

POPULAR MECHANICS

The YOUNG CRAFTSMAN

OVER 450
EASY PROJECTS



Trains
Young MINDS
and HANDS

The **YOUNG CRAFTSMAN**



Here is a practical HOW-TO-MAKE-IT book with simplified instructions, pictures, plans for making over 450 things—useful articles for the home, furniture, attractive gadgets, knick-knacks, toys, games, photo equipment, boat models, etc., of the more simple type. No special skill is necessary.

It is a book every boy and young man should have for its vast helpfulness and educational value. Dad, too, will get a thrill and much practical help from the **YOUNG CRAFTSMAN**.

From the collection of the

o P^{z n m}re^ainger
v L^{t p}ibrary

San Francisco, California
2008



The YOUNG CRAFTSMAN

DESCRIPTIONS OF OVER 450 EASY CRAFT PROJECTS
REPRINTED FROM PAST ISSUES OF POPULAR MECHANICS
MAGAZINE, WHAT-TO-MAKE, AND OTHER PUBLICATIONS

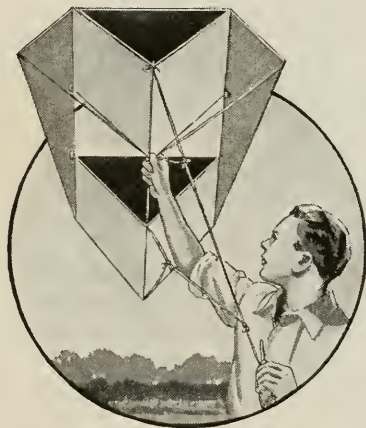

Thrills - Entertains - Trains
Young Minds and Hands

Copyright 1943
POPULAR MECHANICS COMPANY
GROSSET & DUNLAP, Inc. — Trade Distributors

Jigsawed PLANT and

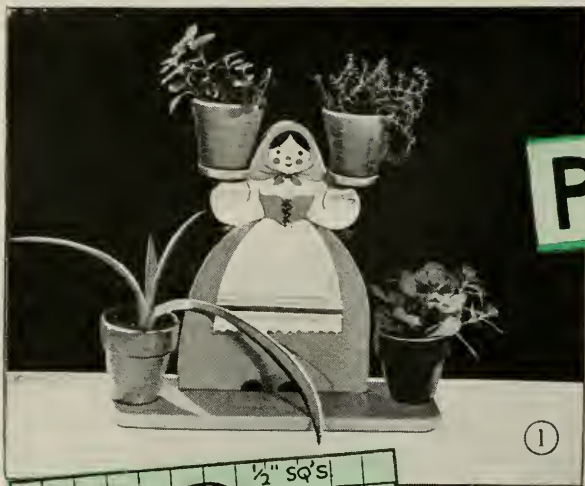

①

ADDDING color and life to any interior, these distinctive plant and flower holders provide appropriate settings into which the flowers blend.

The jolly peasant girl in Fig. 1 carries a tiny pot of flowers in each hand, while a row of them can be set on the shelf or base. Plywood, $\frac{3}{8}$ or $\frac{1}{2}$ in. thick, can be used for both figure and shelf. Draw the figure on a sheet of paper ruled off in $\frac{1}{2}$ -in. squares as in Fig. 2. Allow a space equal to the thickness of the base to extend below the line of the feet. The shelf, which measures 3 by 10 in., has the front corners rounded. A recess is cut in the back edge of the shelf to take the lower edge of the figure, which is attached with glue and brads or small screws. Then, the feet will appear to be resting on the base. Small disks of $\frac{1}{4}$ in. plywood or $\frac{1}{8}$ in. pressed wood are glued and bradged to the arms, the disks being recessed to fit over the bonnet. Appropriate colors for the various parts are also suggested in Fig. 2.

The chef design shown in Fig. 3 is carried out in similar fashion except that he holds a tray on which you can place small pots of parsley, chives and herbs for flavoring. It may be hung on the

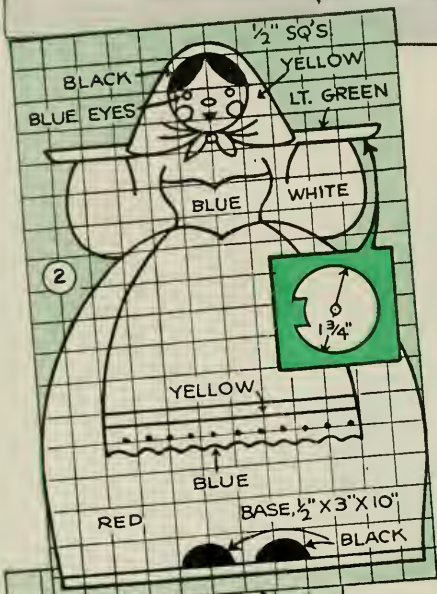

②

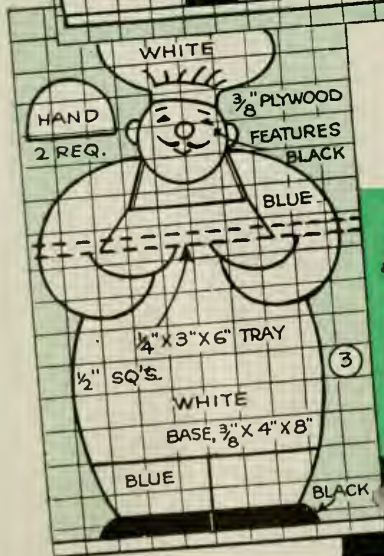

③



④

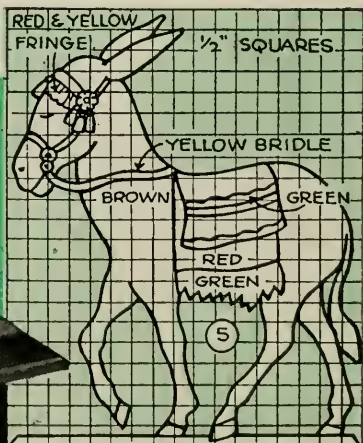

⑤

FLOWER

Displays

wall or placed in a window. A wooden bead can be bradded to the face to form the nose. Figs. 4 and 5 show a burro plant stand. In this, two small baskets contain suitable plants. The baskets are brightly colored woven coasters used for tumblers, or you can crochet little bags for the purpose. Small pegs are glued into the feet and base to hold the two parts together.

The sailboat plant holder, Figs. 6 to 8, goes well in the living room, or as a dining-table centerpiece. Its mast and stay not only serve the purpose of ornament but also lend ideal support to clamoring young vines. The hull is bored to take three pots $2\frac{1}{2}$ in. in diameter. Both the hull and the pieces representing the waves are cut from $2\frac{1}{2}$ by 4-in. block of white pine. Fig. 8 shows how the assembly is mounted on a plywood base. For a little cactus plant a Mexican figure gives an appropriate setting, Figs. 9 and 10. The spread wings of the little snowbird, Figs. 11 and

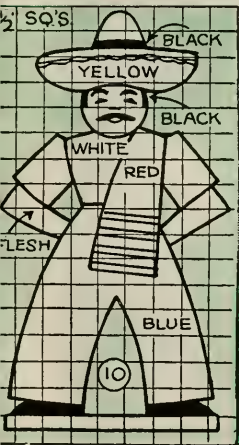
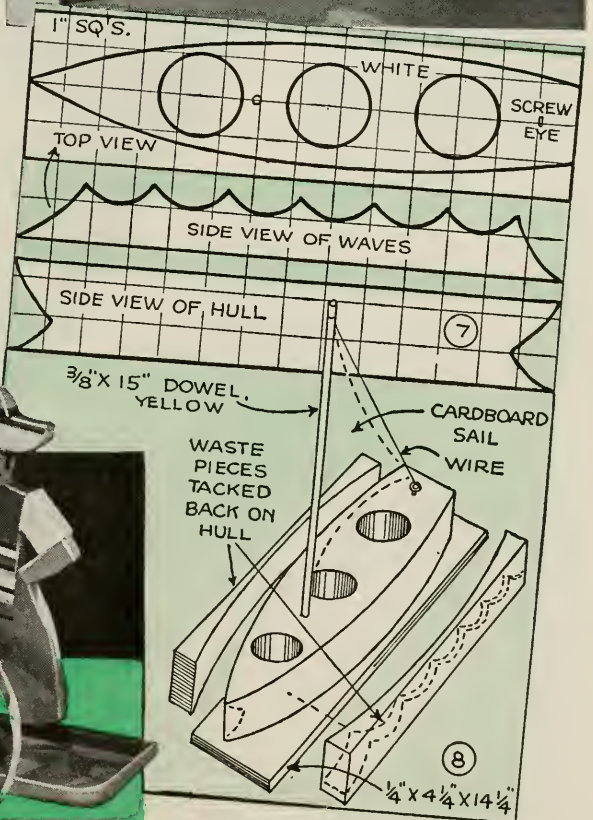

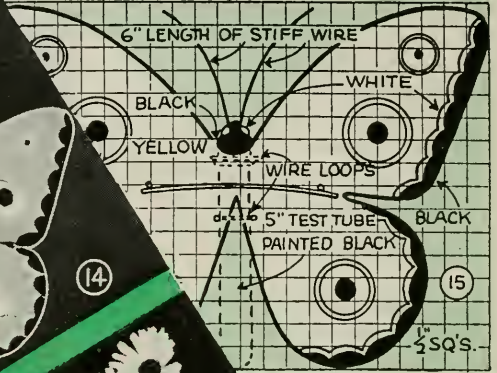
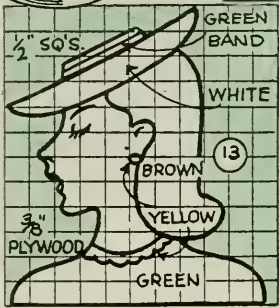
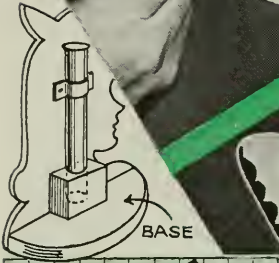
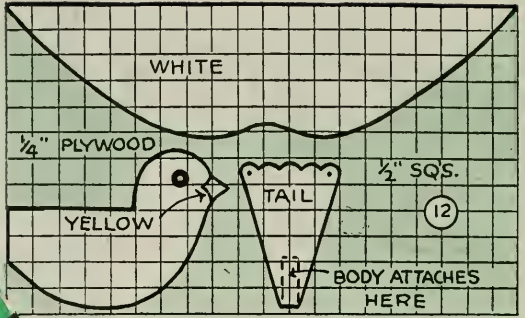

12, form a shelf for plants. The body is attached to the tail with two flat-head screws, countersunk, after which the wings are centered on the top of the body and nailed in place. Two holes are drilled in the tail to facilitate hanging the shelf.

Three types of simple wall vases, incorporating a five-cent test tube you can get at any druggist, are shown in Figs. 13 to 18 inclusive. In case of the butterfly, the test tube forms the insect's body and is held by wire loops. Fresh flowers, used singly or as a cluster, seem part of the girl's hat, Fig. 16, the test tube being concealed behind the figure. In Fig. 18 the quaint, hoop-skirted maid primly holds a blossom, the stem of which is invisible to the observer and goes into the test tube. A small staple on the back of her hand keeps the flower in the desired position.

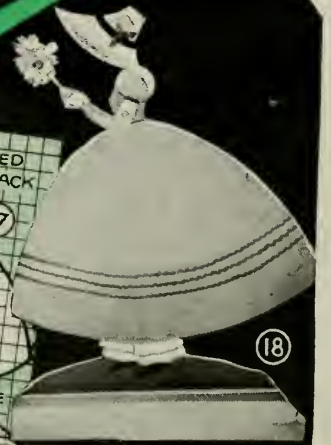
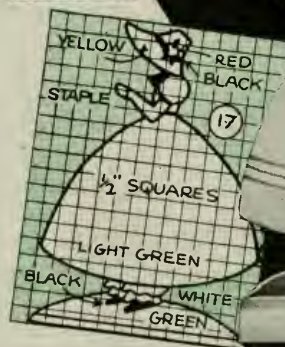
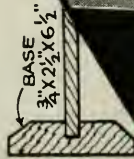



5

Desk duck

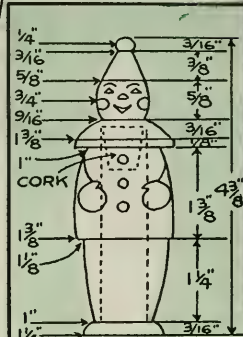

6 *Clown sewing kit*



7

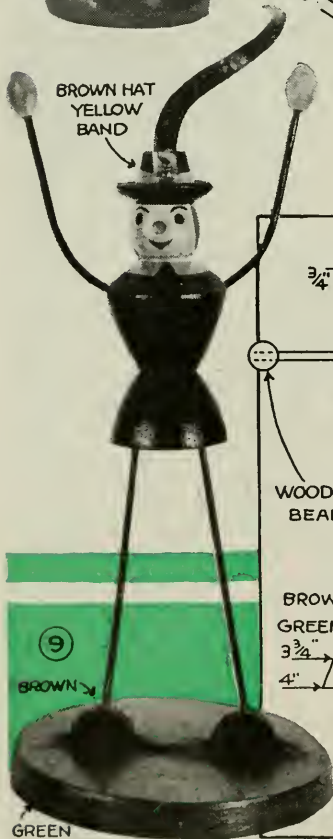
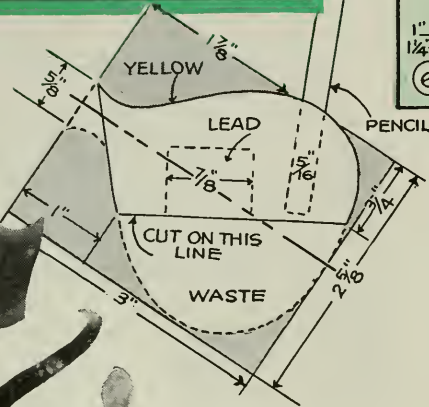

Jack-of all-trades

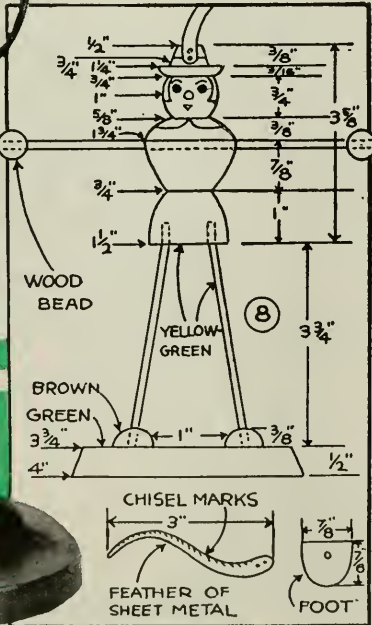

Clown sewing kit: Hidden away in the body of this comical fellow, Fig. 6, are practically all the items needed for mending. It is turned in one piece, after which the head is cut off below the ruff. Then the body is bored lengthwise for small spools of darning cotton, needles and a thimble. A cork pincushion is glued to the bottom of the head.

Jack-of-all-trades: Pretzels, doughnuts and cookies, or jewelry, such as bracelets, necklaces and rings, are but a few of the many items that can be displayed on the spindly arms of the versatile chap shown in Fig. 9. Wire from a coat hanger may be used for the arms and legs. Fig. 8 gives dimensions of the body and base. Wooden beads are used for the hands and nose.

Mexican powder box: Concealing a supply of face powder in his rotund body and a lipstick in his sombrero, the colorful gentleman shown in Fig. 10 will prove a favorite on any dressing table. The lid and box are turned separately on the faceplate, turning out the inside of each and rabbeting the edges to fit together snugly. Then the two pieces are placed together and mounted

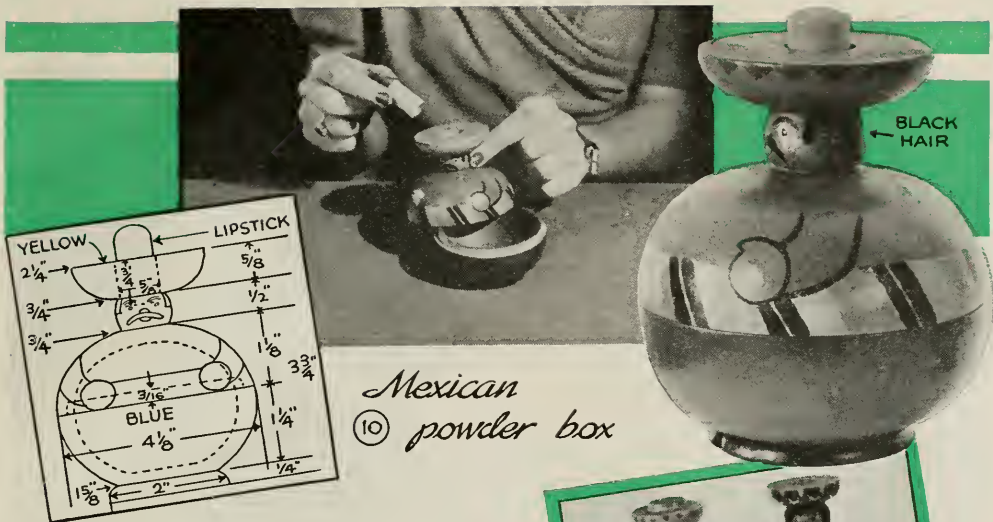

Mexican
 (10) powder box

between lathe centers to shape the outside. The lipstick forming the crown of the hat should fit loosely in a hole at the top so that it may be removed easily. Allow it to project about $\frac{1}{2}$ in. above the top. The base is notched at the front and back to simulate feet. The inside should be sanded smoothly and shellacked.

Mexican table set: The Mexican couple shown in Fig. 11, and the "jumbo" cactus in Fig. 12 provide novel containers for salt, pepper and sugar. The cactus is turned by following the method described for the powder box. It should be finished smoothly on the inside. The handles are notched around the edge and hollowed out in the center to resemble flower blossoms. The one at the top can be turned with the lid and later carved, while those glued to the sides are turned separately. Holes bored lengthwise through the salt and pepper shakers are tapered at the bottom to fit the corks, after which a number of small holes are drilled through the top to meet the center opening.

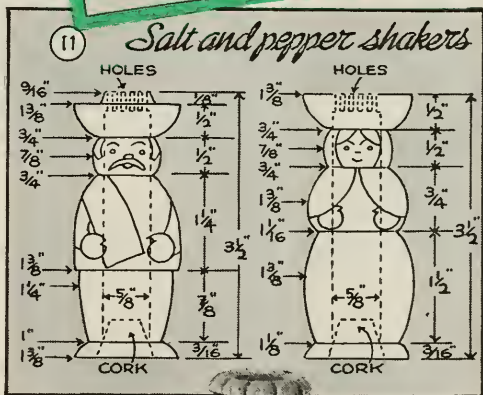

Cactus
 sugar
 bowl

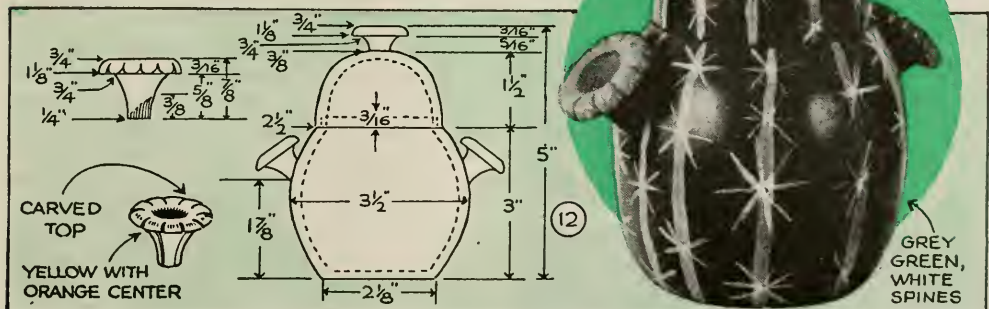

Decorative Plates Dress Up Doorbell Buttons

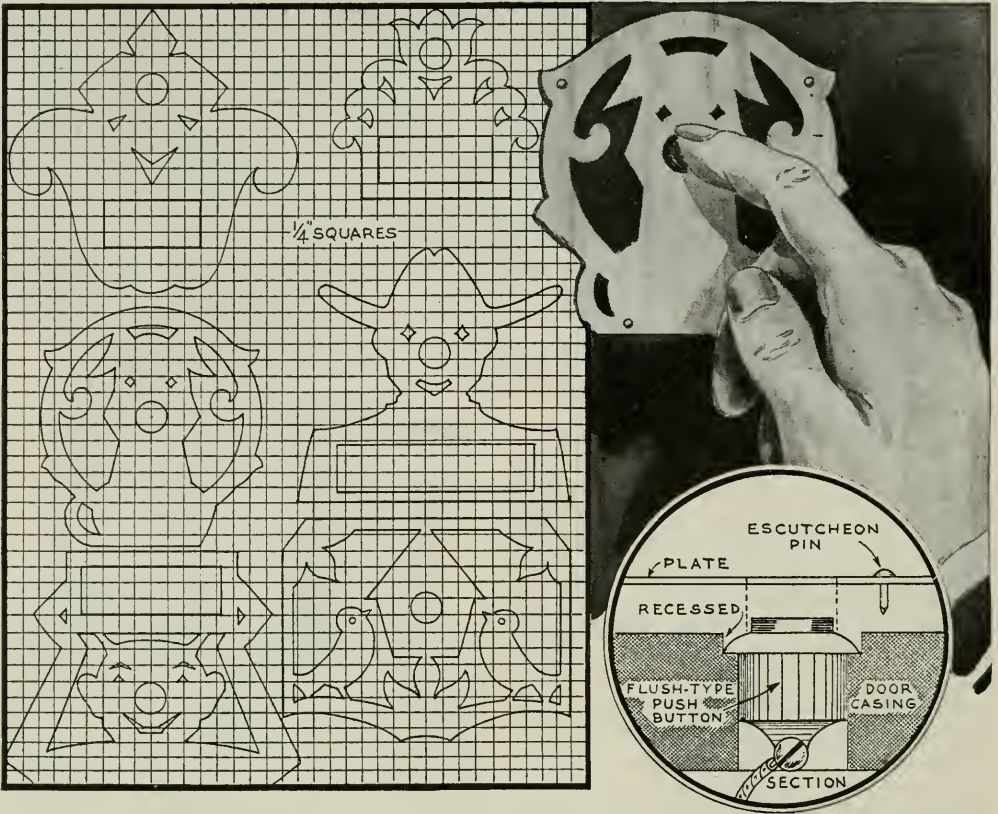

If you have a flush-type doorbell push button which guests find hard to locate, especially in the dark, an ornamental cut-out placed around it will overcome the trouble and add a novel touch to the doorway. Several designs of cutouts for this purpose are shown here as suggestions, or you can make one to suit your own fancy. You can use just one piece of metal, or you can obtain contrast by mounting the cut-out on a plate of different metal, as for in-

stance aluminum or brass over copper or iron painted black. Simple silhouettes in hammered iron, painted black, are very effective against light-colored surfaces. The work can be done with a hand coping saw or on a power scroll saw. All edges and corners of the plate are carefully rounded with a file before starting on the paint job, or in the case of brass or copper, you polish the metal first and then apply a coat of clear lacquer.

Cut-Out Horses Are Harnessed to This Prairie-Schooner Mailbox



Can lids for wheels, and four cut-outs of horses hitched to one end give this rural mailbox the novel appearance of a prairie schooner. The box is mounted on two wood blocks, which are supported by a 1 by 6-in. board nailed to the top of a post, the wheels being pivoted on nails driven into the bottom of the box. Horses, tongue and doubletrees are $\frac{1}{4}$ -in. wood, while the harness is strips of leather. The assembly is painted in appropriate colors.

NOVELTIES *in* WOOD

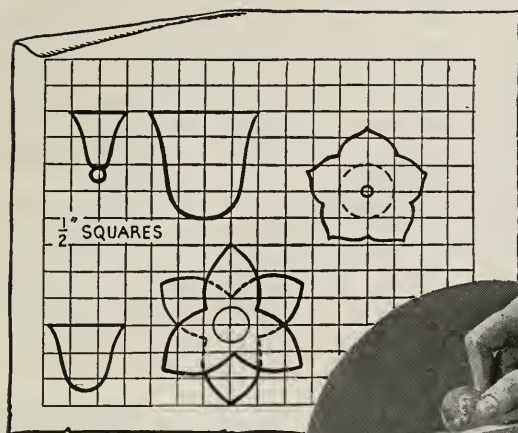

Each one has some useful purpose, is fun to make and profitable to sell

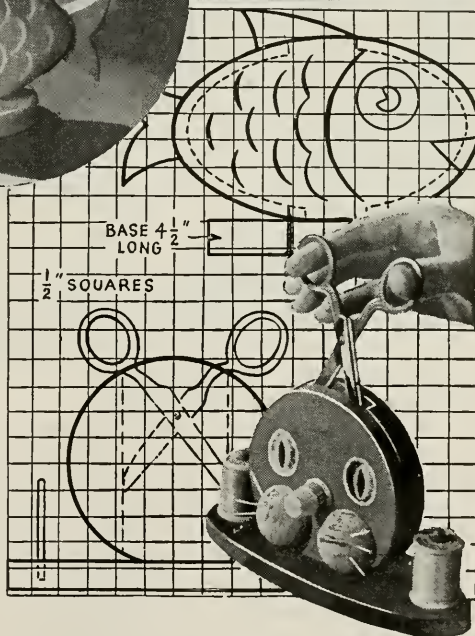
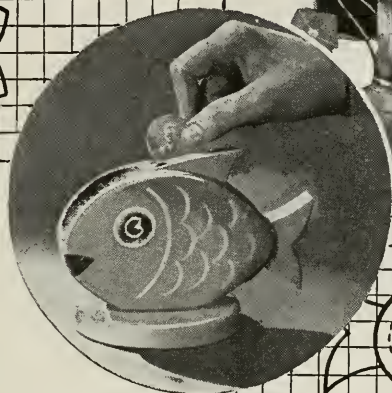

DOWN in a small Illinois town is a craftsman who has built up a nationwide business building birdhouses. It all grew from a hobby, a love for birds and a close study of their habits. In Chicago, another craftsman turned his hobby into cash by designing a simple set of toys which now are turned out in a larger factory. Everyone remembers how the craze for jigsaw puzzles and pictures swept the nation just a few years ago, piling up fortunes for many persons. And today the same opportunities exist. No capital is required to start—just an idea and the ability to use a jigsaw. Why not try and cash in on this demand for novelties? You too can capitalize your spare time by acquiring skill with your jigsaw and then finding some simple thing you can make and sell.

Made from inexpensive woods and enameled or stained in bright colors, these novelties should prove profitable sales items. To form the flowers shown above, cup-shaped parts are turned in the wood lathe, and petals, imitative of many varieties, are

sawed out of thin stock. Curved petals can be shaped from damp wood shavings stained to match the natural colors. Brads, nails, or tacks make realistic stamens, while stems can be made of dowel or stiff wire.

There's plenty of room between the scaly sides of the goldfish to hold nickels and dimes. Softwood, $\frac{1}{4}$ in. thick, is used for the sides, and $\frac{3}{8}$ -in. stock for the mid-

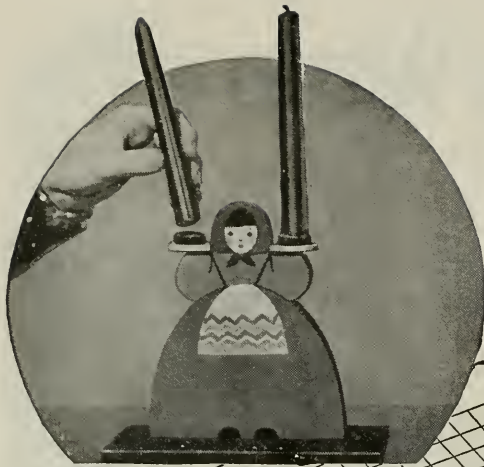

on $\frac{3}{8}$ and $\frac{1}{2}$ -in. stock, that is, all except the hands of the peasant girl which hold the candles. These are turned with an offset and recessed at the center to hold the lower ends of the candles firmly. The chef's "hands" are small hooks by means of which he patiently holds mixing spoons, ladles, saucepans and the like. His nose is a round bead. A small screw eye turned into the top of his cap provides a means of hanging him onto the wall. His white coat is kept buttoned with thumbtacks.

A rare species of cactus which thrives on the closet shelf, or in any nook or corner, makes an excellent hat rack and, without any damage to the "plant" you can also use it as a

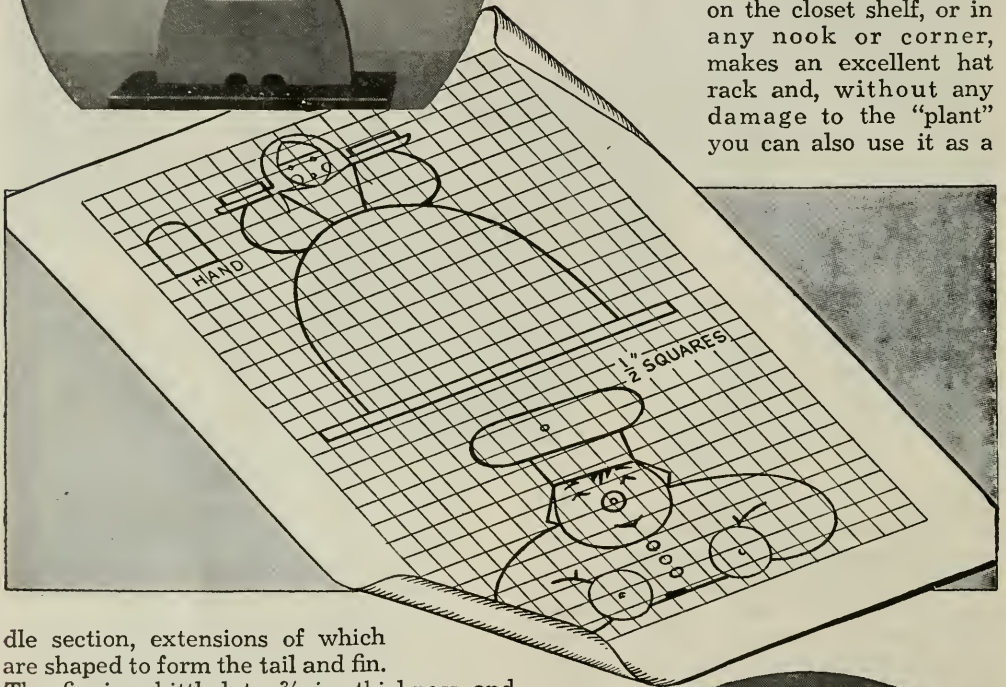

dle section, extensions of which are shaped to form the tail and fin. The fin is whittled to $\frac{3}{8}$ -in. thickness and slots 1 in. long are cut on each side for inserting the coins. The base is sawed and sanded from $\frac{5}{8}$ -in. stock and the fish is fastened to it with two screws driven up from the underside. Only by removing the two screws can you reclaim the coins. The sewing kit is the same type of construction, except that $\frac{3}{8}$ -in. stock is used for both the head and base. A $\frac{5}{8}$ -in. dowel tapered and glued to the face where the nose ought to be, holds the thimble and the halves of a round cork fishing float glued to the face on each side of the nose provide pincushions, the pins representing the whiskers. A $\frac{1}{4}$ -in. dowel in each end of the base holds spools of thread. The peasant girl holding the candles and the jovial chef are just simple scroll-saw jobs



rack for necklaces, bracelets, or even pretzels in the proper setting. It's made of wood, of course, the pot and base being turned in one piece. The "watch dog" is handy for holding your watch in an upright position, making it easy to see the time. The morning-glory "blossom" is just another version of the same idea. And lastly, the fat pig finds himself growing thinner each time you use cord from the ball that forms his body. However, there is nothing he can do about it until you fit him out with a new ball of twine.

Two round pieces of wood make up his face, while a twisted wire provides a tail.

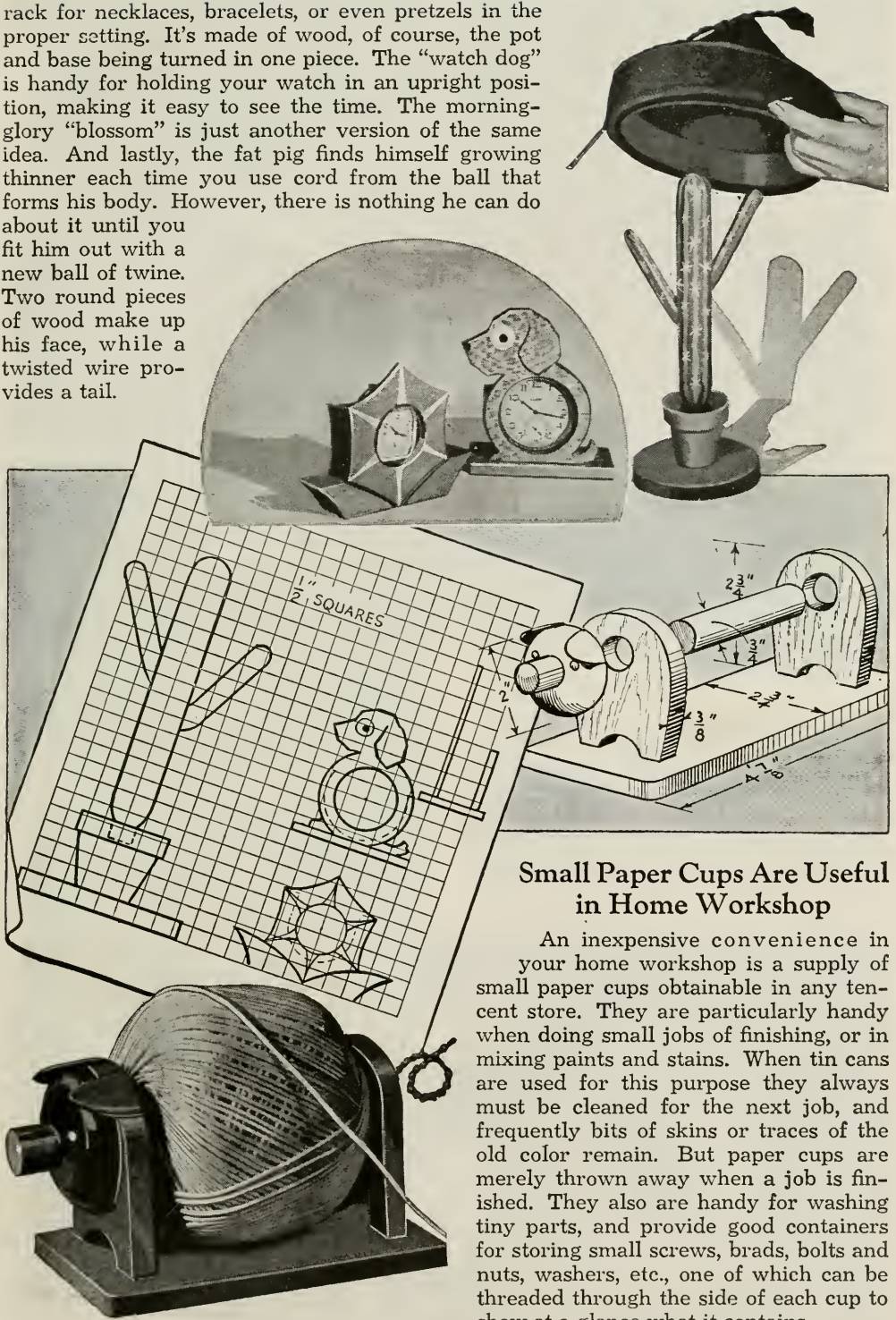

Small Paper Cups Are Useful in Home Workshop

An inexpensive convenience in your home workshop is a supply of small paper cups obtainable in any ten-cent store. They are particularly handy when doing small jobs of finishing, or in mixing paints and stains. When tin cans are used for this purpose they always must be cleaned for the next job, and frequently bits of skins or traces of the old color remain. But paper cups are merely thrown away when a job is finished. They also are handy for washing tiny parts, and provide good containers for storing small screws, brads, bolts and nuts, washers, etc., one of which can be threaded through the side of each cup to show at a glance what it contains.

SCROLLED HOT PADS of Plywood



More than a century ago wrought-iron trivets, hot pads to us, were household utensils in everyday use at the pioneer fireplace. Here they are once again in the old patterns and pierced designs, but made of plywood and modernized with colorful heat-resisting lacquers or enamels. Trace the pattern full size on squared paper, then transfer the lines to the wood with carbon paper. Use $\frac{1}{4}$ or $\frac{3}{8}$ -in. plywood and cut away the waste to the pattern lines with a scroll saw. Legs are the small screw-type brass knobs. Finish in color or leave the pads plain as you desire.

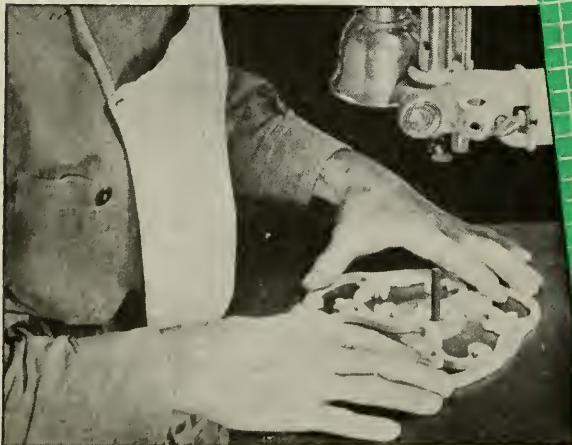
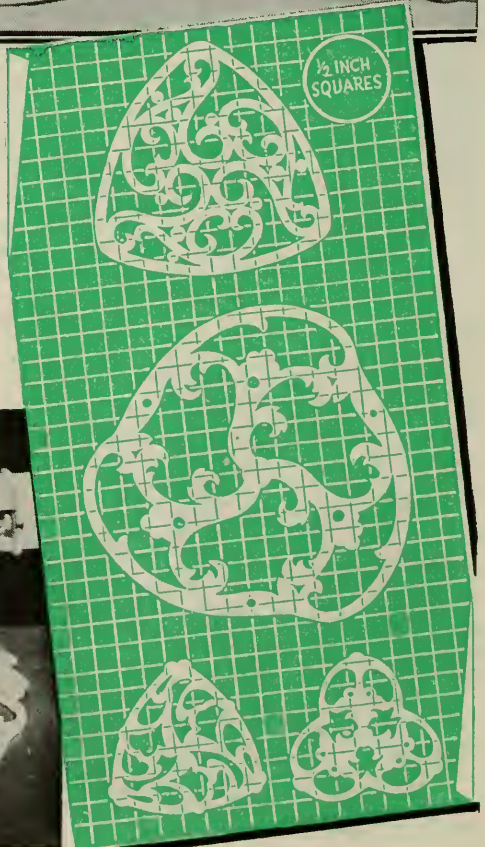

Bridge-Party Serving Tray and Coaster Set

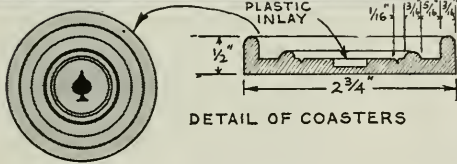
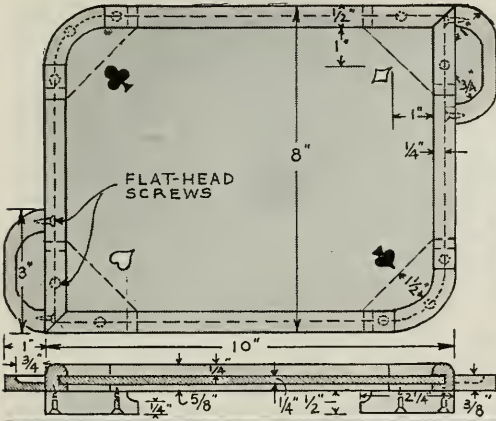

Appropriate for serving at bridge parties because of its playing-card markings, this tray and coaster set will be prized by any hostess. The set is made from maple or birch with inlays of black and red stick shellac. The handles and feet of the tray are walnut or mahogany. First turn the coasters to shape, then rout out the centers and fill the resulting depressions with the shellac, red for the diamond and heart, black for the spade and club. Smooth these down carefully with a warm knife. When cold, scrape the excess shellac from the wood and sand carefully by hand. Power sanding is apt to soften the shellac and cause it to run. The tray panel is made from 1/4-in. maple or birch. Rout, fill and smooth the designs as was done with the coasters. The molding is rounded across the top and grooved to fit the panel. The rounded corners of the molding are turned in a lathe, then quartered. The handles are



routed to form a grip, and the feet are shaped to fit flush at each corner. Before assembling, fasten the handles to the molding with glue and small, flat-head screws, countersunk from the inside of the groove. With the panel in place, glue the parts together and fasten with flat-head screws through from the underside of the feet. Finish with spar varnish or clear lacquer.

Flowerpot Rack Hooksto Window

Finished to match the window trim, this neat rack will hold potted plants in a window without detracting too much from its appearance. The sides or brackets are made of hardwood and are joined at the bottom by lengths of dowel stock, which serve as a shelf. Thin, metal clips at the upper ends of the sides slip between the two window sash.



Picture "Frames" and Tray Edging of Rope



Ordinary rope can be utilized on your craftwork to give it a rustic or marine effect. The tray shown above is just a piece of $\frac{3}{8}$ -in. plywood with $\frac{1}{2}$ -in. rope bradded around the edges and fitted with handles, one of which conceals the ends of the rope. It may be lacquered or just varnished, and then a decalcomania transfer can be applied if desired. Picture frames are made in a similar manner. The prints or photos are cemented to plywood and the rope is attached so that it conceals the edge of the paper. Frames of any desired shape can be made in this way, and you can use more than one photo to a frame as shown in the lower right details. Also, rope can be used for many other purposes. A shoe rack is just one suggestion. The rope is bradded around the edge and across the center of a piece of plywood, loops being formed in the center rope to take the shoes.

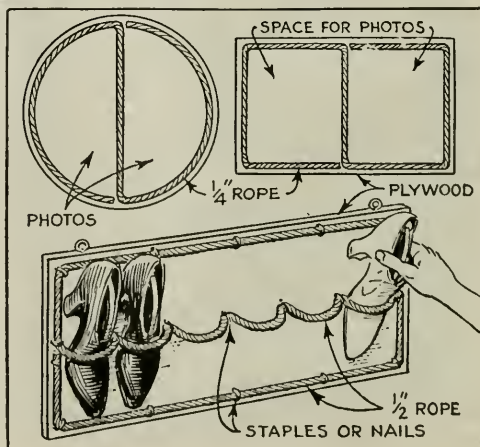
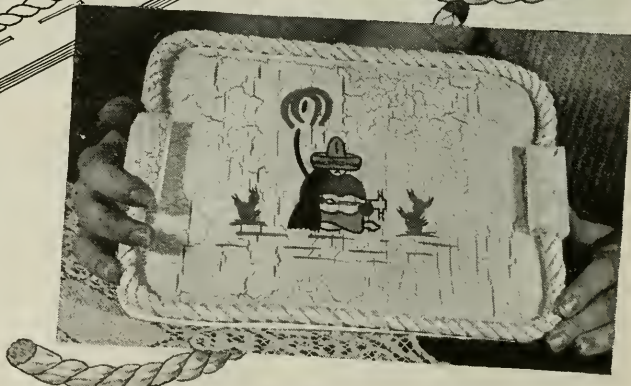

Memo Cabinet in Kitchen Includes a Mirror

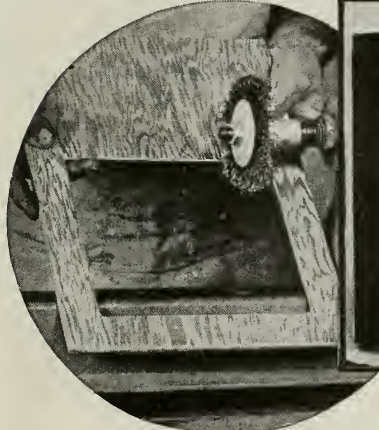
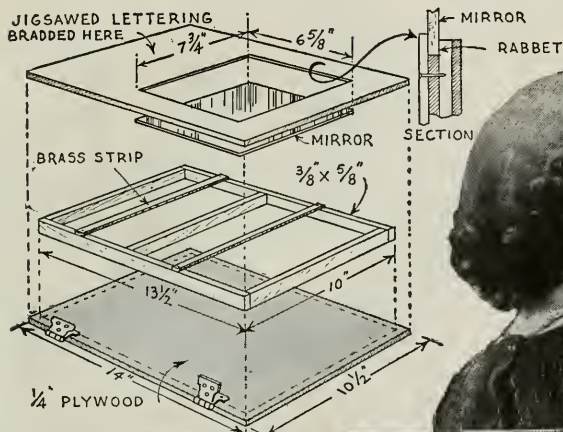

This tiny kitchen cabinet with a mirror set in its front, encloses a small blackboard and has pockets for note and cook books as well as chalk and pencils. Front and back are made of 1/4-in. plywood. Two coats of blackboard slating paint are applied to the back to provide a writing surface for chalk. The front has a window which is rabbeted to take the mirror from the inside. For a novel effect, round the front corners and score the wood with a wire brush. Then finish in ivory or white and rub some burnt umber or other pigment into the scored scratches, wiping the whole surface clean. Jigsaw the letters and paint the sides, then brad them in place and paint the top surfaces. Nail and glue wooden strips to the back of the lid to form the pockets, sides and bottoms. Mortise narrow brass strips into the side pieces to hold articles in the pockets. The hinges must be mortised to their full depth when folded, with the pins standing well out so that the front can

swing out more than at right angles. Two holes at the top of the blackboard fit over screwhooks in the wall to hold the memo.

Strap Hinges Serve as Brackets on Folding Shelf

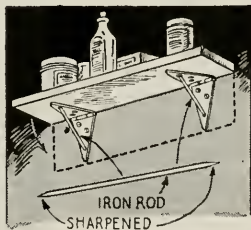

In cramped quarters where a shelf is needed occasionally, one of the folding type can be made in a few minutes from a couple strap hinges and a board. Hinges are screwed to the wall and shelf, leaving the end holes in both hinges to take pointed rods, which hold the shelf in position, as shown in the above drawing. When not in use, the rods can be removed to let the shelf down.

A Corner Whatnot Shelf in Maple-Leaf Design

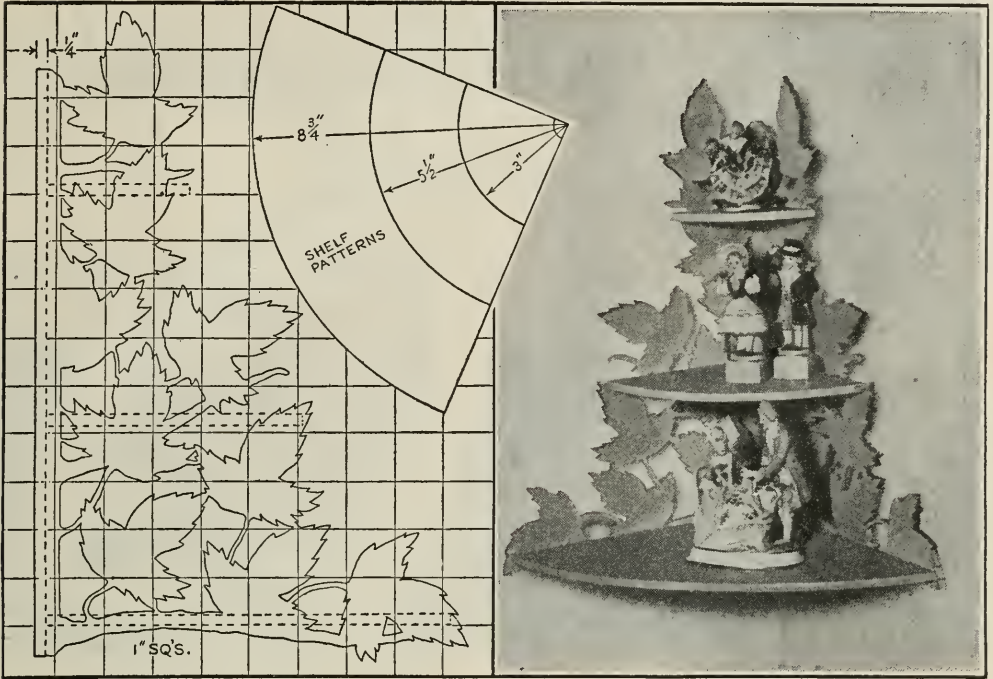

Just the thing to dress up a corner in your living room, this whatnot shelf has duplicate plywood sides that can be cut together. However, one must be $\frac{1}{4}$ in. wider than the other at the back edge. After sanding thoroughly, the sides are assembled with glue and small brads, and the

shelves are spaced as indicated on the squared drawing. Finishing the original shelf to carry out the maple effect consisted of applying maple oil stain, followed by a coat of white shellac. When the shellac was dry, the surface was sanded, dusted clean and given a coat of clear varnish.

Bric-a-Brac Shelves Are Made of Dowels and Plywood

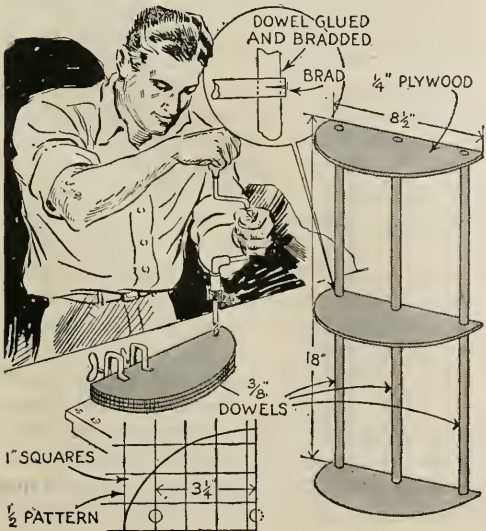

These attractive bric-a-brac shelves can be made in a short time at a cost of only a few cents. They are cut from any available scraps of plywood, after which they are stacked and drilled to take $\frac{3}{8}$ -in. dowels. The shelves are glued and bradded to the latter. Finish can be enamel of a color that harmonizes with room surroundings, varnish or wax.

Making Wood Brackets Easily

One of the easiest and most economical ways to make small brackets of the cove type, is first to cut a wood block perfectly square. Then bore or jigsaw a hole in the exact center, making the hole large enough to leave the wood about 1 in. wide at the centers of all four sides. Sawing the block in four equal parts gives you four brackets.

Wooden CONDIMENT SET

turned on your lathe

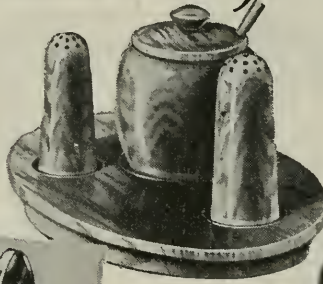

Lid for the mustard pot is turned from a single disk

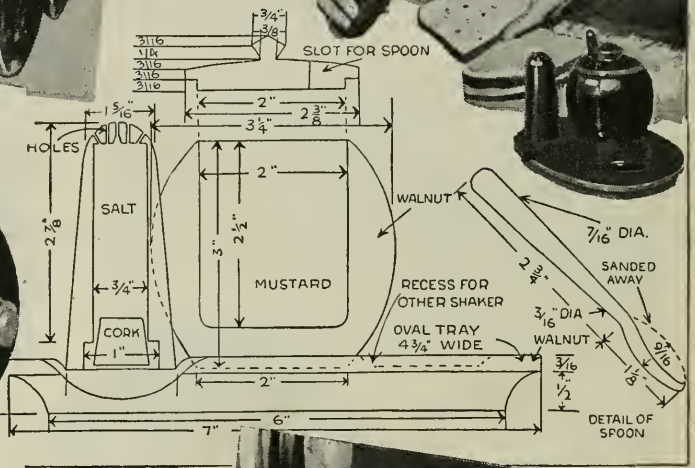
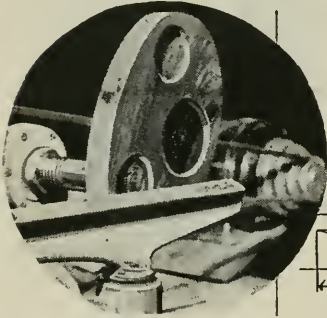

EBONY or rosewood should be chosen for this novel table set because these woods turn out with crisp, sharp edges and can be polished to a high luster. Blocks for the salt and pepper shakers are counter-bored as in the dimensioned detail. Then a $\frac{3}{4}$ -in. dowel is centered in a turned disk on the lathe faceplate to form a chuck for turning the shakers to size. Drill $\frac{1}{16}$ -in. holes for pepper and $\frac{3}{32}$ -in. holes for salt. The mustard pot is a simple turn-and-recess job on the faceplate while the spoon is shaped entirely by hand. The base or tray is oval-shaped, 7 in. long and $4\frac{3}{4}$ in. wide. It's first jigsawed to size, then the edges may be molded. Turning three recesses $\frac{1}{8}$ in. deep requires three operations, one for each recess.



Truing flat surfaces on the disk sander makes a neat job



The edge of the tray can be molded on a shaper

A Corner Whatnot Shelf in Maple-Leaf Design

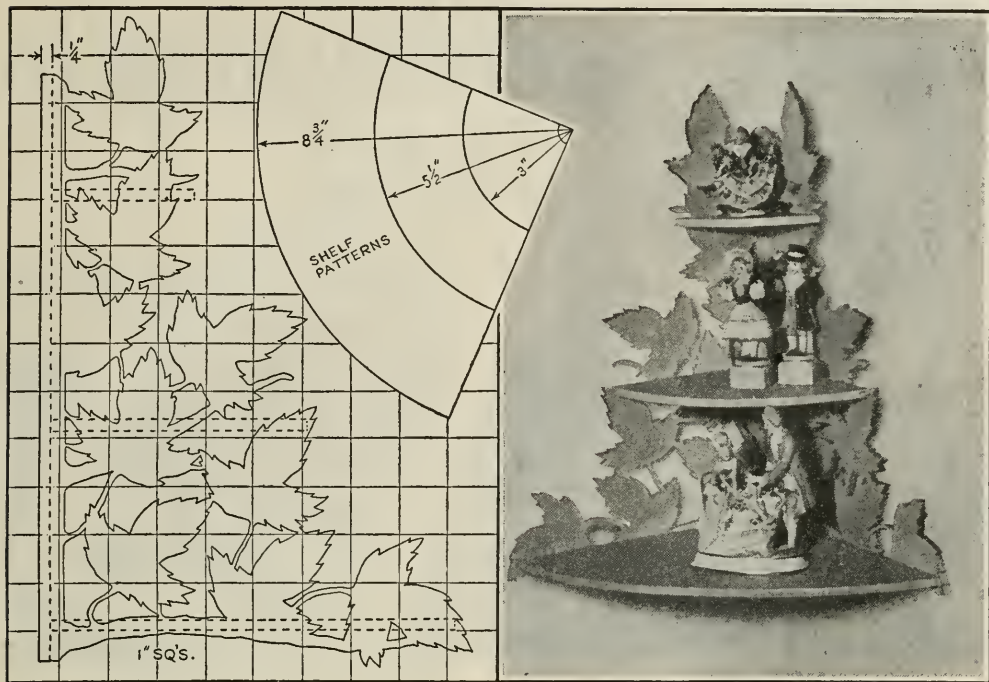

Just the thing to dress up a corner in your living room, this whatnot shelf has duplicate plywood sides that can be cut together. However, one must be $\frac{1}{4}$ in. wider than the other at the back edge. After sanding thoroughly, the sides are assembled with glue and small brads, and the

shelves are spaced as indicated on the squared drawing. Finishing the original shelf to carry out the maple effect consisted of applying maple oil stain, followed by a coat of white shellac. When the shellac was dry, the surface was sanded, dusted clean and given a coat of clear varnish.

Bric-a-Brac Shelves Are Made of Dowels and Plywood

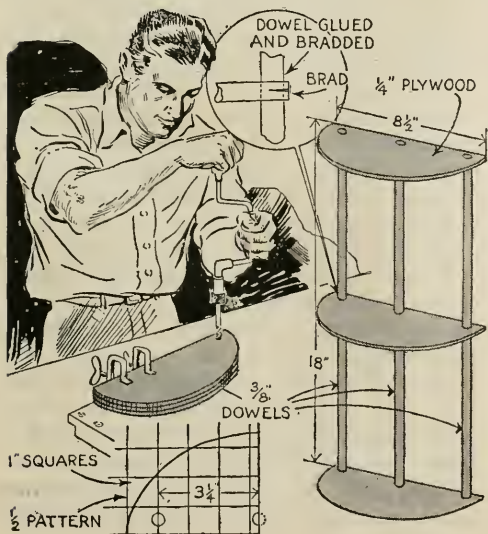

These attractive bric-a-brac shelves can be made in a short time at a cost of only a few cents. They are cut from any available scraps of plywood, after which they are stacked and drilled to take $\frac{3}{8}$ -in. dowels. The shelves are glued and bradded to the latter. Finish can be enamel of a color that harmonizes with room surroundings, varnish or wax.

Making Wood Brackets Easily

One of the easiest and most economical ways to make small brackets of the cove type, is first to cut a wood block perfectly square. Then bore or jigsaw a hole in the exact center, making the hole large enough to leave the wood about 1 in. wide at the centers of all four sides. Sawing the block in four equal parts gives you four brackets.

Two Unusual

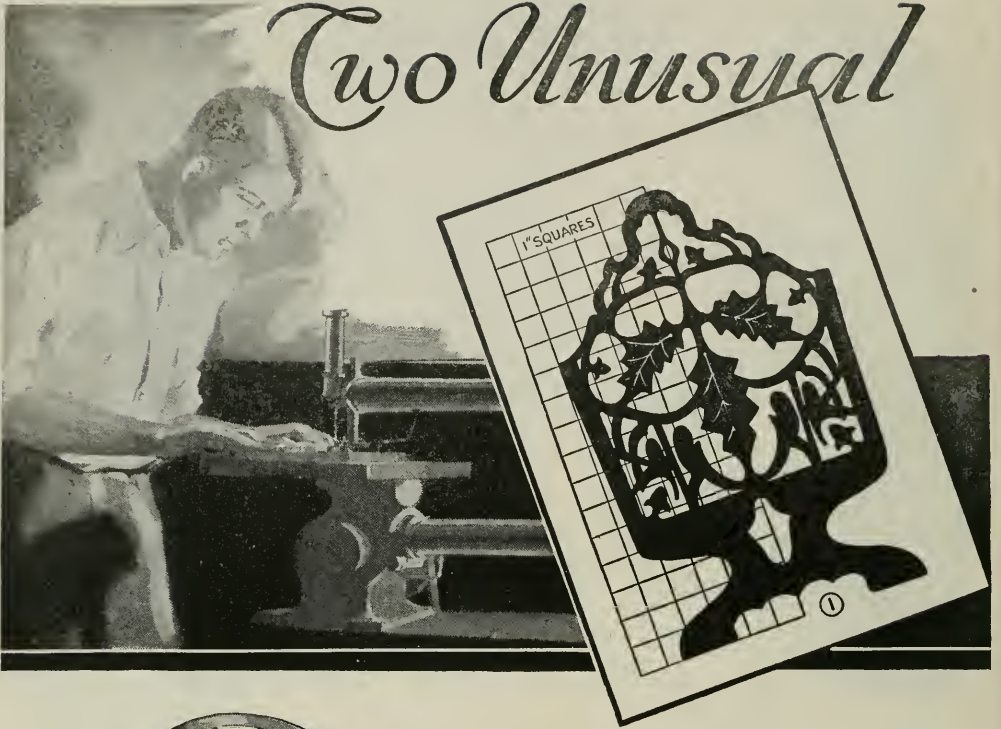

ONE of these magazine baskets is entirely a jigsaw project, while the other is a product of your skill at woodturning, although in the absence of a lathe you can make a simplified type, of the same general design, from dowel rod. A motor-driven jigsaw is, of course, preferable, as it is a great time-saver over the method of using a fretsaw by hand.

Like most jigsaw articles of this type, the magazine basket, shown completed in Fig. 3, should be cut of plywood to avoid splitting, which would occur with single-thickness material when such intricate

designs are cut out. Any good grade of plywood, about 6 sq. ft., will answer, and the thickness should be $\frac{1}{4}$ to $\frac{3}{8}$ in. The feet are made of $\frac{3}{4}$ -in. material, 4 in. wide and 9 in. long, and are fastened to the bottom of the basket with screws. Get a large sheet of paper or cardboard and line the sheet off with a soft pencil into 1-in. squares. Then sketch in the curves making the designs of the ends, sides and center members, Figs. 1, 4 and 5 respectively. These designs are then transferred to the wood with carbon paper, and sawing them out is next. When the different parts have been cut out and sanded they are assembled with small nails and glue, after which a finish to properly harmonize with existing or proposed surroundings is applied.

The second type of magazine basket, shown in Fig. 2, consists of a base of 1-in. plywood, or one built up to this thickness by gluing four pieces of $\frac{1}{4}$ -in. stock together. The base is sanded smooth and the edges carefully rounded. The center is then located with a pencil line, and five $\frac{1}{2}$ -in. holes for the center spindles are drilled, taking care that these holes do not break through. Next, the holes for the

MAGAZINE BASKETS



side and end spindles are laid out and drilled, centering $\frac{3}{4}$ in. from the edge all the way around the base. The corner spindles incline outward approximately 10° , measuring diagonally across the base. This position of the corners will incline the side spindles about 5° , and the holes should be drilled accordingly. An accurate guide for the bit is shown in Fig. 7. This may be made from a piece of hardwood. In use it is clamped to the base. The holes should not break through. Holes for the four legs which are set at a 15° angle may be drilled with a similar guide to assure uniformity. The top frame is made up to the dimensions shown in Fig. 10, and the necessary $\frac{1}{2}$ -in. holes are drilled to take the spindles. The mitered corners of the upper frame may be fastened with clamp nails and glue as in Fig. 8. At this stage the basket may be assembled on the base, using glue on all joining parts, assuming that you have already turned out the spindles, sizes of which are given in Fig. 9. The curved handle is built up of several

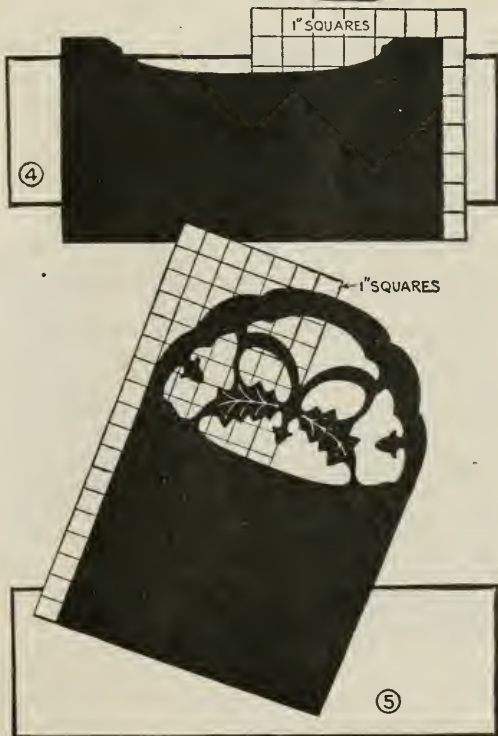

"Lazy-Peon" Book Ends Made in One Evening

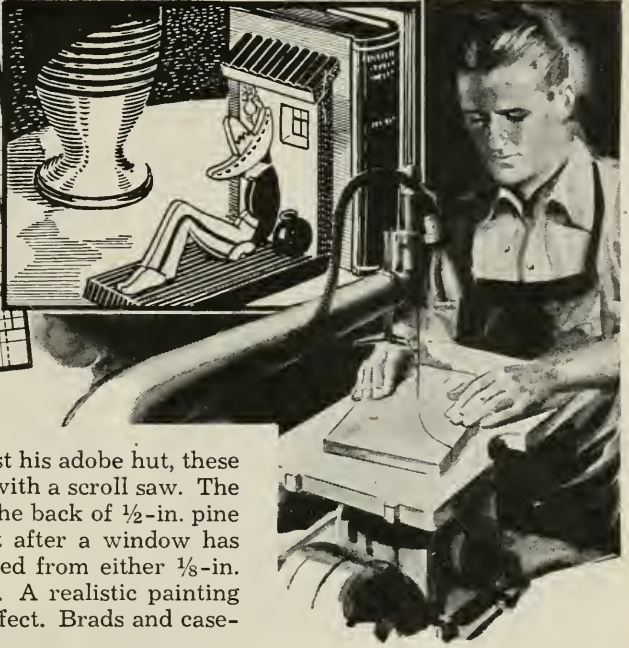
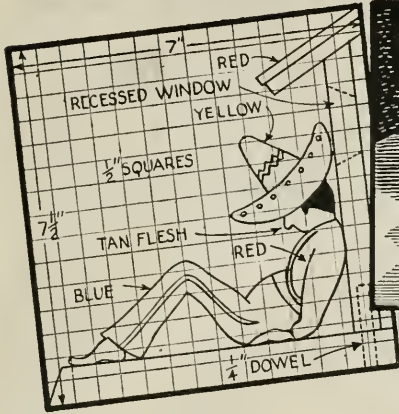

Depicting a peon dozing against his adobe hut, these book ends are easily duplicated with a scroll saw. The base is made of $\frac{3}{4}$ -in. pine and the back of $\frac{1}{2}$ -in. pine with $\frac{1}{4}$ -in. plywood glued to it after a window has been cut out. The figure is sawed from either $\frac{1}{8}$ -in. plywood or hard-pressed board. A realistic painting job is necessary to get the full effect. Brads and case-in glue are used in assembling.

This Magazine Rack Is a One-Evening Job

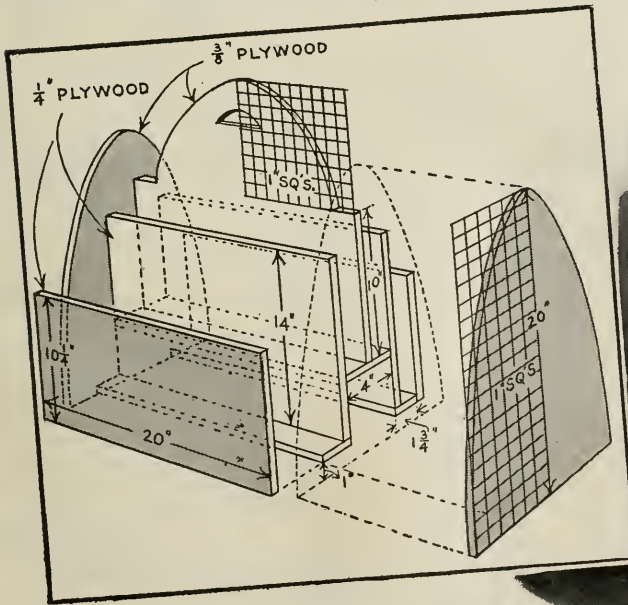

Here is an attractive magazine rack that anyone can cut out with a scroll saw and assemble with a screwdriver. The ends and the center partition are $\frac{3}{8}$ -in. ply-

wood, and the other partitions and sides are $\frac{1}{4}$ -in. plywood. Notice that the bottoms of the two center compartments are raised so small magazines can be seen.

go well in pairs

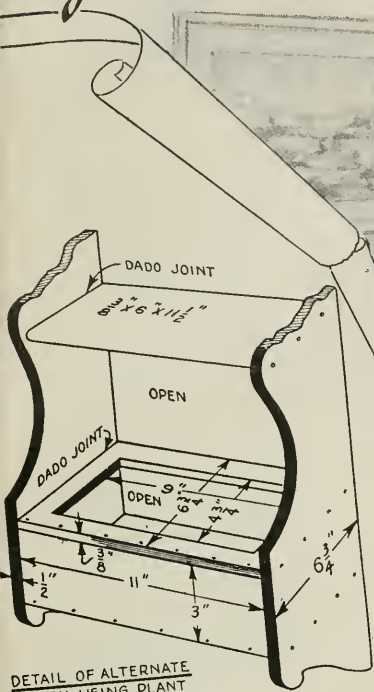

DETAIL OF ALTERNATE DESIGN USING PLANT TRAY INSTEAD OF DRAWER

NOTE - ALL JOINTS ARE SOLDERED TO MAKE WATERTIGHT JOINTS

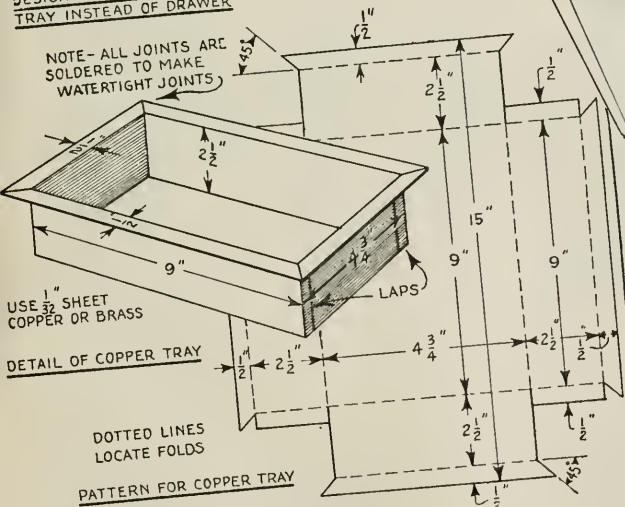

USE 1/2" SHEET COPPER OR BRASS

DETAIL OF COPPER TRAY

DOTTED LINES LOCATE FOLDS

PATTERN FOR COPPER TRAY

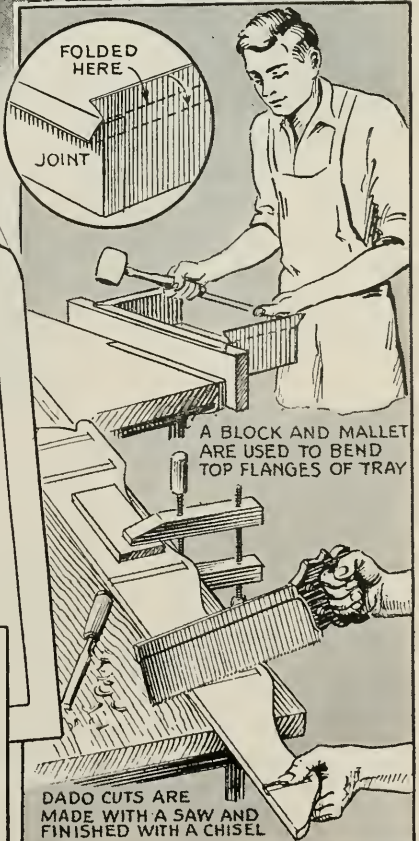

DADO CUTS ARE MADE WITH A SAW AND FINISHED WITH A CHISEL

Arranged as a pair on either side of a fireplace, window or door, these long, narrow shelves provide an attractive display space for books or bric-a-brac. A little drawer at the bottom of each provides a handy place to keep playing cards, pencils, keys, etc., or a metal-lined plant tray may be substituted for the drawer. This plan gives you alternate designs for the scroll-sawed sides, as well as for the scroll at the back of the top shelf

Putting BOOK ENDS to other uses

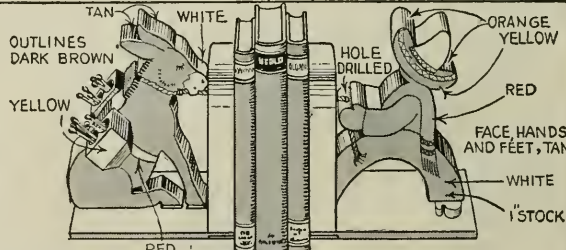
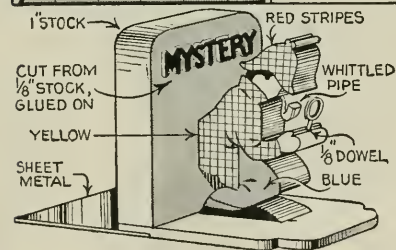
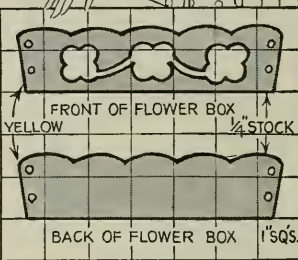
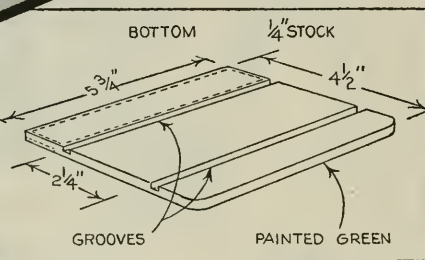
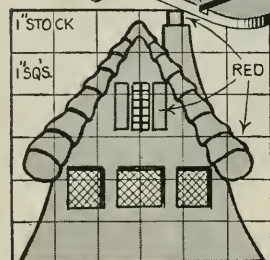
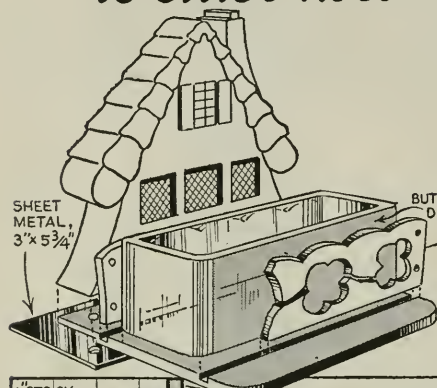

If you are looking for something different in book ends, these colorfully painted ones are just the thing. The cottage type at the top of the page is ideal for the dining or living room as it holds cut or growing flowers as well as books. For a book end to hold your mystery stories exclusively, the detective with his magnifying glass is appropriate. The peon-and-balky donkey set will go well in your den or recreation room as the donkey carries a supply of matches on his back. All the book ends are jigsaw projects, and all must have thin felt glued on the undersides, otherwise the metal-bottomed bases are likely to scratch your furniture

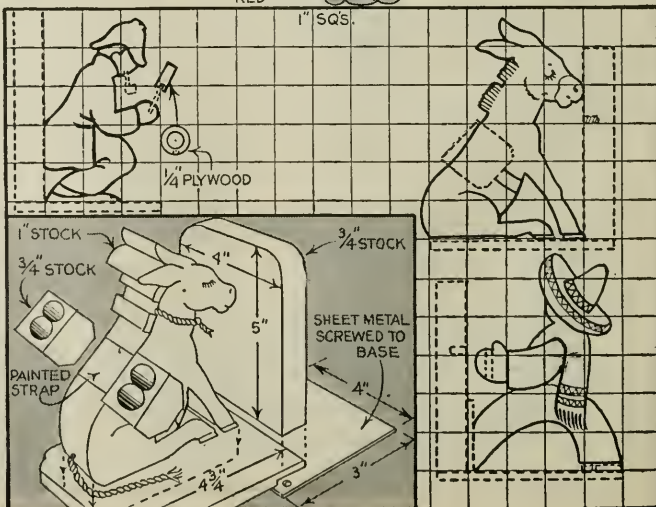

A pair of RAILROAD BOOK ENDS

THE effect of a transcontinental train passing through a row of travel books is decidedly novel, and a pair of neatly finished book ends giving such an illusion will make a very welcome gift. All of the cylindrical parts of the locomotive front can be best done on a lathe, of course, but if such equipment is not available a fairly satisfactory job can be accomplished with a jack-knife. The backs will have to be cut with a scroll or coping saw. Fasten the back on the base with finishing nails and further reinforce it with a brass angle plate screwed to both pieces from the back. Wheels, air tank and cylinders are installed as indicated. The cylinder assembly is built up of three pieces, fastened together with brads and model-airplane cement. This waterproof cement is ideal for model work of all kinds, since it can be had in a colorless variety,

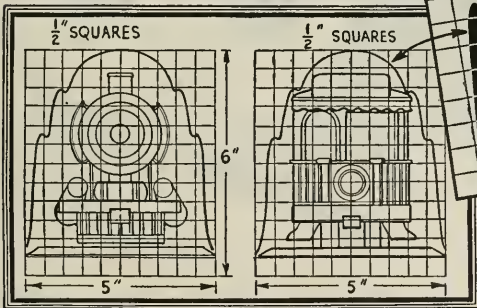
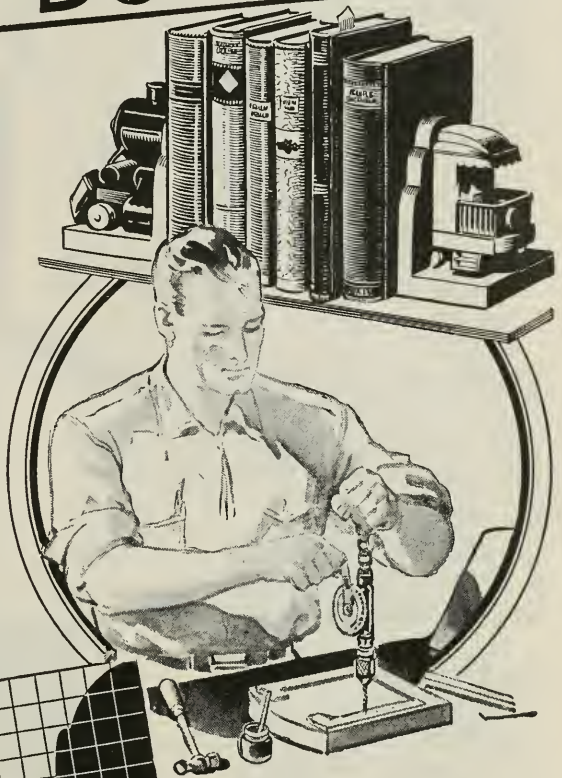

attempt to insert the upper ends of the rods in holes also would result in some difficulty because of the angle. Dummy couplings are carved from white pine.

In building the observation car, the back end of the car body is recessed to represent the door and window. The latter should be about $\frac{3}{16}$ in. deep, and a square of glass is fitted carefully into the recess, which has been painted black. Wood putty can be pressed neatly around the edges to hold it in place, and a frame molding cemented around the outside of the window. The door requires no glass, but will be improved with a frame molding. Note that the spindles of the railing are brass rod, with top and bottom rails of wood. If you wish to make an extra fancy job, use brass rails as well as spindles. The top of the car is built up of three pieces as shown, with a scalloped awning

and will hold wood, leather, metal and even glass with great tenacity. The front end of the boiler is fastened to the back with finishing nails and cement, the headlight having been turned on the front end. Brass rod $\frac{1}{16}$ or $\frac{3}{32}$ in. in diameter is installed for the hand rail, front braces and pilot. In the latter case the rods are set in holes in the bottom part of the pilot only, and cut off even at the top to butt against the underside of the locomotive frame. An

SAILBOAT LAMP

Has Rudder Light Control

"LIGHT UP" with this novel sailboat lamp means "Port your helm," with the rudder arm and rudder, which controls the toggle switch to turn the light on and off. The light itself is enclosed within a parchment shade, which is shaped around wire frames at top and bottom to resemble a ship's sail.

Most of the construction concerns the hull of the boat. As shown in Fig. 1, the bottom part of the boat is a separate piece, while the upper part and the cabin are cut from a single thickness of 2-in. stock. By band-sawing the deck line carefully, the cabin will fit into place perfectly. Shaping of the hull sides is accomplished by simply tilting the band-saw table to an angle of 83°. A few strokes with a plane will round off the forward

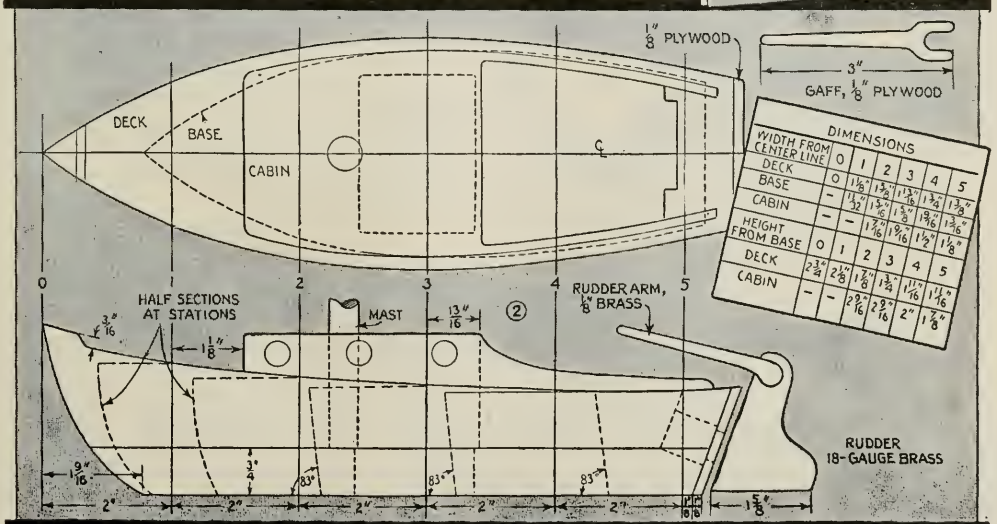
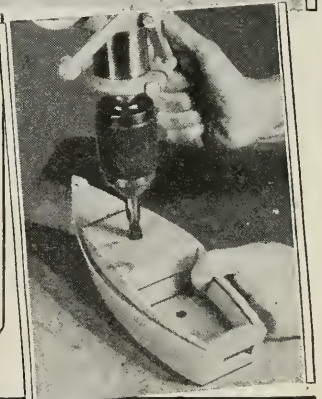
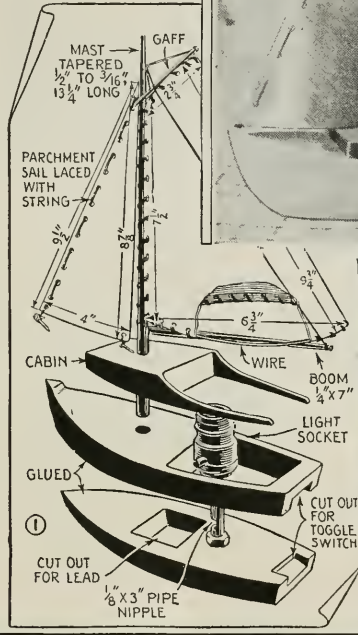
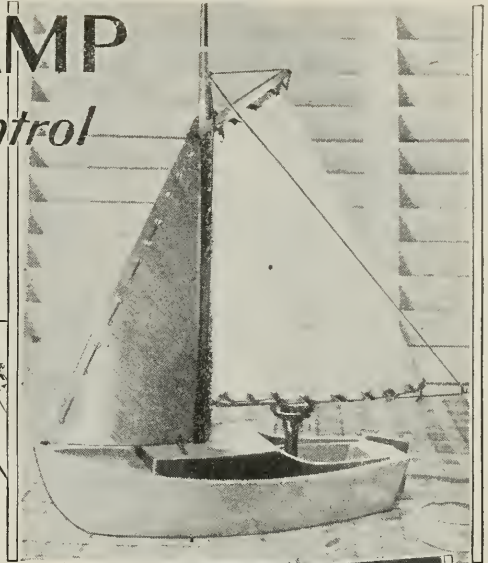

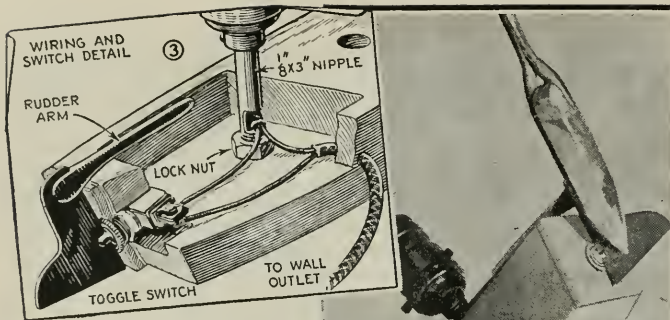

sections. After shaping the outside of the hull, the pieces can be taken apart and the necessary cutouts made for the cockpit switch and wires, as shown. It is advisable to make a full-size plan of Fig. 2, erecting the station lines on 2-in. centers, before commencing the actual construction.

The sail is made from parchment paper, which may be purchased flat or cut from a discarded shade. It is laced around wire loops at the top and the bottom, and then can be laced to the 1/2-in. dowel which serves as a mast. The jib sail is merely a triangular piece of parchment, cut to the size shown, and suspended on a string running from the mast to the bow of the boat. The boom and the gaff are made

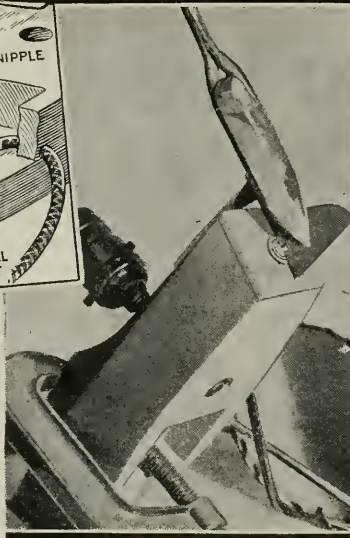

easily, and add to the sailboat motif while helping to hold the shade securely in place.

Fig. 3 shows the switch detail. This is made by slotting the arm of a small toggle switch so that the brass rudder can be soldered in place. The rudder arm, which is made of 1/8-in. brass, is soldered to the rudder, the whole unit serving as the light switch. The light socket is carried on a 1/8 by 3-in. pipe nipple, which is held to the base of the hull by means of two locknuts. The pipe is cut near the lower end to allow the

wires to be connected with the switch.

Additional finishing touches can be added if desired, such as port holes, a small anchor, mooring line, etc. As shown in the heading photo, the hull is done in white pine with a colorful lacquer finish. A varnish finish on hardwood would make up nicely also. The lead in the lower part of the hull makes the lamp "stay put," but could be omitted if desired. The bottom should be covered with felt to prevent the wood from marring polished surfaces.

Reading Lamp for the Davenport Slides From End to End

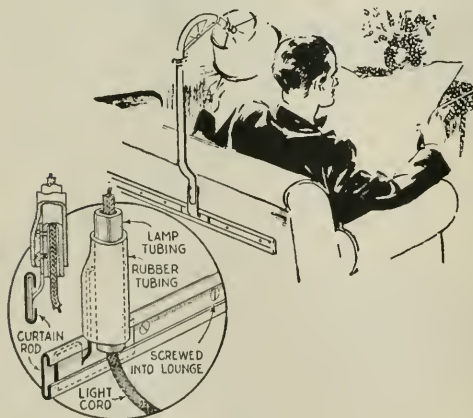

No matter where you sit on a davenport to read, this lamp is quickly moved to throw the light right on your paper. The lamp slides in a track, which is a piece of telescoping curtain rod screwed to the back

of the davenport. The bracket that slides in the track, and to which the lamp standard or tubing is bolted, can be a regular T-brace obtainable in almost any hardware store. Or, you can make a suitable bracket from a piece of 1/8-in. flat iron. After shaping the bracket, the rough edges should be smoothed by filing so that it will slide easily.

☐ Anybody can cut a spiral from a sheet of paper and mount it on a pointed wire or pin over a lamp, the heat of which will cause the spiral to turn slowly. The wire is bent to form a circle to nest on the rounded portion of the bulb after which one end of the wire is brought toward the center and up vertically so that it projects about an inch or so above the bulb. The end of the wire should be filed to a point.

Design for TIME

WITH its red dial backed by a crystal ring, this colorful clock case is assembled from plastics, and makes a distinctive mantel piece. After jigsawing the figures in the dial, it is trued up on a disk sander, using a pivot pin as shown in the photos below, and cemented to the ring. The base of the case is a length of red plastic tube drilled to take two plastic rods as indicated, then cut in half and slotted to take the edge of the ring. The slot must be cut carefully to get a good fit. The clock is a small electric movement, which can be obtained from any clock dealer at a nominal cost. If specified when ordered, the hands that come with the clock will be of the proper length. If you already have a movement the hands can be shortened or lengthened easily with little trouble.



A SMART CLOCK IN COLORFUL RED & CRYSTAL PLASTIC

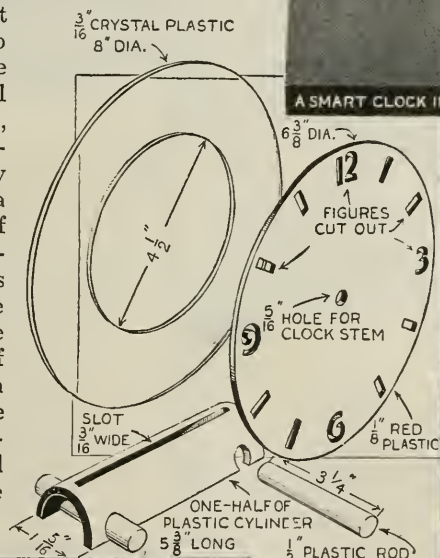

DRILLING HOLES FOR RODS

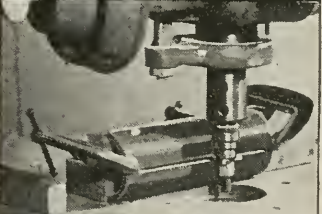

CUTTING GROOVE FOR CRYSTAL DISK

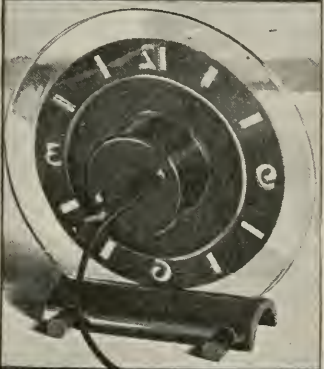
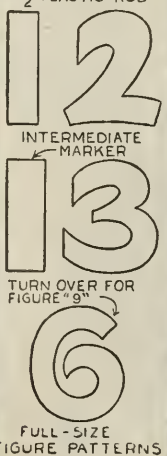

REAR VIEW SHOWING CLOCK

Spanish-Styled BANJO CLOCK

has storage compartment

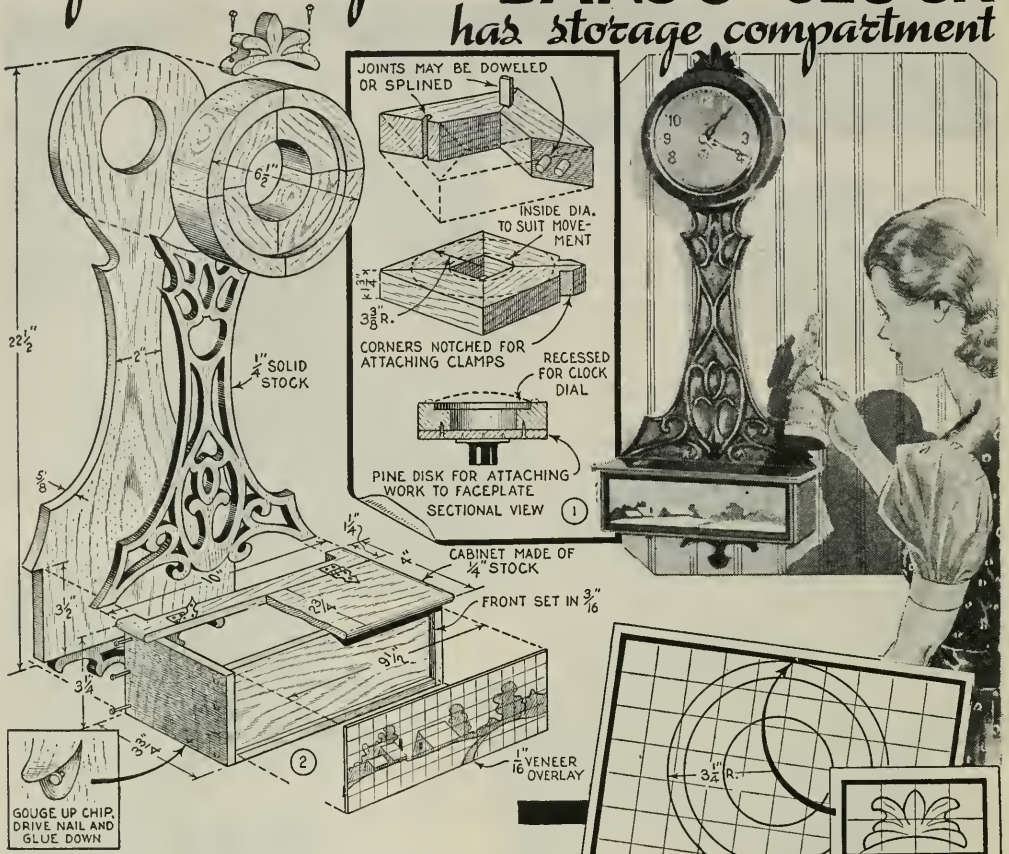

WHILE the banjo clock is essentially American, we have modified it here to embody a touch of southern Spanish style having a carved, scroll throat. Fig. 2 shows the general assembly. The drum of the clock is turned from a blank built up in segments, Fig. 1. A center hole is turned in the drum to take the works, and is recessed around the edge to fit the dial mounting. The back is jigsawed to shape from a single piece, and is fitted with a scrolled overlay, Figs. 3 and 4, glued and screwed in place. After completing the drum, glue and screw it in place on the back. The box at the bottom is of simple construction except that the inlay front panel is set 3/16 in. inside the end and bottom pieces of the box to give a framed effect to the picture. The panel is decorated with an overlay jigsawed from thin veneer and glued in place. A lid hinged to the top of the box makes it a handy place to store numerous small articles.

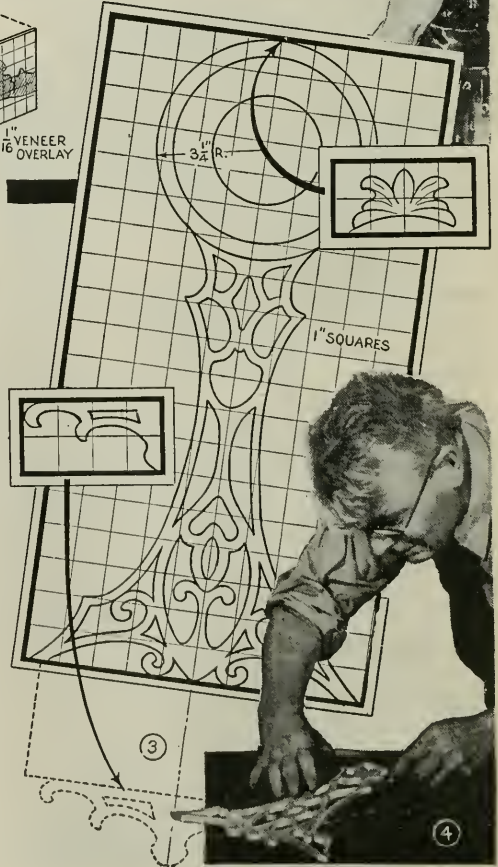

Utility SEWING CABINET



By J. F. Relyea

HERE'S storage space for the mending, twenty spools of thread, as many balls of yarn or darning cotton, drawers for pins, needles and buttons—all contained in a simple rectangular box hung cornerwise on two turned legs. An ornate handle is mounted on the top corner of the box and the two sides, or lids, are hinged to open upward. These are framed and paneled in the same way as a small cupboard door. Or, you can use a single $\frac{3}{8}$ -in. walnut-plywood panel for each door. Here the only difficulty is that of finishing the exposed edge of the plywood. A better way is to edge-glue several narrow strips of $\frac{3}{8}$ -in. solid stock, selected especially for attractive grain and uniform texture. If you have power tools, the strips can be tongued and grooved. If the strips must be joined by hand, then use small dowels to give them

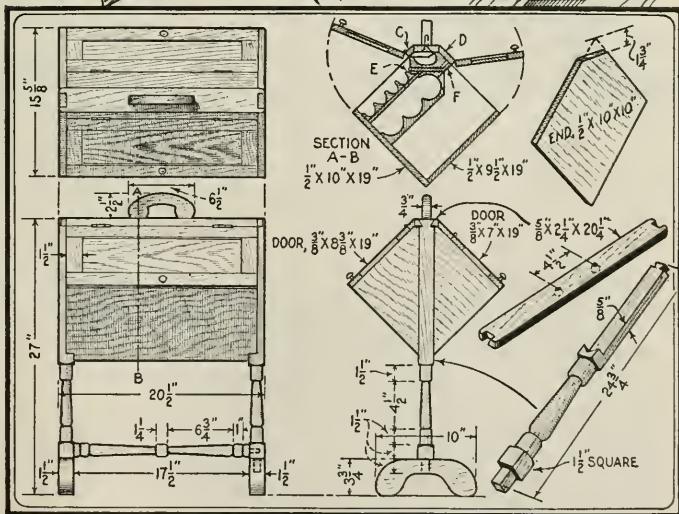

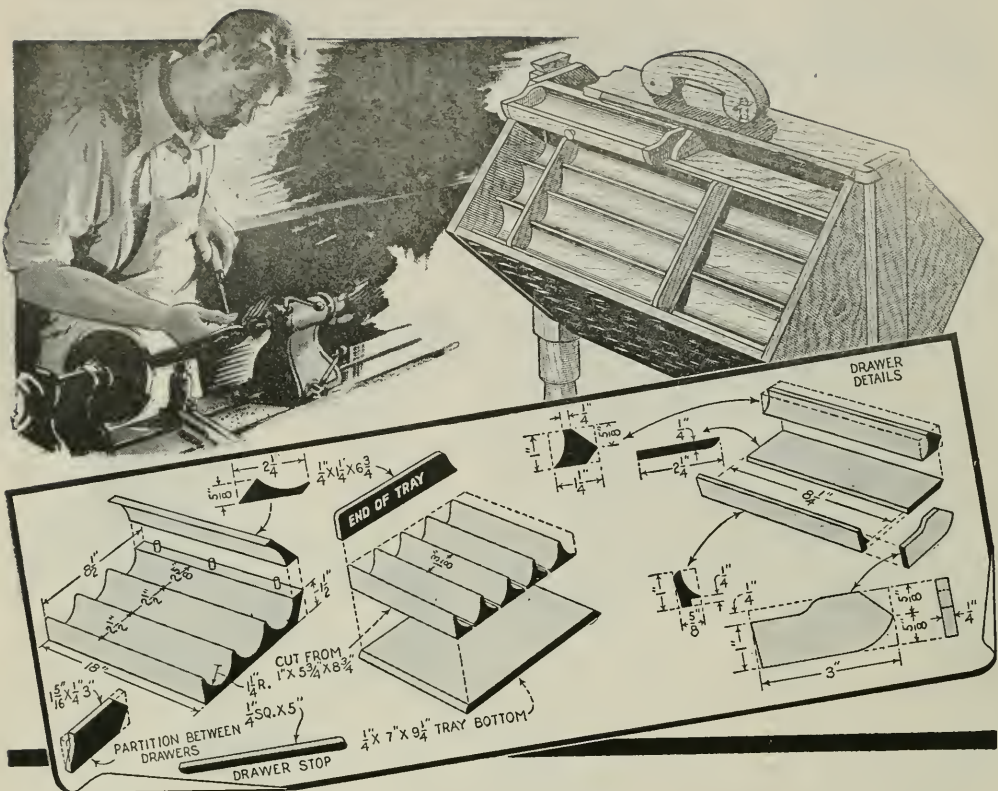

added strength. Details on the first page give the elevations, sizes of the legs and feet, and a cross section. Most parts are of such small size that you can use either solid walnut or mahogany in the construction. You'll save time by building the cabinet first, as the legs are more easily fitted. After the ends and two lower sides of the cabinet have been cut to exact size, they are joined with glue and small brads. Next, the legs are turned to size and the upper square sections are halved and notched as shown. Notice that the upper ends of the legs are dovetailed, the dovetails fitting in sockets cut in the ends of the top cross member. When complete, this arrangement locks the cabinet securely in place. To finish up ready for assembly, you turn out the lower stretcher and saw out the handle and two scrolled feet. Assemble these parts with glue in all joints, and use screws to fasten the handle.

Now the interior fittings: In the cross section, A-B, of the cabinet, parts C and D are simply 3/8-in. lengthwise strips beveled on one edge to fit snugly against the

center member. They should be fastened securely with glue and brads, the heads of the brads being sunk below the surface with a nailset. Part E is the shelf on which the drawers slide, and part F fills the opening back of the drawers. The thread and yarn trays and the drawers are made as in the details above. For the trays use pieces of white pine or basswood which are straight-grained and free of knots. To form the concaves, the width is first laid out and the lines deeply scored with a scribe. Then the waste is removed with a quarter-round gouge and the job finished by smoothing the grooves with sandpaper wrapped about a length of 1-in. dowel.

To finish walnut, sand thoroughly and rub in a walnut filler. After this dries, sand lightly and apply two coats of white shellac, smoothing the surface between coats with fine steel wool. When dry, finish with furniture wax, rubbed down to a dull gloss. Use the same procedure in finishing mahogany except that a stain is applied before filling.

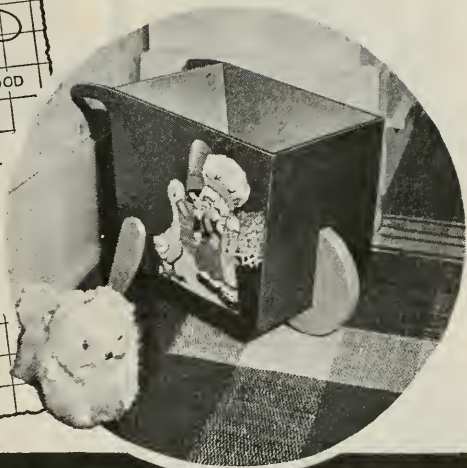
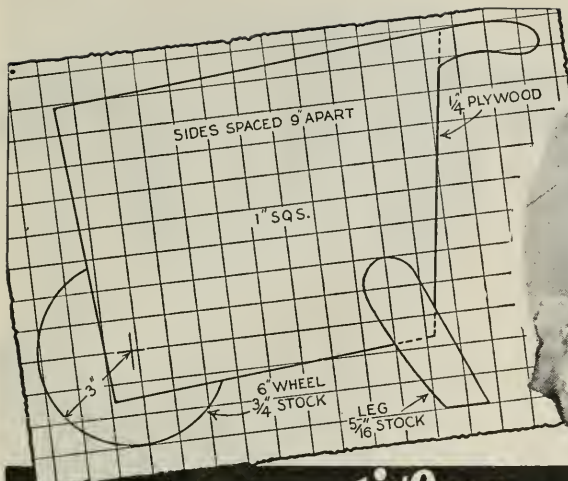

TWO ATTRACTIVE WASTE BASKETS

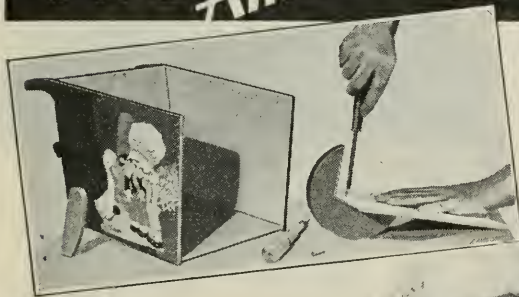

A "wheelbarrow" basket makes an ideal unit for a child's room, but it is not out of place if used elsewhere. Stock is $\frac{1}{4}$ -in. plywood, all joints being butted and nailed. The "wheel" is cut from $\frac{3}{4}$ -in. stock and is screwed to the front of the basket. Legs are sawed from $\frac{5}{16}$ -in. stock and are nailed in place in the position shown. The width of the basket should be about 9 in. for pleasing proportions. Pictures can be cut from a magazine or a discarded ten-cent picture book, and pasted to the sides

The basket shown below is a dandy companion piece for a modern desk. Construction starts with the two sides, which are sawed to shape and then rabbeted on the shaper or circular saw to take the bottom. The latter is either composition board or heavy cardboard and is nailed to the sides. If composition board is used, it can be bent to shape around a hot furnace pipe. A center ornament is made from hardwood, and fluted on the shaper or drill press. The ornaments are finished natural, the rest in color

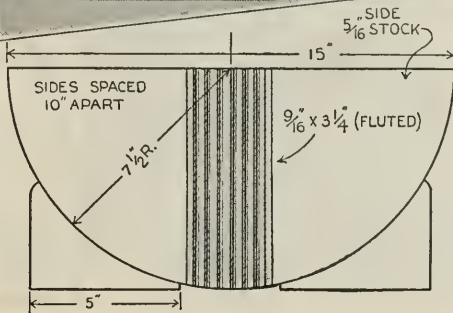
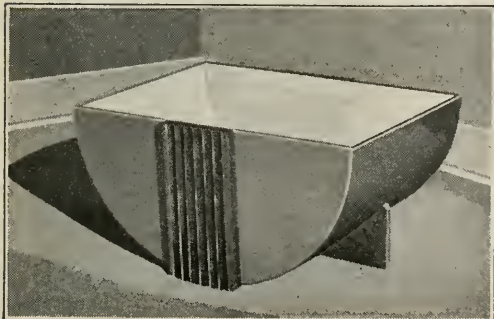
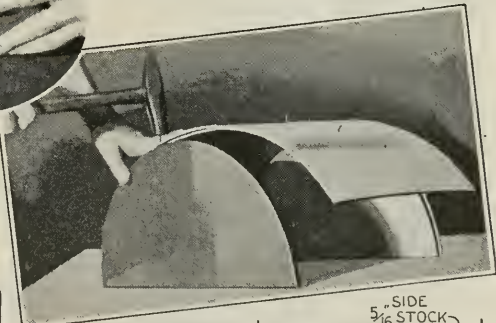

FURNITURE *Built* *without* NAILS

QUICKLY TAKEN APART AND FOLDED
FLAT for STORAGE or SHIPPING

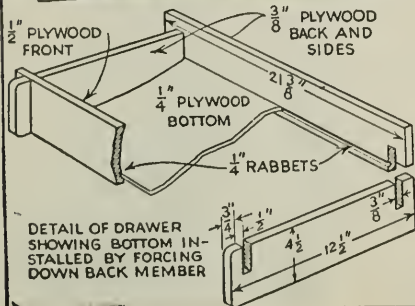
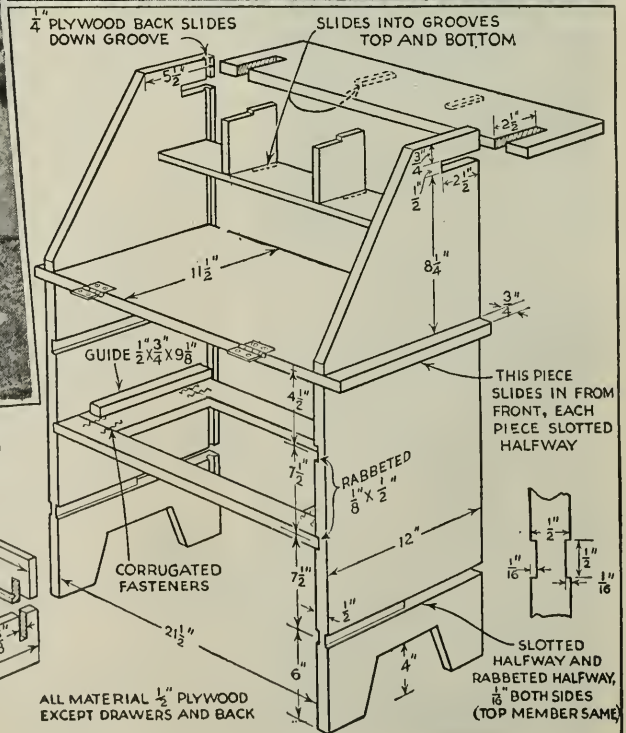
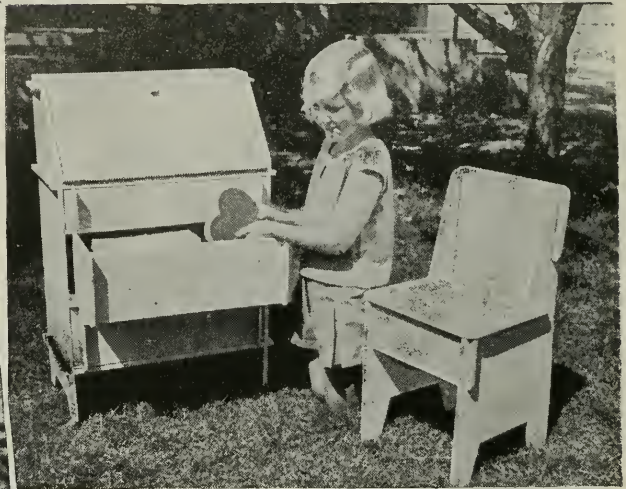
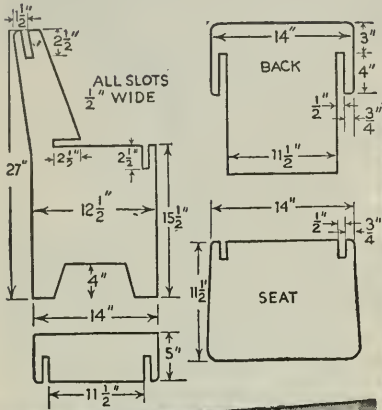

ALL MATERIAL $\frac{1}{2}$ " PLYWOOD EXCEPT DRAWERS AND BACK

Junior's FURNITURE has Secret Compartments

THIS furniture makes a boy's room distinctly his own, and, not only provides a place for many of the things a boy uses in study and play, but each piece has some secret compartment or lock to intrigue the owner and mystify his friends.

The drawing table, shown in Figs. 2 to 5 inclusive, is the easiest to construct. A regular drawing board is used for the top, and the legs are made of tongued-and-grooved pine. Cleats, screwed along the inner faces of the sides to form the drawer slides and guides, strengthen the joints so that short tenons are sufficient. After the sides have been assembled, the back and front drawer rails are screwed in place. Fig. 4 shows how the drawer is made with its false bottom and secret drawer, while Fig. 5 is a rear view of the



table indicating how the lid may be tilted for drawing, and to give access to another hidden compartment at the back. Notice where the pivot point of each hinge is located. The hinges are recessed into the upper drawer rail and top. Brackets, pivoted by a screw through one end, support the top when it is raised.

The bookcase, shown in Fig. 7, has two sliding side panels which expose hidden compartments. The construction of this case, and the location of the compartments are illustrated in Fig. 8. Tongued-and-grooved material is used for the sides of the legs to provide grooves in which the $\frac{1}{4}$ -in. fir panels slide. Note that the decorative scroll pieces between the legs are tacked to the panels only so that they move up and down with them. A metal turn-button controls the lowering of the panel. There is a compart-





ment on each side of the case. The panel door is constructed as shown in Fig. 6. Pieces of tongued-and-grooved stock are cut to width and a tenon is formed on two of the pieces as shown. If the panel is cut to a snug fit and glued in place, it will strengthen the door greatly.

The sea chest is a beauty, and is just the thing in which to keep football clothes, boxing gloves, tennis rackets, etc. It is provided with a secret lock, so arranged that, though no key will open it, a slight movement of the escutcheon plate does the trick. Wide pieces of what is known as white-pine "shelving" should be obtained from the lumber yard. A few tight knots are not objectionable, but rather add to the appearance. Fig. 10 is a working drawing of the chest. Make the back and front pieces first. As the lid is sawed apart after the chest has been assembled, the side pieces must be wide enough to run to the top. It may be necessary to glue up this stock as the sides are 15 by 30 in. To provide sufficient stock to cut the joints, the ends are a full 18½ in. wide at the top and the height is 14½ in. The end pieces should be clamped together in a vise, as shown in Fig. 1, so that they can be planed to exactly the same size and shape. To make the dovetail joints, they are laid out and cut on the back and front pieces first. After scoring the line at the bottom of the dovetail with a sharp knife, start at the top of the piece and space along this line, ½ in. then 1 in. all the way until the last one, which will be ½ in. again. The slant,

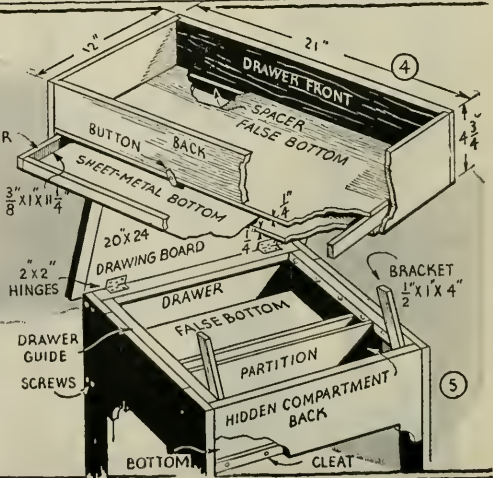
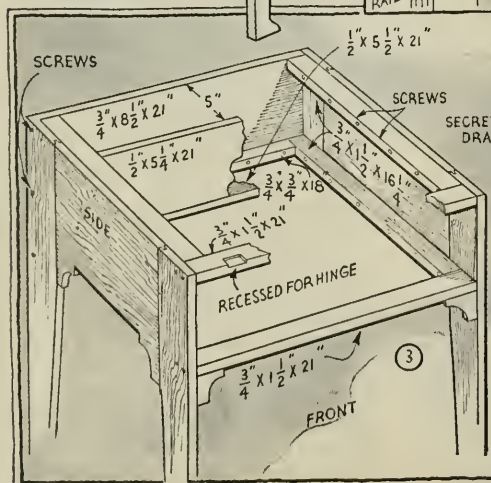
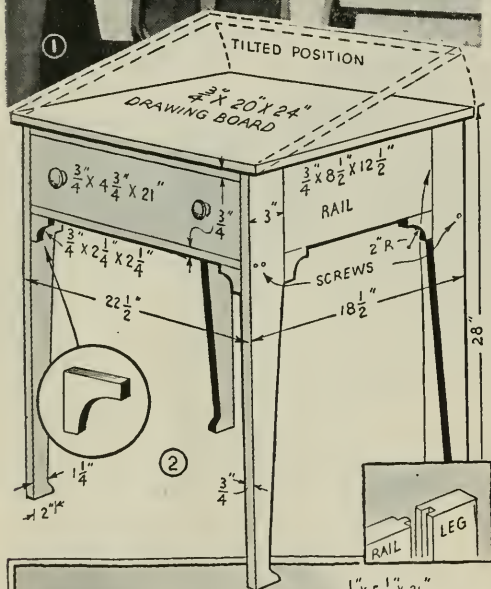

which should be marked off with a T-bevel, is $\frac{1}{4}$ in. in each $\frac{3}{4}$ in. The slanting faces of the dovetails are sawed and the bottom chiseled out. If a $\frac{3}{8}$ -in. hole is drilled to remove part of the waste stock, it will speed up the work. The joints on the ends are marked by holding the finished side piece over it and marking through the dovetail with a knife or sharp pencil as shown in Fig. 16. Joints that do not fit snugly can be patched satisfactorily by gluing in bits of the same material. The patching should be done before the work is planed.

Construction of the lid is shown in Fig. 9. Three pieces of $\frac{3}{4}$ -in. stock are jointed and nailed into place after which a 20-in. radius is drawn on each end. The three top boards are planed to the curve formed by the arc to produce a rounded lid. After the top has been rounded, you are ready to saw off the lid. Start this from the corners, and gradually work toward the centers of the four sides. Handles for the chest are made by braiding three pieces of manila clothesline together. To stiffen the top of the lid and secure the joints, braces are added as in Fig. 15.

The secret lock is shown in Figs. 11 to 14 inclusive. A copper escutcheon, shaped as in Fig. 11, is cut out of $\frac{1}{16}$ -in. stock and hammered on the face with a ball-peen hammer for decoration, and then tarnished by holding it over a burner of a gas stove. When the escutcheon is finished, it should be mounted temporarily by means of a machine screw in the pivot hole shown in

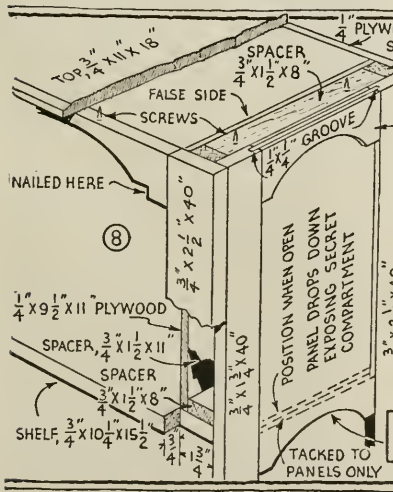
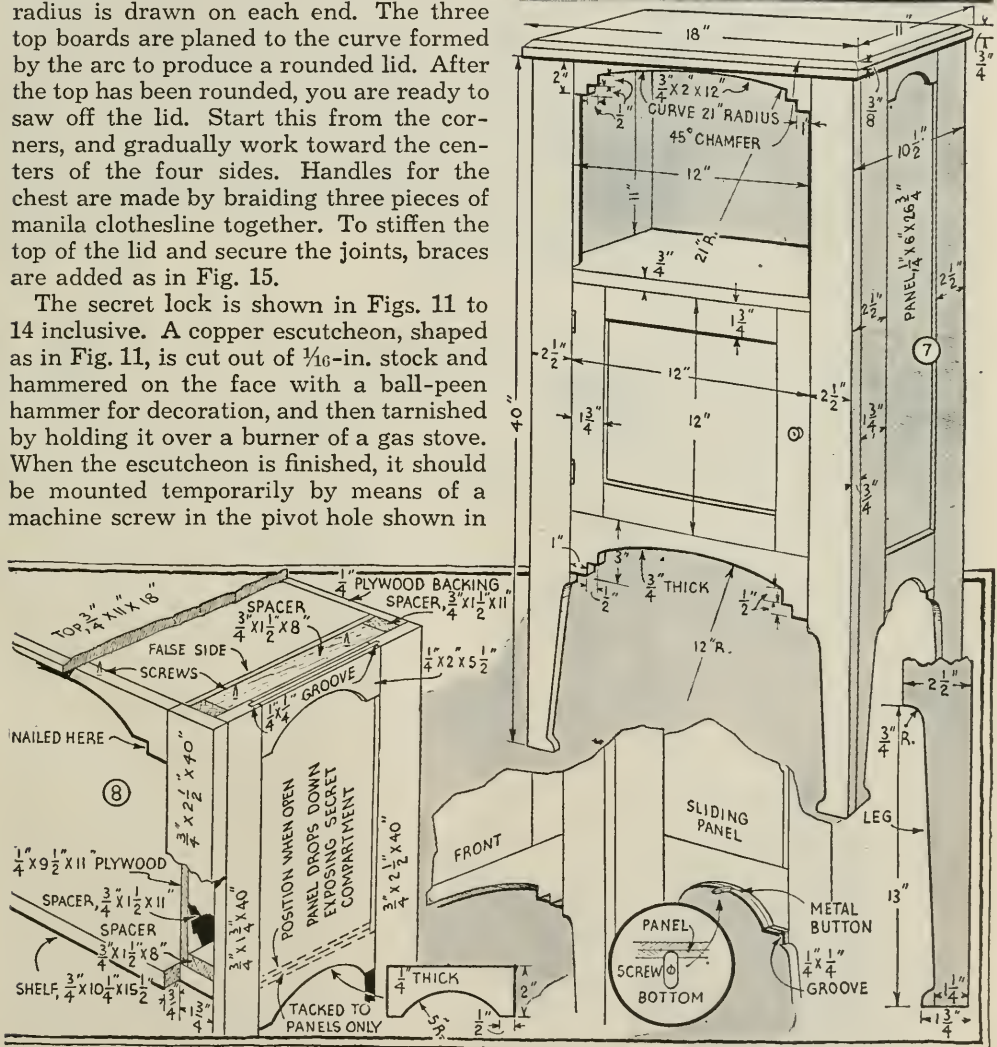
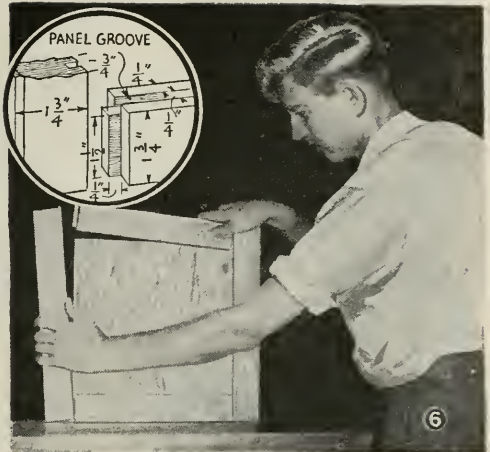

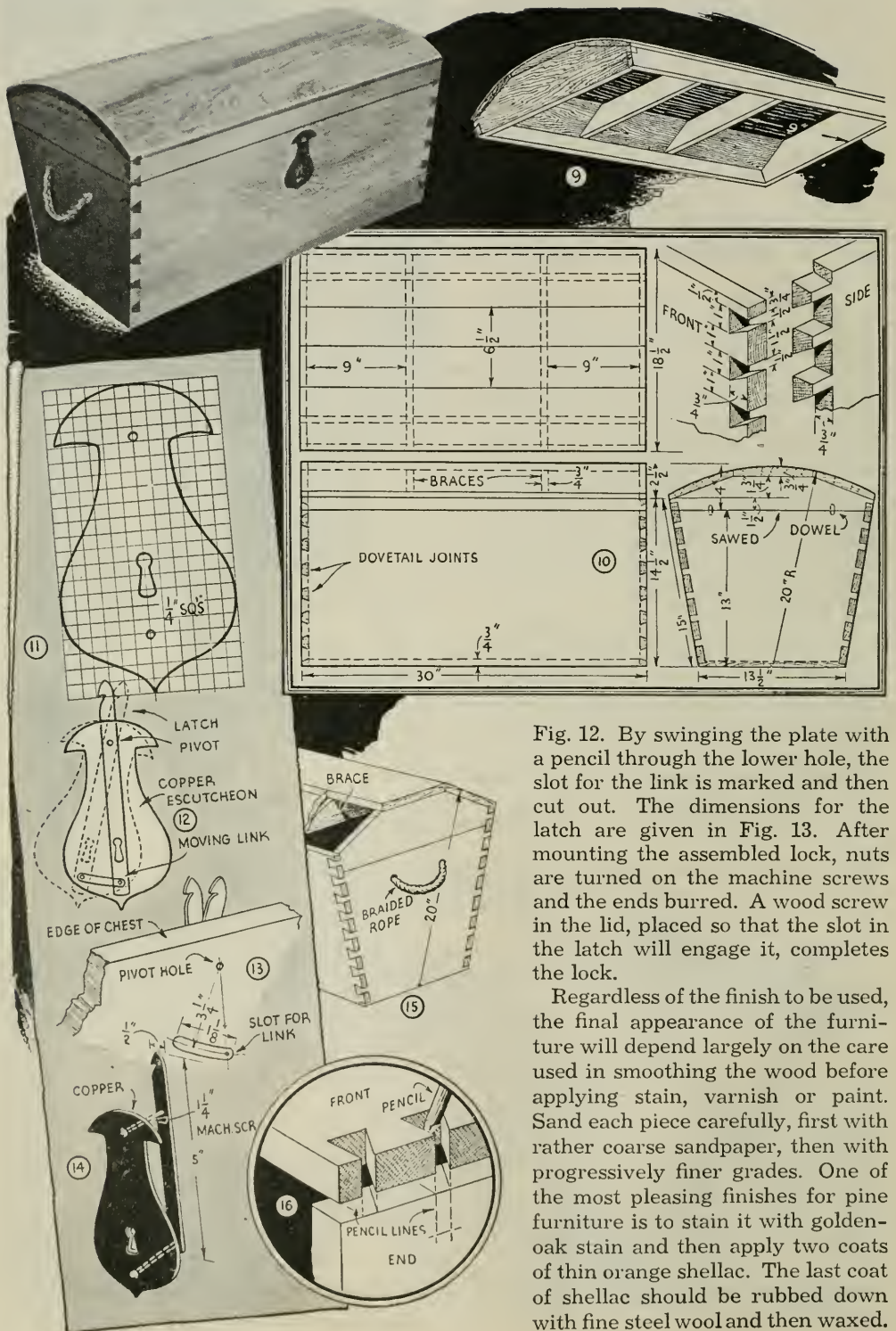
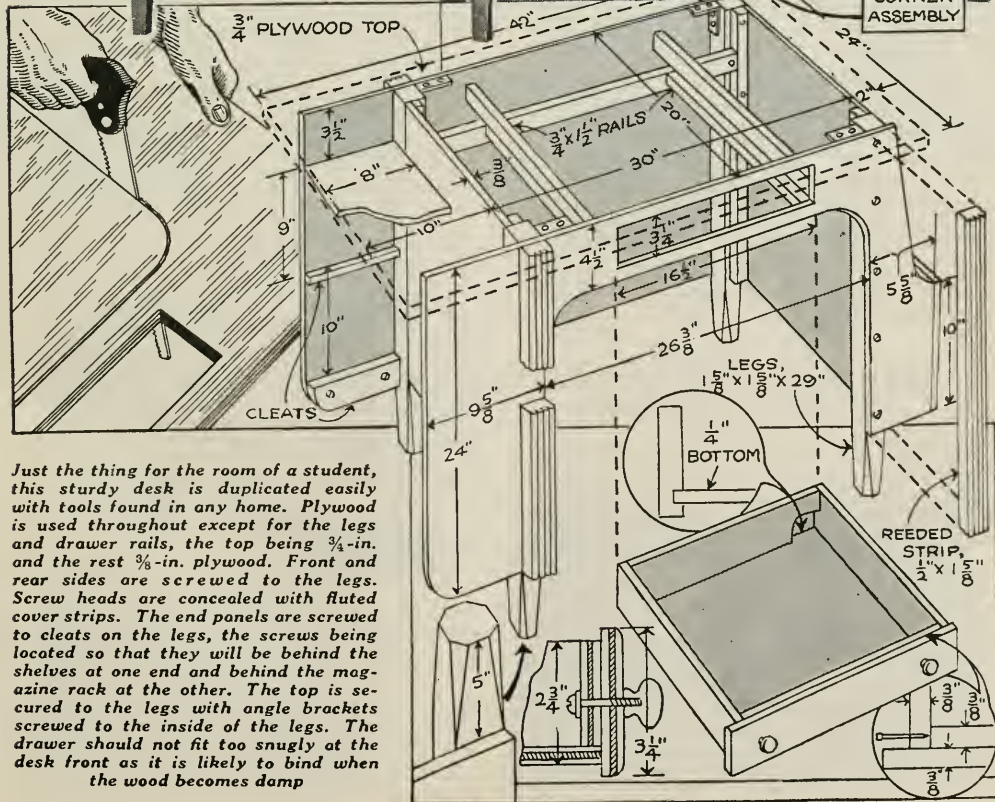
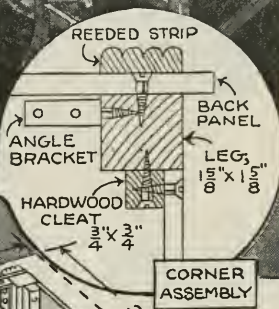
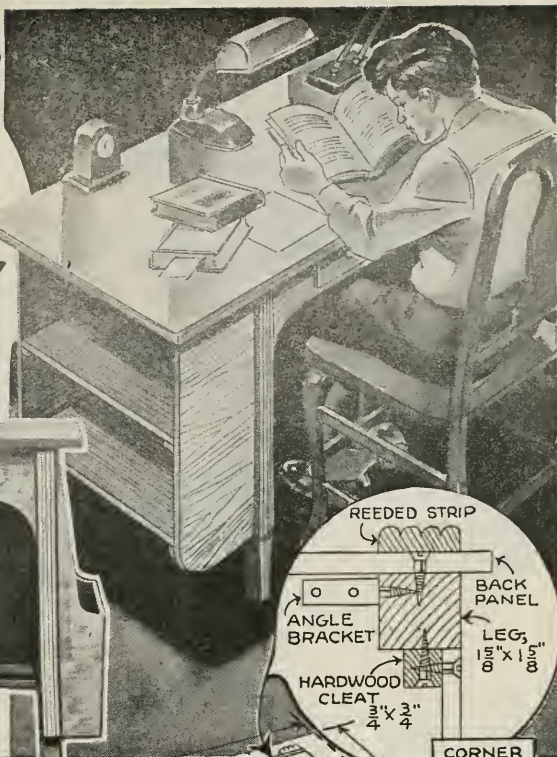

Fig. 12. By swinging the plate with a pencil through the lower hole, the slot for the link is marked and then cut out. The dimensions for the latch are given in Fig. 13. After mounting the assembled lock, nuts are turned on the machine screws and the ends burred. A wood screw in the lid, placed so that the slot in the latch will engage it, completes the lock.

Regardless of the finish to be used, the final appearance of the furniture will depend largely on the care used in smoothing the wood before applying stain, varnish or paint. Sand each piece carefully, first with rather coarse sandpaper, then with progressively finer grades. One of the most pleasing finishes for pine furniture is to stain it with golden-oak stain and then apply two coats of thin orange shellac. The last coat of shellac should be rubbed down with fine steel wool and then waxed.

Designed for STUDY



Just the thing for the room of a student, this sturdy desk is duplicated easily with tools found in any home. Plywood is used throughout except for the legs and drawer rails, the top being $\frac{3}{4}$ -in. and the rest $\frac{1}{8}$ -in. plywood. Front and rear sides are screwed to the legs. Screw heads are concealed with fluted cover strips. The end panels are screwed to cleats on the legs, the screws being located so that they will be behind the shelves at one end and behind the magazine rack at the other. The top is secured to the legs with angle brackets screwed to the inside of the legs. The drawer should not fit too snugly at the desk front as it is likely to bind when the wood becomes damp

Inexpensive Desk of Plywood for Schoolboy's Study Room

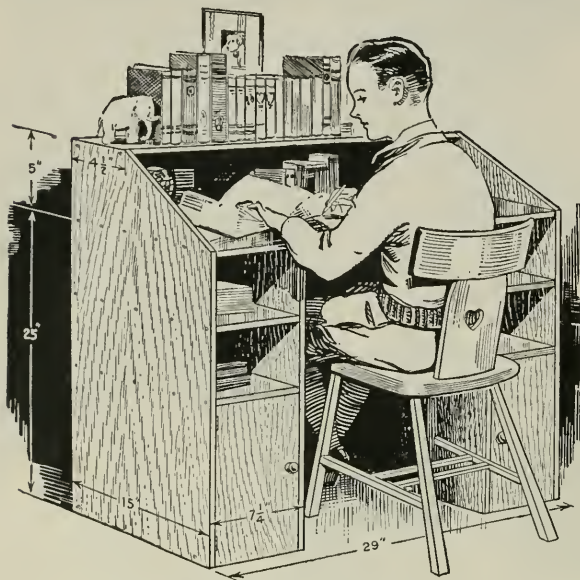

Just the thing for the schoolboy's or girl's study room, this desk can be assembled by anyone with a hammer, saw and screws. Made of $\frac{1}{4}$ -in plywood, it is inexpensive and is really neat looking when painted or stained and varnished. Besides plenty of room for books, there is ample writing space, four open shelves for papers, ink and other school accessories, and the two closed compartments at the bottom are real treasure chests if the doors are fitted with locks. After assembling the desk, give it a thorough sanding, especially the exposed open grain at the edges and then apply your finish.

Dipping of Pen in Wrong Ink Avoided by This Stand

Holding bottles of red and black ink, this stand has a pivoted cover that is

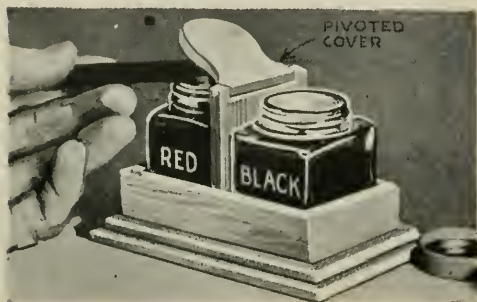

turned over the bottle not being used so that there is no possibility of accidentally inserting the pen in the wrong one. Both inks cannot be exposed at the same time, and the cover is so loosely pivoted that it will not remain in a vertical position.

This Secret Lock Is Opened With a Match Stem

Here's just the lock you have been wanting for that treasure box. It costs nothing because all you need is a spring-type clothespin, a match and an L-hook or screw. First drill a hole in one of the legs of the clothespin to take the hook. Screw the clothespin to the inner side of the front of the box and drive the hook into the underside of the lid so that the hook will slip into the hole in the leg. Drill a hole through the front

of the box and through the fixed jaw of the clothespin to take the match. Several false holes drilled part way through the front will add to the deception. To operate the lock, push the match through the hole

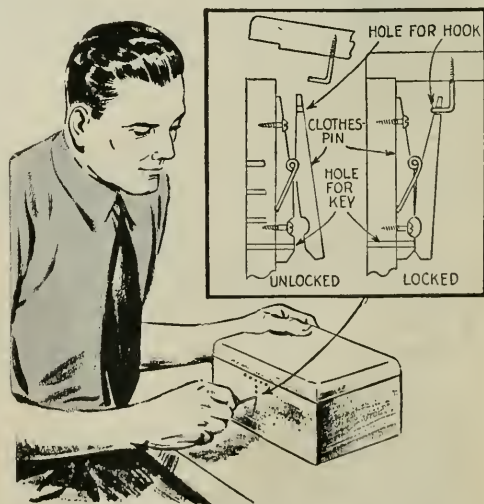

against the movable jaw of the clothespin to compress the leg and release the hook, which will permit the lid to be raised.

ⓂMetal-rimmed tags make novel frames for miniature photos. Spread the rim, remove cardboard, insert photo, and press rim down again.

A Pioneer FOOTSTOOL

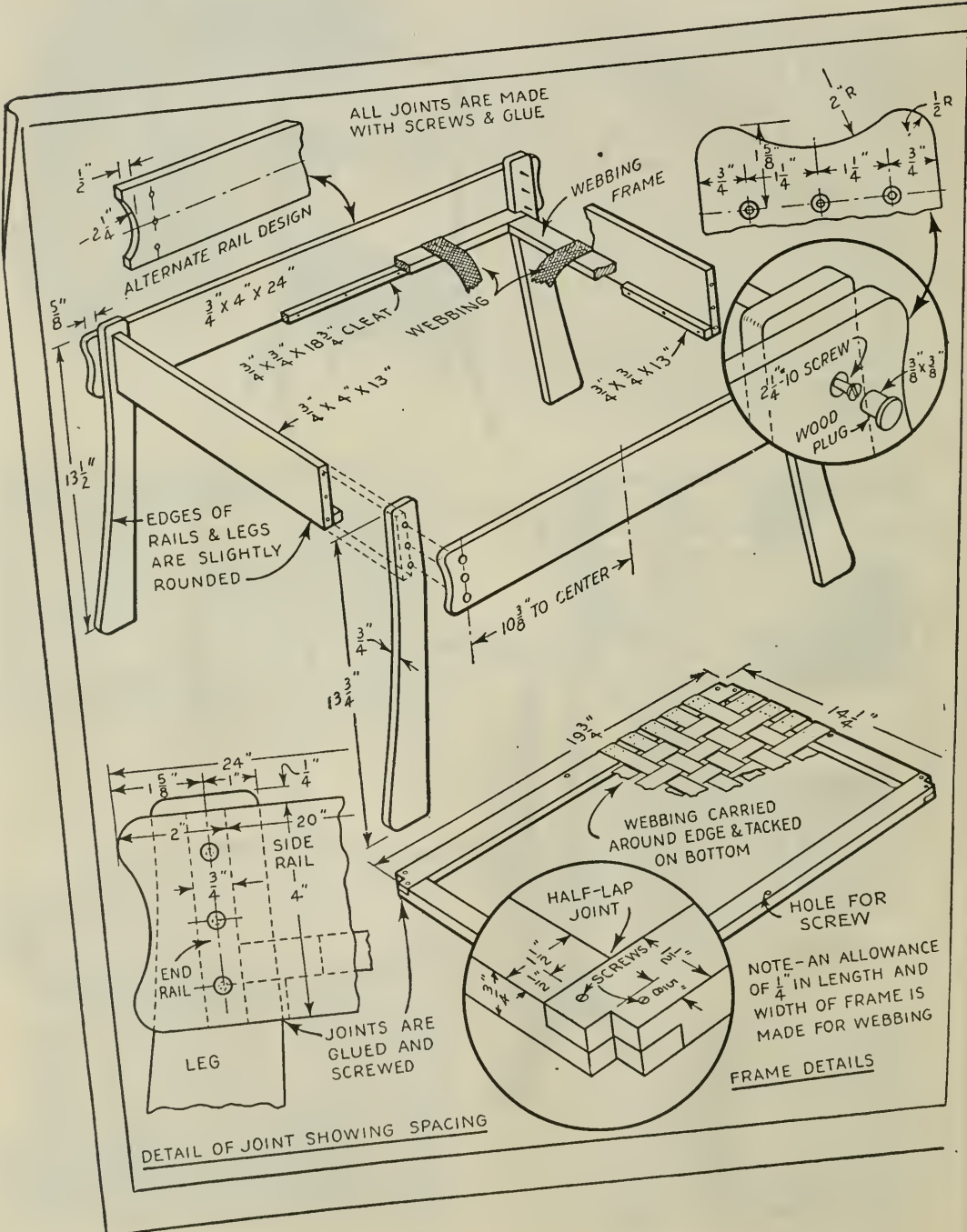

Humidor and Pipe Rack Combined in One

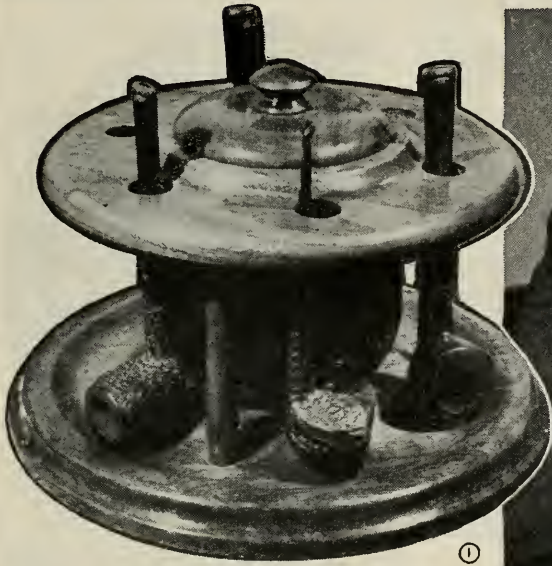

Appropriate for the discriminating pipe smoker, this combination humidor and pipe rack accommodates six or more pipes and a good supply of tobacco. The unit consists of a turned wood base and top, and a colored lantern globe, which serves as the humidor, three dowels being used to space the wood parts and hold them on the ends of the globe. Fig. 1 shows the completed unit, while Fig. 2 gives the assembly. Openings are made in the top for the pipe stems and the humidor lid. Fig. 3 shows how a wood chuck is used to hold the top disk on a faceplate. Notice that the lid opening is rabbeted on the underside to take the globe end and that the base is grooved for the same purpose. The rabbet is turned while the disk is still on the improvised chuck as in Fig. 4. The groove should be slightly oversize to prevent shrinkage of the wood from breaking the glass. The globe can be cemented in the groove if desired, although this is unnecessary if the top and base are held tightly on the globe ends by the dowels. A little melted paraffin poured in the bottom of the humidor will prevent tobacco from contacting the wood. A humidifier is provided for the tobacco, and consists of a can cover screwed to the underside of the lid and filled with plaster of paris, which is moistened with water occasionally. Either wax or shellac provides a nice finish for the wood parts of the unit.

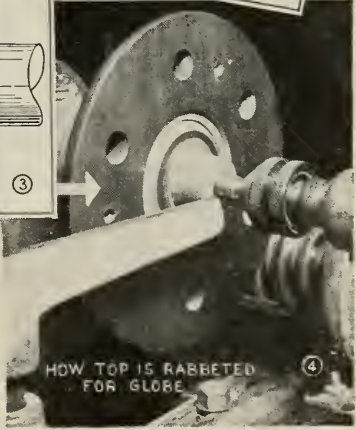
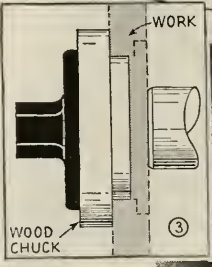
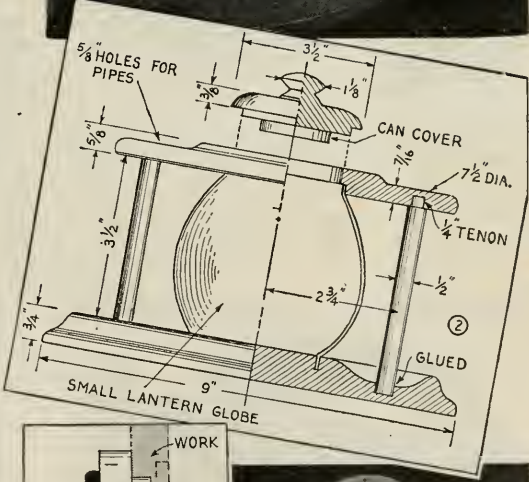

Colorful Cigarette Tray of Metal and Plastic

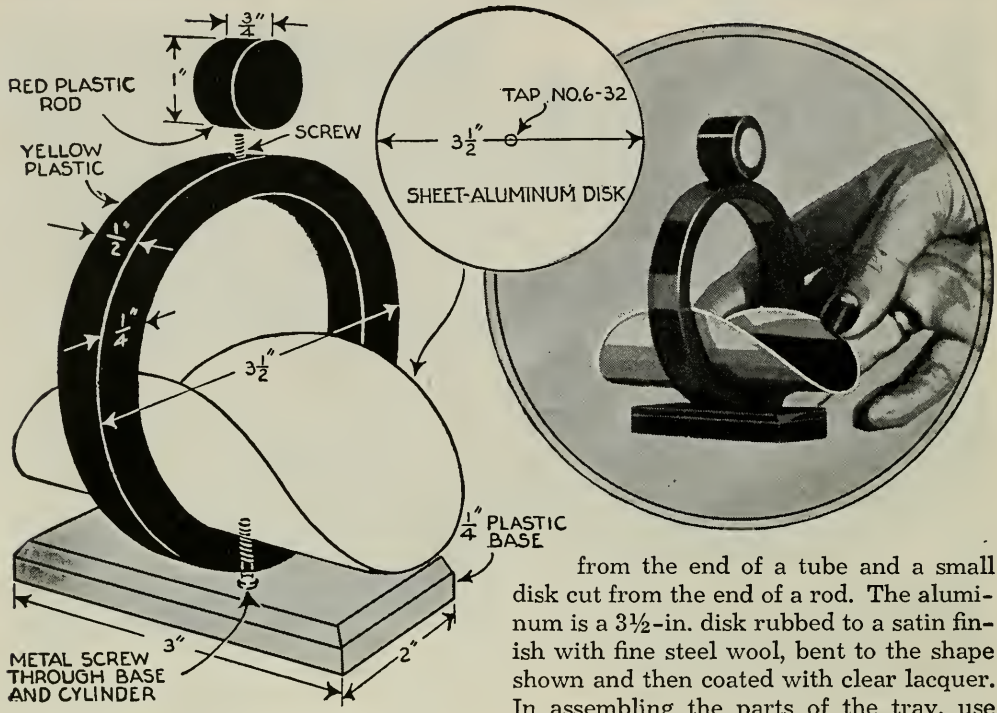

Here's a snappy little cigarette tray in which brightly colored plastics are contrasted with aluminum rubbed to a satin finish. Three pieces of plastic are used; a flat piece for a base, a large ring sawed

from the end of a tube and a small disk cut from the end of a rod. The aluminum is a 3 1/2-in. disk rubbed to a satin finish with fine steel wool, bent to the shape shown and then coated with clear lacquer. In assembling the parts of the tray, use two screws; one which is tapped into the lower side of the plastic disk and the other which runs through the plastic base and ring and is tapped into the aluminum disk.

Wheelbarrow Ash Tray Is a Novel Addition to the Den

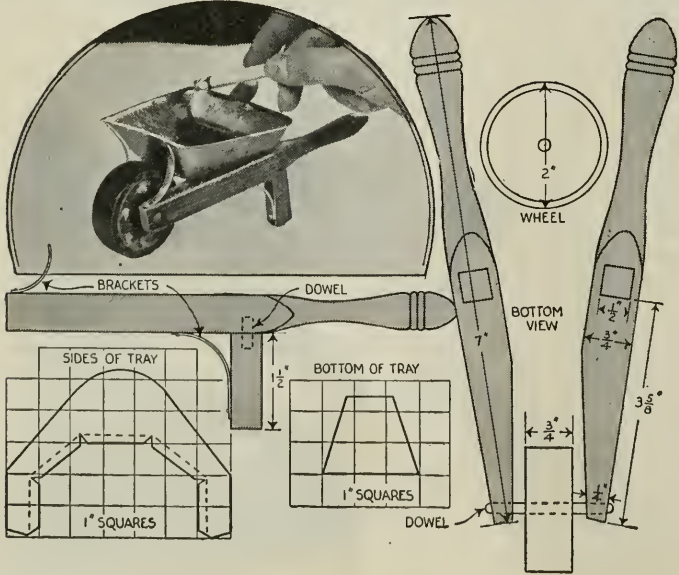

A wheelbarrow built in miniature makes an unusual ash tray for use at your card games. Or, if desired, it can be used as a tidbit tray. The wheel, handles and legs are made of maple, and the body consists of two pieces of sheet copper shaped as shown in the squared diagrams and assembled with tiny copper rivets. A coat of clear lacquer will prevent tarnishing of the copper after it has been brought to a bright finish by polishing, and the wooden parts can be waxed, varnished or stained to suit.

Scenic Wall Rack to Hold Guns and Books

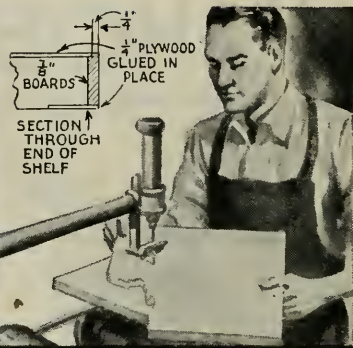
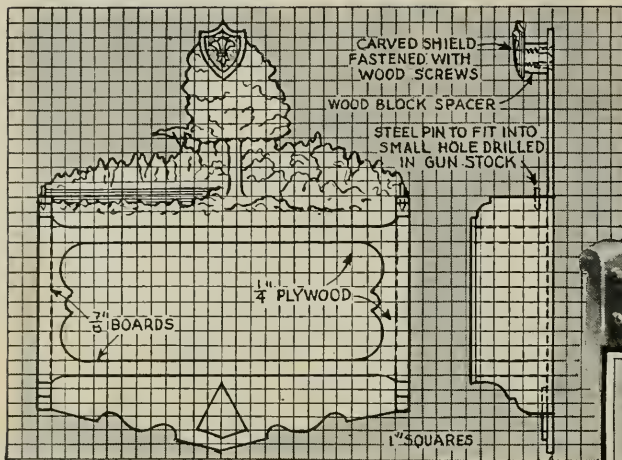

One sportsman who had rather limited wall space in his den for a gun rack and also a hanging bookshelf, combined the two into a single unit of unusual design. To fit in with its purpose, the scroll-sawed top, painted to represent a woodland lake, lends additional "atmosphere." The view shown above may be duplicated by first sketching it on a large sheet crosshatched in 1-in. squares, then tracing the pattern on wood by means of carbon paper, and finally scroll-sawing. If you are artistically inclined the job of painting the scene suitably will be simple, but if you are not inclined to do this, you can substitute a large photo of a similar appropriate scene. For this purpose you use an enlargement which is glued to the wood securely before scroll-sawing along the edge of the

treetops and horizon. Of course, the enlargement need not extend entirely across the width of the rack but it may be only about 12 in. wide and located centrally. In assembling the parts you can use glue and screws, countersinking the screw heads and concealing them effectively with crack filler.

Neckties Hung on Outstretched Arms of This Silent Valet

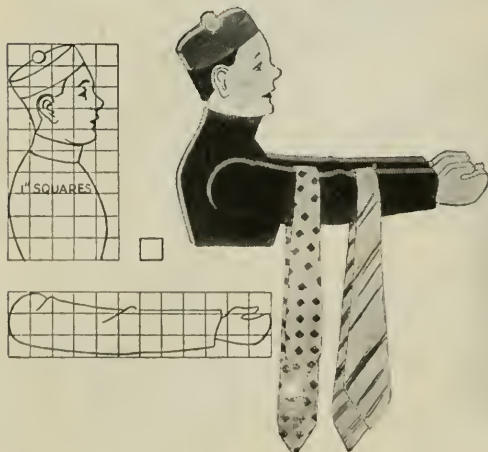

Fastened to the wall in your bedroom or to the inside of the closet door if you prefer to keep it out of sight, this silent valet which is designed to hold neckties, is something different from the usual necktie holder. It can be varied in color to be complementary to the furnishings and color scheme of the room. To make it, you can use regular stock such as poplar, running the grain of each piece lengthwise, or you can use 1/4 or 3/8-in. plywood. The wood should be well filled in at the edges by applying a couple of coats of shellac and then paint. Previous to painting, all edges should be sanded to render them smooth so it won't be possible to damage the neckties as they are slipped on or off the arms when you're in a hurry.

Flower Basket

from the
WOODPILE

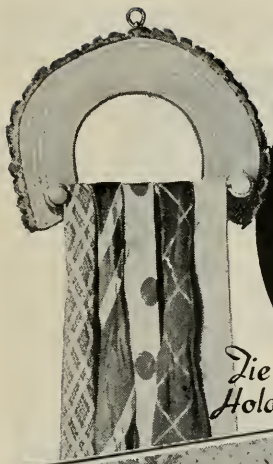

Tie Holder



Bark-covered tie holders, flower baskets, pipe racks and nut bowls are just a few of the interesting and useful things you can make from material in the woodpile. The stock is sawed and turned to shape and is then sandpapered smooth before applying shellac for finish. Green wood often splits upon drying out rapidly, so in order to make the wood dry slowly, put the pieces in sawdust, saturate this with water and set away to dry. After the sawdust and wood have dried thoroughly, which may take several months, you can work the latter and be reasonably certain that it will not split

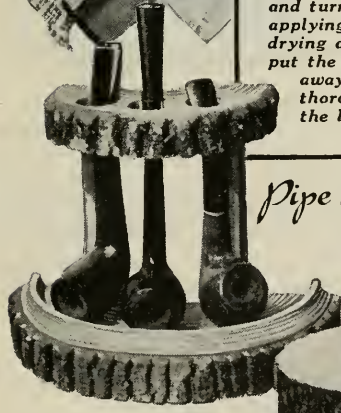

Pipe Rack

Nut Bowl

Bank

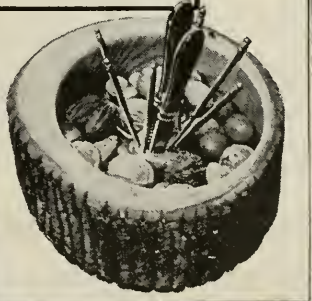

Novelties

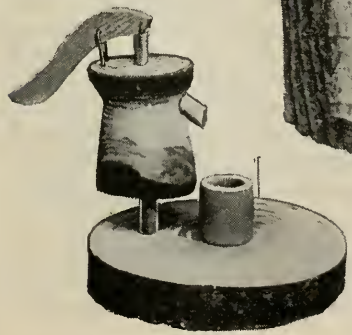

Sewing Set

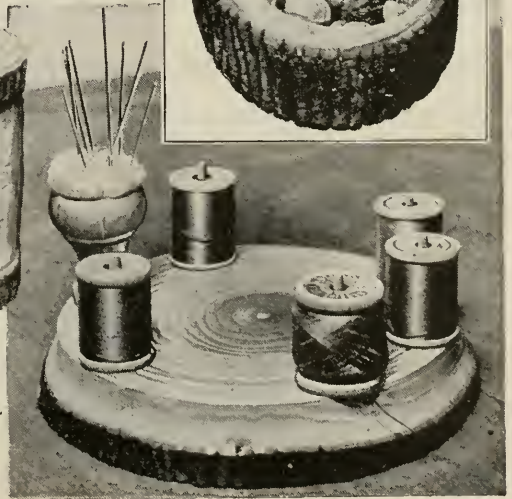

Personalize Your Tie Rack With a Photograph



Using enlargements of favorite photos, you can make these tie racks for yourself, and they will be appreciated as gifts by your friends. A photo of the head and shoulders is glued to $\frac{1}{4}$ -in. plywood and then cut out with a jig saw. When finished, the photo should be about 7 in. high. If desired, silhouettes can be substituted for

photos. In this case, the outline of a photo is traced directly on the wood, which is then sawed to shape and painted black. The rack for the ties is a block of $\frac{3}{4}$ -in. hardwood cut as shown and screwed to the plywood back near the lower edge. L-hooks to hold the ties are then driven into the edge of the hardwood piece.

"Rope Ladder" Shelves Hung on Door, Window or Wall

Suggestive of rope ladders used on ships, these shelves look well on glass doors and

give added space to the indoor gardener. They are useful for walls and windows, too. Ropes through holes near the corners of the shelves support the boards on knots tied just below the holes. The ropes are supported from brackets on the door so that the latter may be opened without disturbing the shelves. The holes in the shelves should be small enough so that a single knot will not pull through them.

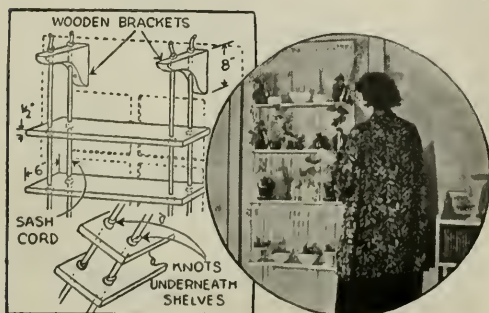

☐ A spring-type clothespin with one handle screwed to a cabinet door, makes a good holder for a tube of tooth paste.

"Black Forest" CORNER SHELF

has rounded edges

FOR ADDING a refining touch to the tasteful room, why not consider the beautiful corner shelf shown in Fig. 1? Its graceful design will add a friendly charm to a corner where nothing else seems to do. You can reproduce this shelf using a hand scrollsaw, or it can be produced in number quickly by using the pattern-routing method.

For a truly fine piece of work, solid walnut stock is preferable to plywood as it is difficult to conceal the plies of the latter when the edges are rounded. Patterns of the sides and the three shelves, Figs. 2 and 3, are enlarged full size on paper ruled off in $\frac{1}{2}$ -in. squares, after which the outlines are transferred to $\frac{1}{4}$ -in. stock. Both pieces are placed face to face and tacked together temporarily, allowing the edge of one to overhang $\frac{1}{4}$ in. Then "entering" holes are drilled through the open areas for inserting the saw blade. After saw-

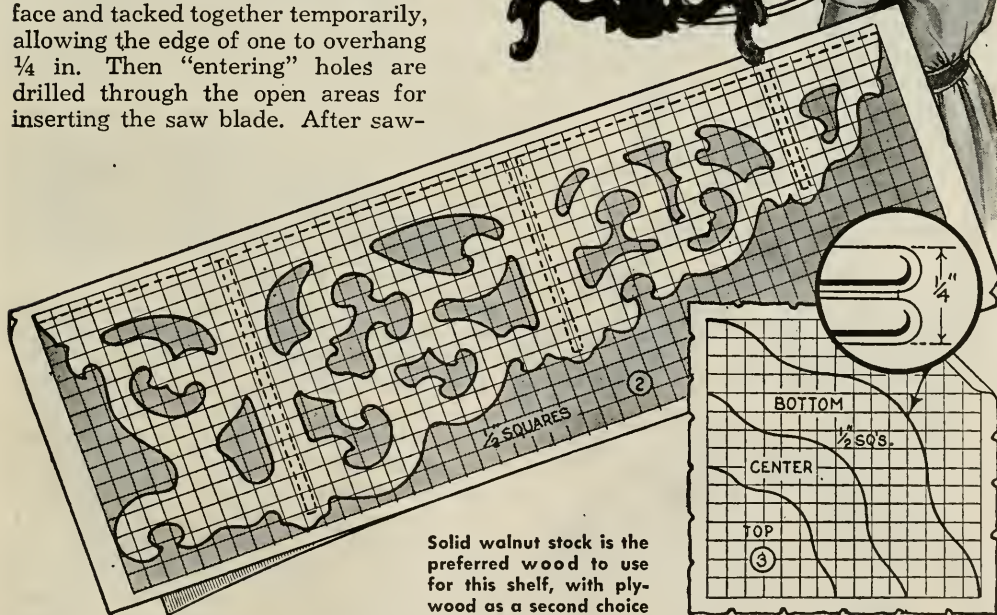
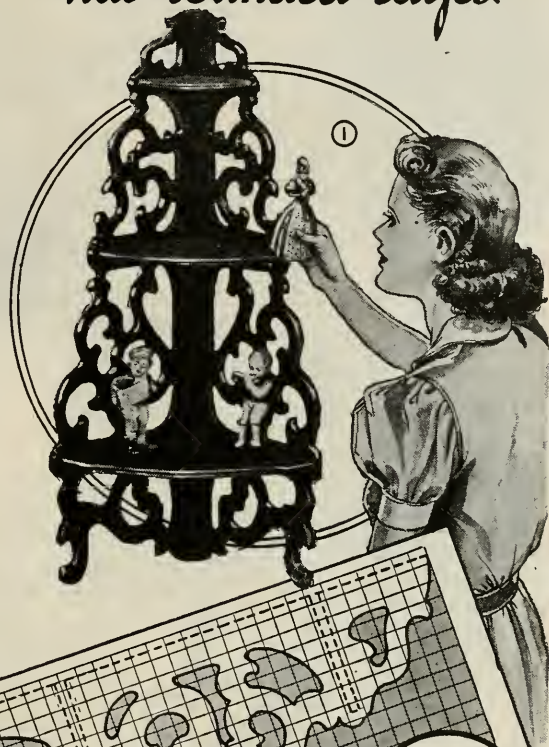

Solid walnut stock is the preferred wood to use for this shelf, with plywood as a second choice

Shellac Brush Is Wrapped to Prevent Drying

When you use a shellac brush several times a day, the muss and delay of washing it out with alcohol each time can be eliminated by wrapping the bristles and part of the ferrule with a double sheet of wax paper. This should be twisted tightly about the handle to exclude air. Brushes protected in this way will remain soft overnight, despite the tendency of shellac to dry in a few minutes.



TEMPLATE ROUTING PRODUCES IDENTICAL UNITS

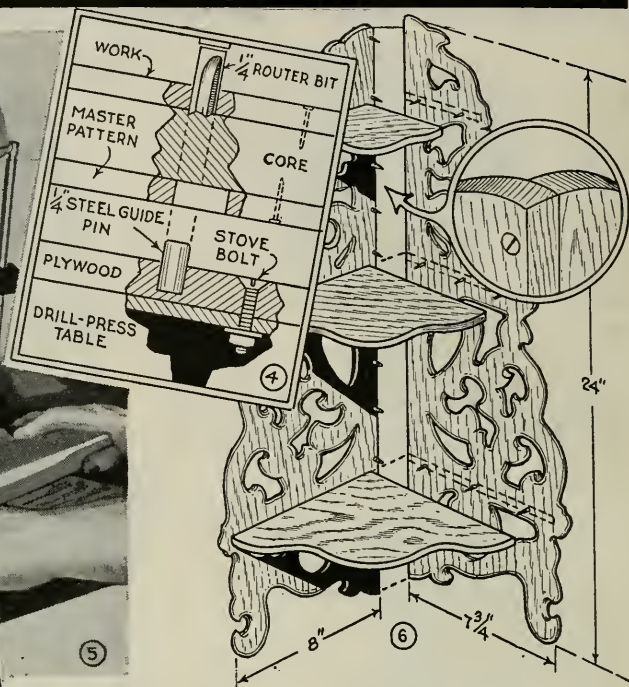
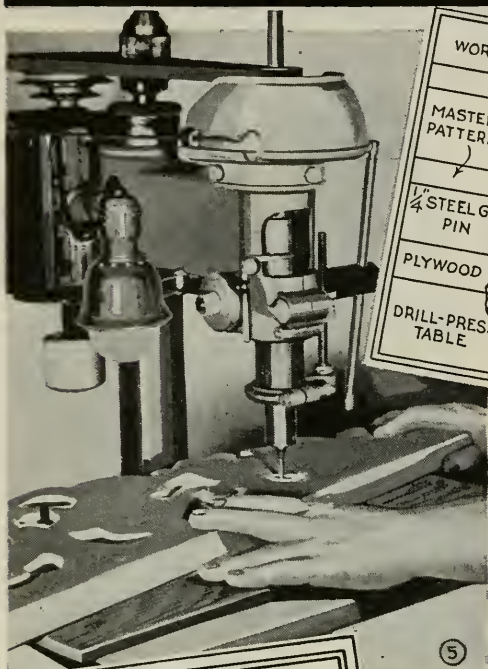

ing out the work carefully, the edges are rounded slightly with a strip of sandpaper, Fig. 8. If you wish, the edges of the shelves may be beaded as in the circular detail of Fig. 3. Slender screws hold the parts together as shown in Fig. 6. The position of the shelves is given in Fig. 2.

For producing the shelves in quantity, Fig. 5 shows a simple production method which can be used for cutting any number of scrolled side pieces exactly alike. Here a drill press is used to rout out the fretwork instead of sawing it. A master pattern of the scroll design, Fig. 2, is jigsawed carefully from a piece of fir plywood. Then this pattern or template is nailed to a softwood core as in Fig. 4. The drill press table is fitted with an auxiliary plywood table in which a 1/4-in. steel pin is inserted directly below and in line with a 1/4-in. router bit placed in the chuck. As the pin follows the opening in the template, the router bit will make an exact duplicate cut in the walnut piece bradded to the core.

Fig. 7 shows a simple tool to speed up the rounding of the edges. Revolving at high speed in the drill press, the tool is run around the routed opening, first on one side and then the other, after which the edge is gone over with fine sandpaper.

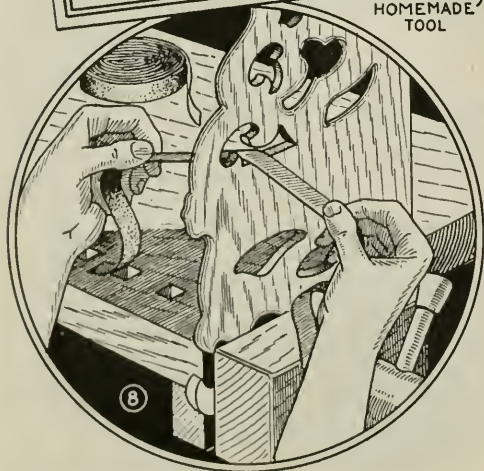
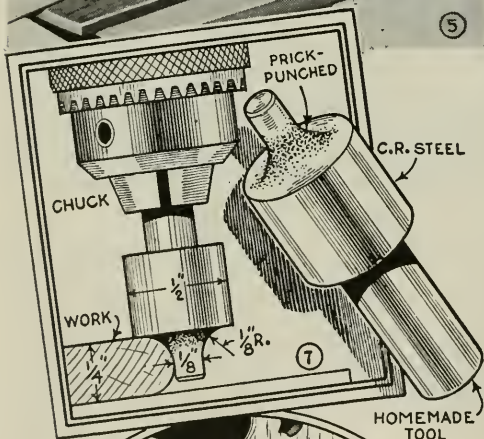

Dress up the CHILD'S ROOM

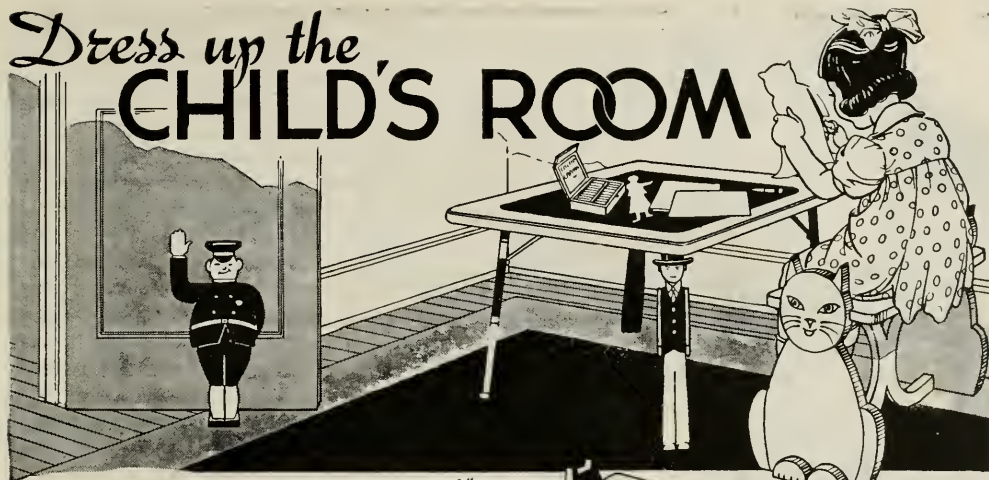

ONE of the advantages of the jigsaw is the almost endless variety of uses to which it may be put, and the speed with which projects can be completed. Besides, the tool is simple to master and it is inexpensive. Attractive designs may be turned out in a single evening—things which will

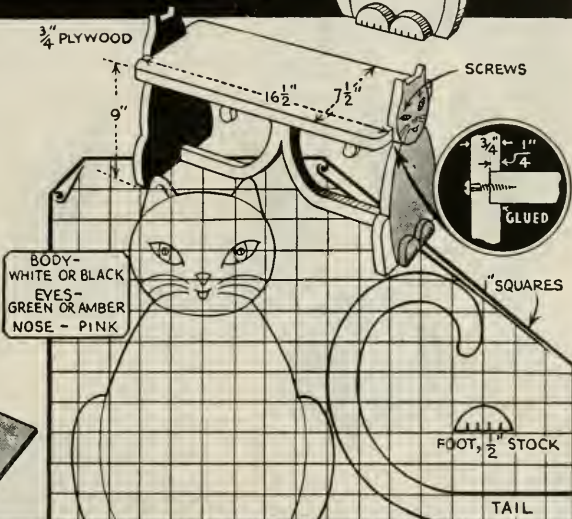
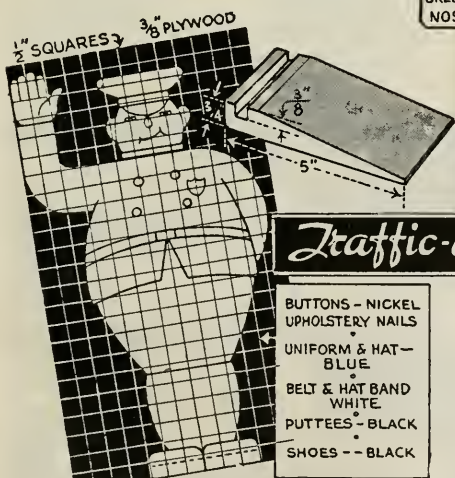

Traffic-cop dootstop and cat bench

squares. The figure is projected to the size desired on paper and the outline inked in. This is a particularly good method to employ in making toys for children.

A room in which each article has special appeal to the youngster's imagination will make play of the dullest routine matters and help to form good habits. Any ordinary room can be dressed up to please your child, with only the aid of a jigsaw and a few hand tools. All of the articles shown here are of simple construction, just the kind of work for spare time, and scraps can be utilized in making some of them.

The traffic-cop doorstop is scroll sawed from 3/8 or 1/2 in. plywood and has a wedge-shaped base. It is grooved for the feet, which are glued and nailed in place. Buttons on the cop's coat are small upholstery

please your family and arouse the admiration of your friends. And then you can create your own projects, or reproduce quickly the novelties you see in stores or windows, varying the designs to suit yourself. Many craftsmen are using a photographic projector to vary the size and enlarge the outlines of figures and pictures on which they desire to work. An old magic lantern will serve the same purpose, thus avoiding the work of enlarging the



Clothes hamper

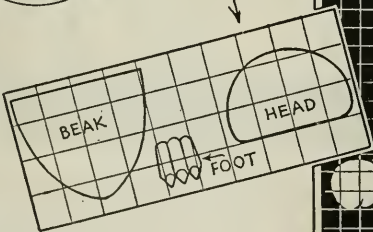
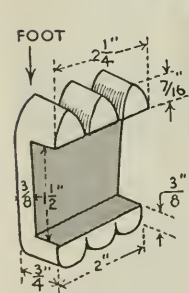
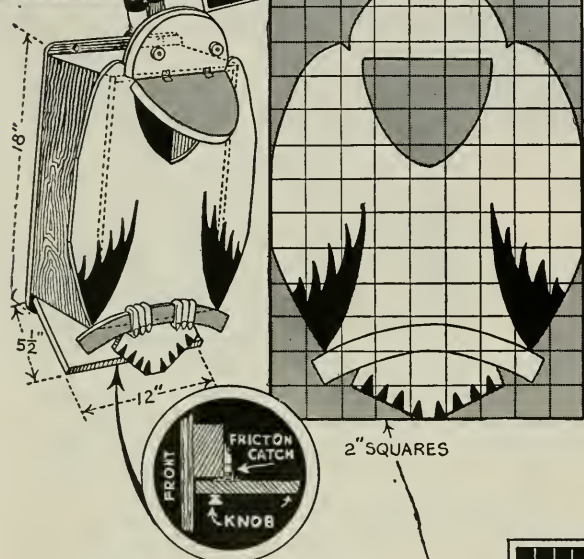

nails. The top of the cat bench fits into grooves in the sides, and screws are driven through the eyes into it. Round the corners of the top to meet the ends. The tails are attached with screws, which are countersunk, while the feet are glued and nailed on.

Putting soiled clothes into the bird-front hamper on the wall or door is a delight to any youngster. The hinged beak covers the opening and the bottom is hinged for removal of the clothes. Saw the bird from 1/4-in., the limb from 3/8-in.,

and the head, beak and feet from 3/4-in. stock. Cut disks 1/4 in. thick for eyes. Nail a strip of wood to the back of the bird, even with the bottom of the box, to serve as a stop for the bottom, which is held in place by a friction catch.

Clothes hangers with personality will help to get a child into the habit of hanging up clothes. Saw the hangers from 1/4 or 3/8-in. plywood, round the edges and sand them smooth. Use wire hooks from ordinary hangers, the kind having straight stems. Bend the end of the wire slightly, apply a coat of household cement and force it into a hole bored vertically in the top of the hanger. When making the clown hanger, bore the hole for the hanger before the pointed cap is cut. The Eskimo is particularly suitable for a youngster's winter togs, while the cowboy's "five-gallon" hat is just the thing for sport clothes. The clown's foolish grin and his fantastically painted face make him a favorite.

Any child will take pride in keeping shoes shined with a grin-

1/2" SQUARES 1/4" PLYWOOD

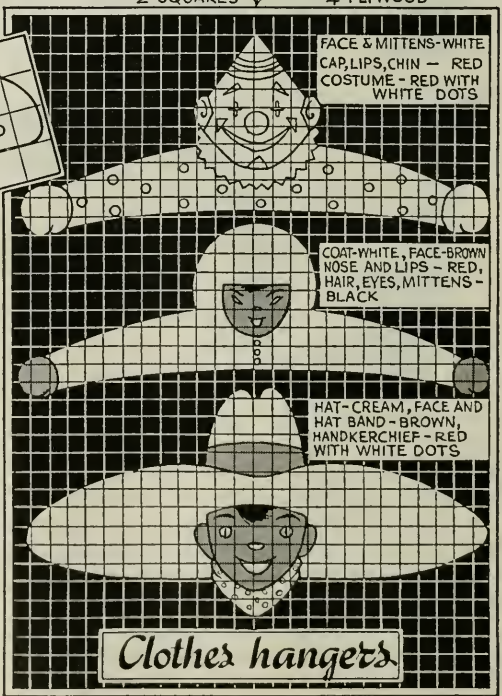

Clothes hangers

ning bootblack always ready to help. A little black box with the hinged top holds polishes and the darky's hands are provided with hooks to hold a shiner, buttonhook and shoehorn. Build the bootblack and box from $\frac{1}{4}$ -in. plywood, sawing the back of the box and the figure in one piece. The base should extend beyond the sides and front of box and a notch is cut out for the back to fit in. Fasten the

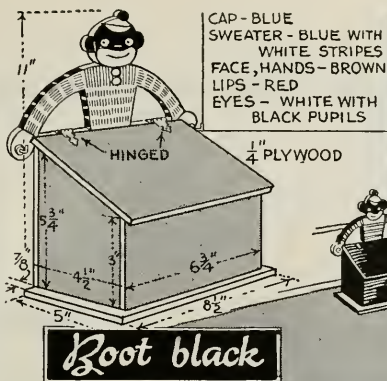

Boot black



pieces together and saw out a lid which also will project a little over the sides and front. Black is the most practical color for the box, as it is just the right height to support the foot while shining the shoe. A vivid sweater and cap offer contrast to the black face and box. The eyes are white thumbtacks with black spots painted on them.

EYES - BLACK
BEAK - ORANGE
COMB AND
WATTLES - RED



PENGUIN - FEET & BEAK - YELLOW
BACK - BLACK
BELLY & EYES - WHITE

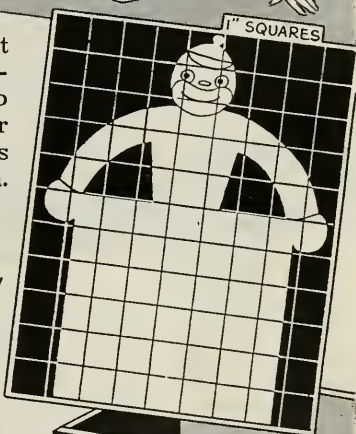
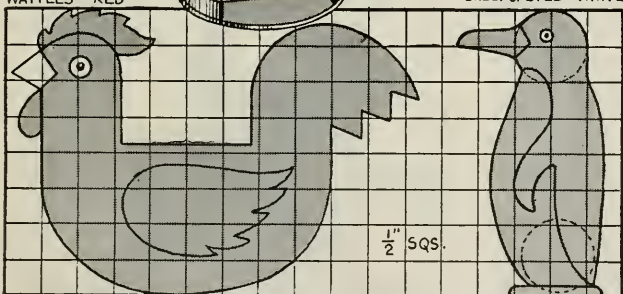

Chests of drawers, dressers or cupboards are easily adapted to juvenile use by giving them a new coat of paint and colorful handles such as gaily painted cocks, sleek penguins or jumping-rope girls. These may be placed in pairs, face to face, or in single file down the center of the drawers. All of these will delight the child and are made in a jiffy. Use $\frac{1}{4}$ -in. plywood for the front of the cock and $\frac{3}{4}$ -in. stock for the back, part of which is cut away to leave space for the hand. Glue the two pieces together and put in small screws at both ends to hold them more securely, countersinking them and filling the holes with putty or other plastic filler. Saw the penguins from $\frac{3}{8}$ -in. plywood. Glue and screw $\frac{3}{4}$ -in. lengths of 1-in. dowel under each end to hold them away from the

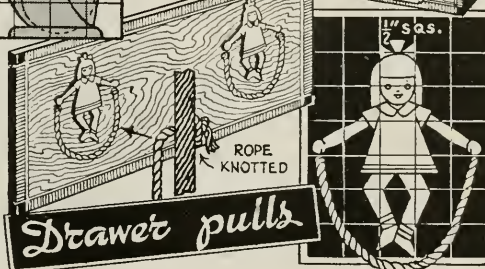

Drawer pulls

drawer to accommodate the hand. A small upholstery tack or a flat bead held on with a brad makes a good eye. The jumping-rope girls are cut from $\frac{1}{4}$ -in. plywood, painted in gay colors and glued to the drawer. Lightweight, twisted clothesline is used for the jumping rope. Bore holes in the drawers behind the hands, draw the two ends of the rope through and tie knots on the inside to secure them.

It's Fun to Rock Between These Two Bunnies

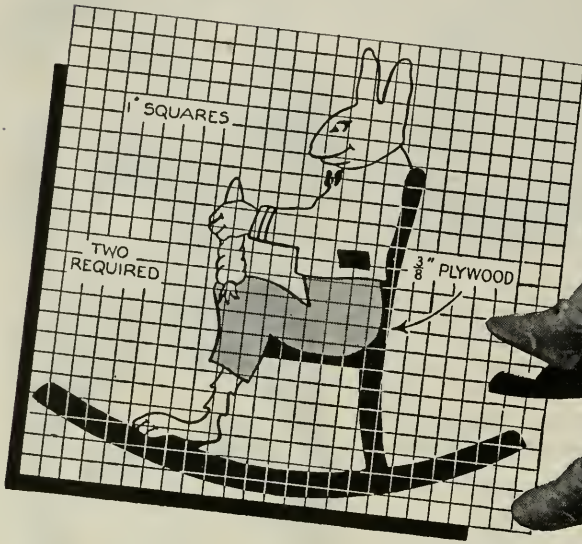

Guarded on both sides by colorful cut-outs of Peter Rabbit, this little girl enjoys sitting in her bunny rocker. The chair is sawed from $\frac{3}{8}$ -in. plywood and consists of four parts—a seat, back and two sides. The rockers are integral with the sides. In assembling the chair, the edges of the seat and back are butted against the sides and fastened with glue and screws spaced about 3 in. apart. Or, you can use cleats under the seat and behind the back for additional rigidity. The cleats are first screwed to the sides, then the seat and back are screwed to the cleats. Painting in bright colors enhances the appearance. First give the wood a coat of shellac and sand lightly when dry. Then finish as desired, painting the cut-outs in identical colors on both sides. The original chair had dark-blue rockers, seat and back, and the bunny cut-outs wore brown trousers and green jackets. Their faces, feet and hands were pale pink. Black neckties, jacket pockets and trouser stripes offer just the right contrast. The carrots in their hands are orange and the eyes are black with yellow pupils.

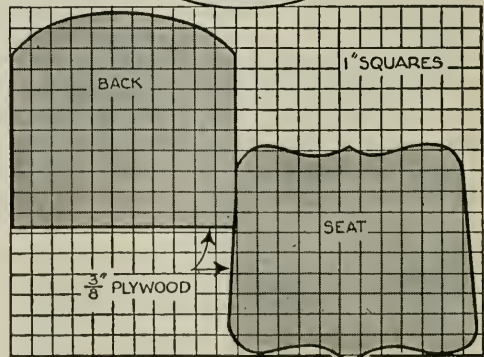

ⓈDon't use cheap paint brushes if you wish to avoid brush marks. For overnight protection, immerse brushes in the paint, if sufficient paint is present to cover bristles right up to stock. Otherwise, wash brushes in thinner and immerse in thinner up to stock.

Circus Elephants Give Child a Ringside Seat

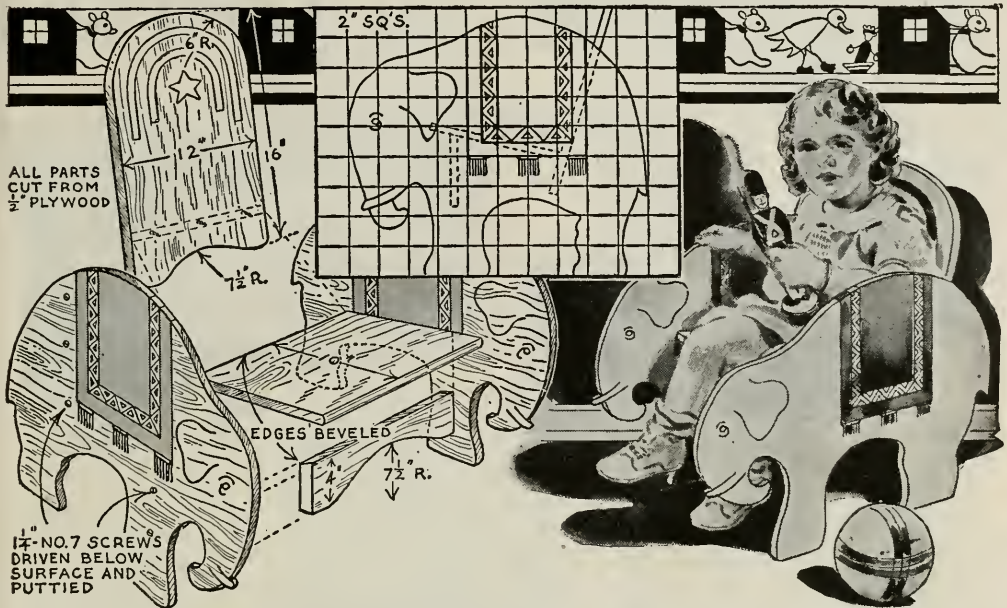

Your small child will take pride in possessing this gaily colored chair, and anyone can make it with a scrollsaw and a screwdriver. All parts are cut from $\frac{1}{2}$ -in. plywood and assembled with flat-head

screws. These should be countersunk carefully and puttied over. The chair looks nice with the elephants finished in light gray and the blankets painted on with a darker gray and bordered with brilliant orange.

Gate-Leg Table Saves Space in Child's Room

The space-saving possibilities of a gate-leg table led a father to make one for his young daughter's room. The room being small, it was necessary to conserve as much space as possible, yet have a table, around which she could seat her friends for tea parties and games. The table shown was found to be the answer to the problem. The table was made of plywood and assembled with screws, brads and hinges, as indicated. Four discarded play blocks were used for the feet. Shelves provide space for dishes, toys and books. Half-round molding was glued to the edges of the top to finish it off.

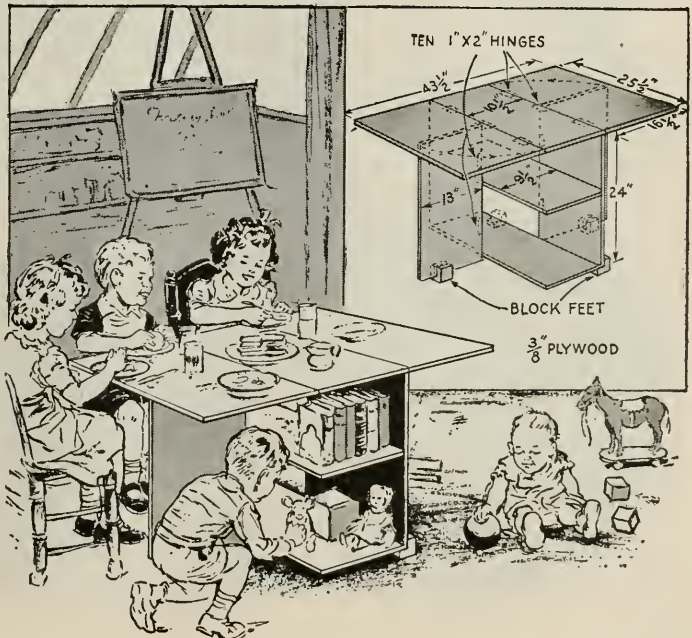

New HOUSE NUMBERS

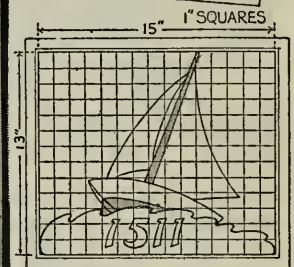
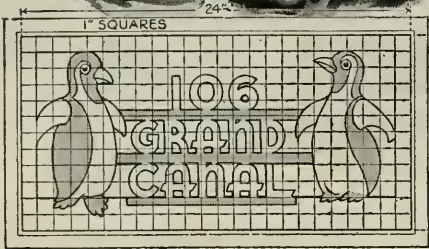
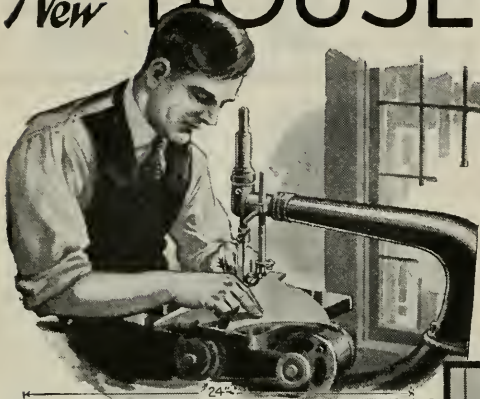

SCROLL-SAWED FROM $\frac{1}{4}$ " PLYWOOD

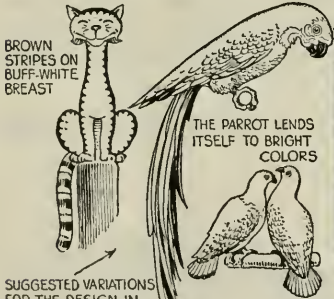

SUGGESTED VARIATIONS FOR THE DESIGN IN PHOTO BELOW

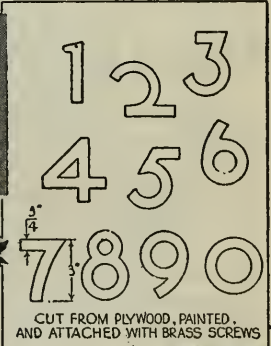
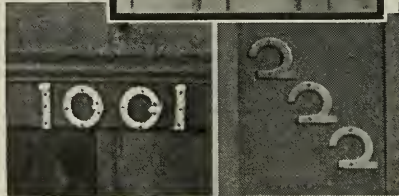

SPELLED-OUT NUMBERS ARE ATTRACTIVE

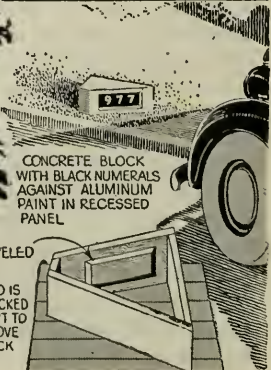

Jig-Sawed LAWN ORNAMENTS



MAKING things with a jigsaw is not only a fascinating hobby, but also a good way to turn your spare time into profits, as the experience of thousands of persons all over the country proves. While it is true that it is impossible for the craftsman to compete with mass production methods on a price basis, there still is a place, and a quick sale, for attractive novelties which it would not pay a big factory to touch. Often such articles can be sold to friends and neighbors, or orders may be taken from samples from department stores, gift shops and specialty dealers. In such cases the price asked should be at least double the cost of production. Lawn ornaments, house numbers, door stops, necktie holders and bird houses are all in demand. Orders also may be taken for toys, in the design of which the craftsman can exercise his ingenuity and skill.

Arranged in an effective display around any roadside stand, these colorful lawn ornaments will attract passing motorists and bring in a substantial revenue. One class of figures, primarily for use on the lawn, includes the alert bulldog and the warning policeman to replace the usual "Keep-Off-the-Grass" signs. The sprinkling maid is a popular item as well as the miniature fireman who can hold the nozzle

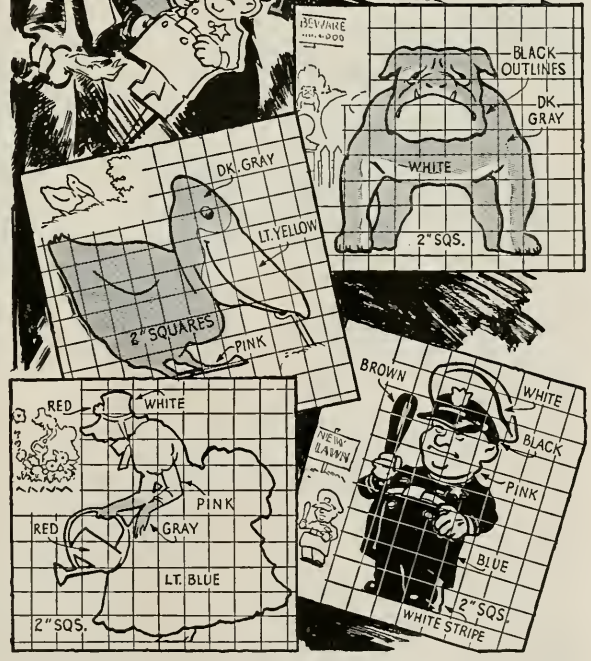

of a garden hose. Another class of ornaments are those like the climbing squirrel, the hanging monkey and the woodpecker, to be used on trees, while a black cat makes a novel silhouette on the ridge of a garage roof, and a taciturn owl watches doings in the garden from a fence post. For those who like small lawn tables to hold books, cigarettes or even for serving tea, the penguin stand has a pointed stake which is

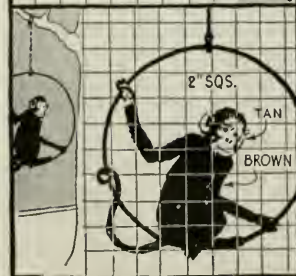
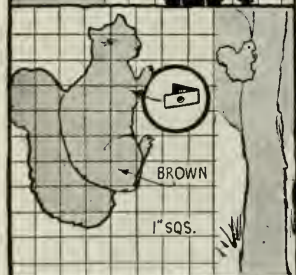
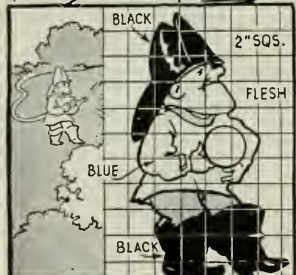
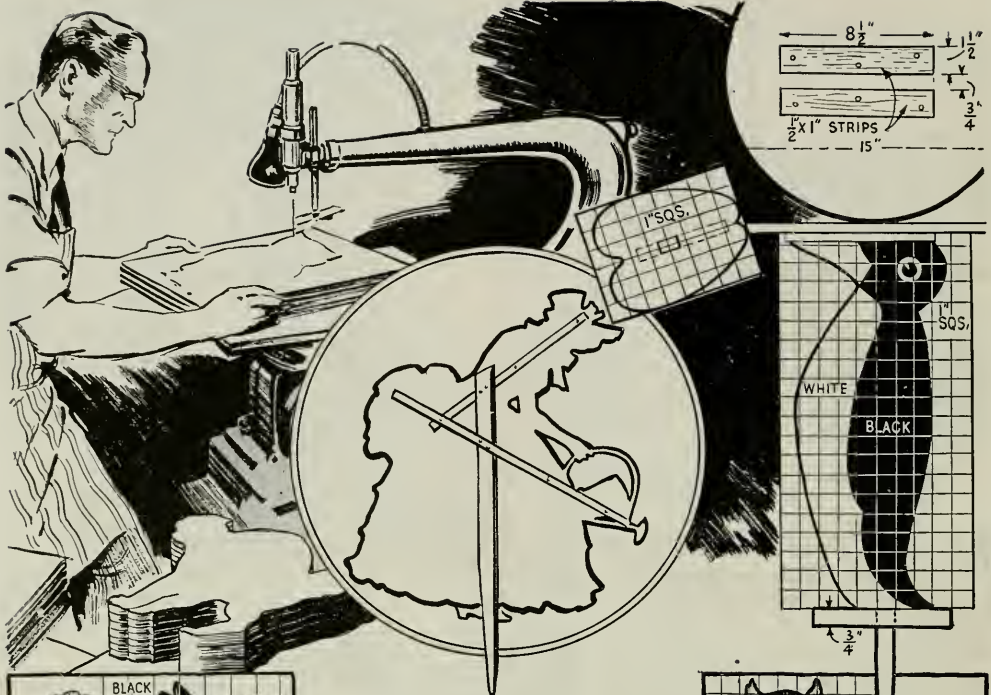

pushed into the ground. Use 1/4-in. stock. Plywood is good material if the edges are thoroughly filled with white-lead paste before finishing, to prevent water absorption. Hard-pressed fiber board may also be adaptable. You can cut out several duplicate figures at the same time by stacking the stock. Where designs have slender parts, likely to break off, use reinforcing strips on the back.

In finishing, apply a base coat of white and over this the finish coat of colors. If you have a paint-spray gun, similar figures can be uniformly finished and decorated in record time by the use of sheet-metal masks to block off portions of the background in colors other than the one you are applying. Some of the figures, of course, will require the use of a striping brush to outline various features.

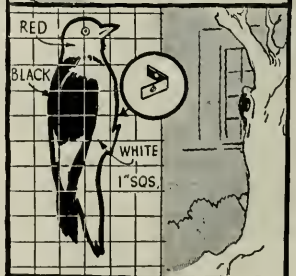
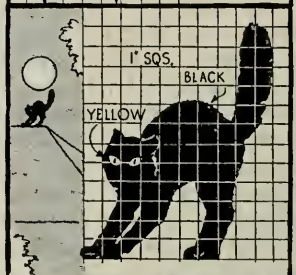
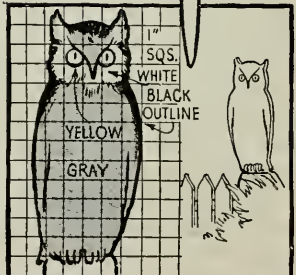

These WOODEN DOGS

carry parkway numbers

SET in a parkway, on your lawn or at the curb, the Scottie-dog cutout at the right, with its sparkling eyes, jauntily poses your house number in plain view. The cutout can be sawed to represent any animal or pet if those given below do not suit. Cut it from 1½-in. selected white pine and paint in appropriate colors. Reflector-type bolts used for car licenses serve as eyes and reflect the light from passing cars. The numbers are sawed from ¼-in. white pine and bradded to each side of the cutout.

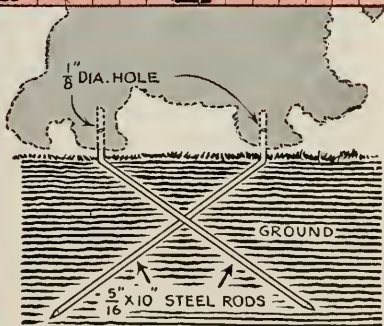
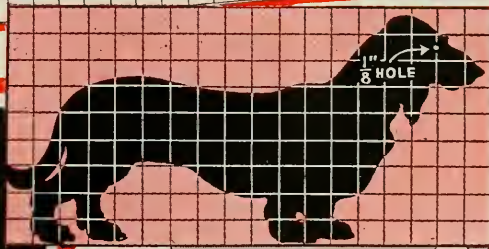
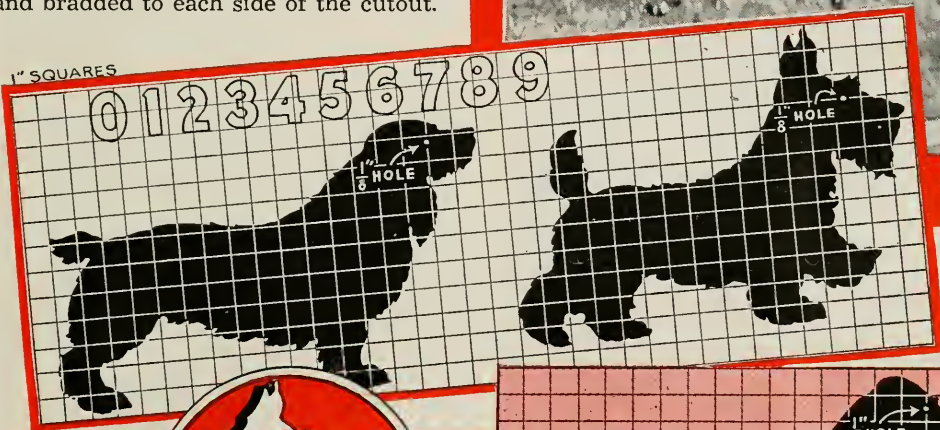

There is little possibility of theft if you mount the cutout on rods driven deeply into the ground as above. Drive screws into the side of the feet to fit into holes near the rod ends and then file the heads so that they cannot be removed with a screwdriver

Chained Dog on Pie Tin Forms Novel Sundial

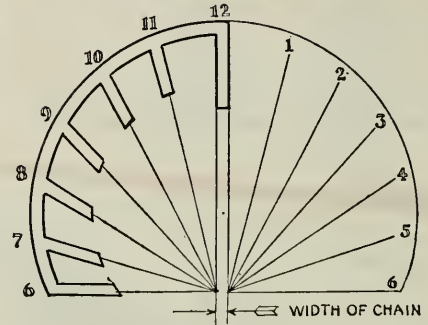
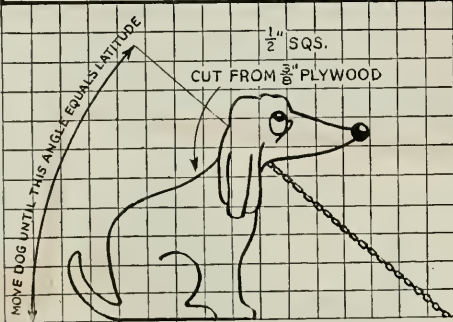
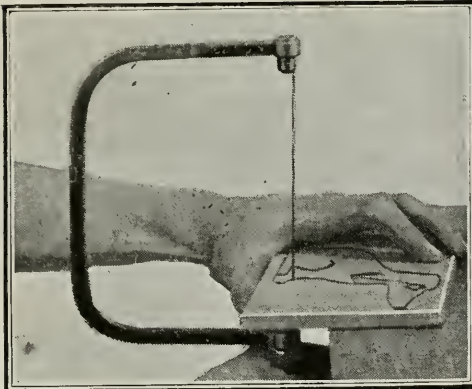

In this simple sundial, a scrollsawed dog is screwed to a large pie tin. A taut chain extends from the dog's neck to the pan, as shown, at an angle equal to the latitude of your home. This angle need not be exact; within a degree or two is close enough. You can find the latitude by looking at a map. Set the assembly in a sunny place so

that the pan is level and the dog's tail points exactly north. Using your watch as a guide, mark off the hour lines. All you have to do is mark the hours from one to five as seven to eleven are in the same relative positions on the opposite side of the chain, and twelve and six are always the same regardless of the latitude.

Novel Weather Vane

A Wisconsin tinsmith is responsible for this novel weather vane, which points in the opposite direction from which the wind is blowing. At the same time, the degrees that the wind flexes the standard give a rough indication of the velocity of the air current. The vane is a double arrow, cut from light tin and soldered to a length of medium-gauge spring wire. The lower end of the wire is anchored permanently in a length of $\frac{1}{4}$ -in. pipe, which is split at one

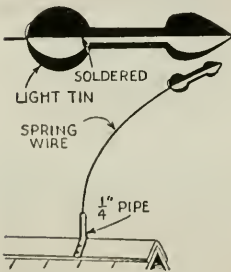

end and spread to fit over the roof gable. The tin arrows are painted in contrasting colors to make the vane easy to see.

Realistic Wings for Bird Cutout

This metal cutout of a bird has been given a realistic appearance by adding metal wings. These are soldered to each side of the bird, and are spread slightly to simulate the action of a live bird on a hot day. Proper coloring and shading add much to the effect.

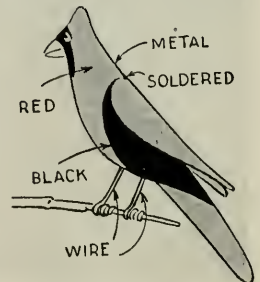

Animated WEATHER VANES that sell

Santa is off with the wind, while farmer Hawkins tries vainly to round up his frisky calf—that's the lifelike action provided by these two amusing weather vanes. The figures may be cut of either thin waterproof plywood, or sheet metal. Leaping action of the reindeer is produced realistically by two off-centered disks pinned to the propeller shaft in a reversed position to give an alternate upward motion to each animal. Movement of the figures shown below is provided by a rubber-covered pulley fitted to the propeller shaft to bear near the outer edge of a rotating disk, to which the figures are attached as indicated

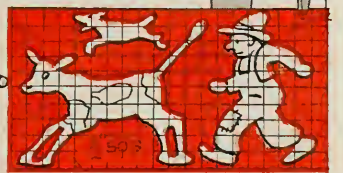
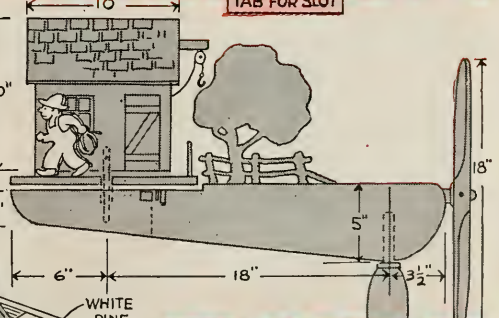
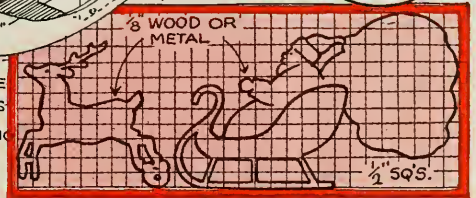
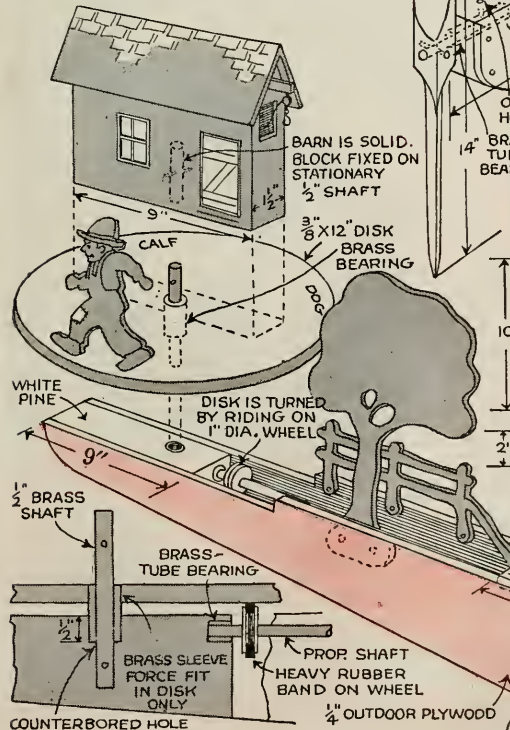
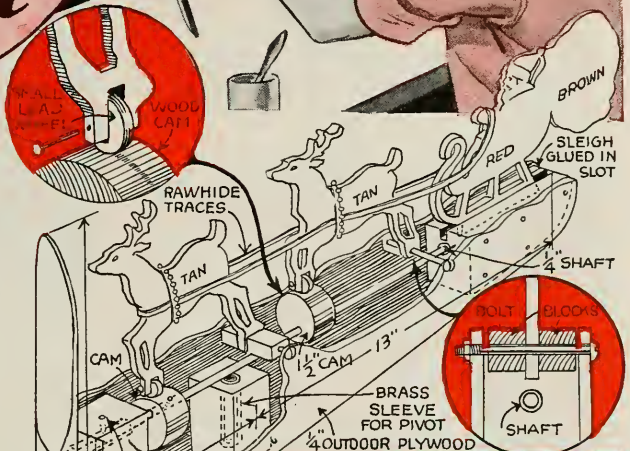
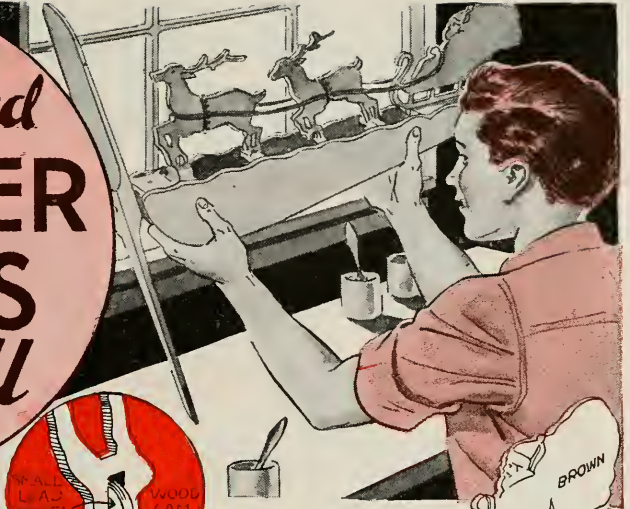

A Colonial Touch on the LAWN CHAIR

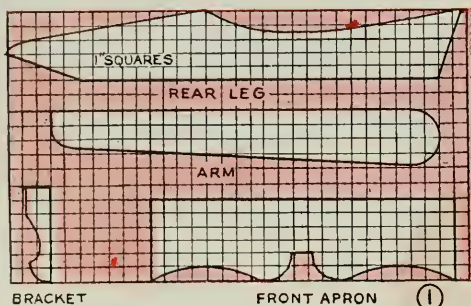

SCROLLWORK on the apron and back of this chair provides the touch necessary to make it fit in well with your colonial-type home. The chair can be made of white pine, although cypress is better due to its resistance to weather. Fig. 1 gives the sizes and shapes of the major parts, while Fig. 2 shows the layout for the decorative scroll on the back. Assembly of the chair is given in Fig. 3. The back is built as a separate unit and is screwed to the arms and legs, which are first assembled in two units and then tied together with the scrolled apron. If care is taken to assemble the back at the angle given, the chair will be comfortable for most users. After sanding, shellac all knots and apply one priming coat and two finish coats of flat white paint.

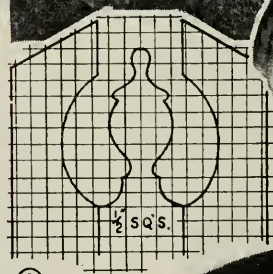

②

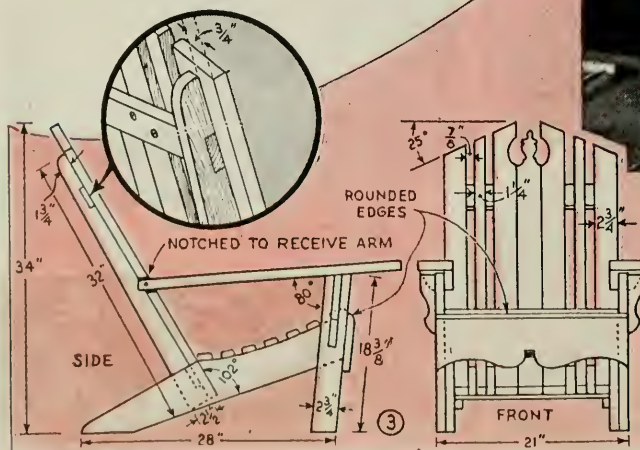
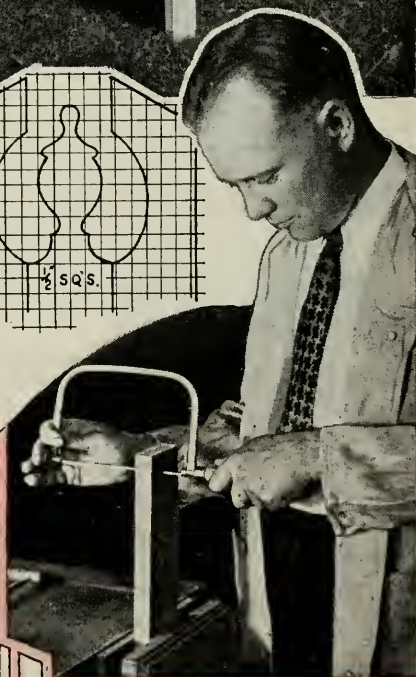

MATERIAL LIST

All dimensions net

- 2 pcs. $\frac{3}{4}$ x $2\frac{1}{2}$ x 33 in.—Back
- 2 pcs. $\frac{3}{4}$ x $1\frac{1}{4}$ x 34 in.—Back
- 3 pcs. $\frac{3}{4}$ x $2\frac{3}{4}$ x 34 in.—Back
- 2 pcs. $\frac{3}{4}$ x $2\frac{3}{4}$ x 18 in.—Back cleats
- 2 pcs. $\frac{3}{4}$ x $2\frac{1}{2}$ x 32 in.—Back supports
- 2 pcs. $\frac{3}{4}$ x $2\frac{3}{4}$ x $18\frac{3}{8}$ in.—Front legs
- 2 pcs. $\frac{3}{4}$ x 5 x $31\frac{1}{2}$ in.—Rear legs
- 2 pcs. $\frac{3}{4}$ x $3\frac{3}{4}$ x 27 in.—Arms
- 1 pc. $\frac{3}{4}$ x 6 x 21 in.—Front apron
- 1 pc. $\frac{3}{4}$ x $1\frac{1}{4}$ x 14 in.—Arm brackets
- 7 pcs. $\frac{3}{4}$ x $1\frac{1}{4}$ x $19\frac{1}{2}$ in.—Seat slats

"Figure" CROQUET WICKETS

of sheet metal are easily seen



Soldered to your croquet wickets, these gaily colored figures not only add a touch of novelty to your court, but they also make it easy to see the wickets, especially if you are playing in the evening when the light is poor. While only five figures are given here, they will help suggest others, such as a policeman posed as though directing traffic, a hitch hiker with his thumb motioning for a ride, etc. It is best to use sheet metal of a fairly heavy gauge so that the figures will not be bent out of shape if you brush against them while playing. Also round all pointed corners and be sure there are no rough edges left on the figures on which to tear your clothing

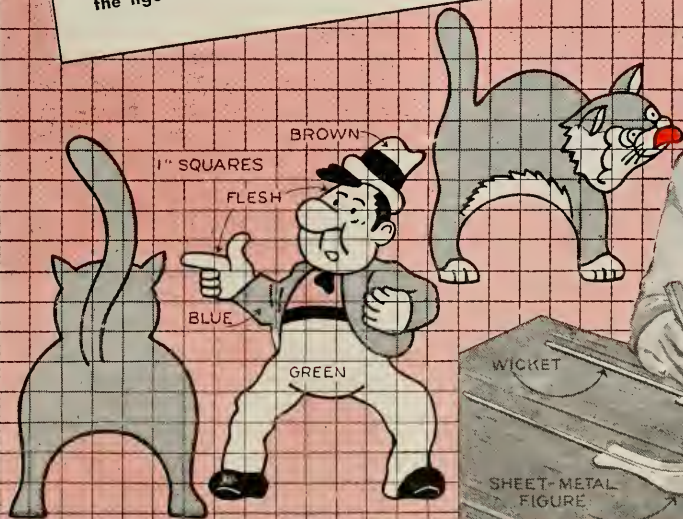
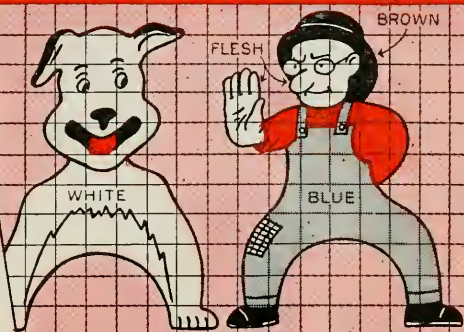

MINIATURE

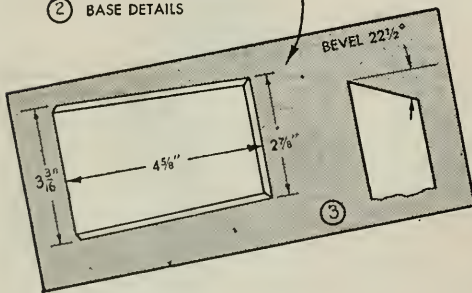
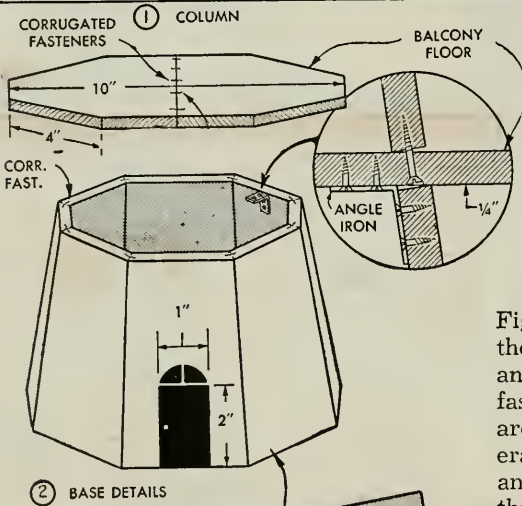
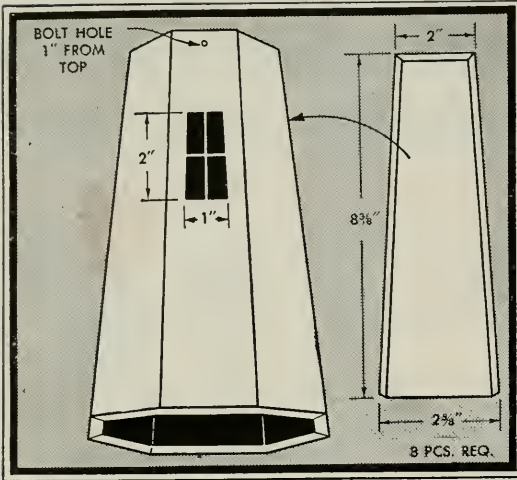

MATERIAL LIST

- 1 pc. $\frac{1}{2}$ x 3 x 72 in.—Column
- 1 pc. $\frac{1}{2}$ x 4 x 42 in.—Base
- 4 pcs. $\frac{3}{16}$ x $\frac{5}{16}$ x 8 in.—Arms
- 12 pcs. $\frac{1}{16}$ x $\frac{5}{16}$ x 6 in.—Sail Blades
- 1 pc. $\frac{1}{4}$ x 10 x 18 in. plywood—Floor, misc.
- 1 pc. $\frac{1}{4}$ x 20 in.—Quarter-round
- 1 pc. $\frac{1}{4}$ x $\frac{3}{8}$ x 36 in.—Rail
- 8 pcs. $\frac{1}{4}$ x $\frac{3}{8}$ x 12 in.—Rail Posts
- 1 $\frac{3}{16}$ x 4-in. carriage bolt (2 nuts)
- 1 doz. $\frac{1}{4}$ x $\frac{1}{4}$ -in. angle-iron brackets
- 4 1/2 doz. $\frac{3}{4}$ -in. No. 5 flat-head wood screws

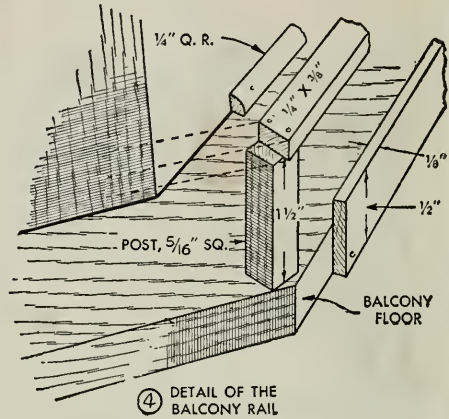

IN BUILDING this miniature Dutch Windmill, which is just the thing to dress up a small rock garden, it's best to use white pine. This works easily and is available at any lumber yard.

Building of the mill starts with the base; the parts of which are detailed in Figs. 2 and 3. In sawing, be careful to get the beveled edges exact and the lengths and widths right. To hold the parts while fastening the joints, loop a stout cord around the top of the segments, cut it several inches shorter than the measurement and then tie in a short coil spring. Force this improvised "clamp" down over the top of the set-up segments, after coating the beveled edges with waterproof casein glue. Anchor the segments by driving corrugated fasteners across the joints. Follow the same procedure in making the top column, Fig. 1.

The balcony floor is cut from a piece of $\frac{1}{4}$ -in. plywood or by joining two pieces of stock with corrugated fasteners, and is screwed to the top column.

The roof is formed from a small wooden chopping bowl or by turning a piece on a wood lathe to the approximate shape indicated. If a bowl is used, it is covered with $\frac{1}{4}$ -in. plywood and fastened in place with wire brads. Small cleats screwed to the cover provide holding blocks for screws driven through holes drilled near the top of the column. Make and fit the roof for trial assembly but do not attach it permanently until the rest of the mill is completed.

Next comes the fitting of the quarter

DUTCH WINDMILL

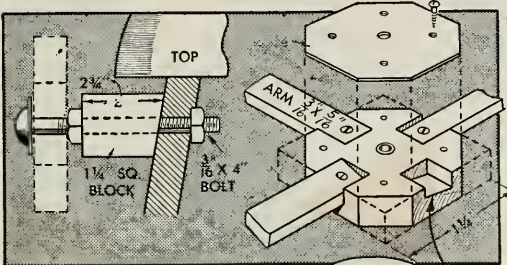
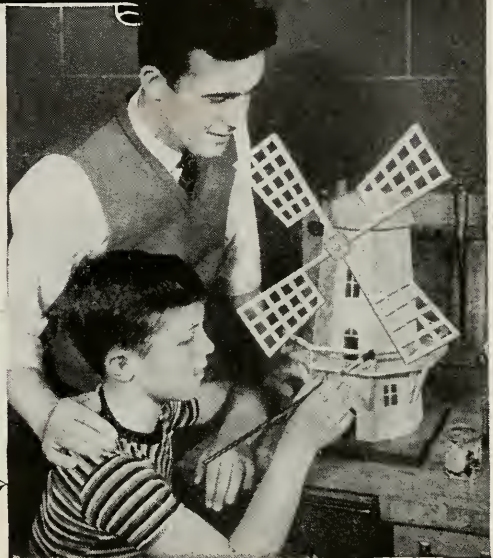
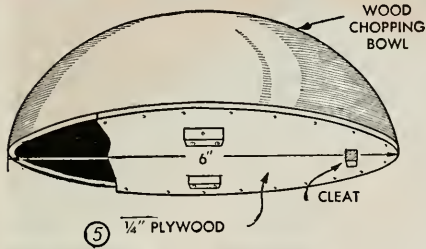

6 HUB AND BEARING DETAILS

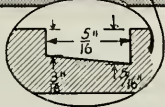

round to the joint where the upper column meets the balcony floor, and the cutting and assembling of the balcony rail, Fig. 4. Cut the parts to the approximate size required then file and sand as required to make them fit. Assemble with glue and wire brads.

The sail consists of four identical blades. Construction is simply a matter of ripping out duplicate parts as dimensioned in Fig. 7 and assembling with glue and tiny wire brads. The hub assembly is shown in Fig. 6. The arm of each sail is fastened in a notch angled to give the proper pitch. In making the notches, cut the angle slightly less than indicated so that you can trim if necessary to get all four sail blades the same angle. Bolt the hub in place with the sail attached, as shown in Fig. 6. Fasten on the roof and baseboard and you're ready for the paint job. First, give the entire surface a coat of spar varnish. Allow this to dry thoroughly then follow with two coats of paint. You can use the color scheme suggested in Fig. 7, or work out your own color scheme, if you prefer.

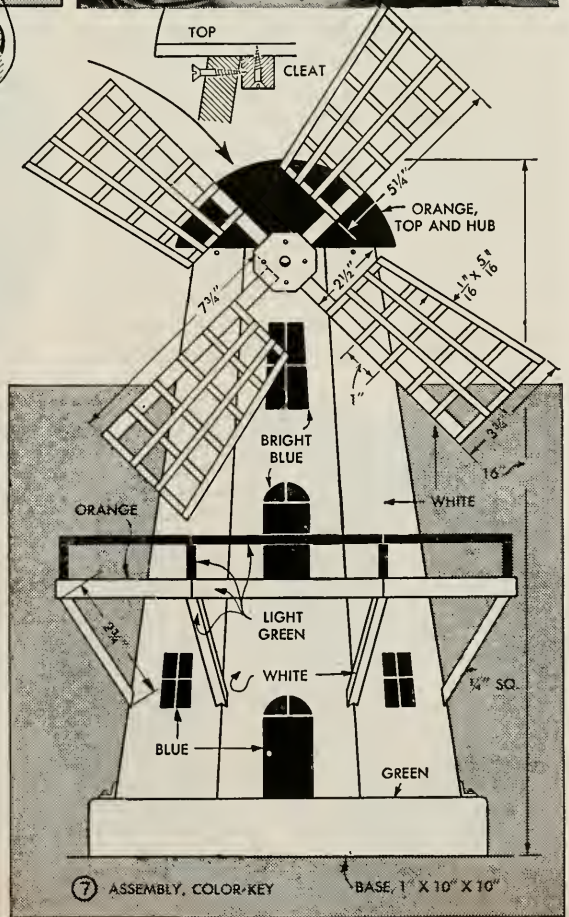

7 ASSEMBLY, COLOR-KEY

BASE, 1" X 10" X 10"

SCULPTURING *in* WOOD

simplified for beginners



WHITTLING caricatures in wood with a jackknife is a fascinating hobby that costs practically nothing and it may be a source of worth-while revenue, as small hand-carved pieces, especially of characterized animals, have become a popular fancy. Fig. 1 shows seven poses of a little stallion, which were carved from softwood. You can use white pine, sugar pine or basswood, or, if desired you can practice by carving in soap. To reproduce these poses in wood, first make full-size paper patterns of the front and profile views shown in the squared drawings in

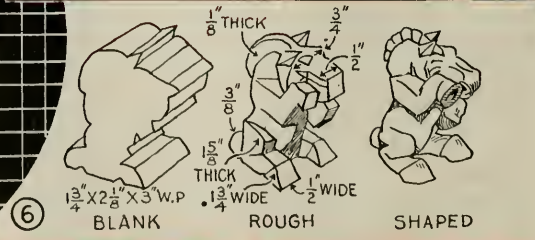
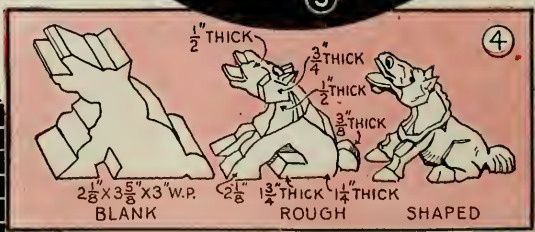
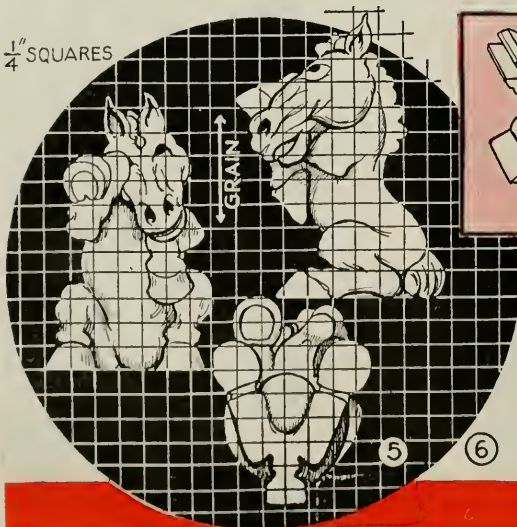

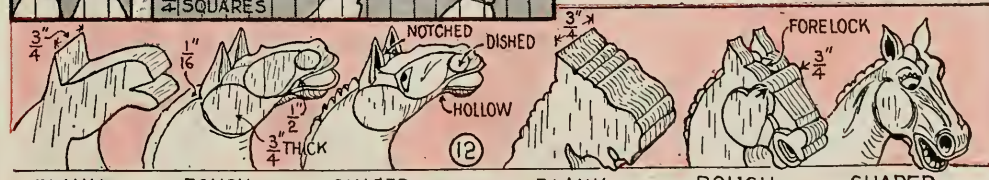
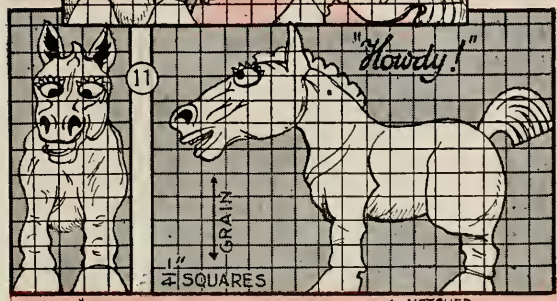
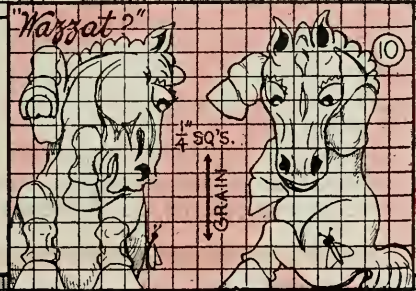
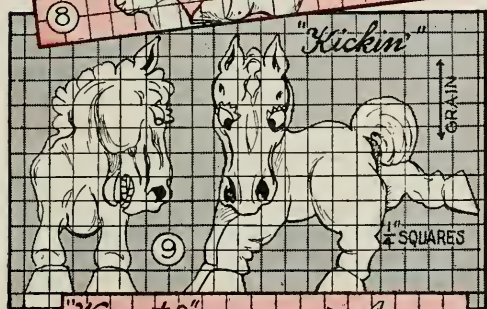
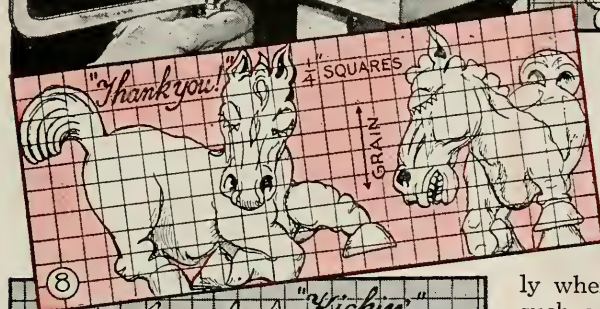
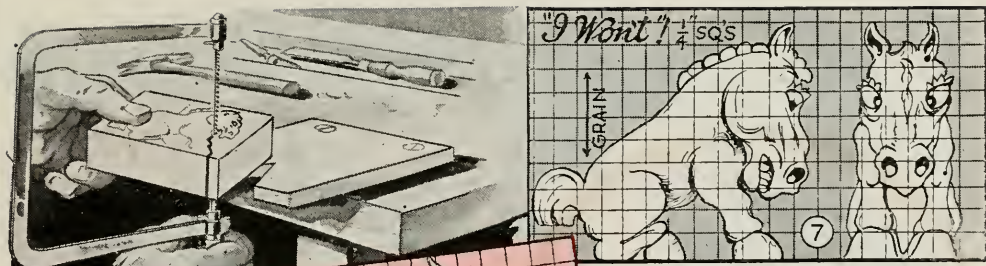

Figs. 2, 5 and 7 to 11 inclusive. Then using carbon paper, trace each pattern on respective, adjacent faces of a squared block of wood. Place the pattern to correspond with the direction of the grain indicated in each pattern. This is important especially when carving in wood, as small parts such as the ears are otherwise likely to break off before the carving is completed. For this reason it is best to carve the ears last. The approximate shape of the horse is obtained by first sawing out the rough blank. This can be jigsawed or cut by hand, using a coping saw as shown at the top of the page. Here you will find that a V-notched board, screwed to the top of a bench to allow it to overhang the edge, will be helpful in supporting the work while sawing. Saw the profile first, then temporarily tack the waste pieces back on the block to provide a flat surface, and saw out the front view. Figs. 4 and 6 show two poses in blank, rough and finished form, with dimensions for thickness at various points. If made of wood, the figure looks best when carved rather roughly as in Fig. 3, while a smoother finish is more desirable on soap or plastics. For the beginner, Fig. 12 suggests a simplified head which is less difficult to carve than the one shown for the advanced whittler. You can finish your model with either stain or paint, applying a darker color to the hoofs, mane, tail and nostrils to give contrast to a light body.

BLANK ROUGH SHAPED BLANK ROUGH SHAPED
SIMPLE HEAD ELABORATE HEAD

Carving "JUMBO" with

By E. J. Tangerman



"Jumbo on the tub" is simulated in a paperweight by mounting the carved elephant on the top part of an auto piston that has been cut off and polished

JUMBO the circus elephant is simple to whittle no matter what pose you choose. And you can use him in dozens of ways. Figs. 1 and 3 show him mounted on modern metal bases for paperweights, while Fig. 7 gives a third pose in which he serves as a simple knickknack on a desk or corner shelf. Other uses are a decoration for a cigarette box or a blotter handle, a letter opener, etc. His blocky shape requires only a little finishing—the rougher you leave him the more natural he looks. For a carving blank, pick a straight-grained, knotless piece of white pine or basswood, planed to about $\frac{3}{4}$ in. thick. You can make him fatter if you like, using a block 1 or $1\frac{1}{8}$ in. thick. On one side draw $\frac{1}{4}$ -in. squares, then copy the pose you want, three of which are shown in Figs. 1, 3 and 7. Other poses are suggested in Fig. 6. Be careful to draw the elephant so that the grain runs the long way of the trunk and tail, otherwise they are likely to split or break off during carving. The details in Fig. 2 are for a vertical pose, while those in Fig. 4 are for a horizontal one. Fig. 8 shows the head carving, which is more or less common to any pose.

To begin carving, cut out the blank with your penknife. Avoid making any edge a continuous curved line; it looks better as a

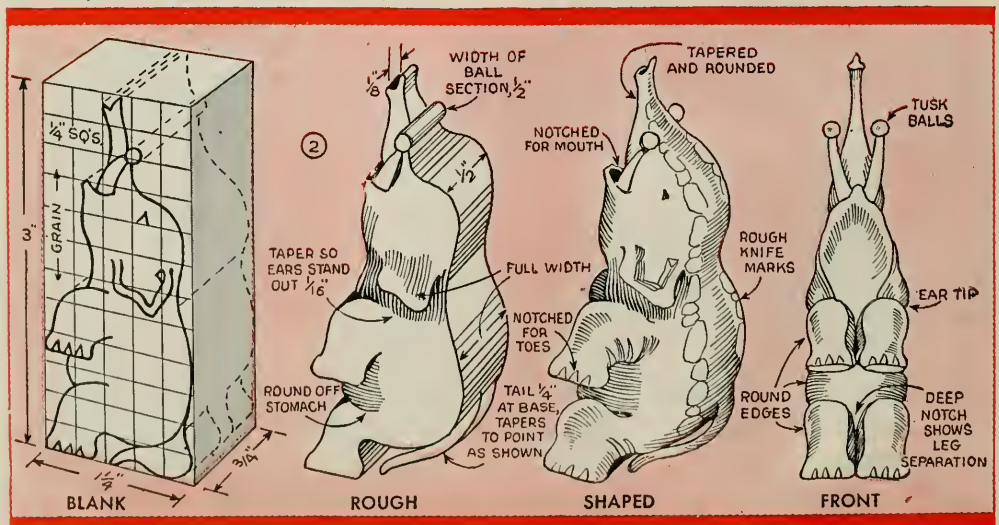

a Jackknife

series of broken planes, just as your rough knife cuts would leave it. Cut a V-notch between the legs in front and back, and extend V-cuts up between the legs and body, Fig. 5. Thin down the tail and round it up. Cut a deep notch behind the head on each side. Now all that remains is the face. Outline the back of the ears with a straight-in cut about $\frac{1}{16}$ in. deep, then cut in diagonally from the body to remove a V-shaped chip. Follow this with a shallow V-notch to represent the ear itself, another V-notch and a shallow shaving inside the lobe to outline it. Mark the tusk position, then thin down the trunk, making certain that the outer surfaces are in line above and below. Accent the mouth opening, and round up the tusks, shaping the balls at their ends. Then carefully round up the head and trunk. If you are unfortunate and break off a tusk, cut both off and have a tuskless elephant. Remember to shape the little "finger" at the end of Jumbo's trunk, so he can pick up peanuts. The line of his lower lip marks the butt end of his tusks. Locate the eyes and cut in little pyramids to form them. Now cut a series of V-notches around each foot to simulate toes, and also behind any bent joints, under the jaw, etc.

To get a grayish-black elephant color, mix equal parts of brown, black and white oil paints to get a blue or brown-gray. Thin it a little more than usual, and daub it on liberally. When all areas are covered, wipe off the surplus paint with a cloth. This will give Jumbo a soft finish, with a little shine to accent the creases of his hide. Touch up the inside of his mouth, the tip of his trunk, his toes and his eyes with pink (red and white mixed). Paint his tusks white, with gilt balls. If you want a fabled white elephant, paint him a dirty, light gray all over—no elephant is pure white unless whitewashed. You can also carve a little palanquin and a mahout if you wish to put Jumbo really on parade. These can be glued on. In that case, carve V-grooves to show a headcloth and a body-cloth. Then paint them in gay colors.

You can, of course, make such an elephant as elaborate as you wish—putting in



③

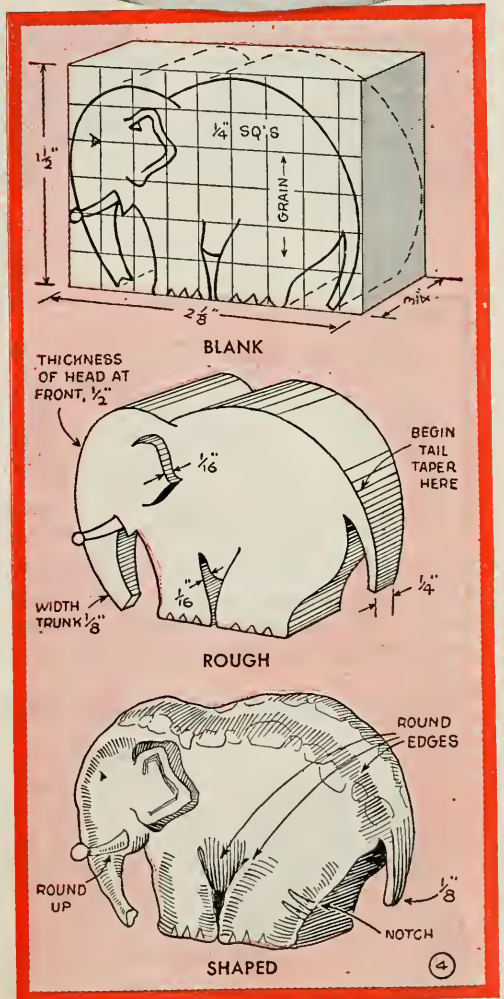

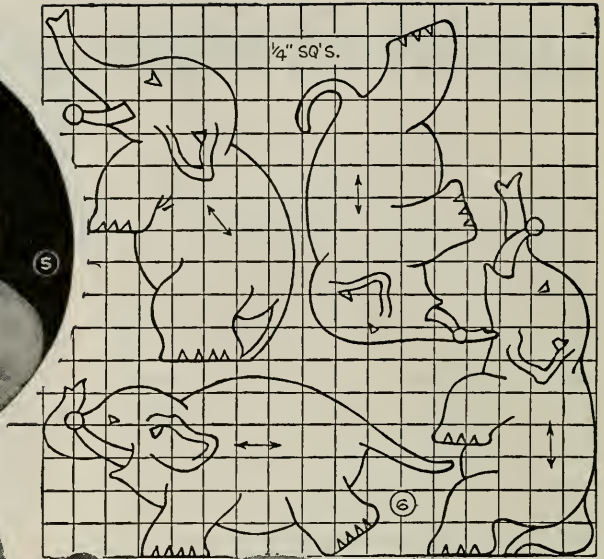
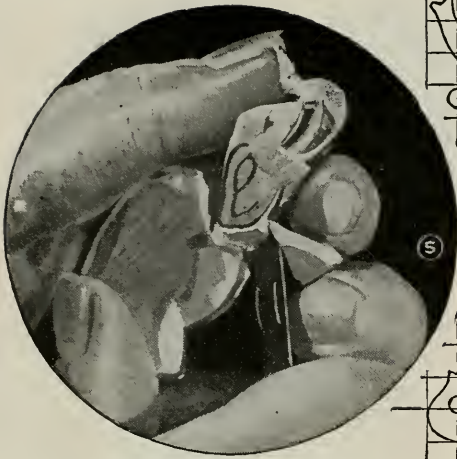

Use a sharp penknife for notching and grooving, and do not make any edge a continuous curved line. The figure looks better with all surfaces a series of broken planes just as left by the rough knife cuts

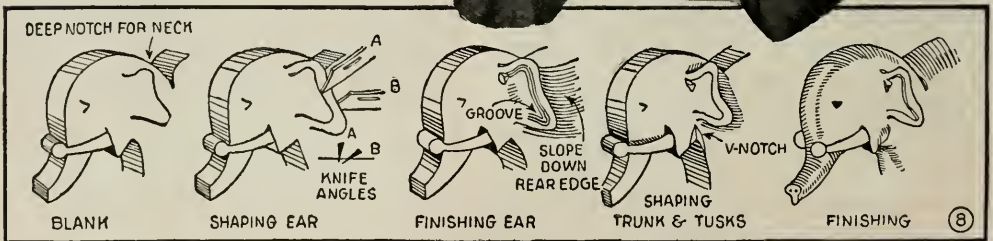

V-notches to simulate the creases in his hide. And you can use mahogany or walnut, and finish him by oiling and waxing. If you want him larger, use $\frac{3}{8}$ or $\frac{1}{2}$ -in.

squares. Or again, lay out the designs on $\frac{1}{8}$ or $\frac{1}{4}$ -in. wood and carve them as silhouettes for a wall frieze, picture-frame decoration, or wall panel.

Pocketknife Has Finger Shield for Carving and Whittling



When using a pocketknife to carve or whittle wood, slip a small sponge-rubber ball over the blade, as indicated, on which to rest the tip of your index finger. You'll find that this keeps the blunt edge of the blade from "cutting" into the finger, which is rather painful when the knife is used for long periods. Once a slot is made in the ball it slips on or off easily.

Small chisels for use in wood carving can be had by grinding ice picks to shape, taking care not to burn them.

Small HAND LOOM delights the youngsters

Doll-house rugs, pot holders and dish pads of embroidery thread, yarn or ordinary cotton string, are but a few of the many practical items that one can weave on this simple hand loom. White pine is suitable for the frame, but the "heddle" cylinder, which raises the warps alternately by merely reversing the position of the handle with each pass of the shuttle, should be made from a maple or birch dowel. The cylinder, slotted as detailed below, is made to pivot in slots cut in the rabbeted edge of the frame, and grooves cut lengthwise in the dowel, in which the edge of the shuttle may be held, serve to guide it easily between the warps. The frame is strung with heavy shoemakers' thread by securing the end around pins at one corner and then spreading it in corresponding slots in the end rails and cylinder. Dowel pins inserted upright in holes drilled equidistantly apart in strips fitted along the inside of the frame, serve to keep the work uniform in width and are advanced as the weaving progresses. For the shuttle bobbin, a common metal film spool will serve

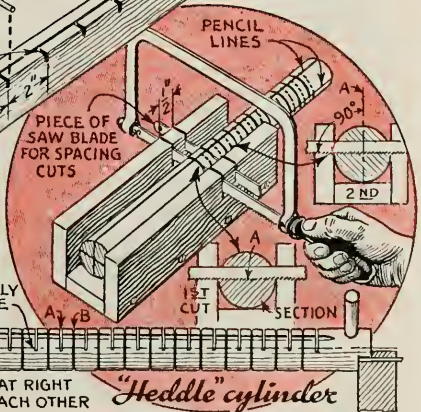
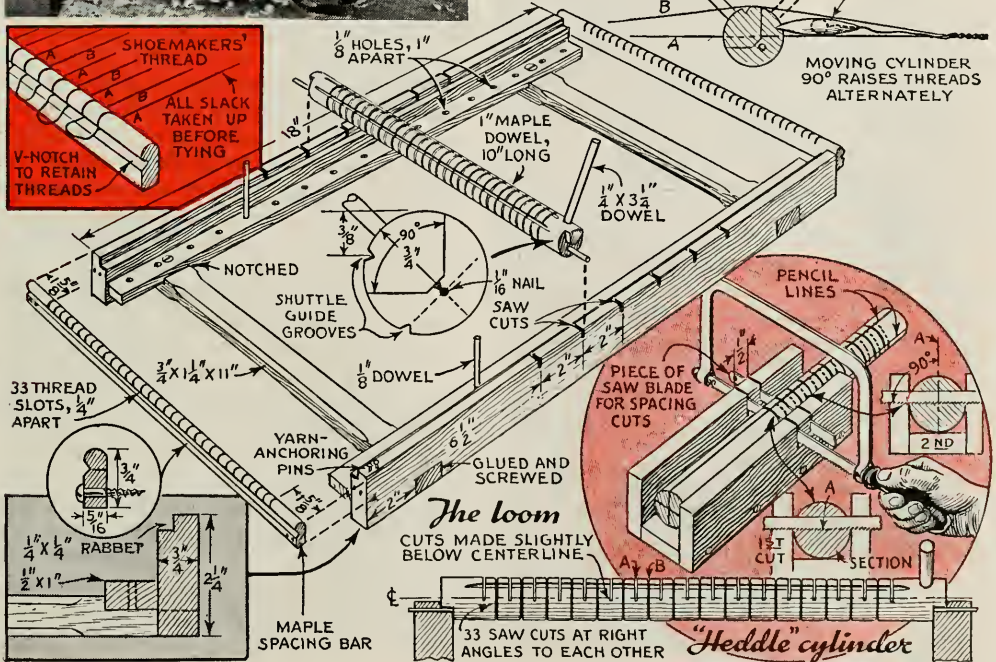
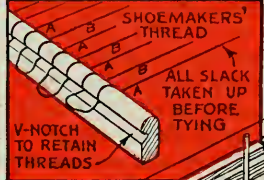
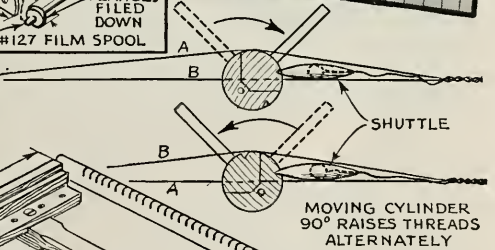
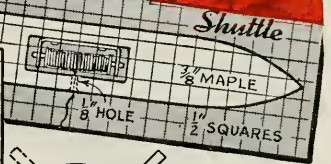
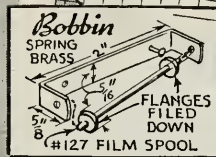



①

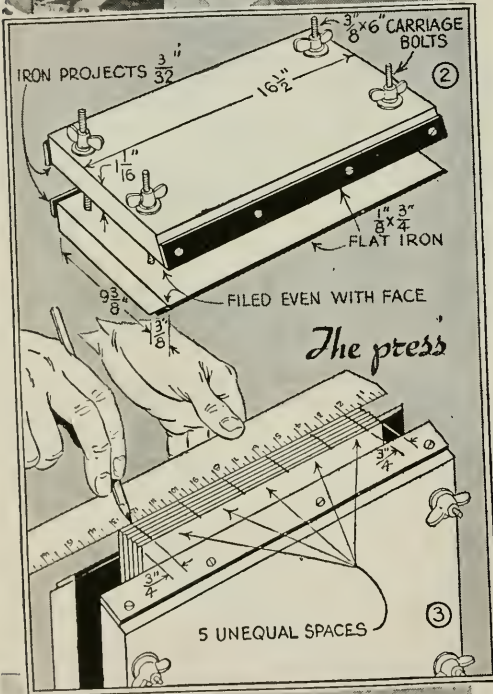

③

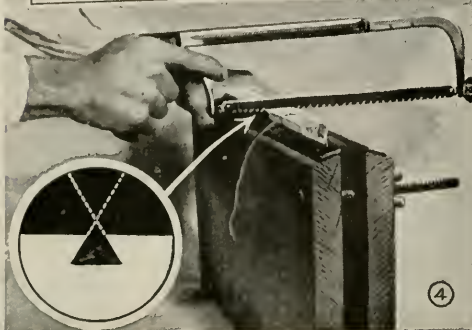

④

TORN, worn and faded volumes that detract greatly from the neat appearance of your library can be given new covers beyond their original appearance when new. Such rebinding can be done at home by anyone. Also, when an accumulating stack of old magazines becomes a problem, why not separate the portions of them you wish to save and bind these together in yearly volumes?

Only a few simple pieces of equipment are required, namely: a press, sewing table and trimming board which are detailed in Figs. 2, 6 and 15. To bind magazines, begin by tearing off the covers and pulling out the staples as in Fig. 1. Separate the sections, being careful not to tear the backs, especially if glued. Align the edges by "jogging" the sections on the table until the back is flat and then clamp the stack in the press. Next mark lines across the back $\frac{3}{4}$ in. from the head and tail, as in Fig. 3, and divide the remaining distance into five spaces. With a fine-toothed saw make two end cuts to a depth of $\frac{1}{16}$ in. to provide openings for inserting the needle when sewing. The other marks are undercut as shown in the circular detail of Fig. 4, to imbed heavy cords. If tapes, available at dry-goods stores, are used instead of cords, all cuts are made $\frac{1}{16}$ in. deep, a cut being made on each side of each tape.

Now for sewing: Place the first section face downward on the bed of the sewing table. Using the saw marks as guides,

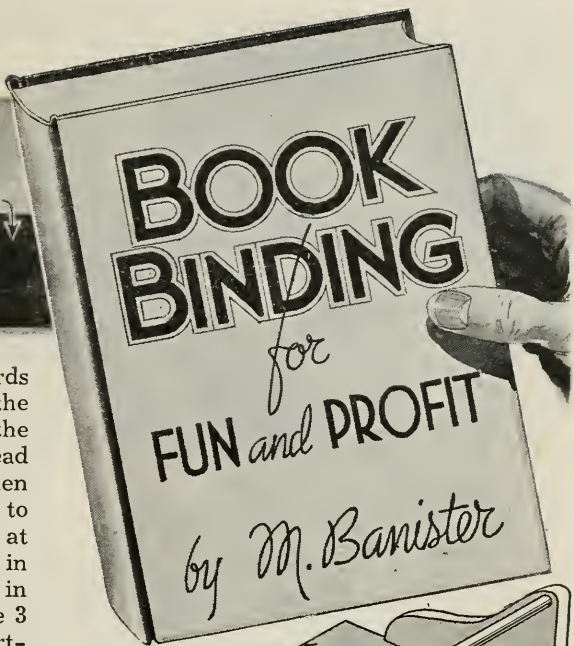
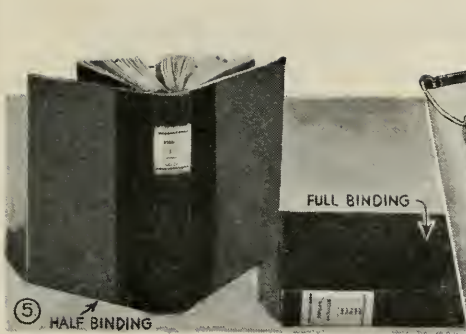

string the table with four vertical cords or tapes, fastening one end beneath the table with thumb tacks and tying the other end to the frame, Fig. 10. Thread a darning needle with No. 25 linen thread and begin sewing each section to the cords by holding the section open at the division and running the thread in and out around the cords as shown in the insert detail of Fig. No. 9. Leave 3 or 4 in. of thread extending at the starting hole. Then the second section is set in place and sewed from left to right with the same length of thread, after which the two ends are tied together. When the thread emerges at the left, or

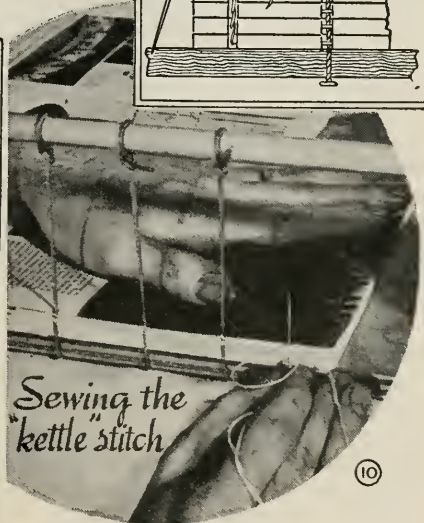
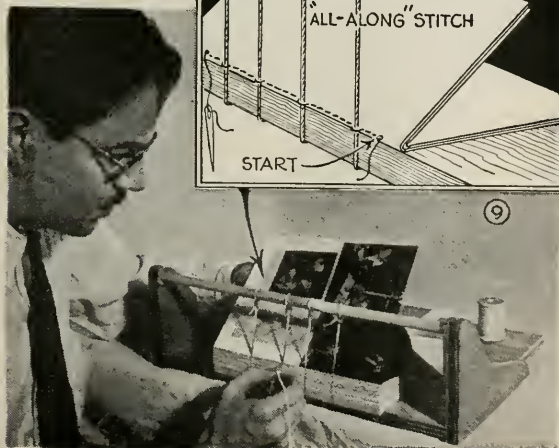
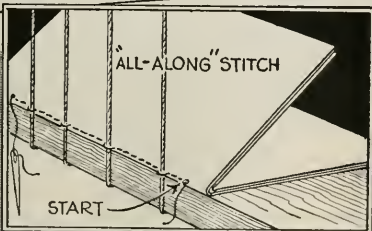
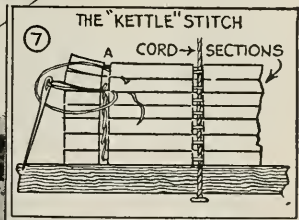
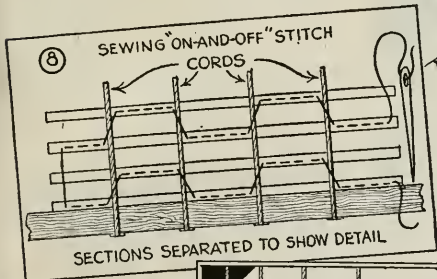
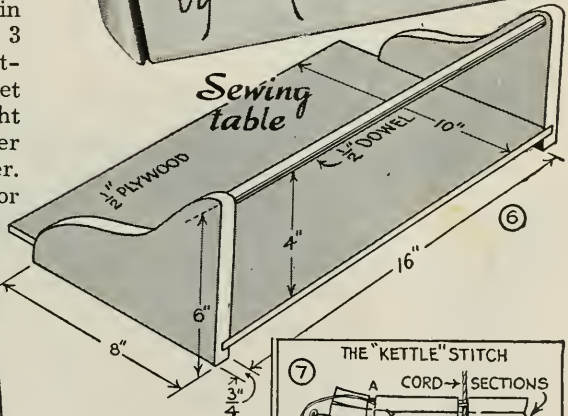

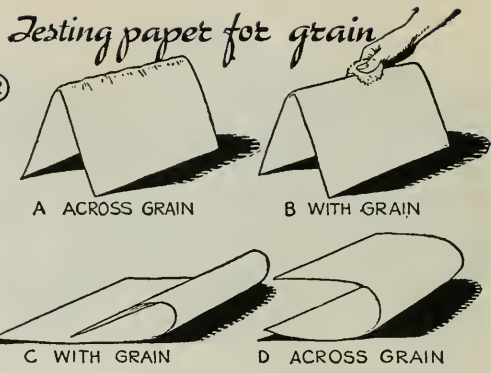
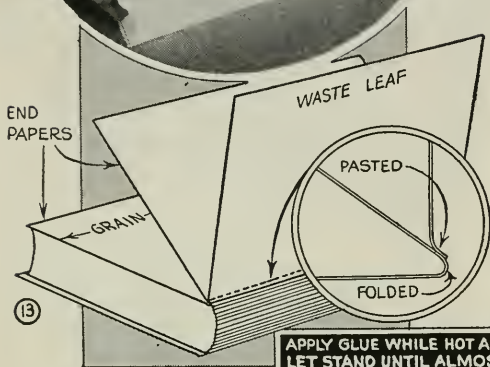

It is important that the grain of both end papers and cardboard run vertically. Fig. 12 shows how to determine this for folding the paper with the grain. The waste leaf is pasted to the outside of the folded end paper, Fig. 13. Open the book and fasten together each of the first and last three sections with a $\frac{1}{4}$ -in.-wide strip of paste down the back. Paste the end papers in the same manner and place under a heavy weight to dry for $\frac{1}{2}$ hr.

You can make your own paste by mixing powdered alum, $\frac{1}{2}$ oz., with flour, $\frac{1}{2}$ cup, adding enough water to make a thin paste. Stir to a

tail end of the third section, the "kettle" stitch is made, Figs. 7 and 10, to tie the three together. This is done by passing the needle behind the cord and again through the loop thus formed. The kettle stitch is made at the end of each section. Sew four sections using the "all along" stitch, Fig. 9, and then change to the "off-and-on" method, Fig. 8, for sewing the center sections of the book, finally reverting to the former stitch for sewing the last four sections. Use a square knot in joining a new length of thread so that the knot will come on the inside of the book. Where tapes are used, the threads passing across each tape are tied together by passing the needle vertically beneath them and knotting together. When the sewing is completed cut the vertical cords, hold the book firmly on the table with the back flat and strike heavy blows with a mallet along the back edge at the front and end to knock down the swelling and imbed the threads.

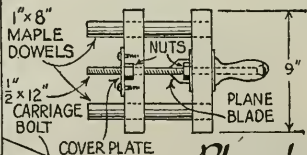
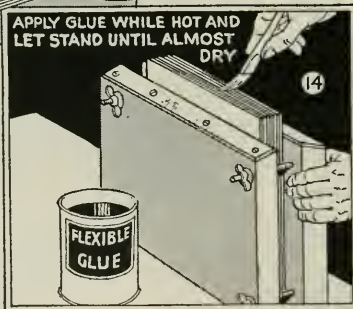

Plough

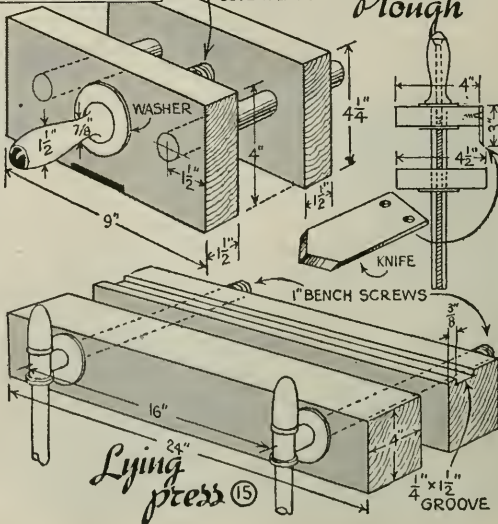

Lying press ⑤

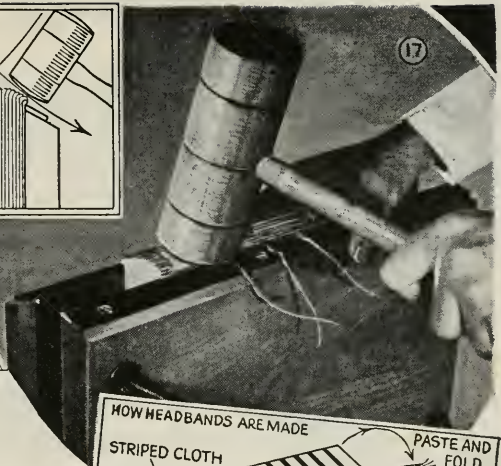
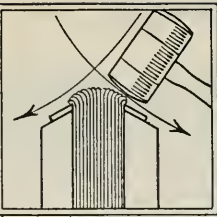
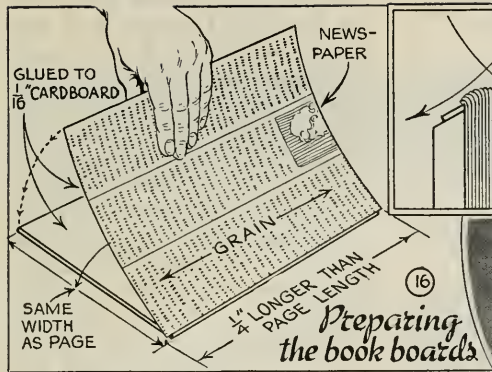

smooth consistency, add two cups of water and boil for five minutes, after which a few drops of oil of cloves are added before setting aside to cool.

Jog the book on the table to flatten the back and again clamp it in the press. Using thin "flexible" glue, which is made by adding glycerin, 1 tablespoonful, to dry glue, 4 oz., while cooking, coat the back of the book, working it in the sections well as in Fig. 14. When still tacky, the book is trimmed. Mark a straight line across the front waste leaf about $\frac{1}{8}$ in. from the head. Insert the book in the cutting press, placing it between heavy cardboards, Fig. 21, and line up the guide mark with the edge of the press. The paper is trimmed evenly by

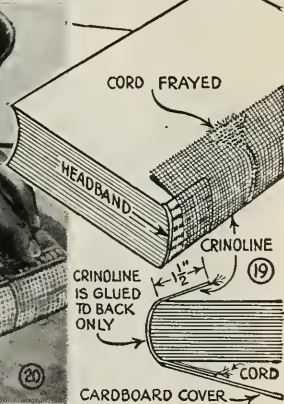
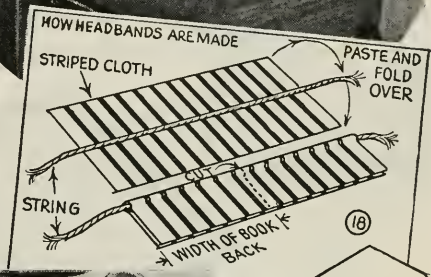

moving the plough back and forth as the feedscrew is gradually advanced with each forward thrust. Feed the knife slowly to prevent jamming and tearing the sections.

Cut the book boards from heavy cardboard to the size given in Fig. 16. Paste a piece of newspaper to one side of each and dry under a weight. The grain of both must run vertically. Rounding and backing the book is done by first pushing in the fore edge with the thumb at the same time a drawing force is exerted with the fingers, as in Fig. 11, and then striking the back with a mallet to form "ears" along each side as in Fig. 17. Headbands of striped cloth are made as in Fig. 18 and are glued to the back at the tail and head. Apply

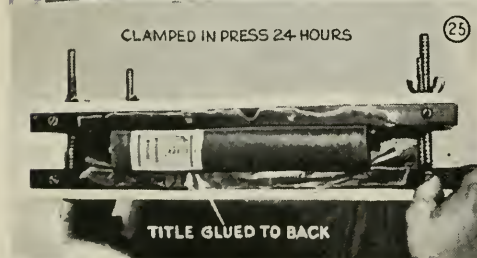
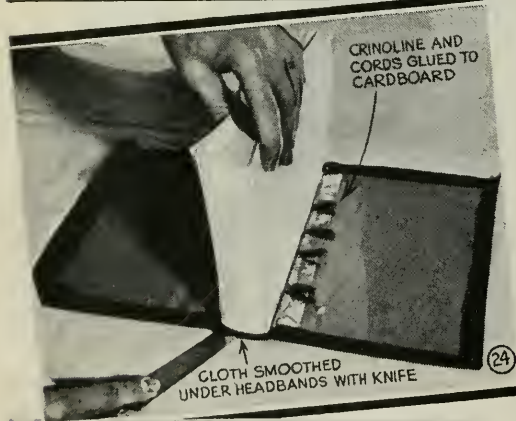
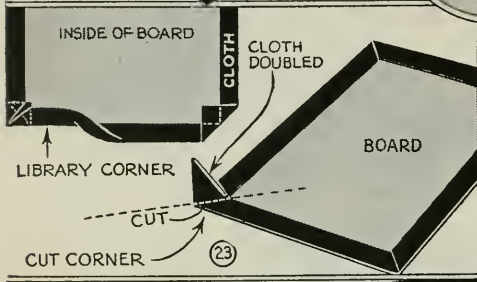
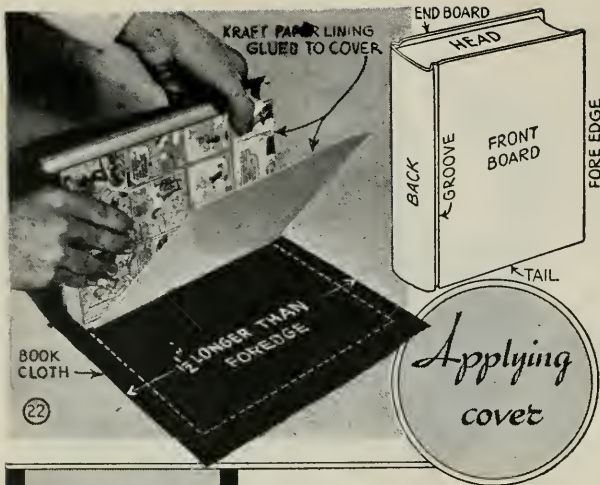

*Applying
cover*

"flexible" glue to the back and lay a piece of crinoline in the glue to overhang $1\frac{1}{2}$ in. on each side as shown in Fig. 19. Cut off the cords even with the crinoline backing and fray the ends. Several thicknesses of wax paper are placed over the front and back waste sheets and the frayed cords and crinoline are glued to the book covers as in Figs. 20 and 24. For this use plain glue which does not contain glycerin. The cover should project $\frac{1}{8}$ in. at the head and tail, leaving a groove $\frac{1}{8}$ in. wide along the back edge. Allow the book to dry thoroughly clamped in the press.

To cover the book, a piece of book cloth, which may be of buckram, paper or leather, is cut to reach completely around the book, allowing sufficient material for turning under. Make a mark down the center of the cloth on the inside and then, straddling this centerline, glue to the cloth a piece of kraft paper which is the same width and length of the book-back, including the headbands. A second piece of paper of the same width, but shorter, is glued to the back over the crinoline. Additional pieces of paper may be glued to both covers to serve as a lining as in Fig. 22. Glue the cover material first to the front board and then to the end board, and turn the cloth in over the edges of the cardboard as in Fig. 23. The sides and edges of the book are rubbed down with the rounded edge of a ruler, after which the book is covered with wax paper and clamped in the grooving end of the press where it is left for at least 12 hrs. After drying, excess cover material is trimmed away with a razor blade, leaving about $\frac{1}{2}$ in. margin around the edges. The waste leaf is then torn out and the end paper thus exposed is glued down. Wax paper is placed between the covers, and the book is once again placed in the press and clamped tightly, Fig. 25. Fig. 5 shows the completed book and an example of half binding. This process is similar as described, except that the back cover material is applied first. When dry, the material is trimmed down the sides evenly, being careful not to cut the cardboard too deeply, and completed by covering the remaining portion with cloth or paper.

The title, listing name, month and year, may be typed neatly on white or colored paper and glued to the back of the book as shown above, or if you prefer, it can be lettered by hand directly on the binding, using gold or silver paint applied with a pen or small brush and followed with a coat of clear shellac to keep the lettering from rubbing off

NEW USES *for* EMPTY SPOOLS



REWINDING SPOOL WHICH IS FORCED ON SHORT ROD AND HELD IN DRILL CHUCK



HALVES OF SPOOL AID IN HOLDING SMALL ROD OR TUBING IN VISE

SMALL SPOOLS DIPPED IN GLUE AND COATED WITH ABRASIVE CAN BE USED FOR SANDING DELICATE SCROLL WORK

SPOOL IS FORCED ON SHORT ROD

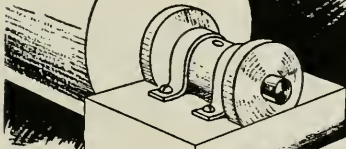

USED AS A BEARING FOR LIGHT SHAFTS

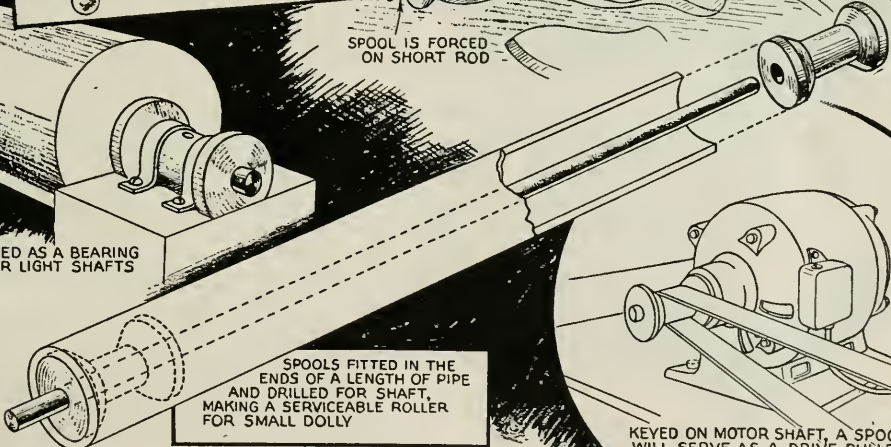

SPOOLS FITTED IN THE ENDS OF A LENGTH OF PIPE AND DRILLED FOR SHAFT, MAKING A SERVICEABLE ROLLER FOR SMALL DOLLY

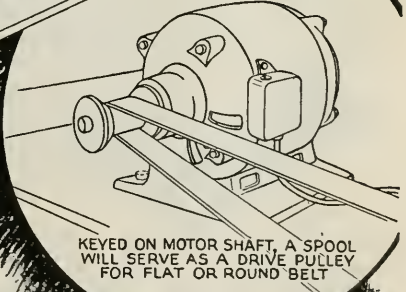

KEYED ON MOTOR SHAFT, A SPOOL WILL SERVE AS A DRIVE PULLEY FOR FLAT OR ROUND BELT

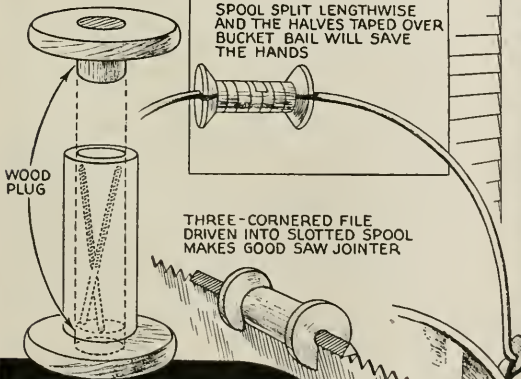

SPOOL SPLIT LENGTHWISE AND THE HALVES TAPED OVER BUCKET BAIL WILL SAVE THE HANDS

THREE-CORNERED FILE DRIVEN INTO SLOTTED SPOOL MAKES GOOD SAW JOINTER

WOOD PLUG

LARGE SPOOL WITH CENTER DRILLED OUT AND PLUGGED AT ONE END MAKES HANDY HOLDER FOR SMALL DRILLS

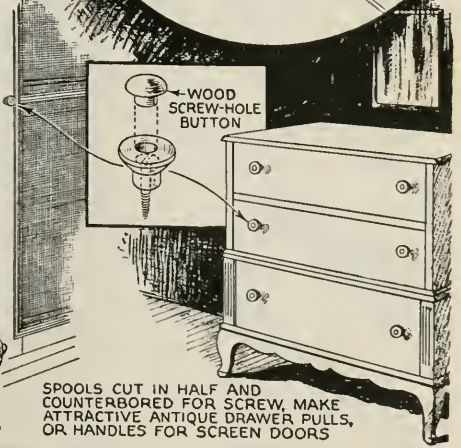

WOOD SCREW-HOLE BUTTON

SPOOLS CUT IN HALF AND COUNTERBORED FOR SCREW, MAKE ATTRACTIVE ANTIQUE DRAWER PULLS, OR HANDLES FOR SCREEN DOORS



You'll Enjoy

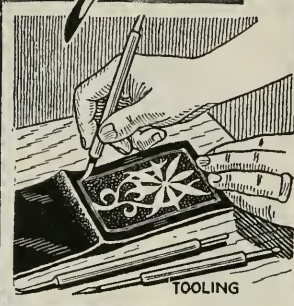

Overlaid pillows, neatly laced moccasins, braided belts and tooled billfolds are a few examples of the art work you can do

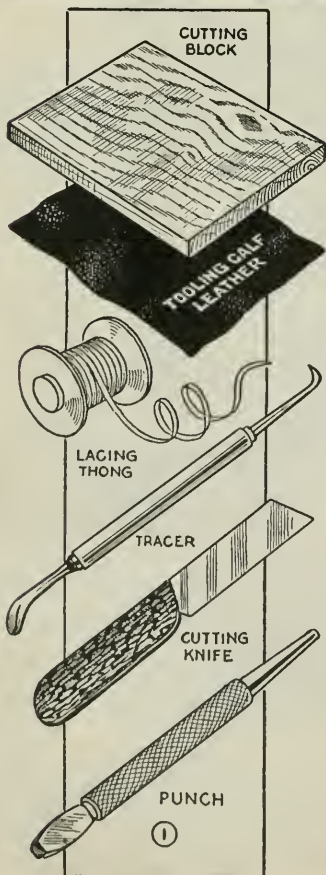

WITH leather available in so many beautiful colors, leather craft has unlimited possibilities. Any of the articles illustrated can be made with only a few inexpensive tools. The work is fascinating and easily mastered by anyone after learning the secrets of the craft.

Overlaying of one or more colors of leather on a background of leather is probably the simplest type of this work but also one of the most effective. By the use of contrasting colors striking effects can be obtained. The leather pillow, shown above, is an example of this type of work. The design is laid out on paper as shown in the squared drawing, Fig. 13, then thumbtacked over the leather and both pattern and leather cut out with a sharp knife. Suede lambskin is used for both the design and the background. Place the design smooth side up on the rough side of the background piece. Ordinary liquid glue, thinned slightly by placing the can in warm water, is used to mount the cut-out pieces. The glue is applied evenly over the rough side of the pieces, then scraped with a knife blade to remove the surplus. If any points fail to adhere after applying the cut-outs to the background, additional glue is applied with a small brush, as shown in Fig. 12. Should glue ooze out around the edges, wait until it is dry and then scrape it off with a knife. After the gluing has been finished, the design should be covered with tissue paper and then weighted down with a board loaded with some heavy object. A binding strip $1\frac{1}{2}$ in. wide is folded over the edges of the cover pieces and the four thicknesses laced together with $\frac{1}{8}$ -in. lacing. Paper clips will hold the material together while lacing. Holes for lacing are spaced $\frac{3}{8}$ in. from the edge and $\frac{1}{2}$ in. apart. A simple running stitch is used.

LEATHERCRAFTING

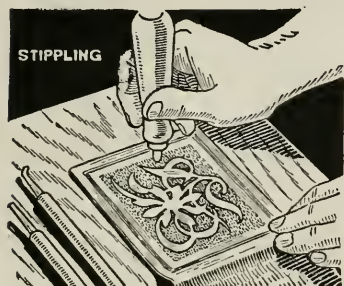

To make moccasins of the type shown in Fig. 6, a soft-tanned elk-skin is recommended. Two pieces are required for each moccasin. Fig. 4 shows the pattern for the sole while the left detail of Fig. 5 gives the pattern for the tongue. The lacing holes on the tongue are spaced closer than those around the toe of the sole, making it necessary to pucker the latter between holes. Because of the thickness of the material it is necessary to skive or bevel the edges of the sole pieces, as indicated in the upper detail of Fig. 5, so that the material can be puckered. Skiving is done by placing the leather along the edge of a board and using a sharp knife. The lacing holes are cut with an inexpensive leather punch as in Fig. 3. It has cutters for various size holes and a stop for spacing from one hole to the next and a given distance from the edge. The heel should not be punched until the moccasin has been fitted as described later.

As the holes are punched for a snug fit, the lacing must be pointed, and pliers used to pull it through the hole. Two colors of $\frac{1}{8}$ -in. lacing may be used, about $2\frac{1}{2}$ times as long as the distance around the toe. Start by pulling one half of one of the pieces of lacing through the holes at the front center of the toe on both the sole and tongue pieces. Pull the other lace through the first hole to the right of the first lace and proceed in a similar manner, lacing over and under with alternate colors of lacing next to each other as in the lower



detail of Fig. 5. Be sure to draw each stitch tight to pucker the sole between stitches. Proceed in this manner until hole B is reached, then end off by passing the lace through the last two holes twice, then under the last stitch, drawing tight and cutting off flush with the edge. Proceed in the same way on the left side. The toe is shaped up by filling with damp newspaper and working by hand.

The moccasins should now be placed on the feet. Then, while standing, pieces M and N are folded around the heel to make sure that they just come together. In case these pieces overlap, the moccasin is too large and the whole pattern of the back should be cut in until a fit is obtained, after which the lacing holes are punched. The outside rows of holes are used to lace up the heel, after which the stay is drawn



up and laced through the inside rows of holes. To finish the moccasins, insert the tie laces through the larger holes, beginning at the heel so the lace goes over the stay on the outside and ties at the center of the tongue.

Braided leather belts are easily made and very practical, as they are somewhat elastic. While braided belts may have almost any number of strands, the ten-strand type, shown in Figs. 8 and 9, is most popular. For this belt, get a piece of leather $1\frac{3}{8}$ in. wide and one third longer than the required belt size. Starting 7 in. from one end, cut the leather into ten strands with a sharp knife and straightedge. Start braiding on the right side with the strand marked 1 in Fig. 8 and weave this over 2, under 3, over 4, etc. Then starting with strand 2, go over 3, under 4, etc. Continue with the other strands in the same way. Draw the strands as tight as possible. The braiding should be hammered at intervals, to flatten it. Make the buckle tongue as shown in Fig. 8. The strands at the end of the belt are skived thin and then glued between the folds of the tongue after the strap and buckle have been inserted. When the glue is dry holes are punched and the tongue is laced through the strands.

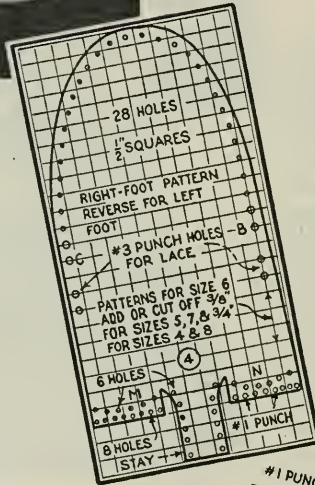

Tooling and embossing designs in leather open up a wide field for craftsmen. An example of this type of work is a billfold, detailed in Fig. 10. A Russian calf or cowhide tooling makes up the cover, lining and two pockets. Only the cover is to be tooled so the choicest piece should be selected for this part. Copy a design on a piece of heavy paper. With a soft sponge dampen the leather thoroughly but not so much that water will ooze out when it is being worked. Lay the piece, smooth side up, on a board and fasten the pattern over it with thumbtacks. Working on the paper pattern, trace the design with the tracing tool, Fig. 1, or a hard pencil. Use a straightedge wherever possible and avoid running past corners by working from the corners toward the center. Marks inadvertently made on the wet leather cannot be removed. Then lift off the pattern, place the leather on a piece of plate glass and retrace the design with a creaser as in Fig. 11. Re-wet and retrace until the lines are of uniform depth. To depress the background, work around the outlines with a

ble and avoid running past corners by working from the corners toward the center. Marks inadvertently made on the wet leather cannot be removed. Then lift off the pattern, place the leather on a piece of plate glass and retrace the design with a creaser as in Fig. 11. Re-wet and retrace until the lines are of uniform depth. To depress the background, work around the outlines with a

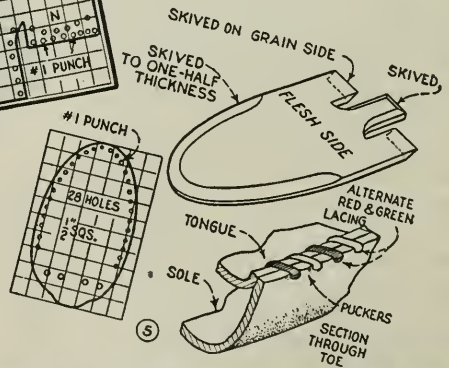

modeling tool or nutpick ground rather flat along the bottom. The final operation is to produce a stippled appearance with a matting tool. If greater relief is desired, the design may be pressed up from the back by laying the piece, face down, in the palm of the hand and working up the raised parts of the design. To secure sharper outlines, the design may be worked out by cutting along the lines with a knife, about half way through the leather, then opening and spreading these cuts with a triangular tool. This type of tooling is called cut leather but requires considerable skill.

We are now ready to assemble the billfold. The simplest method of lacing is the whip stitch, shown in the center detail of Fig. 14. The pieces are simply held together with paper clips

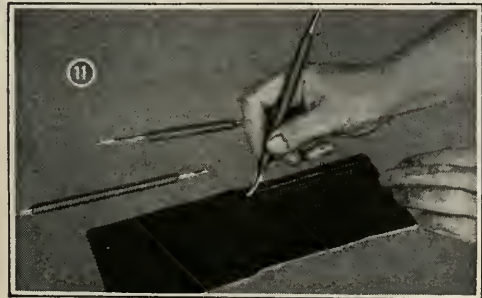
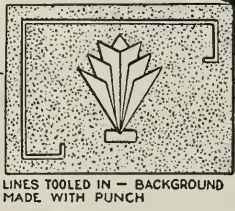
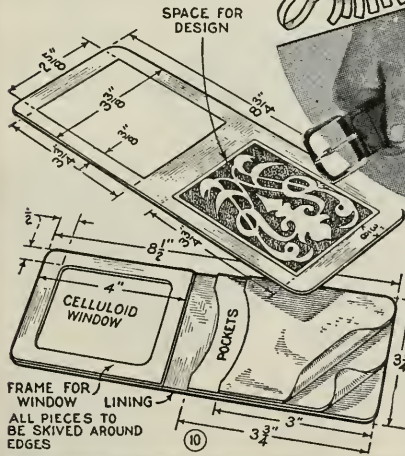
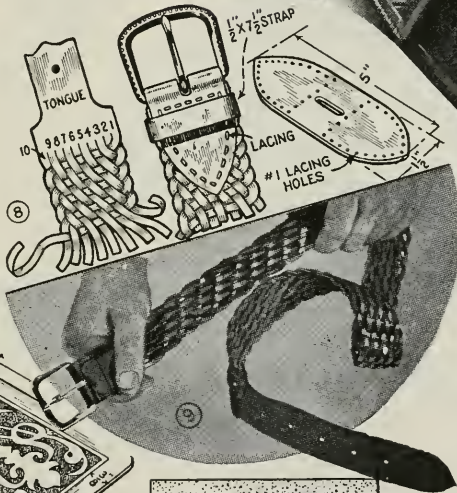
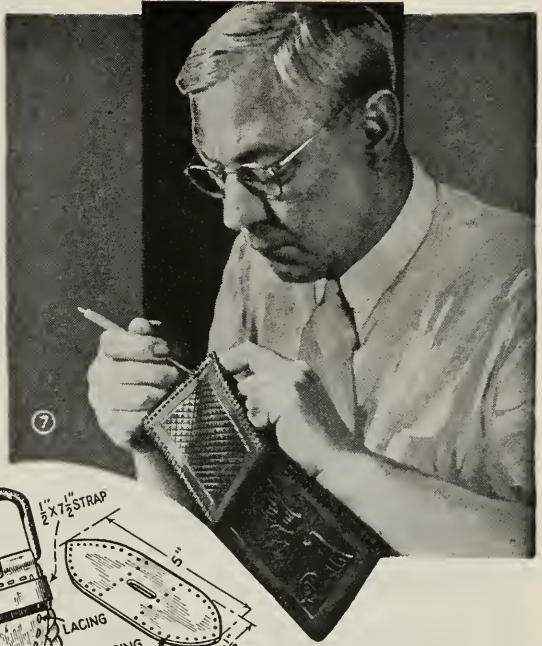

and the holes punched through the entire stack. The two single edges of the paper-money compartment are laced over a single thickness. If it becomes necessary to splice the lacing, simply scarf the ends, glue and clamp as shown in

the lower details of Fig. 14. There are a great many other methods of lacing, the most popular of which is the buttonhole stitch. This method produces a more durable edge than the whip

stitch but requires five times as much lacing as the distance around, while the latter only requires two and one half times. The upper details of Fig. 14 show the steps and Fig. 7 shows a billfold laced in this manner. After lacing around, the ends are pulled through two slits, glue is applied and the trimmed end is tucked under the lacing to conceal it.

Staining or dyeing leather work is an ancient art and many beautiful objects

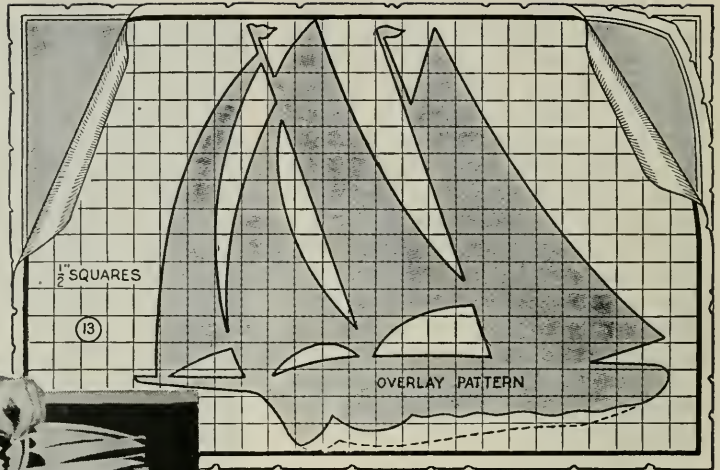
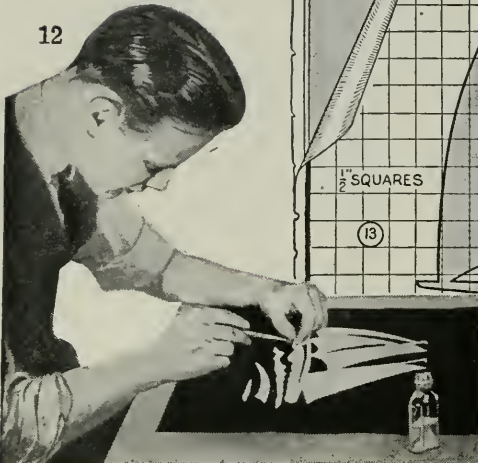

have been made in this way. Large areas are colored with a small cloth pad so that the color will be applied evenly. Smaller details may be worked in with a brush as shown in Fig. 2. Water colors, spirit stains and lacquers are all suitable for leather work. Artistic leather work is usually given several coats of wax to protect it from wear and scratching, the wax being applied with a soft cloth.

There are different ways of applying the wax effectively, the methods depending on the nature of the surface, whether tooled, stippled or embossed. If the surface is smooth, a cloth for applying and another for polishing will do very well. Where possible the work should be laid on a flat surface so that you can apply sufficient pressure to bring out a high luster. On an irregular surface, however, you have to use a brush in applying and polishing the wax coating. An old toothbrush with soft bristles is just the thing for applying the wax to a tooled or embossed surface. After the wax has dried, use an old hairbrush to polish it. On a raised or embossed surface it will take considerable rubbing with the brush to bring out a satisfactory polish.

¶ In an emergency glossy photo prints can be made by substituting window glass for ferrotype plates. Coating the glass with paraffin dissolved in benzine will prevent sticking of the paper.

CRAFT *with* COCONUT SHELLS

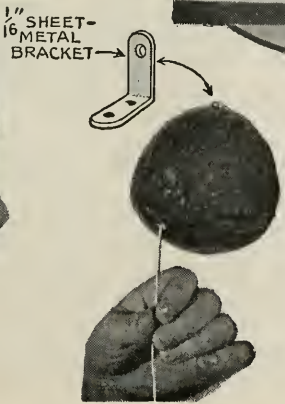
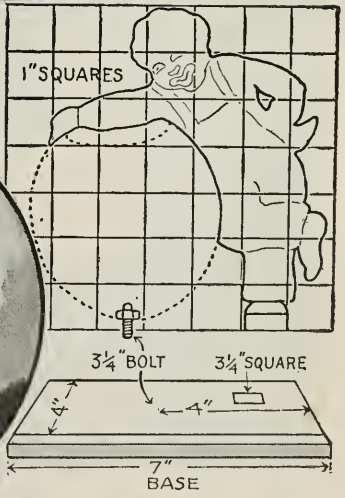
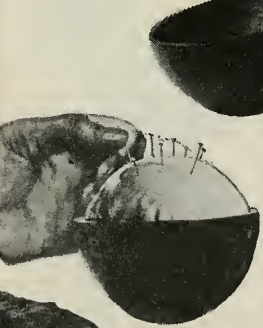
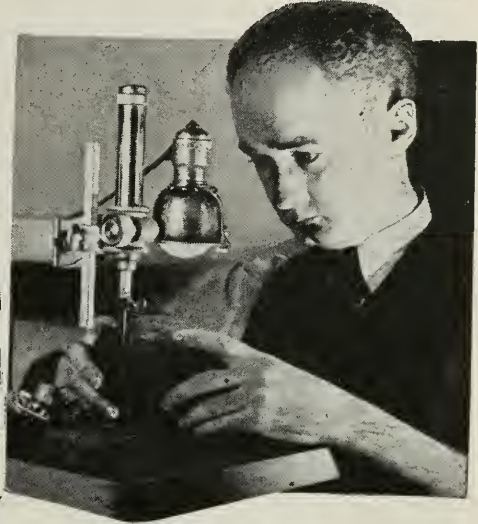

Bracelets and Necklaces From Walnut Shells

UNUSUAL and attractive pieces of "costume jewelry" can be made from black-walnut shells, which are so hard and close-grained that they take a beautiful polish, and are strong enough to withstand reasonably hard usage. The necklace and bracelet shown are but a few of the possibilities of this material. Buttons, pins and novelty hat decorations also may be worked out. After selecting several regular shaped nuts, scrub the shells clean with soap and water, and saw off slices or disks, using any fine-tooth saw. To facilitate holding the nuts, which are placed endwise between the jaws of a vise while sawing, the ends

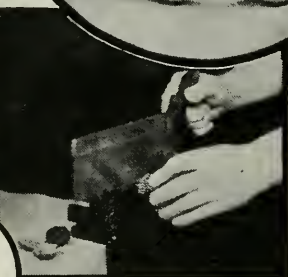
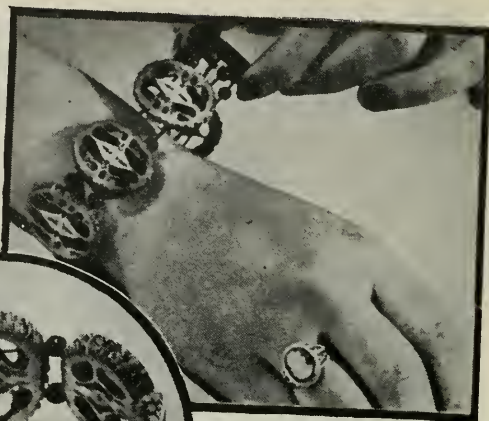

STEPS IN PREPARING THE SHELLS

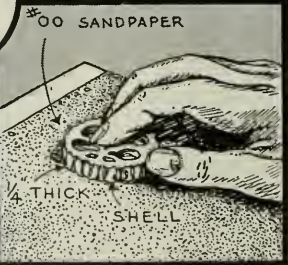
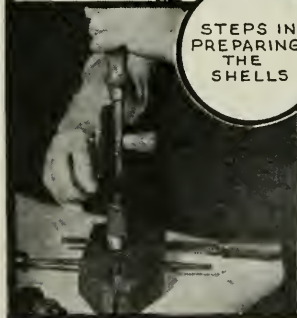

bracelet. Two $\frac{1}{8}$ -in. beads, one on each elastic, are required as spacers between each disk. The elastic is drawn fairly tight and knotted so that the knots will come within one of the large openings of the shell to help conceal them.

are flattened slightly with a file. The nut is squeezed between the jaws with just enough pressure to hold it. After sawing halfway through the nut, a spacer of cardboard is forced into the saw kerf to prevent breaking or binding, and the nut is turned over to continue the cutting.

The sections are placed in a vise or hand screw and holes are drilled about $\frac{1}{2}$ in. apart through the edges for the thread or elastic. The faces of each section are smoothed with sandpaper and polished to a fine sheen with wax. Six or seven sections of uniform size are required for the

The necklace is strung on strong linen thread and provided with a metal clasp. Here you can use pieces of the same diameter, or you can use a large one in the center and have progressively smaller ones toward the end. The quantity of beads between sections and above them will depend on size used. The number of average-size beads needed is indicated by numbers on the photo of the necklace. Brown, black or crystal beads, which are readily available at most ten-cent stores, are appropriate for this jewelry.

Six Unusual

WREN HOUSES

ALL the wren houses illustrated in this article were prize winners and have proved their worth by being occupied during the entire season. One of the simplest homes for a wren can be made from a coconut shell. The top is cut off, holes are drilled for three wires, which are twisted together and slipped through a hole in the top, and a $\frac{7}{8}$ -in. hole is cut in the side. The shell may be painted or left plain, as you desire, and hung up on one of the lower branches of a tree.

Just below the picture of the coconut shell, is one of a home built to resemble a Dutch windmill. This one is particularly adapted for use on a shelf, for hanging from the edge of the roof, or for mounting



Large coconut with hole drilled through side and suspended from tree branch provides home that appeals to Jenny Wren

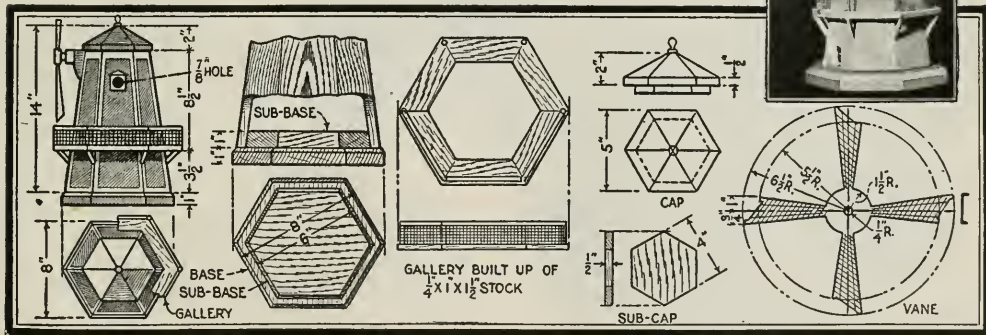

on a pole in your garden. The details of making this type are given in the lower illustration, $\frac{1}{4}$ -in. stock being used. A small gallery is fitted around the walls, $3\frac{1}{2}$ in. from the base. Small split dowels are set at each corner to support the railing, which is a 1-in. width of wire mesh, having a narrow band of tin crimped around its top to form the upper rail. The

base consists of two pieces, one extending beyond the edges of the house and the other tapered to fit inside the nesting space. A hinge and hook and eye hold the base, which is removable for the purpose of cleaning.

Another pleasing type is one made to represent a castle. It is essentially a box, 8 in. square, the bottom projecting beyond

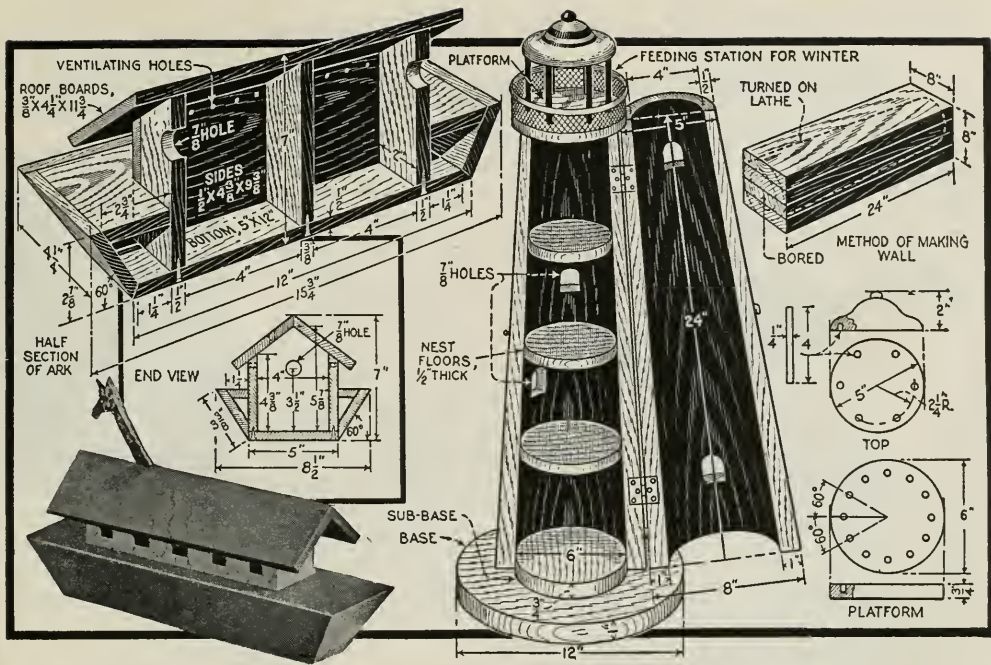

hinged together as shown. In either case, the house should be made in two sections to permit easy cleaning. All bird houses

should be provided with substantial supports and put up early in the season well ahead of the arrival of the songsters.

Pivot Mounting for Bird Feeder Has "Needle-Point" Bearing

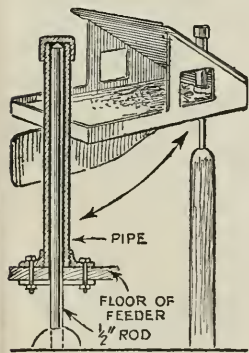

This pivoted mounting for your bird feeder is practically self-lubricating and turns easily so that the feeder always heads into the wind to keep out snow and rain. The mounting consists of a length of 1/2-in. steel rod pointed at one end

fitted into a hole in the end of a supporting pole, and a length of 1/2-in. pipe with a cap on one end and a floor flange on the other. The rod projects through a hole in the floor into the pipe where the point seats in a tiny depression made in the cap with a small drill. A steel plate to take the bolts is placed on the underside of the floor to give rigidity. Heavy cup or fiber grease pressed into the pipe cap takes care of lubrication.

Bird Bath Fitted With Trapeze Pleases Feathered Friends

If you have a bird bath in your garden, rig up a trapeze above it. The enjoyment that the birds will get from this will more than repay you for your time. Just bend a length of small brass rod to a U-shape and invert it above the water. From this, suspend a miniature swing made from fine brass wire.



Bird Houses From Linoleum

Attractive bird houses are made easily from scrap pieces of linoleum. This is tacked to a wood disk to form the bottom and walls of the house, while a cone-shaped piece serves as a roof. A string or wire attached to the side walls, and threaded through the point of the cone, holds the house to a tree branch.

Bird Perches From Coat Hooks

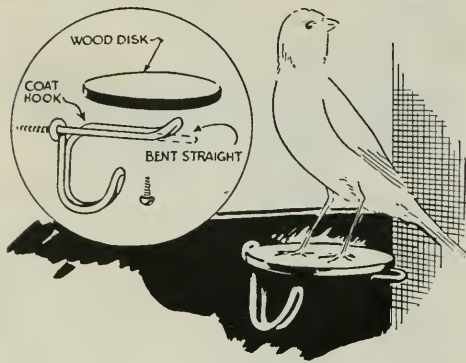

Neat perches in your aviary or pigeon pen can be improvised by screwing small wood platforms to the ends of common wire coat hooks as indicated.

Keeping Cats Out of Birdhouse



If the standard is too large or too small for the pipe, a piece of sheet metal may be substituted.

When cats climb up a birdhouse standard or tree to get at the nests, take a length of stovepipe and slip it over the standard or tree trunk as indicated. As the surface of the pipe is hard, a cat cannot use its paws to climb it.

Pan Nailed to Tree Trunk Is Good Bird Feeder

Desiring an inexpensive bird feeder of large capacity, one farmer nailed a pan to a tree and then soldered $\frac{1}{2}$ -in. wire mesh over the top as indicated, leaving the upper portion open so that the food supply could be replenished. The feeder was kept filled with wheat heads. After picking the wheat grains from the heads, the birds

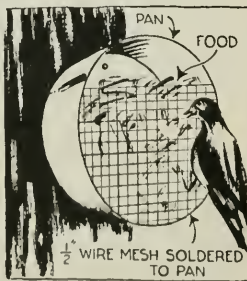

pulled the empty ones through the wire and dropped them so that they could get at the filled heads.

Birdhouse You Can Make Quickly

Here is a birdhouse that you can make in one evening. The ends are cut from $\frac{1}{2}$ -in. wood, and the roof, sides and bottom are cut from composition roofing, which is merely nailed to the edges of the end pieces.



A $\frac{1}{4}$ -in. dowel projecting underneath the entrance hole serves as a perch. The house is about 12 in. high and 6 in. wide at the roof edge, depending on the size of the bird for which it is intended.

Spring Perch on Wren House

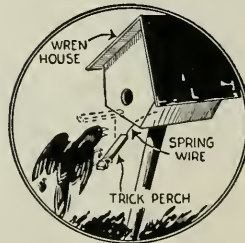

To discourage this, one man provided a perch, which consisted of a short dowel on the end of a short spring wire. As the perch was not strong enough to support a heavier bird, intruders in trying to alight on it were frightened away.

While most birds are too large to enter the opening to a wren house, which needs no perch, they do sometimes attempt to enter and may annoy the wrens. To dis-

Sparrow-Proof Martin House

If you want to keep sparrows out of a martin house between the time the martins leave in the fall and return in the spring, substitute a pivoted shelf for the regular perch as

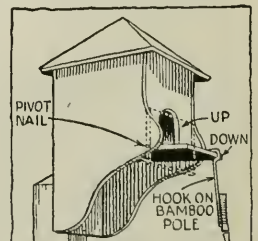

indicated. Then the perch is tipped up against the opening and left there until it is time for the birds to return in the spring.

Birdhouse Spans High Post of Garden Gate

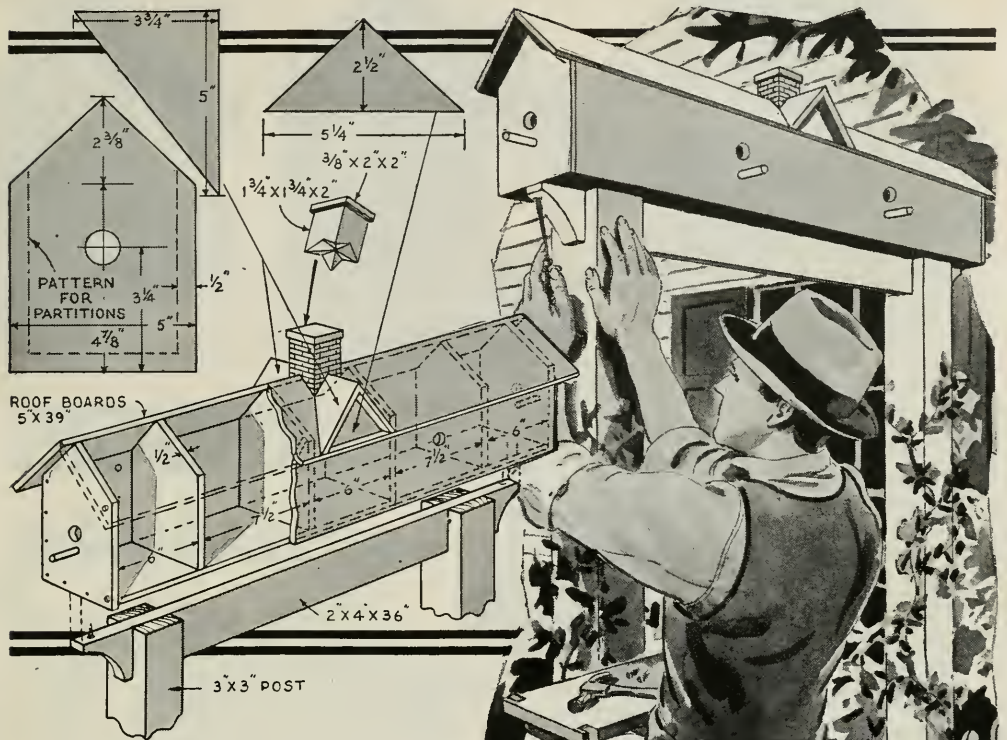

Instead of just a plain tie strip across two high posts supporting a gate to his garden, one home owner mounted a long birdhouse on top of the strip. Simple in construction, the house has four nesting compartments, one at each end and two in the center. Two gables and a false chimney at the center tend to break up the plain lines of the house and give it a more

realistic touch. Screws through the tie strip and house bottom hold it in place.

Split Keg Provides Bird Feeder

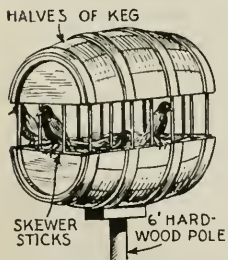

Sawed in half through the center lengthwise, a small keg makes an ideal feeder for birds. Before sawing the keg, nail the hoops to each stave and also nail the ends to keep the assembly from falling apart. Small dowels or skewer sticks are set in holes equally spaced around the edges of each half of the keg to hold them apart. A hardwood pole 6 ft. long supports the feeder.

Wren House From Auto Casing

Jenny wren will appreciate this little house, which is nothing more than a short piece of auto casing fitted with wood ends cut to shape and nailed in place. A 1-in. hole bored in one end serves as a door, and a board nailed to the bottom of the old casing and to the ends provides a base for the little house.

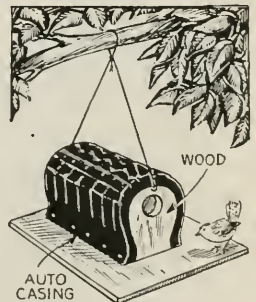

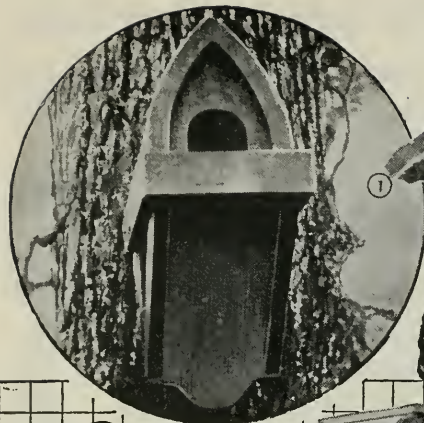

1

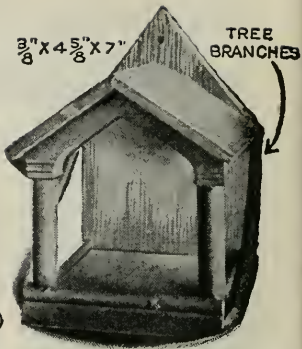
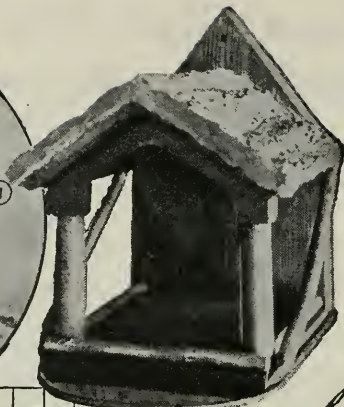

3

Robin shelter

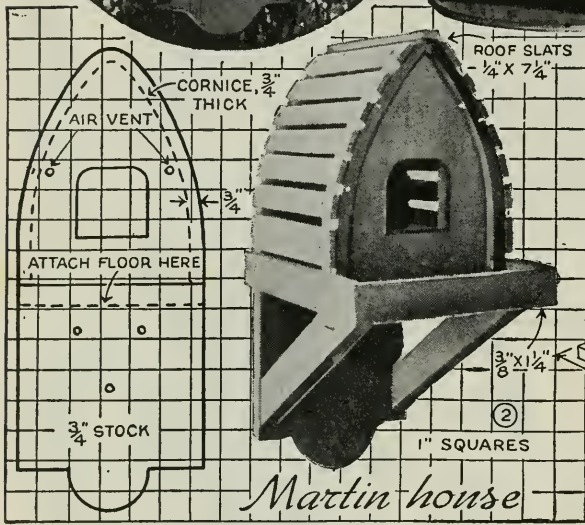

Martin house

COOL of asbestos

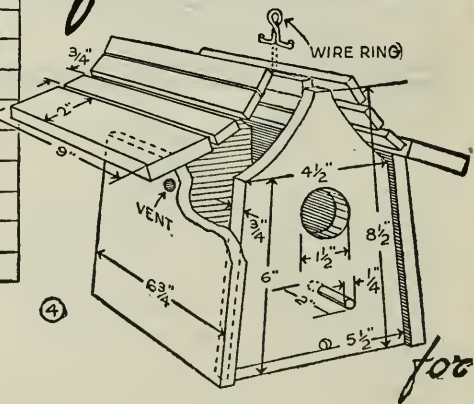

By DICK HUTCHINSON

EVERYONE who has built houses to attract birds around the home probably has wanted to make round and odd-shaped houses with irregular roofs either for the novelty of appearance, or to blend in with the surroundings. Those who have foregone this pleasure because of the difficulty of shaping the desired houses from wood—metal being out of the question because the houses would be too hot—can get any shape desired by covering them with a plastic material consisting of portland cement, 1 part, and asbestos cement, 3 parts. This material dries slowly so that you have plenty of time to mold it as desired, and if kept out of the sun and wind so that it dries as slowly as possible, it will become very hard. It can be troweled smooth or left rough, and will take paint nicely, making it possible to finish the houses in bright colors to help dress up the garden.

In using the plastic, all you need is a framework on which to apply it. The martin house in Figs. 1 and 2 is a good example. The ends are solid wood and the roof, which is covered with the plastic, is made of slats. Robins usually build on a shelf of some kind, but will not nest in a closed house. The shelter in Fig. 3 is attractive to them. The roof only is covered with the plastic, which is molded to resemble bark. A few small nails projecting from the roof slats help to anchor the plastic. The bluebird house in Figs. 4 and 7 is of solid wood, but the roof is covered with the material and molded to simulate shingles. A woodpecker is one bird that insists on building in a hollow log, but it is easier to make the "log" shown in Fig. 6 than it is to find a real one that is hollow. Assemble the skel-

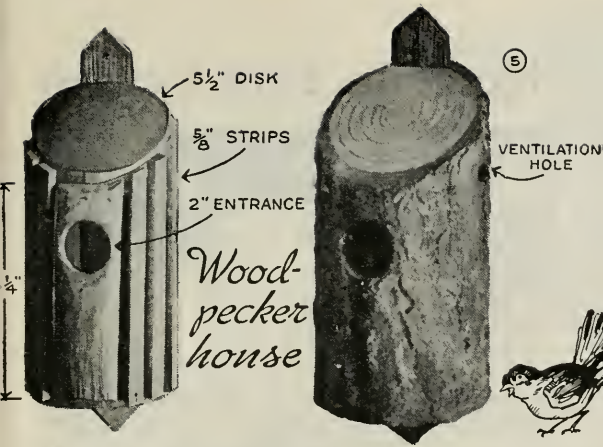

BIRDHOUSES

cement

FORMULA
 ASBESTOS CEMENT
 3 PARTS
 PORTLAND CEMENT
 1 PART

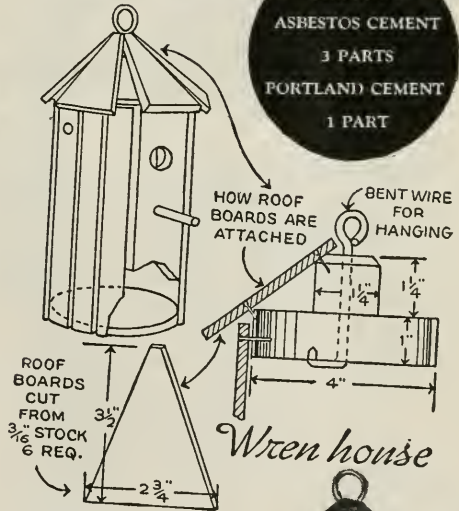
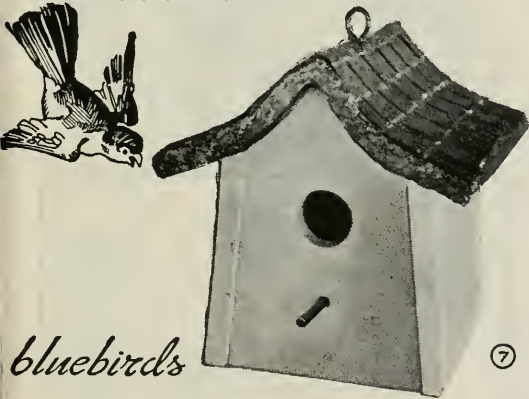

eton framework and cover the outside roughly with the plastic, allowing it to dry for a day or so. Then apply a second coat, reproducing as nearly as possible the bark of a tree.

Now comes a home for the little house wren. The one shown in Fig. 8 is easy to make and is entirely covered with the plastic. The framework consists of slats nailed to wood disks at the top and bottom. Also, the roof is made of slats, which are shaped and assembled as in the upper detail. Be sure to make the entrance opening small enough to keep out other birds or the wren will vacate its home. The house can be hung in the branches of a thickly foliaged tree or under the cornice of a building.

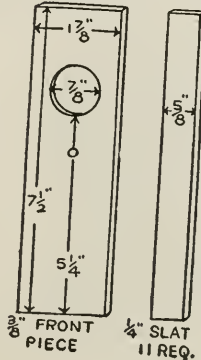

Keeping the Birds at Home in Your Garden

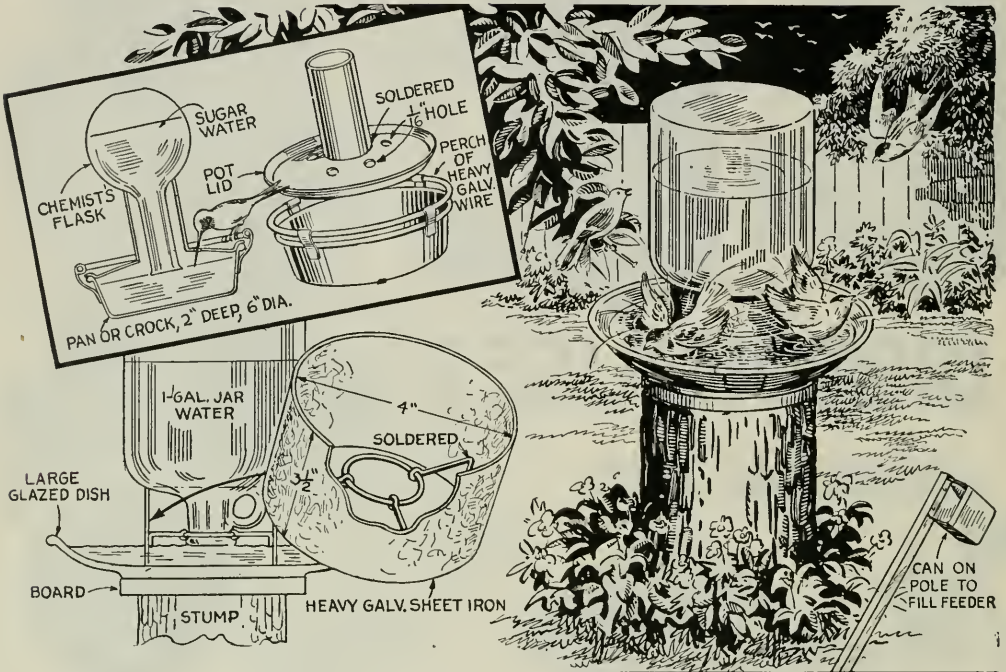

Chances of attracting birds and keeping them around are increased if you will provide water which is readily accessible to them. Where water quickly evaporates from a shallow dish, a constant supply can be maintained by using inverted flasks or jugs held a short distance above the bottom of the pans or dishes as shown in the pictures above. Take the simple type of bird bath at the right: A large, shallow dish, preferably light green in color, is set on a stump or pedestal and a gallon jug of water, fitted with a sheet-metal collar, is placed inverted in the center of the dish. The collar is wide enough to keep the mouth of the jug above the bottom and a wire frame in the collar serves to hold the jug in position securely. The result is a constant supply of water until the jug is empty. The same principle is used in making the small sugar-water feeder at the left. In this case, a flask or bottle is used as the reservoir while the pan is covered with a perforated cover to minimize evaporation. The cover should be located just above the level of the liquid so that birds will have no difficulty in getting at it. A California bird lover succeeded in attract-

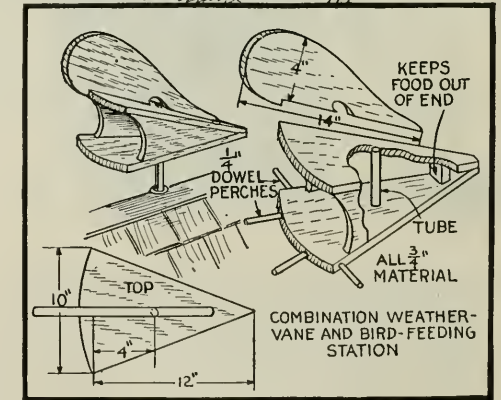

ing hundreds of hummingbirds to his grounds by using such feeders. For hummingbirds, the feeder should be arranged so that they have access to the liquid while on the wing as they seldom alight. The lower detail shows a protected feeding shelter in which crumbs can be placed. The shelter is pivoted to rotate into the wind and the vane on top keeps it pointed into the wind. Keeping the feeder supplied with crumbs is easy if you use a long stick or pole having a can nailed to the top end.

Winter SNACK SHACKS for Birds



By providing feeding shelters for birds in winter, when snow and sleet seal up their natural food supply, they will reward you by becoming quite tame and interesting subjects for study and observation. The shelter at the right is pivoted on a post and swings around in the breeze so that food will not blow away. A sliding feeder suspended from a line as shown below can be moved a little closer to the house each day so that you can observe the habits and antics of the birds at close range. A sheaf of grain on a pole is also welcome to snowbound birds

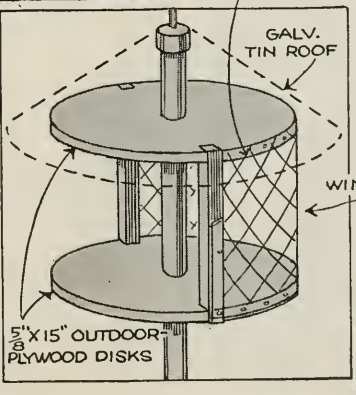
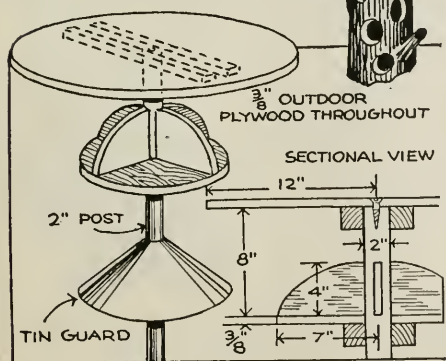
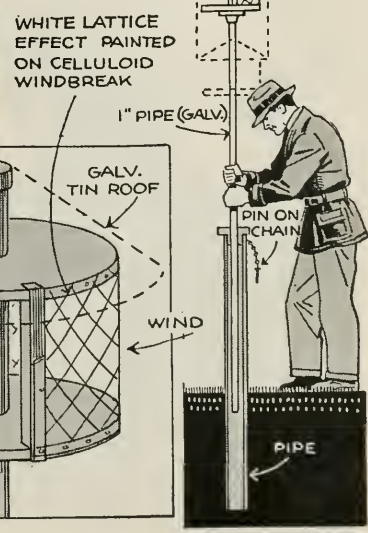
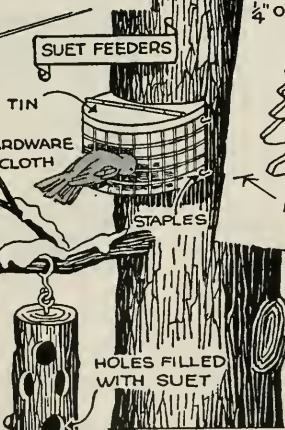
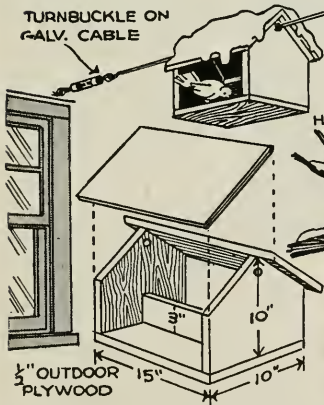
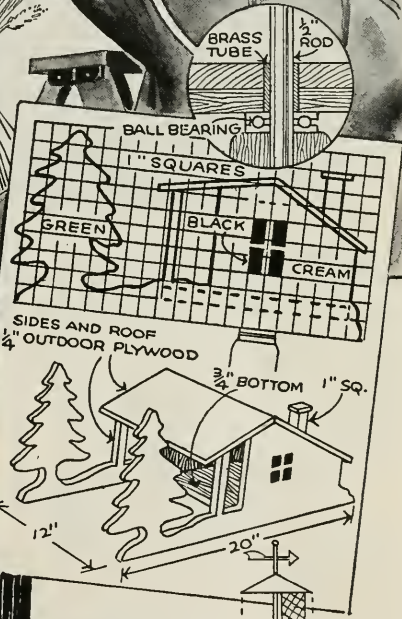
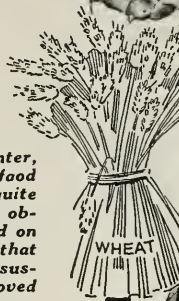

Broom Clamp Supports Bicycle Against Side of House



Instead of leaning your bicycle against the house where it may fall and become damaged, attach a broom clamp to the siding or corner board so it will grip one of the handlebars when the bicycle is in an upright position. It takes only a light jerk to release the handlebar from the clamp.

Stoplight Switch on Bicycle Operated by Chain

The safety added to a bicycle by using a stoplight, especially if you ride on heavily

crowded streets or highways at night, makes it well worthwhile to install this simple one, which flashes when the brake is applied. The light consists of a flashlight reflector fitted with a red Cellophane lens and attached to a block, which is in turn fastened to the rear fender of the bicycle. The light is wired to a dry cell as shown in the diagram, a switch being cut into one side of the circuit. The switch consists of two blocks hinged together at one end with a copper contact on each facing surface near the other end, wires from the lamp and dry cell being attached to the contacts. This assembly is fastened to the bicycle frame with a bracket. The switch is located so that its underside just clears the lower chain, or slack side when pedaling forward. In this position, the switch contacts will be closed when the slack side of the chain tightens as the brake is applied.

Reflectors on Bicycle Pedals

Most bicycles have red reflectors on the fender to reflect the lights of a car approaching from the rear and warn the driver, but few riders take the precaution of warning a motorist who might approach them from the side. This can be done quite easily, however, by attaching red-glass reflectors to the ends of the pedals. The type backed by metal are easily soldered to the pedals, and are noticeable because they rotate with the pedals.

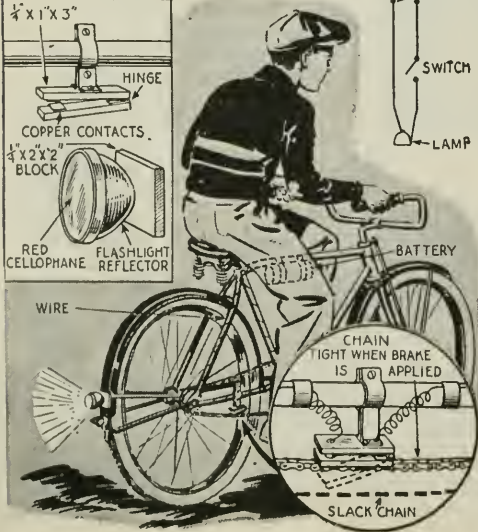
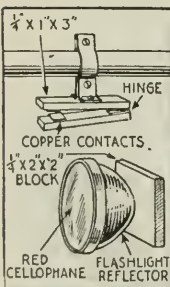
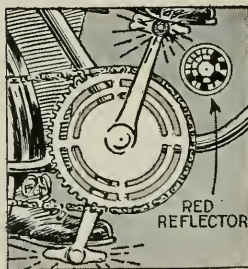

Rubber Straps on Bicycle Basket Keep Books From Bouncing Out

When carrying books or other small objects in the basket of your bicycle they can be kept from bouncing out by use of a couple of straps cut from an old inner tube. These are fastened to the bottom of the basket so that they can be stretched over the article carried.

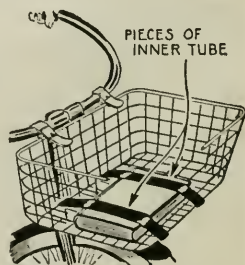

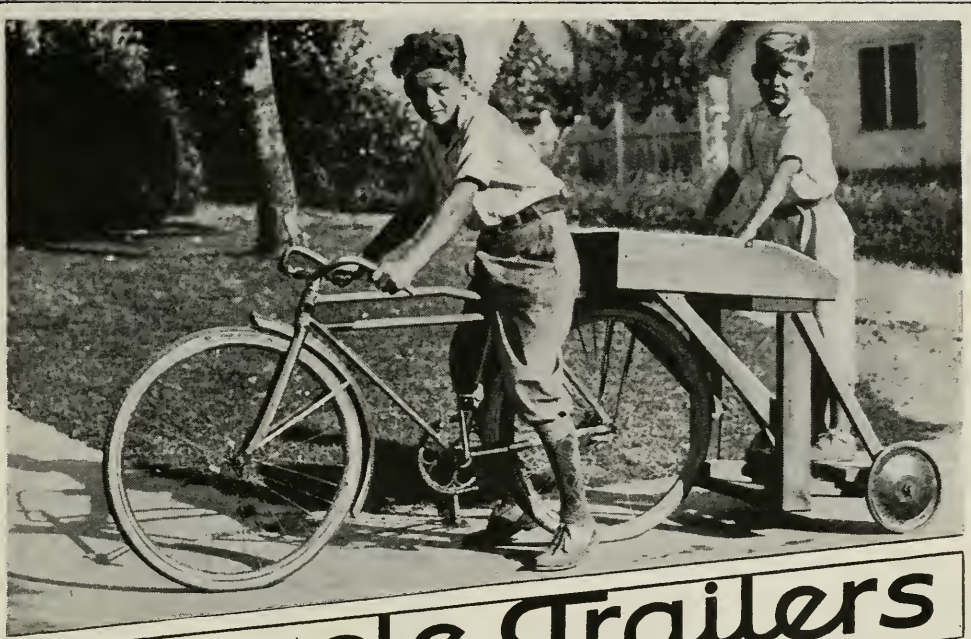

Bicycle Trailers

Above, Carl and Dick Gemin, of Dayton, Ohio, with Their Newspaper Delivery Trailer, Used to Cover a 5-Mile Route. Notice the Low Platform Enabling One to Hop On and Off. The Front Slips over a Pin on the Bicycle so That the Trailer Is Quickly Removed. Below, Light Plywood Trailer, with Hinged or Removable Top

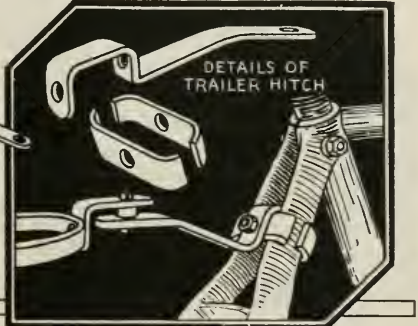
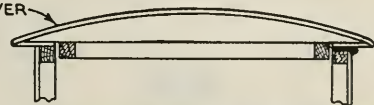
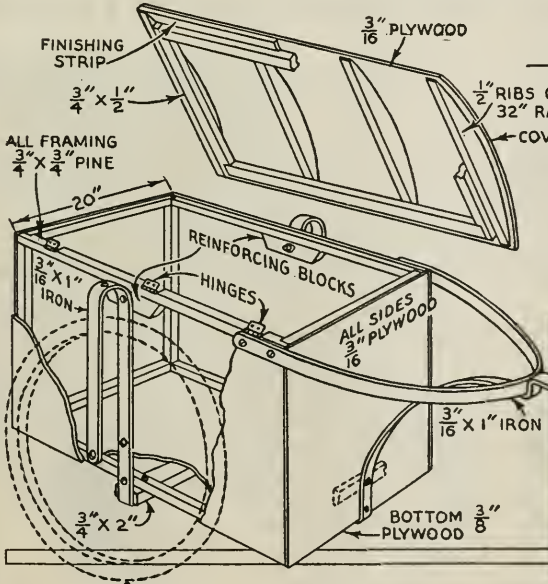
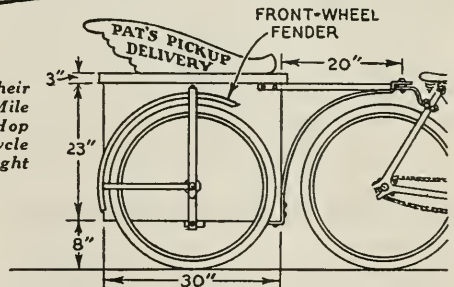

Midget Sidecar for Junior's Sidewalk Bicycle

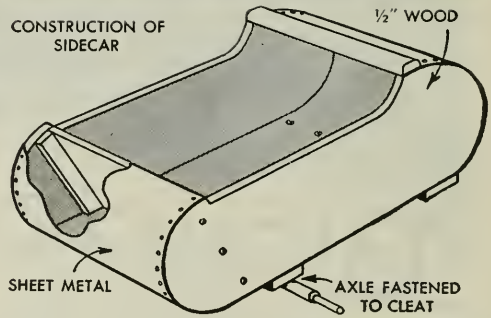
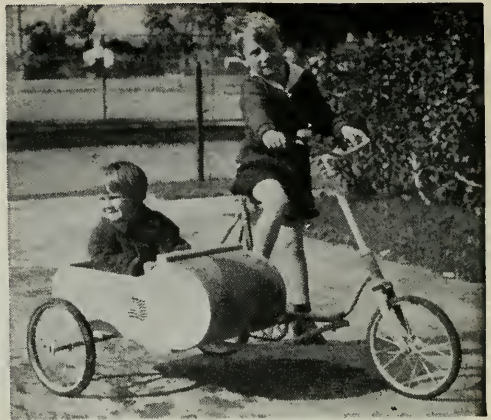
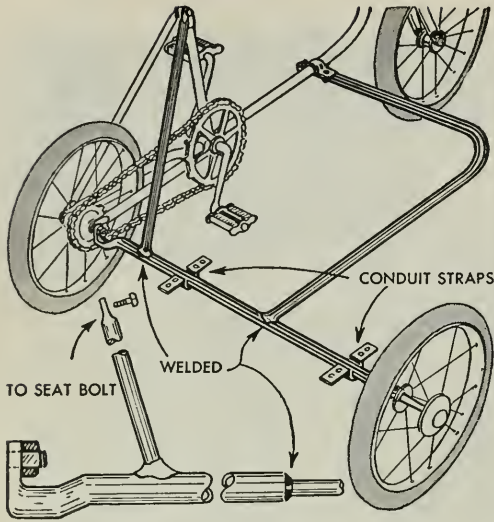

Here's a simple bicycle sidecar that is bolted to the bicycle at three points and can be attached or detached in a few moments. Besides carrying a passenger, the sidecar is handy on a newspaper route or for delivery of packages. The simple frame is made of $\frac{3}{4}$ -in. conduit, bent and welded together, while the body is assembled by screwing a piece of sheet metal onto duplicate wood sides. Two wood cleats screwed to the underside of the bottom give rigidity

and at the same time provide good solid surfaces for attaching the body to the frame with conduit straps screwed in place.

Jig Aids in Truing Bicycle Wheel When Tools Are Limited

The cyclist or owner of a small shop who wants to true or stripe a bicycle wheel oc-

asionally, but does not have the equipment, will find this little jig the solution to his problem. In use, the wheel is clamped in a vise by the spindle, and the jig is attached to the edge of the bench. In it can be held a small block for truing the wheel, or a brush for striping it.

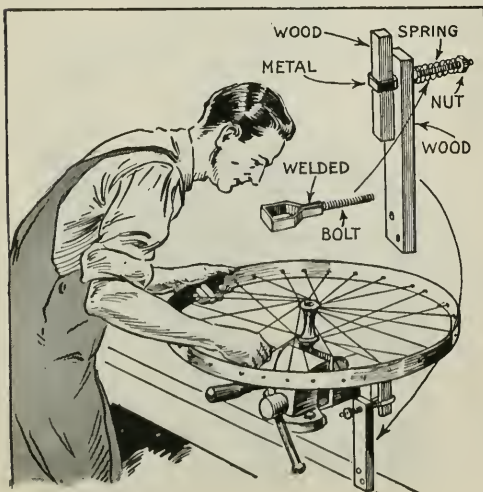

Bicycle Handlebar Has Reflectors

One boy who used his bicycle at night put red reflectors in rear ends of the handlebar grips in addition to a large one on the rear fender. To install the reflectors, rear ends of grips are cut out, leaving enough rubber at the outside to serve as a retaining edge.

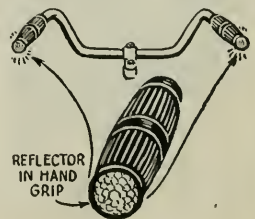

Three Handy Ideas That Will Help the Cyclist

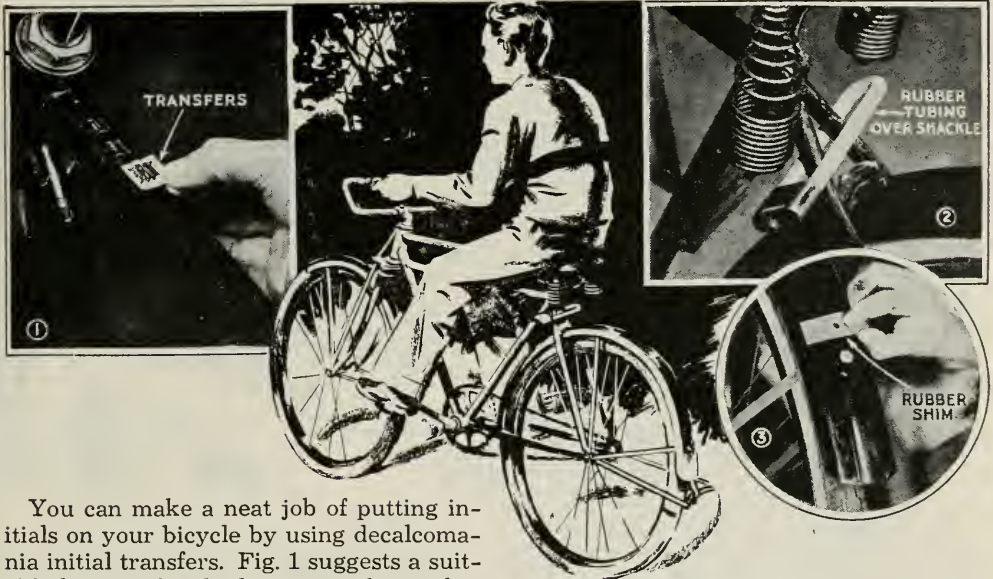

You can make a neat job of putting initials on your bicycle by using decalcomania initial transfers. Fig. 1 suggests a suitable location for the letters, on the top bar of the frame. If you carry a lock regularly, slip a length of rubber tubing over the shackle and then snap the lock over the rear fork under the saddle as in Fig. 2. You'll always know where your lock is and it won't rattle. A clattering mudguard

may be silenced by placing a rubber shim cut from inner tube under the guard between the latter and the supporting frame as in Fig. 3. Don't neglect to use a lock washer under the nut when you tighten the assembly in place.

Bicycle Ramp Above Porch Steps Is Swung Out of the Way

Where bicycles are kept on a porch, children will find it easy to take them up

or down the stairs if a plank is provided to serve as a ramp, which reaches from the porch floor to the sidewalk. It is pivoted at the upper end by means of an L-shaped rod, which fits in a pipe bearing fastened to the underside of the board by means of pipe cleats as shown in the circular detail. The other end of the rod pivots in a cleat fastened to the side of the porch just below the floor boards. This arrangement allows the assembly to be swung against a porch post, out of the way.

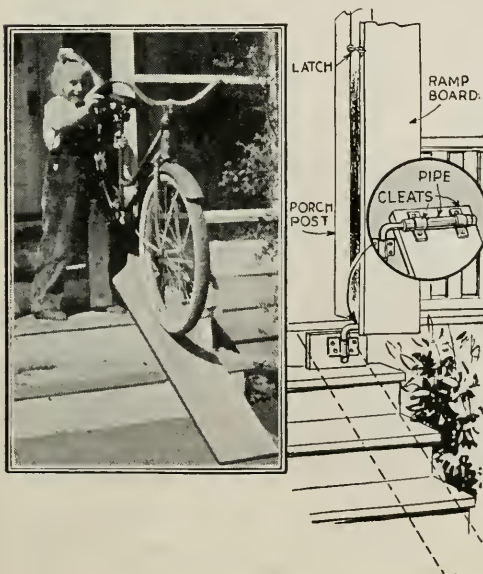

Repairing Worn Bicycle Chain

When a bicycle or motorcycle chain becomes badly worn, its life often can be prolonged in the following manner: After cleaning the chain well, lay it flat on a bench with the heads of the rivets uppermost. Then with a solid metal block beneath, center-punch each rivet by one or two taps. When every rivet has been treated, repeat the operation on the other side.

A Streamlined "Saddlebag" for Your Bicycle

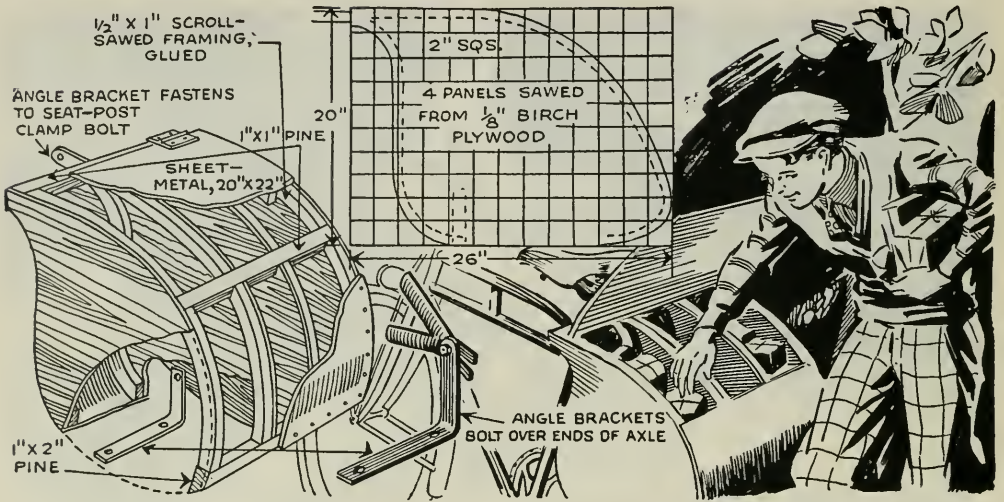

As it straddles the rear wheel of your bicycle, this parcel carrier is something like an old-type saddlebag. It is just the thing to make light deliveries, carry daily orders of groceries or packs of newspapers. The curved portion is covered with sheet metal fastened with brass escutcheon nails. The plywood panels are assembled in pairs and joined by the cross members. The lat-

ter are set in notches in the two inner panels flanking the wheel. There are no notches in the outer panels, which are nailed and glued to the ends of the cross members. The carrier is mounted on two angle brackets bolted to the ends of the rear axle and one bracket to the seat-post clamp bolt. Two curved cleats keep the sheet-metal lid in the proper curved shape.

Bicycle-Carrying Rack Clamps on Car Bumper

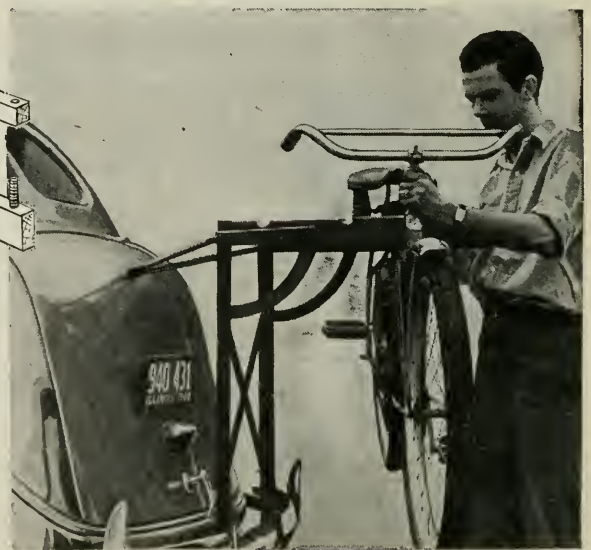
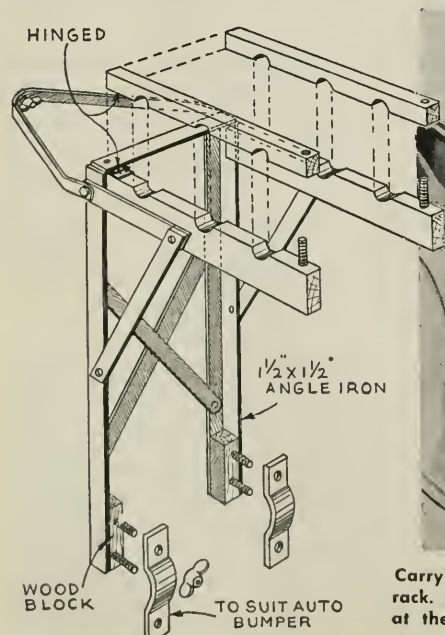

Carrying one or more bicycles on a car is a simple job with this rack. Easy to remove, it clamps to the bumper and is supported at the top by one bolt through the trunk. Notched arms and clamping cleats support the bicycles

Plenty of Fun and Action With These Boxers

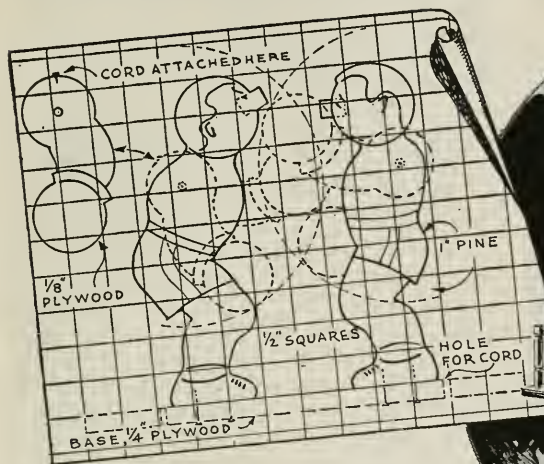

Punching each other in a realistic manner, these bantam boxers will delight any small boy. Animation is obtained by moving the "ring" or base with a slight rotary motion to swing a lead weight, which is attached to the arms by cords. The figures are cut from 1-in. wood, the arms from $\frac{1}{8}$ -in. plywood and the base from $\frac{1}{4}$ -in. plywood. The figures are nailed to the base, and the arms are pivoted to the body, and the arms are pivoted loosely from the body. All four arm cords are tied together about 3 in. below the base, and then to a 2-oz. weight with a 3-in. length of cord. Four dowels support two pieces of cord which form the ring.

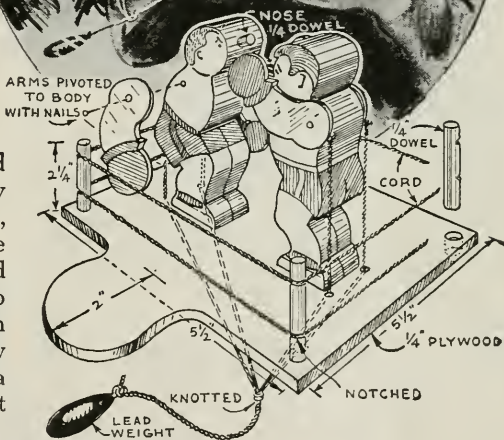

Current Collector on Toy Train Is Polished Automatically

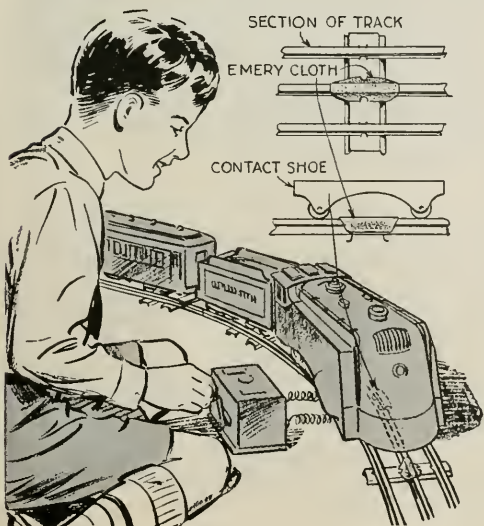

To assure good electrical contact between the current collector and the third rail of a toy train, attach a short strip of emery cloth to the rail as indicated, slipping the edges under the tabs that clamp the rails to one of the ties. The strip should be a little shorter than the distance between the two shoes or rollers of the collector so that the current will not be interrupted entirely. The collector slides over the abrasive each time the train goes around the track and removes film, dirt or oxide that may form on the collector.

When adding the features to animal cut-outs a clever method of representing the eyes can be had by utilizing gummed notebook reinforcements available at stationery stores for a few cents a box.

Easily Assembled Rope Walker Amuses the Children

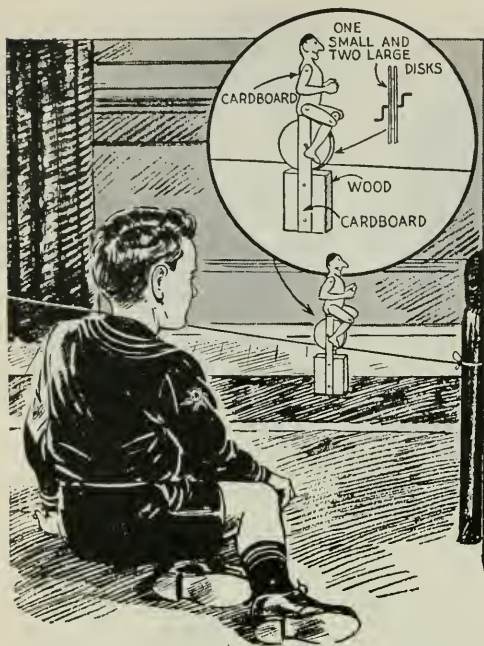

When you are looking for something to amuse a small child, try this tight-rope walker. It is constructed of cardboard in a few minutes. Each arm is cut in one piece and pivoted to the body, while each leg is in two pieces and pivoted at the knee and hip. The disk, which runs on a taut string, has an axle of the bicycle type, the feet being pivoted to it. A wood counterweight keeps the walker upright.

"Push Rod" Removes Pins in Toy-Train Track

When the connecting pins in the ends of a toy-train track become forced into the hollow rails, this push rod is handy to remove them. It is a length of small steel rod of size to slip into the hollow rail eas-

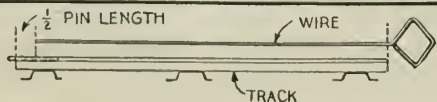
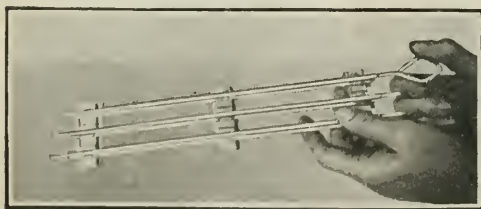

ily. One end is formed into a handle. The straight portion equals the length of a rail less one-half the length of a pin. Then when the rod is used to push out a pin it will automatically stop when half of the pin projects from the rail end.

"Lung Tester" for Fun at Party Will Mystify Your Friends

Here is a lung tester that will provide a barrel of fun, and enable you to show the superiority of your lungs over those of your friends. The tester consists of a small phial floating upside down in a 1/2-pint flask filled with water. There must be just enough air trapped in the phial to barely float it. A rubber tube is connected to the flask by means of a short glass tube through the stopper. The explanation offered to the uninitiated is that by blowing through the tube he can compress the air



in the phial, force in more water and cause the phial to sink. Anyone attempting this will find his lungs unequal to the task. As a matter of fact, no amount of blowing will have any effect, as the rubber tube is plugged. The only way to sink the phial is to compress the air in it by squeezing the flask in the hands, thereby slightly bending in the sides of the glass. By pretending to blow in the tube and simultaneously squeezing the sides of the flask, anyone can sink the phial.

APARTMENT DOLLHOUSE

Modernized with Elevator

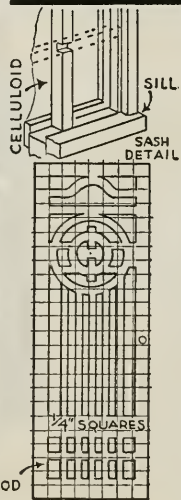
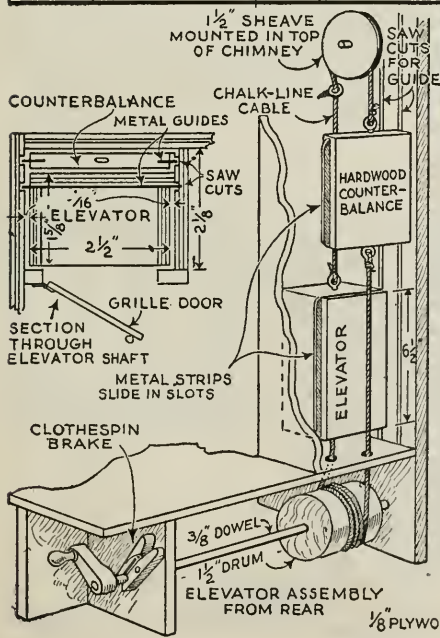
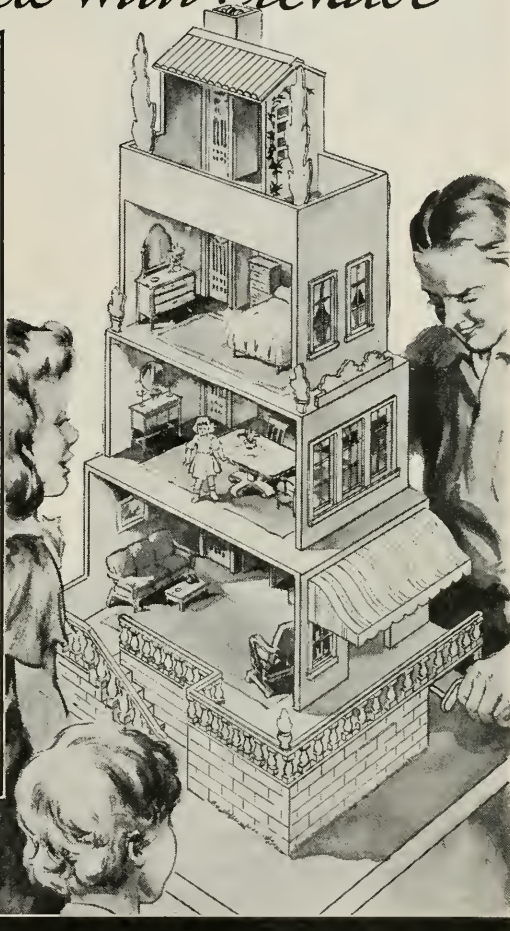
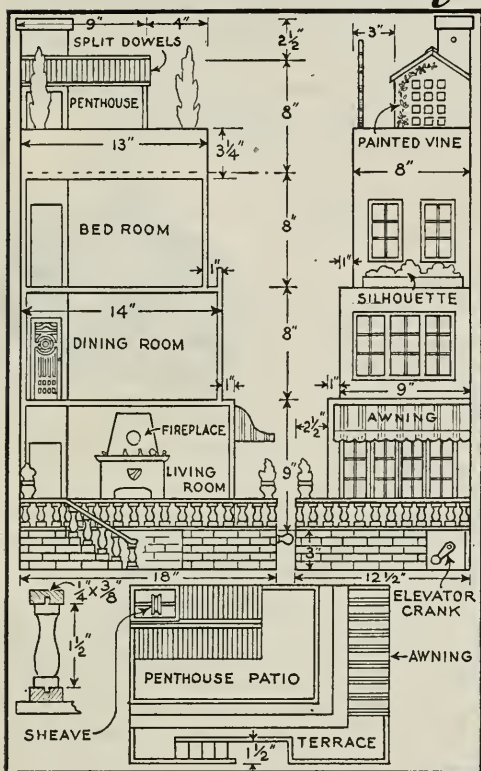

THE four-story, step-back construction of this pressed-wood or plywood dollhouse gives it more room than the average dollhouse, without taking as much floor space. One side of each room is open and only one wall of each room is provided with windows. The elevator shaft is incorporated with the chimney and has a door on each floor. A crank projecting from the basement wall operates the elevator, which remains at any floor by the braking action of a clothespin on the axle. A balustrade around the terrace and a tin awning add to the appearance.

Child's Scooter Folds Compactly for Storage

Just remove one hinge pin on this scooter and it will fold into a small space

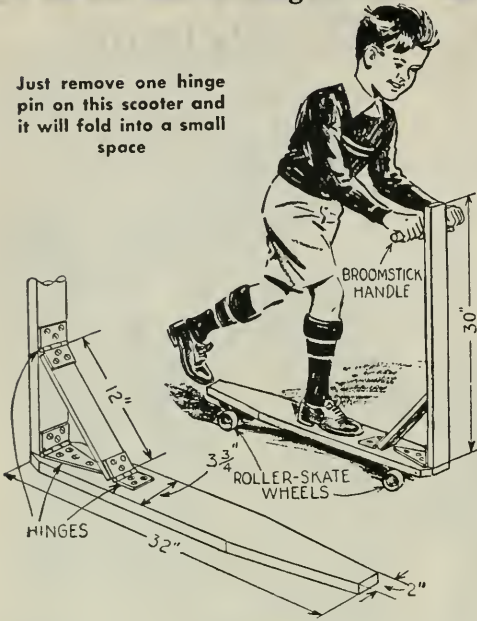

Coasters and scooters often take up more space than the average apartment dweller is willing to sacrifice. Here is one that can be reduced to a small bulk in a jiffy so that it can be stored from one season to the next or squeezed into a small corner when not in use. The small hinge on the base is mounted so that it will fold back on itself, while the one on the upright should have the pin knocked out and a long slender bolt with a thumb screw substituted for easy dismantling. If the half of the large hinge which is screwed to the base is bent up slightly, the upright board will lie flat when the brace board is removed.

Upholstery Tacks Hold Checkers From Sliding on Board

To permit playing checkers on a train or in an auto trailer on the road, without danger of the checker men sliding about on the board, drive upholstery tacks into the centers of the black squares and drill holes of corresponding depth in the centers of the checkers. The rounded

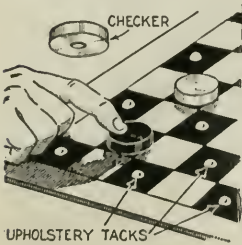

heads of the tacks allow the checkers to be pushed on or off the squares without actually lifting them each time, yet prevent the checkers from being dislodged by jiggling the board, especially when it is supported on the laps of the players.

Bobby Pins Make Connectors on Toy-Train Tracks

The loss of a few stub wires, usually provided as connectors for toy electric-train tracks need not prevent the operation of the plaything. Simply bend bobby pins and employ these as substitutes. The pins will fit snugly into the sockets and provide the contact necessary to carry electric current.

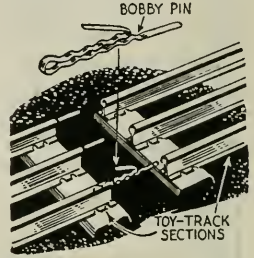

"Balloon Dodger" Hoop Game Tests Your Skill

An interesting and amusing game that looks easy but proves difficult to score may be made from several sausage-type toy balloons. These are inflated and painted to resemble caricatures, after which they are attached to a base. In playing, the contestants stand at a predetermined distance from the balloons and endeavor to toss embroidery hoops over them. As the balloons move at the slightest touch, the hoops must drop directly over them to score a point.



Extra Current Collector Improves Toy Trains

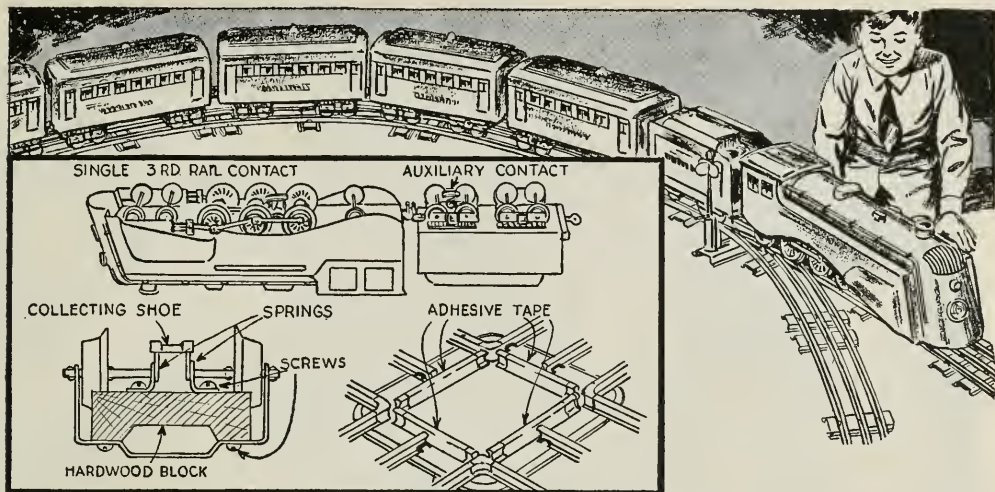

If your toy train stalls when passing over "dead spots" on switches and crossings, likely it has only one current-collecting shoe on the locomotive. This trouble can be avoided if you add an auxiliary shoe to one tender truck, connecting it to the third-rail contact of the locomotive. The shoe is taken from an old electric-iron connector, and is soldered to springs made from the heels of two safety pins, which, in turn, are screwed to a hardwood block.

The wire to the locomotive is soldered to one of the screws holding the springs. Care should be taken to keep the wire away from moving parts that might wear off the insulation. Old-style crossings should be covered with strips of adhesive tape at the points indicated in one of the details to prevent short-circuiting, which might cause the burning out of a transformer. If desired, the strips may be given a coat of shellac for permanency.

Amusing Animal Toy Can Change Its Face

Wagged from side to side by a pendulum, the head of this toy has interchangeable eyes, mouth, nose and ears, which can be used in various combinations to produce unusual facial expressions. Variations of these facial parts are shown in the squared detail. All parts have dowels attached for anchoring them in place, and they all fit in holes in the face except the ears, which slip into staples on the back of the head. The base for the head is a box with the front side painted to resemble the bars of a cage. As shown in the lower, left-hand detail, the head is attached off center to a dowel, which turns in a hole through the side of the box. Washers are used as spacers between the head, box and pendulum, which is fastened rigidly to the end of the dowel

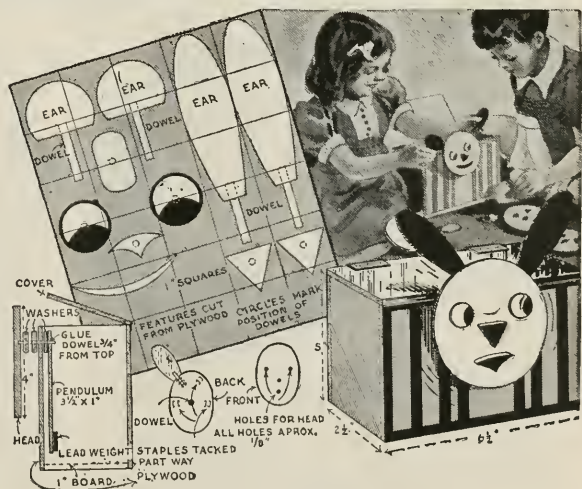

inside the box. The box of the original was painted yellow, bars black and the face white with black features.

of PAINTED WALLBOARD...

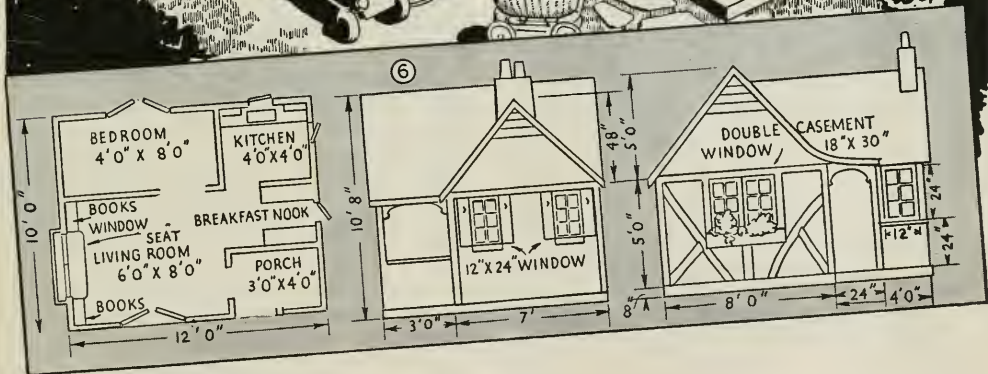
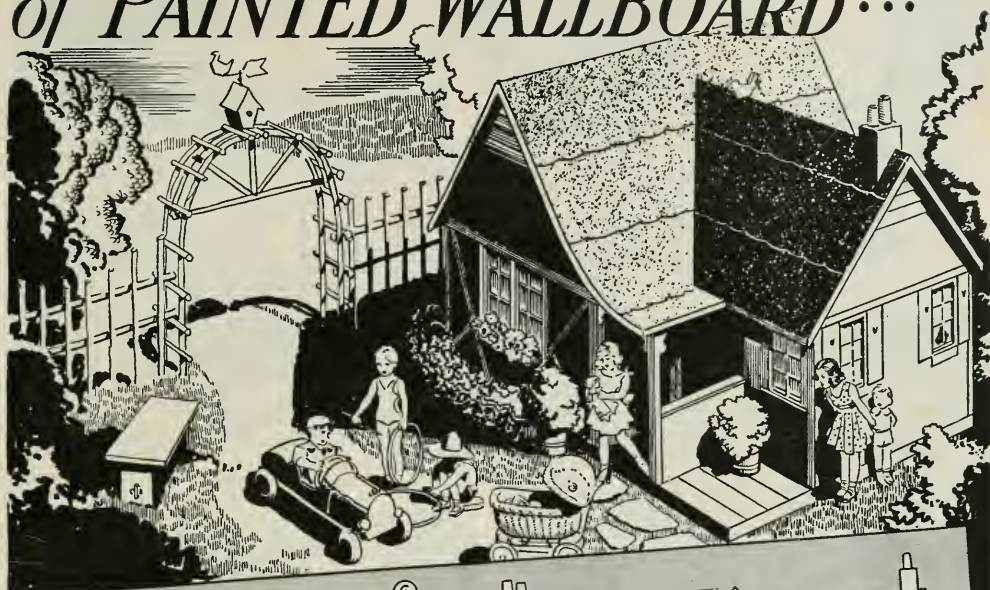

in the elevation drawings, Fig. 6. The distance from the floor to the top of the plate, or horizontal piece across the tops of the studs, is 5 ft., and the peak of the main roof is 5 ft. above the plate. The smaller roof is 4 ft. above the plate. Spacing of the rafters depends on the kind of wallboard used for sheathing. Light wallboard will require rafters fairly close together, while a heavy, stiff wallboard will allow greater spacing. Curved strips are nailed to the rafters and cornice over the tiny porch. After the framework has been completed, install the wallboard roof sheathing and cover with roll roofing, the laps being cemented with roofing tar in the usual way. Timber work is applied over the wallboard on the front of the house. Casement windows, Fig. 4, are easy to in-

stall, the studs and headers forming the window frame. The tapering chimney, Fig. 2, is built up of wood and wallboard, and is nailed to the peak over the completed roofing. Of course, sealing the inside and trimming with battens will greatly improve the appearance of the interior. In this case, cross pieces should join the rafters horizontally about 2 ft. above the eaves as shown in Fig. 5. It is important that the wallboard be painted on the outside to prevent it from absorbing moisture, and it is a good plan to give the inside one coat also, if the house is to be exposed to continued wet weather. In any case, paint the walls before applying the timber work and molding so that they will not become daubed in the course of painting.

A kitchen sink with a drain and running

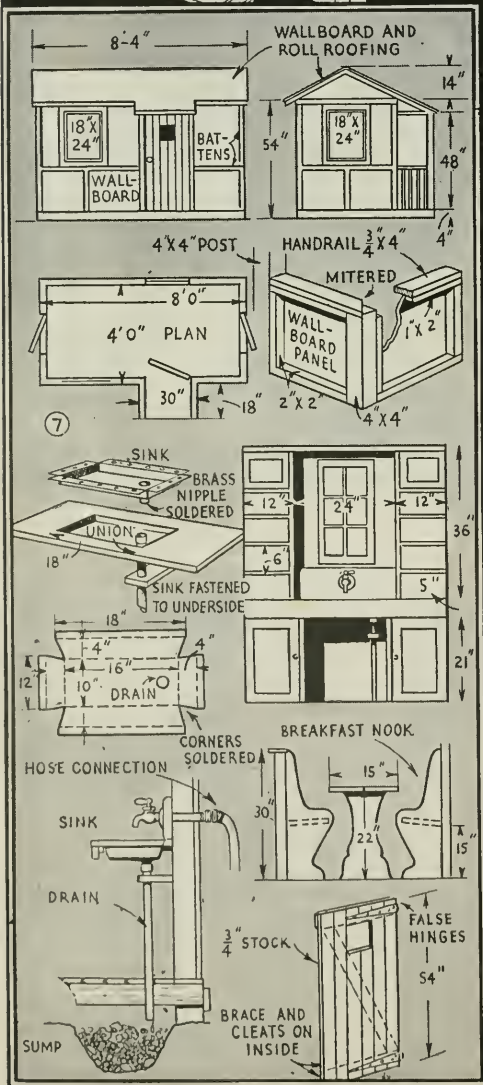
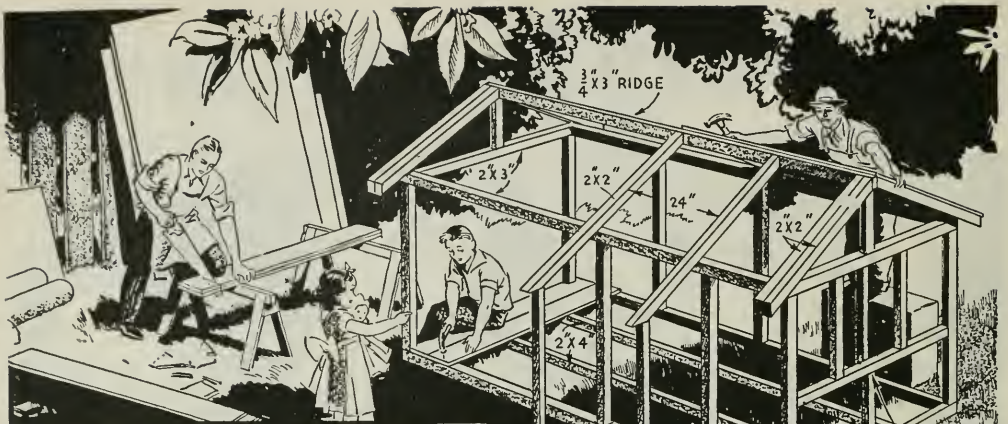

water can easily be made as in Fig. 7. The tap is screwed onto a short length of pipe extending outside the wall, which is coupled to the garden hose. From a sheet of galvanized iron, cut the sink according to the pattern given, bending on the dotted lines and soldering the corners. Also solder a short brass or galvanized nipple at the drain hole. The sink is fastened under the opening in the drain board, and the nipple inserted in a union at the top of a $\frac{3}{4}$ -in. galvanized straight pipe. The nipple sets in loosely, and the pipe, passing through the floor, drains into a hole filled with gravel. The breakfast nook is formed by a low partition and is fitted with fixed seats and a movable table. A front door is easily built of matched boards with a small, glazed window, cleats and diagonal brace on the inside, and false strap hinges on the weather side.

A simpler design of playhouse is given in the upper details of Fig. 7. Note that the windows in the front and rear walls are fixed, while those in the ends are hinged to swing out for ventilation. The little porch with its spindle rail breaks up the angularity of the house, which is decidedly inviting in spite of its low cost. A suggested color scheme for the house is ivory or white walls, dark oak stain on the door, woodwork, molding and window frames, with green roof and shutters. The floor can be stained and waxed.

"Rollicking Rufus" Will Dance Amusing Jigs

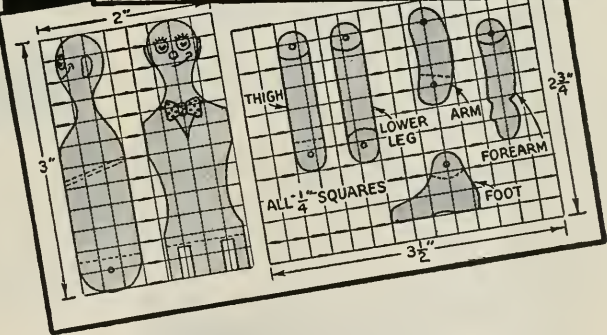
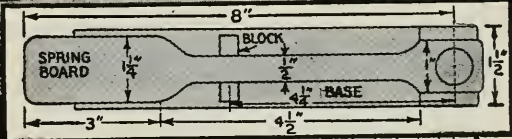
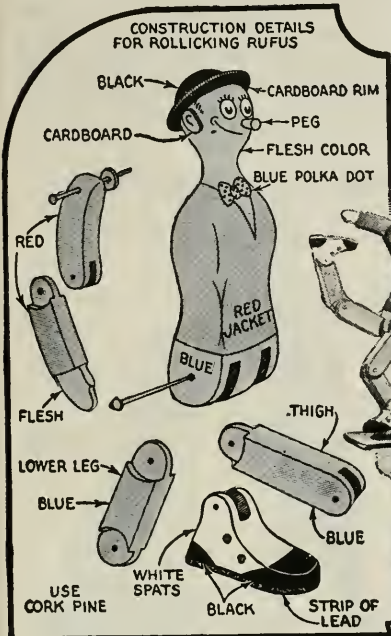

Suspended from a curved length of heavy piano wire, this little manikin will cut amusing capers when the supporting wire is agitated. The base is of $\frac{3}{4}$ -in. wood, and the springboard should be of $\frac{1}{8}$ -in. maple or other hardwood. A screw drawer pull permits adjustment of the rigidity of the springboard. Washers should be put above and below the board. The figure is carved from soft pine. Sizes of the legs and arms, which are pivoted loosely to the body, are given in the squared drawing. Note that a thin strip of lead is fastened to the underside of the feet to bring them down with a "snap" on the springboard. A good paint job makes the figure look quite realistic. Two coats are advisable, one in flat white or gray paint, and the second in the finished color. Flesh tint for the face and hands can be made by mixing a very small amount of red and orange with white. The base should be gray or black and the springboard should be varnished a natural color. When the paint is dry, sandpaper the joints smooth where they rub together and wax them to reduce friction.

Spools and Propeller Make Toy For Air-Minded Youngster

This simple toy will afford a small child many hours of entertainment, and it is easy to make. All you need is a tin propeller, a couple of spools and a length of wire, which is bent as indicated to provide axles for the spools. The propeller is attached to the upper spool and both are belted together by means of a rubber band.

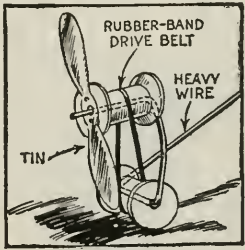

Toy Torpedo Driven to Target by Rubber-Band Motor

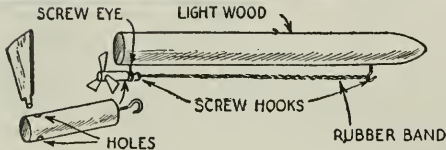

With this torpedo and a toy ship or two, you can stage a regular sea battle. When launched with its propeller spinning, the torpedo approaches its target in a realistic manner. A screw eye serves as a bearing for the propeller, and two small screw hooks take the rubber band, one being driven into the end of the propeller shaft, the other near the front of the torpedo.

Slingshot Target Is Entertaining in the Rumpus Room

You will have a lot of fun in testing your skill with a slingshot if you use a



target similar to the one shown. It is made of canvas or muslin and has a deep metal-ribbed pocket sewed over an opening in the center. This catches the steel ball, which is shot at it, and a second pocket along the lower edge catches the ball if you miss the bull's-eye. A slingshot can be made from a length of metal rod and a strong rubber band as indicated.

Rubber Stirrups on Stilts



Difficulty often encountered in making a pair of stilts is in providing stirrups that are safe and comfortable. Don't overlook the possibilities of using old auto tires for the purpose. You can cut out pieces to the shape shown and nail them to the stilts.

Bearings for Toy Wood Wheels

Pressed into each side of wooden wheels used on homemade toys, large nickel-plated furniture glides drilled through the center provide bearings and neat hub caps. To assure that the holes in the glides will be in alignment and centered perfectly, drill the wooden wheel and the two glides through the center first. Then, using the same drill bit as an axle, slip the glides over each end and press the points into the wood.

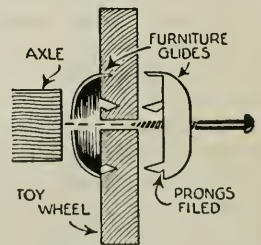

"Juggling Cat" Tosses Ball From Paw to Paw

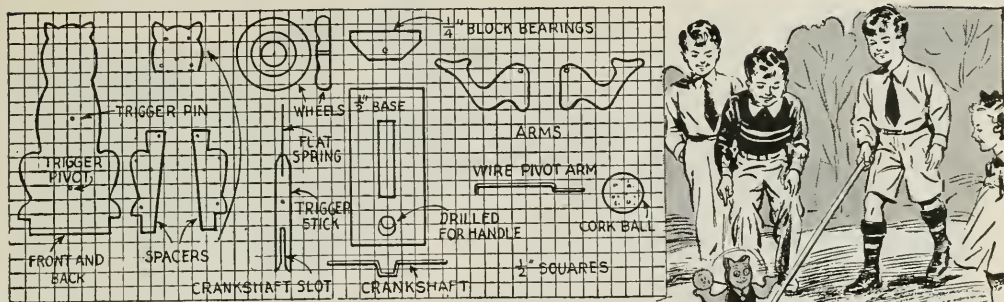

Wheeled across a floor, this cat tosses a cork ball from one paw to the other and it will entertain a small child for hours. Simple construction permits the parts to be cut in duplicate so that you could assemble a number of toys and sell them at a profit. Thin stock is used for the body, which consists of two duplicate parts with spacing blocks between, which are bradded together, leaving sufficient space for the pendulum to swing. This is provided with a piece of clock spring. The pendulum, pivoted on a brad driven through the toy, rides the crankshaft axle and is moved back and forth as the axle turns, snapping the spring strip across the trigger pin. The force of the spring striking the pivoted arms alternately flips them upward in an arc, tossing the cork ball back and forth over the head of the figure. The ball is impaled upon a wire which pivots at the central point of the figure. If desired, you can make the toy to suit the season. A rabbit can be substituted for the cat, and the ball can be replaced with an "egg," to convert the toy into an Easter special.

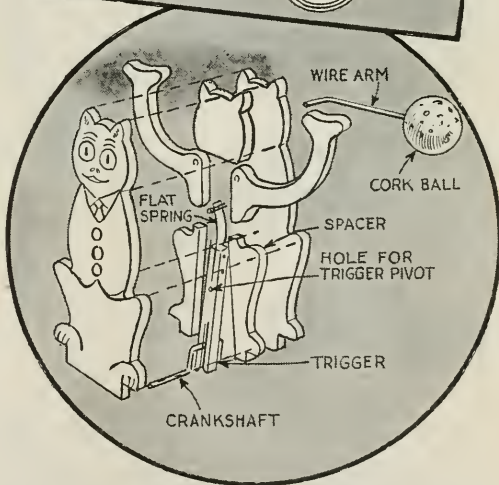
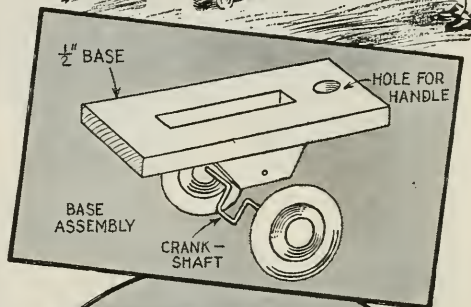

Crossword-Puzzle Fan Pulls Lettered Strips to Find Words

Here's a clever gadget that will help anyone in solving crossword puzzles as it is based on the fact that it is easier for most people to see combinations of letters than it is to imagine them. Twenty-six strips of tough paper, each lettered from A to Z, are slipped next to each other in a holder which has a slotted face through which any selected arrangement of letters can be seen. The width of the strips should be such that they can be slid back and forth individually in the holder.

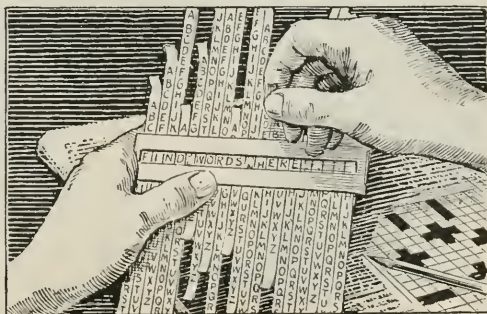

"Running Rastus" Never Tires in the Wind

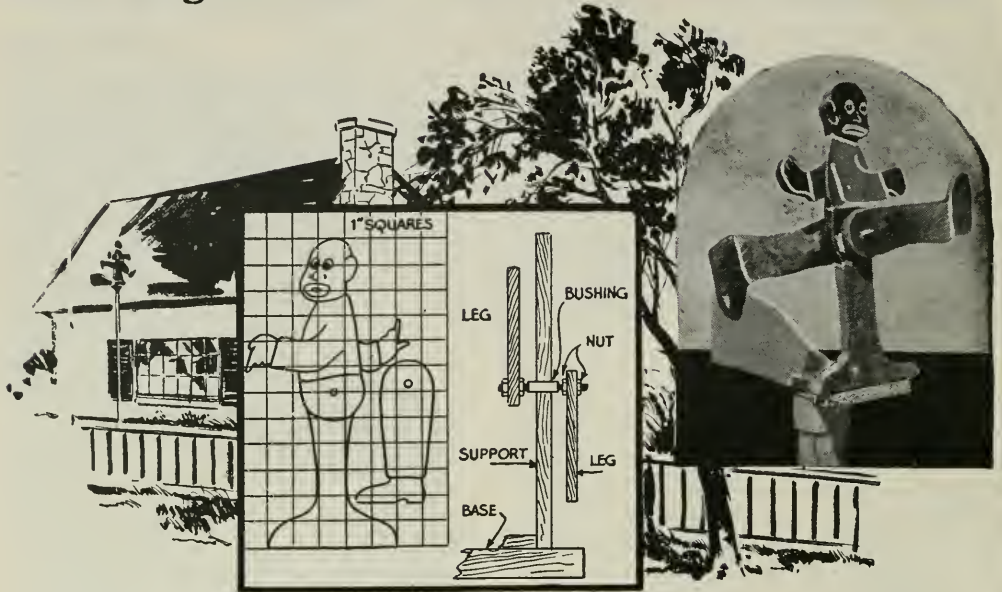

With his legs moving rapidly, "Running Rastus" is an amusing weather vane. Both the body and legs are scroll-sawed from $\frac{3}{4}$ -in. wood, after which the trailing edges of the legs are beveled like the blades of a

toy windmill, which they simulate. In assembling, the legs are locked on the threaded ends of a tiny shaft with nuts, a piece of tubing being inserted through a hole in the body to serve as a bearing.

Midget Acrobat on Toy Windmill Cuts Amusing Capers

Actuating a trapeze performer in a realistic manner, this wind toy will afford you many laughs, especially on a gusty day when the mill runs er-

atically. First get a base for the assembly, which can be a piece of hardwood or light channel iron. Fasten vertical pieces to it to carry the shaft and pulley that rotate the figure. Then provide simple bearings on the base for the airwheel shaft, which is a

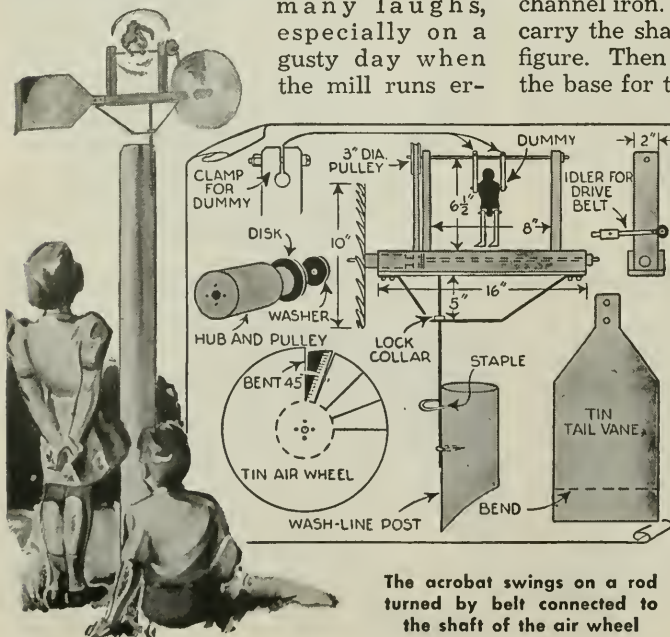

The acrobat swings on a rod turned by belt connected to the shaft of the air wheel

length of brass rod. Next make up the wheel hub and pulley from hardwood, and drill it to take the shaft with a force fit, placing a washer between the hub and shaft bearing to prevent binding. Now you are ready for the wheel, which is a tin disk cut to resemble the wheel on a regular farm windmill. This is tacked to the hub. A tin tail vane is fastened to the rear of the base. Arms and legs of the figure are pivoted loosely to the body, while the arms are clamped tightly to the shaft.

Animated Squirrel Toy Performs Realistically

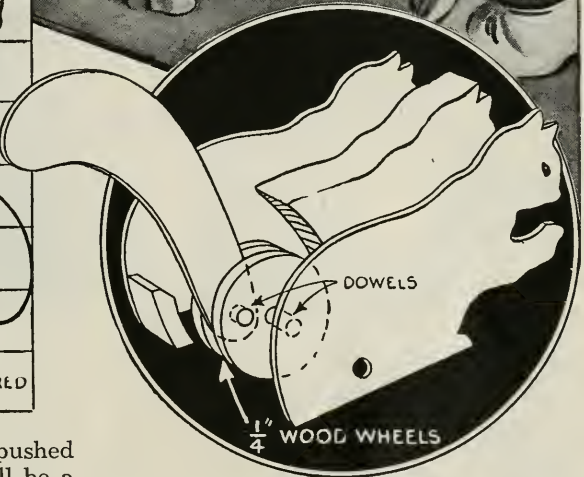
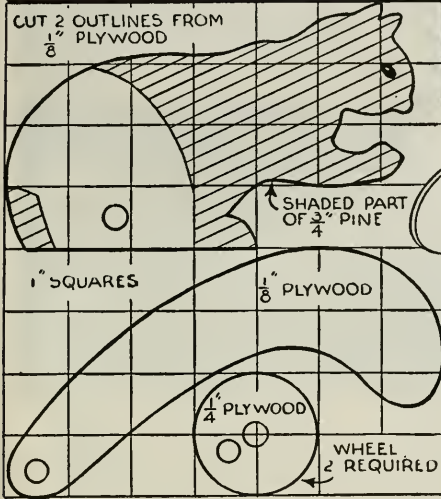
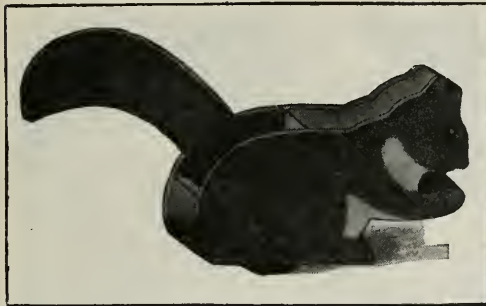

Merrily flipping its tail as it is pushed over the floor, this squirrel toy will be a prized possession of your small child. The two sides are cut from thin wood and are glued to a spacing block shaped and cut out, as indicated in the squared detail, to

accommodate the tail-actuating mechanism. This consists of two wooden wheels or disks having the tail piece pivoted slightly off center between them.

Magic Pinwheel Changes Rotation at Command of Voice

You can have fun mystifying your friends with this trick pinwheel, which changes direction of rotation at a spoken command. The secret of making it spin is in the way the handle is rubbed. Grip the handle and rubbing stick as in Fig. 1 and, with a forward and backward movement, rub the stick over the notches, allowing the index finger to slide along one side as in Fig. 2. To reverse the direction, continue rubbing but lift the index finger as in Fig. 3, and let the end of the thumb nail rub against the opposite side.

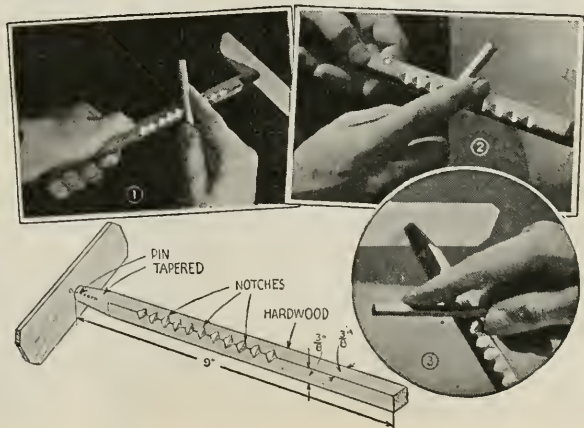

THROW BEAN BAGS FOR FUN

This indoor game looks easy at first sight, but when you try it you'll find it's a game of skill that will hold you for hours at a time. It's something like pitching horseshoes except that the score is made—or lost—by tossing small bean bags through holes cut in a vertical panel. The winning number of points may be decided upon by the opposing teams and the score of the individual players recorded on the score board provided

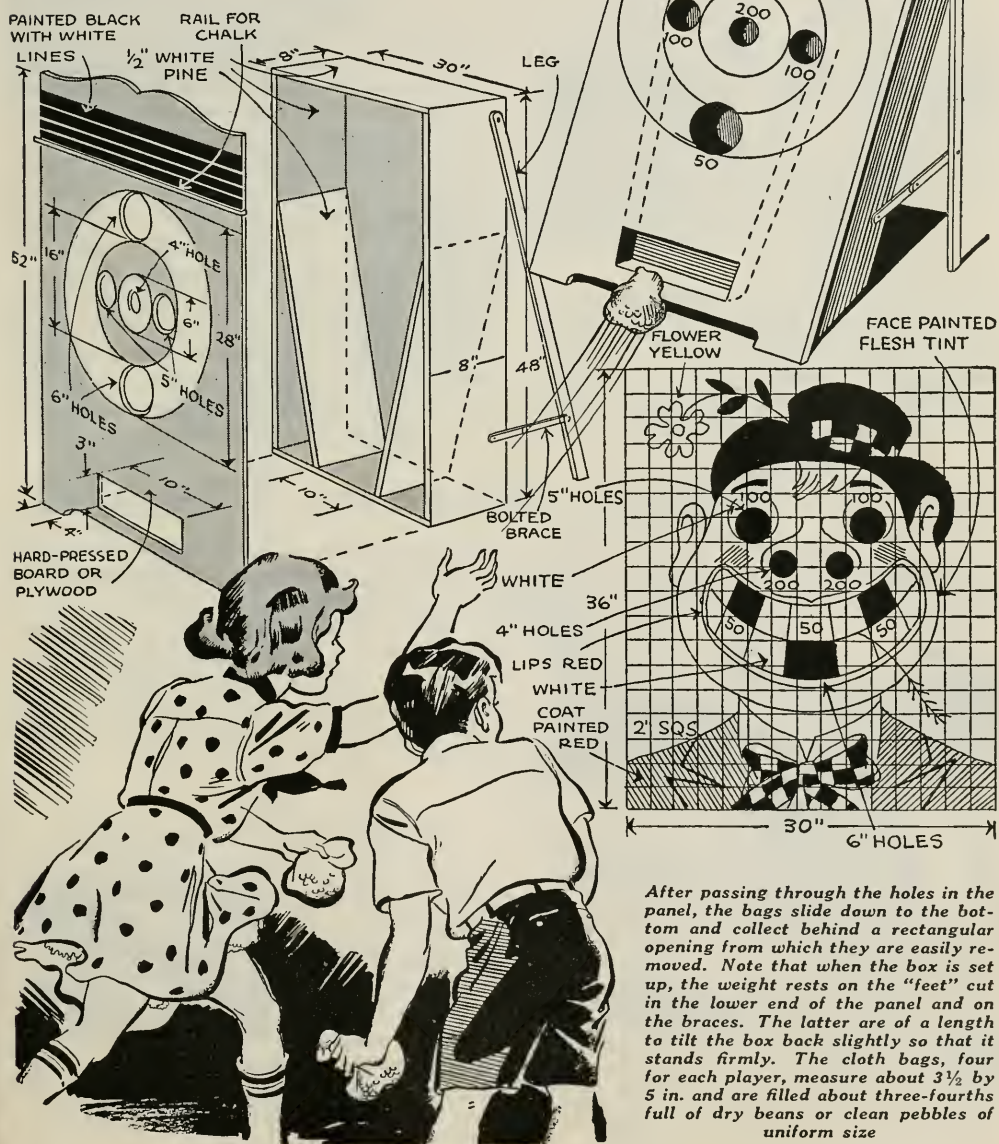

Toy-Train Signals Operate on Flashlight Cells

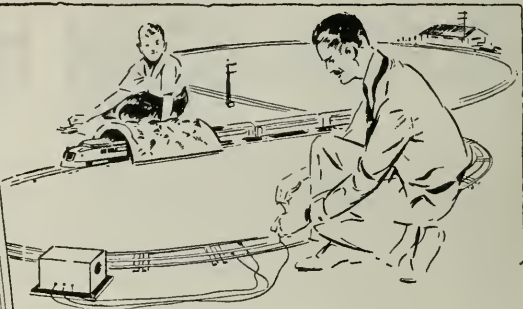
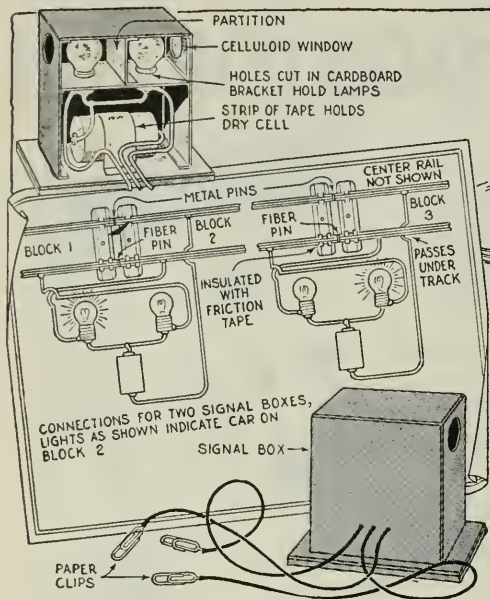

These inexpensive toy-train block signals are operated by flashlight cells so that they are suitable for electric or spring-wound trains. Each signal is a self-contained unit, and consists of one cell and two lamps inside of a cardboard box, which

is assembled with paper tape. The lamps are 1.25-volt flashlight bulbs in regular flashlight sockets. The connections of each box are reversed across the pin, which breaks the connection between the rails of adjacent blocks so that the lamp controlled by any block faces the other block. Three or four sections of track provide a block of about the right length. One of the rails is insulated from the ties by friction tape. All the insulated rail sections in each block are joined by metal pins, and the connections between the blocks are made with wood or fiber pins. All wire connections are soldered. However, if removable connectors are desired, paper clips soldered to the ends of the wires are convenient.

Where Does the Extra Square Come From in This Puzzle?

Does it seem possible to take a piece of heavy cardboard 8 in. square, lay it off in sixty-four 1-in. squares and then cut it

into three parts, which are then arranged in a rectangle having sixty-five squares? That is what apparently happens if you cut the cardboard as indicated in the upper detail and then arrange it as shown in the lower one. The secret is that while the three pieces appear to fit together closely, there is enough space along the three joints to equal a square inch of surface.

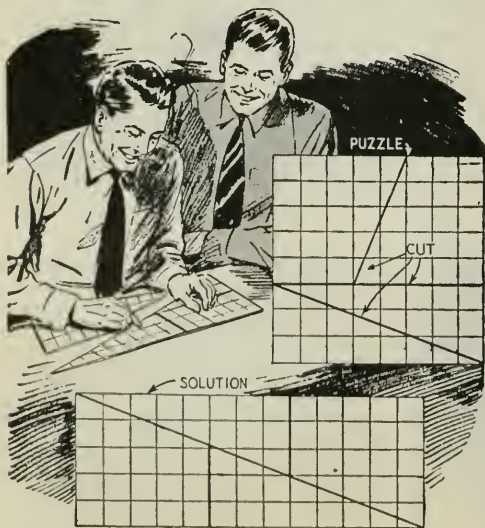

Simple Model-Train Hitch

In building a model train the difficulty in getting a hitch that is rigid, yet allows sufficient freedom for the cars to move around on a curved track, is solved by using ordinary snap fasteners such as used on garments. Both sections of a fastener are attached as shown.

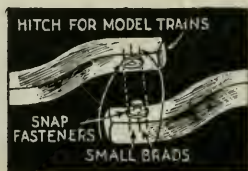

Jigging Puppet Uses Your Fingers for Legs

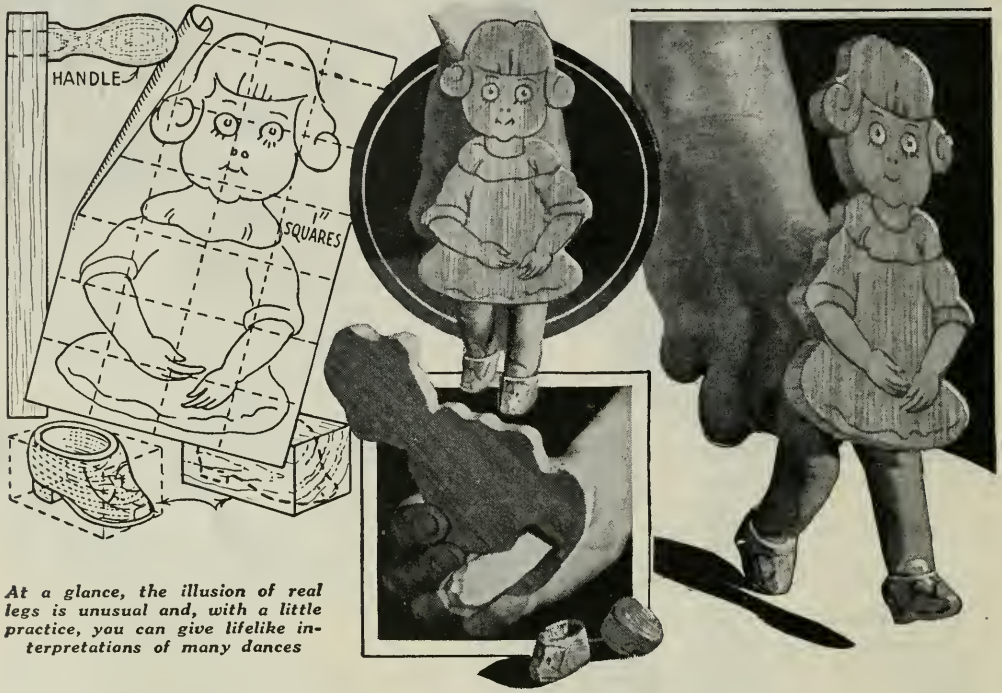

At a glance, the illusion of real legs is unusual and, with a little practice, you can give lifelike interpretations of many dances

Just a simple jigsawed cutout of $\frac{1}{4}$ -in. plywood, with hands and face outlined in pencil on one surface, this doll walks with the aid of legs formed by the first two fingers of your hand. Two shoes are carved from small blocks of wood and recessed

to fit tightly on your finger tips. A short handle glued to the back of the doll, as shown in one of the photos, wedges between the fingers and supports the figure. Hands, arms, face, eyes and clothing are easily outlined with black paint.

Toy Cannon Shoots Rubber 'Shells' for Lead-Soldier Army

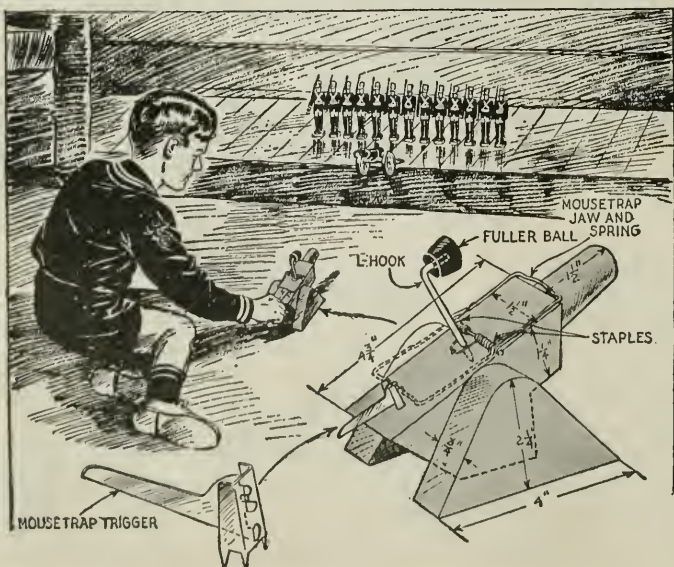

Firing point blank at an advancing army of lead soldiers, this cannon will provide endless fun for any small boy playing at army maneuvers. The cannon is harmless because all it does is toss a fuller balls, a supply of which can be obtained from almost any hardware or dime store, across the room when the trigger is pulled. It is made of pine and the operating mechanism consists of the jaw, spring and trigger of an ordinary five-cent mousetrap which are assembled on the cannon as shown in the drawing.

Toys That Move *by magnetism*

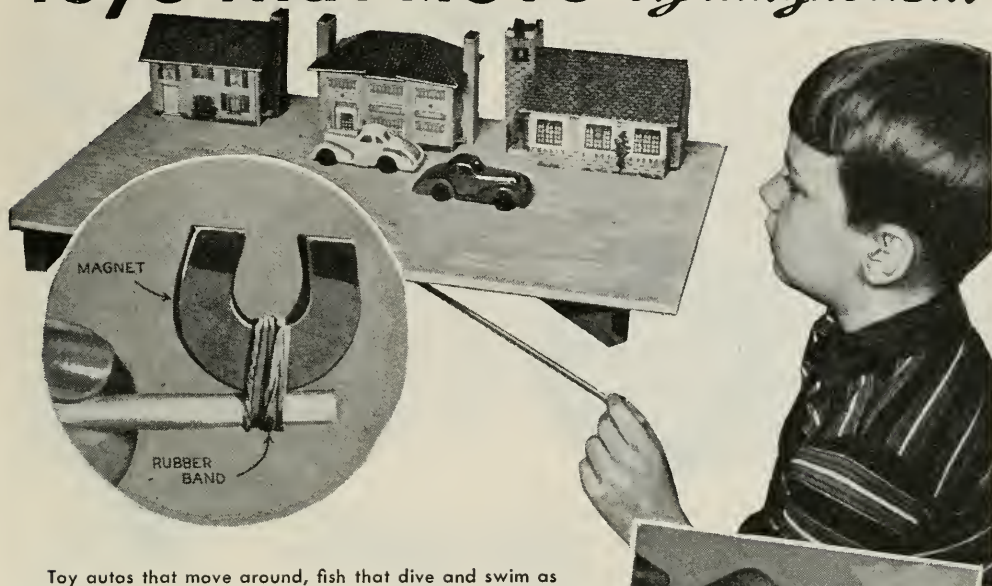

Toy autos that move around, fish that dive and swim as though alive and boats that mysteriously follow the wish of the young performer, are just a few of the many stunts that you can do in this unusual table-top theater. The cost is slight, as you get ten-cent models or make them from wood, and use permanent magnets. By attaching a magnet at the end of a dowel, you can hold it anywhere under the "stage," or you can hold the magnets by hand if there is enough space. The magnet and your movements can be concealed from spectators by closing the front side of the stage. If models are wood, plastic or other nonmagnetic material, a strip of iron or steel is cemented on the underside

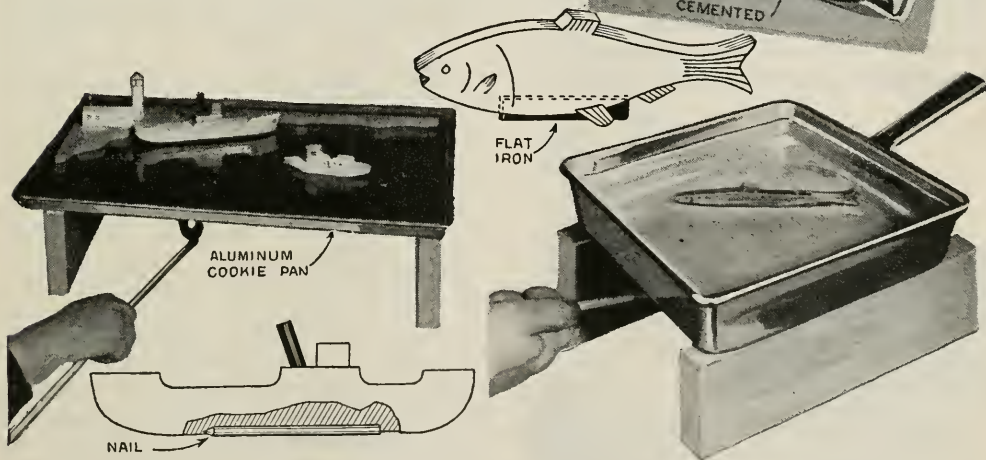
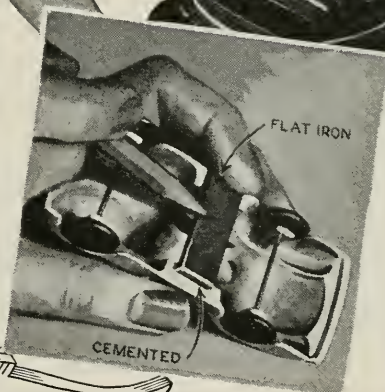

To move objects on or in water you get an aluminum pan of sufficient size and depth, because aluminum is nonmagnetic. A sheet-metal pan would cause the magnet to "stick" to it inconveniently, and the boats and fish would not respond. Two persons can conduct a lively naval battle, causing the opponent's "destroyers" to be "sunk" and removed from the game by ramming them amidships

Toy Balloon Coated With Rosin Is Halloween Noise Maker



Safe and effective, this noise maker is simply an inflated rubber balloon sprinkled with powdered rosin. When this is rubbed against a windowpane it will produce noise without danger of breaking the glass.

Bomb Rack for Toy Airplane Drops Objects in Flight

You can have a lot of fun "bombing" if you fit your model airplane with a bomb rack of the type shown. The rack, which is intended for airplanes operated by rubber-wound motors, is a piece of wire bent to a U-shape, run through a cross member of the fuselage and then bent at right angles

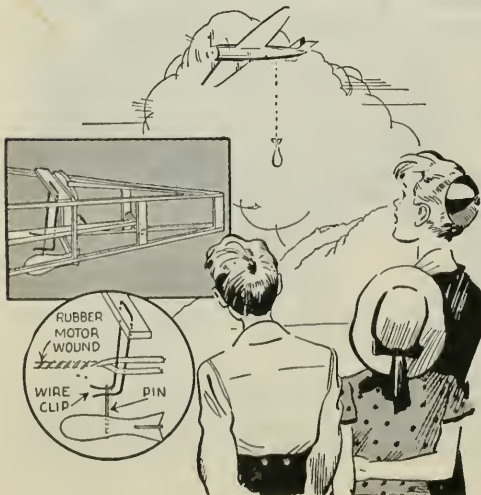

near the ends. The wire is inserted between the rubber strands of the motor so that when the latter is wound, the strands twist and press the ends of the wire together to grip a pin pushed into the bomb or other object you want to drop. As the motor unwinds in flight, the wire ends spread and release the bomb, which then falls in a realistic manner.

Christmas-Tree Lamps Illuminate Model-Railroad Signals

You can assemble model-railroad signals from Christmas-tree lamps, two of which are shown. The flashing danger signal at the left is made of light wood and a lamp and socket are clamped to it and wired to the track, a flasher that is used on the tree lights being installed in the cir-

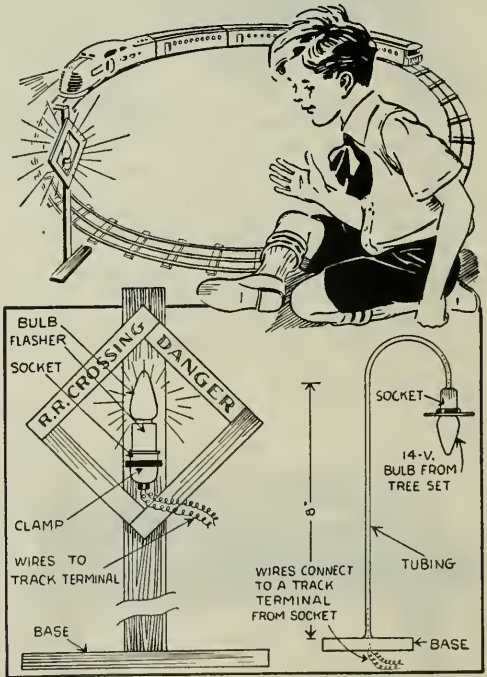

cuit to flash the lamp. The station lamp at the right is a length of small copper tubing soldered to a base and fastened to a socket and lamp, the wires being run through the tubing to the lamp. By doing a little planning and experimenting many other types of realistic-looking signals can be made in a similar manner. As most lamps used on Christmas trees work on 14-volt current, you can use the regular train transformer to operate the signals.

Midget Skiers Jump When Targets Are Hit

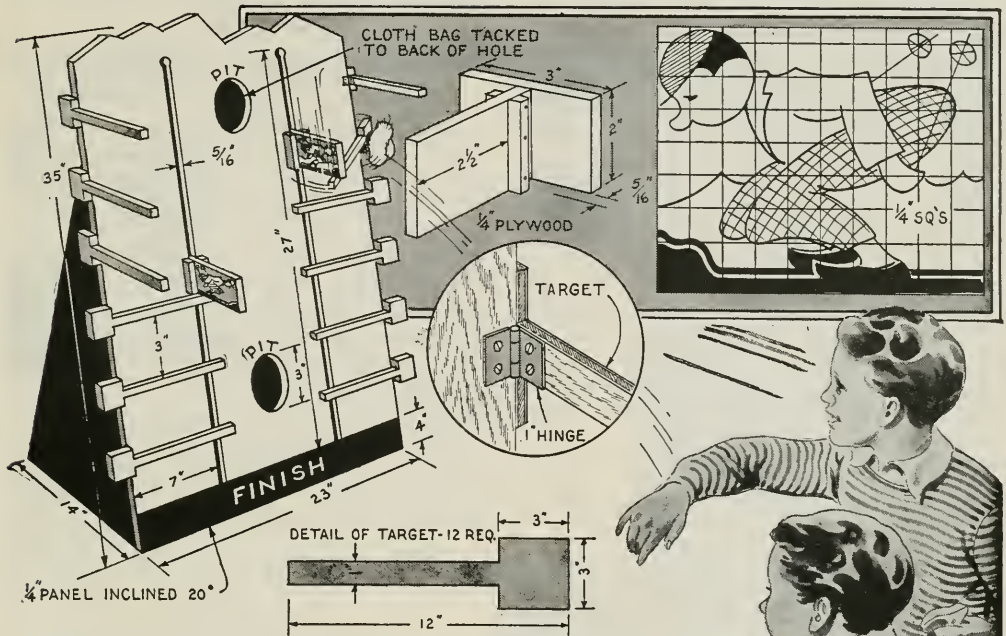

Every member of your family will have fun with this game in which a series of targets must be hit progressively from top to bottom with a bean bag to move indicators to the finish line at the bottom. The players alternate their throws, each one throwing two bean bags. If a player throws a bag into one of the pit holes, he forfeits his next turn at throwing. The game consists of a plywood panel having six targets hinged to each outer edge as indicated in the circular detail. The two indicators slide in slots in the panel and have figures of a ski jumper painted on them. As the indicators must slide easily, it is a good idea to lubricate the grooves with soap or paraffin.



Dashing Barrel-Body Chariot Thrills the Backyard Warrior

Here's a chariot you can make that will provide lots of fun for you and your friends. All you need is a barrel and a pair of wheels from a coaster wagon or even an old baby carriage. Cut the barrel as indicated and put reinforcing strips of flat iron inside the barrel opposite each hoop, screwing both the hoops and the strips to each stave. The axle of the wheels is mounted on the barrel bottom with iron brackets, after which the tongue is attached as indicated. It's a good idea to sandpaper all of the edges carefully to avoid any possibility of splinters and then give the chariot a couple of coats of bright-colored paint.

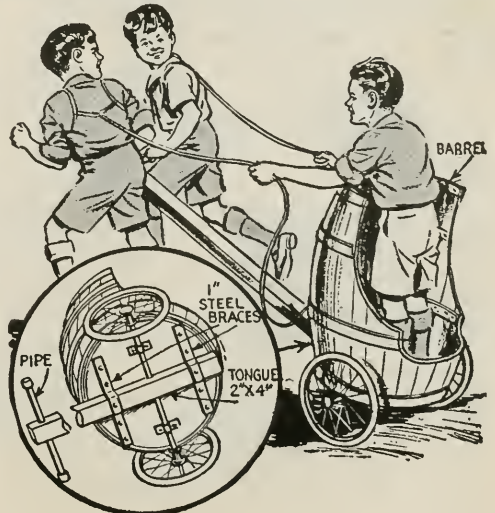

☛ A toe of an old shoe tacked to the floor board of a scooter will keep your foot from sliding off.

Microscope Slides Supported by Soda Straws



When using a microscope, place a couple of soda straws on a bench near by so that you can lay the slides on top of them as shown in the photograph. This not only protects the specimens on the slides against damage when laid down, but also enables you to pick the slides up easily.

Safety-Razor Guard Used as Rack for Microscope Slides

A guard or comb from a double-edged safety razor is a convenient holder for microscope slides. The slides fit between the prongs, which can be bent slightly to hold them firmly. With the slides placed in order, they will collect fewer fingerprint or dust smudges than if they were put in a box or laid flat on a table.

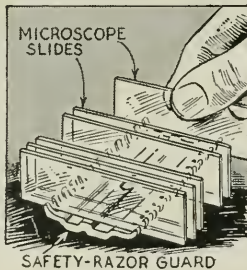

Lots of Fun With Microscope Made From Spool

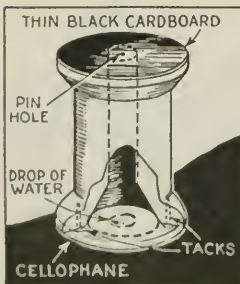

By using a well-known optical principle, with but slight effort you can make an instrument capable of magnifying certain objects considerably. Take an ordinary thread spool, enlarge the bore in one end and paint the inside surface black. Glue a piece of black cardboard over the top and pierce with a small needle. On the bottom tack a disk of Cellophane. Place a drop of water on this and lay a fly's wing or other

thin, transparent object in place. Hold before a strong light and look through the pinhole.

Micro-Reflector Aids in Sketching Specimens Under Microscope

Biology students and microscope fans will find that this reflector eases eyestrain while sketching a magnified specimen, as the image of the latter is reflected on a ground glass, making it unnecessary to look into the eyepiece of the microscope. The reflector is a light-tight box, about 3 by 4 in., containing a mirror on the inside as shown. An opening in the bottom of the box fits snugly over the microscope eyepiece, and has a camera lens at the upper end to direct the image on the mirror.

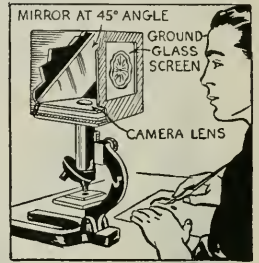

Color-Filter for Microscope Is Adjustable

Any one of four colors or combinations of the four, for use with a microscope, is available with this filter. It consists of two $\frac{1}{8}$ -in. plywood disks, which have four corresponding openings over which pieces of colored Cellophane are glued. The disks are pivoted to a suitable support by means of a brass rod, and are separated by a thin washer as indicated.

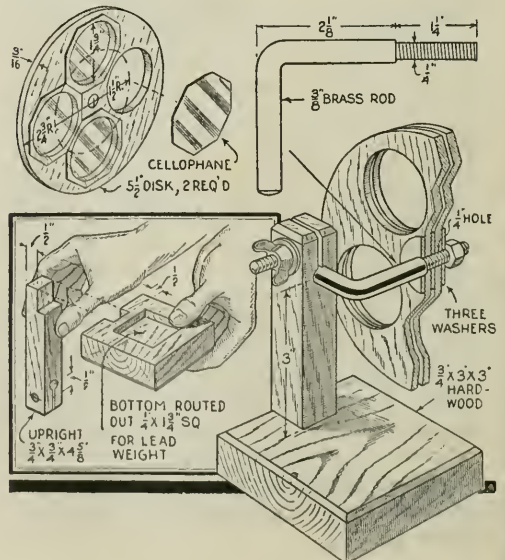

Game-Fish ASH TRAY

proves the story

By L. IRWIN DUPUY

WHILE the thrill of catching a big fish lasts only a few minutes, the pleasure of reminiscence, or telling your friends about it, can last for years if you mount the head to serve as a paperweight, penholder or ash tray, Fig. 1. When removing the head, it's best to leave about 2 in. of the skin on it. If you forgot to do this, the skin can be imitated with plaster of paris. After as much flesh as possible has been removed, the mouth is propped open with a stick so that it resembles the one in Fig. 2. Then it is placed in a bucket or can of 5 per cent-formaldehyde solution, Fig. 3. It should be left in this solution for at least 3 days, or it can be left until ready for use.

When you are ready to mount the head, it is taken out of the solution, rinsed in running water as in Fig. 5, then dipped in denatured alcohol, Fig. 4, and hung up to dry. After it has dried, which will only be a few minutes, it is given a coat inside and out of water glass, Fig. 6. When dry, a second coat is applied. When this

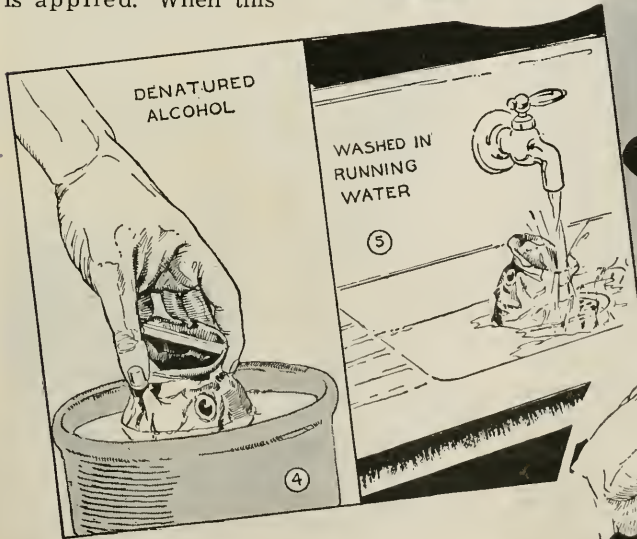
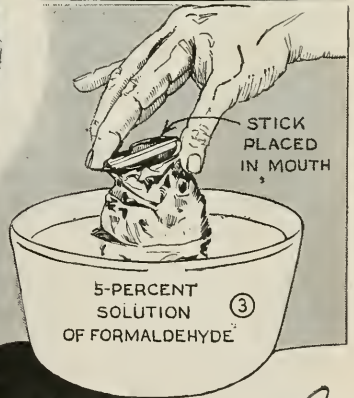

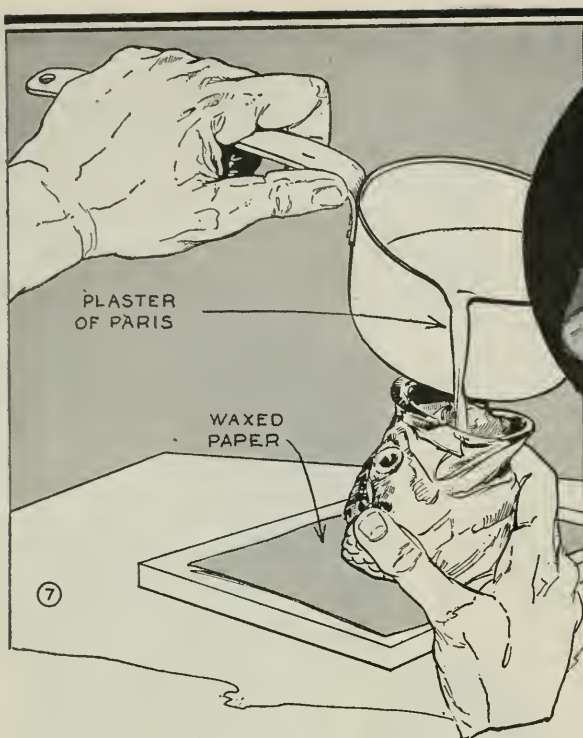

has dried, the head is given a coat of quick-drying clear varnish, which is repeated in a few hours. As soon as the second coat of varnish is dry, the head is ready for a base, which can be made of plaster of paris.

Twist a 3-in. length of small wire to the backbone in a position where it won't show, but so it will go into the base material. The head is then placed on a piece of waxed paper on a flat surface and the plaster of paris is poured in through the mouth, Fig. 7. When the plaster is about $\frac{1}{2}$ to $\frac{3}{4}$ in. deep, it is spread out on the inside and smoothed up on the outside in any place where it pushed through. If the head was cut off too short and no skin was left to cover the back of the neck, the plastic material is built up to fill these places. When the plaster is almost dry, artificial scales are worked in with a sharp instrument to make it look natural. Place a small piece of plaster for the tongue as this improves the inside of the mouth. The name and date can be cut before the plaster gets hard, either inside the mouth or on the back of the base.

Fill the eye holes with the same base material and set the eyes in this. Artificial glass eyes are not expensive and make a neater job, but buttons of the proper size



and color can be used if a black dot is painted in the center of each one. When the plastic is dry, give it two coats of clear varnish. If the plaster shows, or if there are any light spots on the head, they can be touched up with a mixture of black and medium-brown oil color in a few drops of clear varnish to match the rest of the fish.

Don't forget to paint around the eyes. Next, mix a little medium-green in oil with varnish and apply this as dots with a small piece of cotton on a stick. While still damp rub over this with a cloth that will not shed lint, to give it a natural greenish color. The inside of the mouth is rubbed with a light flesh color in varnish. The tongue and the surfaces around the teeth are painted with a darker flesh color to brighten up the inside of the mouth. Fig. 8 shows the completed head.

Steel-Tube Case for Fishing Rod

Fishing rods of the one-piece type may be protected against rough handling by inserting them into a length of thin-wall steel tubing. These are cut to the required length and both ends are closed with rubber crutch tips, which may be purchased at a dime store.

—John C. Michalek, Kansas City, Mo.

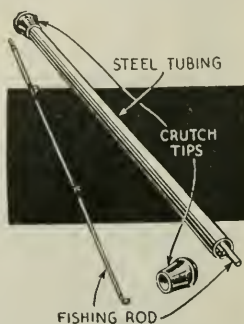

Quick-Acting Fly Vise Holds Spool and Thread

This inexpensive fly vise consists of a dime-store metal clamp mounted on a slanting arm, which is in turn screwed to a wood base. The jaws are rounded at the ends with a file and are drilled partly through from the inside surfaces to take a spring, which spreads them as the tightening screws are loosened. When purchased, the rear screw does not pass entirely through both jaws. This screw hole is drilled out so that both screws can be driven in from the same side. Also, two small holes must be drilled in one jaw to mount the clamp on the supporting arm. A wooden peg set in the base holds the thread spool, and a tightly coiled spring mounted between two wood-

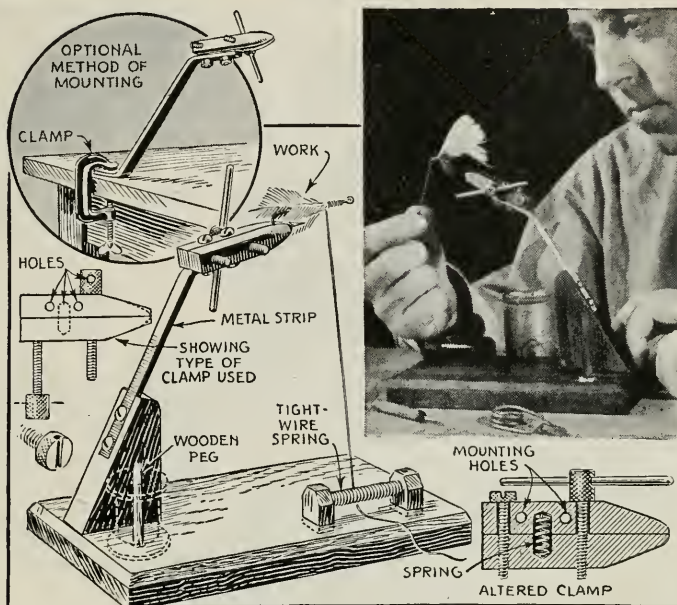

en brackets on the base serves as a holder for the loose end of the thread.

—Fred Howard, Chicago.

Ice-Fishing Semaphore Shifts Balance When Line Is Pulled

Many ice-fishing signals move or wag only when the fish jerks at the line and then return to their normal position. This one, however, continues to show that there has been a bite, even after the line has

again become slack. A 1-in. crossarm having a numbered tin-can lid at one end, is pivoted in a balanced position on a vertical support, which is driven into the ice. A slot is cut in the center of the crossarm to take a steel ball, which should be free to roll in the slot after two pieces of sheet metal are tacked on either side to retain it. A spool to wind the line is fitted in a cutout in the vertical piece, and the line is threaded through screw eyes as shown. When the fin end of the crossarm is pushed down, the ball rolls toward this end and its weight keeps the crossarm in this position. When a fish tugs at the line, the other end of the arm goes down so that the ball rolls toward the latter end and keeps the crossarm in this position.

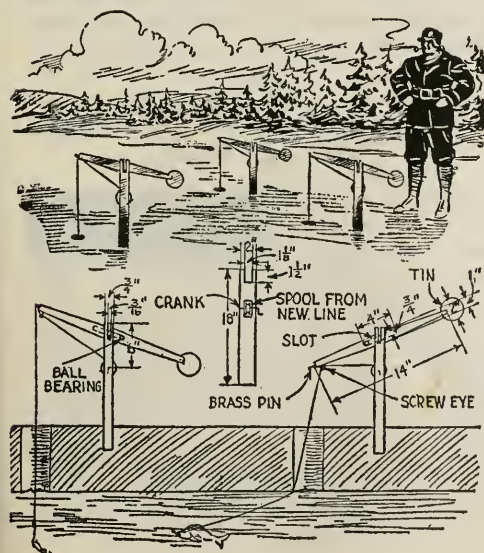

☐ The problem of drying flies is solved by one fisherman who puts them in a bottle of alcohol, inserts the cork and shakes the bottle. The alcohol absorbs the water quickly and evaporates almost instantly when the hook is exposed to the air.

Box for Live Bait in Rowboat Is Under Hinged Seat

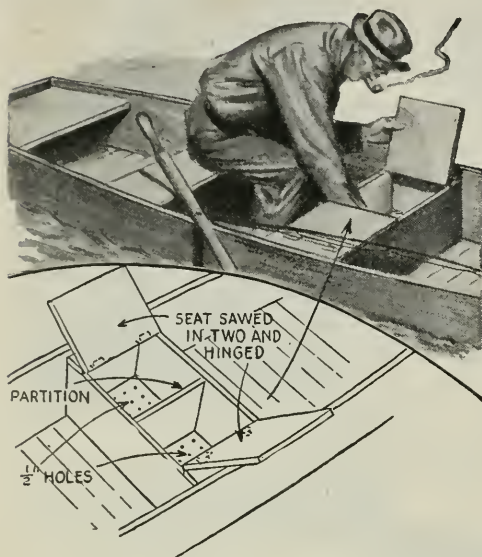

Two watertight bulkheads under the middle seat, and holes bored in the bottom provide a bait well where the water is always cool and fresh. Paint with white lead and linseed oil and calk the joints with marine glue.

Fishhook Holder Is Waterproof

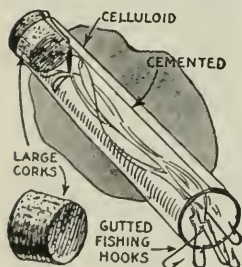

A piece of clear sheet celluloid rolled to form a cylinder and cemented together with acetone provides a handy holder for gutted fishhooks. Such a holder, when plugged at the ends with corks, is waterproof, will not sink if dropped into the water, and is transparent so that you can see the hooks.

Firm Angle Worms Assure a Big String of Fish

When using angle worms for fish bait, anglers will find that trout and bass are more apt to strike them if they are kept fresh and firm. This is best done by lining the bottom of your bait box with swamp moss, which can be found in marshy woodlands. If the moss is not available in

the woods, it can be obtained at your nearest florist. After covering the bottom of the bait box with moss, dampen it, place the day's supply of worms inside and cover them with more moss. The worms will be firm and fresh when the stream or lake is reached and they will remain in good condition for a full day's fishing.

Shotgun Shell Holds Paraffin to Wax Fishline

A handy method of waxing your fishline to preserve it, is to carry a discharged shotgun shell that has been filled with melted paraffin. A deep slot in the end of the shell permits the line to be drawn over the wax quickly.



Safety Pin Holds Fishhooks



Fishhooks can be kept from getting tangled and scattered around by just stringing them on a safety pin. Pins of various sizes may be used in proportion to the number and size of hooks carried, which can be taken off one at a time as they are needed.

Loop in End of Line to Change Fishhooks Easily

When it is necessary to change hooks or plugs frequently while fishing, the following kink will save time: Double the line at the end and tie it in a knot,

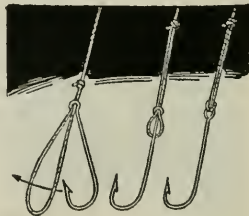

forming a loop large enough for the hook or plug to slip through. Then thread the loop through the eye of a hook, pass the hook through the loop as indicated, and draw the line tightly.

Bracket to Attach Outboard Motor to a Canoe

This simple bracket will enable you to attach an outboard motor to your canoe or kayak for swift transportation without arduous paddling. Outboard motors of $\frac{3}{4}$ to 2 hp. are sufficient for powering the average canoe. The bracket consists of a length of pipe fitted at one end with a hardwood block bolted in place to serve as a motor mount. L-hooks to fit under the gunwales attach the bracket to the boat.

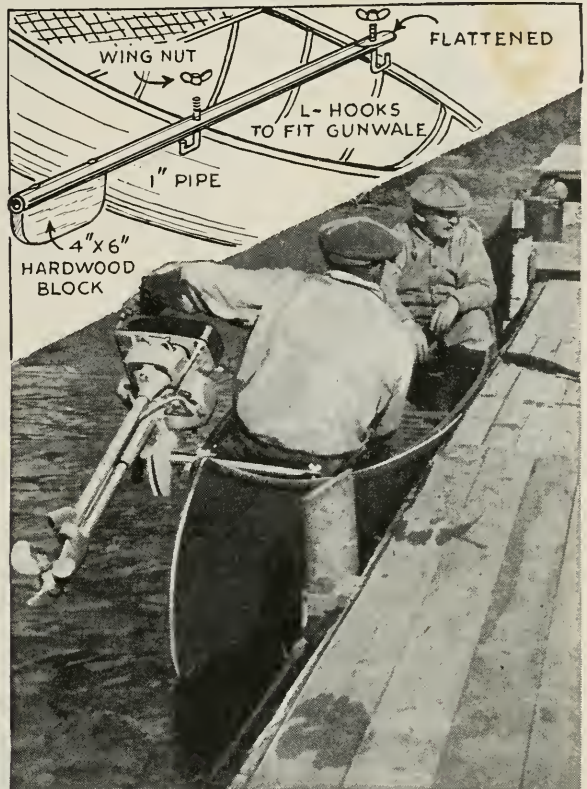

Screw Eye Removes Caps



If you are on a picnic and have forgotten a bottle-cap remover, one can be improvised from a screw eye. Usually a screw eye can be found in

some of the car tool kits. Open the eye and drive the screw into a board. If a file is available, bevel the end of the eye so it will slip under the edge of the cap.

Hiker's Tepee Tent Folds Into Light Bundle for Carrying

This novel tent was used several seasons by a woodsman. It is set up around a tree trunk, which serves as a center pole so that all the hiker carries is the canvas and the drawstring or top cord. The tent consists of several segments sewed together tepee fashion with a ground diameter of

10 ft. and a center hole that can be opened to 10 in. To keep the canvas taut, a number of small rope loops are sewed to the lower edge, through which small saplings are run and the ends lashed together.

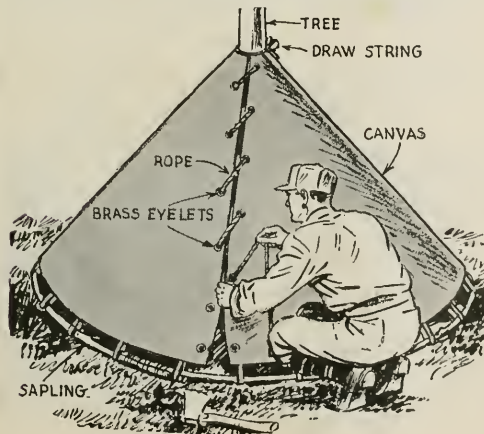

Simple Way of Tying Boot Laces When Walking Through Weeds

To keep the laces of your high-top shoes or boots from becoming untied when walking through weeds and brush, tie them as shown. Loop the ends of the laces and insert them through the upper eyelets of the shoes. Then pass opposite ends of the laces through the loops and pull them up tightly.

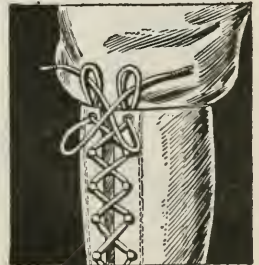

This Improved "Camp Stove" Smothers the Fire



To avoid starting forest fires by careless handling of a campfire, one sportsman recommends this stove for campers who stay only a short time in one place. It consists of two or more iron rods supported on rolls of sod, which are turned back to provide a bare spot for the fire. When finished with the fire, the rods are removed and the sod is rolled back into place, covering the coals and effectually smothering all flames or sparks that may remain.

Picnic Luncheon Cloth Is Held by Clothespin in Ground

The next time you go on a picnic, sharpen five or six regular clothespins and take



them along. They are ideal for anchoring the corners of the luncheon cloth to the ground to keep wind from blowing it about. Just twist each corner of the cloth, insert it between the legs of a clothespin and push it into the ground at an angle as indicated in the circular detail.

Camp Stove Improved from Pail

You need only a 5-lb. lard pail and an empty can to make a good outdoor stove. Punch a number of holes in the pail, then put a few pebbles in the small can to weight it down. Fill it with either gasoline or wood alcohol and set it inside the pail. Ignite the fuel and place your cooking utensils on top of the pail, which acts both as a holder for the utensils, and a windbreak for the fire.

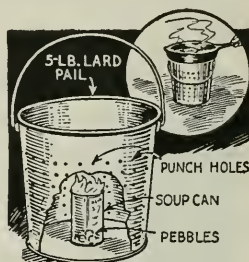

Self-Extinguishing Camp Candle

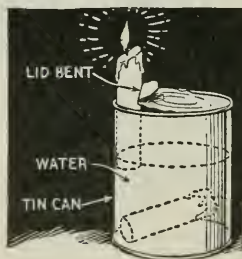

To leave his candle burning so that it will safely extinguish itself at any estimated time, one camper inserts the candle in a tin can and presses the cover against it to hold

it erect. As soon as the candle burns down to the cover, it drops into the can, which is partly filled with water.

Crotched Stick Driven in Ground Serves as Camp Bootjack

Campers who wear rubber boots will find that a crotched stick will serve as bootjack to remove them. Use a strong stick and drive it into the ground at an angle as indicated in the drawing.

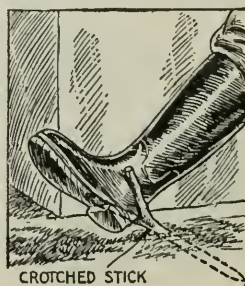

Six Wieners Roasted at One Time In This Wire Holder



Instead of impaling a wiener on a pointed stick and roasting one at a time, use a wire holder like the one shown and save time. There will be enough "spring" in the bent wire to grip six wieners firmly, and there is no possibility of the holder burning off and dropping the wiener into the fire. With two or three of these holders, wieners for a large group can be roasted.

Outdoor Fireplace Covered With Top of Old Stove

Before building your outdoor fireplace get the top from an old iron cookstove to use as a cover. Then put up the fireplace to fit it. With the stove top, the heat is even on all parts of the cooking surface, smoke



goes up the chimney of the fireplace, and pots and pans are protected from soot and blaze of the fire. Cookstoves or tops of old stoves can usually be picked up in the country or at a local junk shop for almost nothing.

Keeping Rain Out of Tent

During long steady rains, water sometimes enters the ridge-pole openings of a tent. To avoid this, cut disks from an inner tube and impale them on the steel spikes that project through the holes.

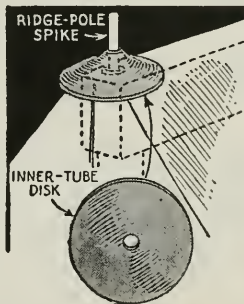

Keeping Ants Out of Lunch Box

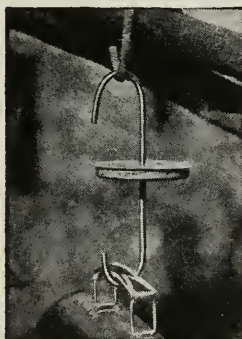

If you have had ants get in your lunch box, here is a hanger that will keep them out. It is nothing more than a length of heavy wire with hooks bent on both ends and a compression can lid soldered in the center. After you hang up the box as

shown in the photo, fill the can lid with water. If ants crawl down the upper part of the hanger, they will not cross the water to reach the box.

Twig Holds Sandwich Plate Leaving Hands Free

The next time you are having a picnic lunch you can have both hands free by supporting your plate on a sharpened twig, pushed into the ground. The plate is punctured so that it can be slipped over the twig and is supported on two or three cut-off sprigs.

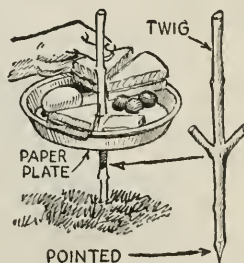

DESIGNED

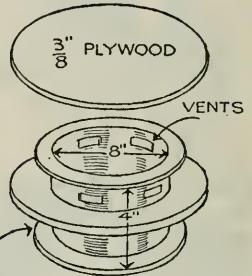
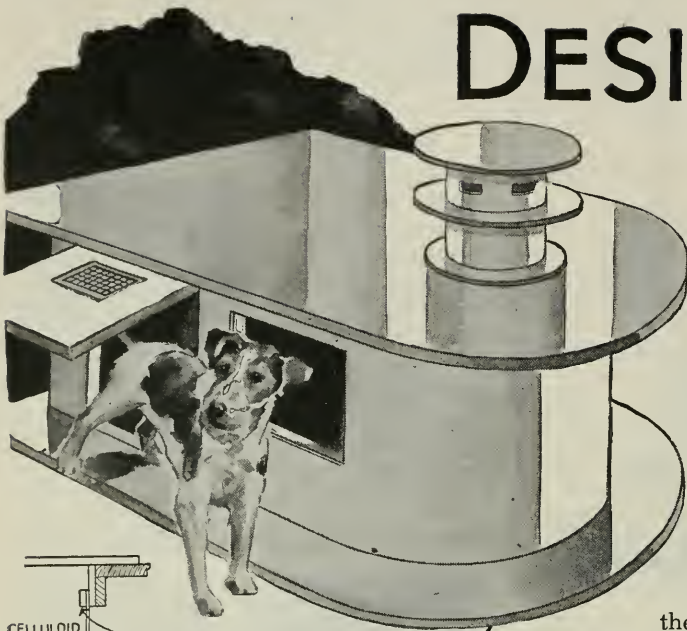

GALV. SHEET-FLANGES SOLDERED ON

CALL them just plain doghouses if you will, it's certain your dog will be quick to show his appreciation of any one of them, and that in his own way. Most dogs won't be fussy about the architectural details; even canine aristocrats are not likely to turn away from a barrel house or a box with a lean-to roof, provided it's warm and clean. Looking at any one of these designs you will see that they fill the latter two requirements without even considering the degree of ornamentation on several of them. Taking the various designs left to right, the first one at the upper left is a rather showy affair of a distinctly modern type made of plywood and hard-pressed board. The detailed view at the left shows you how to

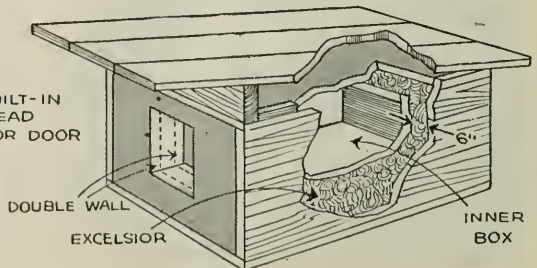
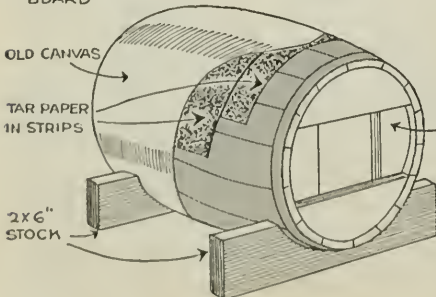
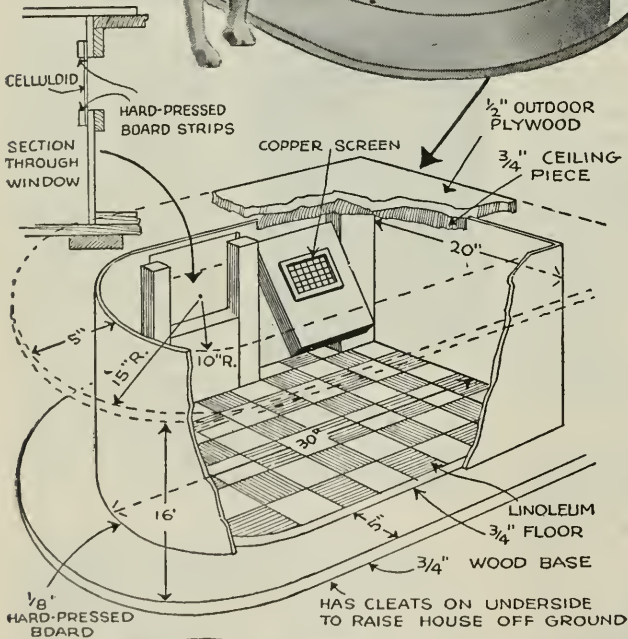

for DOGS

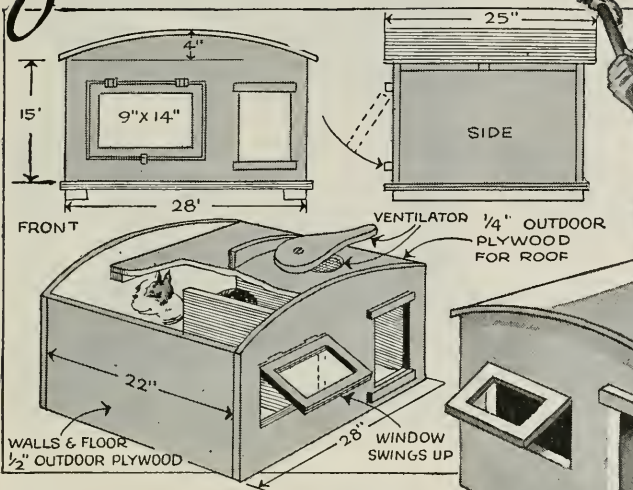

make it. Now, for bare utility combined with a bit of novelty, you have the barrel and the shed or lean-to kennels detailed at the lower left. The barrel is mounted on a cradle as you see and is covered with canvas. Painted white, it's neat and weather-tight. The other is simply a box within a box, the space between the double walls thus formed being filled with excelsior to insulate the interior. The "hanger"-type kennel at the upper left features a vestibule, adjustable ventilator and an up-swinging casement window. At the lower right you have the Cape Cod cottage which will house your pet in snug comfort the year 'round. Directly below is the basement apartment with ground-level entrance. Holes in the back permit warm air to enter.

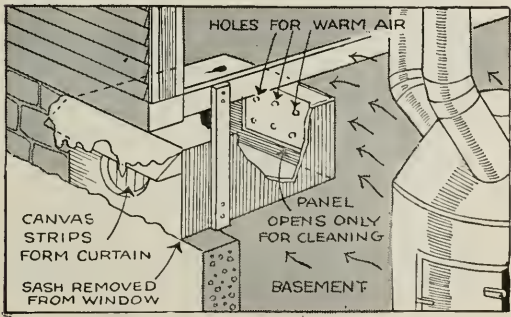
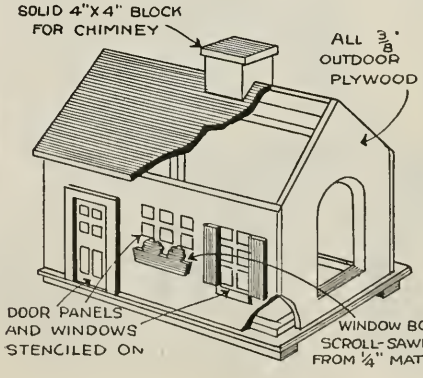
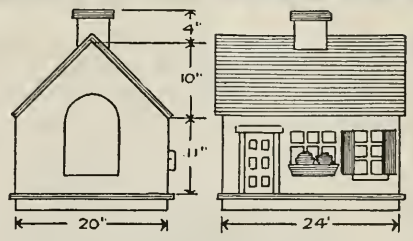

This Insulated Dog House Has a "Skylight" Roof

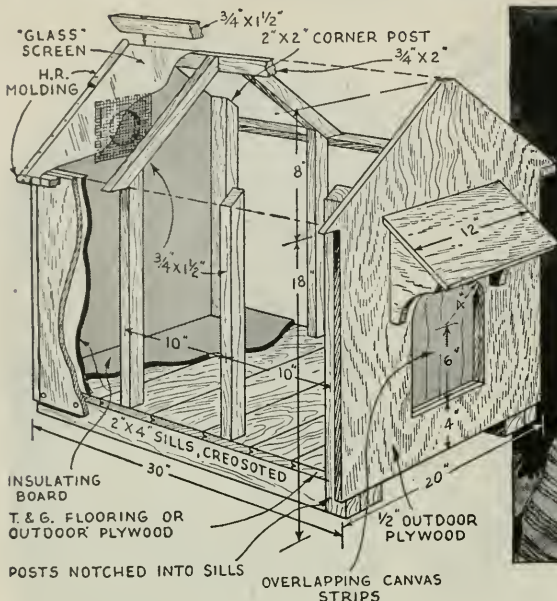

Cool in summer and warm in winter, this insulated dog house is like a sun room with a transparent roof. If located in direct sunshine, the roof can be covered with a canvas shade. In extremely cold weather a quilted pad is laid under the canvas. Outdoor plywood simplifies construction

and adds rigidity because the sides and ends are single pieces. A circular vent in the rear wall has a pivoted cover for adjusting ventilation, and is screened on the inside. Strips of canvas on the inside of the door permit easy entrance, yet keep out insects and prevent drafts.

Kennel Door Can Be Removed Easily to Keep Dog Cool

Instead of propping a kennel door open to give a dog air during hot weather, provide it with this easily removed door. It is suspended by means of two door bolts as

indicated in the drawing below, so that the dog can push it in or out as he desires, and the door can be removed completely by simply sliding the bolts back and lifting it out.

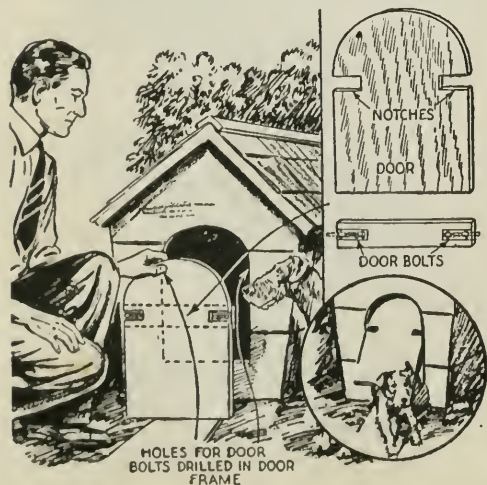

Dog's Dish Set in a Brake Drum Is Difficult to Overturn

If your dog has a habit of overturning the dish in which you feed or water it, or moves the dish about until the contents are spilled, get a discarded brake drum to serve as a holder. The weight of the drum will discourage the dog from further attempts to waste its food.



Pliers Held in This Rack Are Easy to Remove

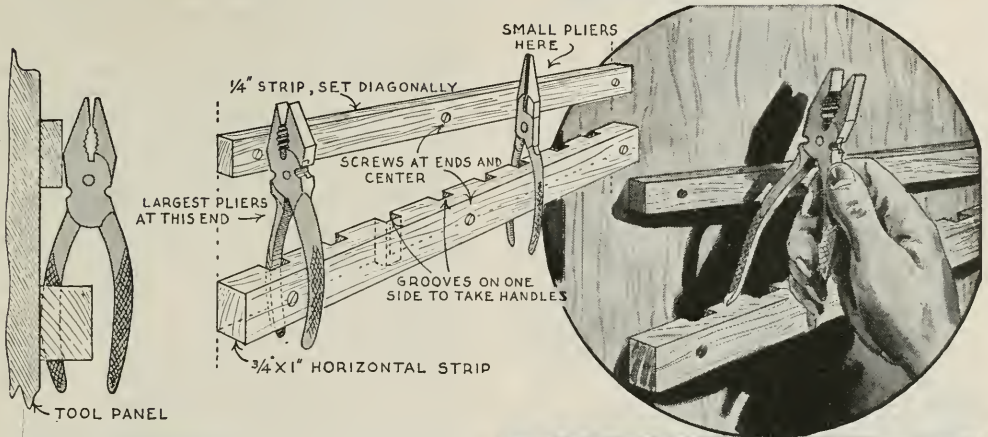

Here is an improvement over the usual rack for pliers that has holes or notches in which the handles tend to bind or are held so loosely that the pliers spread apart at various angles. This rack has one strip notched to accommodate a handle of each pair of pliers and is screwed onto the cabinet back horizontally. A second strip at an angle serves as a headrest for the pliers, which are arranged progressively from the largest to the smallest. The notches of the lower strip should be just deep enough so that the heads of the pliers will wedge firmly against the upper strip, which keeps them erect and prevents them from slipping down in the notches as shown.

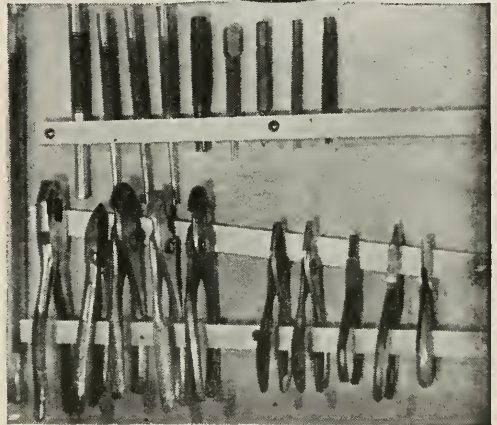

Wood Disks Cut to Size Accurately on Your Circular Saw

To cut a disk on a circular saw, scribe a circle on the work and cut it to form an eight-sided figure. The saw is then raised

to its highest point, the work placed exactly opposite the rim of the blade, and fed against the blade by rotating it on a pivot. A nail driven through a piece of wood, which is clamped to the table, can be used. The disk is not obtained in one rotation. About five settings of the pivot point, taking off $\frac{3}{16}$ in. at each cut, are necessary.

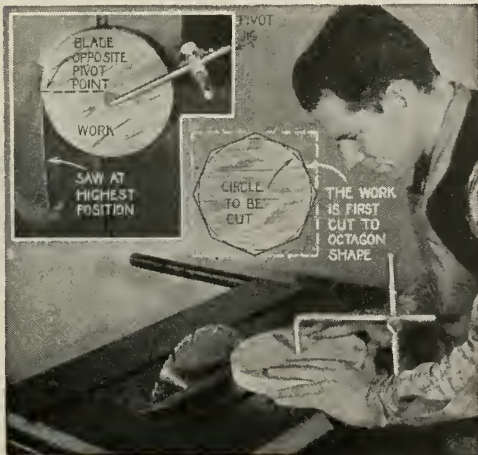

Glue Spread With Fine Comb

To apply a thin coat of glue uniformly over a large surface quickly, use a fine comb as a spreader. The comb is especially handy when working on large pieces of veneer.

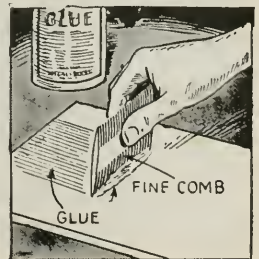

Sheet Veneer Is Cut Smoothly With Straight Razor Blade



Altering the blade of a discarded straight razor as indicated, and fitting it firmly in an old file handle makes a knife for cutting sheet veneer. After removing the blade from its handle, the end is broken off by placing it upright in a vise and striking it a sharp blow with a hammer, after which the severed end is ground to a bevel. The opposite end is ground straight to fit in the file handle.

Fixture Simplifies Wire Brazing

A fixture that holds the ends of small rods or wires in alinement while soldering



or brazing them can be made from a metal plate and two radio binding posts. Remove the knurled screws from the posts, and enlarge the holes through the sides slightly, unless only small wires are to be held. Then notch one side of each post as shown in the photo, to insert or remove the work easily. The binding posts are fastened by means of their regular mounting screws to the metal plate, which is drilled to receive them. It is desirable to add a weight, such as the gear shown in the photograph, unless the plate is fastened to a bench or other support.

Bobby Pin Holds Nails or Brads For Easy Driving

When using brads, tacks, nails, etc., where it is difficult to hold them with the fingers, while driving, just put the nail in the open end of a bobby pin. Put the head down close to the pin and you can drive it easily.

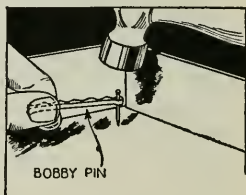

Adjustable Lamp for Workshop

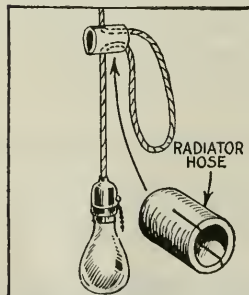

When you want to adjust the height of a drop lamp, use a short length of hose. Just slot one end toward the center on opposite sides and slip it over the cord of the lamp as indicated.

Sheathed Safety-Razor Blade Provides String Cutter

Sandwiched between two thin pieces of wood, and screwed to a wall or cabinet in your kitchen or workshop, a safety-razor blade provides a handy string cutter that is safe. Notch both pieces of wood at

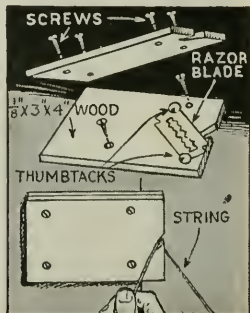

one end, and place the blade at an angle so that the cutting edge will project slightly beyond the inner end of the notches. Fasten the blade to one block with thumb-tacks at opposite corners, place the other block over it, and screw the assembly in place underneath a shelf.

Glass Drilled with Silicon-Carbide

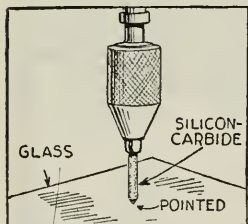

One craftsman found that a pointed piece of silicon-carbide is superior to a steel drill for making holes in glass. When chucked in a drill press or hand drill,

the silicon-carbide will penetrate the glass faster than a drill without the chances of chipping it. The pointed end of the carbide should be dipped in water occasionally.

Non-Scratch Feet for Boxes

Book ends, small boxes or pieces of bric-a-brac that are placed on polished tables can be kept from scratching the surfaces by sticking pieces of felt to their bottoms. Felt corn plasters of the type shown are handy for this, and come in several sizes. Just moisten the pads and stick them in place.

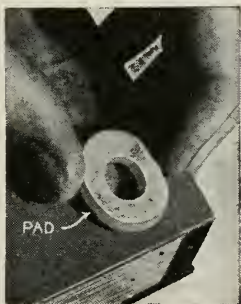

Small Drills Stored in Block



A wood block of the shape shown can be used to hold drills and small tools so that they can be carried about easily as required. The block is stable, of large capacity and the handle, which is

patterned after the handle of a hairbrush, is gripped with the fingers.

Initials Burned in Tool Handles With Fingernail Polish



A good way to initial your wood tool handles is to use ordinary fingernail polish. Just make the initials on the handle with the polish and then ignite it. As the polish burns, it will char the wood under it. If you want the initials burned deeply into the wood, use two or three applications of polish, igniting it after each application.

Holder Keeps Soldering Iron and Accessories Handy

Your solder, flux and iron are always together as a unit in this holder. Spools of solder are kept on short projecting dowels, and the ends of the solder are run through screw eyes at one side of the holder where the hot iron can be pressed against them. The iron itself is supported on two brackets, and the point is shielded by a strip of wire mesh curved over it and fastened to the sides of the holder.

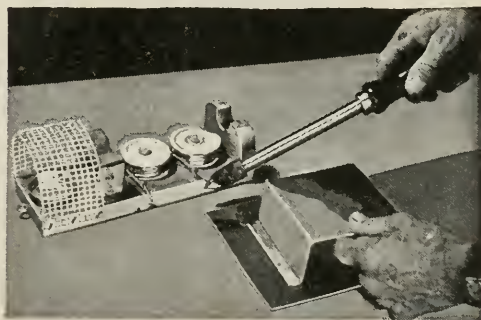

Rotating Shelves in Workshop Hold Small-Parts Jar

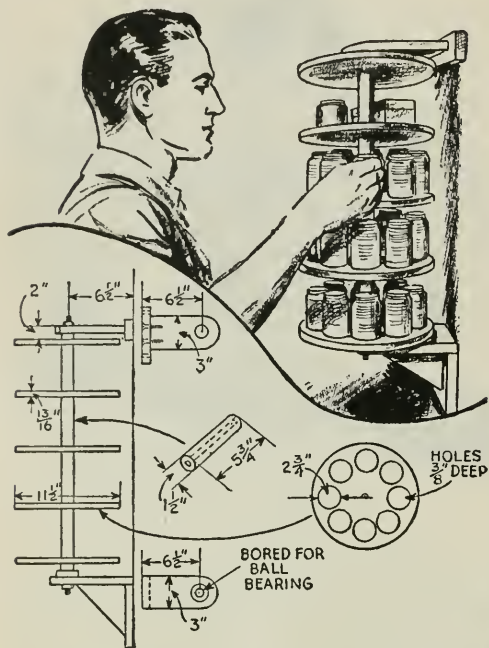

These rotating shelves are just the thing for the home workshop owner who likes to keep screws, nails and other small parts in glass jars. The shelves are plywood disks drilled through the centers for a long iron rod. Pipe, cut to short lengths, is used to space the shelves. If desired, shallow holes or depressions can be formed in the upper surfaces of the shelves to take the jars so they cannot slip off when the shelf is turned. The assembly is mounted on a wall between two wood brackets, the lower one of which contains a simple ball thrust bearing as indicated in one of the details. This permits the shelves to be rotated easily even though they are heavily loaded with filled jars.

Forms to Glue Curved Work

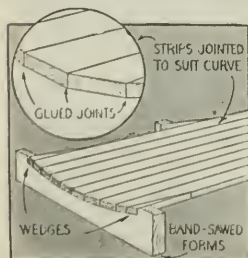

Gluing together a number of narrow strips to produce a curved surface is done easily and accurately by using forms of the type shown. Use hardwood and band-

saw them to the desired curve, leaving shoulders at each end. Then joint the edges of the strips at a slight bevel to suit the curve, apply the glue and lay strips in the forms. Wedges driven between the outside strips and the shoulders of the forms force all of the strips tightly together.

Sandpaper Washers Keep Knobs Tight on Drawers

To prevent wooden knobs of cupboards or dresser drawers from loosening, cut twin washers from medium sandpaper as indicated, fold them in the center and slip them over the knob bolt or screw. When the knob is tightened against the washers, the abrasive surface will hold it securely.

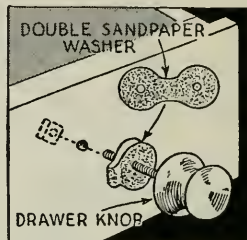

Magnet on Box Picks Up Tacks

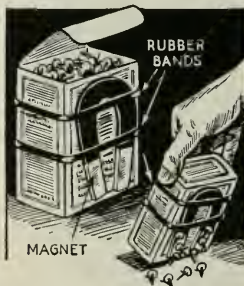

By attaching a small magnet to a tack box, one carpenter saves time in picking up surplus tacks that have been poured out for various jobs. In use, the magnet is merely brushed over the tacks to pick them up, after which they are removed and dropped back into the box.

Handholes Cut in Sawhorses to Carry Them Easily

Carpenters and others who have to work with sawhorses will find that holes cut in the cross members as indicated simplify carrying them. The holes should be rounded and sanded at the edges to avoid getting splinters in the hand.

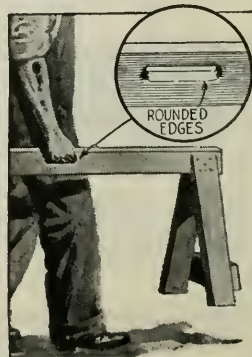

Altered Piston Forms Sturdy Grinder Head

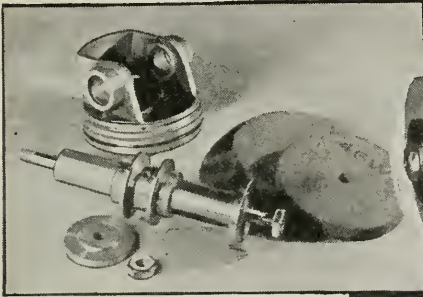

With little alteration, an old auto piston can be converted into a grinder head for light work. The piston skirt is sawed off just below the wristpin bosses. Part of the remaining piston wall is then cut away to allow for the V-belt drive. By cutting a hole in the base of the grinder it can just as well be driven from underneath. The shaft is a cold-rolled rod with its ends turned down to fit the grinding-wheel holes and threaded for retaining nuts. Collars are made to hold the grinding wheel. The pulley is turned from steel and is held in place with a setscrew. Oil holes are drilled in the shaft bearings. After drilling screw holes in the base, the grinder is ready to fasten to the bench.

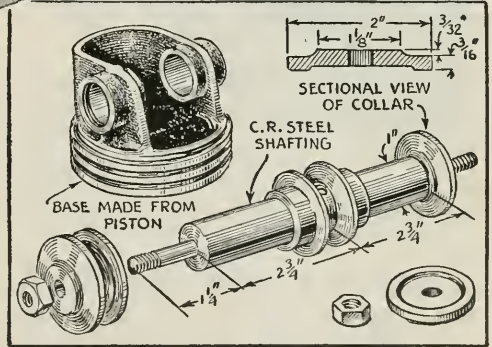
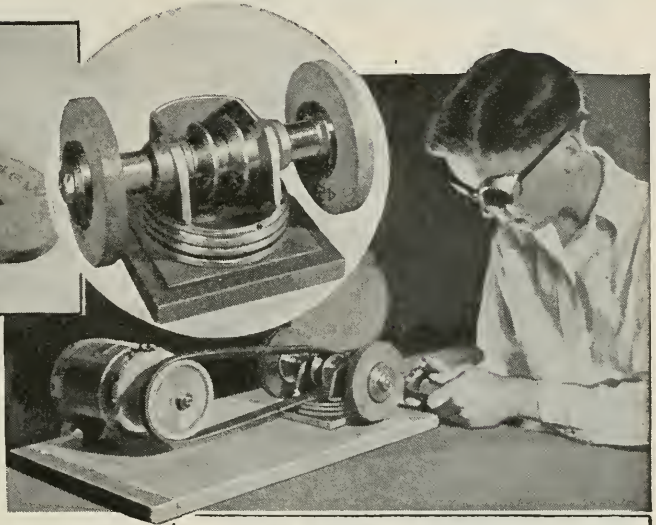

Handy Sanding Block Permits Instant Change of Paper

To change the paper on this sanding block, you merely loosen the wingnut on the quick-acting hand grip, which holds one end of the paper. A slit cut at an angle across the top of the block holds the other end. Resiliency is provided by sheet rubber glued to the underside of the block.

When making the block, allow sufficient clearance for both the screw and the bolt in the hand grip so that it can be tilted slightly. Standard 9 by 11-in. sandpaper sheets are cut to 2 by 9-in. strips to fit the block.

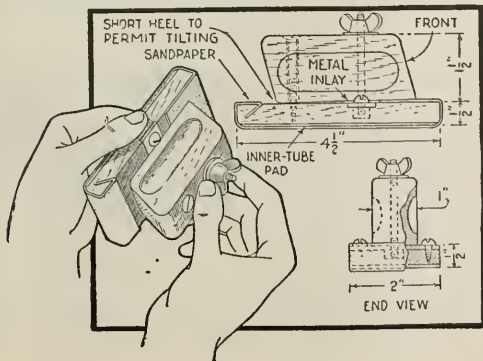

Rubber Side Pockets in Drawer Store Small Parts

Inner-tube sections having slits cut in them and nailed to the sides of shop drawers as indicated provide handy pockets for storing small tools. Also, the pockets are convenient for brads, nails, etc.



Eave Gutter Between Wall Studs Provides Small-Parts Shelves



Lengths of eave gutter nailed between the studs of a garage or workshop provide convenient shelves or bins for small parts. They can be nailed to the wall and the studs, the curved sides of the gutter making it easy to pick up the part wanted.

Tool Rack From Solder Spool

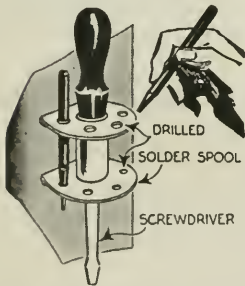

A rack for small chisels, punches, screwdrivers, etc., can be made easily by drilling holes concentrically through the rims of an empty wire solder spool. The rims of the spool are bent over on

one side so that it can be attached to a wall or the back board of your bench.

Small Coil Spring Holds Brads for Driving

To avoid bruised fingers when driving a number of small brads, one mechanic uses the coil-spring holder illustrated. It consists of a length of

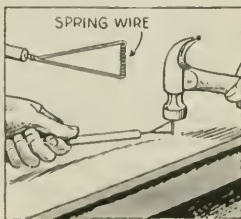

fine spring wire, which is coiled and bent as shown, and attached to a small dowel, which serves as a handle. A brad is slipped into the coil, which grips it until driven into the wood a sufficient depth to remain in place. The coils of the spring should be large enough to pass just over the heads of the brads.

Envelope Removes Small Tacks From Permanent Magnet

Before using a permanent magnet to gather up small tacks or metal filings, slip it into a thin paper sack or envelope. The magnet will lose little of its power, and the paper can be removed to dislodge the metal.

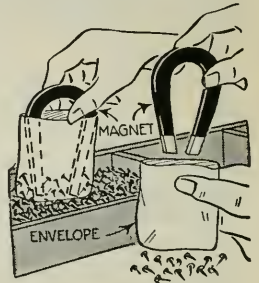

Using Door Turnbutton as Switch

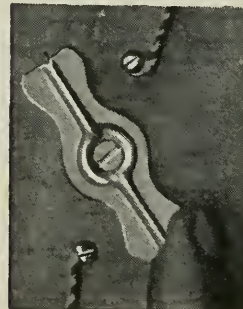

Door turnbuttons provide handy switches at the electrical experimenter's bench where electric currents no stronger than those from a storage battery or toy transformers are handled. The button is mounted between two screws, which serve as wire terminals. The paint must be scraped from the bottom of the button to afford good electrical contact.

Painting a Number of Tack Heads at One Time

A workman who needed a number of tacks having the heads painted a certain color did the job quickly with the aid of a piece of screen wire. This was nailed to a small wood frame and the tacks emptied onto it. A little shaking quickly

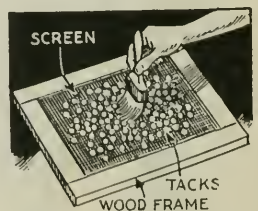

caused the tack points to penetrate the screen mesh so that the heads were exposed as indicated. A few strokes of a brush applied the paint in a jiffy.

Clothespin Heads Provide Pulls on Small Drawers

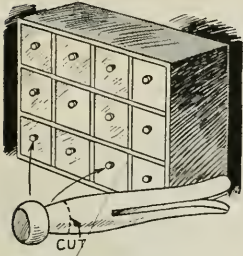

In fitting his shop with a small wall cabinet for storing screws, nails, etc., one craftsman quickly provided neat, little knobs for the drawers by cutting the heads off

of clothespins. Screws through the drawer fronts from inside attached the knobs.

Drill to Use in Model Making Assembled From Scrap Parts

This handy drill for use in making model ships, planes, etc., is constructed easily. A 7-in. length of $\frac{1}{8}$ -in. brass or steel rod is used for the shaft, and a spiral, removed

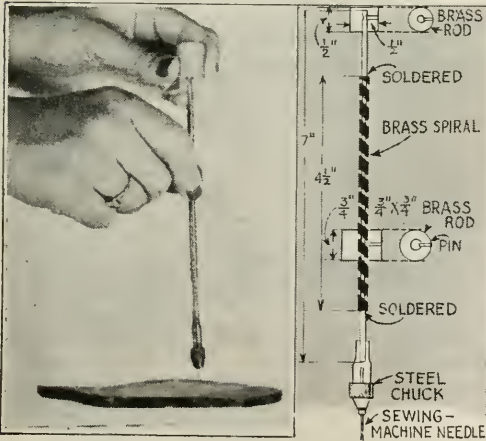

from an automatic lead pencil, serves as a rotating device, which is soldered at the ends to the brass shaft. A finger grip, which rotates the drill when moved up and down the spiral, is made from a $\frac{3}{4}$ -in. length of brass rod. This has a hole drilled through the center so it will slide loosely over the spiral, and is fitted with a pin, which extends slightly into the center of the hole to engage the spiral. The chuck is one removed from a small pin drill. Drill bits are made from steel sewing needles.

Two Handles on Scroll saw Blade to Cut Large Work



When work is too large to use a scroll-saw, try removing the blade from the frame and using spring-type clothespins as handles. If the blade is of the loop-end type, a pin set in one of the clothespin jaws will take the loop. On blades that have pins in the ends, shallow grooves cut in each jaw of the clothespin will serve to hold the blades.

Holding Beveled Work in Clamp

When clamping work that has one or both edges at a bevel, the tendency to slip out of the clamp can be prevented by us-

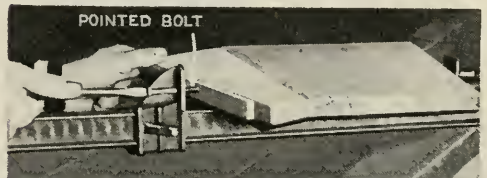

Run the clamp jaws tightly against the work, then drive up the pointed bolts to bear against it

ing pointed bolts in the clamp jaws as indicated. The bolts are screwed into tapped holes, the pointed ends bearing against waste strips tacked to the edges of the work to avoid marring it.

Twine Dispensed in Workshop Through Funnel on Wall

When you need a twine holder and there is none at hand, just hang a tin funnel on the wall, insert the ball of twine and pull

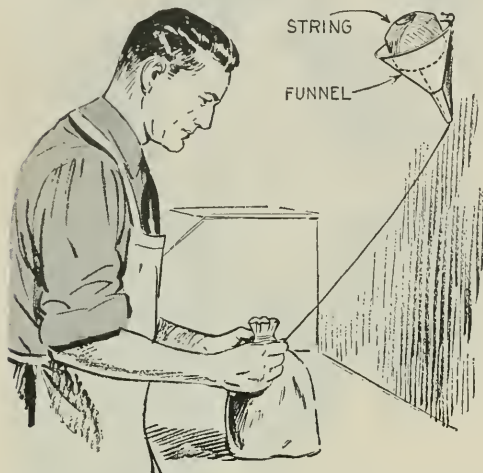

the end down through the funnel spout. Such a holder is only suitable for balls of twine that unroll from the inside.

Brush Used in Different Paints Cleaned Economically

In painting models, it is often necessary to use paints of different colors on a small job. To have a brush for each type of paint would not only raise the cost of production, but would also make a lot more work



in keeping them clean. To avoid all of this, use one brush and clean it on a piece of screen wire stretched over the top of a small box. To clean the brush, merely dip it in a can of kerosene or other solvent and then rub it back and forth across the screen. In this way, the solvent or cleaning fluid does not become colored quickly, as the brush is merely dipped in and out once or twice for each cleaning.

Drill for Tap Selected Quickly

Here's a gauge to determine the correct size drills for taps. Just solder a number of nuts of different sizes to a strip of flat metal, and scribe or paint the nut sizes on the latter. A drill that fits snugly into a nut of the same size as the tap to be used is the one to select.

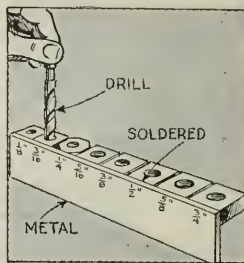

Sheet Metal Is Bent Easily With Celluloid Block

In forming sheet-metal parts, a fiber or wooden block is usually employed to avoid marring or denting the surface, and to assist in making uniform bends. If a celluloid block $\frac{1}{8}$ to $\frac{1}{4}$ in. thick is substituted, the results will not only be superior, but the progress of the forming can be observed without lifting the block from the work. The celluloid will withstand considerable hammering.

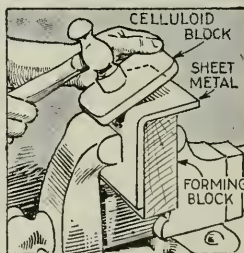

Paper Cups Have Many Uses in Home Workshop

An inexpensive convenience in your home workshop is a supply of small paper cups obtainable in any ten-cent store. They are particularly handy when doing small jobs of finishing, or in mixing paints and stains. Labels and measures can be marked on them easily with a pencil, and liquid levels show clearly through the

translucent sides. They are handy for washing tiny parts, and similar work, and they provide good containers for storing small screws, brads, bolts and nuts, washers, etc., one of which can be threaded through the side of each cup to show at a glance what it contains.

Small Quantities of Water Heated With Soldering Iron



When small quantities of liquids must be heated in the shop, you can do the job quickly with a soldering iron. A brass or copper tube large enough to take the iron is flattened at one end and bent over as indicated to

prevent liquid from entering. In use, just insert the iron and tube into the liquid like an immersion heater.

Modern-Furniture Drawer Pulls From Old Auto Pistons

Drawer pulls that go well with modern furniture can be had by sawing off the tops of auto pistons. The top is cut into three parts as indicated in the upper left-hand detail. After this has been done the pieces are polished highly and drilled and tapped for attachment to the drawers with screws. The pulls can be mounted with the slots running either vertically or horizontally.

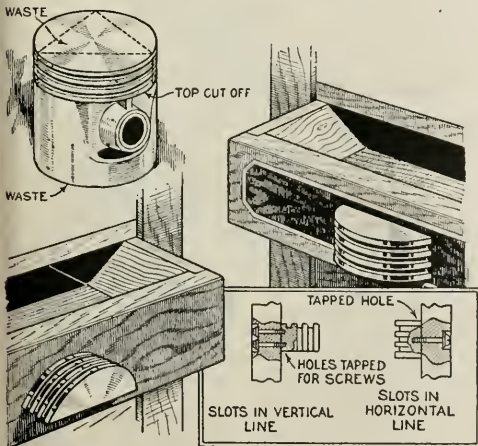

Clamp Improvised From a Bolt and Two Spools

Especially useful for clamping small work at the edge and other places where the depth of reach is small, this little clamp will serve in an emergency. It is made by simply slipping a couple of empty thread

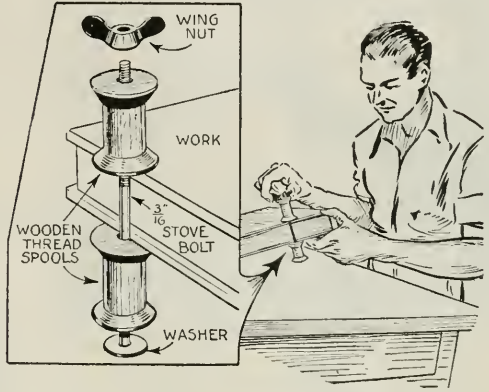

spools over the end of a stove bolt of suitable length. While a wrench can be employed to draw up the nut, a wing nut fitted in its place will be more convenient.

Old Safety Razor Used as Sander on Delicate Work



For smoothing small pieces, or the inner surfaces of curved work, a simple little sander may be made in a jiffy by merely removing the blade from an old safety razor and

slipping a piece of sandpaper over the end as indicated. When the handle is tightened, the comb guard grips the sandpaper.

Milk Cartons Serve as Paint Cups

Try cutting down a cardboard milk container to the desired size, instead of using tin cups or cans in which to mix a little paint for a small job. The cartons are leakproof, and can be discarded after the job has been completed.



Non-Sag Lamp for Workbench Adjustable to Any Position

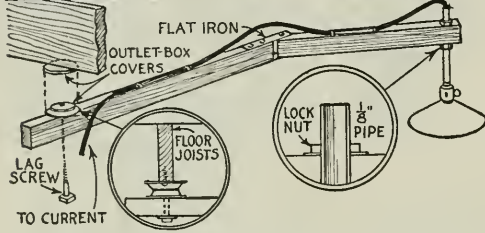

Pivoted on two electrical outlet-box covers, the arms of this adjustable workbench light can be swung to illuminate any part of the bench without sagging. The two covers, one screwed to the overhead floor joist and the other to the extending arm, are held together with a lag screw through the center. Proper adjustment of the screw to get easy movement of the arm is found by experiment. The circular detail on the right shows how the socket is fastened to the arm with $\frac{1}{8}$ -in. pipe and lock nuts.

Dowel-Cutting Jig Saves Time on Quantity Production

When a number of duplicate dowels are required, this simple jig will enable you to do the work quickly by hand. It consists

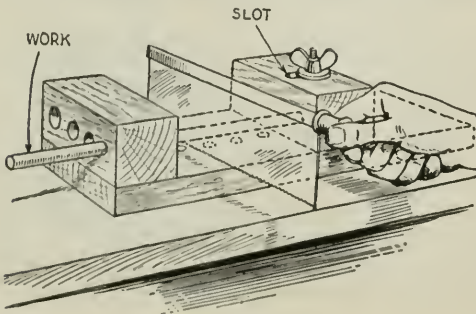

of a base on which two wooden blocks are mounted. The fixed block has three or four holes for different size dowels while the tailstock or removable block has one hole to receive the ends of the dowels and is held in place by a bolt and wing nut which works in a slot. Several holes drilled through the base permit this block to be adjusted roughly and the slot in the block allows it to be adjusted finely.

Padded Feet on Small Boxes From Thumbtacks

Padded feet on small fancy boxes and other wooden objects are made easily from thumbtacks whose heads are covered with two small rubber bands cut from thin rubber tubing. Stretch the bands over the heads of the tacks, letting the points pierce the bands to hold them in place.



Butt Hinge Used as Squaring Tool

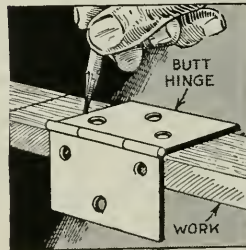

A small butt hinge is frequently much handier to use than a tri-square for marking or squaring narrow work when used as indicated. For accuracy, the hinge pin

must be a snug fit so that both parts of the hinge will be in alignment.

Handy Household Nail Kit

By sawing two slots at right angles in the end of an empty thread spool and slipping it over the corners of four discarded typewriter-ribbon boxes, you will have a kit for carrying small nails or screws around the home. The spool may be attached to the boxes by small brads or glue.

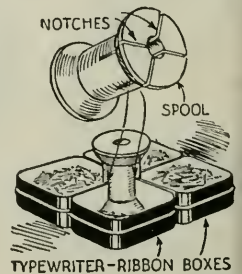

Modelmaker's Safety-Pin Clamp

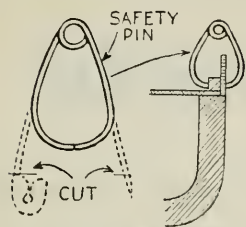

A tiny clamp for use in holding small parts of a model together while glue dries is made in a jiffy from a safety pin. Just cut off the head and point of

the pin and bend the severed ends as indicated. The coiled end of the pin causes the severed ends to grip tightly the small work held between them.

Model Airplane Balanced to Fly With Modeling Clay

The nose of a flying model of an airplane can be weighted to establish efficient flying balance with the aid of ordinary modeling clay. A roll of the clay is pressed with the fingers over the nose block to form

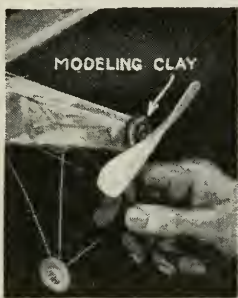

a smooth, streamlined joint or the clay can be sculptured to resemble a motor cylinder block. Correct flying balance is obtained by supporting the model on the fingers at each wing tip and adding or removing the clay.

Small Model Parts Picked Up With Looped Pin in Handle

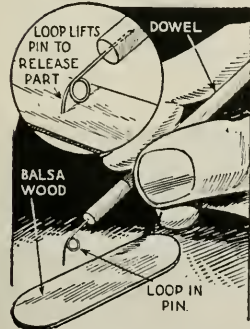

Handling of tiny wood parts when making and assembling models is simplified by using this little tool. It consists of a pin having a loop formed near the pointed end and then stuck into a dowel for a handle. The parts are

picked up by inserting the pin in them, and they are released by pressing down the handle so that the loop acts as a fulcrum to pry out the pin.

Model Yacht Hulls Hollowed on Drill Press

After the outside of your boat has been shaped to final dimensions, place a felt pad on the table of your drill press, adjust the

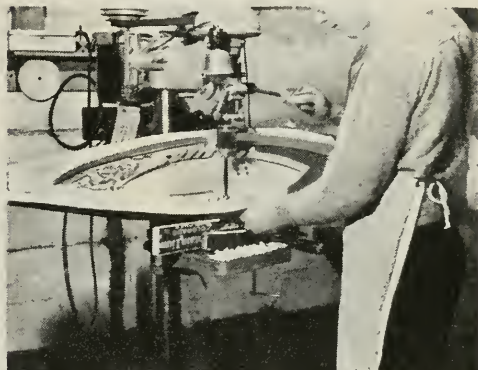

depth gauge to the thickness you want the walls to be, and with a 1/2-in. high-speed wood bit, or router, remove the surplus stock by boring a series of overlapping holes. This can be carried almost to the extreme bow and stern with the 1/2-in. bit then a smaller bit should be used to complete the routing job.

Portholes for Model Boats

When constructing your next model boat try this simple method of making realistic portholes: Get a narrow strip of "Cellophane" of the desired shade, coat one side with shellac and apply to model so it cov-

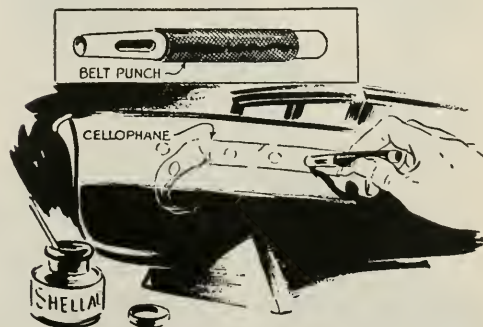

ers the spots where the portholes are to be located. Using a belt punch, which you can get at any hardware store, press it through the Cellophane by hand and at the same time recess the wood slightly. Then strip off the excess stock.

FUN with

By
Alexander Maxwell

FASCINATING to watch and instructive to build, this combination unit comprises an alcohol-fired boiler fitted with a safety valve, a piston-type engine and a turbine. All of these may be mounted on a single base, as in Fig. 1, so that it will be an easy matter to connect the rubber tube on the steam supply line to either engine or turbine. Simplicity of construction and the use of stock material enable anyone to make these engines.

The piston-type engine shown in Fig. 2 is detailed in Figs. 3, 4 and 5. It is an engine of the single-acting or single-admission type, that is, there is only one power stroke instead of two as in the double-acting type. This means that the flywheel must be comparatively heavy to store up sufficient energy for maintaining a steady and uniform speed. Looking at the left-hand sectional detail in Fig. 4, the valve is

open and live steam from the boiler is rushing through the steam chest into the cylinder. The piston has just started

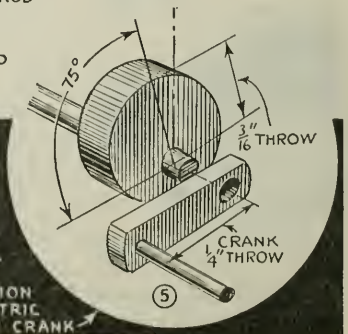
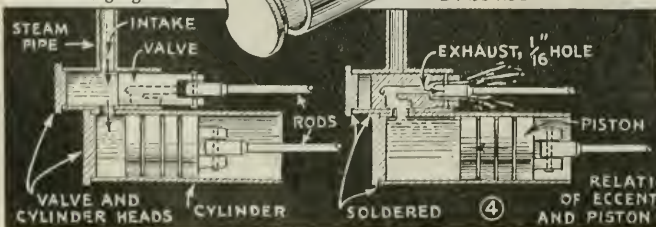
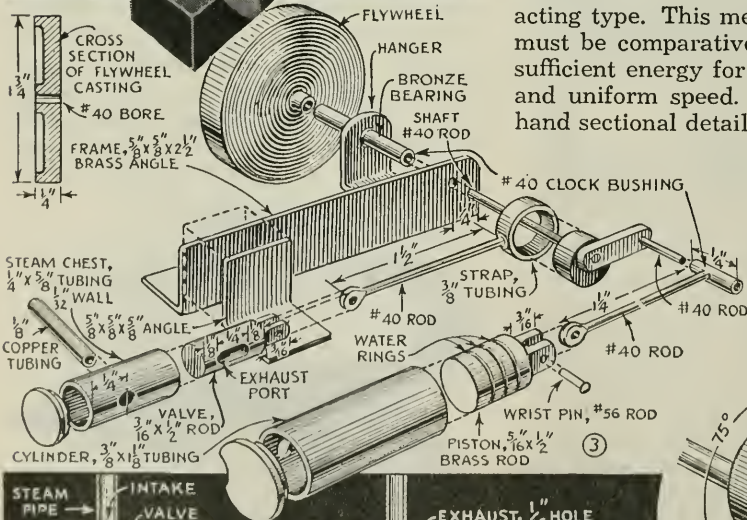
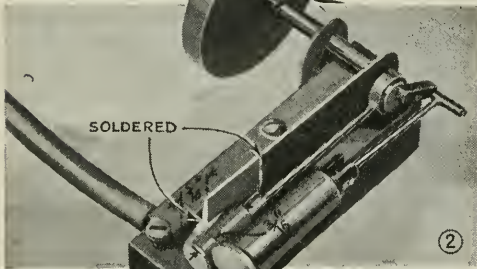
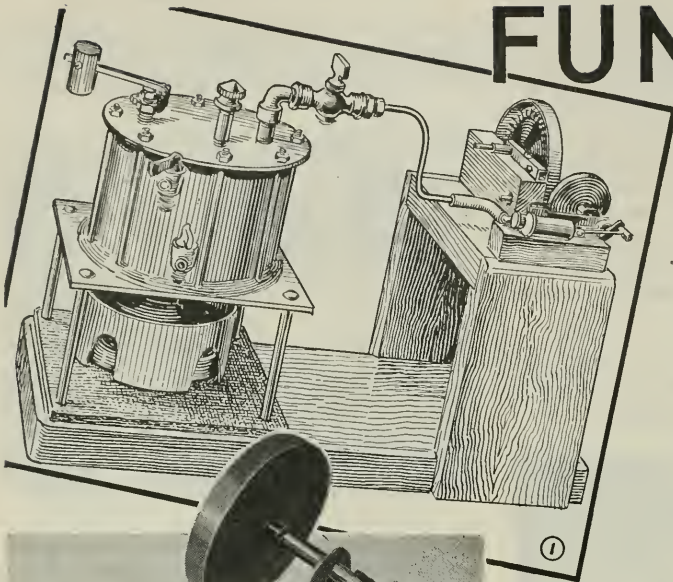

STEAM ENGINES

the outward, or power stroke. While the piston is completing this stroke with the steam pressure forcing it outward, the valve is moving in the opposite direction. Just before the piston reaches the back dead center, the valve closes the live-steam port and by the time the piston starts the return or exhaust stroke the valve has moved into the position shown in the right-hand detail, Fig. 4. This allows the exhaust steam to pass out through a port drilled in the body of the valve. Thus the cycle is completed, the one opening into the cylinder acting as both inlet and exhaust port.

An alloy solder with a high melting point, 500 to 550° F., must be used. Ordinary tinner's solder will not do. However, before assembly all bearing surfaces of cylinder, piston, valve and steam chest must be tin-plated. This is necessary because contact with live steam produces an oxide film on brass, making the surface rough. Sprinkle pure tin salts on the surface to be tinned, apply heat until the tin is liberated and spreads over the surfaces. While a batch of lead is melting in an

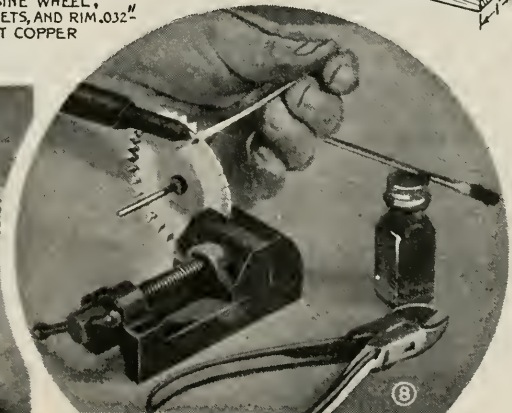
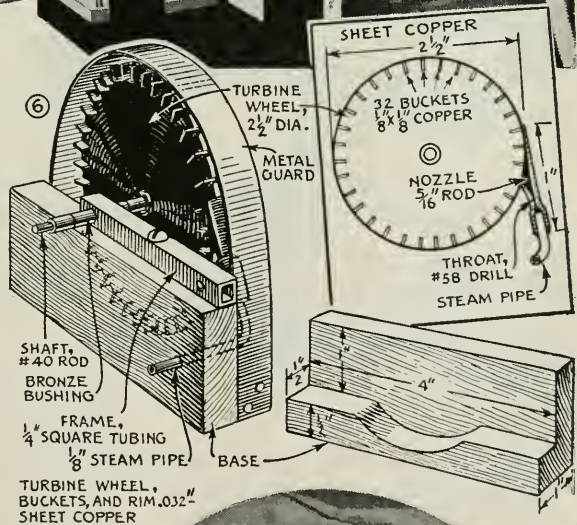
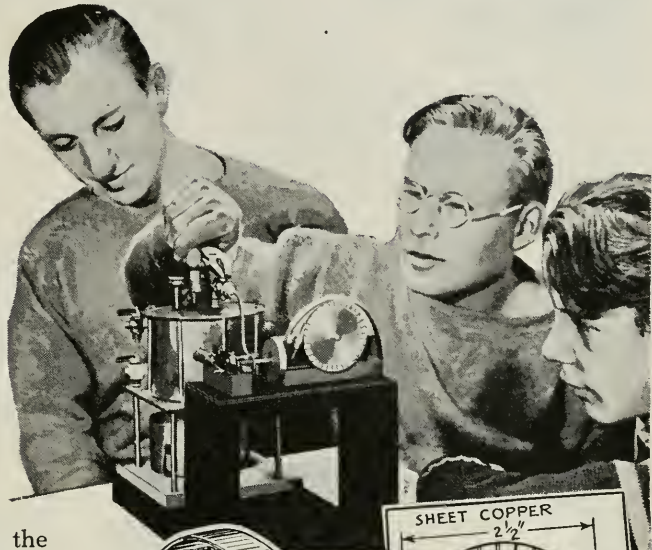

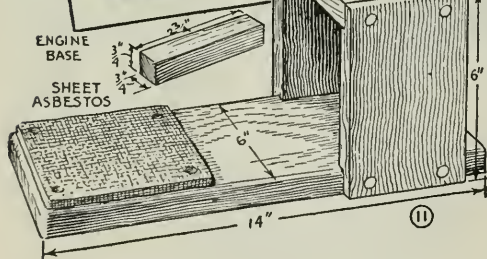
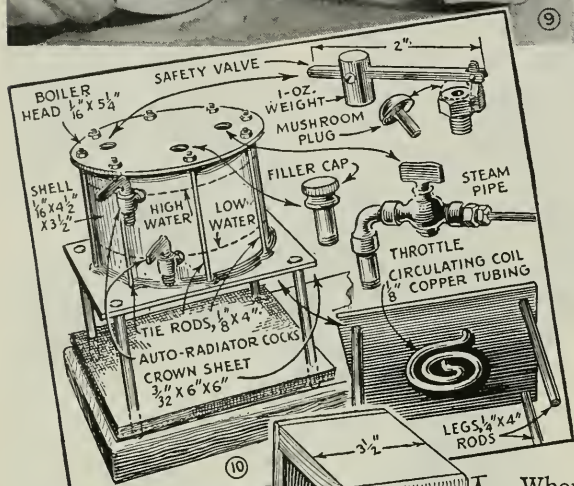

iron ladle, turn the wood mold for the fly-wheel, Fig. 7. Although the wheel is shown separate from the shaft in Fig. 3, it is actually shrunk onto the shaft by simply placing the latter upright in the mold before the metal is poured. This done, the engine is put together complete, except the crank which is pressed on the shaft but not soldered. Connect the engine to an air line furnishing about 10 lbs. pressure. Then move the crank on the shaft until you find the point where the engine runs best, and solder the crank in place.

In the turbine, a jet of steam is directed against buckets on the rim of a disk wheel as in Figs. 6 and 8. The nozzle is made of $\frac{1}{16}$ -in. brass rod filed to the shape indi-

cated. The opening in the nozzle is cone shaped by drilling a number of holes of progressively smaller sizes, finishing with a No. 58 drill. The shoulders are smoothed up with a file. Finally the nozzle is filed down to the curvature of the wheel rim and is fastened securely so that the rim just clears. The throat opening is located on a line tangent to the circumference of the wheel. Carefully made, this wheel is capable of very high speeds.

A good boiler, which is simple and safe, is shown in Fig. 10. A circulating coil and an alcohol burner, Fig. 9, make it steam in about half the time ordinarily required. Soldering the boiler is very important. The open ends of the shell must be filed or turned true so that the joint at the head and crown sheet, Fig. 10, is perfect. Then tin the meeting parts for a space of $\frac{1}{2}$ in. each way from the joint. Assemble the boiler with the tie rods and heat over a flame, taking care that the latter does not contact the tinned joints.

When the metal is so hot that hard solder will flow, hold the latter against the joints building up a triangular fillet all the way around, top and bottom. To make the safety valve steamtight be sure that the two parts seat perfectly.

Portholes for Ship Models

Modelmakers who like a finished effect on their work but have limited time and equipment, will find that shoe eyes can be used sometimes to provide realistic port holes for ship models. First cut the eyes out of some old shoe. Then carefully select a drill that is just a trifle smaller than the inner rim of the eye. After boring the holes in their proper places in the hull, carefully tap the eyes in place.

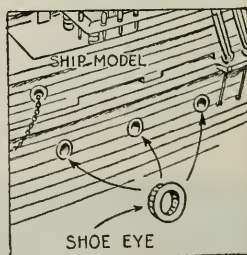

☞ To make a small awl insert the eye end of a needle in a stick handle.

Punchings From Sheet Rubber Provide Model-Ship Deadeyes

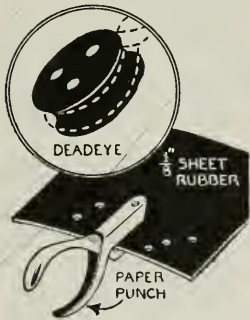

Needing a number of deadeyes for a model ship, one model builder made some very realistic ones by punching them from sheet gasket rubber. To do this, he used a punch similar to the ones used by streetcar conductors. How-

ever, if a large leather punch is available, it could be used just as well. When forced through the rubber, the punch tends to compress it, which produces a slight groove on the edge of the punched piece. Three holes made through each punching with a tiny drill complete the job.

Support for Miniature Trees

When making miniature scenery for model railroads, window displays and other purposes, a turkish towel stained green serves nicely as a lawn. To support miniature trees and shrubs firmly on such a lawn, one of the simplest methods is to use paper clips with one end bent sharply up-

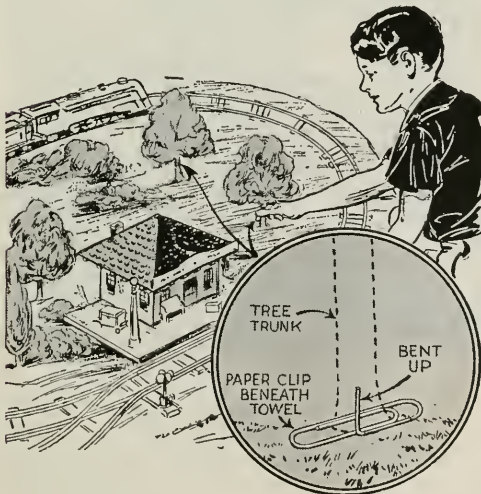

ward. This end is pushed through the towel and then into the stem which is to become the tree or shrub. The clips are out of sight, have a broad area and hold the trees firmly.

Rubber Wheels for Model Plane From Ink Erasers

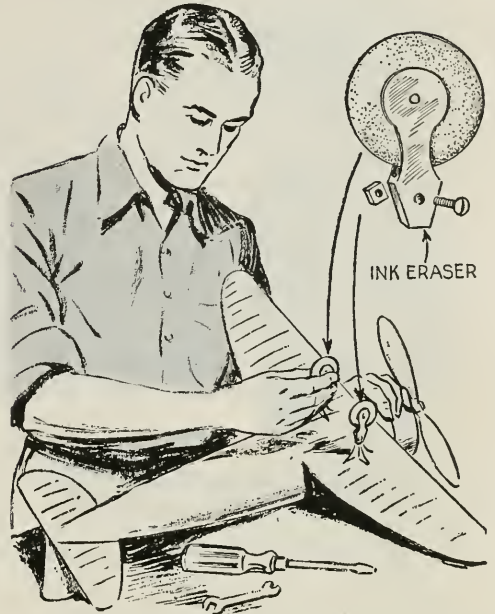

In some cases, round ink erasers provide good landing wheels for model planes. Simply remove the brush from the top of the eraser handle and attach the handle to the undercarriage of the plane with a small machine screw.

Steering Gear for Model Ship Made From Banjo Key

Ship modelers who want a realistic steering gear for a sailing ship will find that a tightening key from an old banjo serves the purpose nicely. If one is not

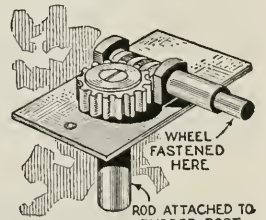

at hand, it can be purchased for a few cents. Generally, the keys are made up in sets, but it is a simple matter to divide the strip on which they are mounted. By removing the finger piece or handle and substituting a ship's wheel, and by extending a rod from the rudder post up through the poop deck, the portion of the key upon which the banjo string was intended to be wound may be joined to the rod with a small sleeve. A post must be set in place to take the key, after which the entire assembly can be enclosed in the model.

Twin Propellers Double Flight Time of This Model Plane

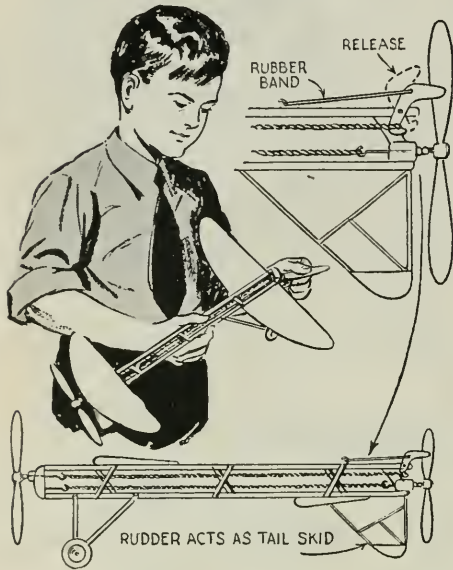

Here is something new in model airplanes; twin propellers arranged in tandem so that one runs and then the other, almost doubling the time that the plane will stay in the air. The plane is made in the regular way except that the rudder is on the underside so that it serves as a tailskid. The rubber band operating the front propeller is fastened to a pivoted L-shaped arm, which engages the rear propeller and prevents it from turning until the arm is pulled back. As the band untwists in driving the front propeller, the pull on the arm is gradually reduced and a short rubber band fastened to the upper end of the arm pulls the arm back, allowing the rear propeller to rotate.

Easy Method of Making Ratlines for Ship Models

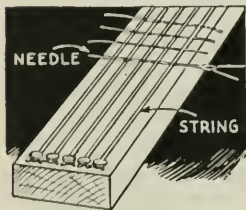

Elaborate ratlines for small ship models can be made easily by the following method: Fasten a number of lines securely to a wood block, getting them as

close to each other as possible. Next take a small needle and thread and pierce each cord successively. Then draw the thread

through, cut it off, and repeat the procedure. Leave plenty of extra thread so that none of the ends will be too short when the lines are spread for mounting.

Nose Plugs for Model Airplanes From Caps of Collapsible Tubes

Screw caps from collapsible tubes can be used for nose plugs of model airplanes. Drill the cap in the center to take the propeller shaft, then fit it into a hole bored in the nose block.

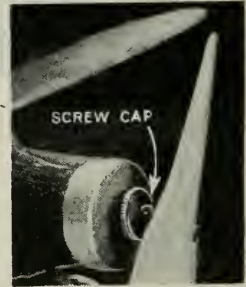

Cotter Keys Serve as Flagstaffs on Model Locomotive

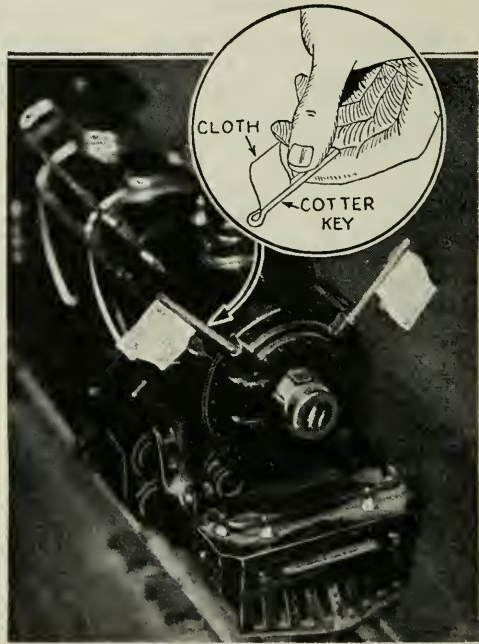

If you have to replace the tiny flagstaffs on a model locomotive, cotter keys will serve the purpose nicely. Select some about the same length and diameter of the original staffs, and insert the flags between the legs of the keys, which can be slipped into the flag sockets on the model.

☛Dusting rubber-band motors with finely powdered graphite will lessen friction.

Pictures Amusingly Distorted by Pantograph

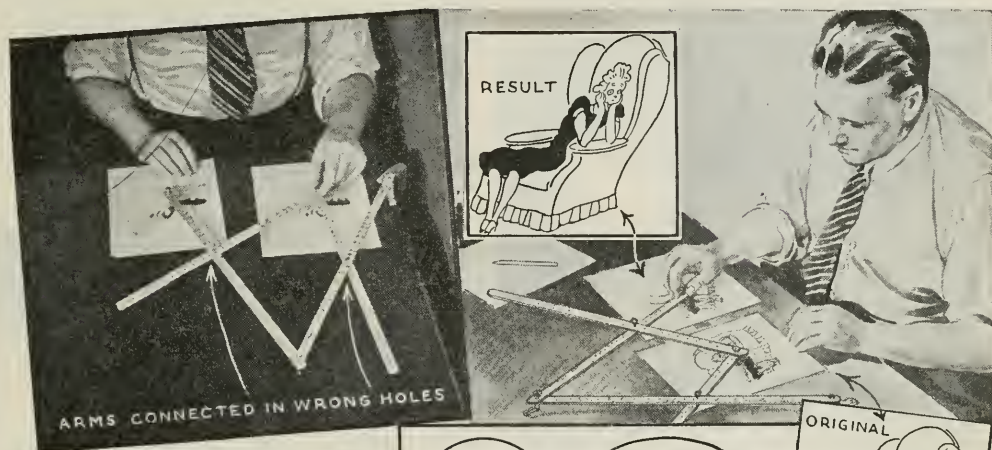

By using a pantograph you can make distorted reproductions of pictures. Distortion of an oval and the figure shown in the details are good examples. In normal use, when making exact copies of pictures, either enlarged or reduced, the bars of a pantograph are connected so that they form a parallelogram, but by shifting the bars so that they form an irregular shape an endless variety of distortions can be obtained; yet the pictures bear a resemblance to the originals. The distortion lengthens the picture in one direction and contracts it in the other. There is a different degree of distortion for each wrong connection

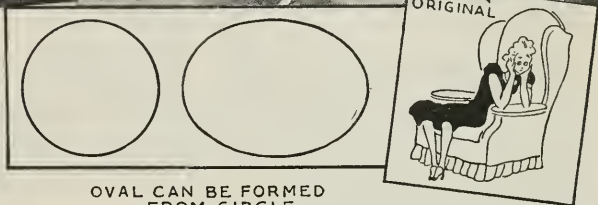

OVAL CAN BE FORMED FROM CIRCLE

made with either the left or right-hand joint where the bars of the pantograph cross, and still a third type if both joints are misplaced. Also, there is a different distortion for each position in which the original picture is placed. As the pantograph either enlarges or reduces at the same time it distorts, the oddity of the reproduction is emphasized by the change in size.

Drawing Board Held at Angle With Casement Adjuster

If you use a drawing board on a desk or table, a convenient working angle can be

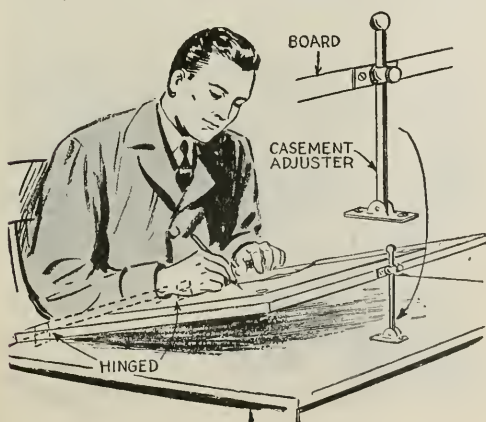

maintained by using a casement adjuster of the type shown. Attached near the rear of both table and board, it provides an ideal arrangement for tilting the board.

Pencil Pointed in Abrasive Pocket Taped to Sketchbook

Instead of gluing a strip of sandpaper to your sketchbook for pointing a pencil, fold the strip with the abrasive side inward and tape it to the book. This forms a pocket to collect the powdered lead and keep it from getting on your hands and the book pages.

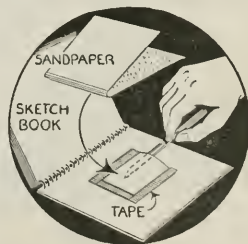

Ruling Lines on Blackboard With Multiple Chalk Holder

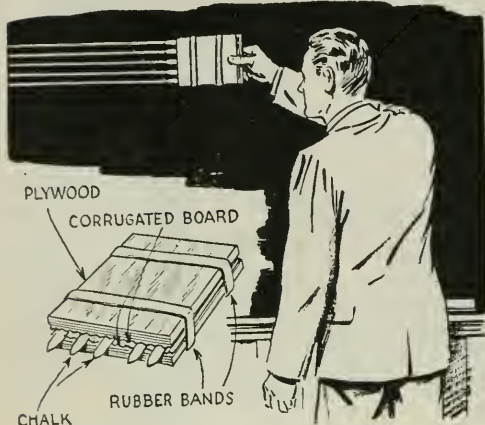

Corrugated cardboard glued to two pieces of plywood provides a multiple chalk holder for ruling parallel lines on blackboards. The pieces of chalk are slipped in the grooves and rubber bands are snapped on the holder to keep the whole assembly tightly together.

Spreader From Mucilage Bottle for Sign Painting

Having a number of signs to get out in a single color, one sign painter used the fountain "brush" shown. It is made by slipping a rubber spreader from a mucilage bottle over one end of a length of steel conduit and corking the other end.

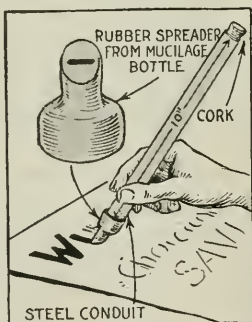

The slit in the rubber is made slightly larger to allow the paint to flow freely.

Pocket Comb Used as Compass

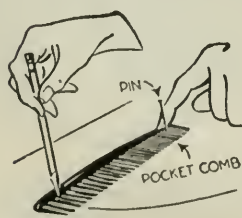

Next time you need a compass and none is at hand, a pocket comb and a pencil will serve the purpose. Sharpen the pencil point to slip easily between the

comb teeth. Then hook one end of the comb over a pin driven into the work and revolve the pencil to draw the circle. If the comb is to be used often for this purpose, drill a small hole through one end in which to insert the pin.

Tack Puller Stores the Tacks

Made from an empty lipstick container, this thumbtack puller also stores the tacks after removing them from the work. Just notch the bottom of the container as indicated so that it can be slipped under the tack heads.

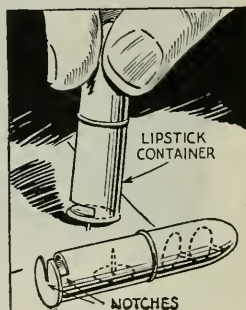

Novel Lettering on Place Cards Done With Alphabet Noodles

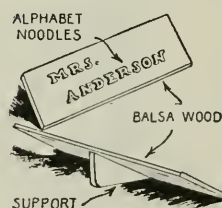

Party place cards may be made by using alphabet noodles. Thin strips of stained balsa wood are used as the card, and the noodles are cemented in place.

Paper Clip Holds Pen Points for Ruling Lines

When it is necessary to draw a number of parallel lines, several can be made at one time by holding the required number of steel pen points in a spring paper clip like the one shown.

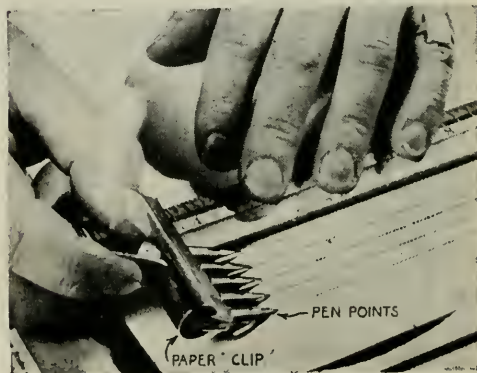

Equipping your CHEMICAL LAB

By C. A. Crowley

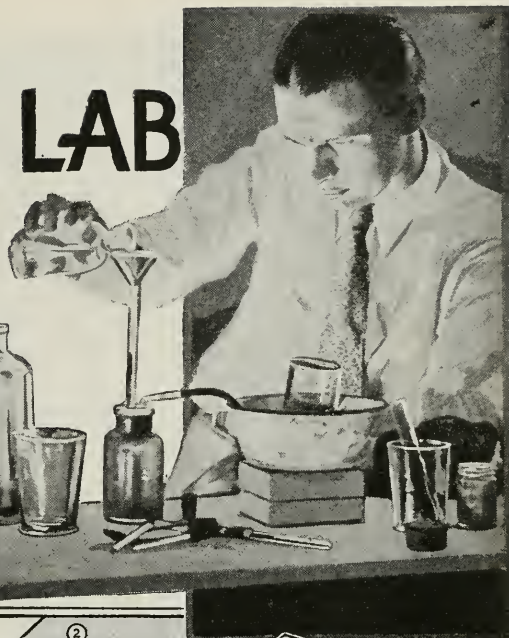
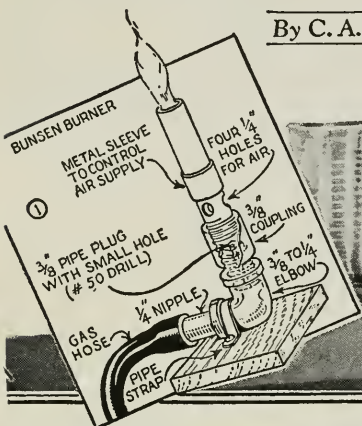

A SIMPLE laboratory in which many miracles of chemical magic may be made to take place at your command can be easily assembled at almost no expense. In Fig. 1 you will find complete details for making an efficient Bunsen burner from pipe fittings and a few other odds and ends. The hole drilled through the pipe plug to admit the gas should be small. The sleeve, which is slipped over the burner tube, permits the flame to be adjusted so that it is very hot and almost colorless. Fig. 2 shows a test-tube rack. The dimensions may, however, be varied to suit. The top board and the upper section of the base board are lightly nailed together, laid out and drilled with a bit of the proper size to accommodate the tubes. Holes $\frac{3}{4}$ in. in size are convenient. The boards are next drilled while still nailed together. After drilling they are separated and mounted between end pieces as shown. An un-drilled third piece of wood, the same size as those drilled, is mounted under the bottom drilled piece to support the tubes.

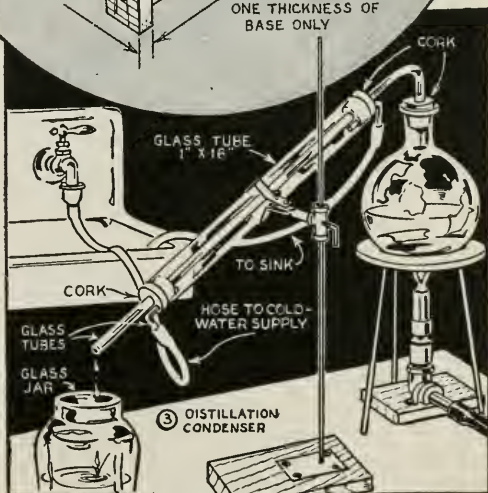
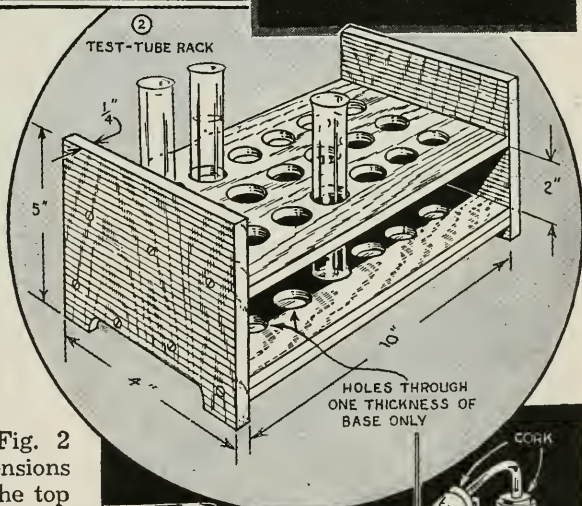

A distilling condenser of homemade construction is shown in Fig. 3. Gas pipe or thin-walled metal tubing, 1 in. in diam-

THE WORK BENCH AND ACCESSORIES

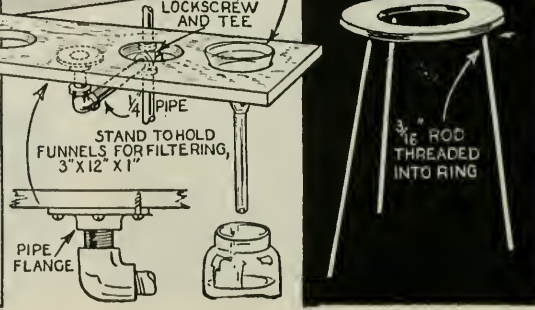
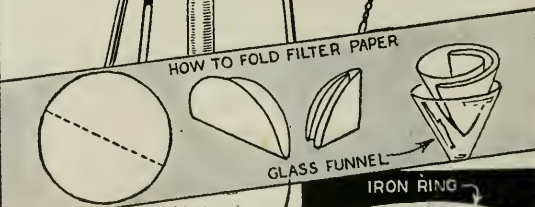
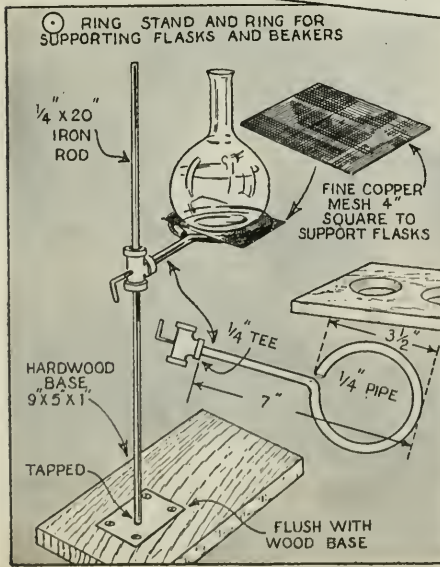
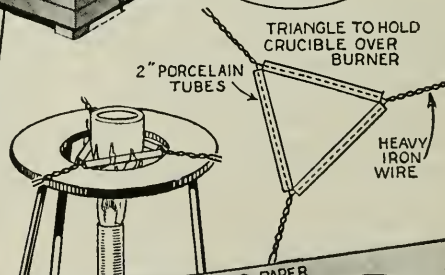
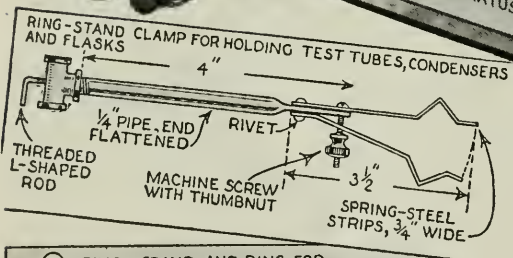
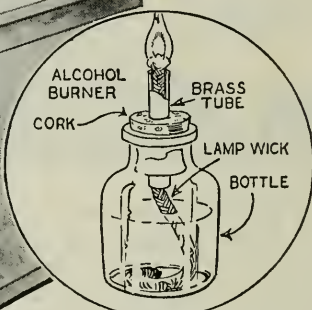
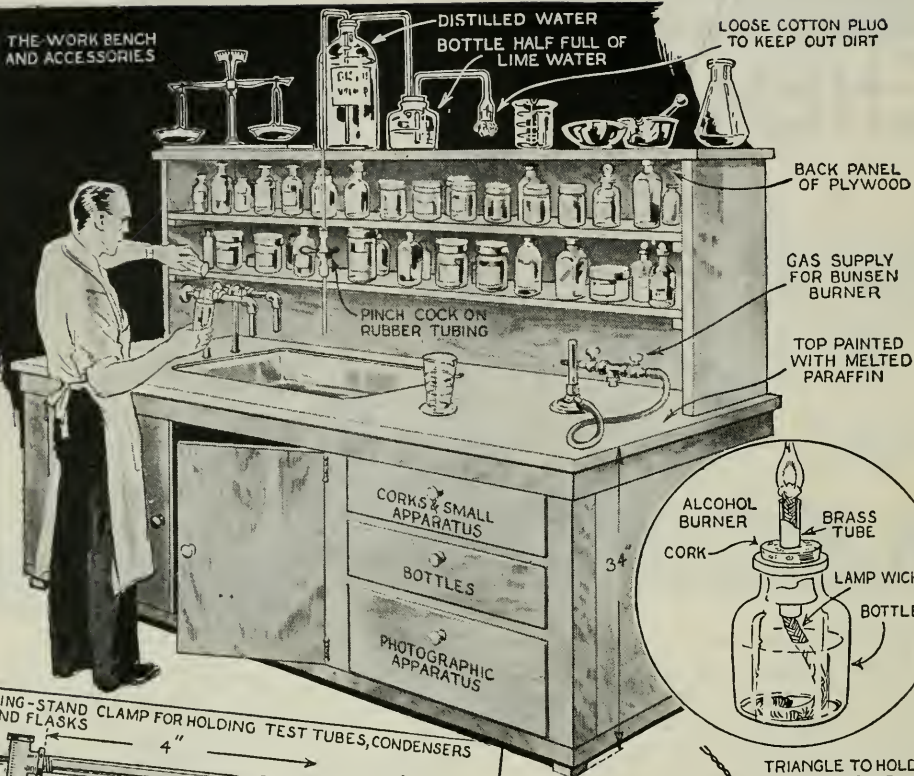

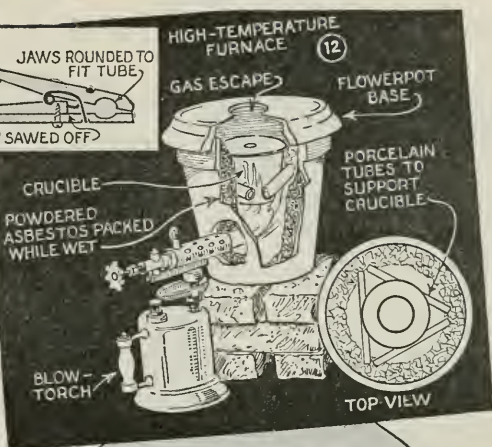
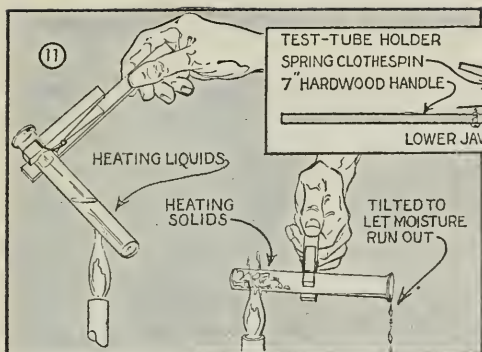

eter may be used in place of the outer glass tube if more convenient. If metal tubing is used, inlet and outlet tubes may be soldered to it instead of using the glass tubes shown inserted through the corks. The center tube should be glass to prevent corrosion when distilling chemicals.

No laboratory is complete without a good substantial work bench. If possible, running water, gas and a sewer connection should be made. If a sewer connection is not handy, the sink may be allowed to drain into a bucket which can be emptied from time to time. In the absence of gas, alcohol burners made like the one shown in Fig. 5 will serve as excellent sources of heat. The distilled water bottle is shown equipped with a siphon so that the water may be drawn by pressing the pinch cock. The second bottle, attached by glass tubing, washes the air and thus prevents contamination of the pure water. Fig. 6 shows details for making serviceable burette clamps such as are used to support distilling condensers and flasks on tripods over burners for heating. Fig. 3 shows one of these clamps in use. Details for making the tripod are shown in Fig. 10. This illustration also shows a simple method of making a ring which can also be attached to the stand for supporting apparatus. In Fig. 7 are shown details for making a triangle and crucible stand, which is very handy for heating dry chemicals.

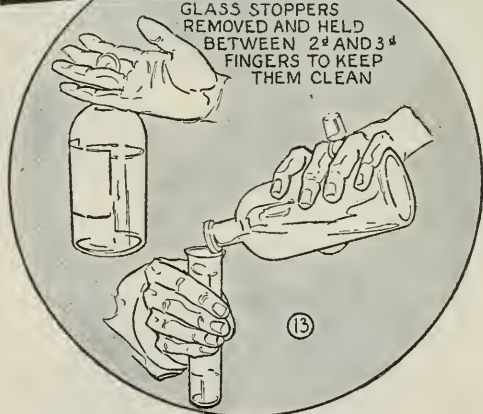

When heating substances in test tubes breakage is avoided by following the suggestions shown in Fig. 11. Fig. 13 shows the proper method of removing stoppers from bottles to prevent their becoming dirty and thus contaminating the contents of the bottle when replaced. When intense heat is required it may easily be produced by directing the flame of a blowtorch into a hole cut in the side of a flowerpot as shown in Fig. 12. It is very convenient for melting metals and making alloys.

Solution to Color Electric Lamps

The proper method of folding filter paper and inserting it into a funnel is shown in Fig. 8 just above the details for the filter rack. Filter racks of this type are supported on a ring stand. The unit is assembled from pipe fittings and a piece of wood bored as shown for the funnels.

Electric lamps and other glass objects may be evenly stained to any desired color by either dipping or painting them with one of the following preparations: First dissolve bleached shellac, 3 oz., powdered rosin, 1 oz., and gum benzoin, 1 dr., in denatured alcohol, 10 oz. Then add in alcohol-soluble aniline dye.

Door Knobs Serve as Pestle in Emergency



Amateur chemists who need a pestle for crushing crystals of various kinds, will find that a pair of discarded door knobs and a strong bowl serve the purpose. A little friction tape wound around the knob held in the hand will improve the grip.

Glass Etching Simplified

Your name, initials or any other design can be etched on glass by using a simple paste solution and a stencil. The etching paste consists of an acid solution, which is mixed with a quantity of Mallinckrodt roach-killing powder, containing 95 percent of sodium fluoride. If this specific powder is not available at your local druggist, he will be able to obtain it for you.

First make up the acid solution which consists of glacial acetic acid, 3 parts; distilled water, 3 parts; sulphuric acid (add cautiously), 1 part. Then add the powder until you get a smooth paste. This will produce a mat finish when applied to glass. The etching paste must be mixed in a lead or wax-impregnated container. If a very small quantity is to be mixed you can do it on a sheet of waxed paper. It is applied to the glass with a toothpick-and-cotton swab or with a lead spatula. Be careful not to allow the paste to touch the skin, as it will cause burns and for this reason it is advisable to wear rubber gloves. Should any get on the skin, wash off immediately with running water.

First get a suitable stencil to cover the portion of the surface to be etched. The stencil can be stuck to the glass with rubber cement. Then, apply a coat of yellow beeswax over the entire surface not covered by the stencil. One method of applying wax is by means of a brush. Dip this in turpentine, rub it on a cake of wax and then apply it to the glass. The wax must dry before the stencil can be removed. Another method of applying wax is to spray it, using equal parts of paraffin and yellow beeswax over both stencil and work, the wax being dissolved in gasoline to make a solution suitable for spraying. In using the spray gun, the wax will run if it is held too close to the stencil; if too far away, the deposit will be in tiny beads. The correct distance is found easily by trial. Suitable stencils can be obtained at any paint or wallpaper store, if you do not wish to cut your own. Small paper doilies make excellent stencils and are available in many designs. Masking tape also comes in handy for straight lines and blocking off areas.

A wax china marking stencil can be used to draw on glass and will form a good etching resist when you want the lines instead of the background to be protected. Cut pieces of adhesive tape into small stencils such as stars, moons and other tiny figures, and stick them directly to the work as a resist. Coat the back of the tape with wax and cover the adhesive side with waxed paper while cutting the design. The waxed paper will peel off readily afterward. Another practical resist is a soft, heavy cord soaked in melted wax. Shape it to form the required design and stick it to the glass while the wax is warm.

By following this simplified process, anyone can make glass etching an enjoyable hobby. Only ordinary skill is required and there's no end to the number of attractive designs that can be etched in mirrors, tumblers, plates and other dishes. Even silhouettes of yourself or members of your family can be copied from photographs and used to provide a personal touch.

Corrosive Acids Filtered Safely

A piece of glass wool will serve as a filter when straining dirt or sediment from corrosive acids. If a funnel is used, it's a good idea to attach the wool to the end of a glass stirring rod, with copper wire, for easy handling.

Remote Alarm Clock Starts Buzzer Near Bed

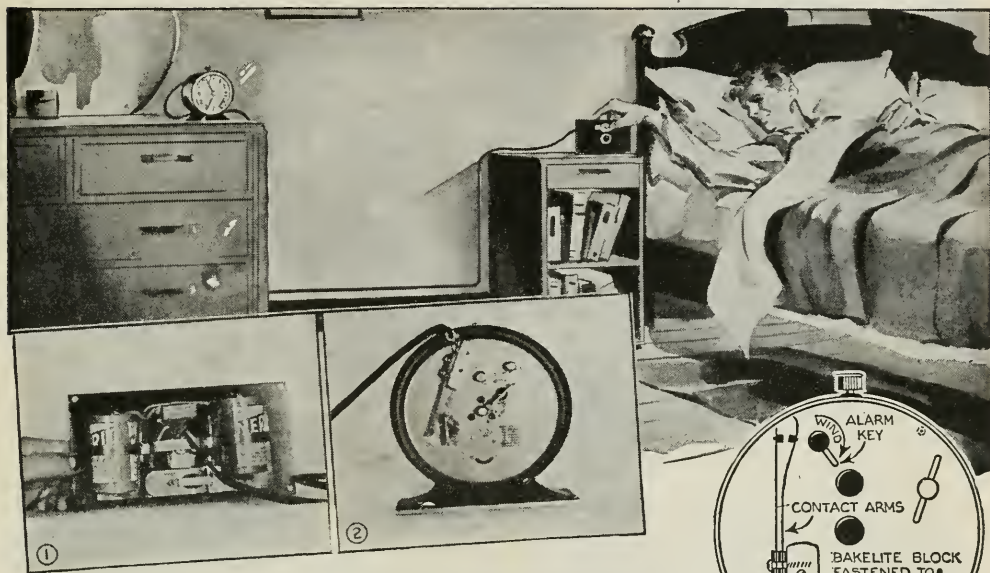

If the ticking of your trusted alarm clock prevents sleep at times, this remote-control unit, built chiefly of old radio parts, will enable you to place the clock at a distance from the bed, or in a clothes closet, so that the ticking will not annoy you. At the time set, a buzzer alarm rings softly at intervals close beside the bed. Simultaneously a dim light illuminates the switch on the control unit so that the alarm may be turned off when you awaken. The control unit, Figs. 1, 3 and 4, consists of a Bakelite panel covering a small metal or wood box which contains two flashlight cells and a door buzzer or one constructed from a radio relay. A brass band holds the dry cells in place and connections are made by soldering the wires directly to the cells as indicated in Fig. 5. Switch and pilot light are mounted on the panel as in Fig. 3. Two contact arms, taken from an old radio relay or phone jack, are fastened to a small Bakelite block which is mounted on the back of the clock, Figs. 2 and 3. The arms must be located in such a position that the projections of the alarm key will strike one of the arms, thus closing and opening the circuit at intervals. The bell-ringing mechanism of the clock is, of course, removed.—Herman R. Wallin, New York.

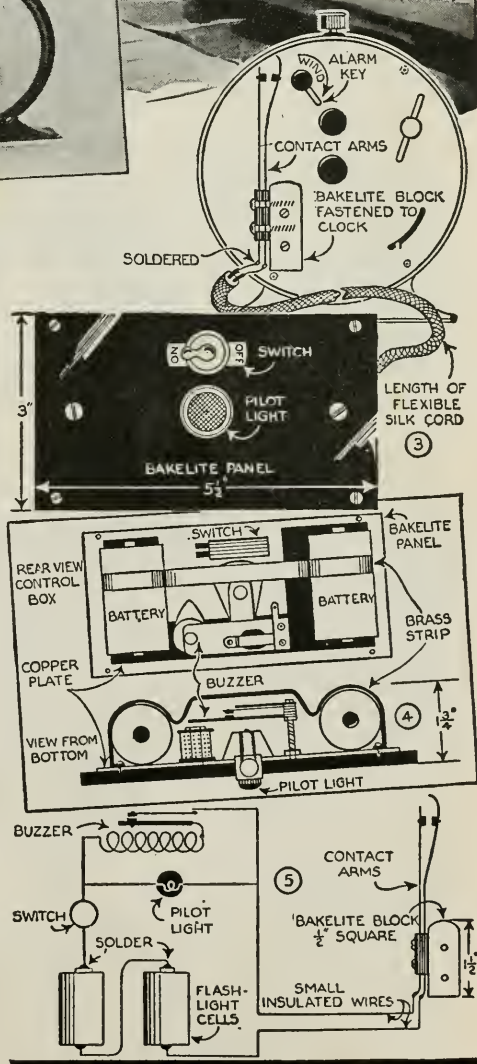

5 TOY

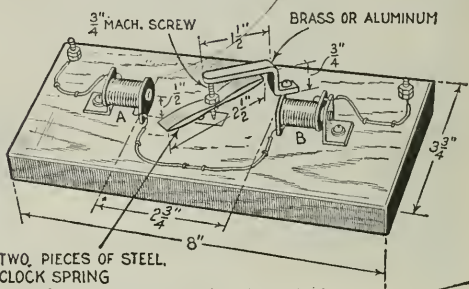

TWO PIECES OF STEEL CLOCK SPRING
 ① MAGNETS A & B FROM BUZZER CONNECTED IN SERIES
 SYNCHRONOUS MOTOR

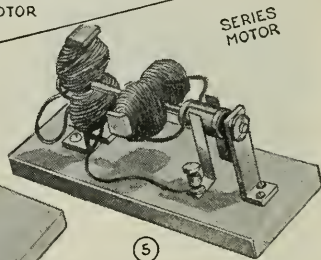

SERIES MOTOR

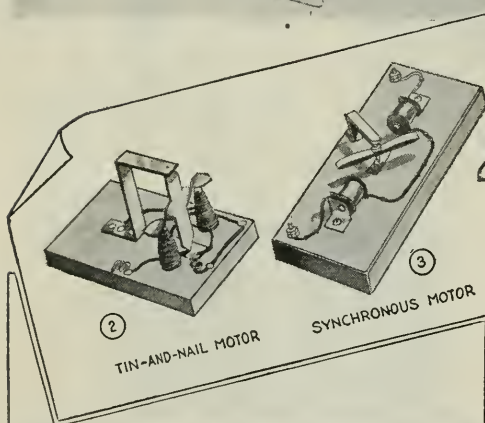

② TIN-AND-NAIL MOTOR

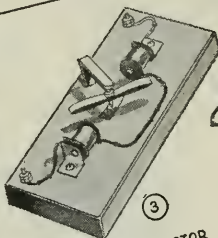

③ SYNCHRONOUS MOTOR

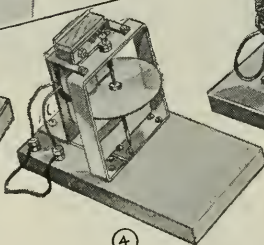

④ INDUCTION MOTOR

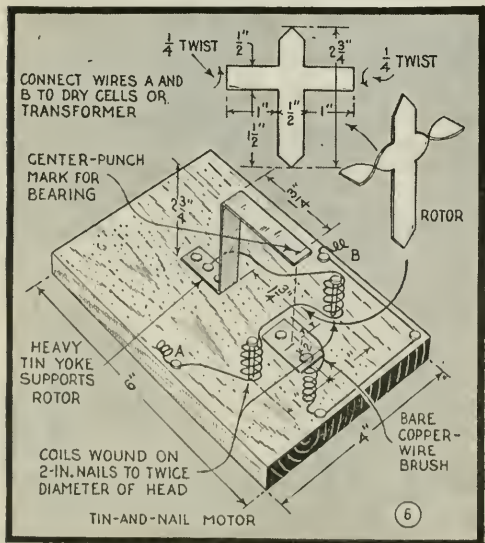

TIN-AND-NAIL MOTOR ⑥

By C. A. CROWLEY

TIN-AND-NAIL MOTOR: One of the simplest forms of an electric motor where small electromagnets cause a tin rotor to spin, is shown in Figs. 2 and 6. This motor runs on a couple of dry cells or will operate on 6 volts a.c. provided by a transformer. The rotor acts like a tiny switch as it wipes against a brush lightly, turning on current momentarily just before its arms pass over the electromagnets. This current impulse, which occurs at each half rotation, is just enough to keep the rotor going. The rotor is cut from tin to the cross shape shown and the side arms are twisted at right angles. The electromagnets or field coils are wound in series on two nails, both windings being in the same direction. The nails are 2 in. apart. One end of the wire is scraped bare and twisted to form a tight coil which serves as a binding post, it being tacked down to

MOTORS

convey basic ideas

These simple electric motors, which run on low-voltage a.c. or d.c. as specified, are constructed from nails, wire and scraps of iron and tin. All of them have been built and made to operate; one provides ample power to drive small toys

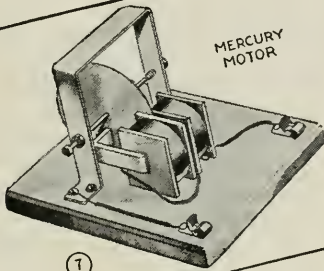

MERCURY MOTOR

①

the baseboard at point A, Fig. 6. At this point connections to a transformer or battery are made. The other end of the wire is tacked to the yoke that supports the upper end of the rotor. A length of bare copper wire is used as a brush, rubbing lightly against the edges of the rotor about $\frac{1}{2}$ in. above the base. It is formed to a coil to provide flexibility. The other end of the brush wire is bared and formed into a binding-post coil at point B to which the other side of the transformer or battery is connected. Center-punch marks are made in the yoke and in a small tin base plate, halfway between the two nails. Then the rotor is set in place so that the arms are about $\frac{1}{8}$ in. above the tops of the nails. The brush is adjusted so that it touches the edges of the rotor and also releases before the arms pass over the nail heads. After connecting the motor to the current supply, give the rotor a start by turning it and the motor should run.

Synchronous Motor: A synchronous motor is one that operates at a constant speed, which is equal to or a submultiple of the frequency of the alternating current supplied to it. A simple synchronous motor

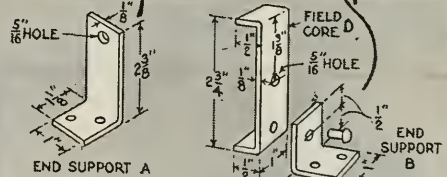
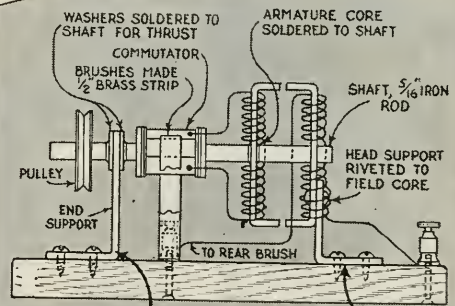

COPPER SHEETS INSERTED IN SLOTS AND BENT AROUND SPOOL AND BOUND WITH CORD AT ENDS

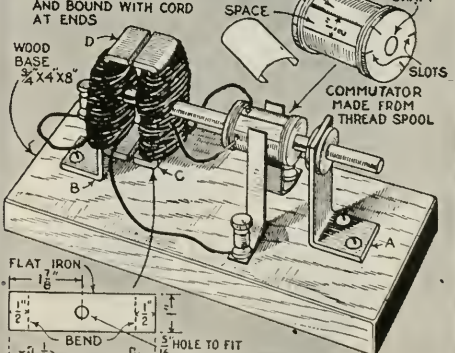

② SERIES MOTOR

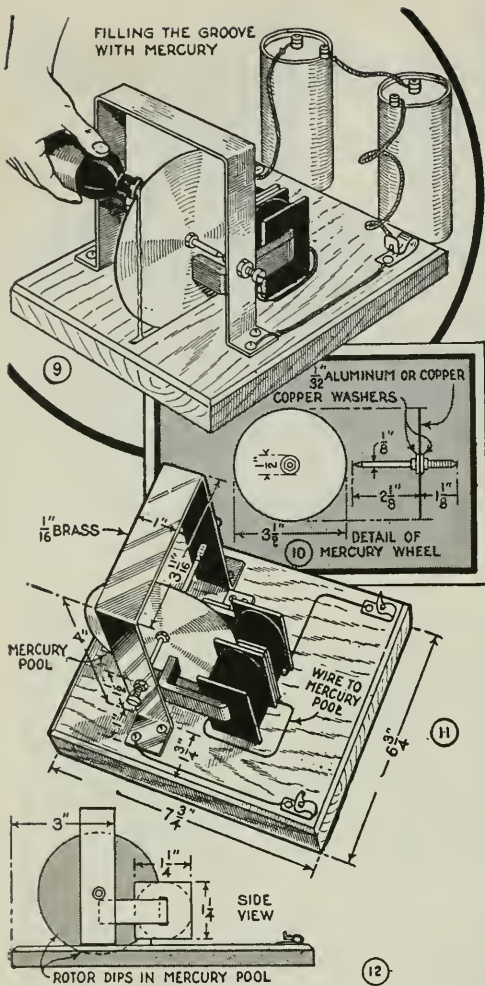

operating on low-voltage a.c. from a bell transformer is shown in Figs. 1 and 3. The field coils A and B are two magnets from a buzzer or doorbell placed so that the windings run in the same direction. These are connected in series. The rotor consists of two pieces of steel clock spring and the shaft is a No. 6-32 machine screw filed to a point at each end. Two nuts hold the springs to the shaft as shown. The shaft is pivoted between center-punched marks in the base plate and the supporting arm. There is no electrical connection to the rotor of this motor. The motor will continue to operate at about the speed at which it is started.

Series Motor: The motor shown in Fig. 5 runs on 6 volts d.c. or 8 to 12 volts a.c. from a toy transformer, and it can be fitted with a pulley to operate small models or other devices, delivering considerable power for its size. Details of construction are shown in Fig. 8. The armature and field cores C and D, as well as the end supports A and B, are made of $\frac{1}{8}$ -in. strap iron. Armature and field coils are wound with bell wire which approximately should fill the space. The armature is slipped on the shaft and is held in place by peening or with a drop of solder. The commutator is made from a thread spool and two strips of copper. Slots are sawed in opposite sides of the spool, the edges of the copper strips are inserted into the slots, and the strips are bent around the spools. There should be about $\frac{1}{4}$ to $\frac{3}{8}$ -in. clearance between the two copper segments. The edges of the commutator should be wrapped securely with strong cord. The leads from the armature coil are soldered to the two copper segments of the commutator, and the armature is put in place. Two washers are soldered to the shaft on either side of the end support to limit end play. The brushes are made of spring brass, $\frac{1}{2}$ in. wide. It may be necessary to give the motor a start by hand. If it does not run as first assembled, turn the commutator on the shaft to a position which will cause the motor to take hold.

Mercury-Pool Motor: The mercury-pool motor shown in Figs. 7 and 9 is a type used in d.c. watt-hour meters and other meters. It operates on two or three dry cells connected in series. It will not operate on a.c. Details of construction are shown in Figs. 9 to 13 inclusive. The rotor is a disk of $\frac{1}{32}$ -in. aluminum or copper mounted on a

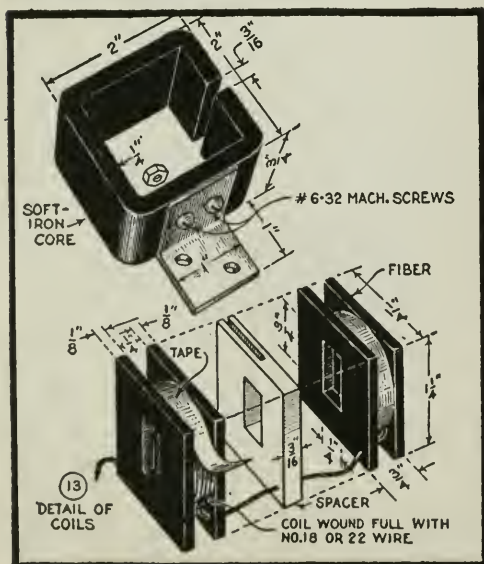

small shaft which is placed between two machine screws which are center-punched at one end to serve as bearings and are locked to the frame with nuts. The mercury pool is cut in the wooden base, directly under the rotor. Next, an electromagnet is made. The core is $\frac{1}{4}$ -in. flat iron bent as shown in Fig. 13 and the two coils are wound full of No. 18 or No. 22 magnet wire, a spacer being placed between them. Both coils must be wound in the same direction. The electromagnet is mounted so that the rotor revolves freely between the coils, and the poles of the magnet are directly below the shaft of the rotor. Electrical connections are shown in Fig. 11. One terminal is connected to the coil, and the other side of the coil is connected to a wire dipping into the mercury pool. The rotor also dips into the pool. The second terminal is connected to the frame of the motor.

Induction Motor: Operated on low-voltage a.c. from a toy transformer, the disk-type induction motor shown in Fig. 4 exemplifies a principle used in meters of various types. It will not operate on d.c. Details of parts are given in Figs. 14 to 17 inclusive. The laminations used are approximately of the dimensions shown in Fig. 17 and can be obtained from an old audio transformer used in radio. Two stacks of laminations, each $\frac{3}{16}$ in. thick, are required for the lower and upper coil. The upper coil is wound with No. 28 d.c.c. wire, enough wire being wound on the coil to fill the winding space on the core. The lower coil is wound with No. 18 wire. The leads from each coil are brought out to a pair of binding posts on opposite sides of the motor. The core of the upper coil is drilled directly below the coil and a single turn of No. 8 bare copper wire is inserted as shown in Fig. 15. The ends of this wire should be lapped carefully and soldered together. The frame is made of No. 16-ga. sheet brass. The rotor is a disk of sheet copper or aluminum. It is moved up or down on the shaft until it is in the proper position between the two cores. The upper coil terminals are connected to a radio rheostat and the lower coil is connected to the transformer supplying 6 volts. It will be necessary to shift the upper coil slightly to one side or the other in order to get the motor to operate properly. Once the proper position has been found, the speed can be controlled by adjusting the rheostat.

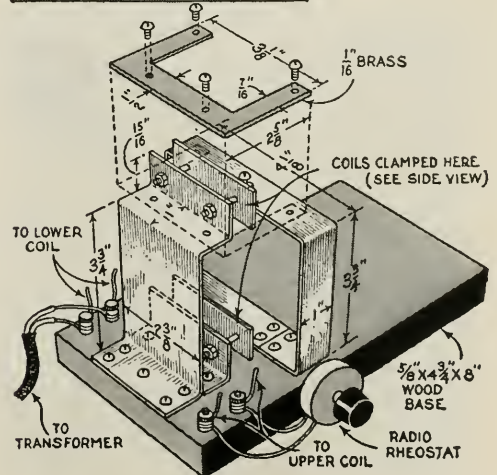
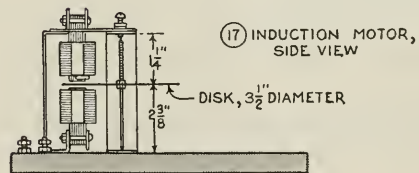
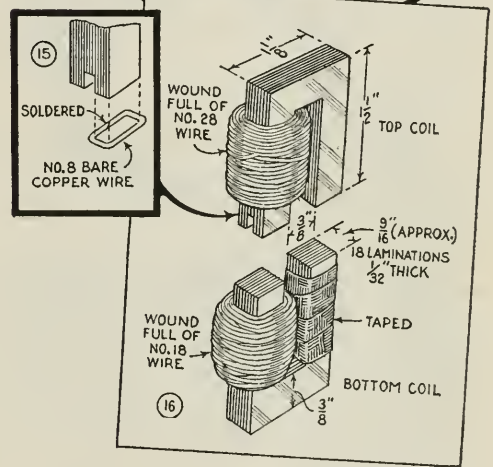
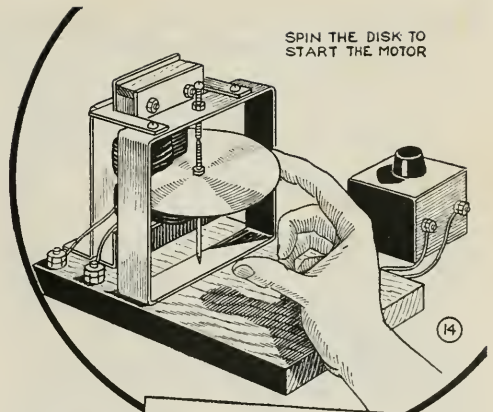

Easy Way of Mounting Reflector on a Lamp Socket

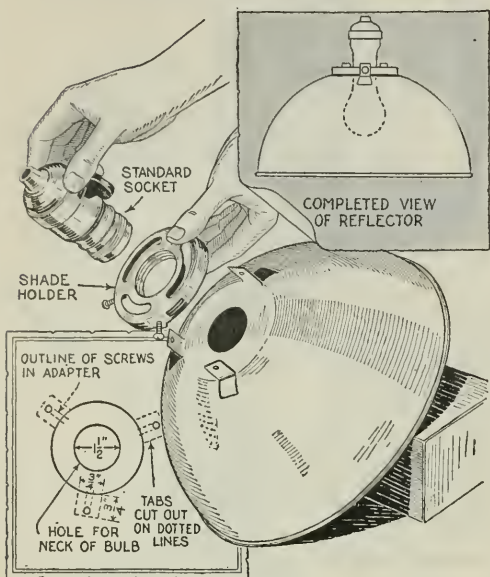

When you have occasion to attach a homemade reflector, such as the type made from an aluminum mixing bowl, to a lamp socket, try the method shown. First get a regular glass-shade holder of the type that screws into the end of the socket. Then form tabs in the reflector and bend them up and drill them to take the screws in the holder.

Simple Tester for Short Circuits

If a lamp or some appliance in the home is blowing fuses, you can make a tester to locate the trouble. Just take a short elec-

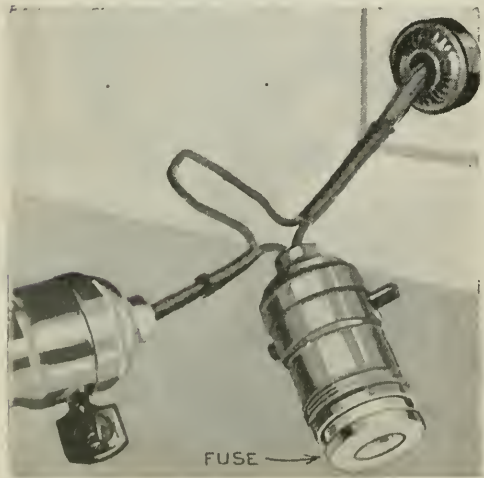

tric cord with a plug on one end and a socket on the other. Remove the insulation in the center and connect a socket containing a fuse, preferably one of low amperage, to one of the wires. To use the tester, remove all appliance wires and then plug in the tester to each one in turn. When the faulty appliance is found the fuse in the tester will blow.

Time Switch Operates Appliances in Your Home

Here is a simple time switch that anyone can make to turn on a radio, toaster, electric iron or coffee percolator at a given time. All you need is an alarm clock and a mercury switch. If desired, the latter can be made from a small phial. This is at-

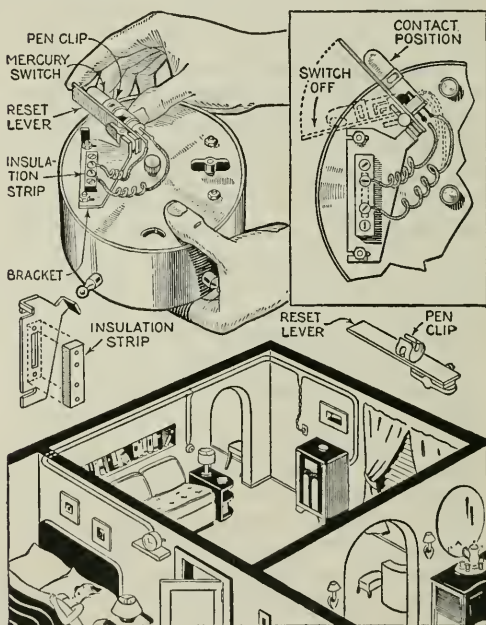

tached to a strip of heavy brass, which is in turn soldered to the alarm winding key after the latter has been removed. In use, the alarm is wound just enough to tip the switch, after which further winding is unnecessary as resetting the switch by pulling down the arm winds the alarm. A stop pin must be soldered to the back of the clock to check movement of the arm after the switch has been tipped. The switch can be used to turn off an appliance by simply reversing the position so that the mercury flows away from the electrodes when the alarm tips the switch.

Motorized Switch Flashes Lights in Sequence

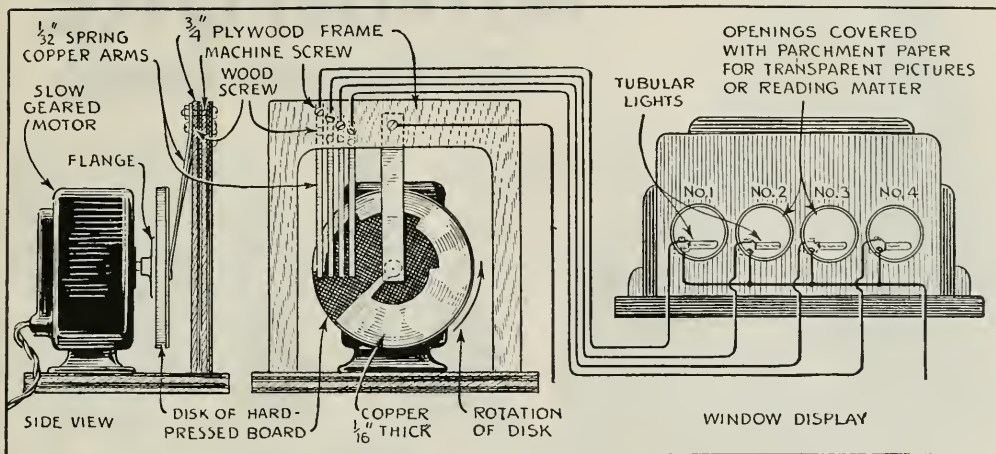

An eye-catching window sign can be made to spell out a single four-letter word, or it will display a series of illuminated pictures or advertising copy in sequence. The display unit may be a rectangular box divided into four light-tight compartments. A single opening in each is covered with ground glass or simply parchment, and the letters or figures to be displayed are mounted behind it so they cannot be seen until a lamp inside is illuminated. In operation, the light in compartment No. 1 flashes on, then, after a short interval, the lights in 2, 3, and 4 go on in sequence. Each lamp remains lighted until all four are on. Then after another interval all four

lights go off simultaneously. In a few seconds the cycle is repeated. A speed-reduction motor is needed if the switch is mounted directly on the shaft, or the switch can be mounted on any speed-reducing unit driven by a motor. The two wires having unconnected ends go to the current supply to operate the lamps. For this purpose, you can use a 6-volt storage battery, providing small 6-volt lamps behind the parchment windows of the sign box. However, if you use 110-volt current in this circuit, it will be necessary to install a line filter especially designed for sign flashers to eliminate interference in near-by radio receivers.

Extra Binding Posts on Terminal of Small Transformer

In experimental work where it is sometimes necessary to attach several wires to one binding post of a small transformer or battery, drill several holes in a strip of brass and fasten it to the terminal. This

will enable you to attach the wires individually with small bolts in the holes of the strip so that they can be connected or removed without disturbing the others.

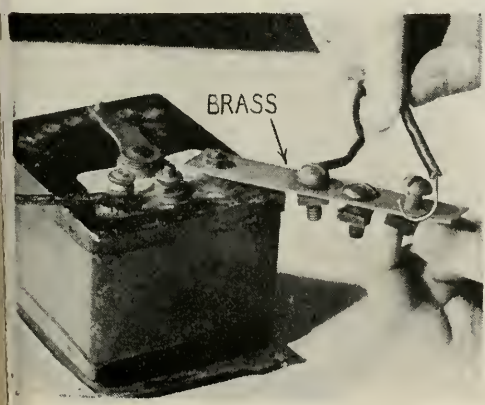

Prongs of Electric-Cord Plug Twisted to Get Good Grip

When an electric cord plug does not fit snugly into the connecting socket, twist each one of the prongs slightly with a pair of pliers. This will cause the prongs to fit tightly in their sockets so that they make a good electrical contact with them.

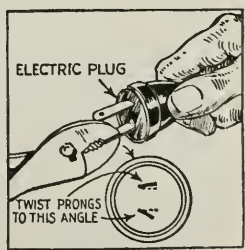

MINIATURE *in trays, bowls*

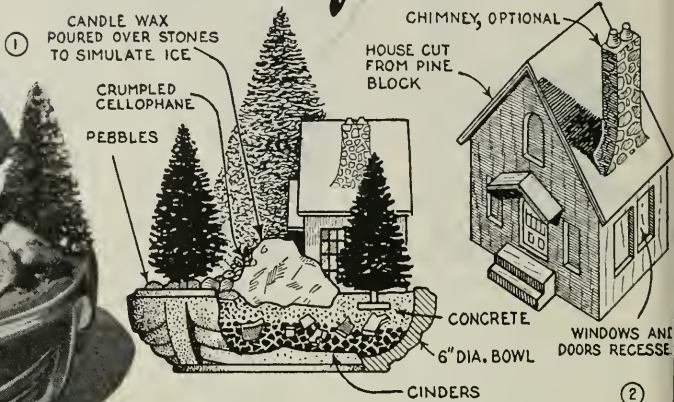

By R. W. MADDEN

WHETHER it's a fairy house, garden or baryard scene, or almost any other subject of your own liking, no special artistic talent is necessary to design and make miniature gardens in bowls and trays, which are highly attractive ornaments on wide window sills, in wall niches or on small tables. The plants either may be artificial or they may be real, depending on what is simulated. Other props such as fences, gates, buildings, wells and garden

furniture can be made from odds and ends. Small animals, birds and other tiny porcelain figures of correct proportional size can be picked up in the dime or variety store. Small pebbles represent stones and large ones simulate rocks. A little portland cement mixed with water goes a long way as mortar for building walls, and the use of plaster-of-paris should not be overlooked.

First of all you decide where you want to place the tiny garden and how large a

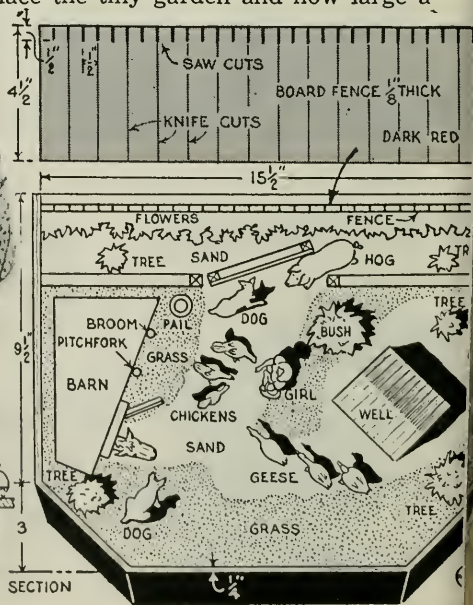



later painting it blue and gluing a piece of Cellophane over it to look like ice. Paraffin, dropped from a lighted candle over the stones and pebbles, looks surprisingly like snow.

The barnyard scene in Figs. 3 and 4 was built on a small wooden base of plywood especially shaped to fit in a wall niche as in Fig. 10. The fence, gate, well top and barn front were made from $\frac{1}{8}$ -in. wood available in orange boxes. These, as well as the trees were glued and bradded to the base. Earth is simulated by a layer of papier-mache, which can be made by soaking strips of newspaper to form a pulp, and adding glue. When this has been applied to the plywood it will stick, and when dry it is painted with glue on which sand is sprinkled for paths, and sawdust, dyed green, for grass. Various details for a barnyard scene are shown in Figs. 8 and 9. Note that the head of the horse is glued to a small box which is attached inside of the cut-off barn, just behind the door opening. As the inside is in shadow, the fact that the horse is incomplete will not be noticed. The fencing and well shown in Fig. 9 can be used for other scenes besides the barnyard.

A cozy corner in a garden is depicted in Fig. 6, which includes a garden seat, gate trellis and a gazing ball. Details showing the construction of these parts and their arrangement are given in Figs. 5 and 7. The gazing ball is a silvered Christmas-tree ball, the neck of which is inserted in plaster-of-paris, put into the socket of a miniature candlestick. Model airplane cement is ideal for gluing the parts of the gate and other garden furniture. In this case live plants are used, and the pan, which was used in place of a bowl, was dropped into a large hole cut in a "stage" so that the edge of the pan, painted green, projected just over the edge of the hole. For miniature gardens it is best to select plants that do not require much water. No flowers were used in the model shown. Ferns and small pot plants last longer and require less care. The plants in this particular garden cost \$1.20. For illumination of a miniature garden placed in a wall niche, a small lamp arranged over the garden as shown in Fig. 11, will set it off to best advantage, a light shield or deflector being provided so that observers do not see the lamp itself.

supply you with the needed materials. The soil should not be pressed down but merely crumbled through the hands when filling.

Figs. 1 and 2 show a winter scene in a 6-in. bowl. A layer of cement and sand, mixed with enough water to form "mud" is poured over a layer of cinders. The house, which was cut from a block of wood and painted previously, and also the pine trees, which are simply Christmas ornaments with snow-tipped branches, are set in the soft cement. A few stones and pebbles can be added. You can make a small depression to represent a pond or lake,

Junior's ICE SCOOTER

gives thrilling ride

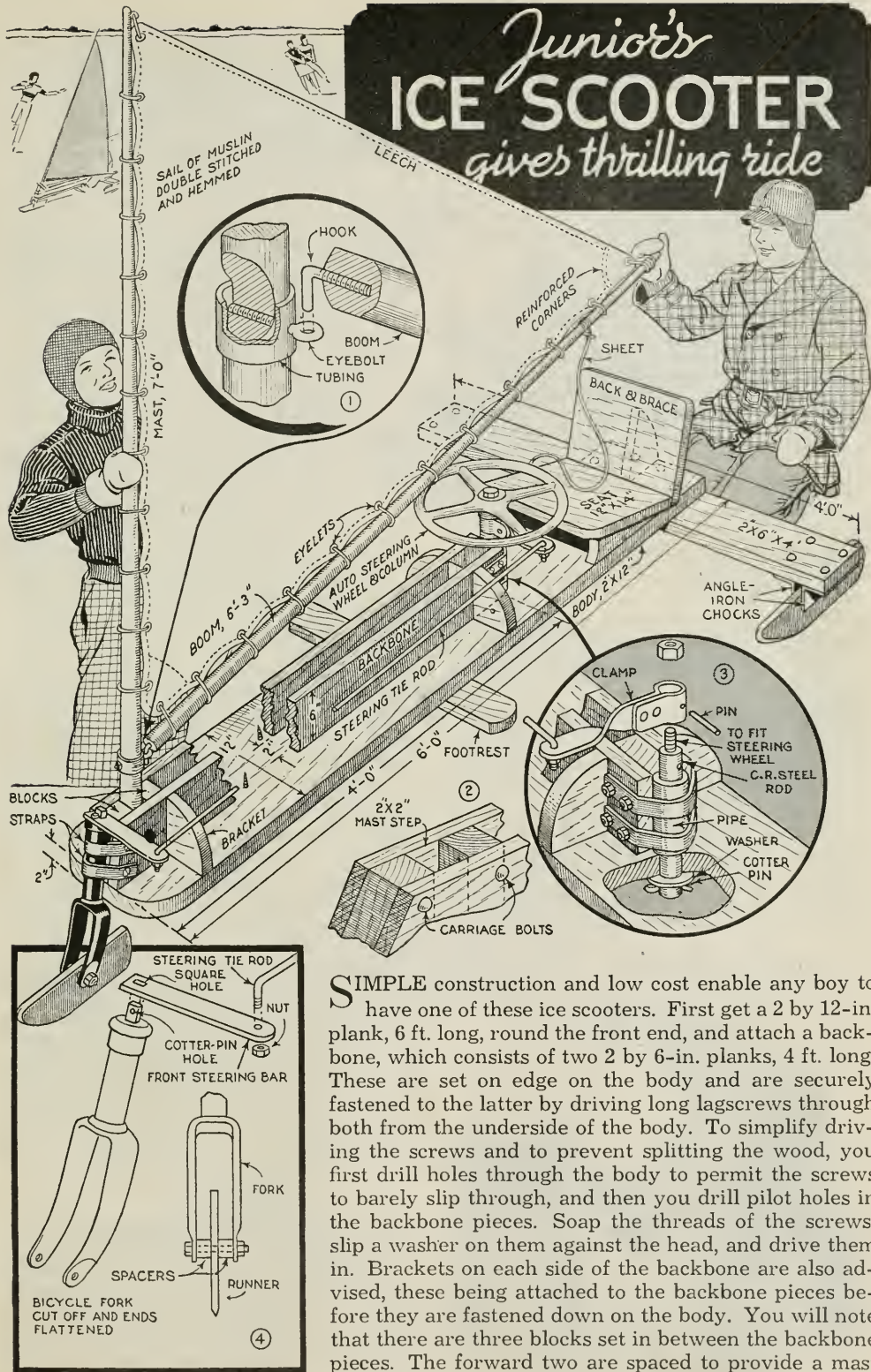

SIMPLE construction and low cost enable any boy to have one of these ice scooters. First get a 2 by 12-in. plank, 6 ft. long, round the front end, and attach a backbone, which consists of two 2 by 6-in. planks, 4 ft. long. These are set on edge on the body and are securely fastened to the latter by driving long lagscrews through both from the underside of the body. To simplify driving the screws and to prevent splitting the wood, you first drill holes through the body to permit the screws to barely slip through, and then you drill pilot holes in the backbone pieces. Soap the threads of the screws, slip a washer on them against the head, and drive them in. Brackets on each side of the backbone are also advised, these being attached to the backbone pieces before they are fastened down on the body. You will note that there are three blocks set in between the backbone pieces. The forward two are spaced to provide a mast

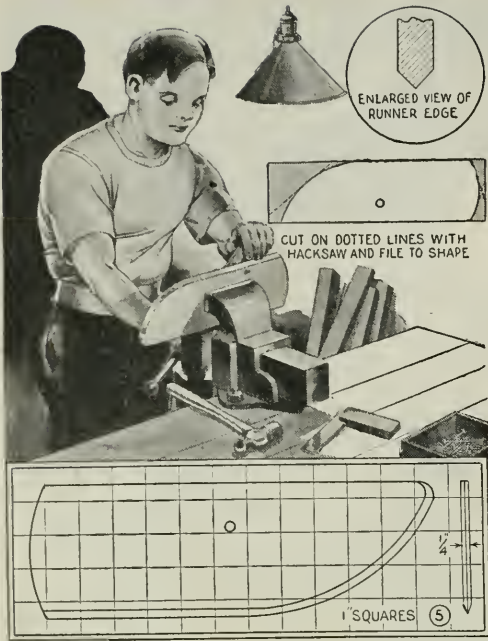

step and the aft one helps to support the steering column. The blocks are fastened in place by means of carriage bolts as shown in Fig. 2.

The front runner support is an old bicycle fork, which is cut off, flattened and drilled to suit as shown in Fig. 4. The fork is clamped to the front end of the backbone with heavy flat-iron straps, these being welded to the fork, or bolted to it with short machine screws so they will not interfere with the inside piece that turns. The steering post is similarly attached with flat-iron straps. It consists of a length of

pipe which serves as a bearing for a steel rod. A short arm about 6 or 8 in. long is attached to the steering fork, and one of similar length is pinned and clamped to the steering column, both extending out toward one side and linked together with a $\frac{1}{4}$ or $\frac{3}{8}$ -in. iron connecting rod. This is threaded at both ends, after which the ends are bent over at right angles to fit holes in the arms. Be sure that the pivot points work freely. Two nuts on each end, locking each other, are better than only one nut, which is likely to come off.

Runners are all the same size. They are cut out of $\frac{1}{4}$ -in. boiler plate by means of a hacksaw, and the lower edges are filed to a sharp edge as shown in Fig. 5. One of the runners is attached to the front fork by means of a steel rod, threaded at both ends for nuts, and a couple of spacers that center the runner between the ends of the fork. The spacers may be cut from pipe. The rear runners are pivoted between two lengths of angle iron bolted to the ends of the rear crosspiece, which is a 2 by 6-in. plank, 4 ft. long.

For a sail you can use muslin, double stitched and hemmed. The corners should be reinforced for strength. Eyelets (grommets) are inserted along the mast and boom edges of the sail for light rope lacing. The boom should extend upward at an angle sufficient to clear the rider's head as well as the steering wheel. Fig. 1 shows how a hook on the bottom fits an eyebolt through the mast. However, an eye welded to a ring that can be clamped to the mast is preferable because any hole through the mast tends to weaken it.

Ice Marked Off for Hockey Game With Salt and Ochre



To mark the ice with indelible boundary lines for a game of hockey, mix equal parts of salt and red ochre powder and apply as shown in the drawing at the left. The salt will melt the ochre into the ice to leave a line that is easy to see and will last as long as the ice remains frozen.

Waxing Ski Runners

A chemical heat pad will be found effective in warming ski runners for the application of a coat of wax. When the wax is put on the warm runners it will flow freely and can be rubbed down to a smooth finish in a few seconds.

"Payload" BOBSLED

has pilot's seat at rear

Steered from the rear, this sled has more room than the conventional type of the same size, as space forward, which ordinarily would be occupied by the steering gear, is utilized for a passenger. Also, this design permits placing the sleds closer together, which makes steering easier, and the pilot has a clear view over the heads of the passengers. Construction is relatively light without sacrifice of strength. The steering gear consists of a standard auto wheel mounted on a steel-tube post having a crossarm welded on the lower end to which tie rods are bolted. The front sled turns on a ball-and-socket joint, permitting it to follow uneven contours without strain on the chassis. This joint consists of a king pin with an integral ball and collar, and a steel socket split and assembled with bolts. The ball-and-socket joint taken from the radius rods of a model-T Ford can be adapted to this purpose. The sled runners are 14 in. apart and the rear sled is connected to the chassis with a long bolt through eye bolts in the upper and lower cross members

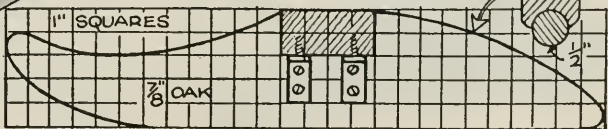
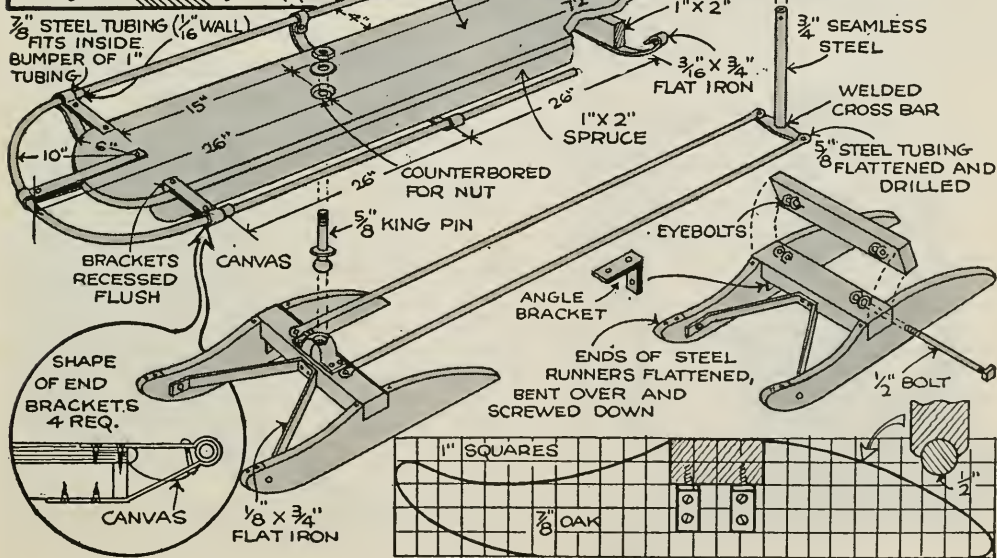
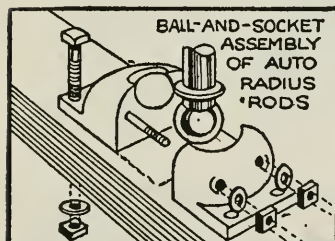
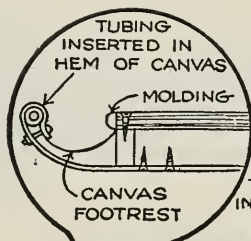
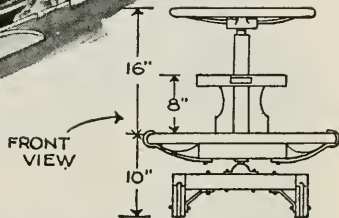

Apron Around the Tennis Table Prevents Balls Rolling Under It

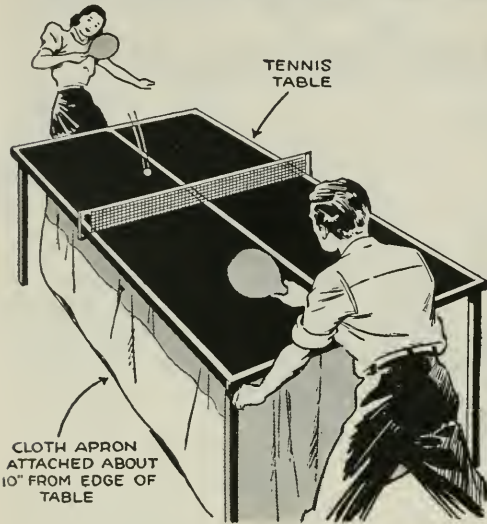
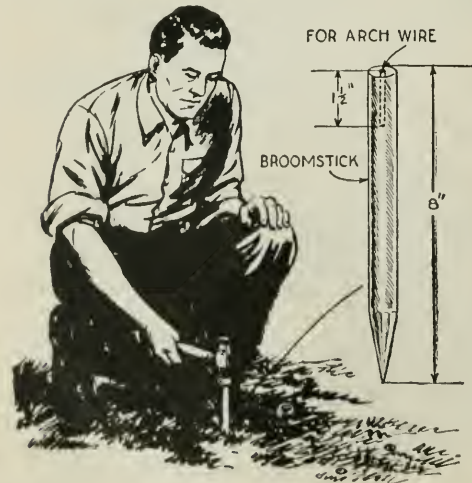

Table-tennis players who wish to avoid crawling under the table to retrieve a ball can do so by tacking a cloth apron to the table so that it extends to the floor. The cloth should be placed about 10 in. in from the table edge to prevent the players from stepping on it.

Croquet Arches Located Easily by Stakes in Lawn

To avoid the trouble of relocating the proper positions for croquet arches, which have to be removed each time after playing, drive stakes into the ground in the proper locations to take the arches. The



stakes can be made from lengths of broomstick and drilled in the upper ends to receive the ends of the arches. Being flush with the top of the ground, the stakes will not interfere with use of the lawnmower, and there is no possibility of anyone tripping over them.

Tennis Nets Given Even Tension by Old Auto Springs

It's a simple matter to keep an even tension on tennis nets by using old auto springs as indicated. These are bolted to the outer surface of the supporting posts

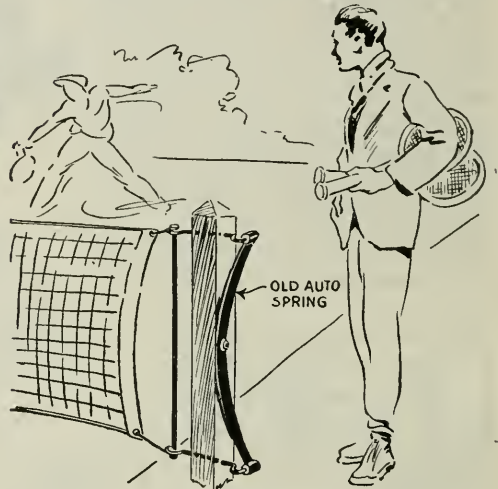

with small iron rods leading from the eyes through holes in the posts to a vertical iron rod which is fastened to the end of the net.

Tennis Net of Chicken Wire Lasts Indefinitely

The park department of a mid-western city has reduced costs on tennis courts by substituting regular chicken wire for regulation nets. The wire is tightened occasionally. It does not shrink nor stretch with changing weather and lasts indefinitely. The wire is painted and then padded along the top edge with canvas.



Regulation Size TENNIS TABLE

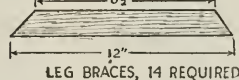
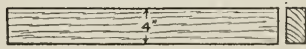
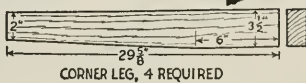
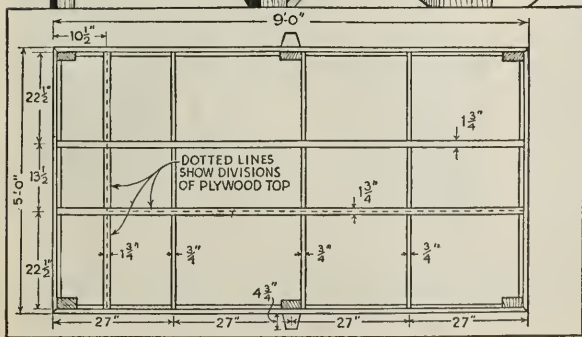
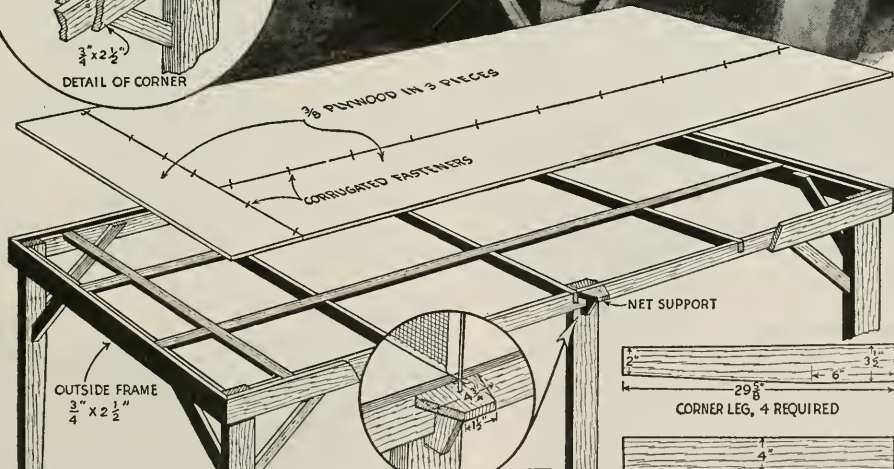
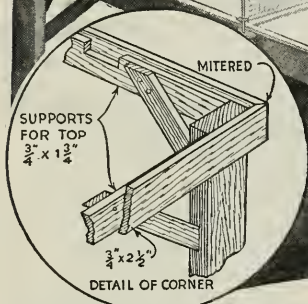
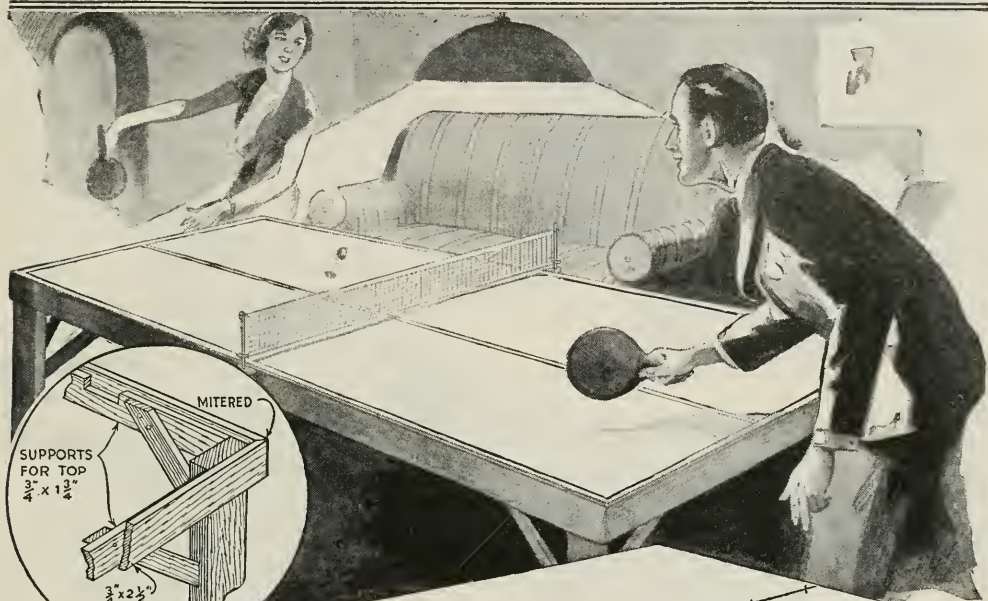

Well-built tennis table of regulation size has a $\frac{3}{8}$ -in. plywood top made from two 3 by 8-ft. sheets; it is fastened with $\frac{3}{4}$ -in. screws at 6-in. intervals; all screw holes are countersunk, filled with plastic wood and sanded smooth; after finishing the top, it is painted a dull dark green with a $\frac{3}{4}$ -in. white stripe around the edge and along the center lengthwise

Scraper for Croquet Court Made From Bed Rail

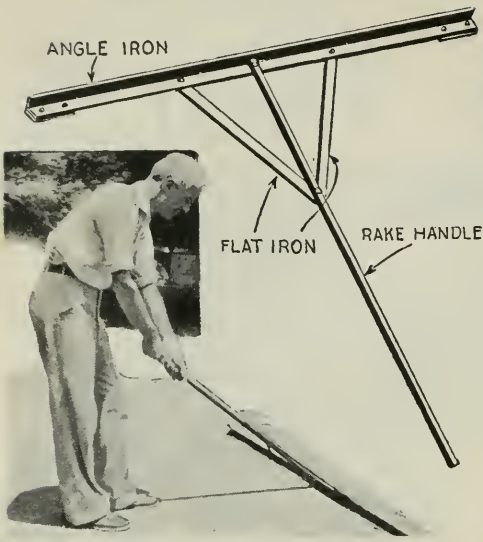

The side rail of an old iron bed or any piece of heavy angle iron makes a handy scraper for dirt croquet courts, when fitted with a wooden handle braced as shown. The weight of the bar makes a smooth surface without bearing down on the handle.

Erasers Provide Tips on Cues

When a new tip is needed on a cue of the type used with toy pool tables, a slip-on eraser will serve the purpose nicely. Sand or grind off the end of the eraser to the shape shown, and then glue it on the end of cue.

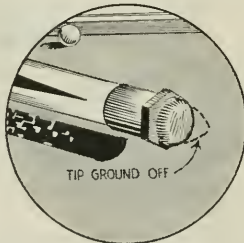

Helmet Hanger Saves Space

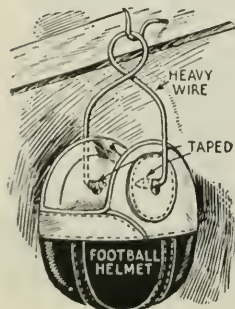

The problem of finding storage space for helmets used by a football team was solved by one coach who used wire hangers of the type shown. These permit the helmets to be suspended from a wall or other place

instead of using shelves. Also, the hangers make it possible for the helmets to dry out quickly after a hard-played game. The lower ends of the hanger are either taped or covered with rubber tubing to prevent damaging the helmets.

Flat Boat Inverted Over Oil Drum Provides Handy Diving Board

While vacationing at an inland lake where there was no diving board at hand, the members of a camping party inverted an old flat boat over an oil drum, which

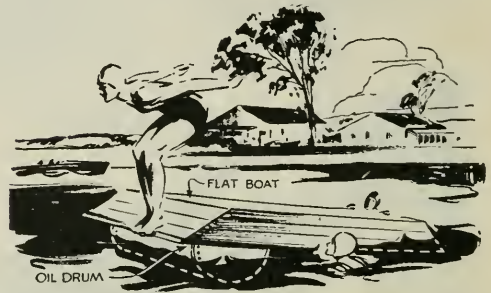

was sealed tightly. The drum supported one end of the boat above water so it served nicely as a temporary diving board.

Tricycle Pedals Shorten "Reach" for Small Children

To make the "family" tricycle as easy for the smallest member to pedal as for the largest, one man provided oversize treads for the pedals. Consisting of two blocks of

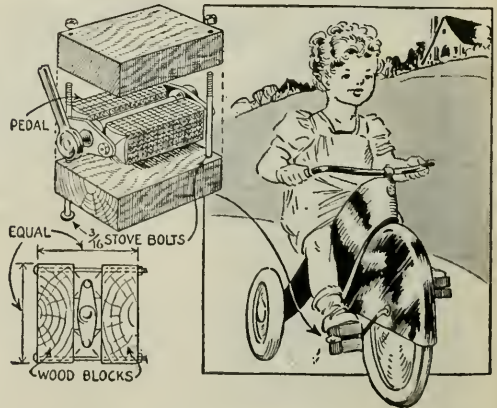

wood clamped to each pedal with stove bolts, these auxiliary treads can be attached or removed in a jiffy.

It's KITE TIME again!

REQUIRING no tails to balance them in flight, here are three easy-to-make kites which will give you a lot of fun both in constructing and flying them. While dimensions given for the French war kite, Fig. 1, should be followed closely to assure perfect balance, the kite can be made any size provided the dimensions are increased proportionately. The sticks should be lightweight wood such as bass, pine, spruce

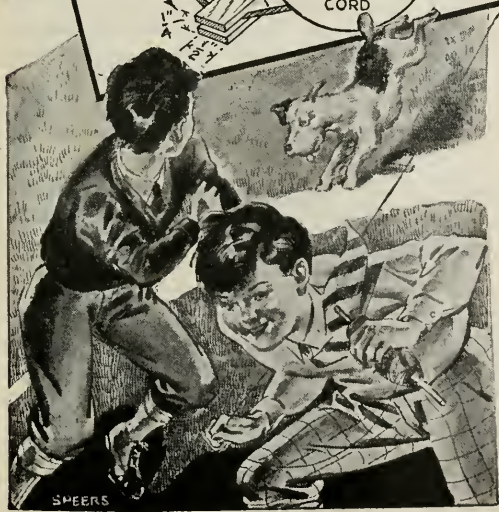
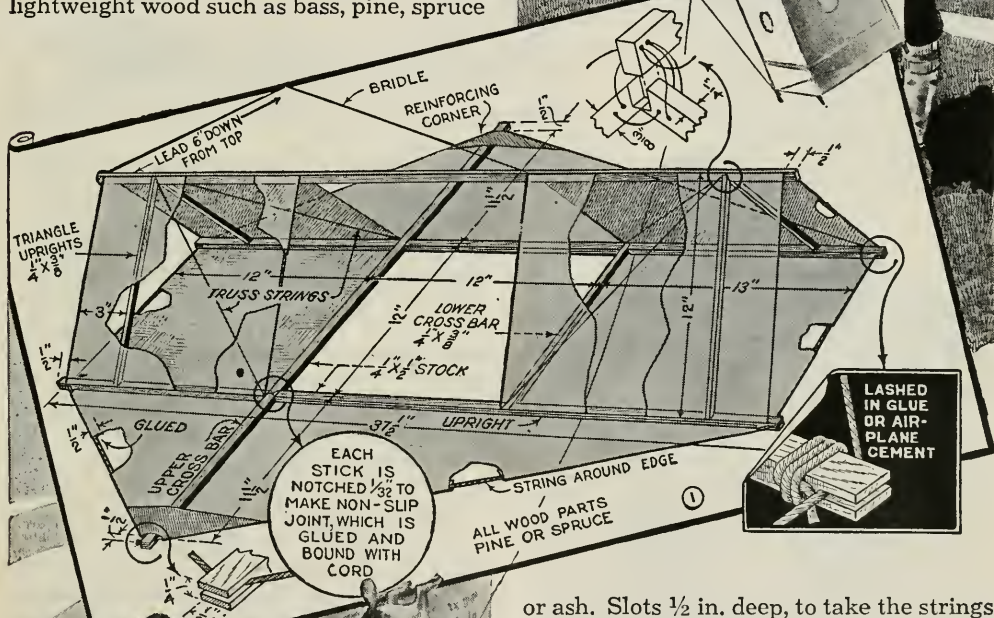

or ash. Slots $\frac{1}{2}$ in. deep, to take the strings, are cut in the ends of each stick forming the outer edge of the kite.

Now, begin assembling the pieces by laying the two upright sticks on the table, spacing them 12 in. apart, and lay the upper crossbar over these in the position shown in Fig. 1. The sticks are notched $\frac{1}{2}$ in. where they intersect and are cemented with shellac and bound together in the manner shown. The lower crossbar is next notched to lap slightly over the uprights, being glued and bound as before. Now, to keep the kite from buckling, run a string through the slots in the sticks and lash the ends as shown. The center upright is fitted in place, this being supported at each end with notched sticks to form a

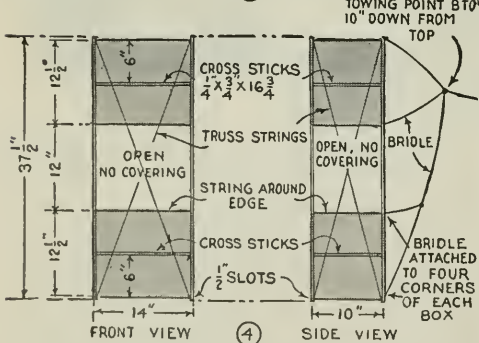
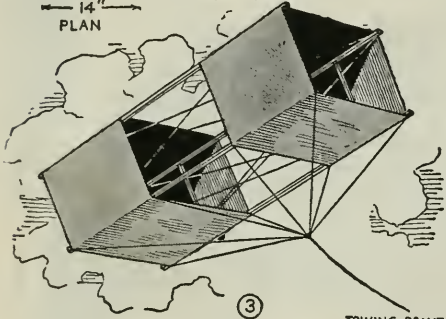
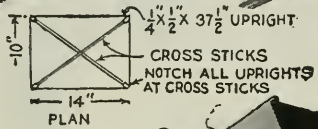
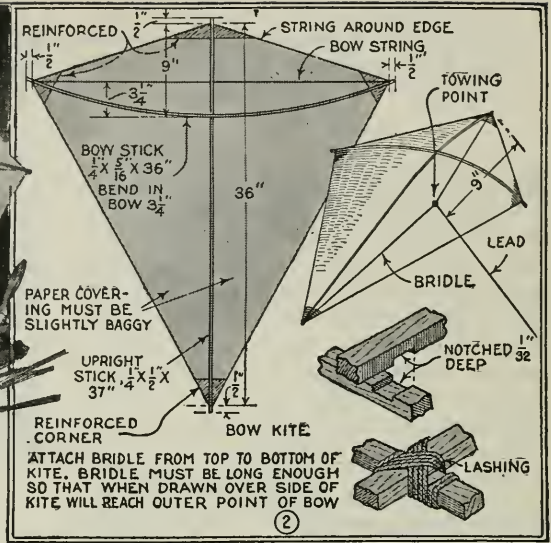
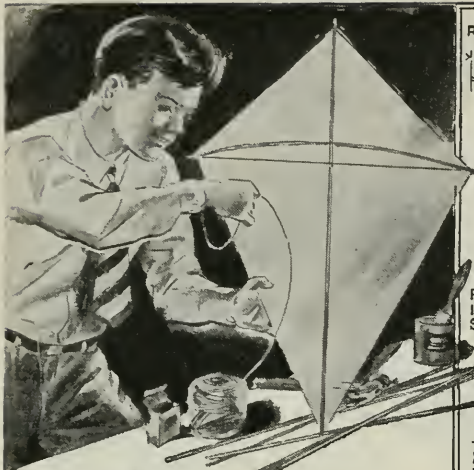

triangular shaped assembly. When dry, run a string around the inner edges of the triangles to support the covering and, then brace them with several cross strings stretched on each side. Parchment or heavy-grade kite paper is the best covering material. Cellophane can be used also.

Cover the three sides of the two triangles and fold and glue the edges of the paper over the string. The covering of the

lower triangle is made $\frac{1}{2}$ in. wider than that on the upper one. This is done to correct balancing. The capacity of the wing surface should be smaller than the surface covering of the triangle. This prevents the kite from diving. The ends and center, you will notice, are left open. The wings are covered next, turning and gluing the edges over the strings as before. Do not pull the covering tight, but allow it to bag slightly to catch all the air currents. Protect the corners of the wings by reinforcing with an extra covering of paper. The bridle should be attached to the top and run to a point two-thirds the way down. The towing point should be 4 to 6 in. from the top.

The simplicity of the bow kite, shown in Fig. 2, makes it very easy to construct. Here a cross strip, bowed $3\frac{1}{4}$ in. with a cord stretched through slots made in the ends, is notched $\frac{1}{2}$ in. at midpoint as shown, to fit a similar notch cut in a center upright. When these two are joined a string is run around the outside of the kite and then the covering is applied as before.

To make the box kite in Fig. 3, four slotted uprights of identical size are assembled into two pairs of corresponding units by notched cross sticks. The units are joined then, into box-shape, and truss strings are stretched from the corner slots to keep it rigid and straight. The paper covering is made $\frac{1}{2}$ in. wider on the lower box than on the upper. The towing point should equal the length of the kite.

FAST-WINDING REELS

give new thrills to kite flying

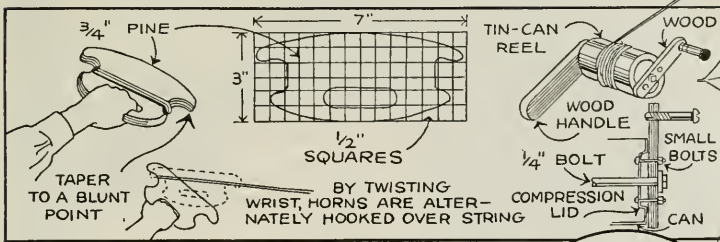

ANYONE can make the flat horn-type string winder shown above, which works by a simple twisting motion of the hand. Another one, which is quickly improvised, is the two-handle affair at the right; it is merely a piece of pine recessed at both ends and drilled for dowels. Below, are shown several other types that are more elaborate and have been designed especially for speed, even winding and ease of handling.

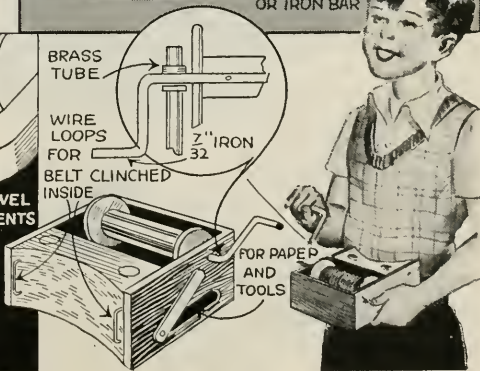
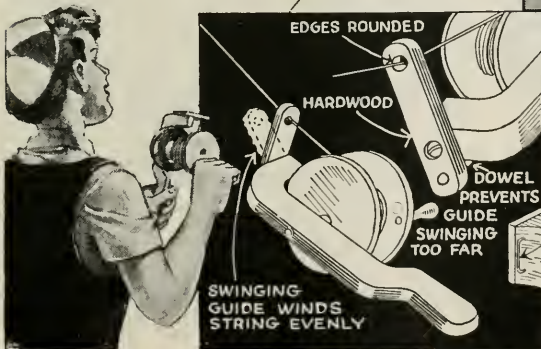
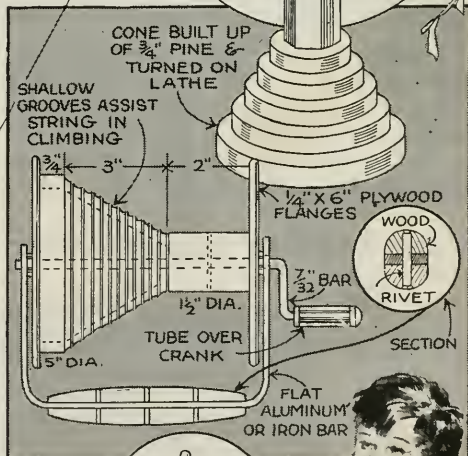
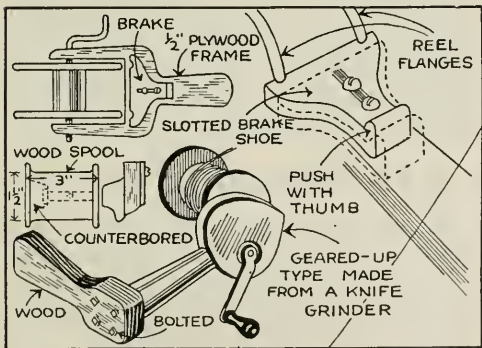
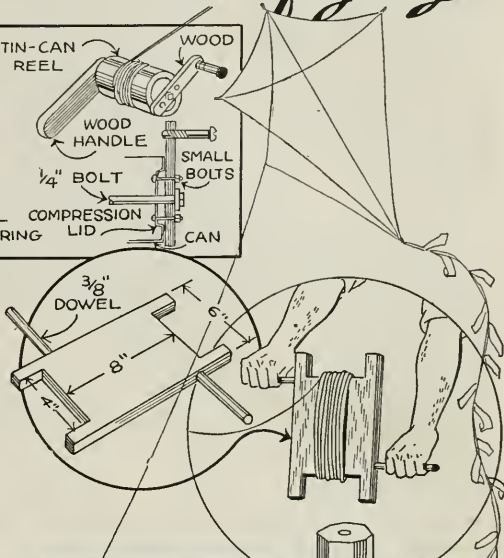

Dropping Parachutes Adds Zest to Kite Flying

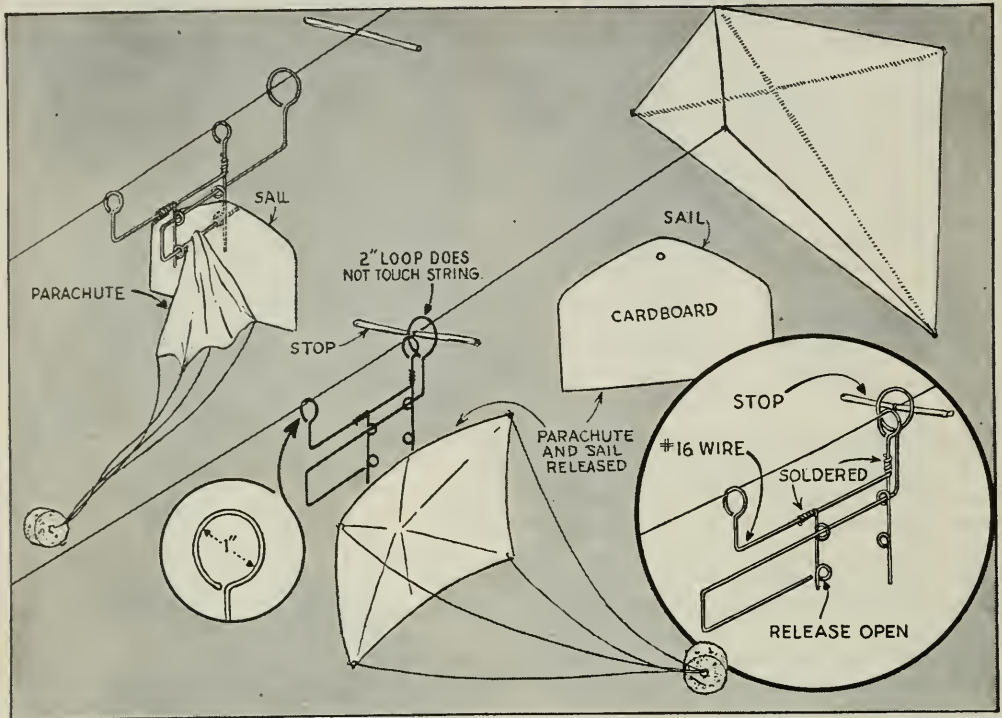

Parachutes carried up to a lofty kite and automatically released when the carrier hits a cross stick tied in the kite line, will keep up a lively interest. The carrier must be lightweight and there should be very little friction on the line so that ascent of

the carrier will not be impeded. A cardboard sail and a parachute are held on a sliding member, which is pushed back when it strikes the cross stick, releasing sail and parachute. By going over the details you will see how the device works.

Scale Markings on Kite String Aid in Measuring Distance

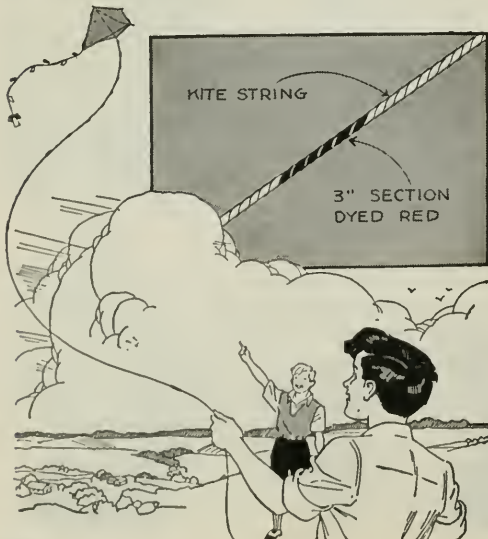

When a group of boys are flying kites in neighborhood competition meets to see who can pay out the most string and fly the greatest distance, it will help to mark the string with red ink at intervals of 25, 50 or 100 ft. This is much better than the usual method of tying small ribbons to the string to serve as markers. Red is also highly visible and the marks can be seen for quite a distance, although the marks can be counted as the string is let out.

Novel Holder for Kite String

A wooden cleat riveted to a belt to go around your waist provides a novel holder for kite string. The string is wound on the cleat and is unwound as desired. If the end is tied to the cleat, there will be no danger of the kite getting away.

Sight on Archery Bow Improves Your Aim

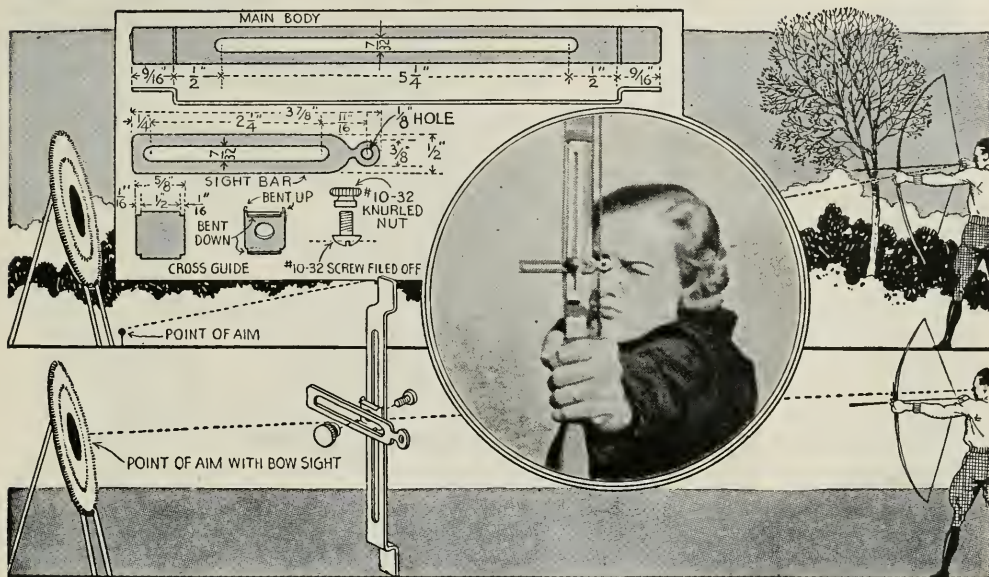

Taped to your archery bow, this adjustable sight will be found a more satisfactory method of shooting an arrow than the "point-of-aim" method, as you aim right at the bull's-eye instead of sighting at a marker on the ground in front of the target. Thus, any variation in bowing or in distance is not likely to affect your aim. The parts of the sight are made of heavy sheet steel or brass and are cut to the shape and sizes given in the detail. When

finished, they should be polished with fine emery cloth or steel wool. Nickel or chromium plating will improve their appearance. The sight is mounted on the back of the bow with the sight end of the cross bar extending to the left. It is adjustable either vertically or horizontally. Once set for a certain shooting distance, the sight may be marked so that when the same distance is shot again, the correct adjustment can be made without any trouble.

A Versatile Homemade Bow Sight

This simple, lightweight device has all the adjustable variations of an expensive bow sight, and with an average weight bow

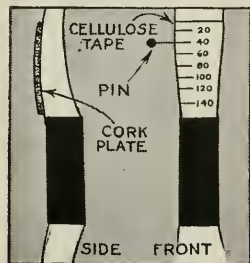

is fairly accurate for distances well over 100 yards. Cut from a strip of cork gasket material 1 in. wide by 6 in. long, the sight is fastened with adhesive tape to the back of the bow just above the leather grip.

After gluing the cork in place, put a strip of cellulose tape on the belly of the bow opposite the cork. Stick a 2-in. round-head hat pin into the cork so

that the head projects $\frac{1}{2}$ in. beyond the left edge of the bow. Then, by the trial-and-error method at various distances, determine the proper position of the pin for each distance and mark these positions in ink on the tape, numbering them accordingly. A coat of clear shellac will protect both the cork and the scale.

Making Arrows Visible

To locate your archery arrows easily after shooting them, wrap bands of tinfoil on the shafts just in front of the feathers, and shellac the bands to prevent tearing. The tinfoil will glisten in the sun so that an arrow can be seen at a distance of many yards. This method is especially effective in cases where the arrows happen to fall in tall grass, weeds, etc.

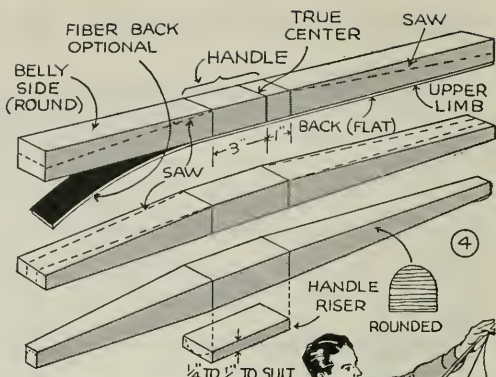
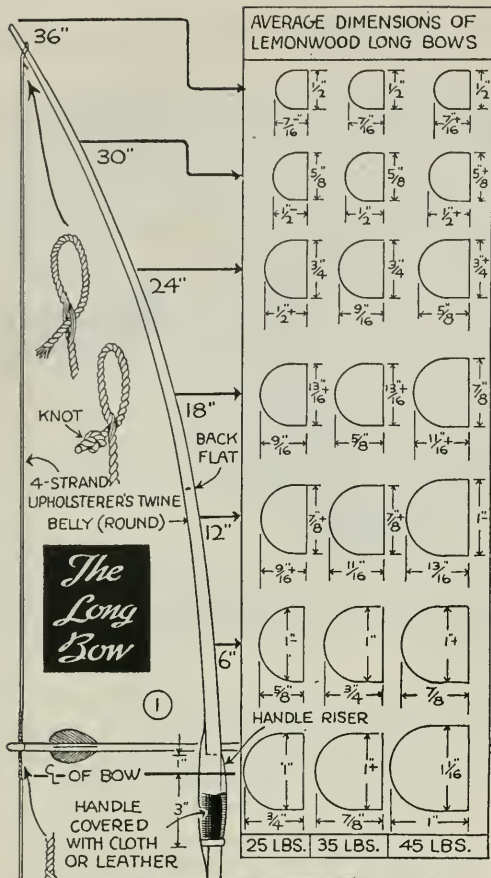

FORMING THE LONG BOW
TAKE DIMENSIONS FROM BOW SECTIONS AT LEFT



SIZE OF TACKLE		
REACH	ARROW	BOW *
54-56 IN.	22-23 IN.	NOT UNDER 4'6"
57-59 IN.	23-24 IN.	" " 4'9"
60-62 IN.	24-25 IN.	" " 5'
63-65 IN.	25-26 IN.	" " 5'3"
66-68 IN.	26-27 IN.	" " 5'6"
69-71 IN.	28 IN.	" " 5'10"

* LONG BOWS. FLAT BOWS CAN BE A LITTLE SHORTER IF DESIRED

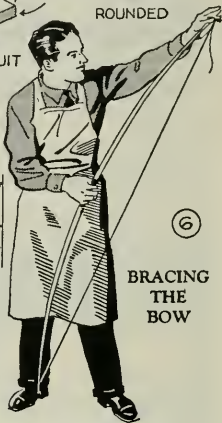

SHOOT A

WHETHER you try to land six in the gold for a perfect fifty-four or take your archery with a dash of small game hunting, you will find keen enjoyment in this ancient sport. Making the tackle is simple.

Size of tackle: The first thing to know is what size of bow and length of arrow to use. This depends entirely on your physique, and particularly your reach. If your reach is 64 in., you can use an arrow 25 to 26 in. long, with a bow not less than 5 ft. 3 in. from tip to tip, Fig. 5. The weight of the bow, that is, the number of pounds pull required to draw it, depends on your muscular development. Most men can draw a 50 to 60-lb. bow, but a 35 to 40-lb. bow is the best weight for general shooting, and good scores can be made with the 25 and 30-pounders.

The long bow: The long bow has a deep or "stacked" body, which is generally recognized as the best type of bow shape. A stave of lemonwood for a long bow will cost you about one dollar. Square up the stave to a little over the dimensions at the handle of the weight bow you intend to make. Bandsaw the wood, Fig. 4, and then round off the belly side with a plane or wood rasp. Cut

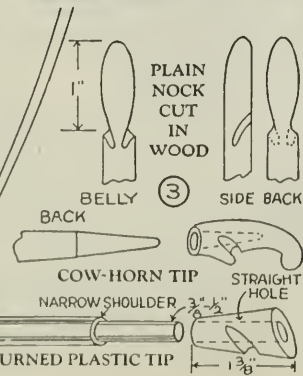
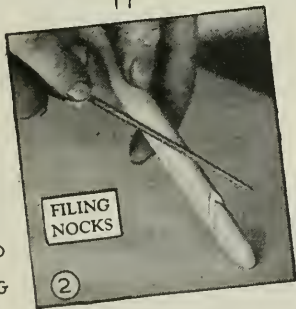

Forming the Flat Bow

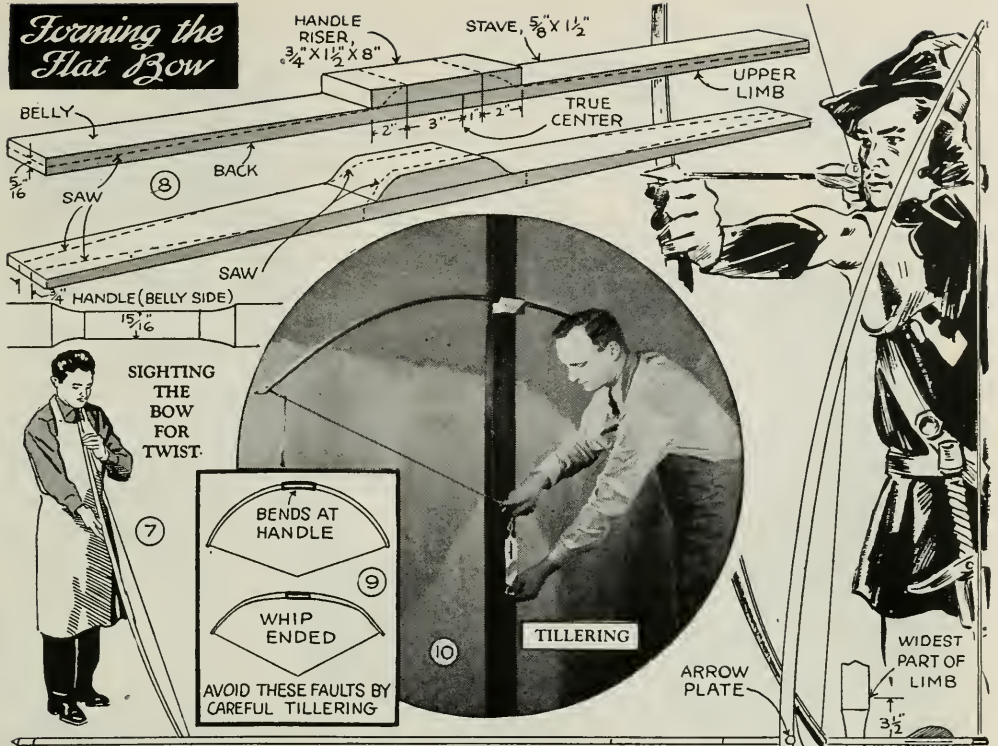

BOW FOR FUN

the nocks 1 in. from each end, Fig. 3, using a round file, Fig. 2. Make a bowstring from upholsterer's twine, as shown in Fig. 1, and brace the bow as in Fig. 6. When the bow is braced the height of the string from the center of the bow should be about equal to the width of the hand and thumb with the latter stuck out as in Fig. 28. You can now "tiller" it to check the bend of both limbs, at the same time measuring the weight with a spring scale, as shown in Fig. 10. Bend the bow gradually. Take off a shaving here and there to equalize the bend. Take your time. You can always take off more wood, but you can't put it back on again. The bow should be quite stiff for a distance of about 6 in. at the center, and should then curve evenly to the tips. The beginner's most common fault is to make the bow "whip ended," Fig. 9. Besides checking the curvature, sight down the bow as you work and note if the string cuts the center of the belly, as in Fig. 7. If it throws off to the side, your bow has a turn in it. This can be corrected by taking off wood opposite the turn.

If desired, you can back your bow with red or black fiber attached with waterproof glue before the shaping is started. Instead of cutting plain nocks, you may decide to purchase and fit a set of cow-horn tips, or, you may want to turn them from colorful plastic. It will be noted, Fig. 3, that plain nocks are not cut across the back of the bow as this would weaken the wood. The groove in horn or plastic tips, however, is let into the back.

The flat bow: The flat bow is easier to make than the long one

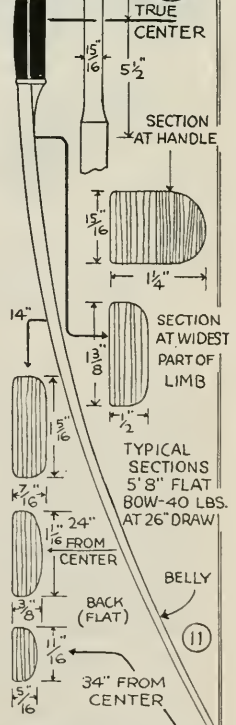

The Flat Bow

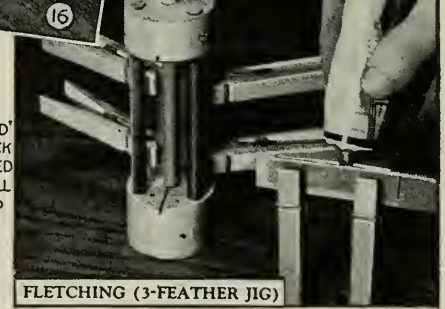
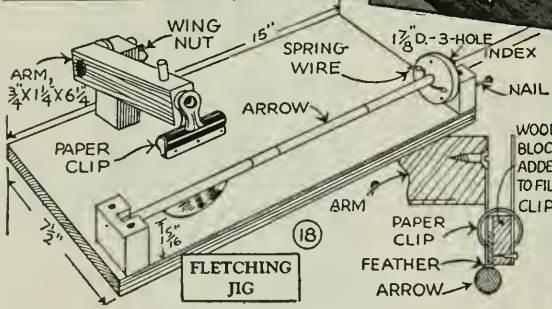
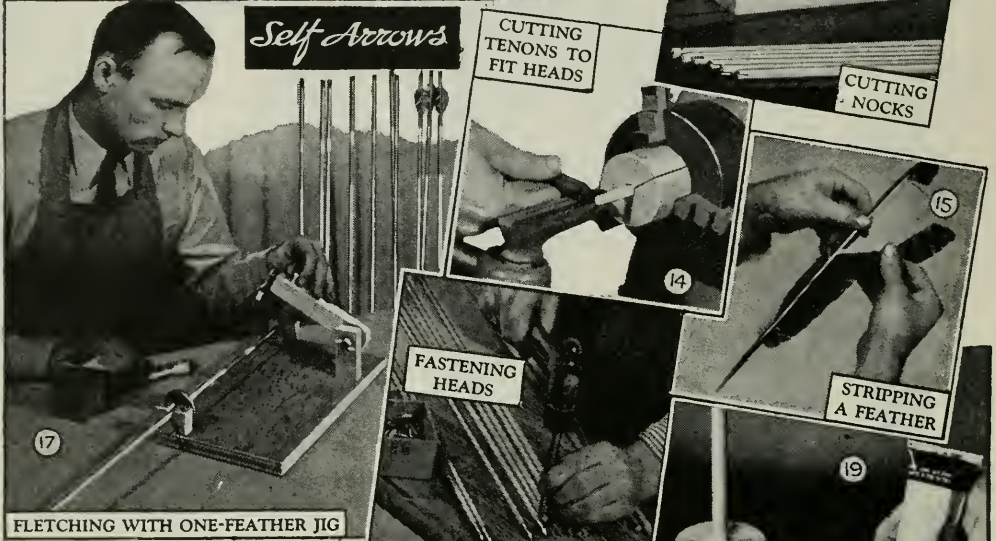
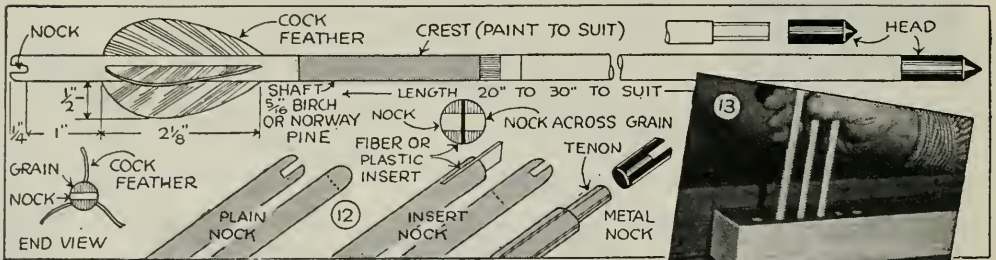

and can be 3 or 4 in. shorter for the same length arrow. The same general method of bandsawing is used, Fig. 8, but the belly side is only lightly rounded off. Typical sections of a 40-lb. flat bow are given in Fig. 11. The handle riser can be the same or of a contrasting wood to the bow itself. The narrow plate, which prevents wear, is inlaid, using a $\frac{1}{16}$ -in. disk of $\frac{1}{8}$ -in. plastic.

Self arrows: A "self" arrow is one made from a single piece of wood. The simplest way to make self arrows is to buy a construction kit, which includes the $\frac{5}{16}$ -in. dowel sticks, feathers and heads. Birch is the best wood to use. The various parts and dimensions of the arrow are shown in

Fig. 12. First put on the head. A number of different ones can be purchased, but for average target work the brass parallel pile head is most satisfactory. Cut the tenon on the end of the shaft by turning on a lathe, Fig. 14. If you are careful, the head will be a drive fit and will hold securely. If the head is a bit loose, anchor it with a few punch taps as shown in Fig. 16. Cut the arrows to the required length and then cut the nocks. Plain nocks can be cut easily by running the shafts over a circular saw, as in Fig. 13. The nock should be across the grain. If you want more strength at the nock, insert a thin slip of fiber or plastic. Aluminum or molded-plastic nocks are

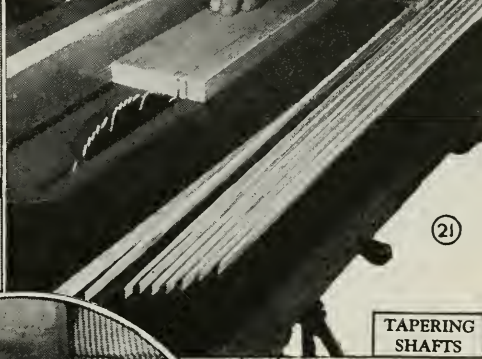
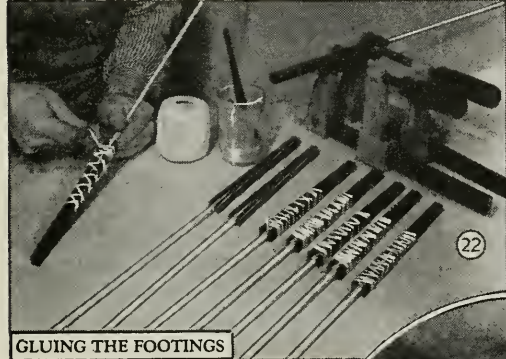
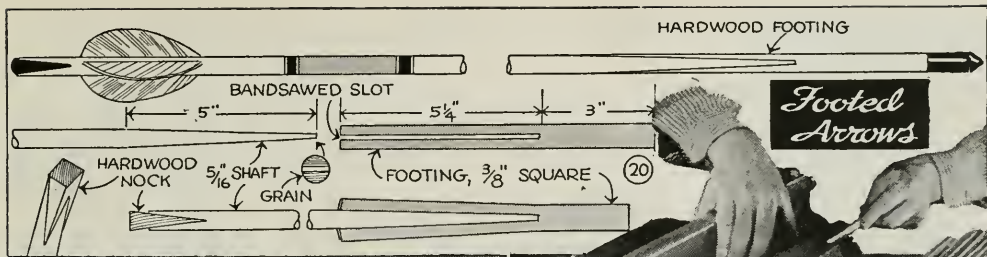

very attractive and are fitted by tenoning the end of the shaft the same as in fitting the head.

Fletching is the hard part of arrow making. However, if you use one of the jigs shown in Figs. 17 and 19, you will be able to turn out good work at a fair rate of speed. Turkey feathers can be purchased already cut, or you can strip your own feathers by grasping the vane at the tip and pulling outward, as shown in Fig. 15, afterward cutting the vane to the required shape. The one-feather fletching jig shown in Figs. 17 and 18 is built around a paper clip. A disk of plywood, which slips over the shaft, is drilled with three small holes to supply an indexing head, and is prevented from slipping by means of a piece of spring wire. One feather at a time is clamped by the paper clip and pressed into position. Any type of adhesive can be used. Celluloid cement has the advantage of quick drying and the ability to anchor on lacquer, thus allowing the shafts to be painted previous to fletching. Waterproof glue on bare wood is the most durable. In the three-feather jig, the feathers are held between metal plates, one plate of each set fitting into grooves in

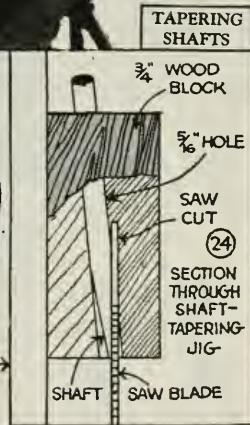

the top and bottom members. The upper ring is removable, being a press fit over the three spacing dowels.

Footed arrows: Footed arrows are more decorative and more durable than self arrows. The footing is made from any tough hardwood, and is slotted for a distance of 5 1/4 in., Fig. 20. Shafts are usually Port Orford cedar or Norway pine, and are tapered to fit the slot in the footing. Perfect tapering of the shafts can be done by the circular-saw method shown in Figs. 21 and 24. The taper should be made with the flat of the grain. The shaft is assembled to the footing with waterproof glue and the assembly is then clamped or wrapped with twine or rubber strips as in Fig. 22. Other than a special tenoning jig, the best method of rounding the footing to match the rest of the shaft is by turning, Fig. 23. Nocks

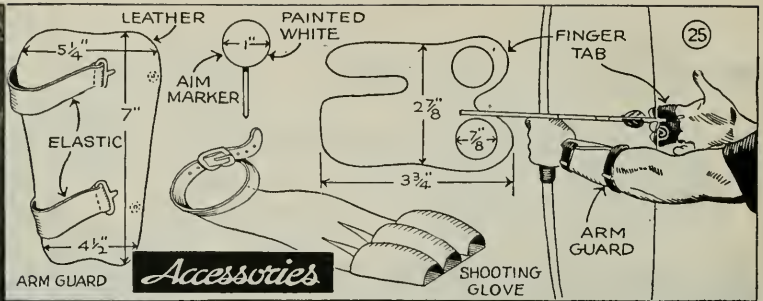

for footed arrows are usually of the same wood as used for the footing. The insert is let into the end of the shaft, and is later rounded off and grooved in the usual manner.

Accessories: If you want to be comfortable while shooting, you will need an arm guard and a finger protector. Any kind of leather band around the wrist and forearm will do for the guard, its purpose being to take the lash of the bowstring as the arrow is let loose. A simple finger tab of soft leather shaped as shown in Fig. 25 will provide protection for your fingers, or you may prefer to make or buy a three-finger shooting glove. An excellent target can be made by cementing four or five layers of corrugated cardboard together, painting the rings directly on the cardboard or on a piece of oilcloth. A simple target stand is made from 3/4-in. lumber, as shown in Fig. 27.

How to shoot: Stand with your feet well apart, left side facing the target, as shown in Figs. 26 and 29. Hold the bow horizontal and fit an arrow across the arrow plate. Grasp the arrow with the thumb or first finger of the left hand, Fig. 30, and with the right hand twirl the arrow until the cock feather is perpendicular to the bowstring. Adjust your grip on the string, as shown at the right in Fig. 25, and start the draw. Pull back slowly until your right hand comes to a fixed "anchor" point on your jawbone, Fig. 31. In this position, the string should be under and in line with the right eye. Aiming is done by sighting over the tip of the arrow to some fixed point previously determined as the correct point of aim at the distance being shot. Fig. 32 illustrates this method of aiming.

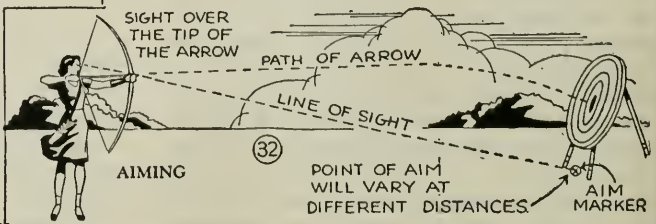
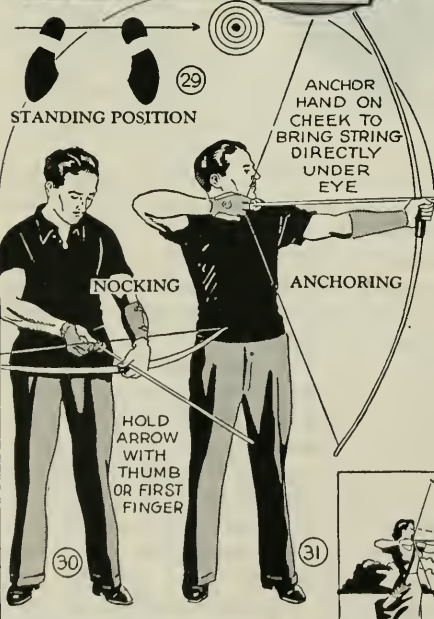

How To Shoot

Tin-Can Stilts Are Lots of Fun

Tin-can stilts are inexpensive and are safe for children, especially the small tots who want in on the fun. The cans are held on the shoes by rubber bands cut from old inner tubes.



Strap on Golf Bag Is Cushioned to Protect Shoulder



If the strap on your golf bag makes your shoulder sore, take a piece of old sheepskin and mount it on the strap with the wool inside, as indicated in the circular detail. If there is no sheepskin available, an old coat lining will serve the purpose, or you can use a ten-cent car polisher.

Tongues in Roller-Skate Shoes Held Securely in Place

To prevent the tongues of your skate shoes from wrinkling and causing discomfort, simply punch four holes near the top of each tongue and pass the laces through them as shown at the left.



Weighted Towels Tossed Easily to Basketball Players



To permit quick passage of towels to his players during time-out periods, one basketball coach punched holes in sponge-rubber balls and used them as weights. The corner of the towel is pulled through the hole in the ball.

Three Units in Outdoor Gym

Located in the back yard of a private home, the gym unit shown in the photo not only contains the usual swing, trapeze bars, etc., but also has a basket and back-stop for practicing basket ball. The unit is assembled from iron pipe at small cost, and the various parts are arranged so that any one of them can be used without interfering with the others.

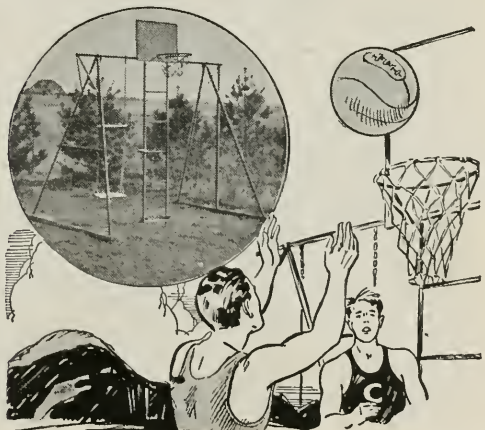

TRICKS *with Your* CAMERA



Trick picture, left, is made by superimposing photo of boy with hands around knees on photo of jar with boy pointing to it. Ghost photo, right, is made by shooting the door, then, without moving camera or winding film, snap someone dressed in sheet at door, using half the exposure time of the first shot



TRICK pictures can be taken with any camera—whether it's an inexpensive box camera or one of the finest cameras made. The key to trick pictures is to show something that seems impossible to accomplish—and as soon as someone sees such shots he knows that trickery is involved. The actual means, of course, should be concealed, so that people don't "catch on" at the first glance. For example, did you ever see the picture of a boy, his eyes crossed, balancing a half-dozen eggs on his nose? Here is how you can make such a picture. Take six eggs (well drained of whites and yolks), string them on a dark thread, and suspend them from the ceiling in front of a dark background. The subject stands under the eggs, tilts his head until his nose just touches the bottom of the lowest one, looks cross-eyed, (if he wants to add a little comedy)—and you snap the picture.

← Turn this picture upside down and see how it was snapped; trousers were pinned up; necktie held up with wire, camera was pointed down



Cut out pictures of Indians and paste on stiff paper with pin at foot to hold erect on pillow; arrange figures and child, then shoot with camera on firm support. Now take away figures and tent and shoot again on same film. During this exposure details blocked out behind figures record, making figures appear translucent, as in a dream

You can suspend other objects in the same manner, for a variety of photographic tricks. For instance, you might show a person enchanting a small book by having it appear to be floating in mid-air.

There is one point to remember here—even a black thread will show if you have too much light on it, so it must be shaded in some manner. The simplest method is to have someone hold a piece of cardboard just outside the picture—adjusting it to cast a shadow on the thread. Outdoors, when you use the sky as a background, have the color of the thread match the sky.



EGGS DRAINED AND SHELLS THREADED TOGETHER

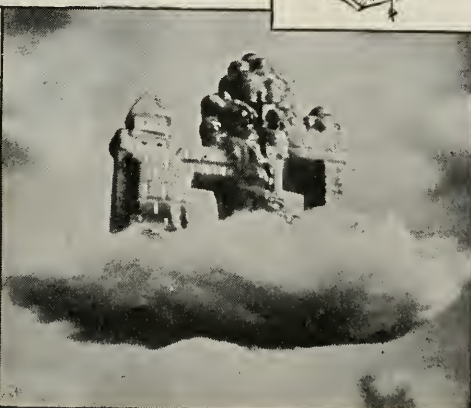
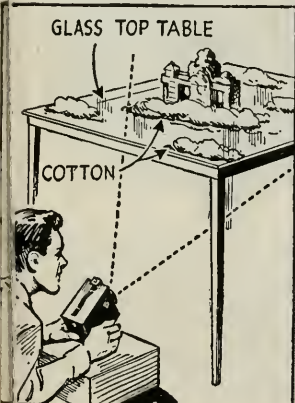

↑ Startling photo—anyone can see it's a trick—is made by draining eggs, threading them together and suspending them so subject's nose may touch them. Camera does the rest

← Diagram shows how toy castle may be made to appear floating on cloud by using cotton and glass top table, shooting in camera position shown. Portrait attachment permits shooting closeup

Many curious effects can be obtained with a transparent glass-topped table or a large sheet of glass placed with its edges on suitable supports. Small objects may be placed on top of the glass and pictures taken with the camera pointed upward from below. The subject appears to be floating in the air, and the unusual view produces intriguing pictures. Since these pictures must be taken fairly close up, it is necessary to use a portrait attachment, if your camera cannot be focused down to 3½ feet or less. Double exposure—two pic-

tures on one film—spoils many snapshots, but double exposure, on the other hand, can serve to produce stunt pictures to baffle your friends. For example, place your camera on a firm support or a tripod. Pose your subject against a black background and snap one picture. Now, let your subject move to a different position, and snap another one without winding the film or moving the camera. That, of course, produces two images of the same subject side by side in one picture—frequently producing a rather amusing effect.

Viewing Box for Color-Film Transparencies

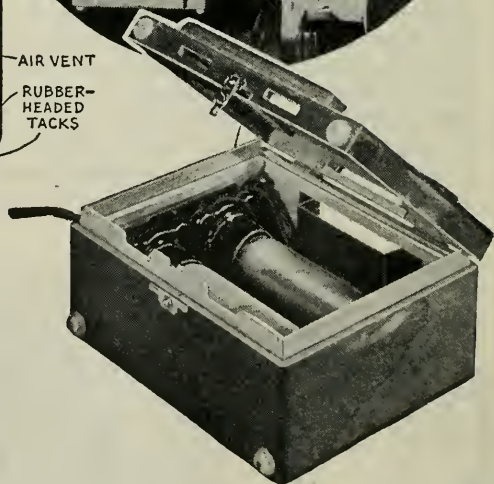
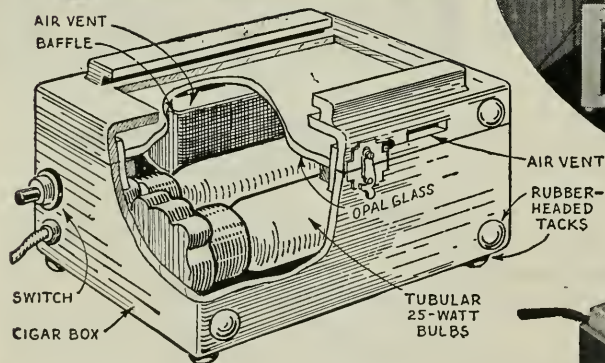
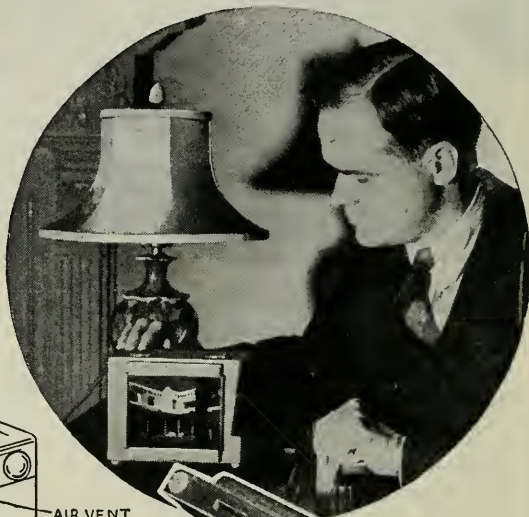

Besides making the examining of color-film transparencies a simple matter, this compact viewing box, when fitted with a long extension cord, can be passed among your guests without them moving from their seats. It's made from a cigar box, which is fitted with two sockets and tubular lamps, the latter being wired through a radio panel switch located conveniently in one end of the box. A sheet of opal glass, not ground glass, diffuses the light and is supported on cleats just under the box cover, thus dividing the assembly into two parts. An opening of the proper size to ac-

commodate the transparencies to be used is cut in the cover, and rabbeted strips are glued at opposite sides of the opening to provide slides for holding the film. Vent openings in both the cover and box are fitted with baffles to prevent escape of light.

Identifying Trays in the Dark



Hard-rubber trays containing different solutions are easy to identify in the dark if a different number of small notches are filed in the edge of each one. Glass and enameled trays can be marked for the same purpose with small pieces of adhesive tape.

Glass and enameled trays can be marked for the same purpose with small pieces of adhesive tape.

Notches in Clothespin Film Clips Hook Over Drying Line

Films being dried in these clothespin film clips are easy to remove from the line for inspection. With a fine saw cut notches in each pin in the position and at the angle indicated.



Box Camera and Cellophane Filter Produce Striking Pictures

Box-camera owners can produce striking pictures of landscapes, clouds, marine and other scenes if they use a set of homemade filters. For each filter, take two playing cards and cut a hole in the center of each a little larger than the hole in the front of the camera. Apply rubber cement to one side of each card and press them together with a sheet of colored Cellophane between. The filter can be held on the camera by rubber bands.

Yellow, in various shades, is the most common color for filters, but novel effects often can be secured with other colors. Determine by experiment how much to increase exposure for each filter and mark them accordingly.

—Arthur C. Nelson, Minneapolis, Minn.

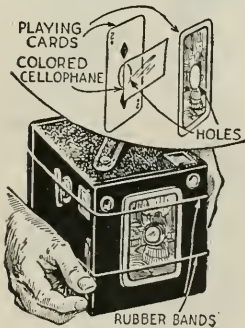

View Finder on Folding Camera Serves as a Distance Gauge

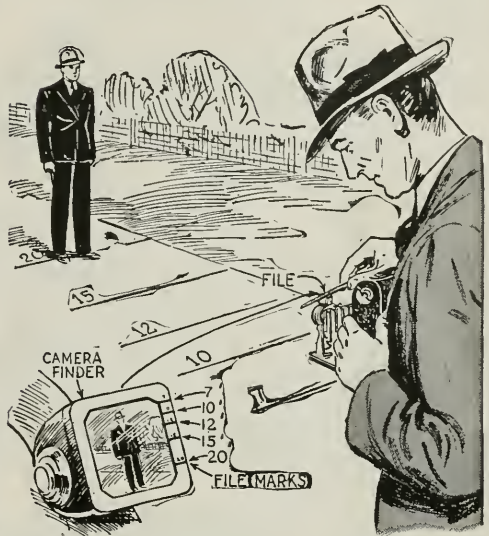

Distance from the camera to persons of average height, when taking snapshots of them standing, can be shown approximately by a number of file marks on the edge of the reflecting view finder of a folding camera. Place the camera on a tripod and mark off on the ground in front of it the different distances shown on the focusing scale. Have an assistant of average height stand on the first mark and note how high his image appears in the view finder. Then mark this point on the finder with a small scratch. Do the same with the next mark and so on for all the distances. When taking a snapshot, first see how high the subject appears in the finder and set the footage scale accordingly.

—Sigmund Sameth, Norman, Okla.

Tiny Suction-Cup Thermometer Fits in Developing Tray

Stuck in one corner of the tray and left there during the developing process, a small dial-type thermometer with a suction cup on the back gives a constant check on the temperature of the solution. Be sure to seal the instrument with rubber cement applied liberally so that liquid will not seep inside.

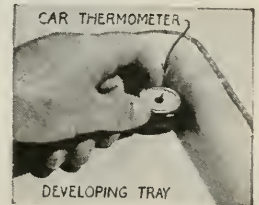

Build this dual-purpose

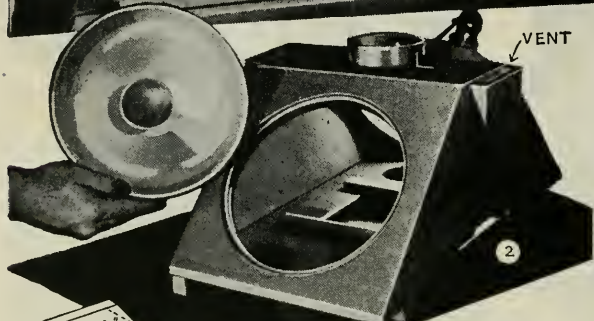
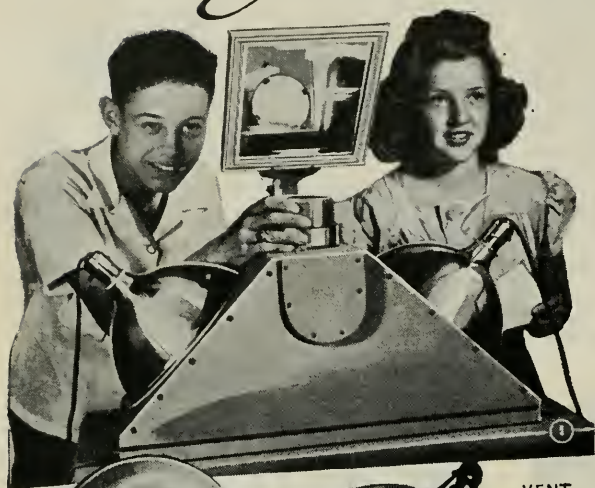

EVERY home-workshop owner will find this inexpensive projector a time-saver. It's handy when enlarging drawings from magazine pages or for doing copy work, Figs. 5 and 6. Also, children will enjoy it for putting on "picture shows" to entertain their friends, Fig. 1. The working principle is quite simple, as illustrated in Fig. 7. A strong light cast on a solid object at a 45° angle is reflected, picked up by a lens, reversed by a mirror and projected on a screen. The brilliance is not as great as with glass slides, but more light can be used. Even a pair of 300-watt lamps are none too bright for a large room.

Photoflood reflectors, Fig. 2, can be used. There is no need of using them exclusively for your projector, for by merely twisting the cleats, Fig. 4, they snap out and may be used for taking pictures, reading or spe-

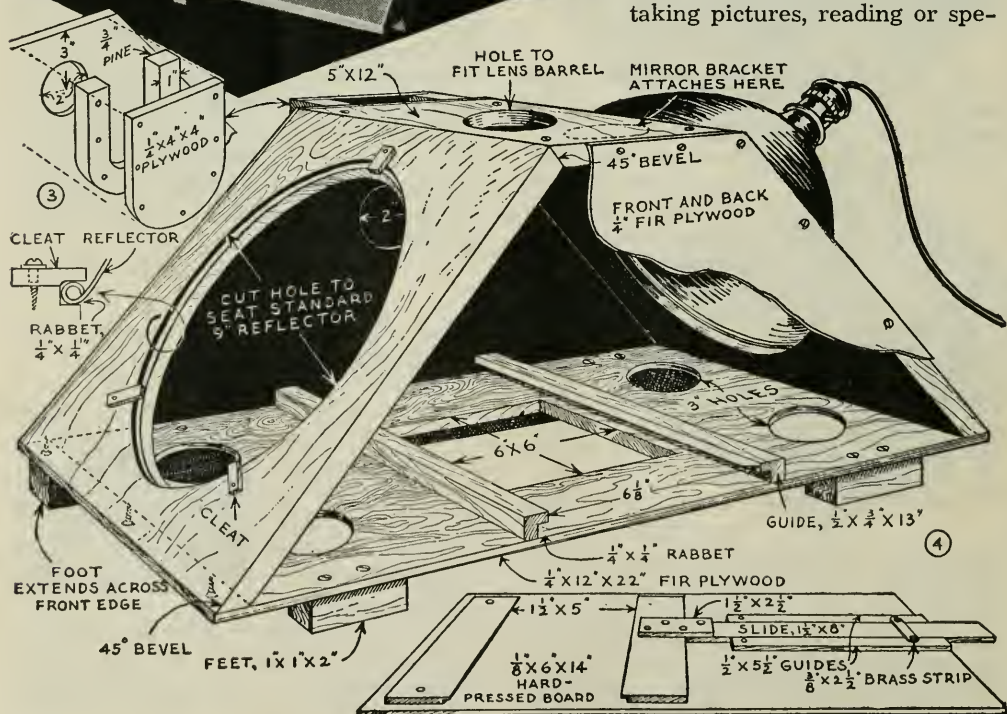

PICTURE PROJECTOR

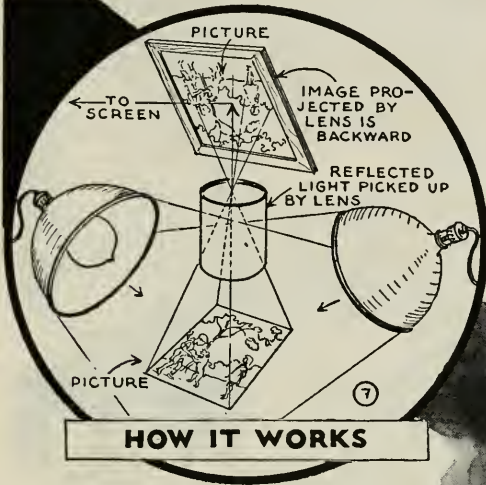

cial lighting effects. If you already have a pair, plan to use them in your projector. The lamp house must be ventilated well, Figs. 2 and 3, to take care of the heat from the powerful lamps. Cut four circular holes in the plywood bottom, and two light-trap louvers in the plywood ends. Holes both above and below the light create a draft and give maximum cooling. Use well-dried lumber and assemble with screws. The end panels are cut to fit after the rest of the housing has been assembled.

The selection of a lens is of utmost importance. An ordinary reading glass will do if the projector is to be used only for amusement. However, low-priced lenses have a tendency to distort, making a grill that looks like B and C in Fig. 8. This can be corrected to some extent by using a diaphragm made from heavy paper and laid over the lens. The quantity of light is cut down, but the picture is more normal.



ENLARGING MAGAZINE PLANS



DOING COPY WORK



Your lens should be between 3 and 5 in. in diameter. A compound lens will be necessary if the projector is to be used for critical enlarging and copying. These can be obtained for as low as \$6.00 from optical houses. A compound lens has at least five times the brilliance of a simple lens, and much less distortion.

Focusing on most lenses is critical and the barrel and ring must work smoothly. Seamless brass tubing works best but is often difficult to obtain locally. It is stocked by mill and machinist supply houses. Order a size that will allow your lens to

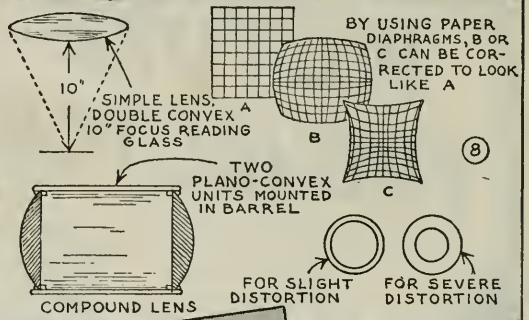
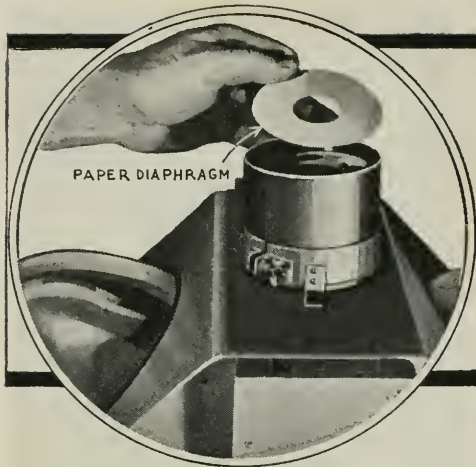

"float," so expansion will not crack it. Mount it between tiny angles of brass, Fig. 9, padded with rubber cut from an inner-tube patch. Stick these to the glass. You will have to make the angles from sheet stock. Thread the small machine screws, Fig. 10, into the barrel and focusing ring and file flush on the outside. Adjust the tension screw until the barrel will just slide when twisted.

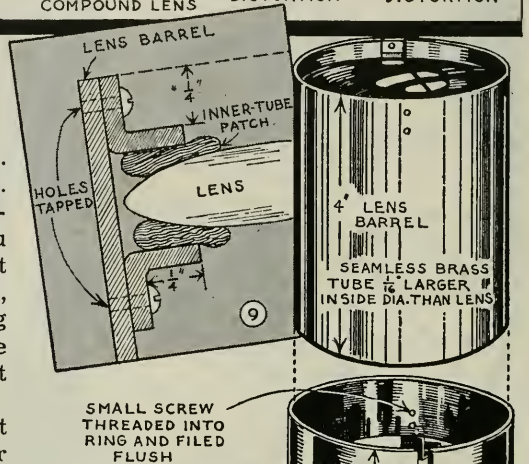

Postcards and snapshots are clamped flat in the carriage, while books and other thick objects are slid under the square hole. The carriage slide moves back and forth between guides to accommodate any picture up to 6 in. square. Paint the carriage and base black to kill reflection.

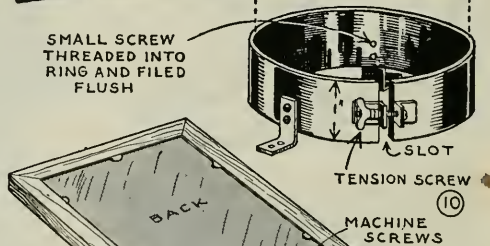

A mirror, preferably of the plate-glass type, gives the image the necessary reversal. Mount it so it may be held in any desired position by tightening the wing nut, Fig. 11. The distance you can throw a picture, and the size of it, depend largely upon your lens and the lights. Using the average magnifying glass and a pair of 100-watt bulbs, an image 3 ft. square on the screen 8 ft. away is possible. For copying on a glass-top table or ceiling projection, the mirror is not used.

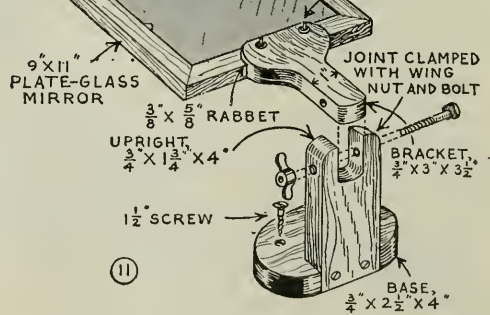

Discarded Photographic Film Packs Serve as Cases for Insect Specimens



Discarded metal film packs and photographic plates, which can be obtained from your local photographer, provide ideal specimen cases for collectors of insects. Remove all parts from the pack but the outside case and line the latter with cotton. Remove the gelatin coating from the plates with hot water, place the insect and then assemble the pack in the regular way. Before closing the pack, it is a good idea to add some moth flakes to keep out small insects that might destroy the specimen.

Use Your Camera with These "JIFFY" ENLARGERS

Most enlargers are complete units, including lens and bellows, but these are really only lamp houses. The camera that takes the picture supplies the lens and bellows units for making the enlargement. As you see, there are two types, one using an opal glass for diffusion, Figs. 1 and 2, the other a condensing lens, Fig. 5. Both types of lamp houses are supported on a column of $\frac{1}{2}$ -in. iron pipe. The sliding arm consists of a pipe tee, with the threads reamed out to fit over the column, a 4-in. nipple and a floor flange. The vertical column is turned into a flange which is screwed to the easel or baseboard. The lower part of the lamp house is built of wood and the reflector is made from a funnel, or, can be purchased ready made

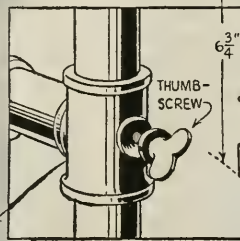
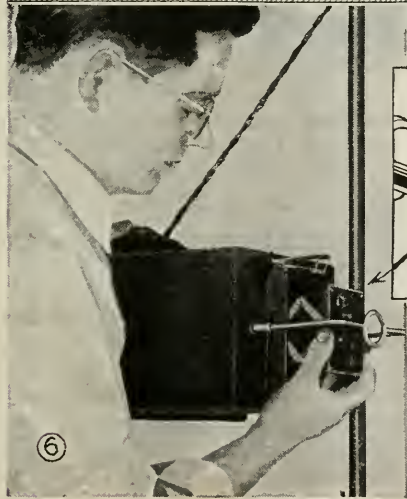
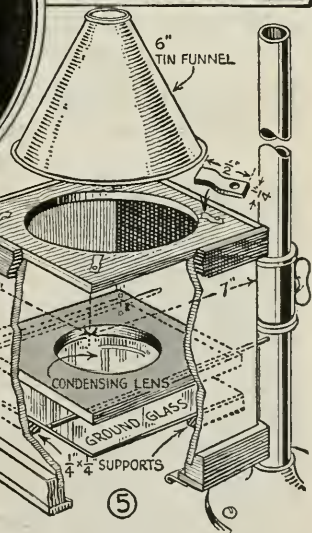
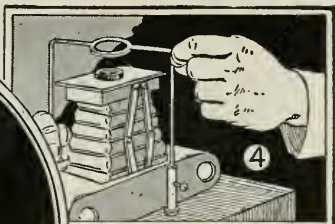
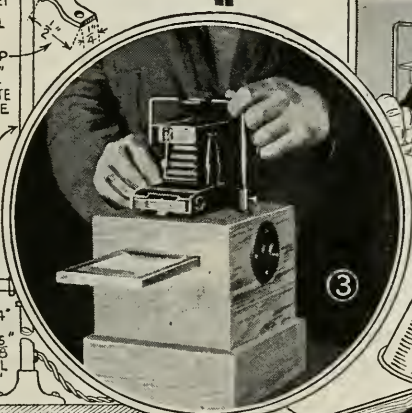
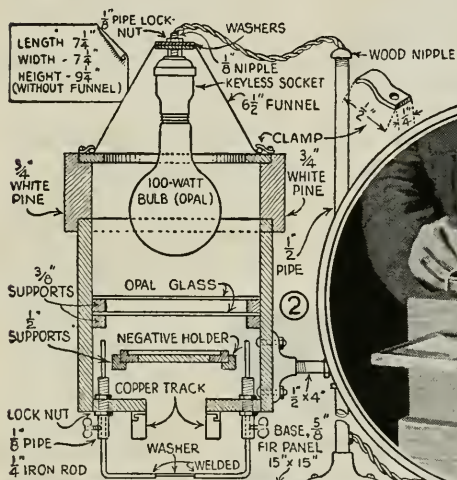
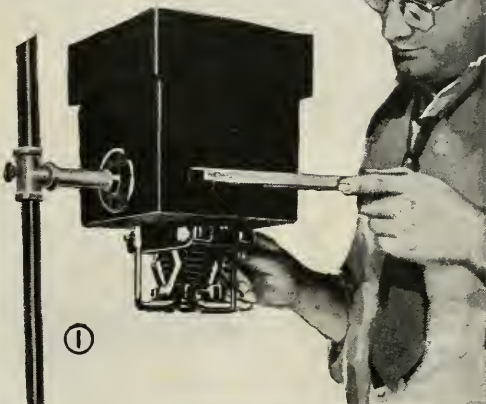

Of course, dimensions of the various parts may have to be altered to suit the camera used. In addition to the clamp for holding the camera back tightly against the light box, some types of folding cameras will require the ring support shown in Figs. 3, 4 and 6 and detailed in Fig. 2. This serves to hold the lens at exactly the position required. A negative holder can be made by hinging two pieces of plate glass with tape and then masking to the required area

Strip of Rubber on Focusing Cloth Clings to the Camera



Focusing is made easier, especially outdoors in the wind, if a wide strip of rubber sheeting is cemented along one edge of the focusing cloth. The rubber clings to the wood or leather parts of the camera and will not slip off easily. Use rubber cement to fasten the rubber strip to the cloth.

Two Towel Holders in Darkroom Made from One Shoe Tree



One shoe tree will provide two handy towel holders for your darkroom. Held by pressure of the wood parts of the tree, the towels can be removed and replaced quickly, and there are no hooks to damage the cloth. For greatest convenience, several holders can be located around the darkroom. After cutting the spring of the shoe tree in the center,

file small notches near the end of each half to take the screws as shown in the

photograph. It is much easier to file these notches than to attempt to drill a hole in the hardened spring.

Simplified Test for Wash Water Indicates Presence of Hypo

A drop of strong potassium permanganate solution in the washing tank will show whether or not prints or negatives have been washed sufficiently. The potassium permanganate will turn the water a brilliant purple, but should any hypo be present the color will fade quickly to a dirty orange or yellow. This treatment is harmless to prints or negatives.

—Kenneth Murray, Colon, Mich.



Paper Clips Provide Finger Grips to Handle Photo Film

Amateur photographers who employ the "seesaw" method of developing films are often annoyed by the difficulty of holding

the slippery ends with the fingertips. If brass paper clips, of the type shown, are attached to each end of the film they will serve as grips to facilitate the work. If a number of films are to be developed at the

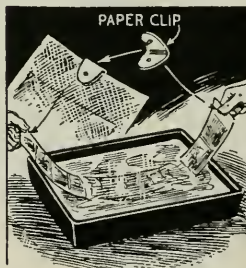

same time, and there is need of identifying them, the clips may be attached to each one in a slightly different position.

Two-Solution Developing Method Is Fast and Sure

Called automatic because over or under-development cannot occur, this system of film developing is much faster than the usual method. It is especially suited to roll film and is not difficult to carry out. Two solutions are used. To make Solution I, mix the following chemicals in the order

named in 24 oz. of water at 110° F.: metol, 5 grams; sodium sulphite (anhydrous), 3½ oz.; glycin, 5 grams. Then add water to make 32 oz. Solution II consists of sodium carbonate, 3½ oz., dissolved in warm water, 24 oz., with cool water added to make 32 oz. Store the solutions in brown bottles. Immerse the film in Solution I for 30 to 45 seconds (30 seconds for slow and normal-speed films and 45 seconds for the ultra-speed films). Allow the film to drain for 5 seconds, then immerse in Solution II for 1 minute. Agitate the film while it is in the solutions. Rinsing, fixing and washing are carried out in the usual way. The activating agent (Solution II) oxidizes only the developing agents (Solution I) that have been absorbed by the emulsion and development, then stops automatically. Thus a film that has been given approximately the correct exposure will produce a perfect negative.—Cliff Edwards, Oshkosh, Wis.

Steel Tape Clamped on Camera Checks the Distance for Portraits



Clamped to the bed of a folding camera, a small steel tape takes the guesswork out of focusing for portraits. Have the subject hold the end of the tape even with his eyes and a glance at the other end will show where to set the footage scale. A small C-clamp soldered to the case as shown in the inset will hold the tape in place on the camera.

Three Ways to Keep Ferrotypes Tins from Being Bent or Scratched

Ferrotypes tins will not fall when set against a radiator or the wall and are less likely to be bent if two corners are fitted with round cork fishline floats or the rub-

ber guards from an auto hood. To lay tins on top of each other without scratching them, cement small cork disks from bottle caps on the back at each corner.

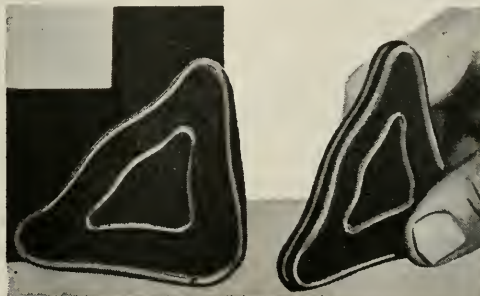
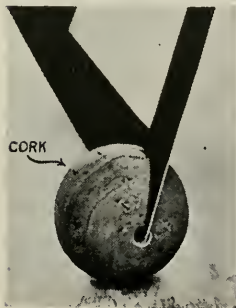

Extension Cord Wound on Cleat Soldered to Lamp Standard

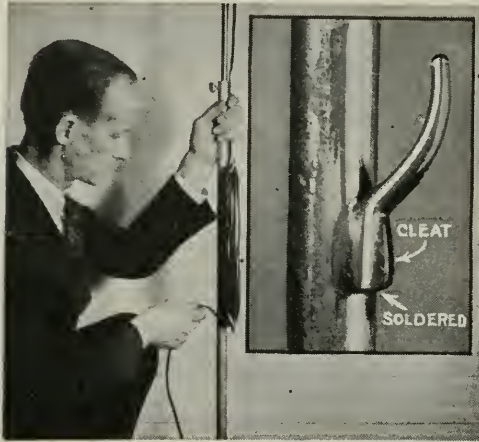

Two halves of a clothesline cleat soldered to the standard of a photo light provide a reel on which to wind the extension cord. Choose a cleat of the right size to accommodate the cord on the lamp, cut it in two, and place the halves about a foot apart on the standard.

Cork in End of Steel Print Tongs Keeps Them Out of Tray



Steel print tongs won't slide into a tray when laid on the edge if a cork is fitted in the loop end. A cork from a gallon jug is just about right.

Small Strips of Colored Paper Identify Film in Holders

Green and red poster paper cut in strips is convenient for indicating the kind of film your holders contain. The strips should be about $\frac{3}{4}$ by $2\frac{1}{2}$ in. and are slipped between

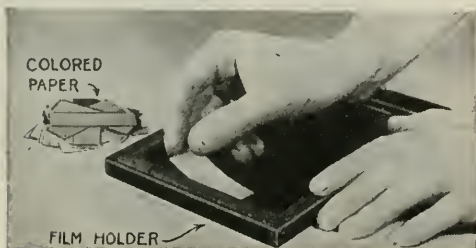

the dark slide and the edge of the holder when the film is loaded. Use green for panchromatic film and red for orthochromatic. If you wish to indicate fast, medium or slow film of either kind, the strips can be cut in different lengths. Remove the paper before a picture is taken and return it afterward. Date, exposure data, or other notes can be written on the strips of paper if desired.

—Arthur Trauffer, Davenport, Iowa.

Diffuser with Two Folded Pockets Slips On and Off Reflector

In an emergency, a square of tracing cloth or other suitable translucent material folded over at two ends and stapled as shown makes a handy diffuser for photoflood lights.

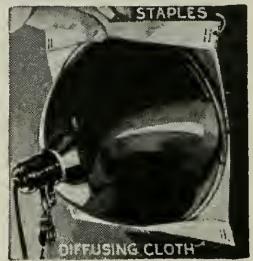

It should fit loosely so it can be slipped on and off the reflector easily and so air can circulate freely around it to keep it from getting too hot.

Cut Films Wedged in Slotted Stick Developed without Scratching



Several cut films can be developed at once in a tray by this method without danger of scratching them. With a sharp knife, make a cut about $\frac{1}{4}$ in. deep on each side of a clean piece of wood. Wedge the ends of the film sheets in the slots as shown and they cannot rub together during development. If a large tray is used for developing, the stick can be made long enough to hold up to a dozen negatives.

Small Photo Printer of Plywood Is Easy to Make

Particularly suited to the needs of amateur photographers who must do their work in small apartments or darkrooms, this printer is assembled almost entirely of plywood. It occupies only a small space and handles negatives up to 5 by 7 in. Fingertip control of the two printing lights is provided by a toggle switch mounted on the lamp box as shown. A spring hinge on the handle keeps it in an upright position when adjusting negatives. Special care should be taken in cutting and fitting the parts, especially those that make up the lamp box, to make sure there are no light leaks at the joints. The exterior surface can be either stained or painted.

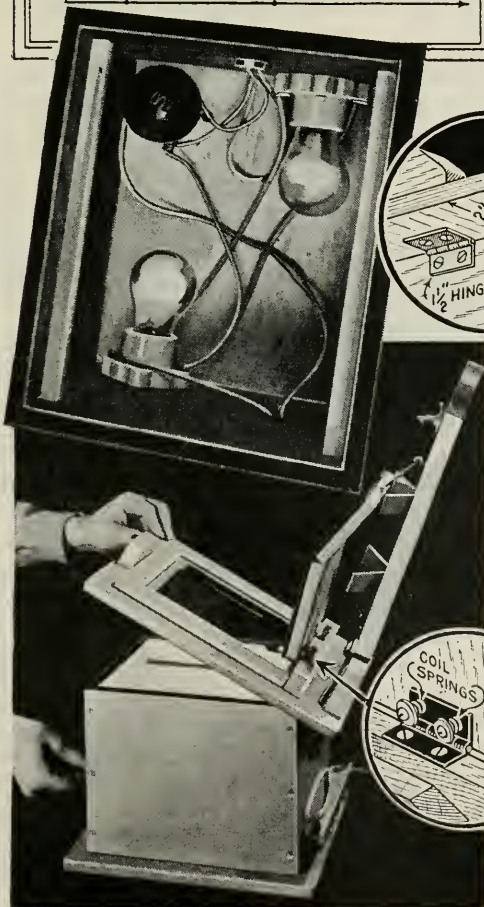
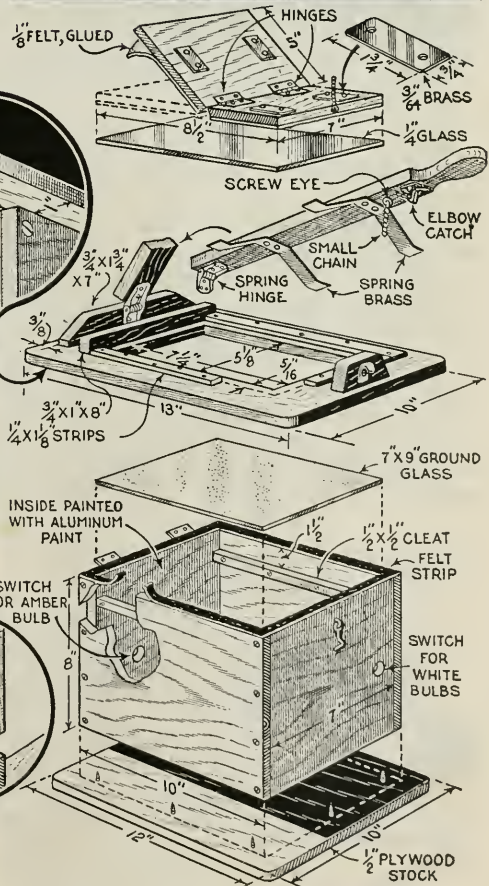
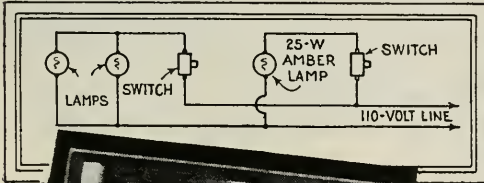

Falling Snow Imitated in Photo With Pepper on Negative

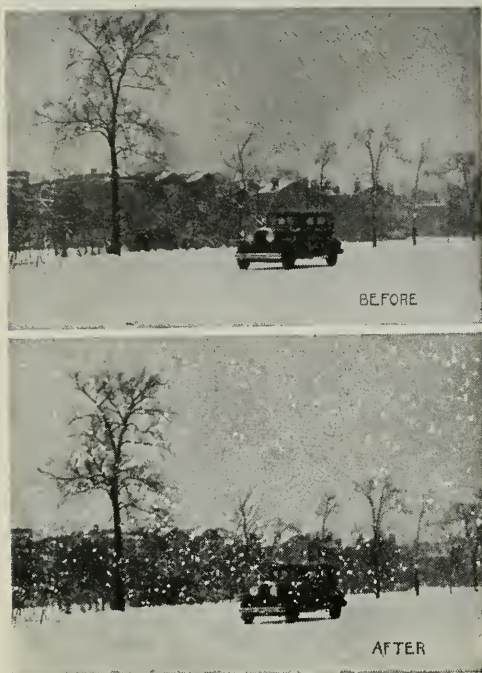

Snow scenes "shot" after the storm is over can have a touch of realism added when making the prints. With the printing frame in the horizontal position, pepper is sprinkled lightly on the negative. As snow would be visible right up to the camera, there is no need of eliminating any of the pepper from the film unless sheltered spots are included in the picture. The print is made in the usual way, care being used when placing the paper on the negative not to disturb the pepper. Stormy effects may be created by swirling the snow around buildings or other objects in the picture.

Testing Board for Camera Bellows Has Photoflood Lamp



Mounted in a porcelain socket on a suitable wood base, a photoflood lamp provides a good tester for camera bellows. The lamp produces a brilliant light that will show leaks that cannot

be detected easily by other means. The face of the base which contacts the rear of the camera is lined with black velvet, and the lamp cord is brought to the socket through a hole in the base.

Panoraming With Any Tripod

Unless your tripod is especially built for panoraming of the camera, it is necessary to loosen the tripod screw to follow a fast-moving object. A better method is to slip a thin metal washer over the screw between the camera and tripod top. The camera then can be swung rapidly from side to side and remains securely fastened to the tripod.

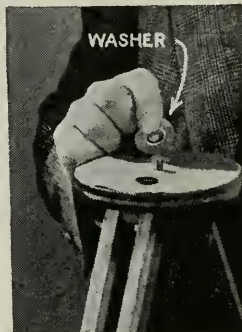

Camera Bed Held at Angle Rigidly To Photograph Tall Buildings



You can photograph a tall building or other object with a small folding camera almost as good as the job can be done with a commercial camera that has a swing back, if the bed of the small camera is tilted as indicated. After tilting the bed at the desired angle, a C-clamp is used to hold it rigidly in place.

DARKROOM TIMER

from alarm clock

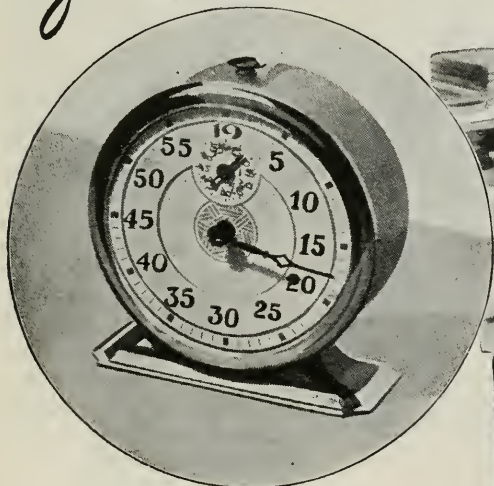

This darkroom timer can be set to ring at any predetermined time within an hour, and it is especially handy when developing negatives in total darkness. After removing the face and works from the case, the large gears, Fig. 1, which drive the hands and actuate the alarm, are carefully pried off the spindles. The small pinion indicated in Fig. 2 is also removed and the teeth are filed off, after which it is replaced as in Fig. 3. Next, the minute-hand shaft is filed flat on two sides and tinned with solder. The gears are returned to their proper position and the sleeve on one gear is sweat-soldered to the shaft. The reassembled mechanism, Fig. 4, is replaced in the clock case. The dial is renumbered to read as shown. To set the timer, first wind up the alarm and turn the alarm-setting key until the bell rings. Then mount the alarm hand and also the minute hand so they both point to 60. Set the alarm hand on the number of minutes interval desired. Always return the large hand to 60, and be sure to always turn it in clockwise direction

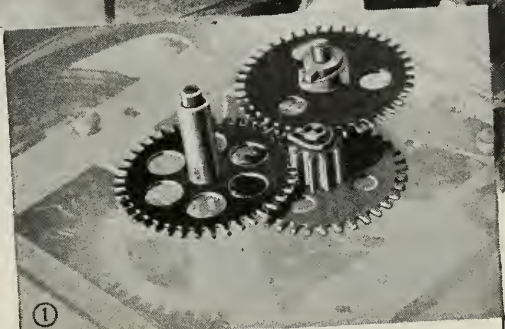

①

GEARS WHICH DRIVE HANDS AND ACTUATE ALARM ARE PRIED OFF SPINDLES

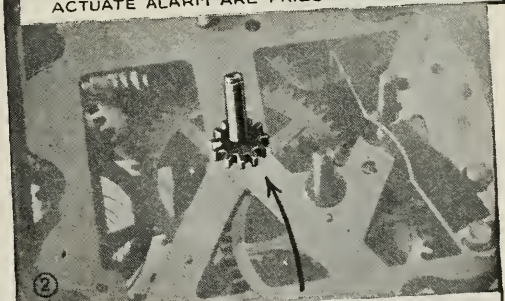

②

THIS PINION IS PRIED OFF AND THE TEETH FILED AWAY



③

PINION IS RETURNED TO ORIGINAL POSITION

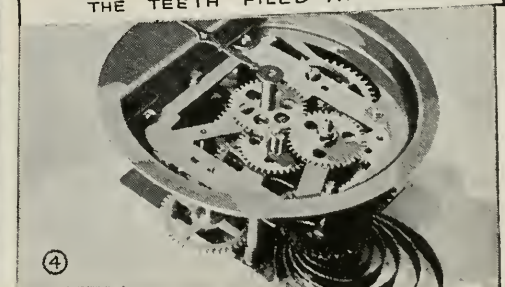

④

THEN THE MECHANISM IS RE-ASSEMBLED

Colored Plastic Tumblers Used as Safelights



Plastic tumblers in different colors are used interchangeably in this darkroom safelight. A metal lid of a jar is cut out in the center to fit on a lamp socket and is soldered to the latter all around to avoid leakage of light. Two small hooks are soldered to the lid for attachment of coil springs, which hold the tumbler inverted against the lid. A layer of sponge rubber between the tumbler and lid makes a lightproof joint. Use a $7\frac{1}{2}$ or 10-watt bulb. Tumblers should be tested to make sure that they will not fog the sensitized material.—Robert J. Williams, Chicago.

Scale on Portrait Attachment Shows How to Set Camera

Figures on a piece of white paper pasted around the rim of my portrait attachment make it unnecessary for me to carry a chart showing where to set the camera distance scale when using the attachment. With the camera set at $3\frac{1}{2}$ ft., the portrait attachment brings objects 23 in. away in focus, so, opposite $3\frac{1}{2}$ ft. on the camera scale I have marked 23 in. The correct marking in inches is placed on the portrait

attachment opposite each division of the camera scale, up to infinity, which is 50 in. All numbers are black ink except 50 in., which is red. When placing the attachment on the camera, the red number is set opposite infinity on the camera scale, making all other marks fall in their proper place.—Lawrence Gottlieb, New York.

Pointer on Darkroom Clock Times Tank Development

Cut from cardboard and mounted on the face of the darkroom clock, this pointer tells when films in a tank have developed the proper length of time. The pointer is fastened to a cardboard disk with a brass paper fastener and the disk is cemented to the clock face.

At the time you start developing turn the pointer the correct number of minutes ahead of the minute hand of the clock. When the minute hand is exactly under the pointer, the time is up.

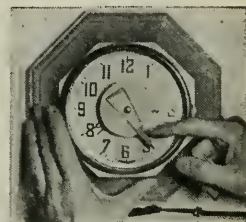

Efficient Print Washer from Ordinary Tub

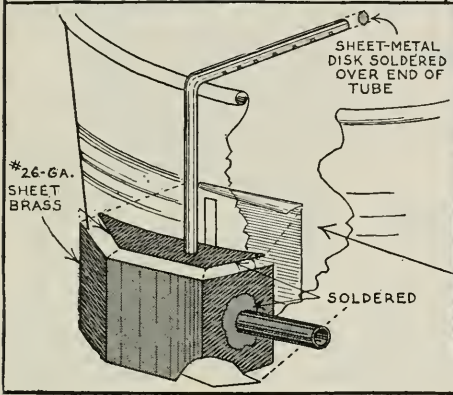
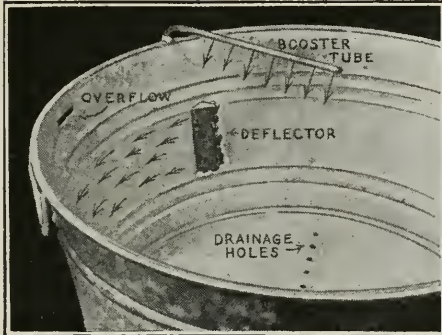

Connected to a water faucet and set in a sink to drain, this efficient print washer depends on swirling water to remove all traces of hypo. In this case a 24-in. galvanized washtub was used, which handles a dozen prints at the same time and removes all traces of hypo in about an hour's time. However, the same principle can be applied on smaller tubs. A rubber tube is connected from the faucet to a water jacket soldered on the outside. From this point water enters through a narrow slot over which a deflector is soldered, this being closed on three sides. The space between the deflector and the wall of the tank is about $\frac{1}{32}$ in., which directs water in the direction shown by the arrows. The width of the slot can be varied to control the pressure of water issuing from it and to control the pressure of the water ejected from the booster tube on the surface of the water, which keeps prints separated and submerged. The booster tube is a length of $\frac{3}{16}$ -in. copper tubing soldered to the water jacket, closed at the other end and having a number of $\frac{1}{32}$ -in. holes $\frac{1}{2}$ in. apart to direct small jets of water downward at an

angle of about 45 degrees in the same direction as the flow in the tank. The end of the tube is not directly over the center of the tank but about 4 in. back of the center, which prevents prints from being "kicked" against the side. Drainage is provided by overflow slots near the top, and $\frac{1}{16}$ -in. holes drilled through the bottom.

Paper Strip Diffuses Floodlight

Diffused light can be secured from an ordinary photoflood reflector by fastening a strip of thin paper to the reflector directly in front of the bulb. The strip should be about 4 in. wide and can be held in place with paper clips.

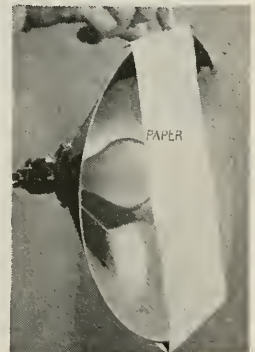



Here's A POPULAR

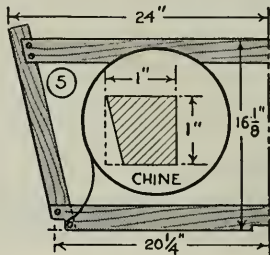
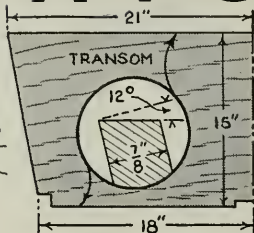

- MATERIAL LIST**
- Stem, 1 pc. 2 x 3 x 21 in.—oak stock
 - Stem knee, 1 pc. 7/8 x 9 x 14 in.—oak
 - Keelson, 1 pc. 3/8 x 3 in. x 12 ft.—oak
 - Transom, 1 pc. 7/8 x 15 x 42 in.—cypress
 - Sternpost, 1 pc. 7/8 x 7/8 x 15 in.—oak
 - Stern knee, 1 pc. 7/8 x 6 x 6 in.—oak
 - Frames, 19 running ft. oak for bottom frames, 2 x 3/4 in., 21 running ft. oak for side frames 3/4 x 1 1/2 in.

- Battens, 10 pcs. 3/8 x 1 1/4 in. x 12 ft.—spruce
- Clamps, 2 pcs. 1/2 x 2 in. x 13 ft.—spruce
- Chines, 2 pcs. 1 x 1 in. x 12 ft.—oak
- Planking, 1 pc. 4 x 12 ft. bottom, 2 pcs. 18 in. x 12 ft. sides—3/16 in. hard pressed wood
- Skeg, 1 pc. 7/8 x 5 in. x 6 ft. oak, this also supplies end cap for skeg, rowlock blocks and seat braces

- Seats, 1 pc. 7/8 x 10 in. x 13 ft.—cypress
- Quarter knees, 2 pcs. 3/4 x 5 x 5 in.—oak
- Breast hook, 1 pc. 3/4 x 4 x 7 in.—cypress
- Flooring, 1/2 x 6 in. x 50 ft. spruce or cedar

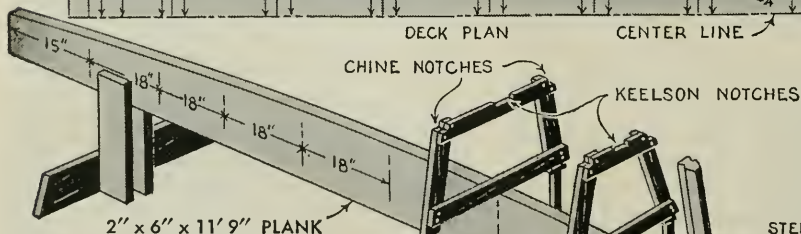
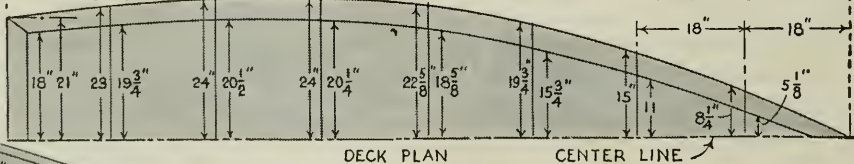
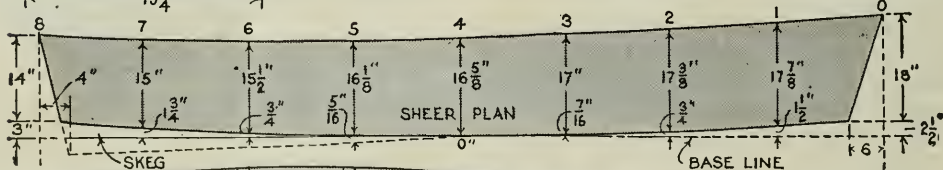
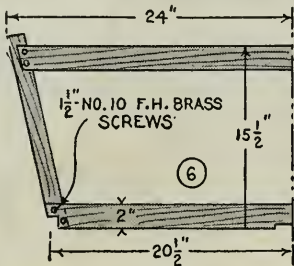
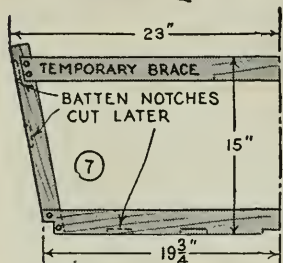

STEM IS TOE-NAILED TEMPORARILY TO END OF BUILDING BOARD

The hull is built bottom side up on a yellow-pine "building board," the top edge of which is shaped to conform with the keelson curvature dimensioned in the sheer plan. Station points equally laid off 18 in. apart locate the position of each respective frame in toe-nailing them to the building board. Check each frame vertically, horizontally as well as cross-wise with a level. The stem is likewise temporarily fastened to the end of the plank prior to fitting the keelson and chines

Twelve-Foot ROW BOAT

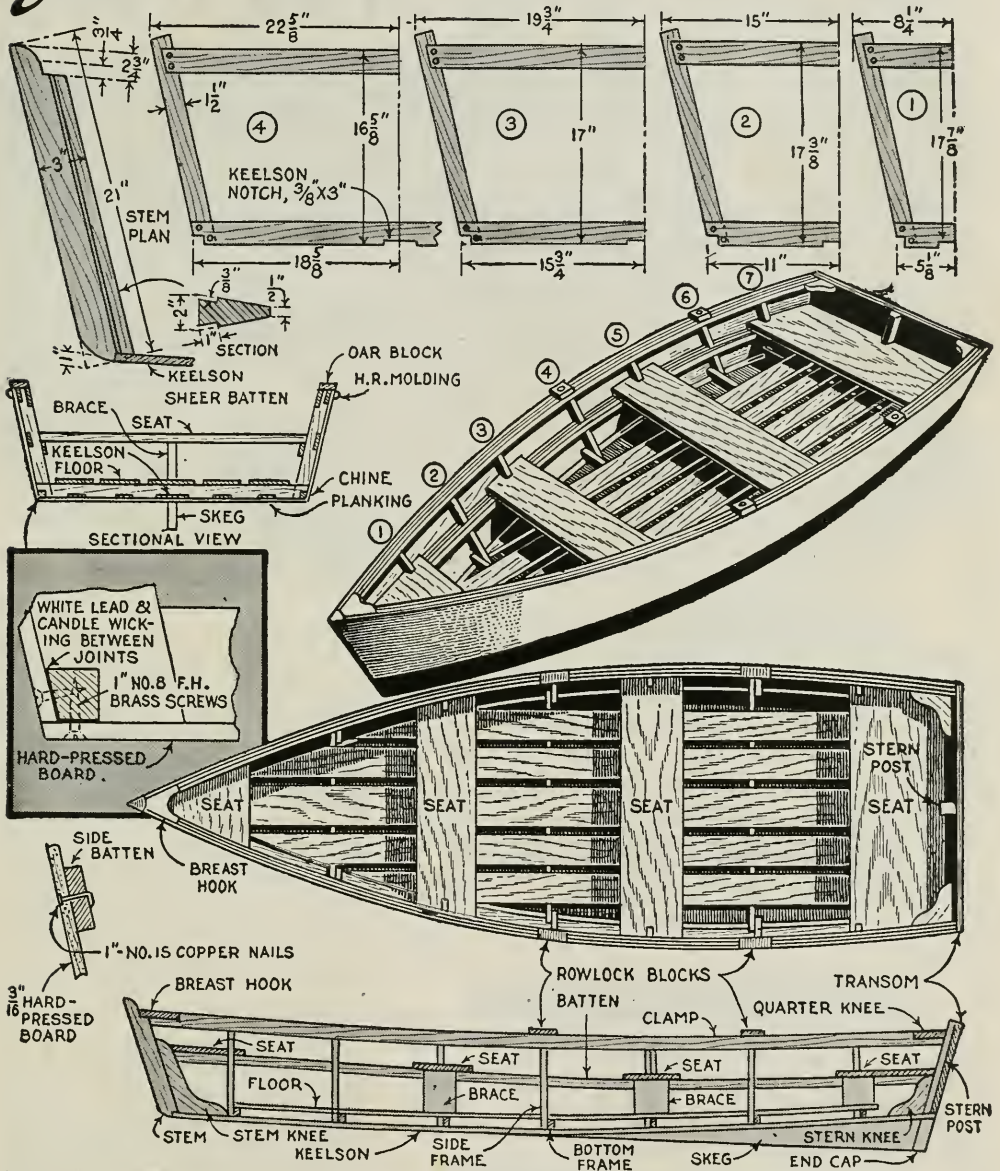

PROCEDURE

1. Construct "building board" trestle from 12-ft. plank as shown.
2. Cut the seven frames to size and assemble with F. H. brass screws.
3. Center the frames and nail them upright to the "building board."
4. Cut the stem to shape from 2-in. oak and fasten to the plank end.
5. Fasten keelson and chines in place with 1 1/2-in. No. 10 F. H. brass screws and plane chines down flush with side frames.
6. Cut batten notches 3/8 in. deep in transom and side and bottom frames and fasten battens with 1 1/4-in. No. 6 F. H. brass screws
7. Shape and fit the breast hook and the stem and the stern knees next.
8. Lay candle wicking in white lead along the chines and transom, and cover the sides of hull first with single panels of 3/16-in. hard pressed board, fastening to frames, stem, chines and transom with 1-in. brass screws spaced 1 in. Cover bottom in same manner.
9. Fit clamp boards and quarter knees at stern and then add floor boards, seat risers and seats. Cover stem with 1-in. iron nosing.

Building the

BILOXI

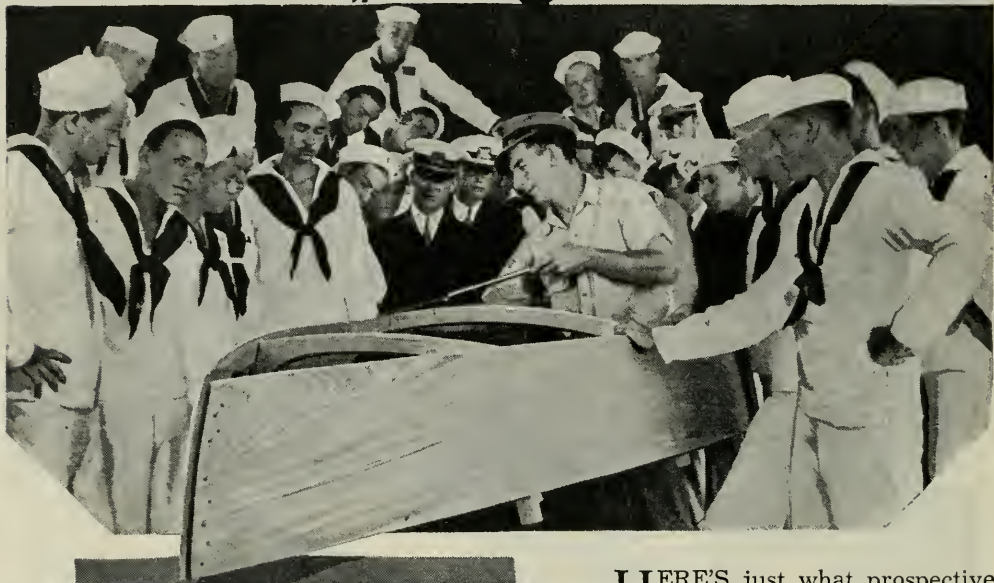

It is used quite extensively for rowing, and is sometimes towed behind a launch, and behaves splendidly for both these purposes. For sailing it is excellent, and I do not think I have ever sailed a small single-pair boat that is so well balanced.

"The little Gorenflo boat which I bought performs under sail better than any small boat of its kind that I have seen, and has proved quite dry under power."

As a sea boat the little thing is quite astounding. With two in her she rides like a duck. Our inlets here are notoriously treacherous, with a current of four knots or more. That against an ocean swell rolling in with a southeasterly breeze behind it kicks up some nasty water but, using motor, we play around in any ordinary weather out to the break of the outer bar and ship nothing but an occasional quart or so of spray.

he: Gorenflo Dinghy.

You may be interested to learn that Region Eight comprising six States have decided to adopt the Dinghy as a Sea Scout project and will lend effort and time towards having the boys build a number of the boats. It is contemplated that these boats may

HERE'S just what prospective builders of small sailboats have been looking for, as you will see from a glance at the facsimiles on the left, which reproduce excerpts from letters written by enthusiastic owners. And, the Biloxi Dinghy is not only seaworthy, as they say, but it's easy to build. Look over Figs. 1 and 2, which detail the frames and stern board, or transom. There are several points to keep in mind before you begin cutting the parts: The lower cross members of all frames are cut to the same radius; the top cross-pieces are a given distance above the lowest point of the curved member, and the frame uprights are joined to the curved members with an angle joint housed in gusset plates, as in Fig. 2. With the frames, stern board and building board made, the work on the hull is well along.

You start assembling the boat by placing the building board on two sawhorses as in Fig. 3. The lines marked on the building

10' 7"

DINGHY

by
L. J. Gorenflo

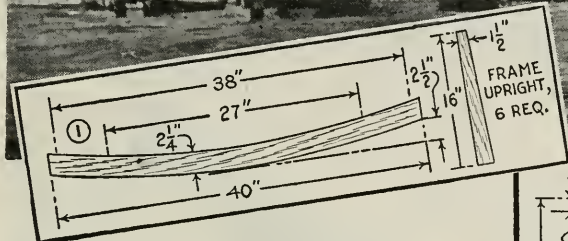
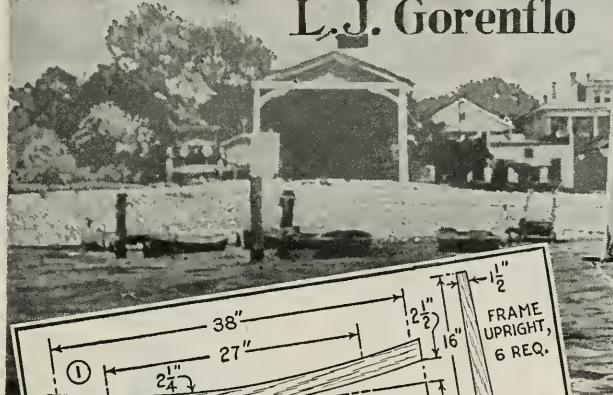

board, Fig. 4, indicate where to place the frames. These are placed upside down and the center line of the building board must match up with that on the frames. Place frames Nos. 1, 2 and 3 along the lines and fasten through the building board with 8-d common nails or 1 1/2-in. screws, also a brace to each frame. After all three frames have been attached to the board, the next step is to fasten the sides to the stem, Fig. 6. This can be done before mounting the stem on the building board although it is shown mounted with the frames in Fig. 3. If the sides are built up of several pieces, you simply screw the two lower planks to the stem, but should the sides be made up of narrow planks, the first plank on the lower side should be at least 8 in. wide. When building up the sides you can use shiplap construction which will eliminate battens. The stem is fastened to the sides at the zero (0) line, Fig. 5. Use 1 1/2-in. No. 8 flat-head brass screws spaced about 1 1/2 in. apart, in a staggered row. In Fig. 3 is a detail showing the exact distance from the lower edge of the boat to the building board. By mak-

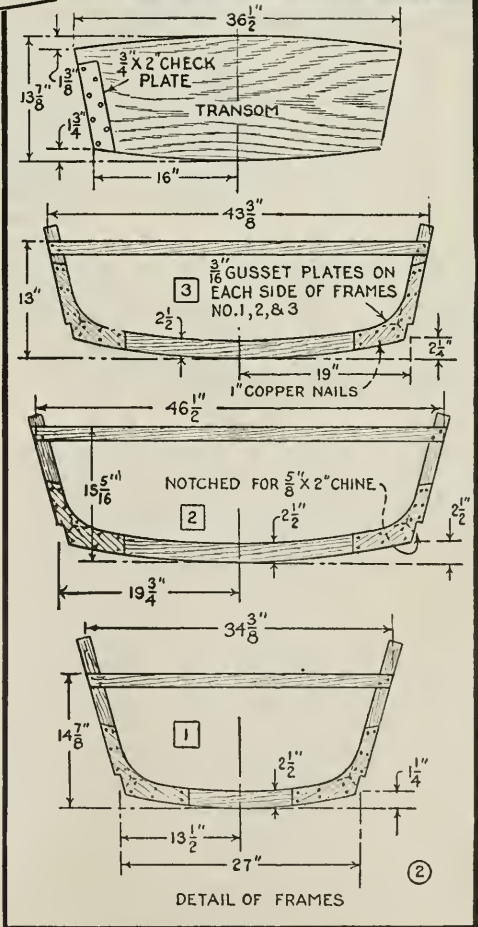

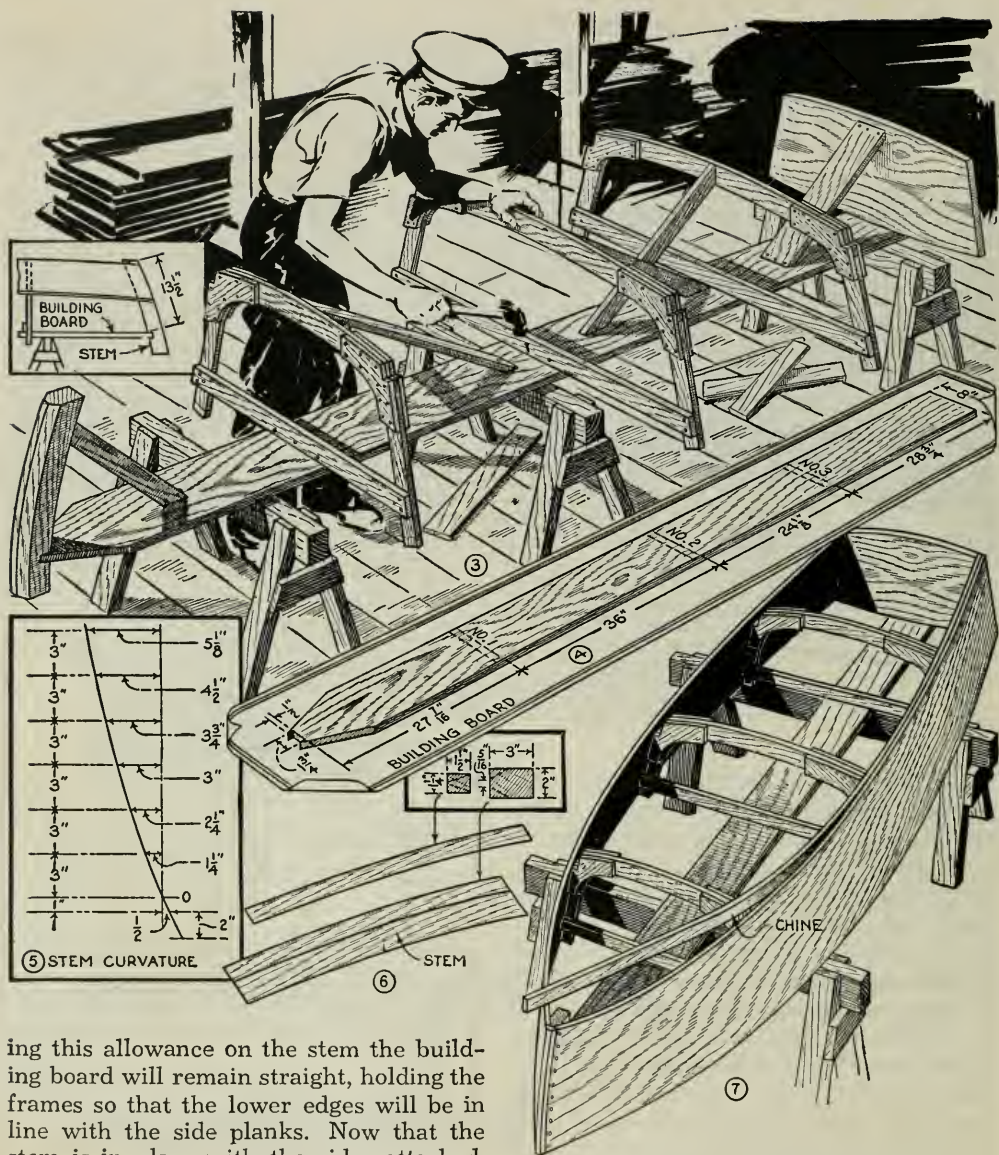

ing this allowance on the stem the building board will remain straight, holding the frames so that the lower edges will be in line with the side planks. Now that the stem is in place with the sides attached, you may continue by bending the sides around the frames and holding them in place with a piece of rope. Fasten the sides to the frames with $1\frac{1}{2}$ -in. No. 8 flat-head brass screws. The transom is also fastened with $1\frac{1}{2}$ -in. flat-head brass screws driven into the check plate and 2-in. screws driven into the end grain of the transom. Fig. 16 shows the offsets and also the exact positions of frames Nos. 1, 2 and 3. Be sure to mark these positions on the sides before bending the latter in position around the frames. The lines are

drawn at right angles to the base line and serve as a guide to placement of the frames in an upright position. Move the temporary braces if necessary to bring the frames into the proper position. Now the second and third planks are placed on each side. The shiplap joints are fastened with $\frac{7}{8}$ -in. copper tacks spaced $2\frac{1}{2}$ in. apart and clinched across the grain. Use marine glue to make the joint waterproof. When the sides are fastened, the next step is to insert the chines as in Fig. 7. Chines are fastened to the frames with $2\frac{1}{2}$ -in. No. 8

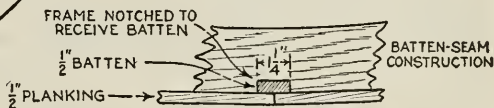
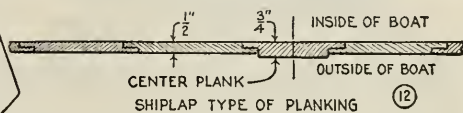
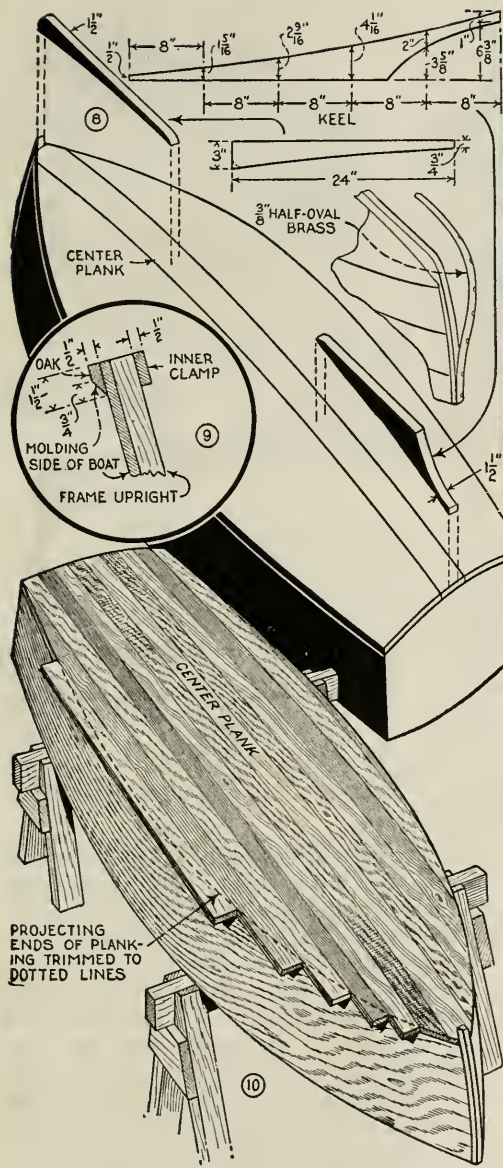

flat-head brass screws and to the sides with 1 1/4-in. No. 6 flat-head brass screws spaced 1 1/2 in. apart in a staggered row. Then fair off the sides, transom and stem, a job which must be done carefully to avoid leaks. At this point, select the type of bottom construction. If it is to be the batten-seam type, battens must be mortised at the proper places and the planks are fastened to the battens with 1 1/4-in. copper nails spaced 2 in. apart and clinched.

If you use the shiplap type, Fig. 12, rabbet the edges of the planks and fasten them together with 7/8-in. copper tacks spaced 2 in. apart and clinched. In either case, bore holes for the tacks, as otherwise the wood is likely to split. Use one 3/4 by 6-in. plank as the center plank, Fig. 10. If you can get them, four 1/2 by 8-in. planks will then finish the job. The planks are fastened to the frames with 1 1/4-in. No. 6 flat-head brass screws, except the center plank, where 1 1/2-in. No. 8 flat-head screws are used. Screws in the chines and along the outer edges of the boat are spaced 1 1/2 in. apart in a staggered row. Use 1 1/4-in. No. 6 flat-head brass screws along this line, as well as into the lower edges of the transom.

This done, the boat is turned over and the centerboard installed. Make up the centerboard well or casing as in Fig. 15. The oak king posts are fastened to the casing with 1 1/2-in. No. 8 flat-head brass screws, spaced 1 1/2 in. apart. The case should fit snugly against the bottom of the boat, and should be notched out at the after end to fit over the No. 2 frame. A

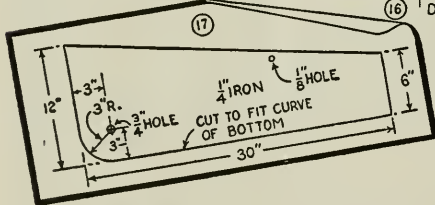
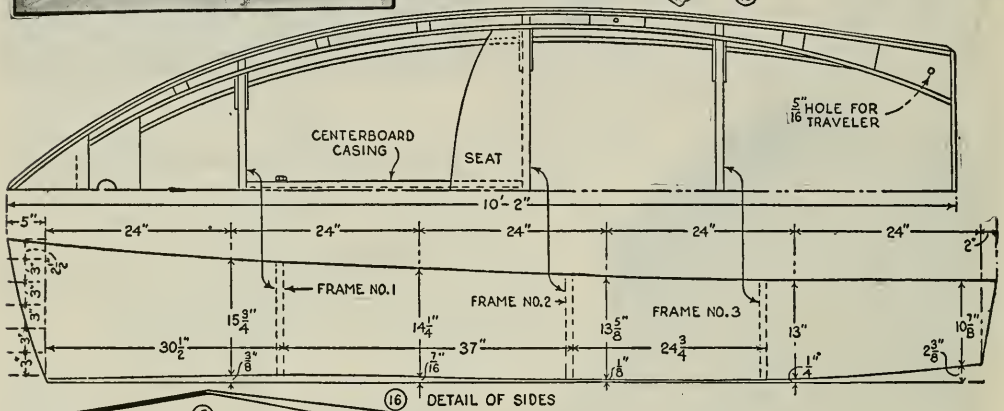
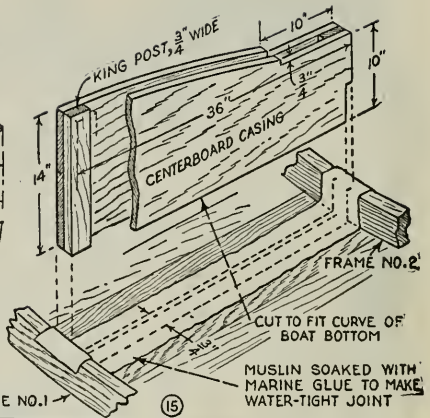
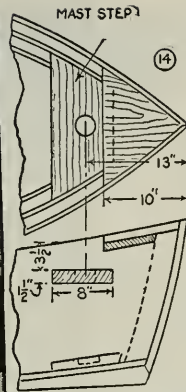

$\frac{3}{4}$ -in. slot is cut in the boat bottom along the centerline as in Fig. 11, the slot being the same length as the opening in the casing. The slot is covered with a gasket made of heavy muslin and coated with marine glue to insure a water-tight joint. The casing is fastened to the bottom with 2-in. screws placed $2\frac{1}{2}$ in. apart. The iron centerboard, Fig. 17, has a $\frac{3}{4}$ -in. hole drilled 3 in. up from the bottom edge and 3 in. in from the side as shown. A hole is bored in the centercase with an $\frac{1}{16}$ -in. bit and the pin used to pivot the board is a $\frac{3}{8}$ -in. pipe nipple, 3 in. long, with a lock nut on each end. By placing a small gasket or piece of cotton behind the lock nut and tightening it, there will be no chance for a leak at this point. A piece of jack

chain is used to raise and lower the board, a pin made of $\frac{1}{4}$ -in. brass rod being slipped through the chain to act as a stop. The cross member of No. 2 frame is now removed and the seat, Fig. 16, put in place. The seat fits over the lower end of the casing and notches into the uprights of the No. 2 frame on each side. This joint beneath the seat must be water-tight as it is near the level of the water on the outside. A cap of $\frac{3}{8}$ -in. material, 3 in. wide, is bent over the curved portion of the casing. The breast hook, Fig. 14, is made of two pieces of wood with the grain running at right angles. The mast partner, cut from $1\frac{1}{2}$ -in. material, is fastened through the sides with 2-in. screws. Now screw the stern knees in place and put the inner clamps in position, Fig. 16. The knees are fastened with 2-in. No. 8 flat-head brass screws and the inner clamps with $\frac{1}{2}$ -in. No. 8 screws. Between the sides and the clamps, the filler blocks, Fig. 16, must be placed. These are made of $\frac{1}{2}$ -in. material, 2 in. long with the exception of those

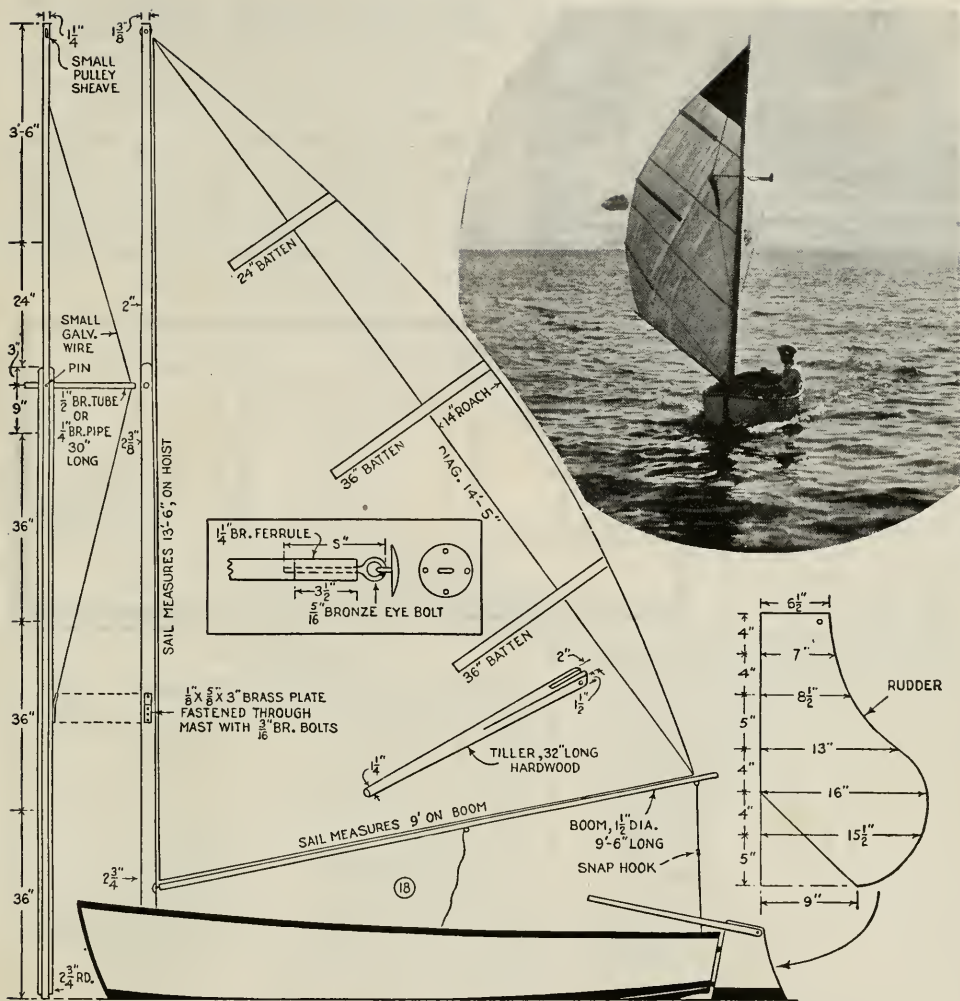

between No. 2 and No. 3 frames, which are 6 in. long and drilled for the oarlock sockets. The boat is now turned over and the keel and skeg put in place as in Fig. 8. When these pieces are made to fit they are fastened from the inside with 1 1/2-in. and 2-in. screws. Before fastening the skeg (forward), the cutwater is shaped up to fit in its proper position. When the cutwater fits perfectly, you calk the ends of the sides and fasten the cutwater in place permanently, which is done with 10-d galvanized finishing nails spaced 3 in. apart. The cutwater is trimmed with 3/8-in. half-oval brass, which extends from the top edge of the boat to about halfway down the skeg. Finally, the molding, Fig. 9, is

fastened in place with 1-in. No. 6 screws spaced 10 in. apart. Use 1 1/2-in. screws through molding at both stem and stern. Bore two 1/4-in. holes in the stern knees and put in 1/4-in. cotton rope for the traveler. Finally, the rudder is made up as in Fig. 18, and attached with rudder irons to the stern. The lower edges of the rudder are slightly tapered to prevent dragging.

The mast, Fig. 18, is quite simple to make by using one 1 1/4 by 3 in. by 16-ft. piece of cypress and two pieces of 3/4 by 3 in. by 10 ft. Casein glue is used to assemble these parts. With a table saw set at a 45° angle you can rip off the corners up to the 10-ft. mark. This will give you an eight-sided section that can be rounded easily



by hand with a small plane. The portion above the 10-ft. mark can be left as it is. At a point 3 in. below the 10-ft. mark a $\frac{1}{2}$ -in. hole is bored through the mast to take the spreader, which is a $\frac{1}{2}$ -in. brass tube, 30 in. long. A small brass pin through the tube and mast holds the spreader in place. Small holes are drilled in the ends of the tube for the galvanized rigging wire which can be of single strand. It is fastened to the mast 5 ft. above the spreader and 5 ft. below. A $\frac{5}{8}$ -in. mast track starting 10 in. below the top sheave extends 12 ft. down the mast. Details of the gooseneck are shown in Fig. 18. The boom is tapered to $1\frac{1}{4}$ in. and a ferrule is slipped over the end, extending $3\frac{1}{2}$ in. back.

When the mast is made up and all the fittings are in place, you install it in the boat. Bore a hole through the mast partner, Fig. 13, and allow the mast to go through until it reaches the step, which is made of $1\frac{1}{2}$ -in. material placed in the bow as far up as possible. Do not nail or fasten it in position until you have set the mast plumb. Scribe a line around the squared end of the mast and another outlining the location of the step on the bottom. Then cut a rectangular socket in the step into which the foot of the mast fits snugly. Fasten the step with $1\frac{1}{2}$ -in. and 2-in. screws through the bottom and into

the skeg. Two upright deck blocks are placed one on each side of the mast on the mast partner. One of these pulleys is used to hoist the sail and the other takes care of the top'n lift. Cleats are attached to the sides of the centercase. A tent cover, Figs. 19 and 20, is quite simple to make and is a protection to the boat and occupants when making short cruises. The edges are held down by a series of screw eyes spaced 8 in. apart just beneath the molding.

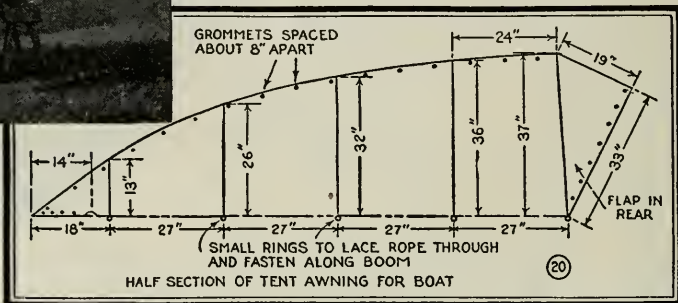

MATERIAL LIST

- | | |
|---|------------------------|
| 2 pcs. $\frac{1}{2}$ x 18 in. x 12 ft. (or equivalent in narrow widths) | side pieces |
| 1 pc. $\frac{5}{8}$ x 6 in. x 10 ft. | chines |
| 1 pc. $\frac{3}{4}$ x 6 in. x 10 ft. | bottom center plank |
| 4 pcs. $\frac{1}{2}$ x 6 in. x 10 ft. | (2 each side) |
| 2 pcs. $\frac{1}{2}$ x 8 in. x 8 ft. | (1 each side) |
| 6 pcs. $\frac{1}{2}$ x $1\frac{1}{4}$ in. x 10 ft. | battens |
| 2 pcs. $\frac{3}{4}$ x $1\frac{1}{2}$ in. x 10 ft. 6 in. | inner clamps |
| 1 pc. $\frac{3}{4}$ x 14 in. x 6 ft. | sides of centercase |
| 1 pc. $\frac{3}{4}$ x 2 x 26 in. | king posts |
| 1 pc. $\frac{3}{4}$ -in. iron | for centerboard |
| 1 pc. $\frac{3}{4}$ x 14 x 30 in. | rudder |
| 1 pc. $1\frac{1}{4}$ x $2\frac{1}{2}$ x 30 in. | tiller |
| 1 pc. $\frac{3}{4}$ x 14 x 38 in. | transom |
| 1 pc. $1\frac{1}{2}$ x 8 x 20 in. | mast partner |
| 1 pc. $\frac{3}{4}$ x 10 in. x 4 ft. | seat |
| 1 pc. $\frac{3}{4}$ x 10 in. x 12 ft. | frames and crosspieces |
| 1 pc. $\frac{1}{2}$ x 3 in. x 12 ft. | oak molding |
| 1 pc. $1\frac{1}{2}$ x 8 in. x 1 ft. | mast step |
| 2 pcs. $1\frac{1}{2}$ x 4 in. x 1 ft. | stern knees |
| 1 pc. $1\frac{1}{2}$ x 8 in. x 4 ft. | skeg and keel |
| 1 pc. 2 x 8 x 24 in. | stem and cutwater |
| 1 pc. pine $\frac{3}{4}$ x 8 in. x 12 ft. | building board |
| 1 pc. $1\frac{1}{4}$ x 3 in. x 16 ft. | mast |
| 2 pcs. $\frac{3}{4}$ x 3 in. x 10 ft. | mast |
| 1 pc. 2 x 2 in. x 10 ft. | boom |

Hardware

- 2 gross $1\frac{1}{2}$ -in. No. 8 flat-head brass screws
- $\frac{1}{2}$ gross 2-in. No. 8 flat-head brass screws
- 5 gross $1\frac{1}{4}$ -in. No. 6 flat-head brass screws
- $1\frac{1}{2}$ lbs. of $1\frac{1}{4}$ -in. copper nails (if battens are used)
- $\frac{1}{2}$ lb. copper tacks, $\frac{3}{8}$ -in. (if lap joint is used)
- 1 sheave for top of mast
- 2 swivel pulleys for sheet line
- 2 deck blocks for halyard and top'n lift
- 1 flat deck block for top'n lift
- 75 ft. $\frac{1}{4}$ -in. cotton rope for lines and rope traveler
- $\frac{1}{2}$ pint, C-quality marine glue
- $\frac{1}{4}$ lb. casein glue
- Brass and brass volts for guy-wire attachments
- 3 ft. $\frac{3}{4}$ -in. half-oval brass for bow trim
- 25 ft. galv. wire
- $\frac{3}{4}$ -in. brass tubing, 30 in. long
- 2 ft. jack chain for centerboard lift

Woods generally used for small-boat construction are: Spruce or oak for frame; pine or oak for the stem, and mahogany, cedar or cypress for planking. Knees, mast steps, inwales and other small parts either visible or subject to strain—oak or mahogany.

A ROWBOAT *goes Sailing*

By David Swartwout

EQUIPPED with this inexpensive portable sail rig any rowboat becomes a sailboat. While dimensions given in Fig. 2 are for a small boat having a beam of 4 ft., the length of the thwart may be varied to suit the boat at hand. With the exception of the rudder and tiller, which should be made of oak, $\frac{3}{4}$ -in. pine will do for the leeboards and thwart. Begin by making the thwart. Two pieces of 6-in. stock, cut to the proper length and mitered $22\frac{1}{2}$ degrees, are held together with a notched cleat fastened to the underside with $\frac{1}{4}$ -in. brass screws as in Fig. 1. The forward piece which rests on the breast hook, is attached to the thwart with a large T-hinge. The barrel of the hinge should be fitted with a removable pin so that the assembly may be taken apart easily for storing. Two bolts passing through

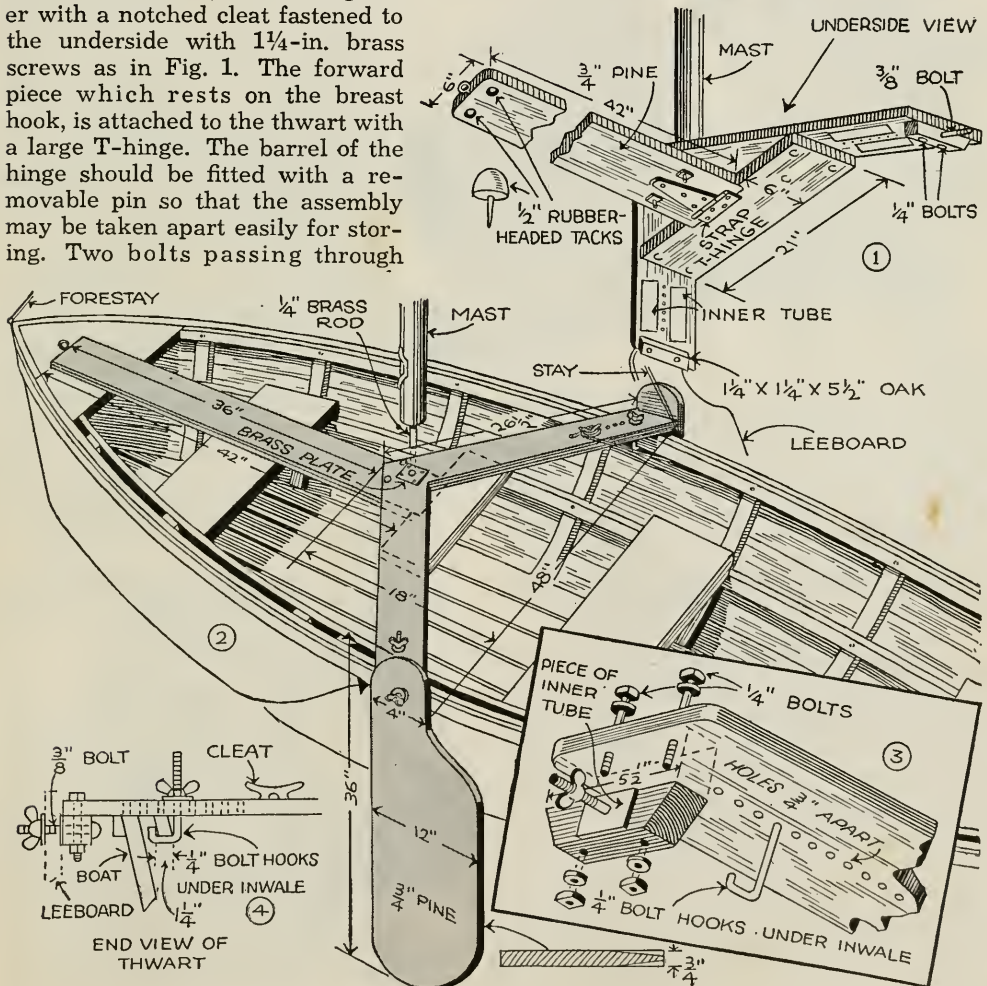

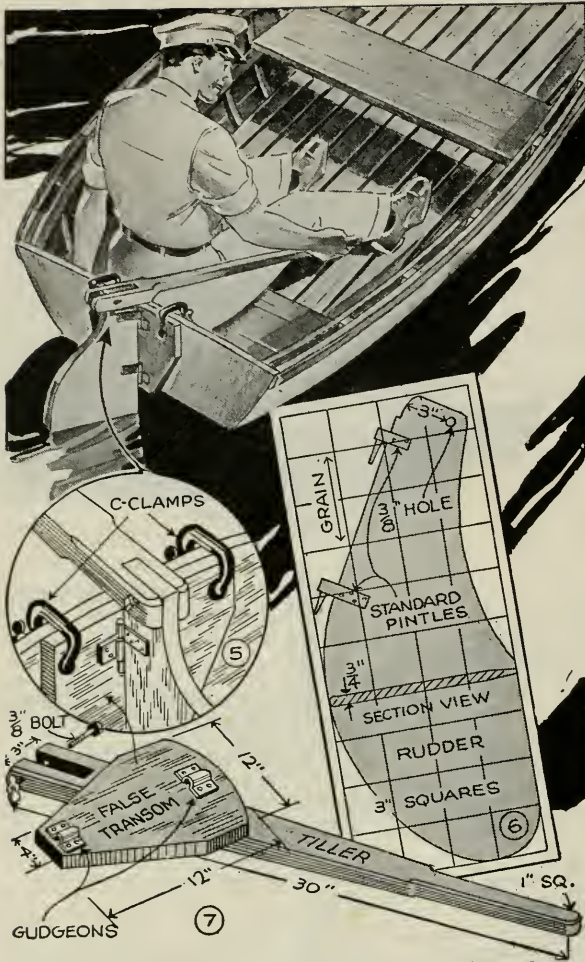

justing the two hook bolts which are bent from a 1/4-in. brass rod, threaded and fitted with wing nuts as in Fig. 3. Fig. 4 shows how these bolts hook over the boat inwales. Oak blocks are next bolted to the extreme ends of the thwart and are fitted with 3/8-in. bolts for attaching the leeboards as in Fig. 3. Pieces of inner tube slipped over the bolts serve as rubber washers to keep the leeboards vertical. Strips of rubber as well as rubber-headed tacks are also fitted to the underside of the thwart to protect the finish of the boat. Next, the leeboards which provide lateral balance to the boat when under sail, are cut from 12-in. pine stock, following the design given in Fig. 2. The after edge of the board is tapered as shown in the sectional detail. A 1/16 by 3 by 3-in. brass plate with a 1/4-in. hole made in the center to receive a brass pin driven up into the end of the mast, is screwed to the top side of the thwart at the center. The mast is held upright by two shrouds and a forestay. See Fig. 2.

Details of the rudder, tiller and false transom, and the method of clamping the assembly to the stern with a pair of C-clamps are shown in Figs. 5, 6 and 7. Standard pintles and gudgeons are used to hinge the rudder, after which the tiller is pivoted at the top by a single bolt fitted with a wingnut. A small lanteen sail, similar to a canoe or kayak sail, of 50 or 60 sq. ft. area, is recommended.

holes in the peak of the thwart securely clamp the forward member in place. To make the rig adaptable for use on several boats whose beam may vary slightly, a series of 1/4-in. holes spaced 3/4 in. apart, is provided at each end of the thwart for ad-

justing the two hook bolts which are bent from a 1/4-in. brass rod, threaded and fitted with wing nuts as in Fig. 3. Fig. 4 shows how these bolts hook over the boat inwales. Oak blocks are next bolted to the extreme ends of the thwart and are fitted with 3/8-in. bolts for attaching the leeboards as in Fig. 3. Pieces of inner tube slipped over the bolts serve as rubber washers to keep the leeboards vertical. Strips of rubber as well as rubber-headed tacks are also fitted to the underside of the thwart to protect the finish of the boat. Next, the leeboards which provide lateral balance to the boat when under sail, are cut from 12-in. pine stock, following the design given in Fig. 2. The after edge of the board is tapered as shown in the sectional detail. A 1/16 by 3 by 3-in. brass plate with a 1/4-in. hole made in the center to receive a brass pin driven up into the end of the mast, is screwed to the top side of the thwart at the center. The mast is held upright by two shrouds and a forestay. See Fig. 2.

Fishing Rod Wrapped With Aid of a Pencil and Eraser

To apply a tight, smooth wrapping of thread when making repairs on a split-bamboo fishing rod, one angler suggests the use of a pencil and eraser. The pencil carries the spool of thread so that it may be rotated easily around the rod, and the eraser is slit to receive the thread and hold it tightly during the operation.

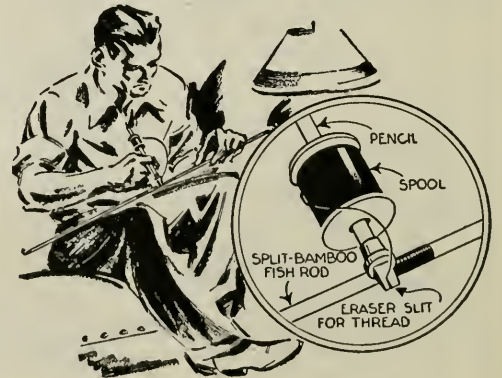

☛ A horseshoe cast in a block of cement forms a good anchor for a boat. The rope should be tied to the projecting curve of the shoe.

MINNOW TROW

Sheet metal and wire mesh are soldered together to form this handy little minnow trow, which will keep the fisherman's bait alive on the hottest day, when the usual minnow bucket, kept in the boat, would fail. In use, it is towed behind or alongside the boat and causes very little resistance because of its shape, and thus it does not make rowing inconvenient due to drag. The wire-mesh sides permit a constant change of fresh, cool lake or river water, which is the reason for its success. While the details given here were taken from a model that proved entirely satisfactory in actual use, you can make a larger one of similar proportions if desired. Airtight chambers keep it afloat even in rough weather, and as sheet metal is used for construction, the trow should last indefinitely.

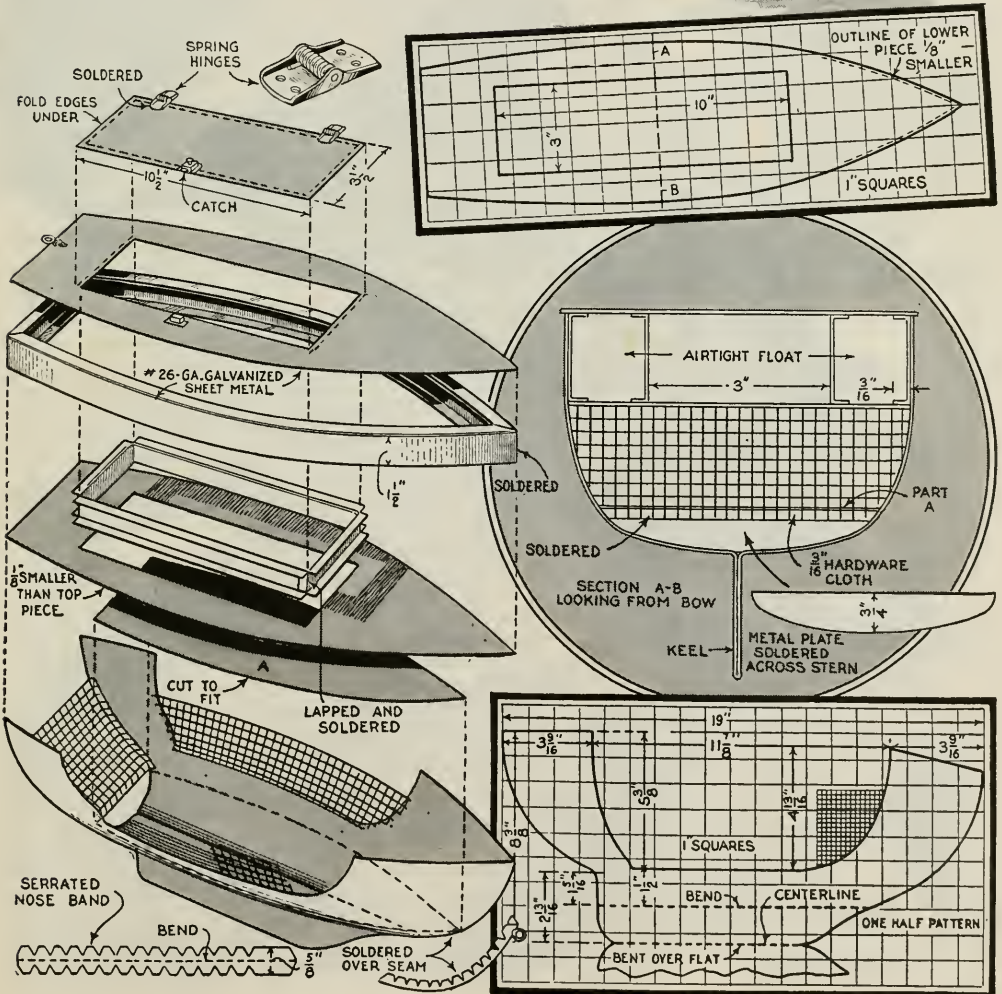

Build "BANTA"

IF YOU want a lightweight utility boat with a nice turn of speed and easy handling, build "Banta." A boat like this has a lot to recommend it—simple, inexpensive construction, a one-man weight of less than 110 lbs., practically leakproof—she's a smooth, easy sailor on any man's river. Good for rough water, too. The vee-bottom of "Banta" makes her a much better rough-water boat than conventional flat-bottom plywood construction. She'll ride 'em!

Making the frames: Make the frames first, using

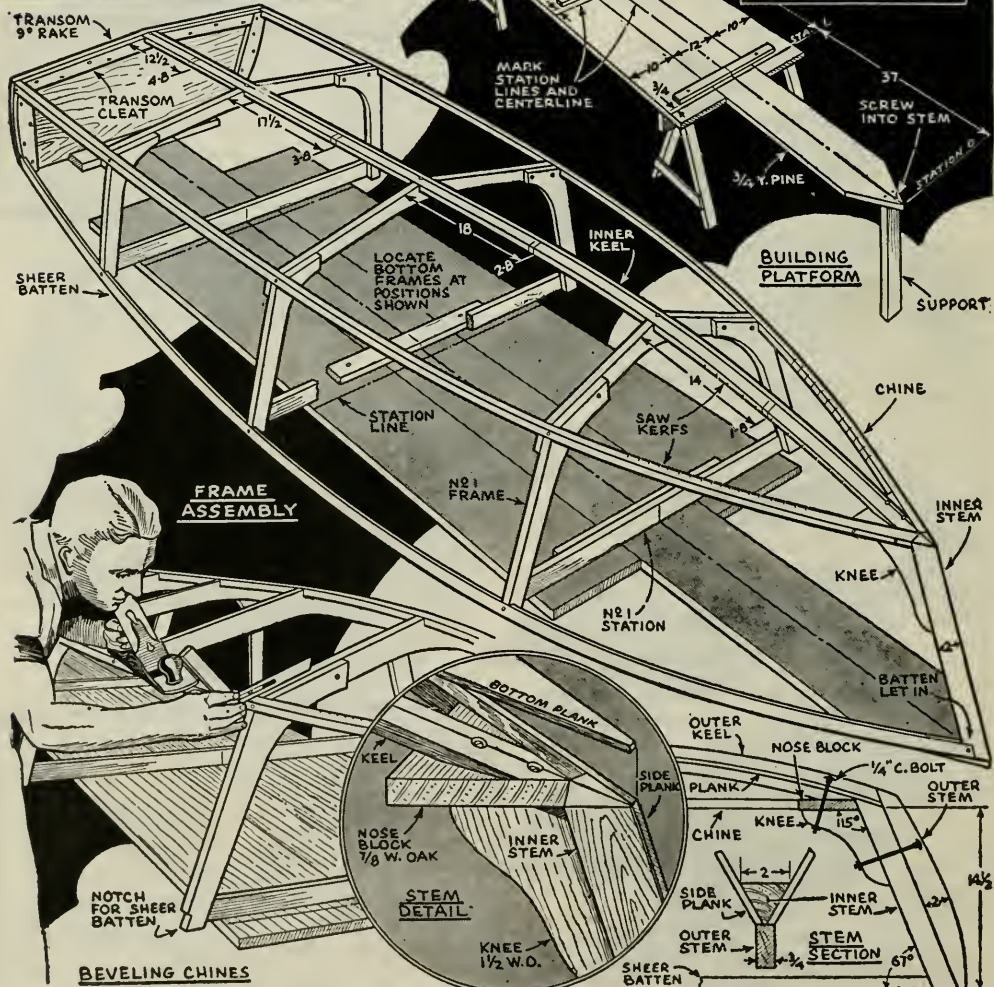
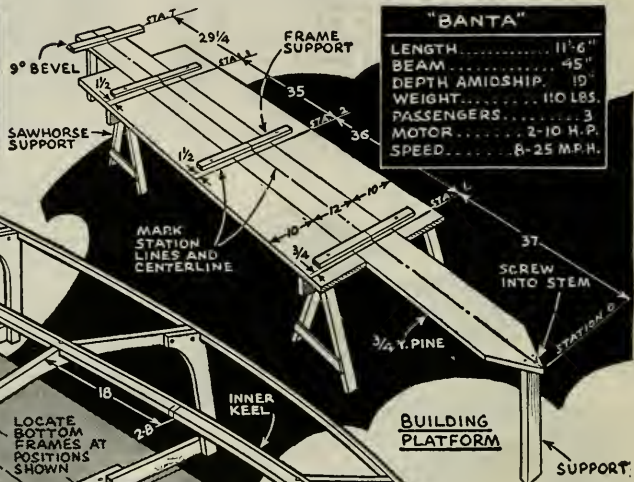
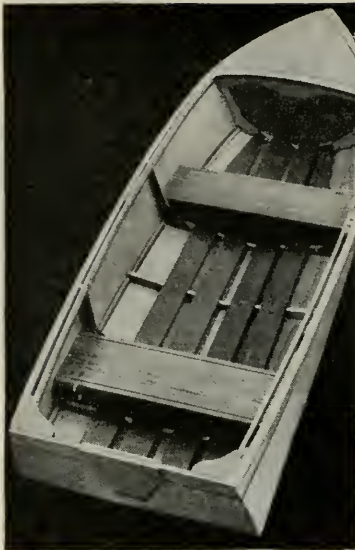

12-Foot Plywood Outboard

oak, elm, pine or mahogany. Draw each frame carefully on a piece of building paper and make the assembly over this after cutting the parts to shape on the bandsaw. The side frames are curved out at the bottom to produce a good landing on the bottom frames. An optional method of construction is to butt the side and bottom frames together and tie them with $\frac{1}{4}$ -in. plywood gussets on either side. The transom is band sawed from $\frac{3}{4}$ -in. marine plywood to the dimensions given. It is cleated at the edges and bottom with the frame stock. The transom is raked 9 degrees, which amounts to $2\frac{5}{8}$ in. in the height given. The top and bottom bevels can be cut at the time of sawing out.

Frame assembly: Banta is built upside down on a level surface, the most convenient method of working being to make a building platform, as shown in the drawing. On the surface of the platform, run in a pencil centerline and mark the station lines. Cleats fastened parallel to the station lines as shown will provide a support and locate each of the main frames. The keel is now fastened to the frames and transom, checking carefully to maintain each frame true and square with the building platform. The stem is a triangular piece of white oak, mounted at the extreme nose of the building platform at an angle of 67 degrees. It is a good idea to make a full-size drawing of the assembly at the stem since this will show exact lengths, angles, etc. As can be seen in the stem detail and section drawings, the forward end of the keel fastens to a nose block, the nose block being held to the stem by a knee. The chines go on easily, the assembly at the stem being to either side of the nose block. All joints are screw-fastened. The carriage bolt fastenings at the stem are not put in until the boat is complete. It will be noted in the drawing that the forward end of chines and keel are saw kerfed. This makes bending easier and also helps to maintain a full curve. The kerfs can be cut on the band saw, $\frac{1}{8}$ in. deep and 1 in. apart for the chines, and $\frac{3}{16}$ in. deep by $1\frac{1}{2}$ in. apart on the keel. All frames must be beveled to carry out a smooth line, and the keel and chines are planed down to come flush with the frame shape. The sheer batten goes on without much trouble, being let into the stem. The whole frame assembly should be made dry and is knocked down and reassembled with cold resin glue after the work of fitting has been

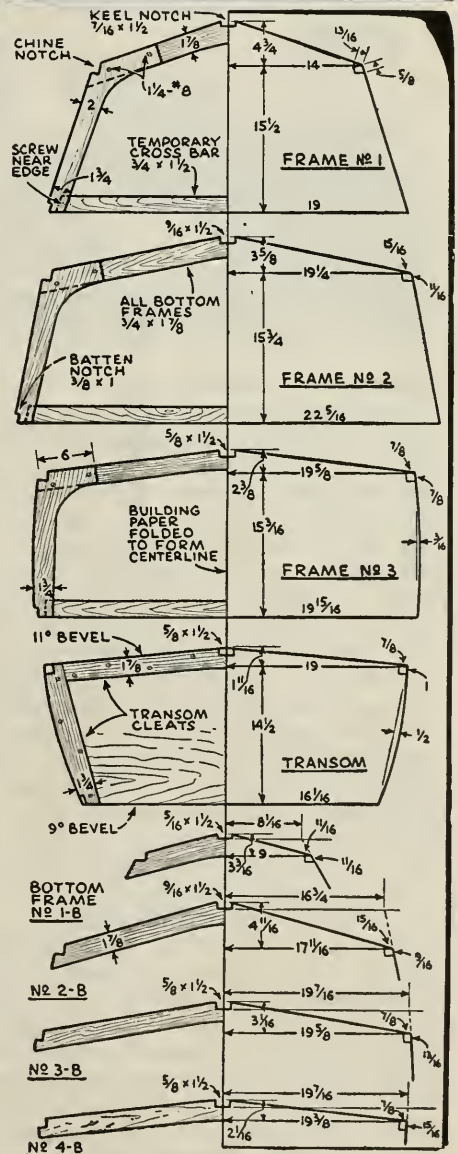

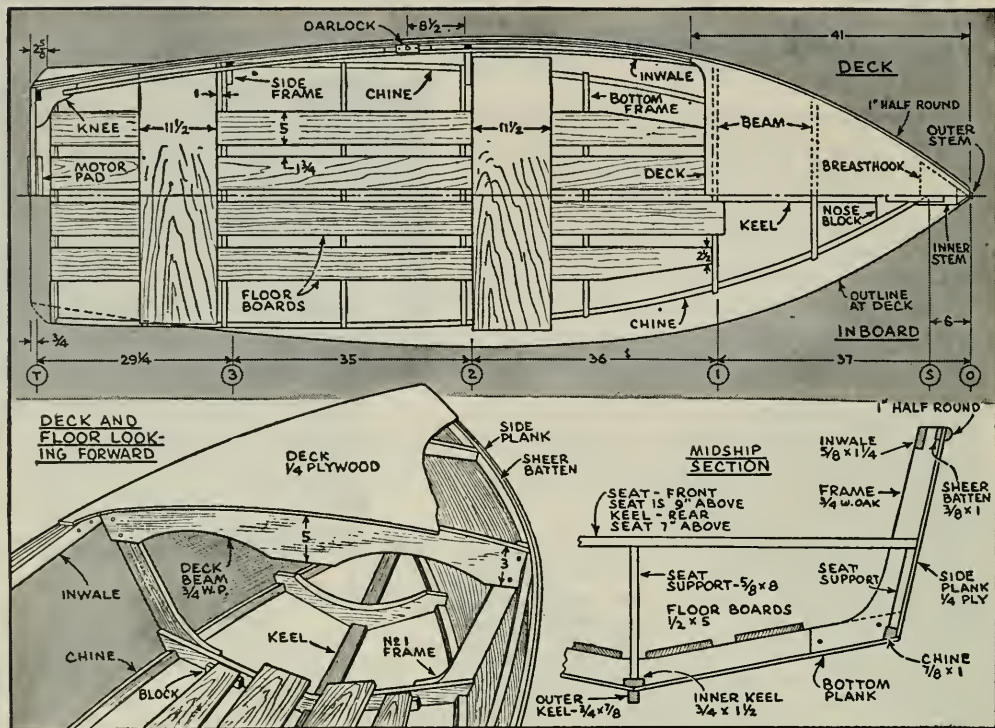

finished and found completely satisfactory.

Planking: Planking for Banta is 1/4-in. fir plywood of the waterproof, resin-bonded type. Two standard 4 by 12-ft. sheets are required. One sheet will make the two side planks, while the other sheet will cut the two bottom planks and the deck. The side planks are applied first. Fitting is quite simple since the half sheet of plywood can be bent to the frames and held with clamps while the shape is being marked with a pencil. The planks are cut off square at the stem and will provide a flat of about 3/4 in. on which to land the outer stem piece. The bottom planks butt together at the keel and extend over the side planks. All fitting should be done dry, after which the permanent assembly can be made with cold resin glue. The outer keel is vee-cut on the circular saw to fit the angle of the bottom planking.

Floor and deck: The fitting of floor boards is quite simple and clearly shown in the drawings. The deck is 1/4-in. marine plywood bent to a crown of about 2 in. The main deck beam is spanned across frame No. 1. There is an intermediate deck beam about 15 in. forward of this, and a breasthook at the extreme forward position behind the stem. Notches are cut on the

inner edge of No. 2 and No. 3 side frames to take the inwales. At frame No. 1 the inwale is beveled slightly and fastened directly to the sheer batten, as can be seen in the drawings. At the transom the inwales are let into wooden knees. Seats are spanned across the hull and butt against the planking. Each seat is supported with a riser at the center and at either end, the end risers extending down to the chines.

Finishing: The hull can be finished natural or painted as desired. In either case, the fir planking will take a much better finish if given a first coat of special plywood sealer and primer. This will prevent hairline checking and the typical fir fault of showing the ridges of the grain structure even under two or three coats of paint. The use of oak for any member which is to be finished bright should be avoided since it tends to blacken on contact with fastenings and glue. A typical finish would be red or green bottom up to the chine; red outer stem and half round moulding; interior natural wood varnished or painted buff brown; floor boards dark green. Minimum hardware would include lifting handles fore and aft, kapoc-filled cushions, and oars or a paddle. In addition to minimum equipment, Banta must com-

ply to government regulations for Class A power craft if operated on Federal waterways.

MATERIAL LIST

LUMBER

- Frames, oak, elm, mahogany, white pine, 3 pcs., $\frac{3}{4}$ x 8 x 8 ft.
- Transom, waterproof fir or mahogany marine plywood, 1 pc., $\frac{3}{4}$ x 17 x 39
- Inner Keel, oak, pine, spruce, yellow pine, 1 pc., $\frac{3}{4}$ x $1\frac{1}{2}$ x 11 ft.
- Outer Keel, oak, yellow pine, 1 pc., $\frac{3}{4}$ x $\frac{7}{8}$ x 11 ft.
- Chines, pine, oak, mahogany, 2 pcs., $\frac{7}{8}$ x 1 x 12 ft.
- Sheer Battens, oak, mahogany, 2 pcs., $\frac{5}{8}$ x 1 x 12 ft.
- Nose Block, oak, 1 pc., $\frac{7}{8}$ x 5 x 6
- Stem Knee, oak, 1 pc., $1\frac{1}{2}$ x 5 x 8
- Planking, waterproof fir or mahogany marine plywood, 2 pcs., $\frac{1}{4}$ x 4 ft. x 12 ft.
- Deck, waterproof fir or mahogany marine plywood. This item will cut from planking stock on sheet used for bottom planking
- Deck Beams, white pine, spruce, 1 pc., $\frac{3}{4}$ x 8 x 4 ft.
- Breasthook, white oak, yellow pine, 1 pc., $1\frac{1}{4}$ x 5 x 8
- Inwales, oak, yellow pine, mahogany, 2 pcs., $\frac{5}{8}$ x $1\frac{1}{4}$ x 9 ft.
- Inner Stem, oak, yellow pine, 1 pc., $1\frac{3}{4}$ x 2 x 18
- Outer Stem, oak, yellow pine, 1 pc., $\frac{3}{4}$ x 2 x 18
- Floor Boards, white pine, cypress, redwood, 4 pcs., $\frac{1}{2}$ x 5 x 9 ft.
- Seats, white pine, mahogany, 1 pc., $\frac{3}{4}$ x 12 x 8 ft.
- Seat Supports, white pine, 1 pc., $\frac{3}{4}$ x 8 x 4 ft.
- Motor Pads, $\frac{1}{4}$ fir plywood, 2 pcs., $\frac{1}{4}$ x 5 x 12.
- This item will cut from planking stock
- Transom Knees, yellow pine, white oak, 1 pc., $1\frac{1}{4}$ x 8 x 8
- Sheer Moulding, yellow pine, white pine, 2 pcs., 1 inch half round, 12 ft. long

FASTENINGS

(galvanized, cadmium plated or brass)

- Planking, flat head wood screws, 1 inch No. 6, 34 doz.
- Frames to keel, chines to frames, $1\frac{3}{4}$ inch No. 10, 4 doz.
- Deck, $\frac{3}{4}$ inch No. 6, 4 doz.
- Transom cleats, frame assembly, $1\frac{1}{4}$ inch No. 8, 4 doz.
- Floors, seats, inwales, $1\frac{1}{4}$ inch No. 8, 4 doz.
- Outer keel to inner keel, outer stem to inner stem, 2 inch No. 10, 2 doz.

MISCELLANEOUS

- 1 pint cold resin glue
- 1 quart plywood sealer and primer
- 1 pint undercoat paint, enough for 1 coat
- 1 quart finish paint, enough for 2 coats
- 3 lifting handles, 1 at stem, 2 at transom
- Class A equipment if boat is operated on federal waterways

Detachable Canvas Seat in Boat Accommodates Extra Person

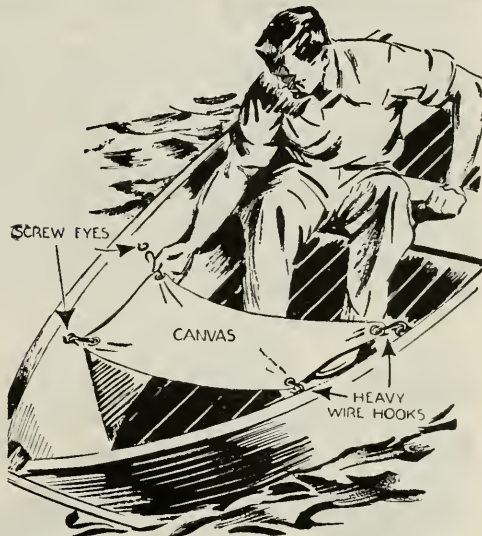

This boat seat, which is made from heavy canvas, comes in handy when carrying an extra passenger. It hooks into screw eyes driven into the boat sides and is quickly removed and rolled up when not in use.

Canoe Carried Single-Handed

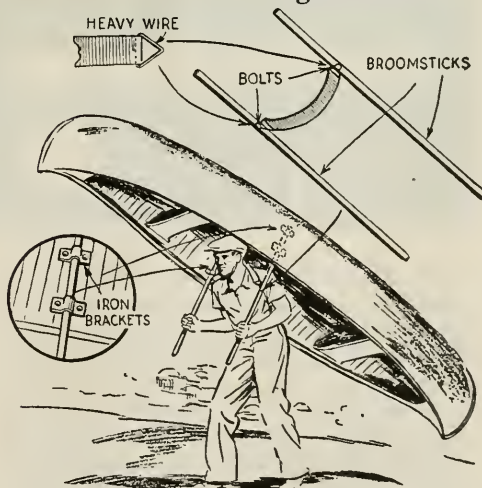

Sportsmen who employ a light canoe on their hunting or fishing trips are often obliged to carry it around rapids or shallows. If two pieces of broomstick are provided with a canvas shoulder strap, as shown, they may be used to carry the boat much more conveniently. The ends of the handles fit into iron brackets screwed to the inner surface of the canoe.

Feathercraft Gives New Sport to Swimmers

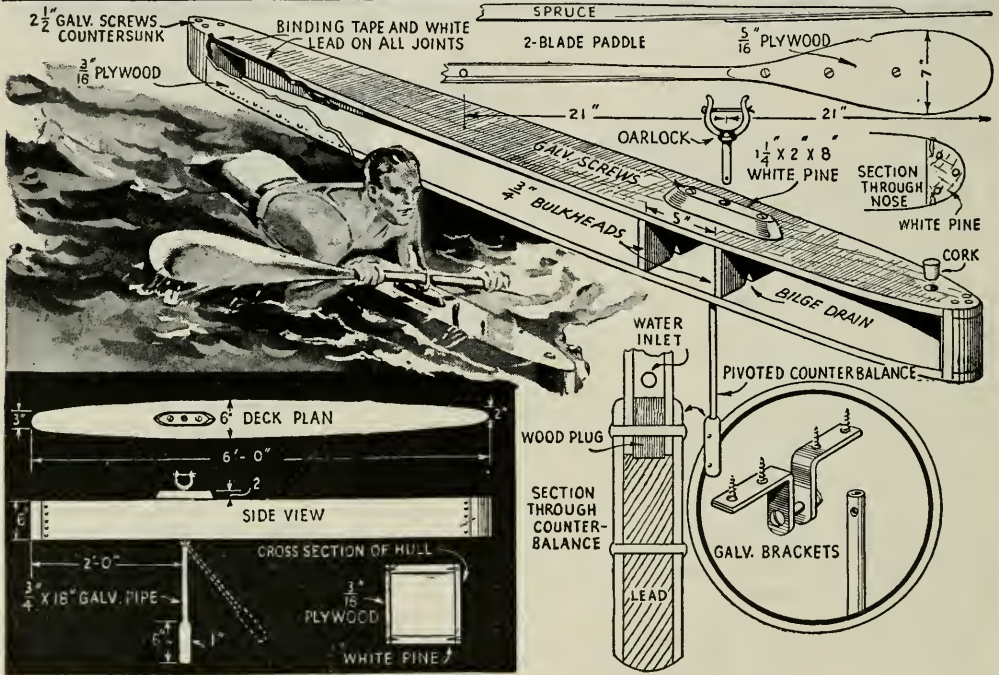

Propelled half by swimming and half by paddling, these featherweight pontoons will provide plenty of sport at any beach. They are 6 ft. long, tapered and rounded at both ends. Top and bottom are pieces of 3/4-in. white pine of exactly the same size and shape. These are screwed to nose and stern blocks and to two bulkheads located under the oarlock. Sides of 3/16-in. plywood are then cut out. It is preferable to use waterproof plywood for this purpose, but if this is not available, ordinary plywood given several coats of paint, especially at the edges, will do. In order to make the pontoon watertight, all joints must be given a liberal application of white lead and a strip of binding tape laid between the contacting surfaces. This should

be done at the nose and stern blocks before the top and bottom are screwed on, and similarly when the plywood sides are attached. Note the bilge drain in the bulkheads, which helps to empty the hull of water, should any get inside. The drain hole at the nose is corked when the pontoon is in use. Besides serving to drain out the water, the cork, if not pushed in too tight, will prevent the hull from bursting when the air inside expands under the hot sun, for which reason an air vent is necessary. A beveled block on the top takes an oarlock for a two-blade paddle. To balance the pontoon properly, an 18-in. counterweight is pivoted to galvanized angle-iron brackets, which are screwed to the bottom directly under the oarlock.

Carrier Transports Boat Safely on Top of Car

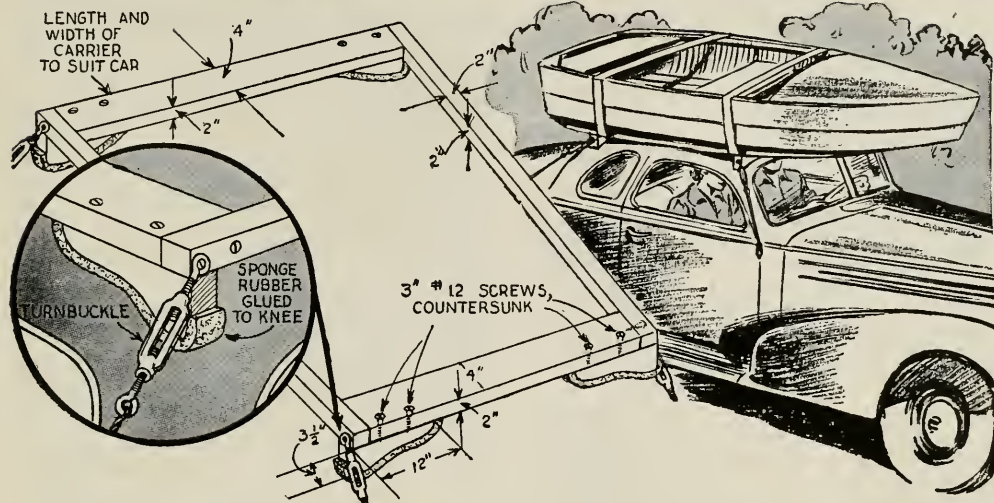

Taking your boat along is no trick at all if you spend a few minutes time to make this carrier, which fits on the top of your car. As you see, it's a very simple affair joined together with heavy screws for maximum strength, and is capable of carrying boats, kayaks and canoes up to 300 lbs. in weight. The carrier is supported at the corners by curved feet, which are cut to the contour of the car top and padded

with strips of sponge rubber to prevent marring the finish. Cradles cut to the contour of the boat bottom can be attached directly to the carrier frame with bolts. The cradles should be padded and fitted with adjustable straps of heavy webbing to hold the boat in position. Rods and turnbuckles are used to hold the carrier in place, these being cut to lengths to suit the car.—William D. Jackson, Knox, Ind.

Heavy Outboard Motor Moved on Detachable Wheels

Having an outboard motor that was too heavy to carry, I moved it wheelbarrow fashion on a couple of detachable wheels. These consisted of the wheels and an axle obtained from a boy's express wagon. In my case, the axle was bolted to lugs on

the gas tank of the motor, both the axle and lugs being drilled to take the bolts. If your motor has no lugs on the tank, iron brackets usually can be slipped under some bolt or cap-screw heads for attachment of the wheels.

—Lloyd Jensen, Los Angeles, Calif.

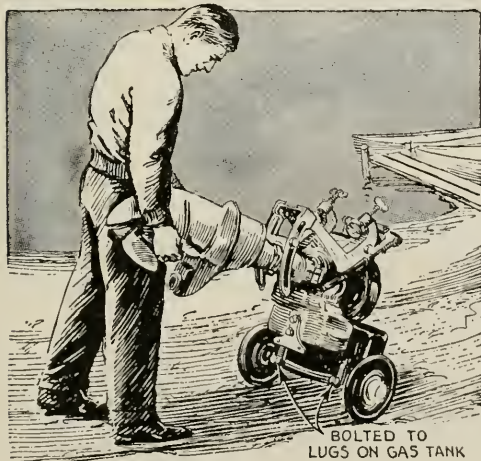

Overflow Gauge for Boat Tanks

The fire hazard of slopping gasoline over into the cockpit of a motorboat when filling the tank, can be avoided with this simple gauge. First insert the gauge into the tank and then lower the funnel over it. Stop the flow from the dock pump at intervals while the float seeks its level.

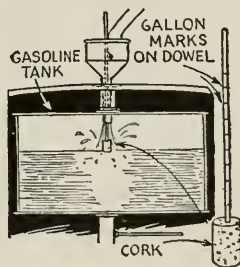

The Young Craftsman Index

A

Airplane, Model	
balanced with clay.....	149
bomb rack for.....	126
nose plugs from tube caps.....	154
rubber wheels from erasers.....	153
twin props double flight time.....	154
Ants, keeping out of lunch box.....	135
Archery	
homemade bow sight.....	181
making arrows visible.....	181
making bows, arrows.....	182
sight on bow improves aim.....	181
Ash Tray	
from fish head.....	129
miniature wheelbarrow.....	52

B

Bank, novel savings.....	16
Basketball, weighted towels tossed to players.....	187
Bean Bags, throw for fun.....	121
Belt, leather.....	89
Bench, cat.....	59
Bicycle	
broom clamp supports.....	102
carrying rack clamps on car bumper.....	106
handlebars have reflectors in grips.....	104
jig aids in truing wheels.....	104
lock.....	105
mudguard.....	105
putting initial on.....	105
ramp swings out of way.....	105
reflectors on pedals.....	102
repairing worn chain.....	105
rubber straps on basket hold books.....	102
"saddlebag".....	106
sidecar.....	104
stoplight switch operated by chain.....	102
trailers.....	103
Billfold, leather.....	87
Bird Bath, fitted with trapeze.....	95
Bird Cutout, realistic wings for.....	68
Bird Feeders	
pan nailed to tree trunk is good.....	96
pivot mounting for.....	95
split keg provides.....	97
winter snack shacks.....	101

Bird Houses

cool, of asbestos cement.....	98
easy-to-make.....	96
keeping cats out of.....	96
span garden gate.....	97
sparrow proof.....	96
springy perch discourages intruders.....	96
wren, from auto casing.....	97
wren, six unusual.....	93
Birds, keeping at home in your garden.....	100
Blackboard, ruling lines on.....	156
Boats, Boating	
anchor, homemade.....	214
canoe, carrying single handed.....	219
carrier on car, transports safely.....	221
feathercraft for swimmers.....	220
minnow trow.....	215
motor moved easily on detachable wheels.....	221
outboard, 12-ft. plywood.....	216
rowboat, 12 ft.....	205
rowboat, sailing a.....	213
sailboat, building Biloxi dinghy.....	206

seat, detachable canvas.....	219
tanks, overflow gauge for.....	221
Bobbed.....	173
Book Binding.....	81
Book Ends	
"Lazy-Peon".....	23
putting to other uses.....	26
railroad.....	27
Book Shelves, long, narrow.....	24
Bootjack, crocheted stick serves as.....	134
Boot Laces, simple way of tying.....	133
Bottle Caps, screw eye removes.....	133
Boxes	
non-scratch feet for.....	141
padded feet for small.....	148
Bracelets, walnut shell.....	92
Brackets, strap hinges serve as shelf.....	15
Brads, small spring holds.....	144
Brazing, fixture simplifies.....	140
Breadboards.....	17
Brush, way to clean.....	146
Buzzer, remote clock starts.....	161

C

Cabinet, memo includes mirror.....	15
Camp Stove, improvised, smothers fire.....	134
Candle, self-extinguishing.....	134
Candlesticks, fish-shaped.....	5
Cannon, toy, shoots rubber shells.....	124
Canoe, attaching outboard motor to.....	133
Car, simplified steering for sidewalk.....	123
Chair, elephant.....	63
Chariot, barrel-body for backyard warrior.....	127
Checkers, upholstery tacks hold from sliding.....	110
Chemical Lab, equipping.....	157
Chest, sea type.....	41
Cigarette Tray, colorful.....	52
Clamp	
holding beveled work in.....	145
improvised.....	147
modelmaker's.....	149
Clocks	
banjo, Spanish style.....	34
colorful, assembled from plastics.....	33
Cocoon Shells, craft with.....	91
Compass, pocket comb used as.....	156
Condiment Set, wooden.....	18
Costume Jewelry.....	92
Croquet	
arches located easily.....	174
scraper for court.....	176
Croquet Wickets, gaily colored.....	71
Crossword Puzzle, gadget helps solve.....	117
Cups, paper, used in workshop.....	146

D

Desk	
inexpensive.....	46
study, made of plywood.....	45
Dish, dog's, is hard to overturn.....	138
Disks, wood, cut on circular saw.....	139
Diving Board, temporary, supported by oil drum.....	176
Dog Houses	
door removed easily.....	138
insulated.....	138
several types.....	136
Dogs, wooden, carry parkway numbers.....	67
Doll House, apartment with elevator.....	109
Doorbell Buttons, decorative plates for.....	8
Doorstop, traffic cop.....	59

Drawer Pulls	61	Leathercrafting	86
clothespin heads provide.....	145	Lettering, novel, done with noodles.....	156
modern	147	Lights, motorized switch flashes	167
Drawing Board, casement adjuster holds at angle.....	155	Linoleum Inlays	17
Drill		Lock, secret	46
modelmaker's, from scrap parts.....	145	Loom, small, delights youngsters.....	79
selecting proper	146	Lung Tester	108
small, stored in block.....	141		
Drilling Glass	141		
		M	
E		Magazine Baskets	
Electric Motors, five toy.....	162	assembled from lathe turnings	20
		oak leaf	20
F		Magazine Rack, attractive, cut on scrollsaw.....	23
Fireplace, outdoor	135	Magnet, envelope removes tacks from.....	144
Fishhooks		Mailbox, resembles prairie schooner.....	8
holder for, is waterproof.....	132	Microscope	
loop in end of line, to change easily.....	132	color filter is adjustable.....	128
safety pin holds	132	made from spool.....	128
Fishing Line, shotgun shell holds paraffin to wax.....	132	micro-reflector aids in sketching specimens.....	128
Fishing Rod, steel-tube case for.....	130	razor guard used as rack for slides.....	128
Fly Vise, quick acting.....	131	slides supported by soda straws.....	128
Footstool, pioneer	48	Moccasins, leather	87
Furniture		Models	
built without nails.....	40	deadeyes for ship.....	153
child's room	59	making ratlines for ship.....	154
junior's has secret compartments.....	41	portholes for boat.....	149
		portholes for ship.....	152
G		steering gear for ship.....	153
Games, Indoor		Model, tool for picking up parts.....	149
"balloon dodger" hoop tests your skill.....	110	Model Train, cotter key serves as flagstaff.....	154
throw bean bags for fun.....	121	Motors, five electric.....	162
Gardens, miniature	168		
Glass, etching	160		
Glue, spreading with comb.....	139	N	
Gluing curved work.....	142	Nail Kit, handy	148
Golf Bag, strap cushioned to protect shoulder.....	187	Nails, bobby pin holds.....	140
Grinder Head, sturdy.....	143	Necklaces, walnut shell	92
		Neckties	
H		holder for	55
Hamper, clothes	60	personalized rack for.....	56
Hangers, clothes	60	silent valet holds.....	54
Hat Rack, jigsawed.....	22	Novelties in Wood	9
Helmet, hanger for football.....	176	Novelties, turned, with personality.....	5
Hot Pads, scrolled.....	12		
House Numbers, novel	64	O	
		Outdoor Gym	187
I			
Ice, marking off for hockey game.....	172	P	
Ice-Fishing, signals for.....	131	Paint Cups, from milk cartons.....	147
Ice Scooter	171	Parallel Lines, drawing several at once.....	156
		Parkway Numbers, wooden dogs carry.....	67
J		Perches, bird, from coat hooks.....	96
Jewelry Box, "beehive," has two compartments....	32	Pestle, emergency, from door knob.....	160
Jig, dowel-cutting	148	Photography	
Jumbo, carving with a jackknife.....	76	Cellophane filters	191
		clock, pointer on, times development.....	202
K		colored paper, strips of, identify film holders.....	198
Kites	177	enlargers, jiffy	195
fast winding reels.....	179	extension cord wound on cleat.....	198
parachutes add zest to flying.....	180	ferrotype tin, ways to keep from bending.....	197
string marked to measure distance.....	180	film clips hook over line.....	191
Knobs, washers keep tight.....	142	film packs, discarded, serve as cases for insects.....	194
		films developed without scratching.....	198
L		identifying trays in dark	191
Lamp		light, paper strip diffuses.....	203
adjustable, for workshop.....	140	paper clips provide clips to handle film.....	196
mounting reflector on.....	166	photo printer, small	199
non-sag shop	148	picture projector, dual purpose.....	192
sailboat has rudder light control.....	29	print toner, keeping out of tray.....	198
turned, of "sandwiched" woods.....	31	reflector, diffuser slips on and off.....	198
Lawn Chairs, colonial type	70	rubber on focusing cloth clings to camera.....	196
Lawn Ornaments, jigsawed.....	65	safelights, colored tumblers used as.....	202
		scale shows how to set camera.....	202

DEPARTMENT
257 STATE ST.
SCHENECTADY

$\frac{P-t}{1.00}$	$\frac{E}{4}$
--------------------	---------------

More HELPFUL BOOKS

THAT MAKE AND SAVE MONEY
IN A HUNDRED DIFFERENT WAYS!

FORTY POWER TOOLS YOU CAN MAKE (New Edition)

If you want an inexpensive motorized workshop that will speed up your work and do it accurately, get this amazing book. Explains how to make forty different machines, such as lathes, drill press, jig saw, band saw, circular saw, sanders, from pipe fittings, old auto parts, wood, etc. (Cloth) \$1.25.

HOW TO READ BLUEPRINTS

This important subject now covered in simple language in a new Popular Mechanics book. Shows how to read the "prints" which all machine shop construction and production follow. Gives signs, symbols, etc. (Cloth) \$1.50.

THE BOY MECHANIC

The book for your boy—for any boy. Tells how to build midget auto, boats, models, games, craftwork. Hundreds of pictures. (Cloth) \$2.00.

WHAT TO MAKE

Shows what to make and how to make hundreds of things in spare time for fun or profit. Furniture, craftwork novelties, jig saw projects, gifts, toys, games, photographic equipment. Set of five books, Volumes 1, 2, 3, 4 and 5 (1000 interesting pages) \$2.50. Single volumes 50c each.

CONCRETE HANDBOOK

Doing your own concrete work and making things of cement is simplified and made downright easy with the Popular Mechanics Handbook. For the home owner, handyman and construction men. (Cloth) \$1.50.

SHOP NOTES

Popular Mechanics annual mechanic's guide. For every man who uses tools. Few of subjects covered are lathe operation, drafting, shop practice, using hand and power tools, welding, autos, electricity, time and money-saving shortcuts. Set of five books (Shop Notes for 1944, 1943, 1942, 1941, 1940) \$2.50. Single volumes 50c.

MONEY MAKING FORMULAS

Over 3,000 up-to-date formulas; supply directory; how to start your own manufacturing business by transforming simple ingredients into wanted products. (Cloth) \$2.00.

BUILD A BOAT FOR PLEASURE OR PROFIT

How to build 17 low-cost boats at home—power, sail or row boat. New book prepared especially for the home builder with limited tools, no experience and little money to spend. (Cloth) \$1.50.

POPULAR MECHANICS PRESS

200 East Ontario Street, Chicago

YOUR CAR

Save up to \$100.00 a year on your car. Make it last longer. Auto-owners guide describes hundreds of simple car repairs, shortcuts, how to operate your car economically. (Cloth) \$1.25.

PHOTO GUIDE

Contains over 200 articles on making at low cost, your own camera and darkroom equipment; getting better photos; tricks, gadgets. (Cloth) \$1.25.

GARDEN BOOK

Build your own trellises, fences, lawn furniture, outdoor fireplaces, attractive ornaments, etc. (Cloth) \$1.00.

WELDING, BRAZING AND SOLDERING

How to construct welding equipment and use it effectively. Small arc welder, spot welder, arc torch. Tricks of soldering, brazing, heat treating iron and steel. (Cloth) \$1.25.

PAINTING, FURNITURE FINISHING AND REPAIRING

A new book for craftsmen, home owners, painters, handymen and manual training classes. Covers all types of repairs and finishing, restoring antiques, spray and brush painting. Rare woods shown in actual colors. (Cloth) \$1.50.

