

SKAT



Swiss Centre for Development Cooperation
in Technology and Management
International Labour Office

ROOF COVER GUIDE

Design and Construction of FCR/MCR Roof Covering:
Principles, Detailing

Paul Gut

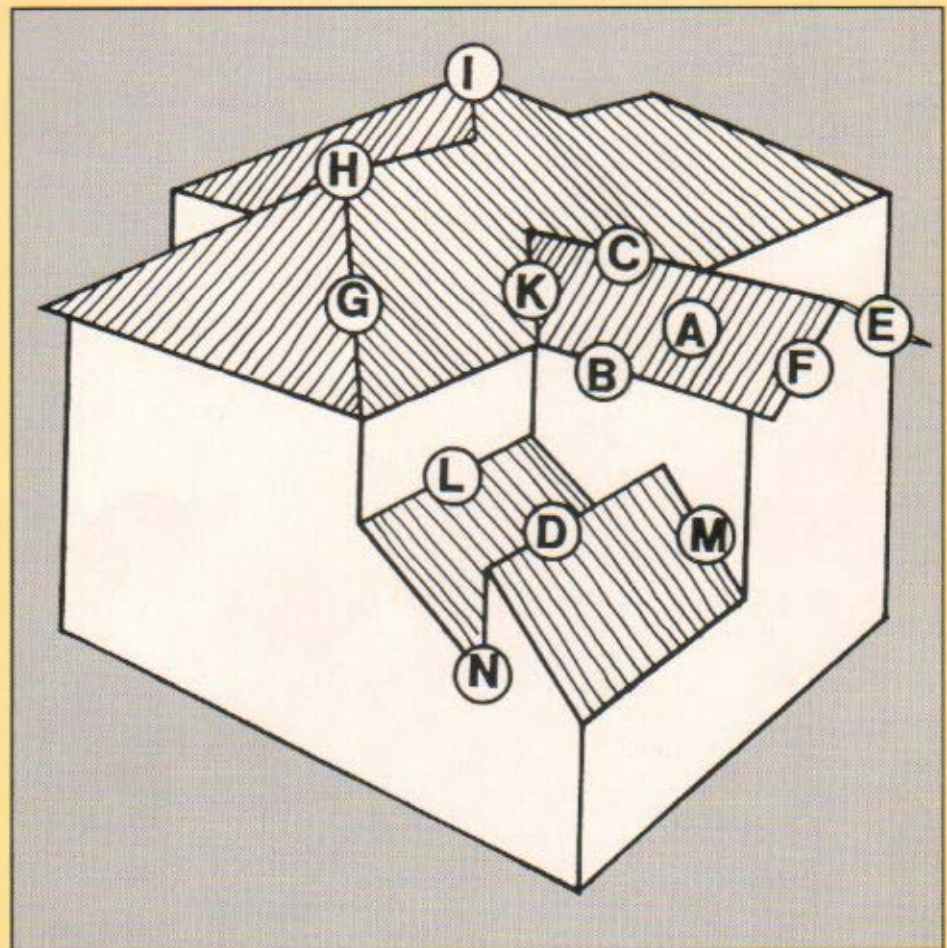

ROOF COVER GUIDE

Guide for the design and construction of FCR/MCR tile roof covering, with detailing.

A co-publication of the Swiss Centre for Development Cooperation in Technology and Management (SKAT) and the International Labour Office (ILO), supported by the Swiss Development Cooperation (SDC)

FCR / MCR TOOLKIT-OVERVIEW

NATIONAL CENTER KIT

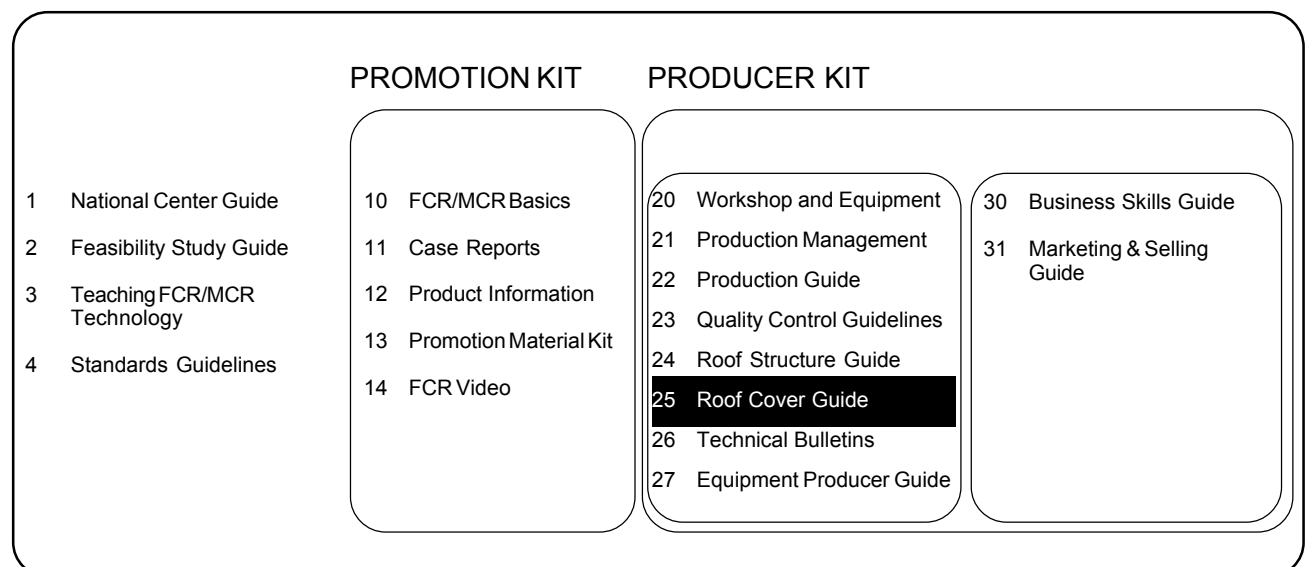

Author: Paul Gut, Intep AG, Zürich, Switzerland

Editing Committee: Karl Wehrle, SKAT, Heini Müller, SKAT, Olivier Scheurer, SKAT, Gilbert Brys, ILO, Roland Stulz, Intep AG

Co-Published by: **SKAT**, Swiss Centre for Development Cooperation
in Technology and Management
in collaboration with
ILO, International Labour Office, INSTEAD

First edition: 1993 by
SKAT, Swiss Centre for Development Cooperation
in Technology and Management and
ILO, International Labour Office, Entrepreneurship and Management
Development Branch

Layout: P. Gut, Intep AG and SKAT

Illustrations: Mathias Staehli, Lachen, Switzerland

Photos: Heini Müller, SKAT, T. Moncrieff, P. Gut

Cover: SKAT

Copyright: by SKAT, St. Gallen, Switzerland, and
ILO, Geneva, Switzerland

Comments: Please send any comments concerning this publication to
SKAT or ILO

Printed by: Niedermann, St. Gallen, Switzerland

ISBN: 3-908001-27-7(SKAT), 92-2-109006-X(ILO)

Distribution by: SKAT-BOOKSHOP
Vadianstrasse 42
CH-9000 St. Gallen, Switzerland
Phone: +41 (0)71 228 54 54, Fax: +41 (0)71 228 54 55

ILO
INSTEAD
Route des Morillions 4
CH-1211 Geneve 22, Switzerland
Phone: +41 (0)22 7996111, Fax: +41 (0)22 7988685

Neither the author nor the publisher can be held responsible for possible damage resulting from the use of the information contained in this publication.

August 1993, 1000 ex

The designations employed in ILO publications, which are in conformity with United Nations practice, and the presentation of material therein do not imply the expression of any opinion whatsoever on the part of the International Labour Office concerning the legal status of any country, area or territory or of its authorities, or concerning the delimitation of its frontiers.

The responsibility for opinions expressed in signed articles, studies and other contributions rests solely with their authors, and publication does not constitute an endorsement by the International Labour Office of the opinions expressed in them.

Reference to names of firms and commercial products and processes does not imply their endorsement by the International Labour Office, and any failure to mention a particular firm, commercial product or process is not a sign of disapproval.

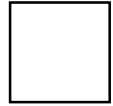

TABLE OF CONTENTS

PREFACE	3
1. INTRODUCTION	7
1.1 FCR/MCR in general	7
1.2 Objectives of this guide	8
1.3 Contents of this guide	9
1.4 General remarks	10
1.5 Definition of main terms	11
1.5.1 Roof types	11
1.5.2 Roof cover related terms	12
2. ROOF COVER TYPES	13
2.1 Single leaf roofing	13
2.2 Double leaf roofing	16
2.3 Horizontal ceiling	17
3. MATERIALS	119
4. NUMBER OF TILES AND LENGTH OF RAFTERS AND BATTENS	21
4.1 Tile requirements	21
4.2 Length of rafters and battens	23
5. FIXING OF TILES	25

6.	ROOF COVER DETAILS		27
6.1	Normal tile	Detail A	29
6.2	Eaves	Detail B	31
6.3	Double-pitched ridge	Detail C	35
6.4	Mono-pitched ridge	Detail D	39
6.5	Left verge (gable end)	Detail E	41
6.6	Right verge (gable end)	Detail F	43
6.7	Hip ridge	Detail G	45
6.8	Hip roof apex	Detail H	47
6.9	Pyramid roof apex	Detail I	48
6.10	Valley	Detail K	51
6.11	Adjoining wall ridge (lean-to roof)	Detail L	53
6.12	Adjoining wall verge	Detail M	55
7.	ROOF CONSTRUCTION PROCESS		57
7.1	Safety		57
7.2	Laying of battens		59
7.3	Laying of tiles		61
8.	MAINTENANCE		63
8.1	Maintenance concept		63
8.2	Maintaining the tiles		65
	APPENDICES		67
1	Conversion factors for roof slopes		69
2	Recommended further reading and references		73



PREFACE

The history of FCR/MCR

The FCR/MCR technology was developed in the 1970s based on many years of experiences made with concrete tiles and asbestos cement sheets. During the 1980s it found applications in many countries all over the world. Today the technology is at a mature stage and experiences have shown that it offers a reliable roofing material which can compete in most cases with conventional roofing materials.

FCR/MCR Toolkit Series

This guide is part of the FCR/MCR Toolkit series. This series impart the entire know-how that is required in the field of FCR/MCR technology, covering technical as well as economic, organisational, management and marketing aspects. The FCR/MCR Toolkits Overview shows the structure of its contents.

Roles of BASIN, SKAT/RAS and ILO

SKAT and ILO are co-publishers of the FCR/MCR Toolkit Series which this guide is one element.

BASIN

SKAT is a member of BASIN (Building Advisory Service and Information Network), a coordinated network of experienced international professionals, which was established to provide qualified advice and information in the field of building materials and construction technologies.

The activities of BASIN are divided amongst four leading European, non-profit organisations in the field of appropriate technology viz. GTZ/GATE Germany, ITDG Britain, SKAT Switzerland, CRATerre France. Each of these organisations covers a separate specialised subject area, thus providing more qualified expertise with greater efficiency.

SKAT

SKAT is an information and documentation centre and a consultancy group engaged in promoting and implementing appropriate technology in partner countries worldwide.

RAS As a member of BASIN, SKAT specialises in roofing technology, particularly FCR/MCR technology. Within BASIN, SKAT established the Roofing Advisory Service (RAS). To facilitate the promotion and dissemination of roofing technologies, SKAT/RAS produce the “FCR/MCR Toolkit” series of which this “Roof Cover Guide” is one element.

Network of specialists A worldwide network of specialists and specialised institutions provides technical support to new and existing producers of FCR/MCR. This helps to ensure the reliability and quality of the products in this growing market.

This FCR/MCR network is coordinated by SKAT/RAS.

ILO A programme for the development, promotion and application of appropriate building technologies suitable for low-cost construction is currently being implemented by the Micro-enterprise and Informal Sector Section of the Entrepreneurship and Management Development Branch of ILO.

The objectives of this programme are to minimise construction costs, maximise the use of locally-available raw materials and generate productive employment. The program also aims at developing small and micro-enterprises in this sector and at demonstrating their commercial viability. It makes use of an innovative approach whereby some of the activities are carried out in ongoing technical cooperation projects for the development of small and micro-enterprises. These projects are executed by ILO or other agencies such as UNDP, as multilateral or bilateral projects. Various approaches are used by this programme: research and development, dissemination of technological information, advisory services to governments and implementation of technical assistance projects.



Contact address

This literature, as well as further information, is available from:

Roofing Advisory Service, c/o SKAT/RAS
Vadianstrasse 42
CH-9000 St. Gallen
Switzerland Tel +41 (0)71 / 23 74 75
 Fax +41 (0)71 / 23 75 45

and

ILO
INSTEAD
Route des Morillons 4
CH-1211 Geneve
Switzerland Tel +41 (0)22 / 799 61 11
 Fax +41 (0)22 / 798 86 85

Acknowledgements

We would like to thank all the experts, technicians and producers who helped us with their valuable comments and remarks based on their wide experience.

Comments

Comments and feedback information are welcome and will help to further improve this guide. They may be sent to SKAT/RAS or ILO.

1. INTRODUCTION

1.1 FCR / MCR in general

What are FCR and MCR ?

FCR (Fibre Concrete Roofing) consists of concrete tiles made of cement mortar mixed with a small amount of natural or synthetic fibre.

In the case of MCR (Micro Concrete Roofing), fine aggregate is used instead of fibre.

For further basic information please refer to “The Basics of Concrete Roofing Elements”.

The advantages of FCR and MCR

The technology provides an inexpensive and reliable roof cover and especially suits the needs of developing countries. The main advantages are :

- The raw materials are available locally and thus foreign exchange is saved.
- The appropriate technology that is involved enables decentralised and small-scale production.
- The technology involves little investment.
- The production is labour intensive rather than capital-intensive, it thus creates jobs.
- Compared to metal sheeting, rooms covered with FCR/MCR are more comfortable during solar radiation because of better thermal insulation and ventilation.
- During rain, compared to metal sheeting, FCR/MCR-covered roofs are less noisy than those covered with metal sheeting.
- The product is environmentally appropriate.
- The technology is easy to learn.

The drawbacks of FCR/MCR

The durability of FCR/MCR is basically the same as ordinary concrete tiles, which have shown service life spans exceeding 50 years. Sometimes, however, lower strength of the material compared to modern concrete tiles and AC-sheets was achieved. This can be accounted for by small production units involving a higher risk of quality variations and by a lack of standards.

1.2 Objectives of this guide

The roof constitutes the most important part of a building and special care has to be taken in preparing it and its elements. The best available raw materials should be used and throughout the production process it should be kept in mind that a sub-standard and ill-designed roof may not only result in a defective roof, but may also lead to severe damage of the whole building.

In order to construct a reliable roof, not only the cover material - in this case the tiles - must be of a high quality, but the entire roof structure and cover must function as a coherent system which is adapted to local conditions such as climate, available skill and materials.

This guide, therefore, aims at helping to do proper detailing, and to build and maintain the roof cover in a sound manner. For the design and construction of the suitable roof shape and the adequate structure the Toolkit Element 24: "Roof Structure Guide" [6] should be consulted.

Target group

The guide is addressed to architects and engineers involved in the design of buildings with FCR/MCR roofs, and also to builders, site engineers and overseers, which are implementing construction.

Producers of roof cover materials can also use the guide as a basis for advising their customers on the successful use of their product.

This guide can also be useful as a teaching aid during training.

The guide is not intended for newcomers who are interested in the FCR/MCR technology in general. For basic information we suggest that the following booklet be consulted: "The Basics of Concrete Roofing Elements" (available from SKAT free of charge in English, French and Spanish).

1.3 Contents of this guide

What you will find in this guide:

The guide provides the necessary information on the design and construction of FCR/MCR cover. Emphasis is given to simple and basic roof forms. Free and complicated forms in roof design are not dealt with in detail as they require higher expertise, skill and practical experience.

- Different FCR/MCR cover systems are described and particulars given about the dimensions of the most common tiles. A method for calculating the number of tiles required is explained.
- Proven and well-established methods of detailing for the different situations on roofs are provided.
- Methods and practical hints for the construction process as well as maintenance are provided.
- The appendix contains conversion factors for roof slope measures and a list of selected literature.

What you will NOT find in this guide

The guide is not a scientifically-comprehensive textbook, but is rather designed for practical application.

It also does not contain:

- Information on production management
- Specifications with regard to costs and profit
- Information about particular problems in specific countries
- Guidelines for the production of tiles
- Guidelines for quality control of tiles and the required tests
- Design and construction of the roof structure

For information on these subjects consult the respective Toolkit-elements (see overview on the front cover).

1.4 General remarks

Validity of data

The material presented in this guide is based on general know-how and universal practice. It is up to the readers in each particular country to develop and apply corresponding solutions which are adapted to local practice and circumstances .

Responsibilities of the producer of roof-cover material

The reliability and functional value of the entire roof as a system as well as of its individual components such as the cover or structure, are of relevance for the house owner. The producer of cover materials should, therefore, not only be concerned about the high quality of his product, but also about the quality of the roof as a whole. If he constructs entire roofs as well as sells tiles, his responsibility is clearly defined. In the case where the roof is constructed by someone else, however, the producer should also take an interest in its design and construction. Although he can, naturally, not be held responsible for the structure and the laying of the cover, he should participate by advising and providing all necessary information.

Only if the roofs are properly functioning and long-lasting, will his products earn a good reputation and become a sustainable success.

1.5 Definition of main terms

1.5.1 Roof types

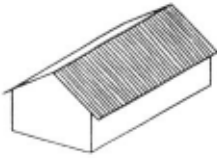

Gable roof, saddle roof or double-pitched roof

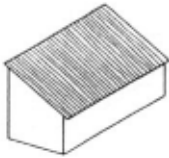

Single pitch roof or mono-pitched roof

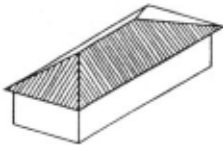

Hipped roof



Pyramid roof

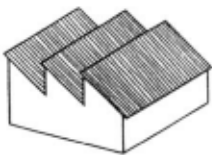

Shed roof

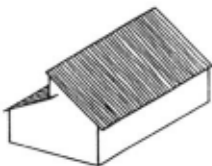

Broken pitched roof

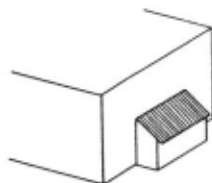

Lean-to roof

1.5.2 Roof cover related terms

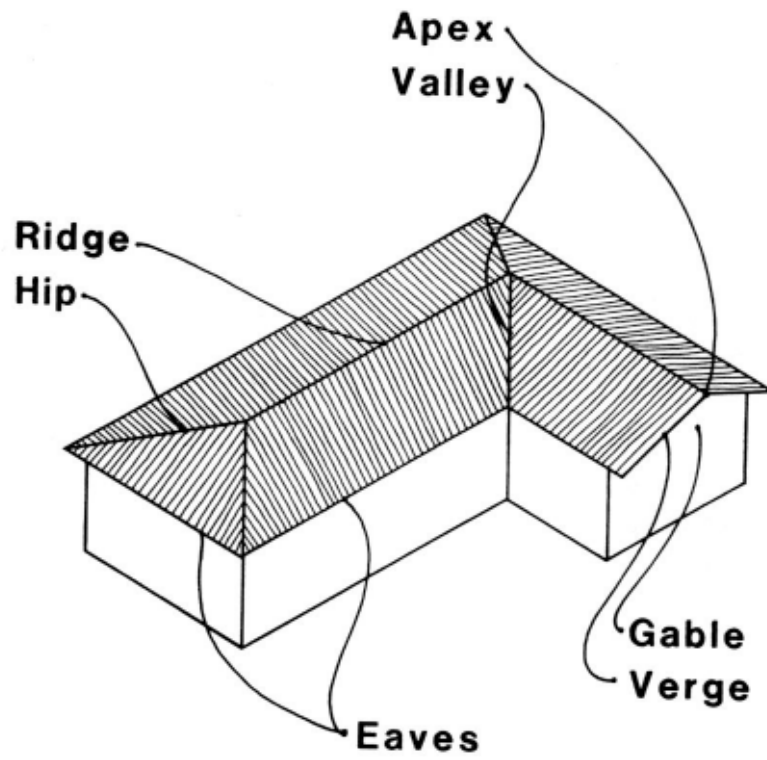

2. ROOF COVER TYPES

2.1 Single leaf roofing

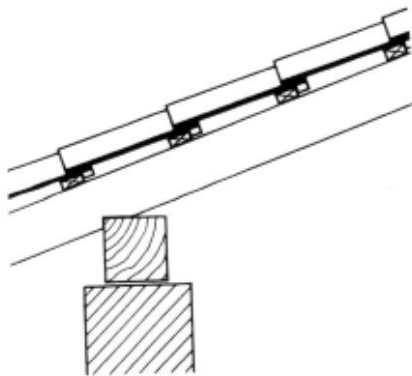

The simplest and cheapest method of roofing with FCR/MCR is the single leaf cladding.

Advantages

- Inexpensive
- Simple construction
- Maintenance is easy from the inside
- Control of leakage is easy

Disadvantages

- Relatively poor thermal insulation
- Hot in summer, cold in winter, though better than aged corrugated iron sheeting
- Not air and insect proof

Suitability

- For low cost buildings

2.2 Double leaf roofing

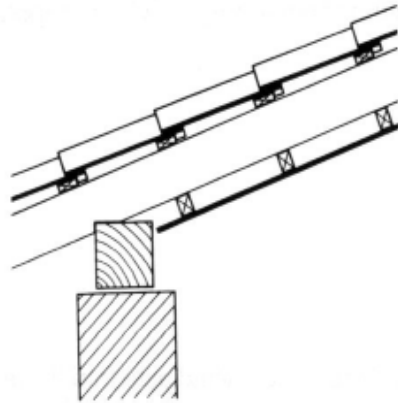

A more sophisticated method of roofing is the use of an inner leaf along the roof slope. This can be fixed from the inside onto the rafters and forms a sloped ceiling. The space between the tiles and the ceiling is ventilated by special openings or simply by the gaps between the tiles.

Advantages

- Improved thermal performance
- Dust, insect and (more or less) wind proof
- Proper surface from the inside

Disadvantages

- Higher costs
- Leakage cannot be easily detected from the inside
- Changing tiles from the inside is difficult
- Uncontrollable space between tiles and ceiling (rats etc.)

Suitability

- Middle-class housing

Types of double leaf roofing

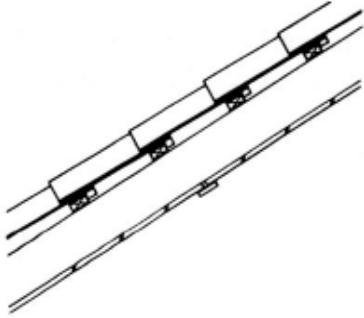

- Ceiling under rafters

Plywood or another material can be nailed onto the rafters from the inside. Bamboo matting a possibility which is cheaper, but less effective.

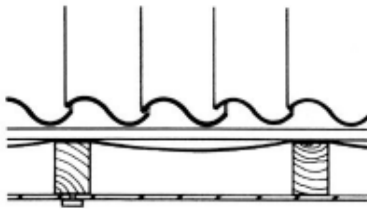

- Additional under-roof

For improved safety against leakage and wind penetration, an additional foil (strong plastic or similar) can be placed over the rafters before the battens and tiles are fixed. In this case the tiles can only be fixed and maintained from the outside.

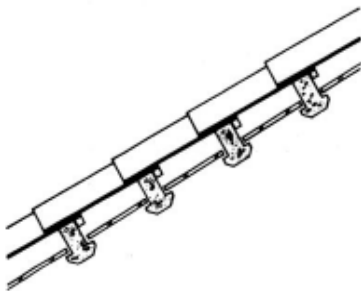

- Ceiling in between purlins

This system uses purlins that are laid at a distance of 40 cm, thus providing direct support to the tiles without rafters and battens. The purlins are made of precast concrete and have a T-shape, providing support to ceiling sheets (plywood, flat MCR sheets or other material). These sheets can be installed without fixing and easily removed to provide access to the tiles. This enables changing tiles from the inside.

This system is still in the research and development stage.

2.3 Horizontal ceiling

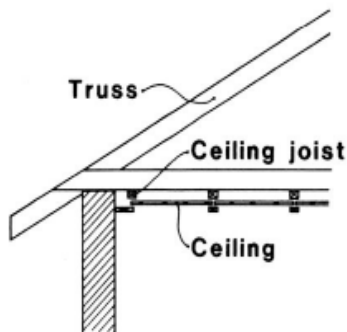
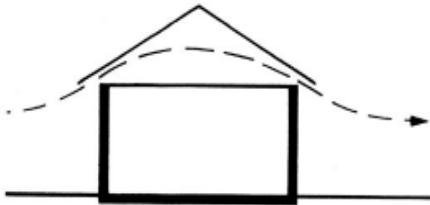

Rooms can be closed off from the roof with a horizontal ceiling. This requires ceiling joists that are either fixed onto trusses, spanned from wall to wall, or suspended from the rafters.

Plywood or other sheeting are possible materials.

The space between the roof and the ceiling should be accessible for maintenance purposes. Therefore the ceiling joists should be fixed so that they are strong enough to support a person.

Advantages

- Highly-improved thermal performance
- Dust, insect and wind-proof
- Proper surface from the inside

Disadvantages

- Higher costs
- Leakage cannot be easily detected
- Reduced air volume in the room (in cold climates this can be an advantage)
- Uncontrollable space between tiles and ceiling (rats etc.)

Suitability

- Middle class housing

Cross ventilation of the roof space is important to keep the rooms cool. The openings should be protected with a wire mesh against rats and birds.

3 MATERIALS

FCR and MCR elements are available in two sizes: semi-sheets and tiles.

Product size (Dimension)	Thickness	Effective cover per m ² (sloping)	No. of tiles / sheets per m ² (sloping)	Weight per m ² (sloping)
Tiles 500 x 250 mm	6 mm 8 mm	0.076 m ²	13	20 kg 26 kg
Semi sheets 600 x 600 mm	8 mm	0.25 m ²	4	26 kg

Other shapes and sizes may become available in the near future

Semi sheets

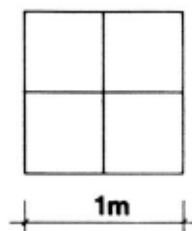

Semi-sheets are designed for a higher efficiency in production. The cement requirement per m² is 40% higher than for tiles. Their dimensions are 60 x 60 cm, 4 pieces per m² roof are required. Semi-sheets require careful handling and a very even and firm roof structure.

Compared to tiles, the laying of semi-sheets is more efficient.

Tiles

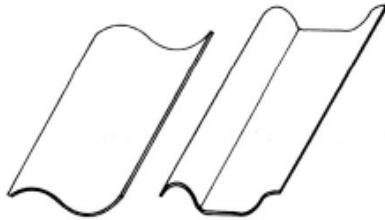

Pantile

Roman tile

Tiles produced so far have a size of 25 x 50 cm. They are more responsive to slight movements within the roof structure such as bending or distortion due to wind or earthquake. Handling tiles is easy since they weigh only 2 kg per piece.

Two different shapes are common: the Roman tile and the pantile.

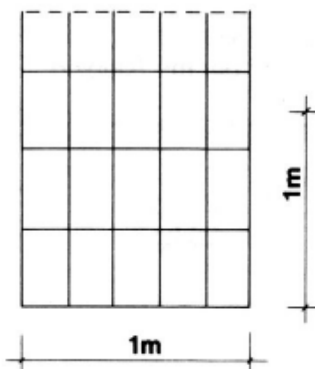

Roman tiles have a flat area on which they rest. They fit well, but require a rather even roof structure.

Pantiles have a sinus-like shape and can also fit on slightly uneven roof structures, such as pole timber or bamboo structures.

Per m² roof 13 pieces are required

4. NUMBER OF TILES AND LENGTH OF RAFTERS AND BATTENS

When designing an FCR/MCR roof and working out the dimensions including roof overhangs, the area covered by each tile has to be taken into consideration.

The typical overall dimension of the tiles are 500 x 250 mm and the area covered is 400 x 190 mm.

4.1 Tile requirements

Rough estimation

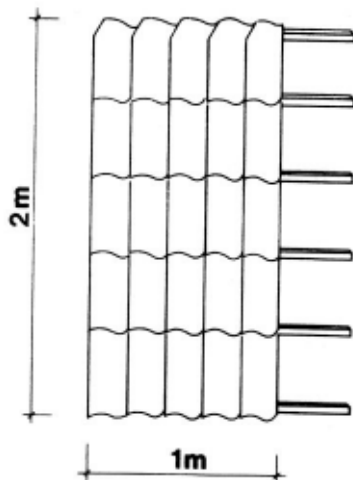

For a rough estimation of the number of tiles required the following rule can be used:

5 tiles cover 1 m roof along its length

5 tiles cover 2 m roof along its width at a slope

Thus for 1 m² of roof, 13 tiles are required.

To convert the horizontal dimensions into the width along the slope by different pitch, see the conversion tables in [Appendix 1](#).

Tile requirements for a double pitched roof with a 30° pitch

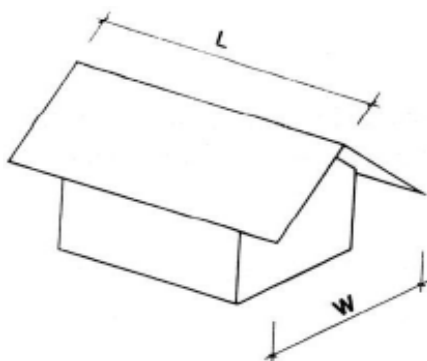

Remarks

For roof slopes with less than 30° pitch the difference in the tile requirements is negligible and can be disregarded.

When ordering tiles, add 10% for wastage, inaccuracy etc.

Number of tiles per row												
			5	10	15	20	25	30	35	40	45	50
			Length of roof including overhang (L in m)									
			1.00	1.95	2.90	3.85	4.80	5.75	6.70	7.65	8.60	9.55
6	Width	2.20	30	60	90	120	150	180	210	240	270	300
8	of roof	2.90	40	80	120	160	200	240	280	320	360	400
10	incl.	3.60	50	100	150	200	250	300	350	400	450	500
12	overhang	4.30	60	120	180	240	300	360	420	480	540	600
14	(W in m)	5.00	70	140	210	280	350	420	490	560	630	700
16		5.70	80	160	240	320	400	480	560	640	720	800
18		6.40	90	180	270	360	450	540	630	720	810	900
20		7.10	100	200	300	400	500	600	700	800	900	1000
22		7.80	110	220	330	440	550	660	770	880	990	1100
24		8.50	120	240	360	480	600	720	840	960	1080	1200
26		9.20	130	260	390	520	650	780	910	1040	1170	1300
28		9.90	140	280	420	560	700	840	980	1120	1260	1400

Number of tiles for double pitched roofs

Example

In the case of a roof which is 4.8m long (L), and with a horizontal distance (W) of 6.4m between eaves, the total number of tiles required is 450.

4.2 Length of rafters and battens

Exact calculation

To calculate the length of rafters and battens exactly, the accurate coverage area and detailing of the edges of the roof (verge, ridge, eaves) have to be taken into consideration.

Rafter length

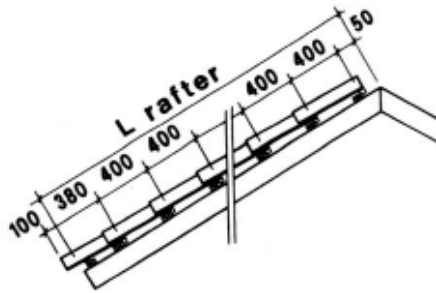

The coverage of one tile along its length is 400 mm and the overhang at the eaves is 100 mm (a minimum of 50 mm is required here). The exact length of the rafters can be calculated using the following formula:

$$\text{No. of tiles} \times 400 \text{ mm} - 50 \text{ mm} = \text{L rafter}$$

This formula gives the following values

Number of tiles	Rafter length mm	Number of tiles	Rafter length mm	Number of tiles	Rafter length mm
1	350	11	4350	21	8350
2	750	12	4750	22	8750
3	1150	13	5150	23	9150
4	1550	14	5550	24	9550
5	1950	15	5950	25	9950
6	2350	16	6350	26	10350
7	2750	17	6750	27	10750
8	3150	18	7150	28	11150
9	3550	19	7550	29	11550
10	3950	20	7950	30	11950

It is possible to vary the length of the rafters by adjusting the overlapping area of the tiles (minimum 100 mm). For an optimum use of tiles, however, it is advisable to take the tile size into consideration already in the planning stage. This is important especially in bigger projects, where there are large numbers of identical buildings or in large housing schemes etc.

Batten length The coverage of one tile along its width is 190 mm. The exact length of the battens can be calculated using the following formula:

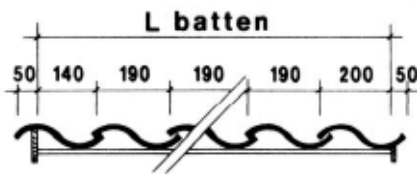

$$(\text{No. of tiles} \times 190 \text{ mm}) - 40 \text{ mm} = \text{L batten}$$

This formula gives the following values

Number of tiles	Batten length mm	Number of tiles	Batten length mm	Number of tiles	Batten length mm	Number of tiles	Batten length mm	Number of tiles	Batten length mm
1	150	11	2050	21	3950	31	5850	41	7750
2	340	12	2240	22	4140	32	6040	42	7940
3	530	13	2430	23	4330	33	6230	43	8130
4	720	14	2620	24	4520	34	7420	44	8320
5	910	15	2810	25	4710	35	6610	45	8510
6	1110	16	3000	26	4900	36	6800	46	8700
7	1290	17	3190	27	5090	37	6990	47	8890
8	1480	18	3380	28	5280	38	7180	48	9080
9	1670	19	3570	29	5470	39	7370	49	9270
10	1860	20	3760	30	5660	40	7560	50	9460

In practice, battens are kept somewhat longer on the right verge and cut to the correct length only after the last row of tiles have been placed. (also see Chapter 7)

In contrast to the rafter length, the correct batten length has to be ensured. Less flexibility is allowed here, because the spacing of 190 mm must be observed when laying the tiles properly.

5. FIXING OF TILES

Wind creates a suction force on tiles with the tendency to dislocate them or even to blow them off.

(Also see [6], Toolkit Element 24: Roof Structure Guide)

Especially exposed to wind suction are all roof edges, ridges, eaves and verges. Open roofs, large overhangs, veranda covers, open shed roofs etc. are also exposed.

In these exposed areas (B), very careful fixing is required, for example with additional hooks or double nib fixing.

In less exposed areas (A) fixing with a single nib with one wire loop is sufficient. In less important buildings in areas which are not storm-prone, wire loop fixing may be omitted. This, however, applies only in the case where there is no ceiling and readjusting of displaced tiles is therefore easily possible from underneath. In this case, however, the tiles have to be laid with great care and the under-structure has to be even, so that the surface is smooth and the wind cannot easily find a grip.

Methods of fixing see [Chapter 6.1](#), [6.5](#), [6.6](#).

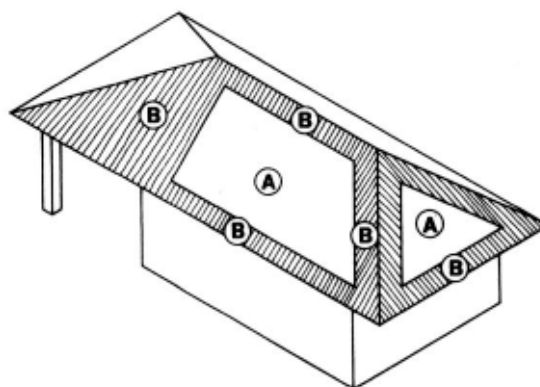

6 ROOF COVER DETAILS

Overview This chapter provides common detailing for roofs of different forms and shapes. The details are based on Roman and pantiles.

The illustration below serves as an index for the details explained in this chapter.

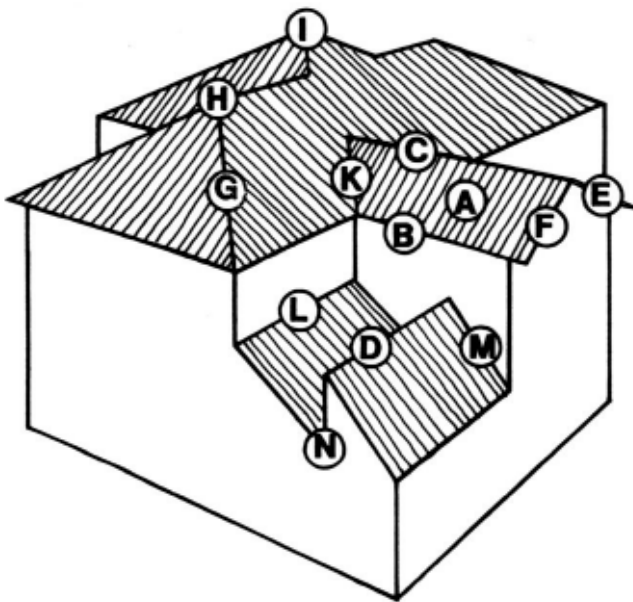

Detail A	Normal tile
Detail B	Eaves
Detail C	Double-pitched ridge
Detail D	Mono-pitched ridge (lean-to ridge)
Detail E	Left verge
Detail F	Right verge
Detail G	Hipped ridge
Detail H	Hipped roof apex
Detail I	Pyramid roof apex
Detail K	Valley
Detail L	Adjoining wall ridge (lean-to roof)
Detail M	Adjoining wall verge

6.1 Normal tile

Detail A

The mitre

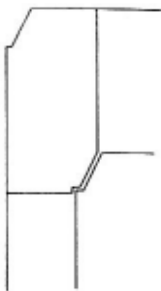

The laying pattern of tiles requires a mitre on two corners of the tile. Two types of mitres can be used.

a) Straight corner cut

This is the most common form used. It has the disadvantage that an inaccurate laying of the tiles is possible.

b) Mitre with a notch

A modified mitre with a notch enforces an exact laying of the tiles. A proper roof surface can more easily be achieved.

Fixing methods

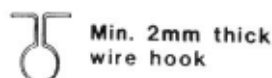
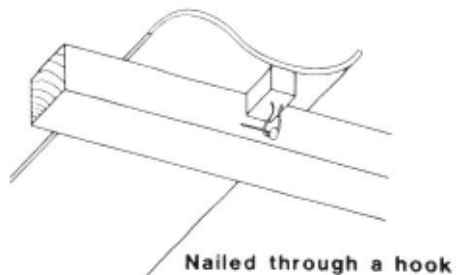
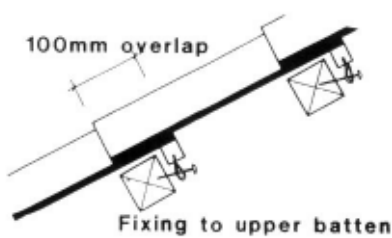

Tiles overlap each other in the direction of the roof slope by 100 mm and rest on the batten by means of a nib. The nib is normally situated at the upper end of the tile and has an inserted wire loop at least 2 mm thick. The tile is fixed with a nail through this loop.

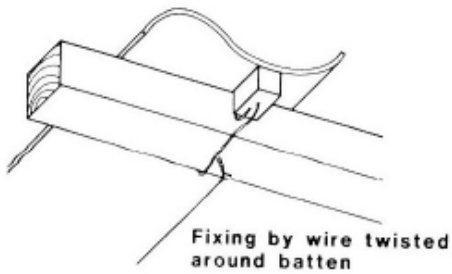

Fixing with a nail through the nib or tile is not recommended because it involves the risk of damaging the tile.

Fixing with a thin wire twisted around the batten is also not recommended because of rusting of the wire.

Not recommended: fixing with twisted wire

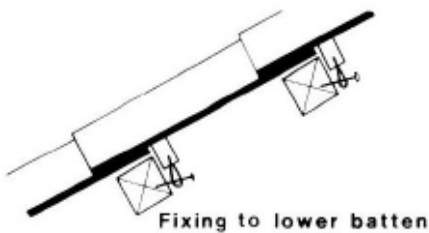

In areas with heavy storms, the nib can be placed at the lower end of the tile. This provides double fixing and dislocation by wind is impossible. In this case the spacing of the battens must be very accurate.

Nib at lower end of tile for areas with heavy winds

In areas where there is no risk of storms, normal tiles do not have to be fixed. Only the tiles at the edges of the roof must be fixed. In this case, however, the tiles have to be laid with great care and the under-structure has to be even so that the surface is smooth and the wind cannot find a grip.

(see Chapter 5 and FCR - News No 5)

6.2 Eaves

Detail B



At the eaves tiles without a mitre at the lower end can be used. Where such tiles are available, more proper eaves can be achieved. It is also possible to use normal tiles which are less ideal, but it means that production and construction are easier.

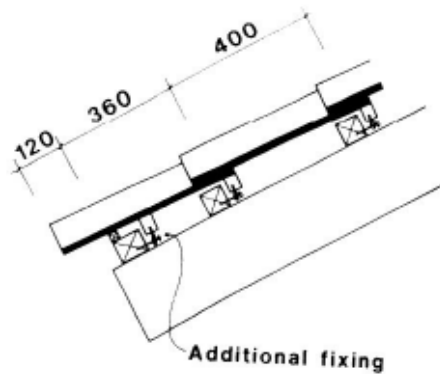

The eaves' batten is fixed at of only 300 mm instead of 400 mm from the next batten providing a sufficient overhang of the tile and thus protecting the timber structure. A strip of wood (beading) of the thickness of a tile (normally 6 mm) is added to this batten to provide a regular slope to the last tile.

The tiles at the eaves should be additionally secured by means of a nib at the bottom against wind uplift.

Fascia board

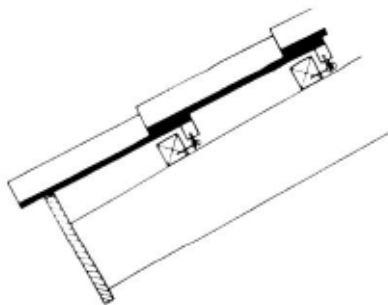

For aesthetic reasons a fascia board may be used. If the timber used in the roof structure is soft, fasciae also have the advantage that they protect the exposed end-grained wood of the rafters from insect attack.

If a fascia board is used, the last batten is not essential as the fascia board provides direct support to the last tile.

The fascia board can be placed either in a vertical position or at right angles to the rafters.

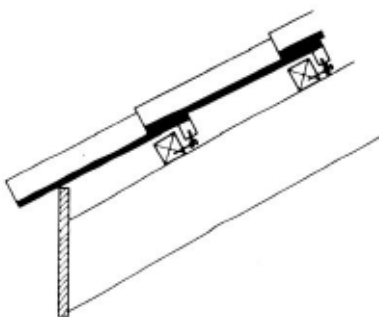

Gutter

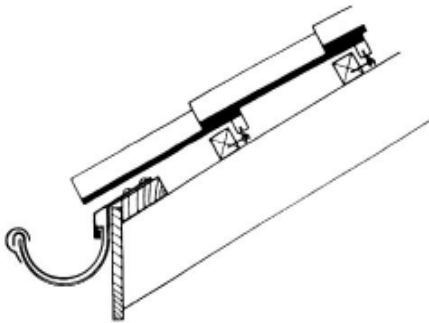

Round gutter with fascia board

In areas with heavy rainfall a gutter has many advantages. It protects the basement and the lower parts of the walls from splashing water and moisture. It also makes the access to the building more comfortable, doors and windows are protected. Furthermore, it provides the possibility of collecting rain water and storing it in a tank for later use.

The gutter can be made of galvanised steel sheet, 0.6 mm thick. Aluminium or copper is more durable but also more expensive.

The gutter should be laid at a slope of 1 - 2%.

Gutter size

The width of the gutter depends on the roof area feeding the water to it.

For a roof area less than 50 m² the gutter width (ø) should be 180 mm. For a roof area more than 50 m² the gutter width (ø) should be 220 mm.

Gutter types

The gutter can be rounded or rectangular in shape.

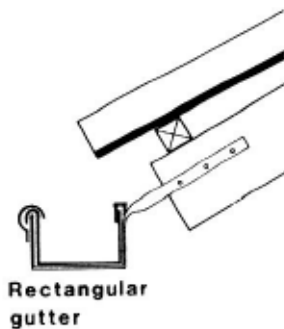
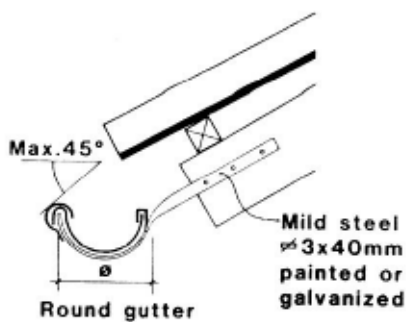

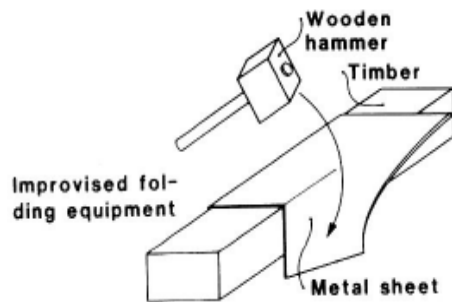

A rectangular gutter can be produced with simple, improvised equipment, usually resulting in a somewhat inaccurate workmanship.

The manufacture of a rounded gutter requires special skill and equipment. It has the advantage of staying cleaner and looking neater.

Maintenance

Gutters require a certain degree of maintenance. Leaves and dirt has frequently have to be removed and gutters made of galvanised iron have to be painted occasionally.

Drainage of gutters

Gutters are drained by a discharge or by drainage pipes (downpipes). The water is drained into the drainage system the plinth drain.

In areas where water is in short supply, the water from the gutters can be collected and stored in a tank.

If the rain water is discharged into a yard or a field which can absorb it, this has the advantage that the rain water is fed into the ground water and the risk of flooding the drainage system is lowered.

6.3 Double-pitched ridge

Detail C

Tiletypes

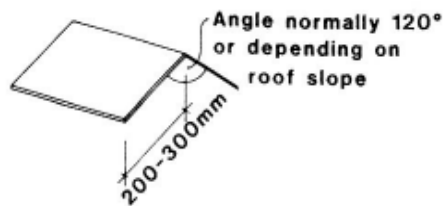

The construction of the ridge requires the use of two special tiles, the ridge cap and the ridge tile.

The ridge cap is a simple V-shaped piece with an angle normally of 120° (depending on the roof slope). More sophisticated types, for example, tiles which are shaped according to the corrugation of the tiles (like some AC-elements) are too difficult to manufacture.

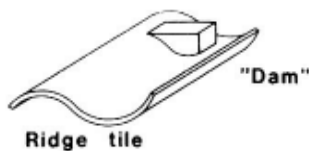

The ridge tile can be an ordinary tile or a more sophisticated tile with an additional "dam", which prevents driving rain water from entering the ridge. An upper mitre is not required.

Laying of ridge cap

The ridge caps can be laid according to different patterns:

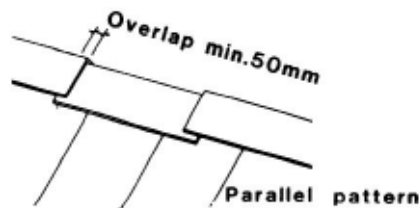

a) Parallel, using a type of long caps.

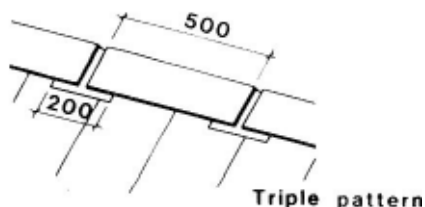

b) Triple pattern, using short "blind" caps and long covering caps.

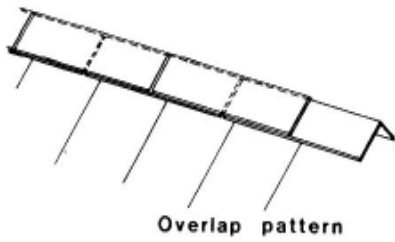

c) Overlap pattern, using a type of long caps.

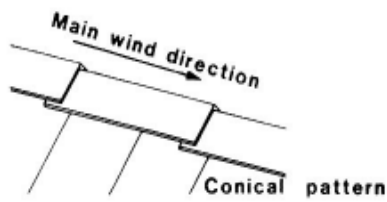

d) Conical pattern, using conical caps staggered in one direction.

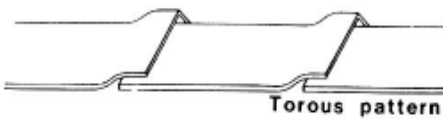

e) Nepal pattern, using ridge caps with a torus.

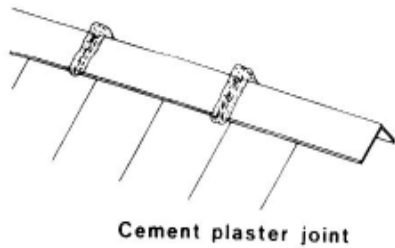

f) Direct pattern, where the ridge caps are joined by means of cement mortar grout.

Fixing the ridge cap

The ridge cap is fixed to the roof structure with wire loops tied to the purlins, similarly to the fixing of the tiles to the battens. In the long run, rusting of this wire loop may create problems.

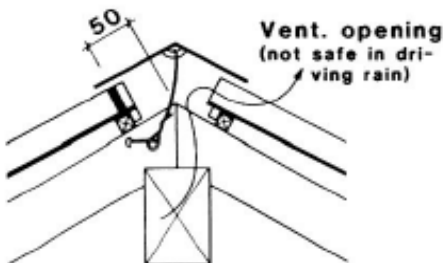

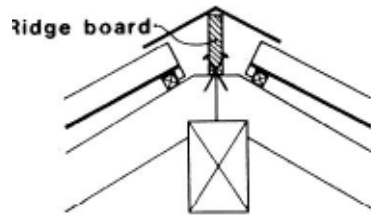

Fixing on ridgeboard by hooks

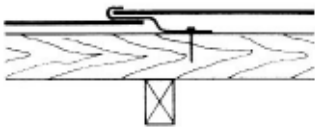

Fixing in cement mortar

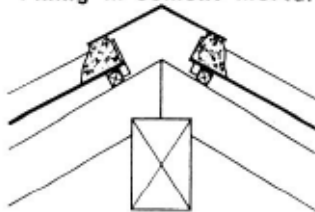

The use of a ridge board facilitates an exact positioning of the ridge cap. In this case the ridge caps are fixed with GI hooks or straps. This solution is more durable than fixing with a wire loop.

Fixing the ridge caps in cement mortar is also a common practice, but is not recommended because the mortar tends to crumble with time.

Ventilation of ridge

The FCR/MCR roof is not airtight and usually allows sufficient ventilation in the roof space. In extreme hot or humid climatic conditions additional ventilation in the ridge area may be required for reasons of comfort reasons. This can be achieved by

- a) omitting the dam, with the risk of driving rain entering the ridge;
- b) raising the last row of tiles or using two rows of ridge tiles.

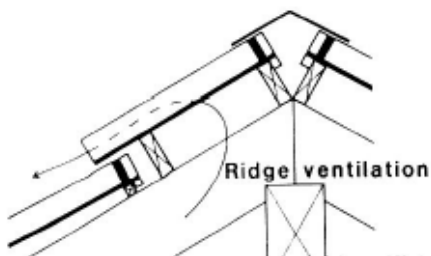

6.4 Mono-pitched ridge

Detail D

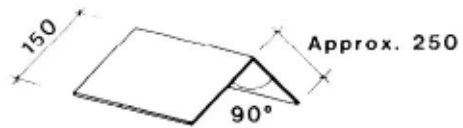

The construction of a mono-pitched ridge requires a similar ridge cap as the ridge of a double-pitched roof. The angle, however, is 90°. The two sides may be unequal in size.

The ridge cap can be fixed in a similar way as in the case of the double-pitched roof, namely,

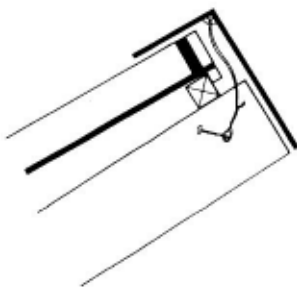

a) with wire loops tied to the purlins with a certain risk of rusting, or

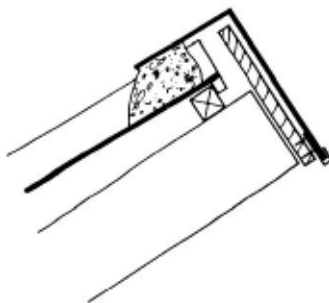

b) by fixing the ridge cap in mortar on one side and attaching it with a hook on the other side.

6.5 Left verge (gable end)

Detail E



At the left verge tiles without a mitre at the upper end can be used. Where such tiles are available, a more proper verge can be achieved. It is also possible to use normal tiles which are less ideal, but it means that production and construction are easier.

A verge board is used to support the outer row of tiles. This board is fixed prior to laying the first row of tiles, which is begun on the left. The board should be of good quality timber or be properly treated or painted, because it tends to get wet.

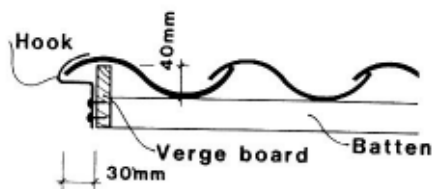

Because of wind exposure the tiles of the outer row require fixing by means of two nibs or an additional hook.

Additional nailing in the overlapping area is not recommended because of the danger of damaging the tiles.

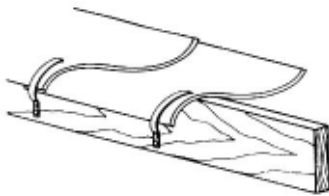

6.6 Right verge (gable end)

Detail F



At the right verge tiles without a mitre at the lower end can be used. The same tile type as for the eaves can be used. Where such tiles are available, a more proper verge can be achieved. It is also possible to use normal tiles which are less ideal, but it means that production and construction are easier.

The battens are cut to the required length only just before the last row of tiles is laid.

Because of wind exposure, the tiles of the outer row require fixing by means of two nibs or an additional hook.

Additional nailing in the overlapping area is not recommended because of the danger of damaging the tiles.

Due to the shape of the tile the right verge differs from the left verge. There are various possibilities:

Alternative 1

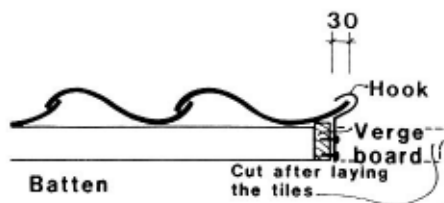

A standard tile is used. In this case a similar verge board as on the left side is required.

This is the easiest solution, but has the disadvantage that the verge board is not fully protected from rain. The board has to be of good quality timber and/or must be well treated.

Alternative 2



An alternative is to use a special tile consisting of the top portion of a normal tile only. This solution provides a right verge which looks similar to the left verge. A special mould for this tile is not required, but fixing it requires special care.

Alternative 3

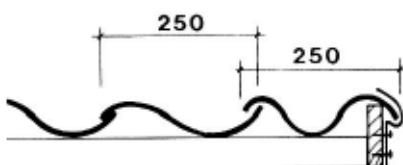

It is also possible to use a special tile with two “waves”. The width must be the same as in the case of normal tiles, so that no special vibrating table is required. This is aesthetically and technically the best solution, but a special mould is required.

6.7 Hip ridge

Detail G

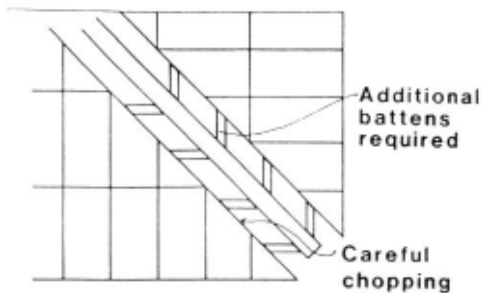

At the hip ridge the tiles are carefully chopped to exactly the required shape. If the nib is chipped off, the tile has to be carefully fixed with a nail.

The open gap is covered with ridge caps, laid in an overlapping pattern.

For more accurate fitting a special hip ridge cap can be used with an angle which is flatter than that of an ordinary ridge cap.

Fixing of the hipped ridge cap

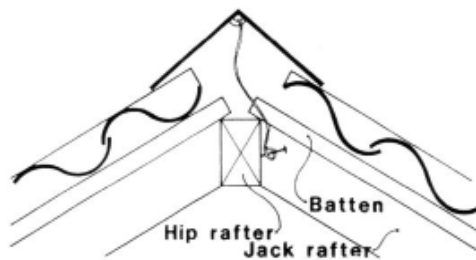

The hip ridge cap is fixed to the roof structure with wire loops tied to the purlins, in a way similar to the fixing of the tiles to the battens. In the long run, this wire loop may rust and the cap slide down, causing problems.

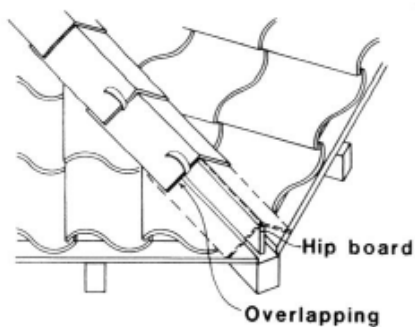

The use of a hip ridge board facilitates the exact positioning of the hip ridge cap. In this case the caps are fixed with GI hooks or straps. This is more durable than fixing the cap with a wire loop.

Laying the hip ridge caps in cement mortar is also a common practice, but is not recommended because the mortar tends to crumble with time.

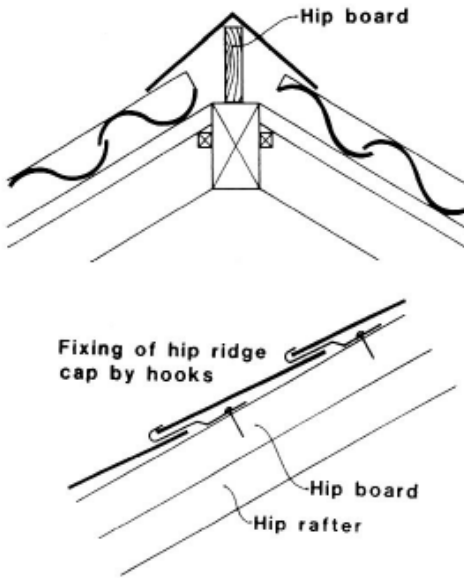

6.8 Hip roof apex

Detail H

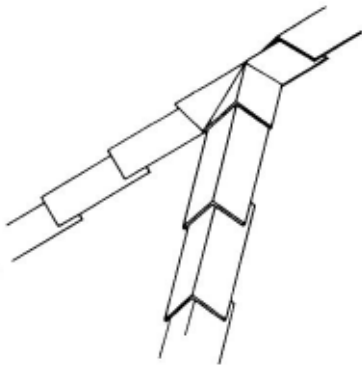

The proper construction of the hip roof apex is a demanding job. Various alternatives are possible:

- a) The apex is covered with a lead cap.
- b) The apex is covered with cement mortar.
- c) A perfect solution would be the use of a special cap. It can be made with a modified ridge cap mould.

These solutions are also valid for other similar positions such as ridge corners, etc.



6.9 Pyramid roof apex

Detail I

The proper construction of the pyramid roof apex is a demanding job. Various alternatives are possible:

- a) The apex is covered with a lead cap.
- b) The apex is covered with cement mortar.
- c) A perfect solution would be the use of a special cap. It can be made with a modified ridge cap mould.

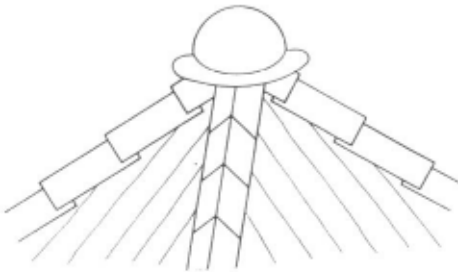

These solutions are also valid for other similar positions such as ridge corners, etc.

Local traditional features such as the use of a clay pot or decorative elements are also possible.

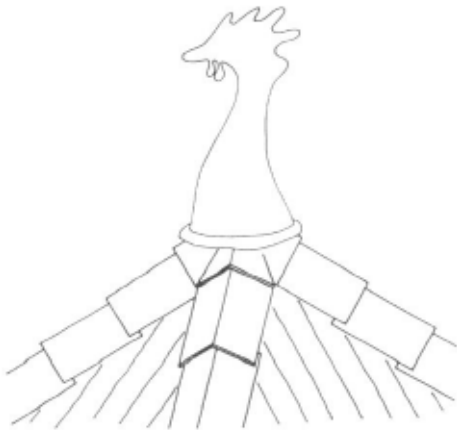

6.10 Valley

Detail K

The valley is the most exposed position on the roof where leakage would have a disastrous effect. Therefore its construction requires great care. A metal gutter should be used. This can be either a simple flushing or a U-shape gutter. The tiles in the valley have to be carefully chopped.

Between the metal and the tiles a layer of roofing felt should be used to avoid corrosion.

a) Flushing

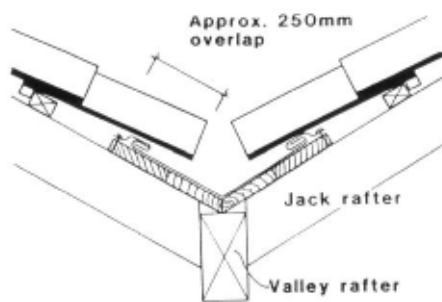

To support the flushing, planks are placed in the valley on top of the rafters.

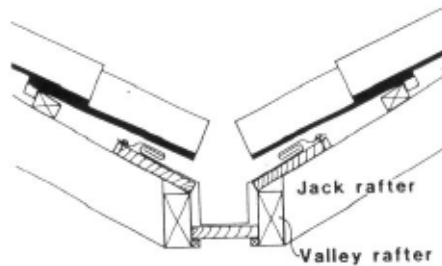

Instead of using planks, the flushing can also rest directly on the valley rafter. Covering the metal flushing with a layer of roofing felt is a good protection against corrosion.

b) Gutter

A more sophisticated solution is the use of a gutter, U-shape or rounded. It might be necessary in extreme situations where the roofs are very large or where snow occurs.

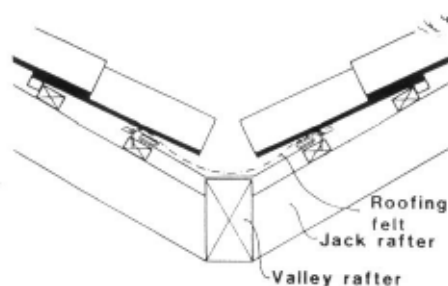

If a gutter is used, a pair of valley rafters is needed to provide a gap for the gutter.

c) Valleytile

Special valley tiles can also be used. This method is, however, not safe and therefore not recommended.



6.11 Adjoining wall ridge (lean-to roof)

Detail L

When a lean-to roof adjoins to a wall, 4 basic types of joints are possible:

a) Tiles built into the wall and sealed with mortar.

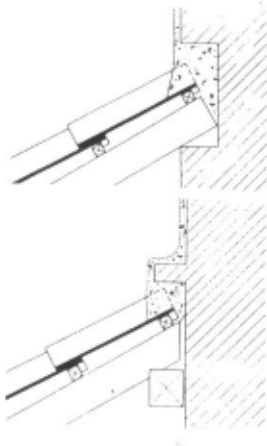

b) Flushing with lead sheet.

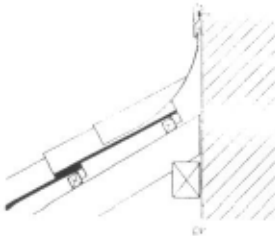

c) Flushing with galvanised iron or another hard metal sheet. In this case a tile with a “dam” as for ordinary ridges (Chapter 6.3) is used.

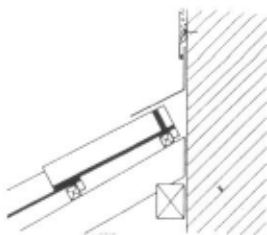

A layer of roofing felt should be used between the metal and the tiles to avoid corrosion.

d) Cement mortar joint against the plain wall.

This solution is not reliable because cracks may occur between the wall and the cement mortar.

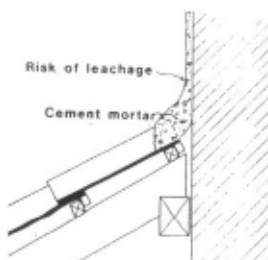

6.12 Adjoining wall verge

Detail M

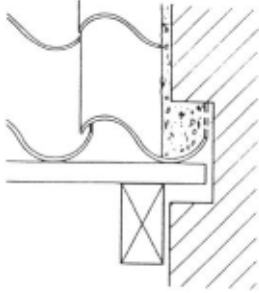

Tiles built into the wall

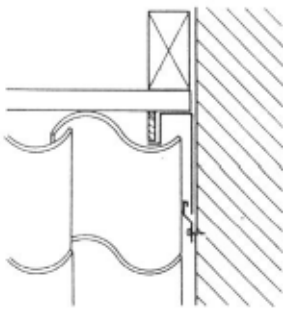

Left verge with gutter laid on top of the battens

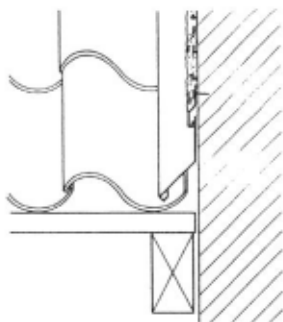

Right verge sealed with metal flashing

When a roof joins a wall on the verge side, the tiles can be built into the wall, or the joint can be sealed with metal flashing on the right side and a gutter on the left side.

A layer of roofing felt should be used between the metal and the tiles to avoid corrosion.

7. ROOF CONSTRUCTION PROCESS

This chapter contains the basic rules for laying of battens and tiles. A report on a course in Ghana [10] gives a detailed step-by-step description of the construction of a L-shaped hipped roof.

7.1 Safety

Working on roofs, especially erecting roofs, is obviously a dangerous job. There are many different dangers which can cause serious accidents.

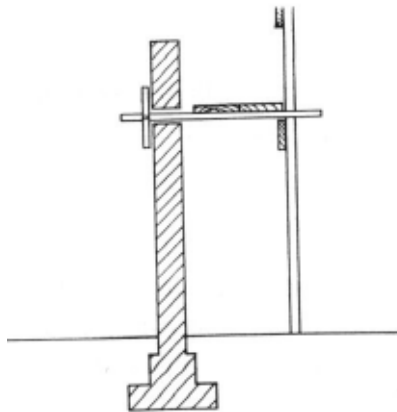

Scaffold built during wall construction

For the safety of the workers all possible precautions must be taken to minimise the risks. The most important aspects are:

a) Construction of a reliable scaffold

For laying the roof structure, a properly-built scaffold is necessary. Often it is already needed for the construction of the walls. Where this is not the case, the scaffolding must be built subsequently.

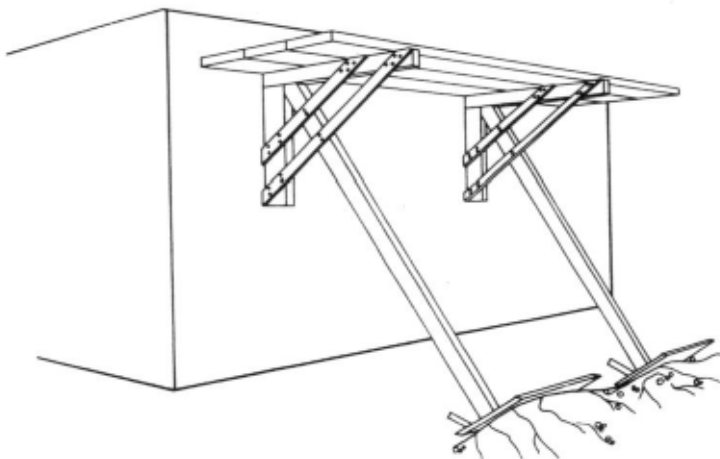

Scaffold added subsequently to the wall construction

If gutters or fascia boards have to be mounted, it is advisable to add a railing to the scaffold.

b) Substructure

The substructure must be strong enough to support the weight of the workers as well as stacking of the required material. Battens and rafters for instance have to be strong enough to carry a man as well as the weight of the roof cover (see Chapter 4.3.4 “Sizing of timber structures” and Appendix 3)

c) Safe access

Ladders, stairways etc. must be strong enough and should not rest on slippery surfaces. Ladders should be fixed with ropes.

d) Clothing

Workers should wear solid and non-slipping shoes. The use of helmets is advisable, especially for those working below the roof because of the danger of material and equipment falling.

e) Physical fitness

Only mentally and physically fit and healthy workers should work on the roof. The work is too dangerous for people who are ill, unfit, weak or drunk. Children and old people should also not be employed for such work.

7.2 Laying of battens

also see [6], Toolkit Element 24: Roof Structure Guide)

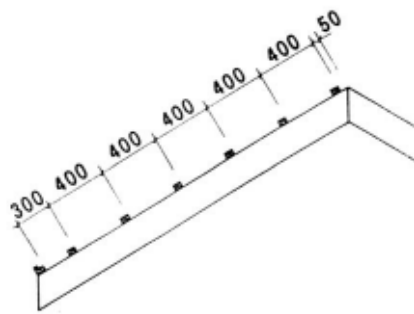

The battens which normally measure 50 x 50 mm or 30 x 50 mm, are fixed to the rafters starting from the ridge. The first batten is placed at a distance of 50 mm from the ridge and checked with a string for straightness.

The subsequent battens are fixed at a distance of 400 mm and are also checked for straightness. A template is a good tool to check the correct distance of the battens.

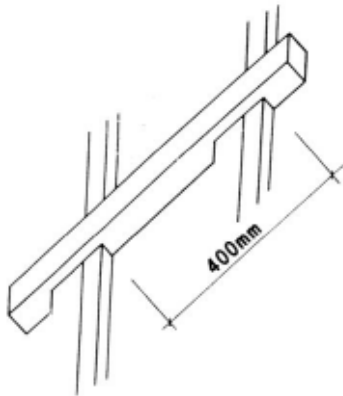

The last batten has a distance of 250 - 300 mm only, because of the tile overhang at the eaves.

After the lowest batten has been fixed, the rafter is cut to its final length.

At the right verge the battens are kept slightly longer. After laying the last tile, the final batten is cut to the required length.

Where necessary, minor cutting or wedging work is needed to ensure that no difference in height would hamper laying the tiles. The top of the battens must be level, except the lowest one which should be higher by the thickness of a tile.

Jointing of battens is done always on top and in the centre of a rafter, so that sagging joints can be prevented.

7.3 Laying of tiles

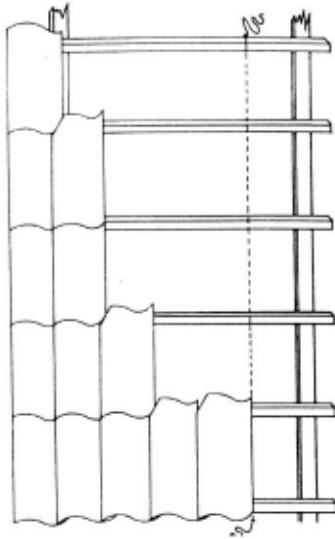

*Laying from left to right
and from eaves to ridge*

(also see [Chapter 6.1](#))

Once the roof structure has been erected, it should be covered as soon as possible to protect it from sun and rain; otherwise the wood may start to warp and the joints loosen. Laying the tiles is started with the bottom tile at the left verge. Then the entire row along the verge is laid and brought into line with the help of a string. The second row is laid and brought into line, and so on. The direction of the prevailing wind does not influence this laying pattern.

The tiles are laid as tightly as possible to minimise daylight penetrating the roof.

Before laying the last row of tiles, the battens are cut to the required length.

Once all tiles have been laid on one side of the slope, the work is continued on the other slope, but in the opposite direction (also from left to right). At this stage the ridge tiles are placed, simultaneously with each row of tiles. In this way the need for climbing onto the roof later can be avoided.

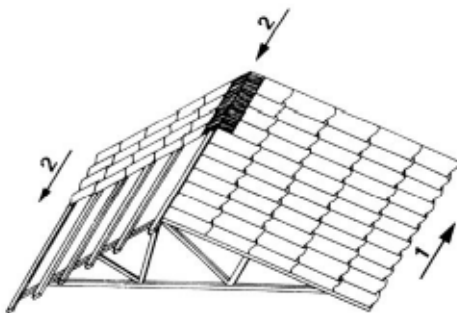

The tiles are fixed by a nail through a wire hook built into the nib or by a wire loop around the batten (see [Chapter 6.1](#)).

8. MAINTENANCE

8.1 Maintenance concept

As with all building parts, the roof structure and its cover have a certain life span. This can be extended considerably if the roof is maintained regularly and damage is repaired in time. Severe damage can often be prevented if it is repaired immediately at the initial stage. In this sense, regular maintenance does not only retain the value of the building, but it also saves cost.

For these reasons it is advisable to plan maintenance work, to establish a maintenance concept.

Aspects of a maintenance concept

Responsibility

The persons who are responsible for checking, organising and implementing repair work have to be clearly identified.

Timeschedule

Checking the structure and the roof cover should be done routinely according to a clear time schedule. A yearly inspection should be the minimum. The roof cover should also be checked after every storm and of course in the case of any leakage.

Material stocks

Some basic materials such as spare tiles, wire, nails and tools should be readily available to facilitate immediate minor repairs.

Money allocation

Although the maintenance costs for well-constructed roofs are minimal, difficulties can arise if there is no budget allocated for this. Therefore a small amount of money should be reserved in the yearly budget for maintenance. This can save higher costs arising from damage to the roof and the interior if timely repair is neglected.

8.2 Maintaining the tiles

(Maintaining the structure see [6], Toolkit Element 24: RoofStructure Guide)

Normally the roof structures as well as the tile cover does not need much maintenance. However, tiles can be dislocated by heavy storms and break when people walk on them, and be damaged by falling branches, coconuts, or large hail stones. Faulty manufacturing may be another reason for damage.

Tiles should be regularly inspected, maybe once a year. After every heavy storm inspection is also indicated or whenever moisture appears inside the building.

Working from the inside

Inspection and repair of tiles should be undertaken from the inside of the building. Small cracks and dislocations can easily be found as a result of the daylight shining through. Walking on the roof should be avoided to prevent breaking.

A firm and safe scaffold is required for work done under the roof.

Where there is a ceiling, it may be removed for maintenance purposes.

Where this is not possible, walking on the roof is unavoidable. In this case a crawling board or a ladder should be laid on the roof. Jute bags between the tiles and the board cushion it and prevent it from sliding down. For safety reasons, especially in the case of multi-storied buildings, scaffolding is recommended as access to the roof.

Replacement

The replacement of broken elements can easily be done from the inside. Where a ceiling renders access from the inside impossible, replacement must be done from the outside. In this case fixing the new elements with wire loop is not possible.

Readjustment

If roofing elements are dislocated by heavy storms they should be readjusted. At the same time the wire loop fixing may be re-tightened where required.

APPENDICES

- 1 Conversion factors for roof slope
- 2 Recommended further reading and references

APPENDIX 1

Conversion factors for roof slope

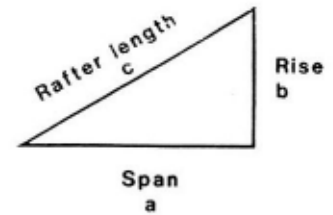

Pitch (Degree)	Pitch (%)	ratio rise : span b : a	ratio rafter length : span a : c
22°	40.4%	1 : 2.47	1 : 1.079
24°	44.5%	1 : 2.25	1 : 1.095
26°	48.8%	1 : 2.05	1 : 1.113
28°	53.2%	1 : 1.88	1 : 1.133
30°	57.7%	1 : 1.73	1 : 1.154
32°	62.5%	1 : 1.60	1 : 1.179
34°	67.5%	1 : 1.48	1 : 1.206
36°	72.6%	1 : 1.38	1 : 1.236

Reading example:

With a given pitch of 30°

- the pitch is 57.7%
- the span is 1.73 x the rise
- the rafter length is 1.154 x the span incl. roof overhang

or

with a given pitch of 30° and a span of 5m

- the rise is $5\text{m} : 1.73 = 2.899\text{ m}$
- the rafter length is $5\text{m} \cdot 1.154 = 5.77\text{ m}$

Conversion factors for roof slope

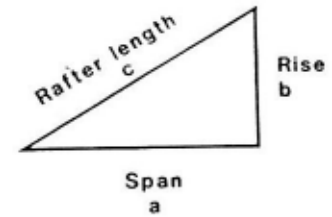

Pitch (Degree)	Pitch (%)	ratio rise : span b:a	ratio rafter length : span a : c
21.8°	40%	1 : 2.50	1 : 1.08
24.2°	45%	1 : 2.22	1 : 1.10
26.6°	50%	1 : 2.00	1 : 1.12
28.8°	55%	1 : 1.82	1 : 1.14
31.0°	60%	1 : 1.67	1 : 1.17
33.0°	65%	1 : 1.54	1 : 1.19
35.0°	70%	1 : 1.43	1 : 1.22
36.9°	75%	1 : 1.33	1 : 1.25

Reading example:

With a given pitch of 60%,

- the pitch is 31.0°
- the span is 1.67 x the rise
- the rafter length is 1.17 x the span incl. roof overhang

or

with a given pitch of 60° and a span of 5m

- the rise is $5\text{m} : 1.67 = 2.99\text{ m}$
- the rafter length is $5\text{m} \cdot 1.17 = 5.85\text{ m}$

Conversion factors for roof slope

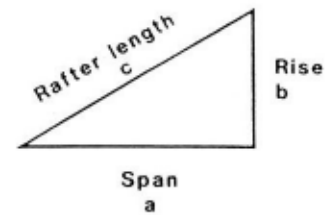

Pitch (Degree)	Pitch (%)	ratio rise : span b:a	ratio rafter length : span a : c
21.8°	40%	1 : 2.5	1 : 1.08
26.6°	50.0%	1 : 2	1 : 1.12
33.7°	66.7%	1 : 1.5	1 : 1.20

Reading example:

With a given ratio of slope (rise : span) of 1 : 2

- the pitch is 26.6° or 50%
- the span is 2.0 x the rise
- the rafter length is 1.12 x the span incl. roof overhang

or

with a given ratio of slope (rise:span) of 1:2 and a span of 5 m

- the rise is $5\text{m} : 2 = 2.5\text{ m}$
- the rafter length is $5\text{m} \cdot 1.12 = 5.6\text{ m}$

APPENDIX 2

Recommended further reading and references

(E)= English; (F)= French; (S)= Spanish; (G)= German

1. Evans, Barrie: "Understanding Natural Fibre Concrete, Its Application as a Building Material", IT Publications Ltd., London, 1986 (E)
2. Gram, H.-E.; Parry, J.P.M.; Rhyner, K.; Schaffner, B.; Stulz, R.; Wehrle K.; Wehrli, H.: "FCR - Fibre Concrete Roofing. A comprehensive report on: The Possibilities of Fibre Concrete Roofing. The Limits of Application, and The State of the Art", SKAT, St. Gallen, 1986 (E)
3. Gram, Hans-Erik; Gut, Paul: "FCR/MCR Toolkit Element 22, Production Guide", SKAT, St. Gallen, 1992 (E)
4. Gram, Hans-Erik; Gut, Paul: "FCR/MCR Toolkit Element 23, Quality Control Guidelines", SKAT, St. Gallen, 1991 (E)
5. Gut, Paul: "FCR/MCR Toolkit Element 4, Standards Guidelines", SKAT, St. Gallen, 1992 (E)
6. Gut, Paul: "FCR/MCR Toolkit Element 24, Roof Structure Guide", SKAT, St. Gallen, 1993 (E)
7. Gut, Paul: "Climate Responsive Building", SKAT, St. Gallen, 1993 (E)
8. Heierli, Urs; Beck, Victor: "FCR - Fibre Concrete Roofing, Feasibility and Market Study Guides", SKAT, St. Gallen, 1987 (E)
9. Lola, Carlos R.: "Fibre Reinforced Concrete Roofing Sheets, Technology Appraisal Report", AT International, Washington, D.C., 1985 (E)
10. Müller, Heini: "Roof construction training in Ghana, T.R. 14", SKAT, St. Gallen, 1991 (E)
11. Parry, John: "Fibre Concrete Roofing", Intermediate Technology Workshops, Cradley Heath, 1985 (E)
12. Parry, John: "Fibre Concrete Tiles, Users Manual", Cradley Heath (E)

13. Preiswerk, Susanne, Müller Heini: "Introduction of Micro-concrete tiles in the Philippines, T.R. 17", SKAT, St. Gallen, 1991 (E)
14. Schunk Eberhard; Fink, Thomas; Jenisch, Richard; Oster, Hans Jochen: "Dach Atlas", Institut für internationale Architektur-Dokumentation, Munich, 1991 (G)
15. SKAT: "Información Básica Sobre Techos de Micro Concreto (TMC) y Fibro Concreto (TFC), Introducción para Arquitectos, Técnicos, Epresarios, Instituciones de Desarrollo y el Público Interesado en TMC y TFC", SKAT, ST. Gallenen, 1989 (S)
16. SKAT: "The Basics of Concrete Roofing Elements, Fundamental Information on the Micro Concrete Roofing (MCR) and Fibre Concrete Roofing (FCR) Technology for Newcomers, Decisionmakers, Technicians, Field Workers and all those who want to know more about MCR and FCR", SKAT, St. Gallen, 1989 (E)
17. Stulz, Roland; Mukerji, Kiran: "Appropriate Building Materials, A Catalogue of Potential Solutions", SKAT, St. Gallen, GATE, Eschborn, IT Publications Ltd., London, 1988 (E)
18. Twigt, Fred Jan: "Fibre Concrete Roofing in Malawi, Kenya, Tanzania, Zambia and Uganda", FCR Advisory Services, SKAT, St. Gallen, 1988 (E)

Audio-visual material

19. MacWhinnie, Ian: "An Introduction to FCR/MCR Production", A BASIN Video, ITDG/GTZ-GATE, Eschborn, 1990 (E)

This guide provides the necessary information on the design and construction of FCR/MCR tile roof cover. Emphasis is given to simple and basic roof forms.

The guide aims at helping to do proper detailing, and to build and maintain the roof cover in a sound manner. It deals with the different roof cover types, gives information about tile requirements and provides detailed solutions to all commonly occurring situations on roofs.

The guide is addressed to architects and engineers involved in the design of buildings with FCR/MCR tile roofs, and also to builders, site engineers and overseers, who are implementing construction.

Producers of roof cover materials can use the guide as a basis for advising their costumers on the successful use of their products. The guide is also useful as a teaching aid.