

Make Your Own Treadle Lathe



By Steve Schmeck

**Make Your Own
Treadle Lathe**

Copyright © 2005, 2008 by Steve Schreck

Published by ManyTracks Publishing

All rights reserved.
Permission to reproduce portions of this
book may be obtained from the publisher or author.
Inquiries should be addressed to:

ManyTracks Publishing
770N Fox Road
Cooks Michigan 49817.

Telephone: 1-906-644-2598
e-mail: steve@manytracks.com
Web site: www.manytracks.com

ISBN: 0-9652036-7-0
ESBN: 81897-050218-122102-14
Library of Congress Control Number: 2005922672

Print version printed on 100% recycled, acid-free paper
with power from the sun.

Updated January 2008

Why this small book exists

In the last twenty years or so since I built this foot-powered treadle lathe, I have received many requests for drawings or plans. The lathe has been used as part of our traditional woodworking demonstrations and it never fails to draw a crowd. Of course, the reason the lathe exists is because I felt a need for it as a tool.



Design considerations

Some of the main considerations when designing the lathe were:

- Human powered -- our solar energy system was pretty small at the time
- Size -- it had to be less than 42" tall to fit into our old truck
- Compact -- since it would sit in our small shop all the time, a small footprint was essential
- Portable -- as in not too cumbersome or heavy
- Functional -- it had to perform the basic duties of a light-duty lathe
- Adaptable -- I had in mind several untraditional uses for the tool, like sanding

Background

During a demonstration at a Steam and Gas Antique Village many years ago, I had the opportunity to use a monster treadle lathe with a 6' diameter wood flywheel and 8' long bed. This old timer had been used during the lumbering boom years in Michigan's Upper Peninsula to turn decorative porch posts for some of the fancier "Lumber Baron's" homes. As you might guess, it took a lot of energy to keep that big, heavy wheel turning, even when the piece you were turning was not particularly large.

I had built a couple of spring pole lathes for use in the shop and on the road at demonstrations. One used an ironwood pole lashed in the shop's rafters, and the portable unit used a bungee shock cord for recoil power. Spring pole lathes are cool and although their unique intermittent cutting action required a bit of getting used to, mine did a lot of turning of both spindles and some small bowls and plates. Eventually, though, I wanted an easier way to demonstrate the use of a lathe to turn the tubes of a series of wooden flutes I was making. This treadle lathe with its continuous cutting action was my next project.

Materials

I wanted to use materials I had on hand to build the lathe. Luckily I had recently had a local sawmill cut and dry some 3x3's and 2x4's from a large maple cut in our woodlot. Although I used this more or less uncommon stock, there is no reason a decent lathe couldn't be made from regular dimensioned 2x lumber. The denser and more durable the better. I would think that something like yellow pine would be very good.

This booklet can be used to guide you through the construction process. step by step or.

if you like, just to help you see one way the design and construction challenges of building a human-powered lathe were handled.

Where from here?

If you are reading this in digital format you can use the index at the left to move through the construction process. Click on any of the heavy-bordered photos accompanying the text to see an enlarged view or select a graphic from the list at the lower left. If you are reading this in a printed form and would like to obtain a free, up-to-date digital version (E-Book or PDF), aim your Internet browser at www.manytracks.com/lathe. I hope you enjoy this project and that it helps you to build your own human powered treadle lathe.

Lathe - Front View

Make Your Own Treadle Lathe



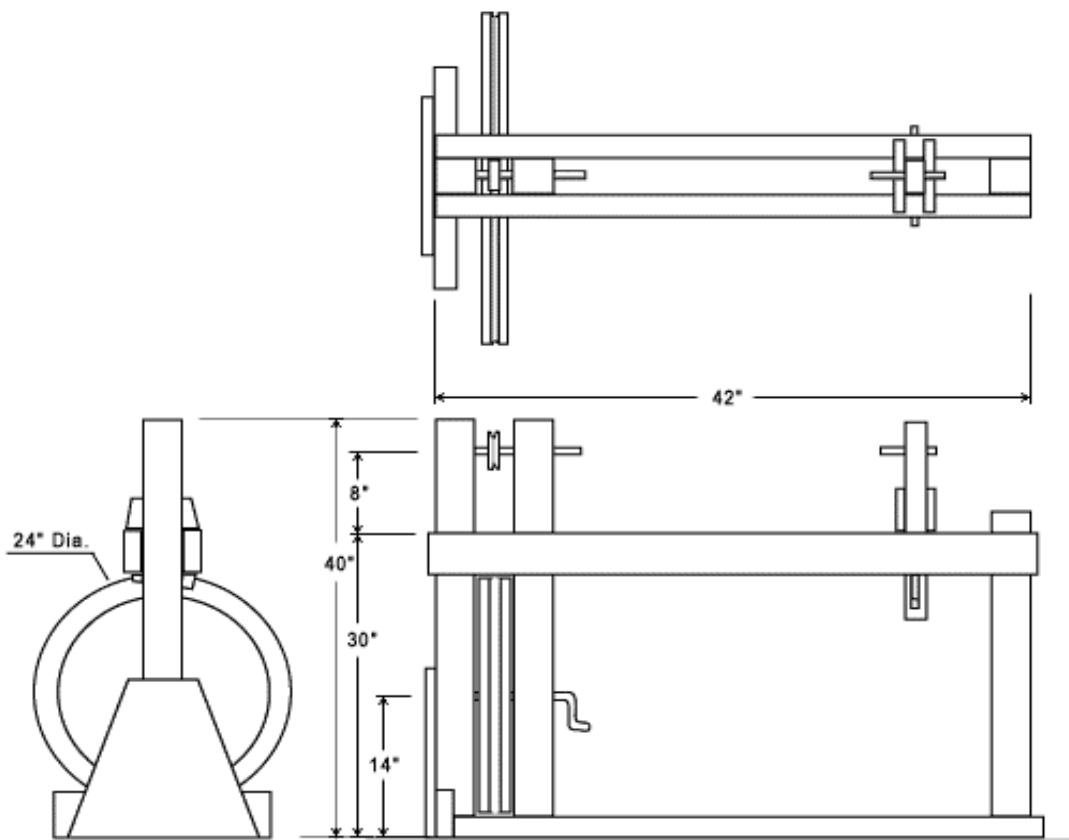

(c) 2005 Steve Schreck

I have listed below the materials and parts used in the building of this lathe. In a few places I have listed options or alternatives based upon experience I've had using the lathe over the last 20+ years. In general it has done what I asked it to do but there are a few things I would change and have noted them here and in the building process text. The materials are based upon stock I had on hand and the dimensions shown work for my 5'-10" height frame. Feel free to modify either materials or dimensions to fit your own needs.

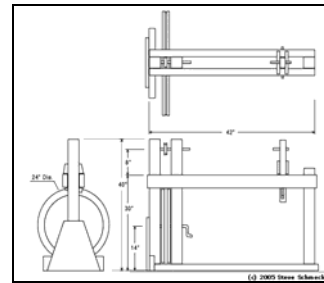

Wood:	
I used maple for all wood parts except as noted below. All lumber dimensions are nominal, that is, 3x3's actually measured 2¾"x2¾", 2x4's measured 1½"x3½".	
Headstock Uprights: 2 - 3x3 x 38½" Tail Upright: 1 - 3x3 x 27½" Ways: 2 - 2x4 x 42" Base: 1 - 2x4 x 40½" Base Stabilizer: 1 - 2x4 x 24" Headstock End Brace: 1 - 1x10 x 12" Tailstock: 1 - 2x4 x 18" Tailstock Braces: 2 - 1x3 x 6" Flywheel Center: 1 - 1x8 x 8'	Flywheel Rim: 2 - 1x6 x 6' - (cherry) Treadle: 1 - 1x2 x 28" Tool Rest... Upright: 3x3 x5" Top: 2x4 x 8" (could be longer) Base: 1x4 x 12" Spacer: 3x3 x 3" Clamp-piece: 1x4 x 6"

Parts:
Spindle Shaft: 8" x ½" steel rod (Optional 8" x 5/8" or larger diameter) Spindle Pulley: 3" Diameter adjustable pulley (or pulley to fit your belt) Flywheel Centers: 2 - 3/8" plumbers floor flanges - (or sized to fit your crank shaft) Crank Shaft: 11" x ½" steel rod (I used crank arm from old Singer treadle sewing machine) Treadle Connector 11" x ¼" threaded rod (Mine came from above sewing machine) Tool Rest Adjusting Bolt: 3/8" x 6" Carriage Bolt - with square nut & flat washer Tool Rest Post Pivot: 5/16" x 3" lag screw Leather belting: Singer treadle sewing machine replacement belts (2)

Looking back at some of the reference books in my library, I was struck by the relative simplicity of some of the old treadle lathes. I have had some experience with hardwood bearings and had originally planned to go that route on this lathe.

In the early years here on our homestead our alternative energy system was pretty small; too small to run larger shop tools. To solve this problem, I set up a line shaft at one end of the shop. It was made of a ten foot long, 3/4" diameter cold rolled steel shaft supported by three maple bearings. It was powered by a gasoline engine just outside the shop. With six horsepower spinning that shaft it ran my Shopsmith, jointer and band saw just fine. I had a throttle control and engine cut-off on the inside wall which gave a lot of control over tool rotation speed. I'd guess that a good part of that six horsepower was used to overcome the friction in those bearings.

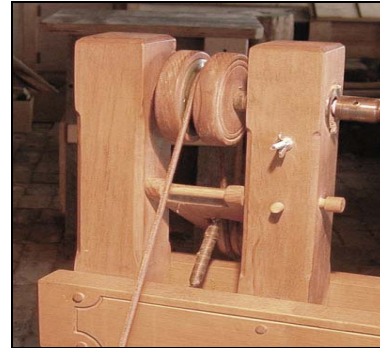

With just my right leg to power the lathe, I decided I'd need as little friction in its shafts as possible so I compromised a bit on authenticity and designed the headstock around a pair of light-duty sealed ball bearings. If I was to do it over, the only change I'd make here would be to use a larger, perhaps 5/8", diameter spindle. There are two reasons for this; the additional mass of the larger spindle would increase its flywheel effect, and 5/8" plain-shaft accessories like drive centers and chucks are more readily available.

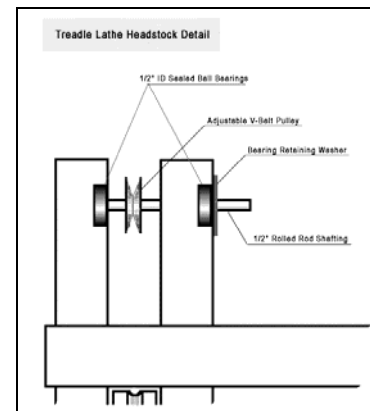

Layout and Construction

You can see from the drawing at right how the bearings and spindle are set up. Before the uprights are fastened in place you will want to lay all three 3x3's side by side, with the base 2x4 across their bottom ends, and draw a line across them 30" up from the bottom of the base board. This is the height of the top of the ways on my lathe.

You may want to adjust this to match your most comfortable working height. On the two longer uprights measure up another 8" to establish the spindle's center above the ways. Carry the lines around on all four sides of each upright with a try square. On the left upright mark the center and bore a hole the size of the outside of the bearing and as deep as the bearing is thick. I used an old adjustable auger bit which nicely also cleaned out the hole. An appropriately sized Forstner or paddle bit could also work well.

Repeat this on the center upright and then continue through it with a bit large enough to clear the spindle's shaft completely. In my case, I used a 3/4" bit for my 1/2" shaft. The bearings are retained in place by a couple of pan-head screws, placed 180° from each other just outside the edge of the hole.

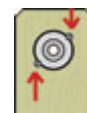

While working with these pieces use the same procedure to lay out and install the

flywheel bearings. These are centered in the space between the base 2x4 and the *bottom* of the ways; 12½" up from the base on my lathe. I happened to mount my flywheel bearings on the inside or wheel-side of the uprights but could just as easily have laid them out on the right sides as were the headstock bearings.

The variable width headstock pulley I used (from a furnace blower) is pretty ugly so I turned a couple of cherry disks to fit tightly on either side of it. These are for looks only. Every once in a while one will work itself loose a bit and make a racket as it spins on the shaft but I just slide it back into position and it is good for a while. I hesitated to glue these on because that might compromise servicing the pulley some day.

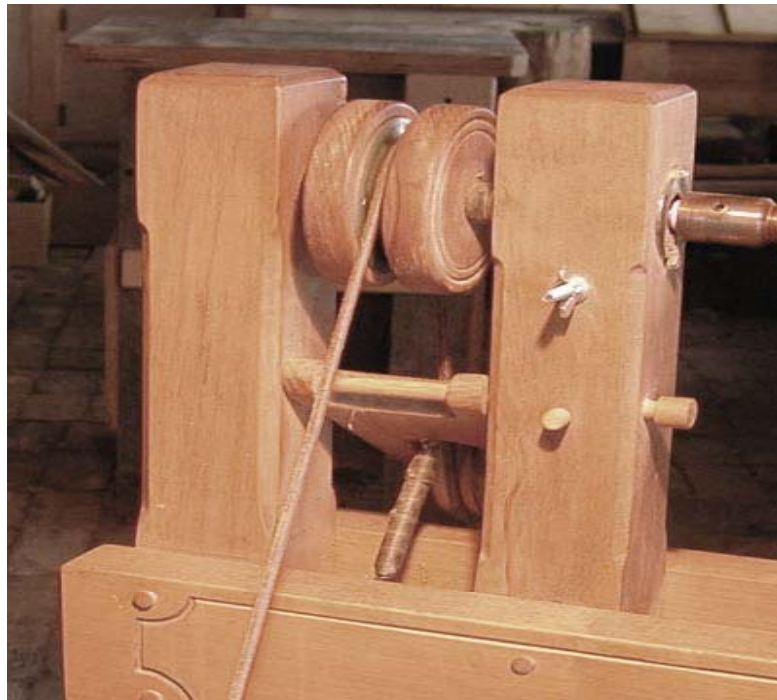

Headstock Close-up

Make Your Own Treadle Lathe

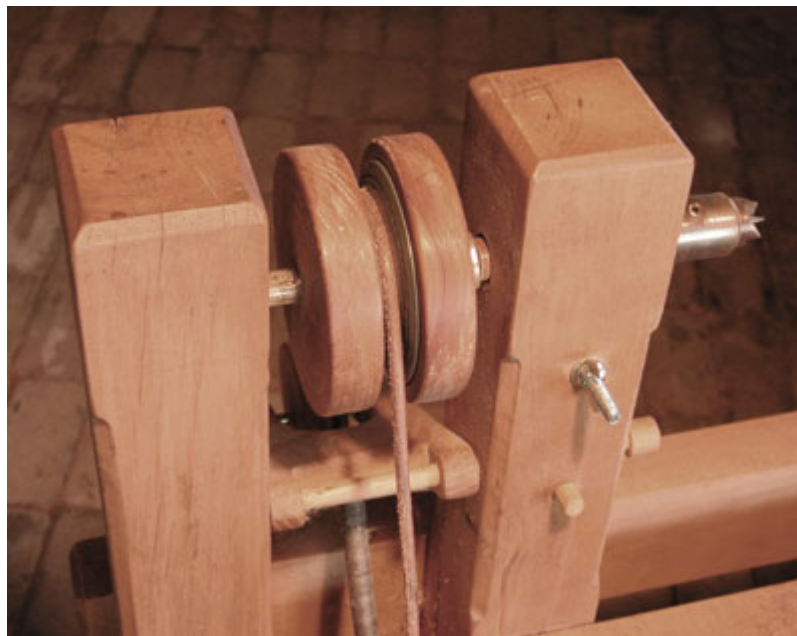
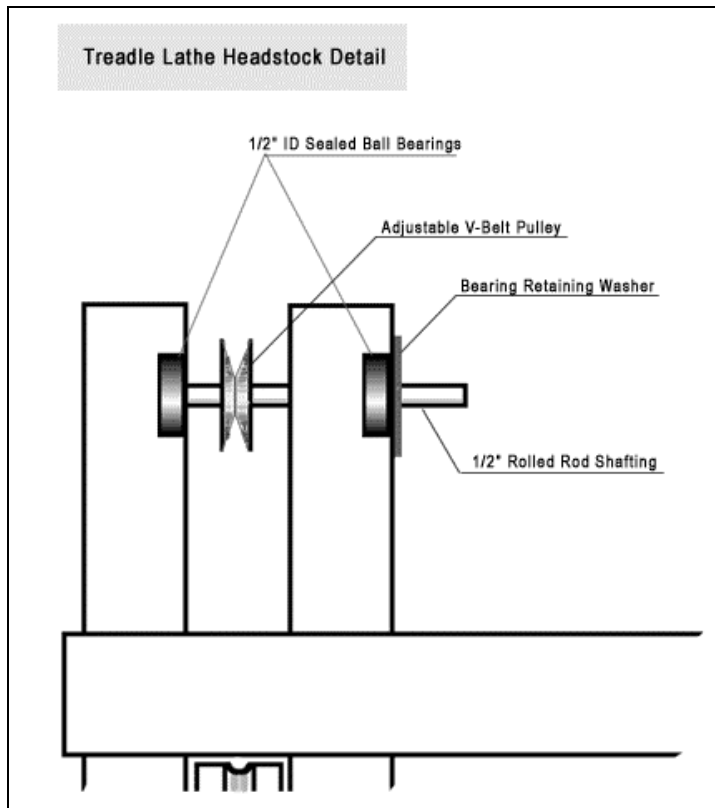



Depending on the type of belt you decide on, you may need a belt-tensioning device of some kind. My belt is made from a couple of Singer treadle sewing machine belts cut and joined to fit the lathe.

The Belt: Singer sewing machine belts, which are essentially long loops of leather have a cross-section of about ¼". Singer used a small metal staple  to hold the ends of the loop together. I used this system for a while but found it was prone to break during critical moments during public demonstrations. After several experiments, I found that a better way to join the belting for this application was to sew the ends together using nylon artificial sinew (heavy nylon thread).  This also had the advantage of going through the top pulley more smoothly.



The Tensioner: The solution I came up with to keep a moderate amount of tension on the belt was a spring-loaded, pivoting frame holding a lathe-turned (need a lathe to make a lathe?) idler pulley. The 'U'-shaped frame pivots on a ¼" dowel and is tensioned by a wimpy, found, coil spring (barely visible below the frame in the photo). Although the spring arrangement works OK it looks a bit cheesy and might be done more elegantly with some sort of system with adjustable weights on the idler. I put a short section of ½" dowel on the end of the pivot dowel to make it easier to remove or adjust.

The idler wheel runs on a couple of very small ball bearings scavenged from an old computer disk drive, but any small bearings or even a nice little bronze bushing would work well. The whole point here is to keep just the right amount of tension on the belt to avoid slippage, without adding any unnecessary friction into the system.

This is a place where you might say "I can do better than that!", and you are probably right. This tensioner has worked well for me for many years but I'm sure there are other ways to solve the belt slippage problem.

As an aside, the old monster lathe I mentioned in the introduction had a unique slippage problem and solution. The attack angle of the belt coming off that big six foot flywheel to a 4" drive pulley didn't provide much traction area on the small pulley ['A' below]. The simple solution was to loop the narrow belt (a loop of hemp rope) around the small drive pulley and reverse the direction of rotation of the flywheel ['B' below]. It looked and felt weird with that big wheel going 'backward', but it worked quite well.

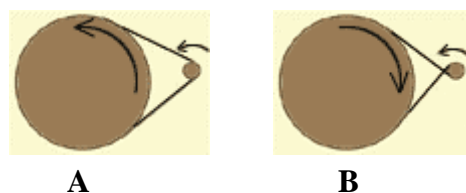



Tailstock

The tailstock is made from an 18" long 2x4. For the part that rests on the ways I cut a rabbet in a 6" piece of 3x3 and doweled and glued the pieces together. This is another case of "If I had it to do over again". For simplicity's sake and to add a bit of rigidity, I'd now attach a 1x3 on either side of the upright piece as shown on the Measured Drawing.

Mark the center height by sliding the tailstock up to the end of the shaft. I had a fixed cup center from my old Shopsmith so I drilled a 1" hole to mount it in. You could also use a good #2 Morse taper live center. If you do, drill a 9/16" hole and carefully use a rat-tail file and sandpaper wrapped around the center's shaft to taper the hole.



Then again, you could do as I did on my old spring pole lathe. I used a 1/2" x 8" lag screw, with a sharp 90-degree bend in it for a handle. I drilled a 7/16" pilot hole, heated the screw red hot with a propane torch and burn/screwed it into place. With the point reshaped into a smooth, blunt cone and a little paraffin wax rubbed on the threads and point, the "center" worked just fine.

A tapered wedge running through a mortise in the tailstock secures it to the ways. The drawing on the right shows the shape and position of the mortise relative to the bottom of the ways. You can chop put the mortise with a 1/2" chisel or drill it out and clean up the sides with wider chisels. Make the wedge from a 7" x 2 1/4" piece of 1/2" hardwood. The narrow end tapers to 1 1/2" wide and the bottom of the mortise matches this angle. Drill a hole an inch from the end of the wedge and insert a short piece of dowel to keep it from falling out during adjustment.

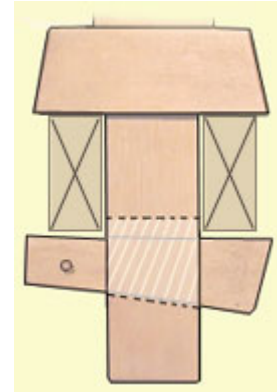

Tailstock Close-up

Make Your Own Treadle Lathe



One of the projects I was working on at the time I designed this lathe was a series of wooden flutes. The blanks were split out by hand and bored by hand but I had been using my old Shopsmith as a lathe for shaping the outside. Not very traditional and certainly not very portable. I wanted to be able to be able to turn these on the treadle lathe.

The original tool rest top was about 14" long to facilitate turning those tubes but was not as steady as I would have liked. In the photos you can see a couple of hangar bolts in the right upright and tailstock. These hold a slotted-for-adjustability hardwood 1x2 which acts as a tool rest for the flutes. The top shown here was installed later to use in faceplate turning of a set of cherry plates.



Tool Rest Design

The close-up photos show the structure of the tool rest assembly. The top piece can be interchanged with longer, shorter, or specialty rests. Just about the only thing that doesn't show in the photos is the fact that the vertical post rotates on a lag bolt, the head of which is recessed into the base piece that spans the ways. This allows the tool rest to face parallel to the ways for spindle work or be rotated perpendicular to the ways for faceplate turning.

There is no vertical adjustment of the tool rest. Once I found a height that worked for me, I have been able to live with it for all kinds of turning. It wouldn't be too difficult to design height adjustability into the support post, but I haven't needed it for the kind of turning I've been doing.

To create the slot in the base piece drill a hole 3" in from each end, draw guide lines from hole to hole, and saw along these lines to connect the two holes. I used a traditional turning saw which looks like a regular old time frame saw but has a narrow, 1/4" wide, blade. A coping saw (slow) or non-traditional saber saw would also work. The slot width is determined by the thickness of the square shoulders just under the head of the 6" carriage bolt.

The 'wing nut' that tightens the tool rest in place was made by chiseling a mortise in the bottom of a 1" x 1" x 4" hardwood scrap to accept a square nut, and shaping the piece to allow finger room.



Flywheel

The flywheel is made up from a central layer of maple planks with a cherry rim applied to each side. The idea here was to use the rim to hold the wheel together as well as add some more weight at the outside edge of the wheel where it would do the most good. Although it may seem like I was putting the cart before the horse, I began by making the rims.



Rim design & layout

Start by making a template from an 18" x 12" piece of illustration board or similar material. Using a center point half way along one long edge draw two arcs, one with a radius of 12", the other, a radius of 10".

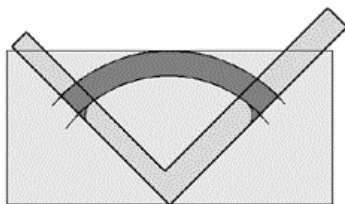

Then use a framing square positioned with the point on the center mark and draw the two quadrant end lines. As you can see at left and perhaps better in the larger photo, I fancied up the ends by drawing small arcs intersecting the inner arc and each end line. For this 24" diameter wheel the template length turned out to be a bit less than 18" so four pieces fit on each of two cherry 1 x 6's about

6' long.

Cut these eight rim sections (four for each side of the flywheel) about 3/8" oversized on the outside arc, being careful to cut the ends true to the lines. The over-sizing is done to allow some cutting space when the assembled wheel's finished circumference is trimmed.

The wheel body

The next step is to cut an 8-foot long maple 1x8 into four pieces; two 26" long, and the other two 22" long. These pieces are laid out on the bench and clamped down side by side with the longer pieces in the center. Draw an 'X' from corner to corner on the middle boards to establish what will become the center of the flywheel. Next use this center point to draw a 10" radius circle on the boards as a guide in laying out the rim sections. The Flywheel Layout Drawing shows this better than I can say it.

The rim sections are then placed around the inner guidelines. They should be arranged to give maximum strength by crossing the joints in the maple at as close to a right angle as possible. This is a good time to clean up any ill-fitting rim joints. The rim sections are then nailed into place. Although the nails have worked just fine for many years on my lathe, I now might be tempted to use some nice flat-head brass screws.

Before turning the assembly over, drill a 1/16" hole through the center point to transfer the center to the other side of the wheel. Repeat the same procedure; draw 10" radius guide-circle, lay out then fasten the rim on the other side, staggering the section joints for strength.

Cut the wheel to shape

I have an ancient 12" Craftsman bandsaw so I made a jig as explained below to true up the outer edge of the flywheel. If you don't have access to a bandsaw a good, sharp power jigsaw would work. Without power at all one could do a decent job with a narrow blade in a frame or 'turning' saw.

You can make a bandsaw jig using a scrap 2x4 about 36" long. First, make a cut half way through the 2x4 in a position that gives some clamping room to the left of the blade; about 11" from the left end. Remove the board from the saw and measure a point 12" to the right of the saw kerf, centered on the width of the 2x4. On that mark drill a 1/4" hole for a 6" long, 1/4" bolt that will act as a pivot point for the cut.

Next, re-draw the 12" radius circle and draw a tangential line (just brushing the circle) on the cherry rim and then enlarge the center hole to 1/4". Securely clamp the jig in place *without the pivot bolt* to support the wheel while making the initial cut on that tangential line. Then install the bolt up through the jig and wheel center. Adjust the saw's upper guide as low as practical and cut the wheel to shape.

There are as many ways to build a jig as there are jig-builders so don't hesitate to be creative here. This just one way to trim the outside of the flywheel. Whatever way you do it just remember that the smoothness of power transmission is directly proportional to the roundness of the flywheel.

Mounting the wheel

I used the same 1/2" bearings for the flywheel as I did for my headstock. To make up the wheel's shaft I brazed a section of 1/2" rod to the crank assembly cut off of our old Singer sewing machine. This provided both the crank and crank bearing, sort of simplifying this aspect of the project. You could make a one-piece crank from hardware store round stock by heating and bending it in a sturdy vise. The offset on my crank is only about 1-1/4"; less than I would have thought necessary, but it gives a good compromise between speed and torque with the pulley ratios I used (24:3).

Build you own crank

In an early edition I suggested an alternative method of making a crank bearing using a heavy washer brazed to a piece of threaded rod. A builder reported excessive wear on the crank shaft. So, my current thought is to use an inexpensive rod-end bearing, like the one shown here. These bearings are not designed to have a rotating shaft running through them but if one was to slightly reduce the shaft diameter with some fine sandpaper and oil it once in a while... Screw a length of threaded rod into one of these, the bottom end of which goes through a hole in the treadle and is held there by a nut and washer on the underside of the treadle. You want a bit of looseness in all this to allow the treadle to pivot and move around to a comfortable position beneath the lathe.

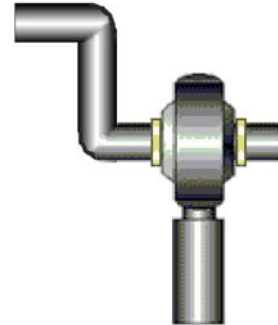

The flywheel hubs are made from 3/8" steel floor flanges sometimes used to support stairway handrails. These were bored out to accept the shaft and the right-hand one cross-drilled through its hub to accept a heavy cotter pin (or high-tech bent nail), tying the wheel securely to the shaft. This arrangement provides adequate stability and has weathered some pretty aggressive use without any problems.

Finally, grooving

Once the flywheel is mounted and can be rotated easily about its permanent axis, it's time to cut the groove for the belt. This was the only two-person job on the project. Mount a 'V' bit in your trusty router and clamp its base to a scrap of 1x8 to use as a steady rest. Then, while your assistant (In my case, my wife Sue) slowly rotates the wheel, ease the bit into the center of its outer edge. After several rotations you should have a nice groove deep enough to keep the belt in place. This technique results in a groove that may appear to wander a bit in relation to the edge of the rim due to the flywheel not being absolutely flat or perhaps some minor error in hub alignment, but the groove should be true to the center of rotation, which is what you are after. I didn't sand the groove, preferring to leave it a bit rough for belt 'traction'.

If you don't have access to a router you could set up a similar system to hold a course rat-tail rasp in place of a router. Hold the rasp against the center of the rim while your assistant spins the wheel to form the channel. The end result is that the belt runs true and does not slip on the flywheel at all.

Flywheel Close-up

Make Your Own Treadle Lathe



Flywheel Hub Close-up

Make Your Own Treadle Lathe



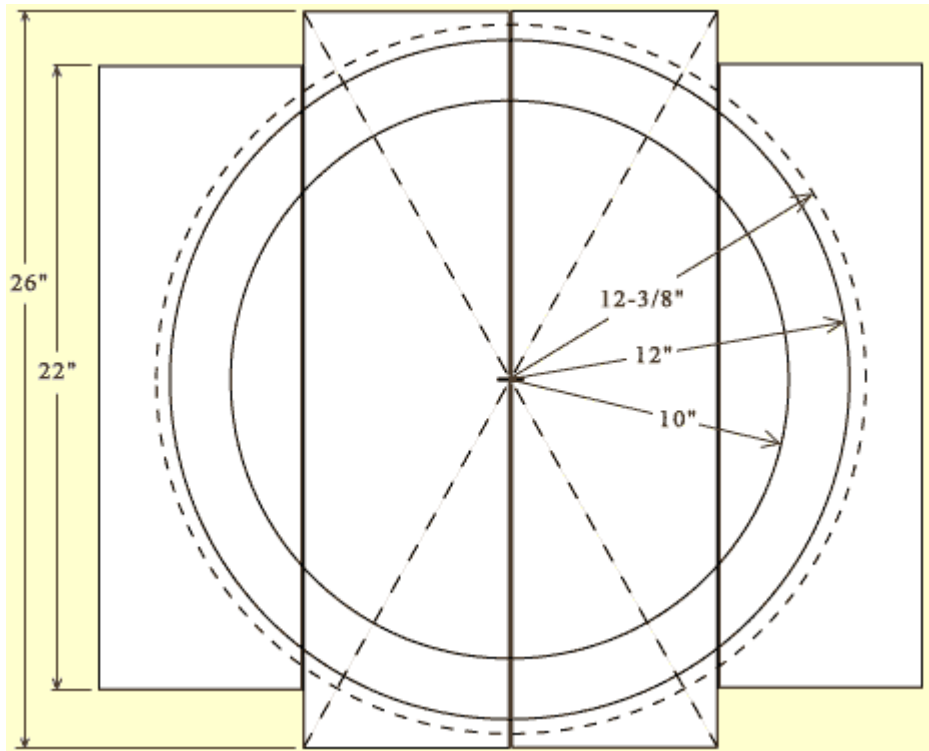

I'll not try to give a lesson in wood turning here but highlight some of the things which I've found unique to this type of lathe. It might also be helpful to mention some of the non-turning uses we've come up with.

Using a treadle lathe is initially an exercise in hand/foot coordination. If you have ever used an old treadle sewing machine you have a leg up, so to speak. The major difference is that on the lathe you also have to support your weight on your non-pumping leg.

Direction of Rotation

Another similarity to the sewing machine is that you have to motivate the work to turn in the right direction. Depending on crank position when you begin, there is a 50-50 chance that the work will turn away from you rather than toward you. This 'feature' can be put to good use when finish sanding. Only the most expensive powered lathes can be reversed to help remove those pesky little fibers that lie down in the direction of rotation. On a treadle lathe, just give the work a bit of a boost in the desired direction as you begin and go at it.



Positioning the stock

Since the tails stock on my lathe has no lateral adjustment for securing the work piece, a special technique is used. Start out by cutting an 'X' across the driven end and punching a significant dimple in the center of the tailstock end of the piece. Press the stock firmly against the drive center and slide the tailstock up until it will just hold the piece in place. Then slide the tailstock a bit farther towards the headstock (it is now angled backwards slightly) and firmly tap in the securing wedge. How hard you hit the wedge determines how tight the stock is secured in the lathe. All this becomes second nature and takes just a moment to do.

Non-Turning Uses

Although the lathe is used for an occasional turning demonstration, these days it spends most of its time right where it is in the photo above... in our traditional tool shop. I use it occasionally to turn a special project but its primary use is as a power source for sanding. We make hand carved wood spoons during the long winters here in Michigan's Upper Peninsula and use the lathe to help sand the insides of the spoon's bowls. I remove the drive center and replace it with a ½" geared drill chuck. Various shop-made sanding disks are fitted into it and the unit speeds up that part of the spoon-making process considerably. So, the spoons are technically hand carved and foot sanded.



I have tried running a flexible shaft from the lathe but found little advantage over just chucking the sanding disk directly in the lathe. Both felt and lambs wool buffing pads also work well. It is quite easy to adjust the lathe speed to match the needs of your work just by peddling harder/softer or adjusting the pressure of the work against the sanding or buffing tool.

Did you find this information helpful?

I hope that the information and ideas I've shared with you here have been of value to you. If you do build a treadle lathe, I'd enjoy hearing how it turned out? You can contact me at:

Steve Schmeck
770N Fox Road
Cooks, MI 49817
OR
steve@manytracks.com

