

energy for the future

EXPERIMENTS YOU CAN DO...FROM EDISON

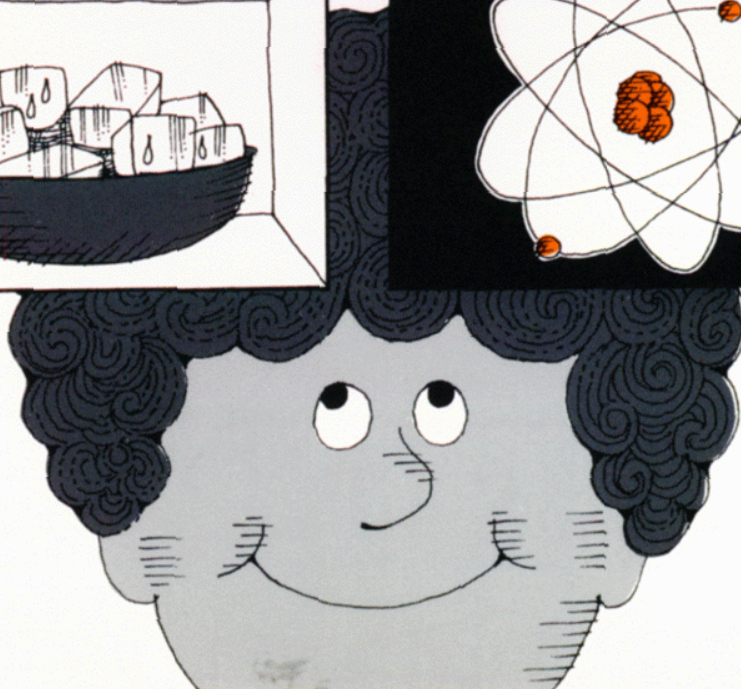

We are grateful to the General Electric Company for providing the assistance for the initial publication of this booklet, *Energy For The Future, Experiments You Can Do... from Edison.*

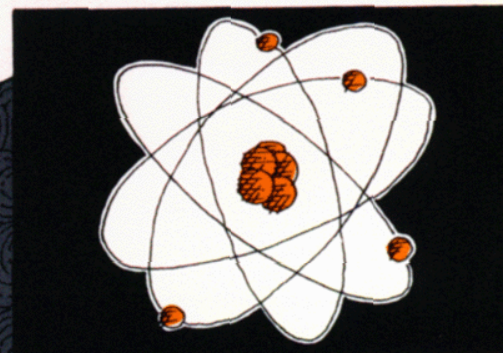
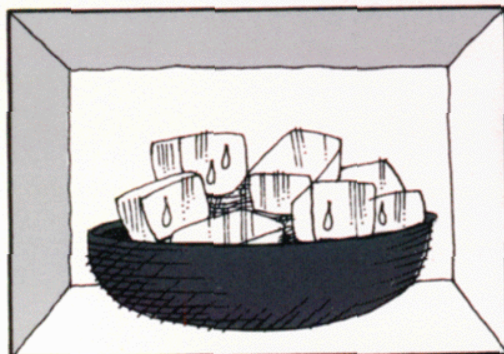
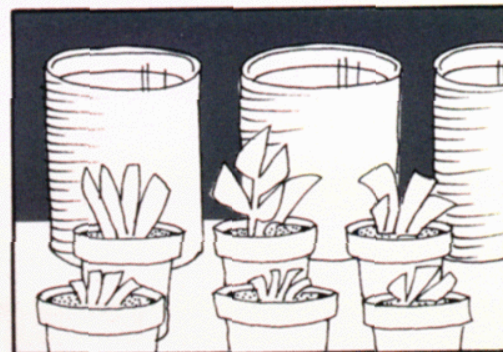
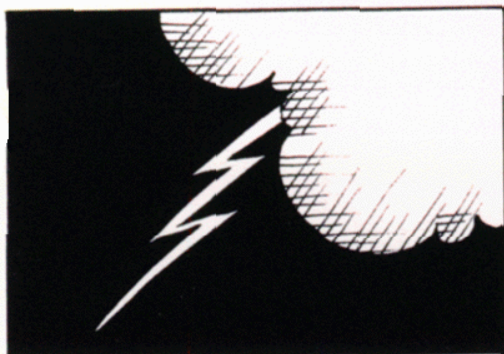
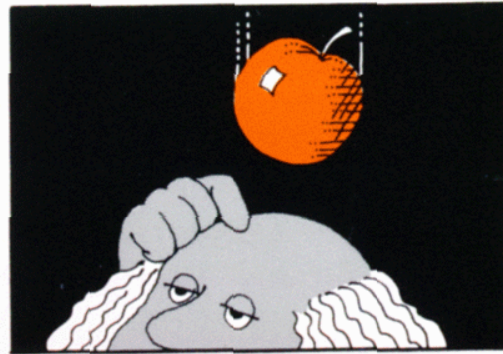
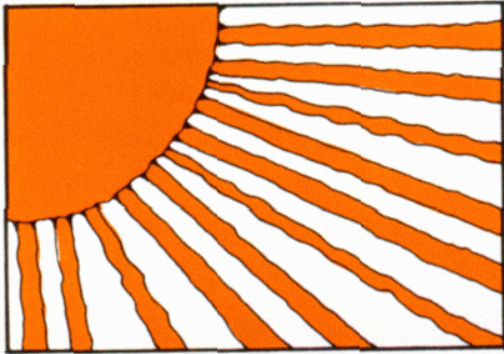

A PUBLICATION OF THE

THOMAS ALVA EDISON FOUNDATION

CAMBRIDGE OFFICE PLAZA, SUITE 141
18280 WEST TEN MILE ROAD
SOUTHFIELD, MICHIGAN 48075

ADVANCING SCIENCE, TECHNOLOGY AND ENGINEERING EDUCATION

energy for the future

EXPERIMENTS YOU CAN DO. . . FROM EDISON

Text, Design, and Illustrations

by

CopyWrite Publications

© 1983, Thomas Alva Edison Foundation, Inc.

TO THE YOUTH OF AMERICA

Thomas Alva Edison was awarded 1093 patents during his lifetime. No other man of the 19th Century did as much to change the face of America, to create the wealth of America, and to improve the living standards of the nation and, indeed, the world. He gave us the incandescent light bulb, the phonograph, the stock ticker, the motion picture camera and the feeder-and-main method of distributing electricity, to name only a few of his inventions.

In spite of all these contributions to society, when asked in later life to reflect back over the years and decide what he considered his greatest invention, Edison unhesitatingly replied, “the commercial laboratory.”

He was the first to systematically organize experimentation, and it was experimentation that was the backbone behind all of his inventions. Experimentation was what Edison was referring to when he said that inventing is “10 percent inspiration and 90 percent perspiration.”

Today, most of the world’s inventions are coming from commercial laboratories, where, thanks to modern technology, experimentation is reaching new levels of organization and speed. Much of the emphasis now, however, is upon the conservation of and finding new sources for the energy Edison’s inventions made so popular. In Edison’s day no one gave much thought to the fact that someday our energy sources might be used up.

This booklet will show you how you can apply the same basic method used in the world’s greatest laboratories, the method Edison relied upon so heavily — that is, the experiment — to learn more about how to conserve energy and what new sources may someday be utilized to generate it.

**Board of Trustees
Thomas Alva Edison Foundation**

CONTENTS

BEFORE YOU BEGIN	4
------------------------	---

SECTION I

Getting the Facts	7
EXPERIMENT 1:	
Your Home and the Forces of Nature	8
EXPERIMENT 2:	
A Basic Home Energy Audit	10
QUICKIE EXPERIMENT "A"	11
QUICKIE EXPERIMENT "B"	13

SECTION II

Conserving Energy	15
EXPERIMENT 3:	
Can You Use Electricity More Wisely?	16
QUICKIE EXPERIMENT "C"	19
EXPERIMENT 4:	
Building and Weatherizing a Model House	20
QUICKIE EXPERIMENT "D"	24
QUICKIE EXPERIMENT "E"	25

SECTION III

Solar Energy	26
EXPERIMENT 5:	
Converting to a Solar Garden	27
QUICKIE EXPERIMENT "F"	32

BEFORE YOU BEGIN...

Before you begin the experiments in this book, take a minute to think about energy. What is it? Where does it come from? What is it used for? And why are people all over the world so concerned about the “energy crisis”?

In simple terms, energy is the ability to do work. There are many forms of energy: radiant (which includes light), thermal, chemical, mechanical, electrical, nuclear, and gravitational. Energy itself is never consumed (that’s the First Law of Thermodynamics); it’s only changed from one of these forms to another.

The problem is, whenever it changes form, some of it is “lost.” It changes into unuseable heat, which dissipates and gradually warms up the earth’s atmosphere (and that’s the Second Law).

As an example, look at all the changes energy could undergo in order to light your living room tonight (see page 5).

Conversions Mean Lost Energy

The more conversions there are between the primary source of energy and its final use, the greater the waste. Some machines and processes not only use more energy, they also require more conversions before the energy is finally used. In 1979, the United States *wasted* more energy than it had both used *and* wasted in 1960. This is one reason behind the energy crisis.

Another reason is our dependence on fossil fuels, especially oil and natural gas, as our primary supply of energy. These resources were created millions of years ago. Unlike sunlight, wind, water, or living plants, they cannot be replaced. You can grow another tree, but once a barrel of oil is gone, it’s gone forever.

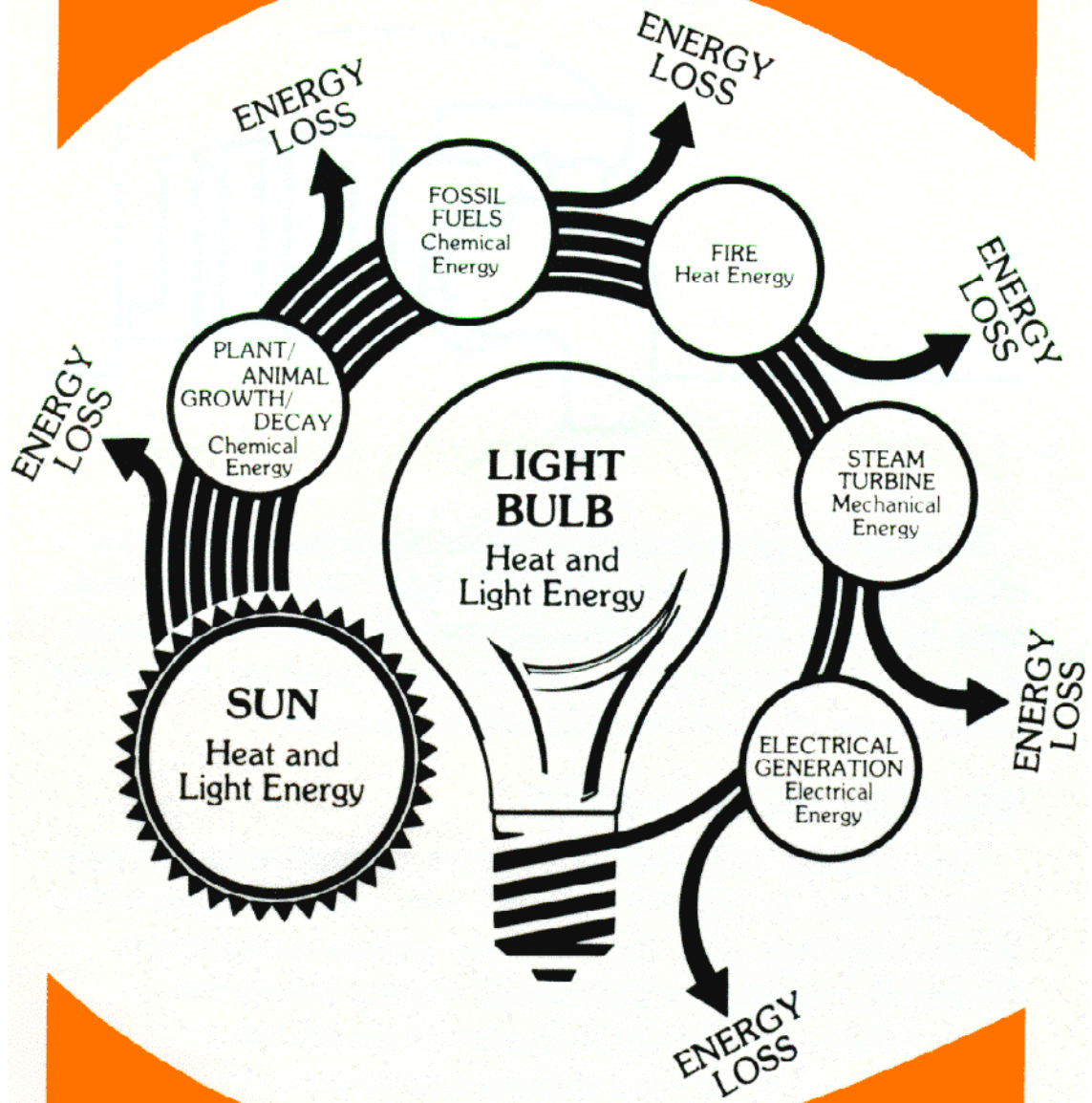

So now the race is on to find substitutes for oil and natural gas before these sources dry up or become so scarce that few people can afford them. It's a race against time. Some experts predict, for example, that the United States oil reserves will be used up by about the year 2035. They're the optimists. The pessimists are predicting 1998!

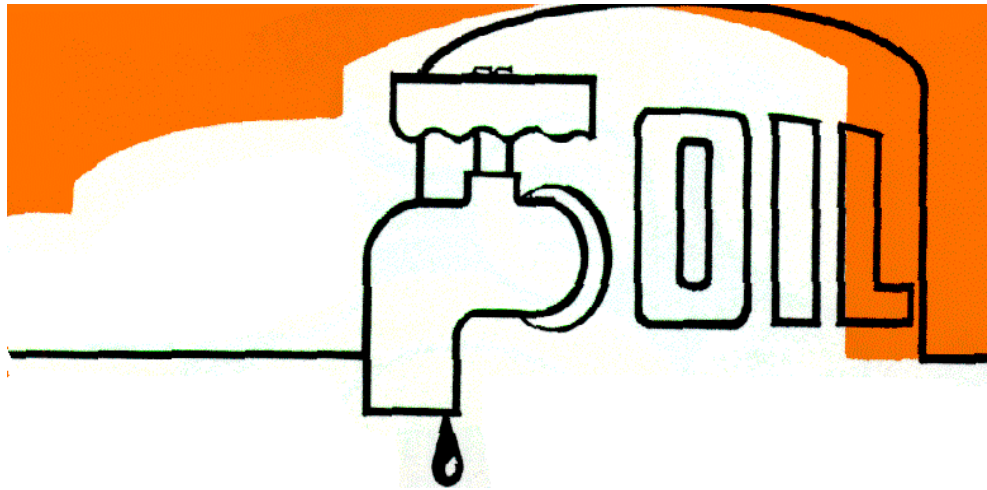

And this brings us to energy conservation today. Every bit of oil or gas energy we save now will “buy” us that much more time to come up with other sources to generate electricity, power our transportation systems, and produce the many products we all have come to take for granted.

What Can We Do to Help?

This booklet will give us a better understanding of how energy is lost. In Section I you will take a look at some of the factors affecting your own family's energy consumption. In Section II you will investigate some ways to reduce that energy consumption. And, finally, in Section III we will talk about solar energy — one of the most exciting and versatile alternatives to oil and natural gas.

We hope you will have fun doing the experiments — and learn something too, of course. But more than that, we hope these exercises will raise your “energy awareness” so that you will be constantly on the alert for ways to save or avoid wasting energy in your daily life.

SECTION I Getting the Facts

The first step in deciding how to conserve energy is to identify some of the major factors that cause you to lose — or help you to save — energy in your home. Only then can you develop a logical plan to cut your losses.

Here are two experiments that will help you discover how energy is being lost right now in your own house.



EXPERIMENT 1: Your Home and the Forces of Nature

You will need: compass and pencil.

There is not much you can do about your home's location, especially since moving houses is an expensive and tricky proposition. But knowing how that location affects energy usage can be valuable when you're beginning your energy audit in the next experiment.

First, determine the orientation of your house and how the weather forces act upon it, as shown in the drawing on page 9.

Using the compass, locate the points at which the sun rises and sets. You can also obtain information about the directions of the winds and storms that affect your area by calling your local weather bureau, the state agricultural extension service, or news agencies. Then sketch in the areas of your house that are used most — like the kitchen, dining room, and rec room.

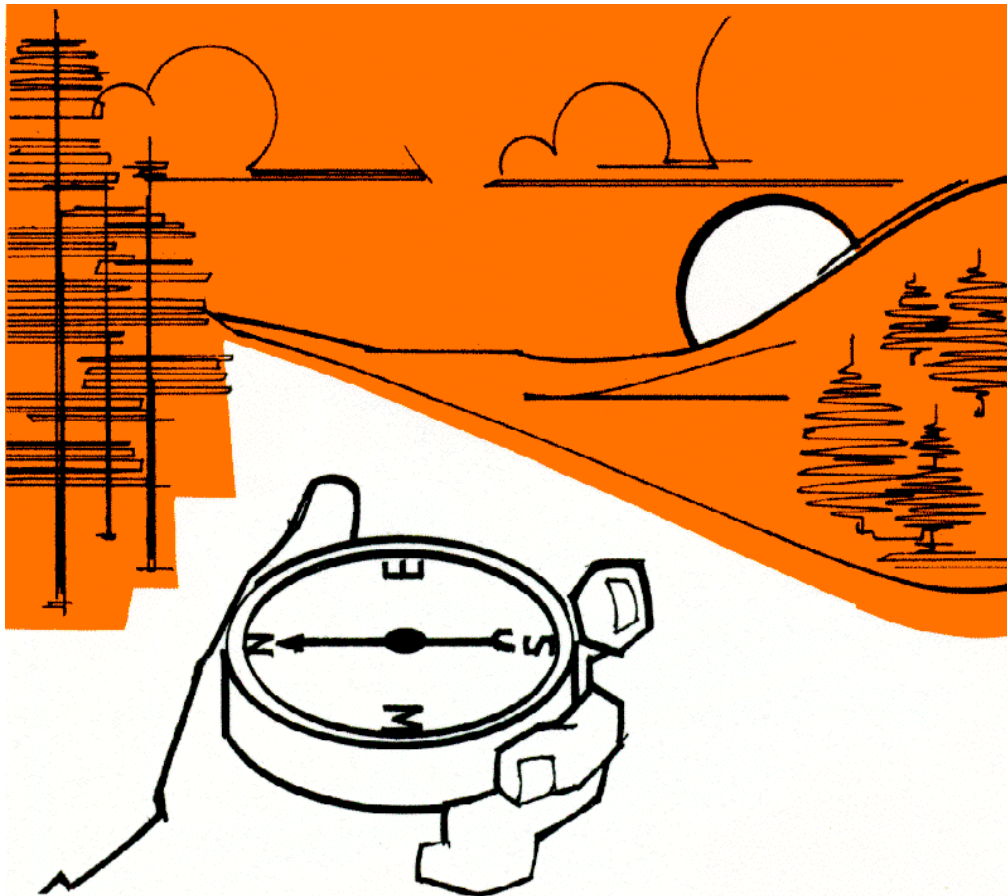

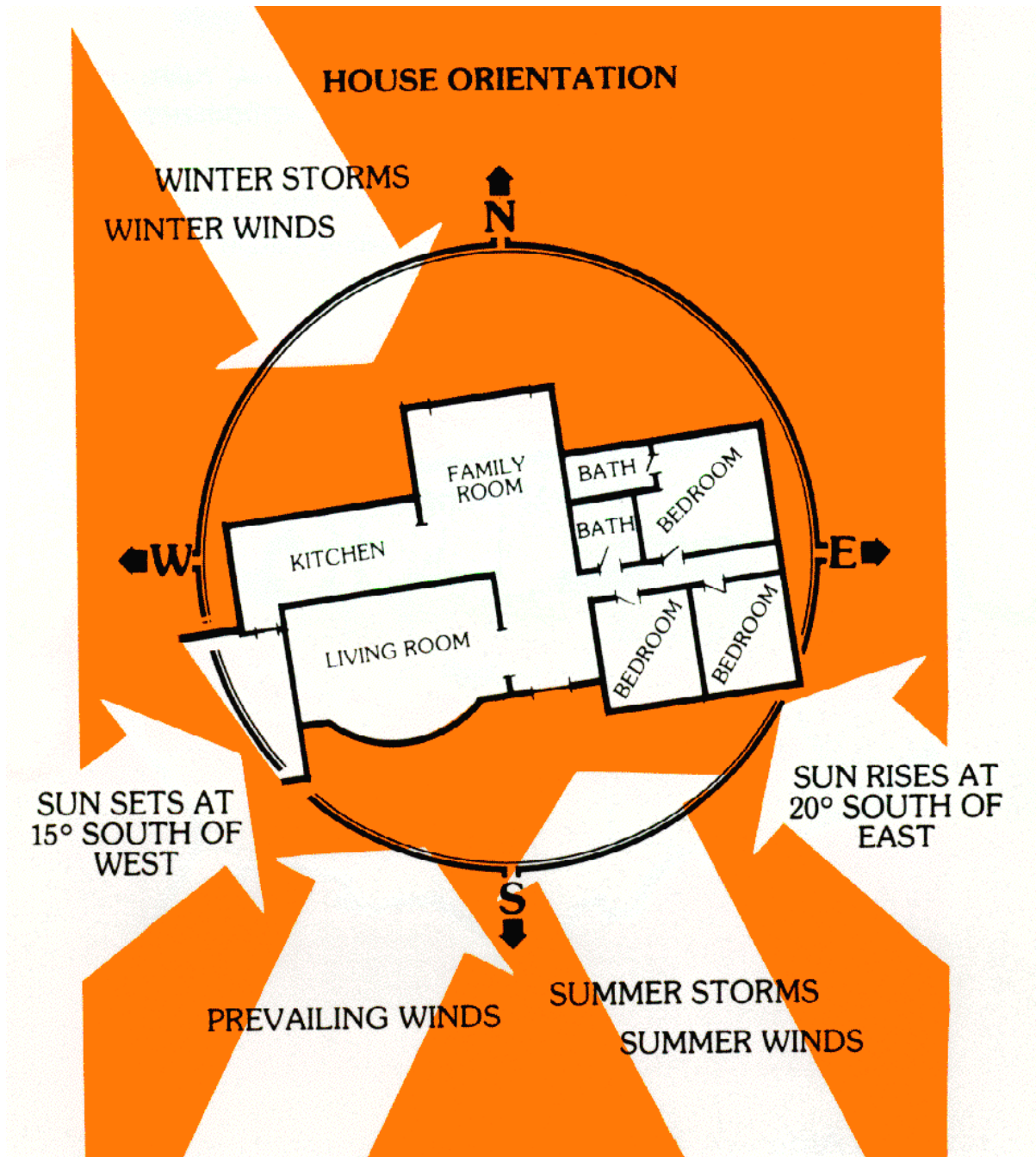

Now take a few minutes to think about the orientation of your house to the forces of nature. If your house is in a northern area, for example, shrubbery along the northernmost wall might give it more protection from winter storms. Are there drapes or curtains in front of windows exposed to the winter winds? Could anything be done to your home to give it more protection?

EXPERIMENT 2: A Basic Home Energy Audit

You will need: pad and pencil, flashlight, gloves, ruler, draft detector (see Quickie Experiment "A"), two thermometers, and tape.

First, find your geographical location on the map below to determine the approximate inches of ceiling insulation recommended for your temperature zone.

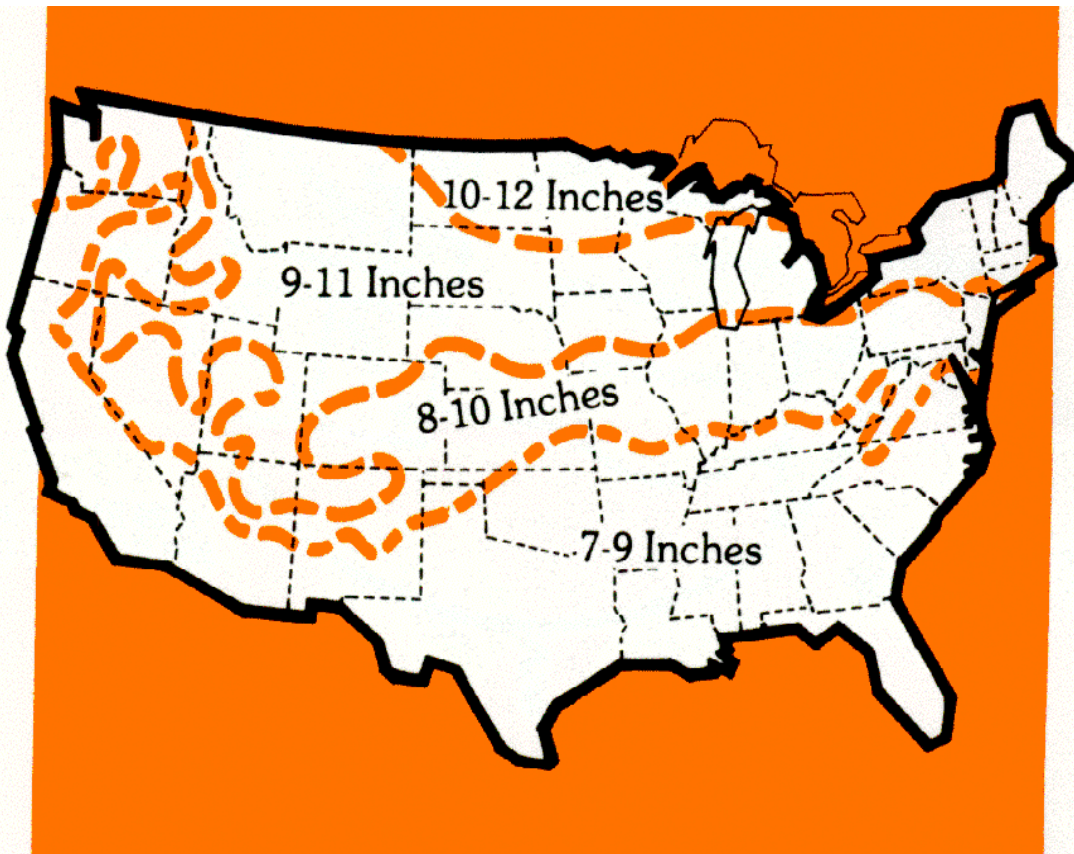

In the Attic

- Measure the depth of insulation between ceiling joists. Remember to wear gloves whenever you handle insulation.

If you already have the recommended thickness of insulation or more, score 30 points. If you have two inches less, score 25; four inches less, score 15; six inches less, score 5. If you have less than two inches of insulation, score 0. _____

In the Living Areas

To investigate these areas, you will need a draft detector. So...

QUICKIE EXPERIMENT "A" Making a Draft Detector

Cut out a piece of clear plastic food wrap about 5" x 10". Tape the 5" end to a short stick so the long end hangs freely. For the stick, you could use a pencil or ruler (but a baseball bat probably wouldn't be a good idea).

That's your draft detector. Notice that even when you blow ever so lightly, the plastic detects the movement of air.

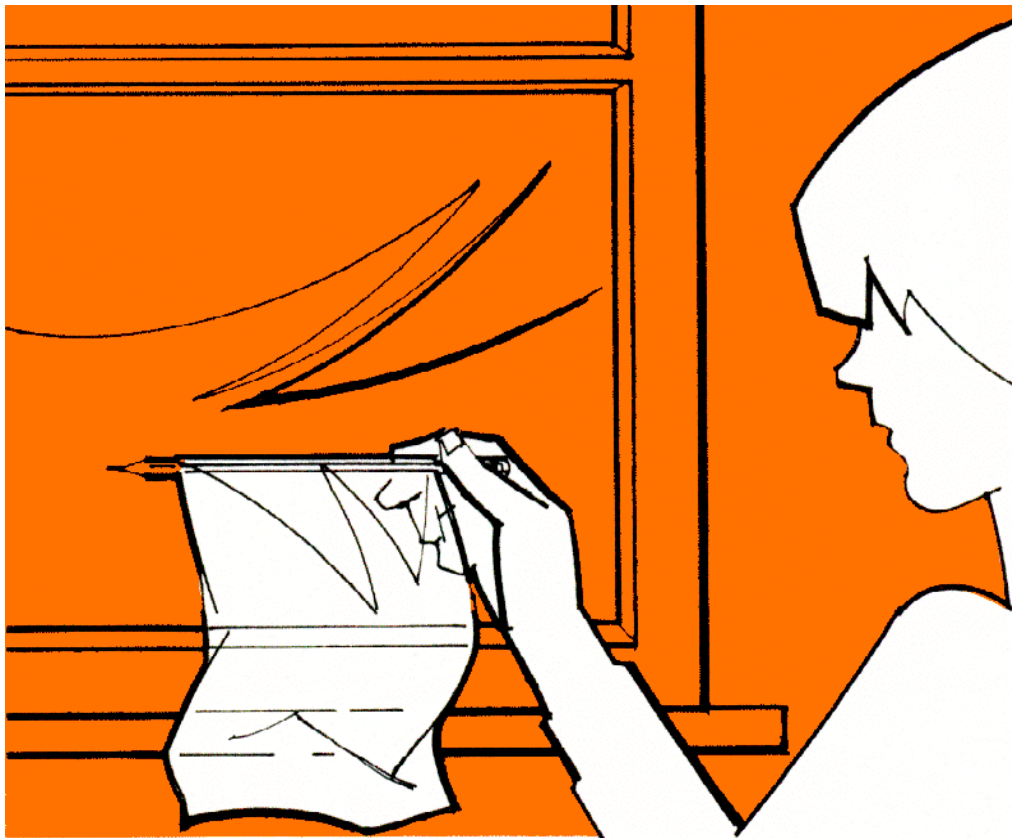

- Check for drafts by holding the draft detector about an inch from where windows and doors meet their frames.

If there is no draft around your windows, score 10 points. If there is a draft, score 0. _____

If there is no draft around your doors, score 5 points. If there is a draft, score 0. _____

- If you live in an area where the temperature often falls below 30°F and you have storm windows, score 20 points. If you do not have storm windows, score 0. _____

- Test your wall insulation by taping one thermometer to an outside wall and taping another in the center of the same room (say, to a chair back). Make sure the thermometers are at the same height from the floor. Read the thermometers after four hours.

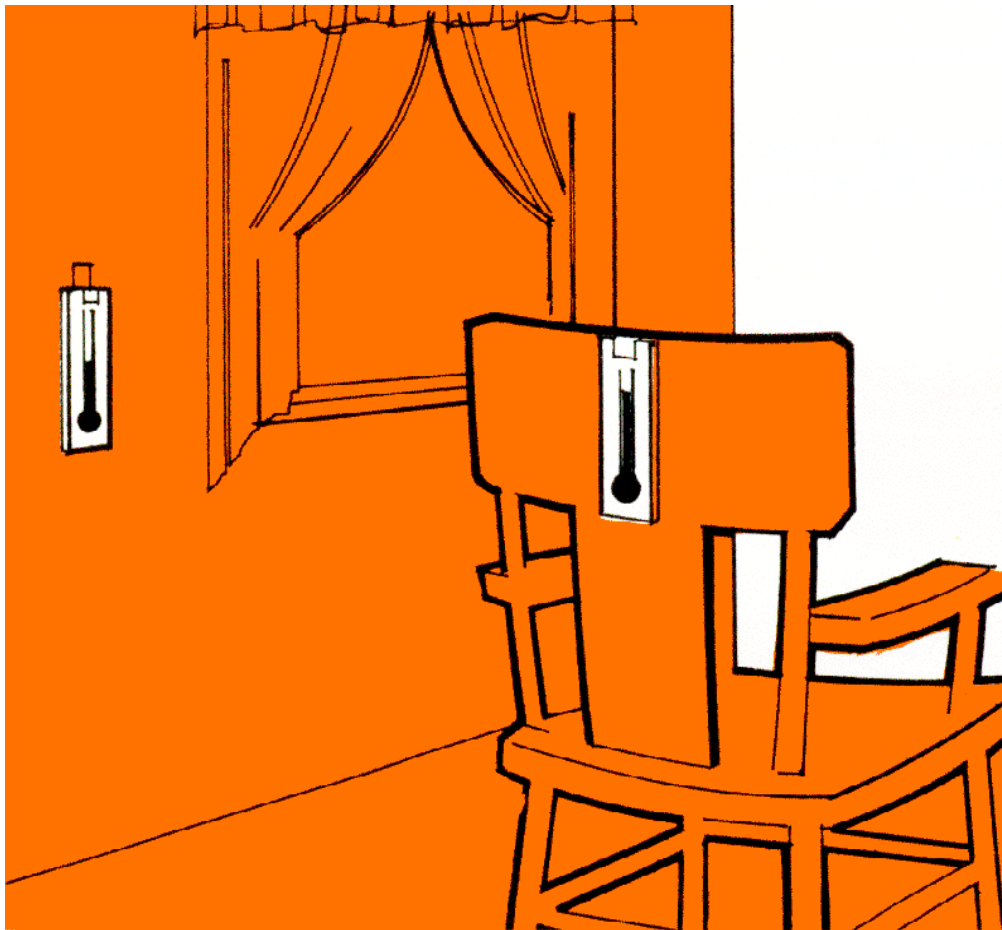

If there's less than five degrees difference, score 10 points. If the outside wall reading is more than five degrees below the inside reading, score 0. _____

- Do you have a fireplace? If not, add 4 points. If you have a fireplace and always keep the damper closed when it is not being used, add 4; if you leave the damper open when the fireplace is not in use, score 0. _____

Now, time out for a little test.

QUICKIE EXPERIMENT "B" That Hole in the Roof

For a dramatic demonstration of how much heat is lost up the chimney in the winter, check the fireplace with your draft detector. Start with the damper open, then with it closed. You'll be amazed. The escaping heat is like money going up in smoke.

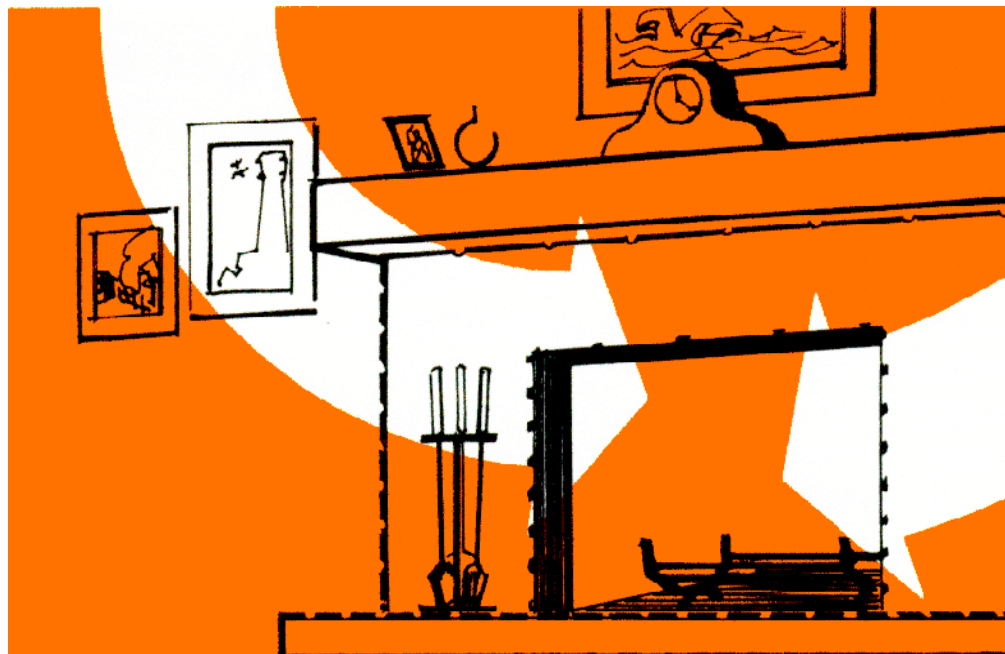

In the Basement

- If you have a heated basement or if there is no space under the house, score 10 points. If you have unheated space under the house and there is insulation under your floor, score 10; if there is no insulation score 0. _____

Your Energy Conservation Habits

- In winter, if your thermostat is set at 68°F or less during the day, score 6 points. Deduct one point for every degree over 68. If your thermostat is set over 70, score 0. _____

- If you set your thermostat back to 60°F or less at night during the winter, score 10 points. Deduct one point for each degree over 60. If your thermostat is set at 66 or above, score 0. _____

- If you do not have air conditioning, score 7 points. If you have air conditioning and you keep the temperature setting at 78°F or above in summer, score 5. Deduct one point for each degree below 78. If your air conditioning is set below 76, score 0. _____

- If your water heater is set below 120°F, score 10 points. If it is set between 120 and 140, score 5. And if it is set above 140, score 0. _____

TOTAL _____

IF YOUR SCORE ON THIS HOME ENERGY AUDIT IS LESS THAN 100, THE MEMBERS OF YOUR HOUSEHOLD PROBABLY COULD TAKE SOME STEPS TO MAKE THE HOUSE MORE ENERGY EFFICIENT—AND SAVE SOME MONEY IN THE PROCESS. WHY NOT HAVE EVERYONE MAKE SUGGESTIONS, AND THEN LET THE GROUP VOTE ON THEM.

SECTION II

Conserving Energy

Now that you know how you are using energy in your own home, you can begin looking for ways to cut down on the amount you use.

Try this for a start: Simply use more wisely some of the things in your home that are run by electricity. Or, when considering a purchase of an electrical product, compare the energy-saving features of various product makes and models.

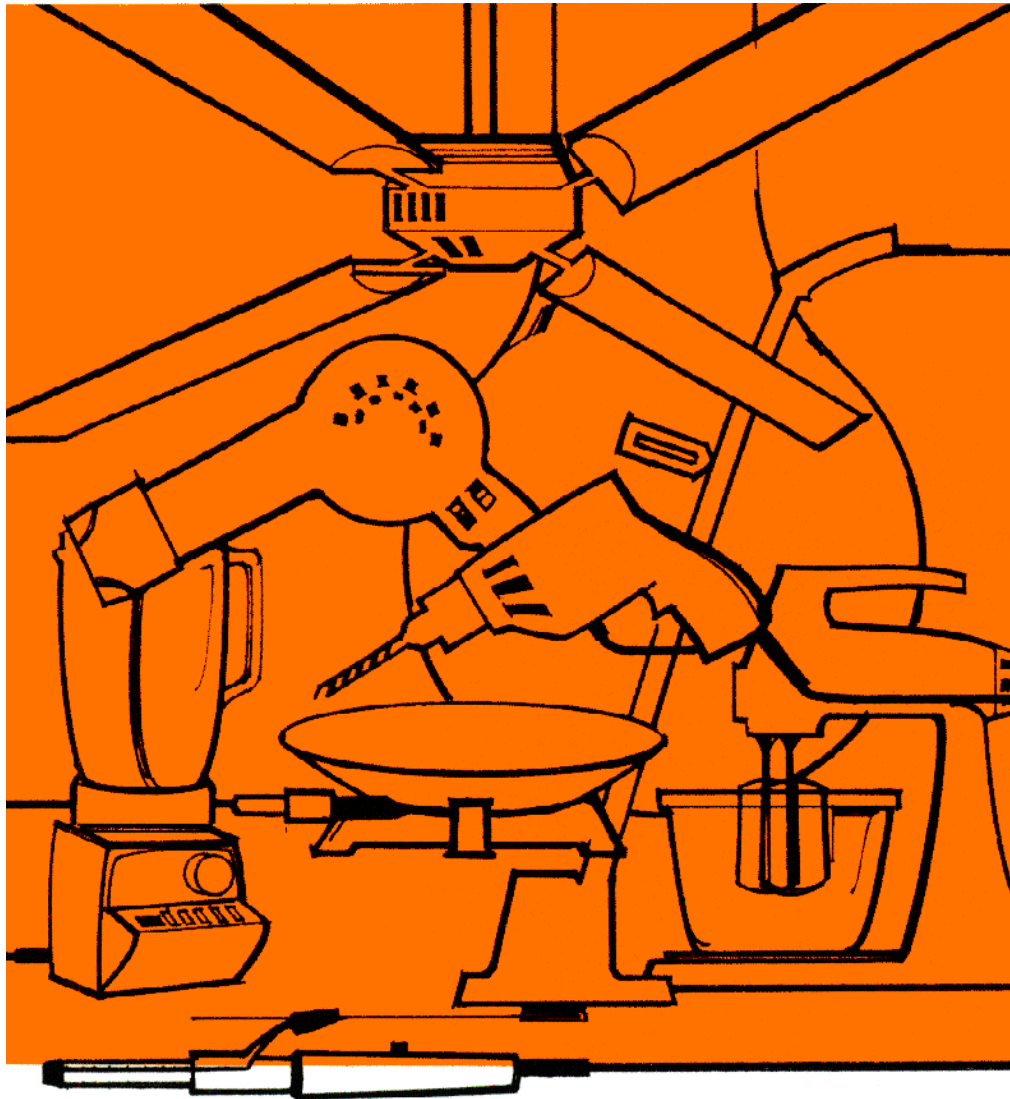

EXPERIMENT 3: Can You Use Electricity More Wisely?

You will need: pad and pencil, and cooperation from everyone in the house.

Get together with the rest of the family and go over the list of common electrical appliances below (of course, just the ones you have in your house); add anything pertinent you may have that is not on the list.

Which could you use less often and still be comfortable? Put a check in the column on the chart that best describes your family's attitude about each appliance. A simple majority could determine the family vote.

Electrical Appliances We Can Use More Wisely

	Very Easily	Easily	With Some Difficulty	With Great Difficulty	Im- possible
Air conditioner					
Blanket(s)					
Blender					
Calculator					
Can opener					
Carving knife					
Clock(s)					
Clothes dryer					
Clothes washer					
Curling iron					
Dishwasher					
Fan(s)					
Freezer					
Frying pan(s)					
Game(s)					
Garbage disposal					
Hair dryer(s)					
Hot water heater					
Ice crusher					
Ice cream maker					

Electrical Appliances We Can Use More Wisely

	Very Easily	Easily	With Some Difficulty	With Great Difficulty	Im- possible
Iron					
Lights					
Microwave oven					
Mixer					
Popcorn machine					
Power tool(s)					
Radio(s)					
Range					
Refrigerator					
Space heater(s)					
Stereo/Record player(s)					
Television(s)					
Toaster					
Toothbrush(s)					
Trash compactor					
Typewriter					
Vacuum cleaner					

Agreeing on the list was the hard part; the rest of the experiment is less difficult.

First, you should know how to read electric meters. Electric meters measure the number of kilowatt-hours (KWH) consumed. Most have four or five dials, each numbered from 0 to 9. To read the dials, write down the number the pointer has just *passed*. Be careful to note whether the dial reads clockwise or counterclockwise.

Look at the examples on page 18 and make sure you understand how the readings were made. (Four-dial meters do not measure individual KWH units, so you'll have to add a 0 as the last digit in your reading.)

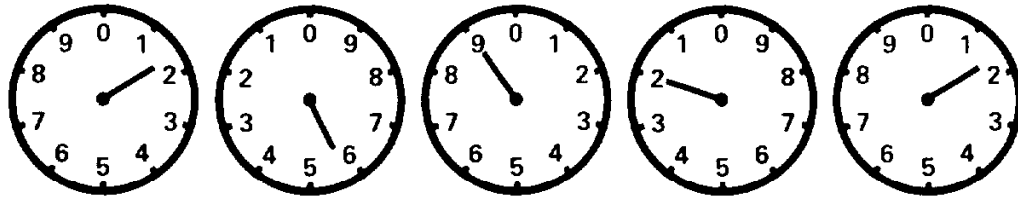

Reading = 15921

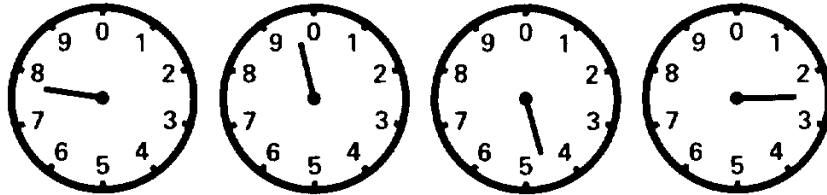

Reading = 79420

Keep a chart like the one below to measure your electricity usage. To determine how much your family uses during a normal week, subtract the reading you take at the beginning of the week from the reading you get at the end.

	Reading (KWH)	Use (KWH)
Reading on <u>October 31</u>	<u>15,921</u>	<u> </u>
<u>November 7</u>	<u>79,420</u>	<u>63,499</u>

Now for the energy-saving experiment. Begin by taking a meter reading. Then have the family avoid using all the appliances in the “Very Easily” column. After a week, read the meter again and enter the reading on the chart. Do you see a big drop over a normal week’s usage? Probably not. The appliances in this column are likely to be the ones that don’t get used much anyway.

So for the next week, ask the family to avoid using appliances in both the “Very Easily” and the “Easily” columns. Take your meter reading at the end of the week, log it, and see if there’s a drop. And for the third week, ask the family not to use the items from the first three columns of the list. And so on.

By the end of the experiment you should see some reduction in the amount of energy used per week. This assumes that the

weather stays about the same and the energy used by the appliances that were still plugged in did not change drastically during the experiment.

While running this experiment, remember to make allowances for other factors. During holidays, for example, major appliances tend to be used a lot more than usual — or a lot less. And a sudden cold snap or hot spell could mean that any savings were hidden by the increased use of your central heating system or air conditioning unit. Even normal variations in usage may hide real reductions. So don't be discouraged if your tests show smaller savings than you expected. Think of how much higher your readings would have been if *all* the appliances were being used.

After this experiment your family may decide to test other energy conservation measures (like turning down the room thermostat or the setting on the hot water tank) to see how those measures affect energy consumption.

Before we leave the subject of using less energy in the home, here's a simple demonstration of how to conserve heat when cooking:

QUICKIE EXPERIMENT "C" A Cover Is Like a Blanket

Pour two cups of water in a pan and set the pan on a hot range burner. Note how long it takes the water to boil vigorously.

Empty the pan and let it cool. Then repeat the steps above. Only this time, put a cover on the pan. You'll know the water is bubbling away when the cover starts rattling.

Did the covered water come to a boil faster? Is it worth using a cover when boiling? Now you know.

EXPERIMENT 4: Building and Weatherizing a Model House

You will need: one 4' x 8' sheet of ¼" plywood, finished one side; about 100' feet of 1" x 2" furring strip; one pound of 1½" nails; about 9 square feet of foam pads (¾" thick) for insulation; a small bag of loose insulation; a 9' x 12' heavy-duty clear plastic dropcloth; thumb-tacks; glue; tape; 8' of adhesive-backed weatherstripping ¾" wide; and a saw, hammer, and pair of pliers.

Your home loses heat in winter (or gains it in summer) in two main ways. *Conduction* occurs when heat moves directly through ceilings, walls, and windows from the warmer to the cooler side. *Insulation* makes a big difference in fighting conduction. Infiltration occurs when cold air leaks in while hot air leaks out (or vice versa) through cracks around doors and windows, or in the foundation or siding. Weatherstripping and caulking, especially around doors and windows, stop excessive infiltration.

In this experiment you will build and weatherize what is practically a model of a real, one-story house. In Experiment 5, we will convert that house into a small solar garden. These experiments will illustrate some important energy principles.

As you can see, the experiments will require a considerable amount of wood and effort (and probably some occasional advice). Therefore, you may want to consider teaming up with some friends to share the work and the expense. The model house and solar garden would make an excellent class project, especially if you could use the school workshop.

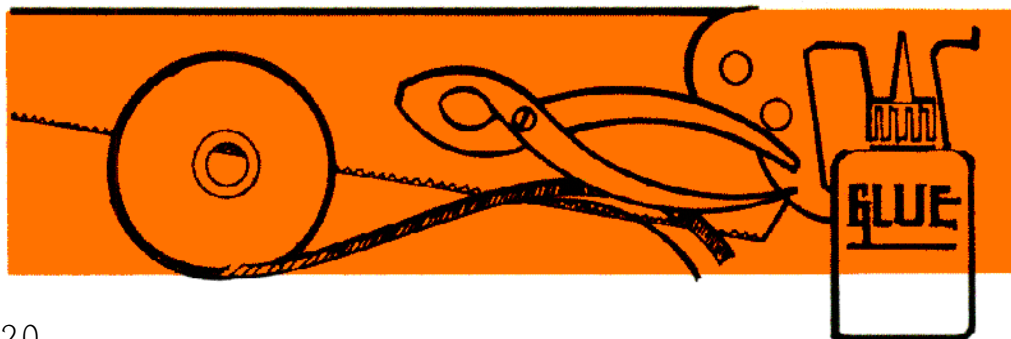

CUTOUT PATTERN FOR 4' x 8' PLYWOOD SHEET
 (Cut Each Piece as Needed)

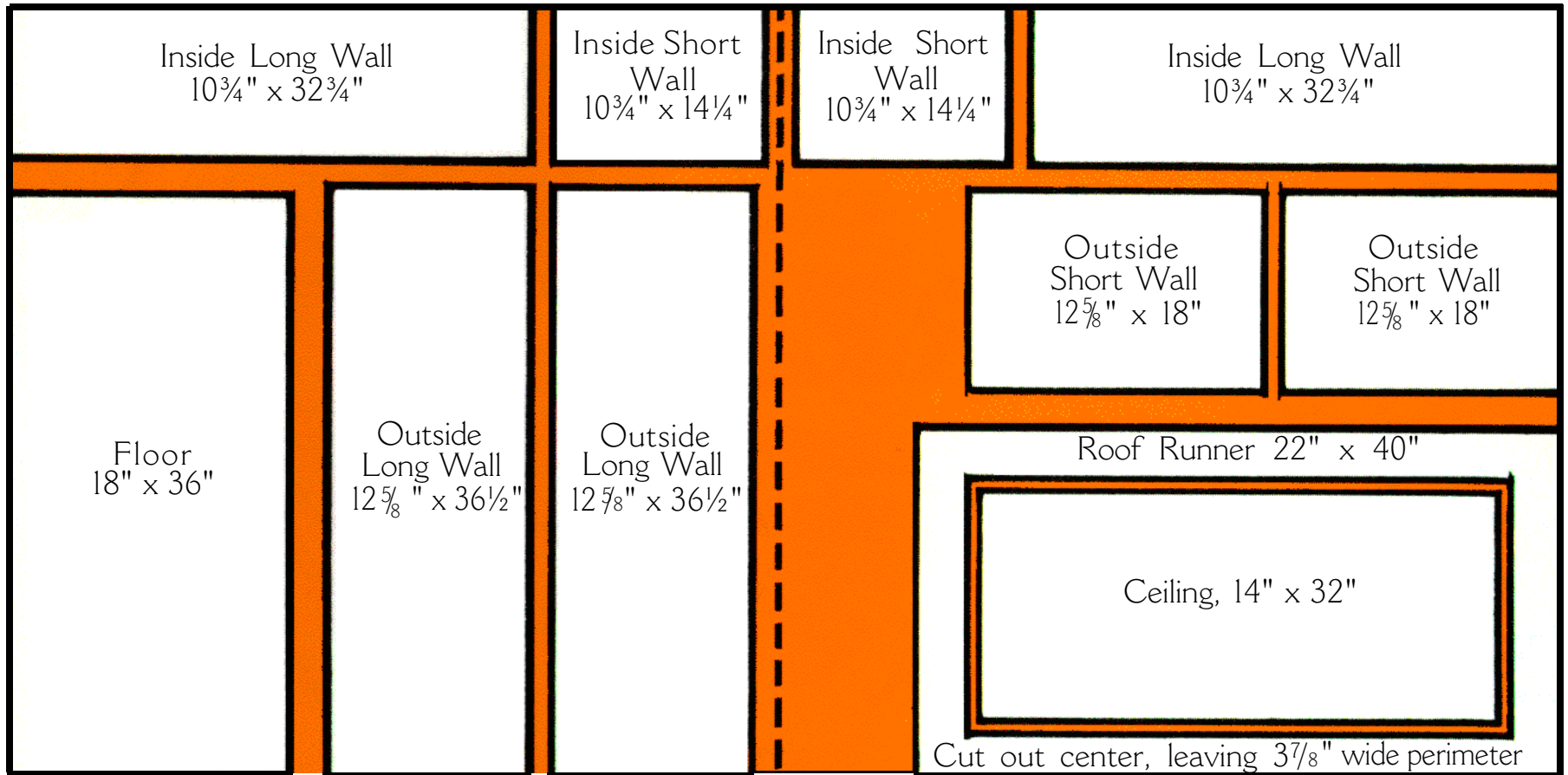

Note: Sheet may be cut into two 4' x 4' sections at the lumber yard for easier transporting.

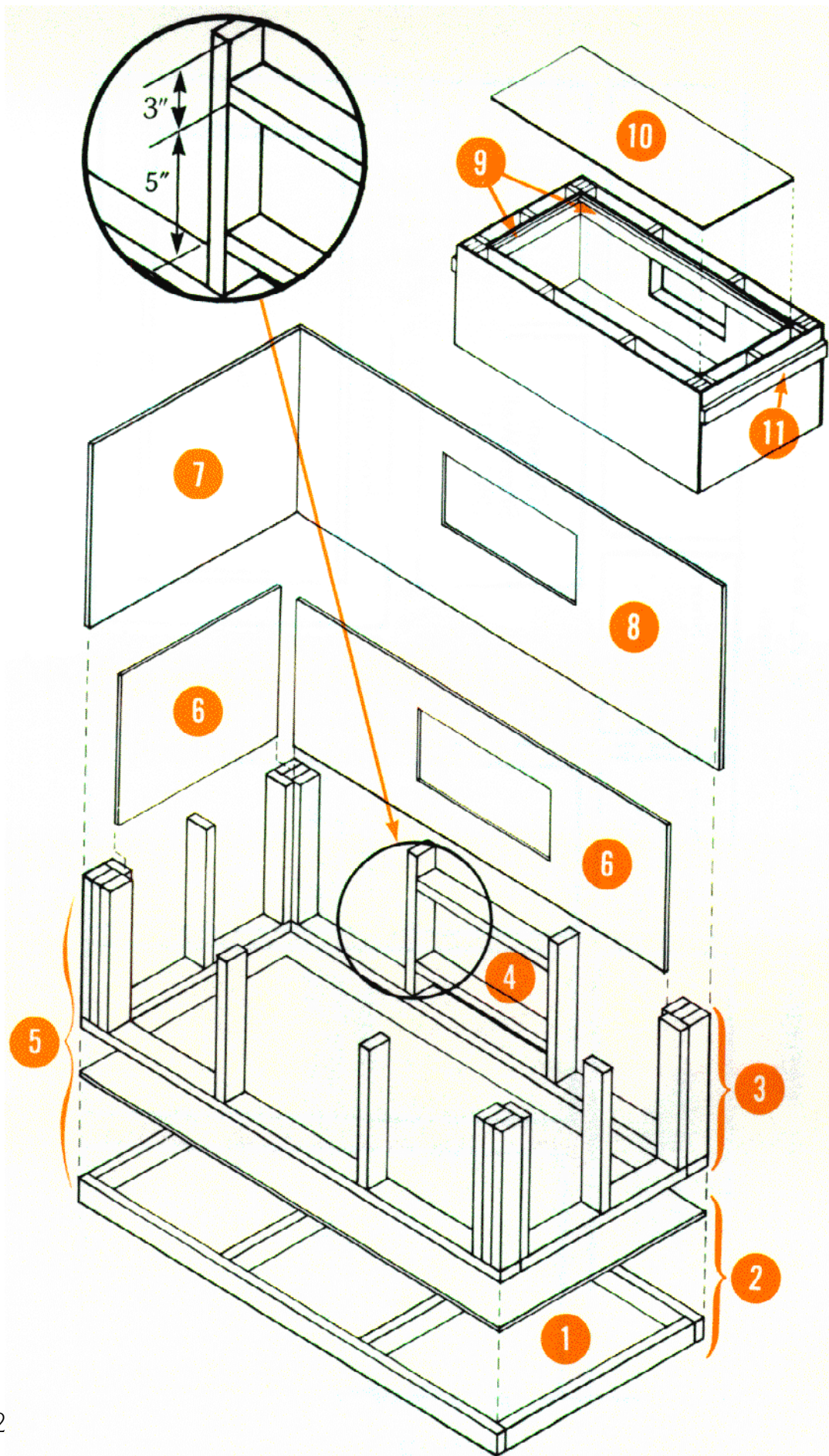

OK, let's get started. The numbered instructions below pertain to the numbered items on the drawing. Read them carefully. Good luck and happy hammering.

- 1 MAKE THE FOUNDATION.**
 - 4 pcs. furring 16½" long
 - 2 pcs. furring 36" long
- 2 PLACE FLOOR ON FOUNDATION (don't nail it down yet).**
 - 1 pc. plywood 18" x 36"
- 3 CONSTRUCT WALL FRAMES BY ERECTING STUDS ON SOLE PLATES (nail corner studs together first, then anchor studs by nailing upward through sole plates; allow 11¼" between window studs).**
 - 2 pcs. furring 14¾" long } (the sole plates)
 - 2 pcs. furring 36" long }
 - 22 pcs. furring 10" long
- 4 NAIL WINDOW FRAMES BETWEEN WINDOW STUDS.**
 - 2 pcs. furring 11¼" long
- 5 NAIL WALL-FRAME ASSEMBLY AND FLOOR TO FOUNDATION.**
- 6 HOLD AN INSIDE WALL AGAINST WINDOW STUDS AND TRACE WINDOW OPENING WITH A PENCIL. SAW OUT WINDOW OPENING. STRETCH PLASTIC OVER OPENING ON BOTH SIDES OF WALL AND SECURE WITH TAPE AND THUMBTRACKS. NAIL INSIDE WALLS TO STUDS (install long walls first).**
 - 2 pcs. plywood 10¾" x 32¾"
 - 2 pcs. plywood 10¾" x 14¼"
 - 2 pcs. plastic sheet 7" x 13"
- 7 NAIL OUTSIDE SHORT WALLS TO STUDS.**
 - 2 pcs. plywood 12⁵/₈ " x 18"

- 8 MAKE WINDOW OPENING AND COVER WITH PLASTIC AS IN STEP 6. BEFORE NAILING WALLS TO STUDS, FILL CAVITY BELOW WINDOW WITH LOOSE INSULATION.**
 - 2 pcs. plywood 12⁵/₈" x 36¹/₂"
 - 2 pcs. plastic sheet 7" x 13"
 - Loose insulation- enough to fill
- 9 NAIL CEILING SUPPORTS ON INSIDE WALLS (align bottom edges with top of window opening).**
 - 2 pcs. furring 32¹/₄" long
 - 2 pcs. furring 12³/₄" long
- 10 PLACE CEILING ON SUPPORTS**
 - 1 pc. plywood 14" x 32" (cut from center of 22" x 40" panel)
- 11 NAIL HANDLE GRIPS ON END WALLS**
 - 2 pcs. furring 18¹/₂" long

And that completes the basic structure. At this point, you're just about ready to weatherize the house. But before you do, you'll have to check the thermal efficiency of the model as it now stands. So...

QUICKIE EXPERIMENT "D" Testing the Unweatherized House

This quickie experiment won't be all that quick. But it *will* be easy. Put six ice cubes in a saucer and set the saucer on the floor inside the model house.

Replace the ceiling, noting the time on the clock. Periodically look through the plastic window to check the ice. When it has all melted, jot down how long the melting required.

Now you can weatherize the house. Cut the foam pads to fit the top of the ceiling and the spaces under the floor. Whatever remains can be used as a second layer under the floor, if room permits.

Secure the pads in place with glue and tape. Be sure to put the pads on the *unfinished* side of the plywood ceiling. Then fill the wall spaces with loose insulation, but don't pack it down. Run weatherstripping around the top of the ceiling supports. And finally, if the walls and floor don't fit together too well, get a small tube of caulking compound and caulk all inside joints.

How can you tell if the weatherized house is any more effective than before? That's right, run another experiment. Here we go again...

QUICKIE EXPERIMENT "E" Testing the Weatherized House

Pick out six ice cubes of the same size you used for Quickie Experiment "D," and follow the same procedure as in that test. This time, however, you'll be putting the saucer of cubes into a weatherized house. Once again, note how long it took for the ice to melt.

If the total amount of ice was the same in both experiments, you should have recorded a longer melting time with the insulated house. Did you?



SECTION III

Solar Energy

So far you have found some of the factors that affect your family's energy usage and you have seen how reducing electrical usage and weatherizing your home can help conserve energy.

But however much we conserve, the fact remains that two of our most important sources of energy — oil and natural gas — are in short supply. Sooner or later (and many experts say it had better be sooner) we will have to find new sources of energy for the years ahead.

Many alternative energy sources are being considered. One of the most attractive is the sun. And no wonder. The sun pours more clean energy on the earth in two weeks than is contained in all the world's coal, oil, and natural gas reserves *combined*. And best of all, it's free.

In the next experiment we will convert our weatherized house into a solar garden that you can actually use to grow small plants (potted herbs, for example) *outside during the winter*. This working model, by the way, is based on a full-sized solar garden that did indeed produce crops in commercial quantities all year around in Michigan.



EXPERIMENT 5: Converting to a Solar Garden

You will need: the weatherized house and leftover materials from Experiment 4; eight 2¼" nails; aluminum foil; a small screw eye; six 2-pound coffee cans; flat black paint; six to eight 3" or 4" pots with various herbs or other small plants.

In the winter, a solar garden needs something to collect and store the sun's heat for release during the night. Our "something" will be water. . . water in coffee cans. The cans will help the water absorb heat better if they are dark and nonreflective. That's the reason for the flat black paint. So begin by painting the cans inside and out.

While they're drying, you can put up the roof. For that job, the instruction numbers below correspond to the numbers on the drawing.

- 1 NAIL ROOF BASE TOGETHER.**
 - 4 pcs. furring 18¾" long
 - 4 pcs. furring 40" long
 - 1 pc. plywood 22" x 40" (interior cutout dimensions: 14¼" x 32¼")
- 2 ERECT RIDGE SUPPORTS ON ROOF BASE (anchor by nailing upward through roof base; make sure supports are centered).**
 - 2 pcs. furring 12" long
 - 4 nails 2¼" long
- 3 CUT OUT CARDBOARD TEMPLATE FOR MARKING RIDGE AND ROOF-BASE ANGLES ON RAFTERS.**
- 4 SAW RAFTERS TO LENGTH.**
 - 8 pcs. furring 17¼" long
- 5 MARK RIDGE AND ROOF-BASE ANGLES ON RAFTERS. SAW ANGLES OFF.**
 - Cardboard template from Step 3
 - 8 rafters from Step 4

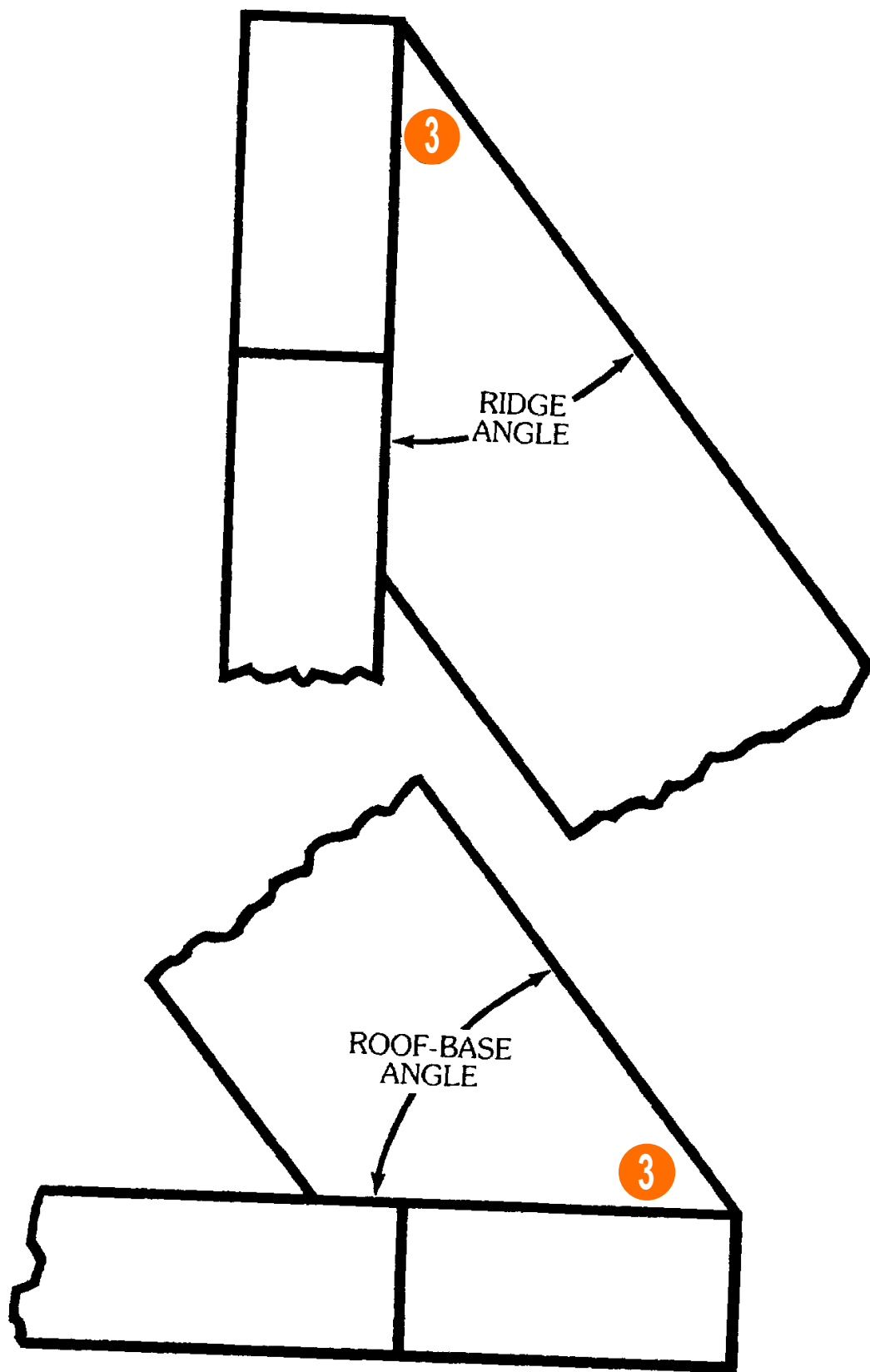

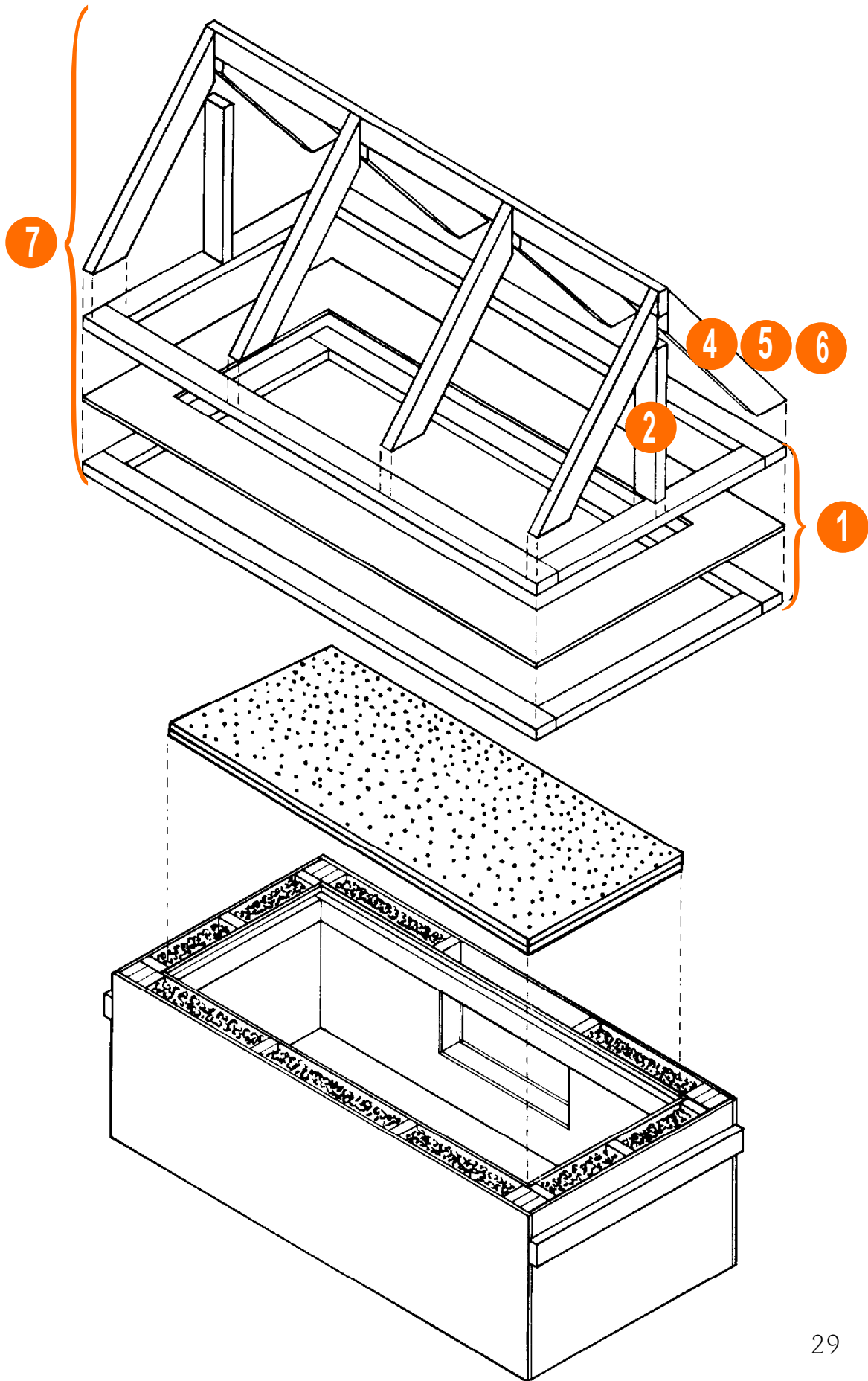

6 NAIL RAFTERS TO RIDGE BOARD.

- 1 pc. furring 40" long
- 8 angled rafters from Step 5

7 NAIL ROOF ASSEMBLY TOGETHER.

- Roof base with ridge supports
- Ridge board and rafters
- 4 nails 2¼" long (to fasten ridge to its supports)

That's it for the roof. Just a few more details and you can wrap up this project. But first, let's check your handiwork. Get the house you built in Experiment 4 (whaddya mean you can't find it?). If you worked with reasonable care, the roof overhang should just clear the exterior house walls. And the plywood roof runner should cover the tops of all the walls and the space between. They do? Way to go.

Now for the final steps:

- Glue aluminum foil to the entire underside of the ceiling. Try not to wrinkle the foil, as it must reflect the sun's rays into the garden when the ceiling is propped open.
- Set the ceiling and roof in place. Swing the window side of the ceiling upward till it hits the back rafters (you will have to raise the roof slightly to clear the front rafters). Then cut a length of 1" x 2" furring to keep it propped open to its maximum. A small nail in the ceiling will keep the prop from slipping.
- Tightly cover the roof with the plastic dropcloth; if there are any wood projections that could tear the plastic, saw them off. Secure the plastic to the underside of the roof with tape and thumbtacks. You can lift the roof easily by grabbing the overhang with both hands. Or you can insert a screw eye in the center of the ridge board. If you prefer that option, put a piece of tape over the plastic before twisting the screw in.

When starting up your solar garden, try to place it high enough off the ground to avoid its being covered by snow. A picnic table or bench would be great. Orient the house so that the window faces south at high noon. Inside, arrange the coffee cans and potted plants as shown on page 31.

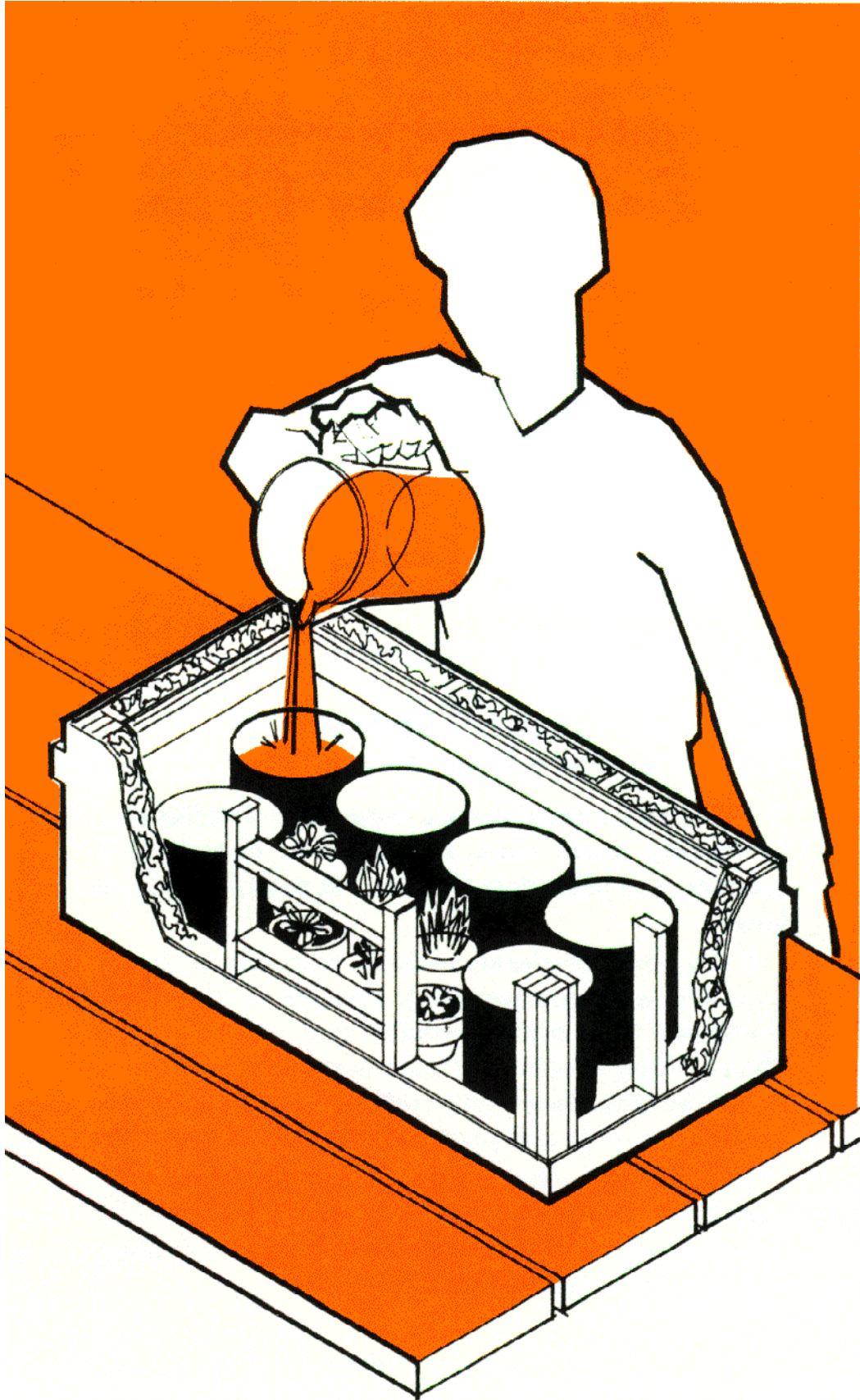

Fill the coffee cans with water.* You might also want to put a small thermometer among the plants to monitor the temperature in your garden.

The ceiling should be propped open every day, even when the skies are cloudy. And it should be closed every night. In both cases, the roof will have to be removed to adjust the ceiling, of course.

Your solar garden should provide a suitable temperature for the plants. But when it really gets cold, you may have to bring the plants indoors. Let the water in the coffee cans be your guide. If it starts freezing, that's the time to move inside.

By the way, don't forget to maintain the water level in the cans. And remember to water those plants.

* Why use water? The best way to answer that question is to (oh, oh, here it comes) do another quickie experiment. Sooo..

QUICKIE EXPERIMENT "F" **Water as a Heat Storage Material**

Try to get three small cans of the same size, like soup or tomato paste cans. Put water in one, sand in another, and pebbles in the last. Fill each to the same level.

If you have permission to do so, place the cans in an oven (not a microwave oven). Turn the thermostat to the lowest temperature possible and set the oven on "bake." After about a half hour, the contents of all cans should be at the same temperature. Using a pot holder, remove the cans and put them on some newspapers.

Wait several minutes. Then carefully touch each can. Keep doing that every so often. Which one holds heat the longest? Does that answer the question about using water in the coffee cans?

THOMAS ALVA EDISON FOUNDATION

Advancing Science, Technology and Engineering Education

OFFICERS

MADELEINE EDISON SLOANE, II
Honorary Chairman

WALKER L. CISLER
Chairman and Chief
Executive Officer

W. DONHAM CRAWFORD
Vice Chairman

JAMES G. COOK
President and Chief
Operating Officer

PAUL J. CHRISTIANSEN
Vice President

KENNETH A. MEADE
Vice President, Assistant Secretary
and Assistant Treasurer

PAMELA DAWN HURST
Assistant Vice President

DONALD R. MANDICH
Treasurer

THOMAS J. UNGERLAND
Secretary

TRUSTEES

ARNALDO ANGELINI, Ph.D.
Presidente
Ente Nazionale Per L'Energia Elettrica
Italy

A. H. AYMOND
Retired Chairman
Consumers Power Company

D. JEFFREY BADDELEY
Vice President, Secretary and General Counsel
Sargent- Welch Scientific Company

JAMES A. BAKER
Executive Vice President
General Electric Company

J. E. BERTRAM, Ph.D.
Vice President
International Business Machines Corporation

L. K. CHEN
Chairman
Taiwan Power Company
Republic of China

* **PAUL J. CHRISTIANSEN**
President
Charles Edison Fund

WALKER L. CISLER
Chairman
Overseas Advisory Associates, Inc

* **ASHTON B. COLLINS, JR.**
President
Reddy Communications, Inc

* **JAMES G. COOK**
President
Thomas Alva Edison Foundation

* **W. DONHAM CRAWFORD**
Honorary Chairman
Gulf States Utilities Company

MICHAEL E. DeBAKEY, M.D.
President and Chief Executive Officer
Baylor College of Medicine

LOUIS DeHEEM
President de L'Association Vincotte. Retired
Belgium

* **WILLIAM O. DOUB**
Partner
Doub and Muntzig

JOSEPH M. FARLEY
President
Alabama Power Company

RAYMOND C. FIRESTONE
Chairman of the Board, Retired
Firestone Tire and Rubber Company

WILLIAM CLAY FORD
Chairman, Executive Committee
Ford Motor Company

RAYMOND H. GIESECKE
Retired Chairman
McGraw-Edison Company

LEON HESS
Chairman
Amerada Hess Corporation

* **SOL KING**
Retired Chairman
Albert Kahn Associates, Inc.

CARL THEODOR KROMER, Ph.D.
Retired Director, Badenwerk
Federal Republic of Germany

F. MAHMOUDIAN
Associate
Overseas Advisory Associates, Inc.

* **DONALD R. MANDICH**
Chairman and Chief Executive Officer
Comerica Incorporated

WALTER J. McCARTHY, Jr.
Chairman of the Board
and Chief Executive Officer
The Detroit Edison Company

WILLIAM McCOLLAM, Jr.
President
Edison Electric Institute

* **WILLARD F. McCORMICK**
Chairman
Cresap, McCormick and Paget

JAMES H. McNEAL, JR.
President
The Budd Company

* **KENNETH A. MEADE**
Retired Director of Educational Relations
General Motors Corporation

GUY NICHOLS
Chairman, President and
Chief Executive Officer
New England Electric System

COURTLAND PERKINS, Ph.D.
President
National Academy of Engineering

JOHN W. PORTER
President
Eastern Michigan University

JOHN T. RYAN, Jr.
Chairman
Mine Safety Appliances Company

JOHN D. SELBY
Chairman, President and Chief Executive Officer
Consumers Power Company

JOHN EDISON SLOANE
John Edison Sloane, Inc

MADELEINE EDISON SLOANE, II
Attorney
Southern Pacific Transportation Company

ROBERT I. SMITH
Chairman and Chief Executive Officer
Public Service Electric and Gas Company

GEORGE A. STINSON
Chairman
National Steel Corporation

CHARLES TRETOWAN
Chairman
State Electricity Commission of Victoria
Australia

THOMAS J. UNGERLAND
Associate General Counsel
U.M.C. Industries, Inc.

* **EDWIN VENNARD**
Private Consultant
Greenwich, Connecticut

PETER von SIEMENS, Ph.D.
Chairman
Siemens AG
Federal Republic of Germany

FRANK M. WARREN
Chairman and Chief Executive Officer. Retired
Portland General Electric Company

EDWARD J. WILLIAMS
Chairman, Chief Executive Officer and President
McGraw-Edison Company

*Executive Committee Member