

# Water for the World

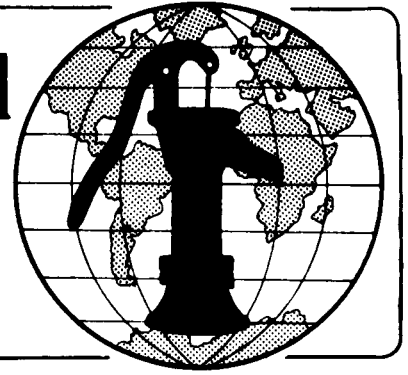

## Constructing Hand Dug Wells Technical Note No. RWS. 2.C.1

Proper construction of a hand dug well is important to ensure a year-round supply of water and to protect the water from contamination. Construction involves assembling all necessary personnel, materials, and tools; preparing the site; excavating the well shaft; and lining the shaft. Finishing the well is discussed in "Finishing Wells," RWS.2.C.8.

There are several good methods to construct a hand dug well; if you are familiar with a specific method, use it. This technical note describes one method of construction, using locally available materials, that has been employed successfully in a number of countries. Read the entire technical note before beginning construction.

### Useful Definitions

**AQUIFER** - A water-saturated geologic zone that will yield water to springs and wells.

**CONTAMINATE** - To make unclean by introducing an infectious (disease-causing) impurity such as bacteria.

**GROUND WATER** - Water stored below the ground's surface.

**KIBBLE** - A large bucket for lifting materials when sinking a shaft; also called a hopper or sinking bucket.

**POROUS** - Having tiny pores, or spaces which can store water or allow water to pass through.

**WATER TABLE** - The top, or upper limit, of an aquifer.

### Materials Needed

The project designer must provide three papers before construction can begin:

1. A location map similar to Figure 1.
2. A design drawing similar to Figure 2.

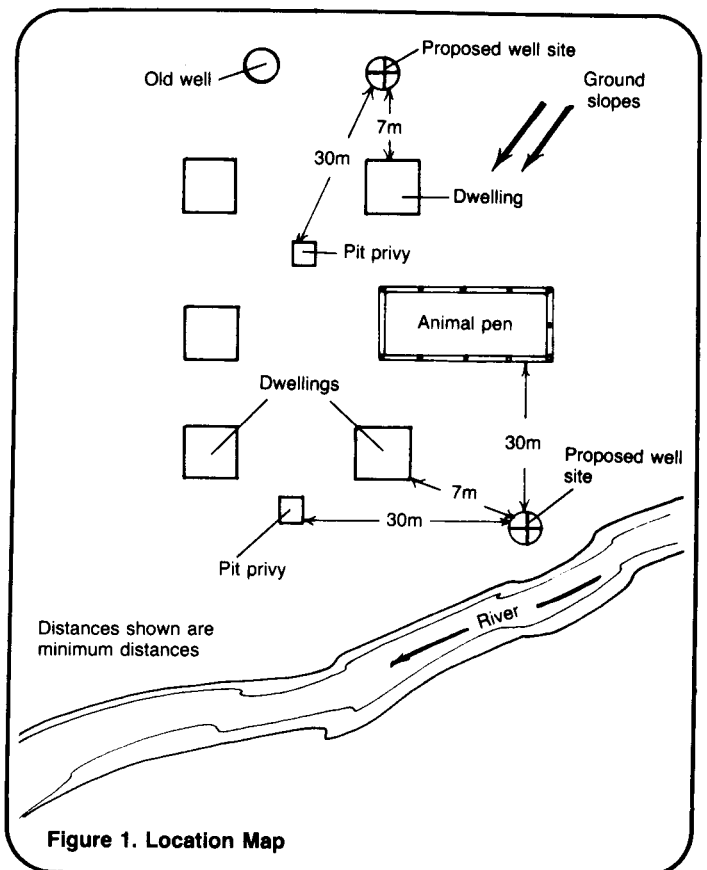

3. A materials list similar to Table 1.

After the project designer has given you these documents and you have read this technical note carefully, begin assembling the necessary workers, supplies, and tools.

### Construction Schedule

Depending on local conditions, availability of materials, and skills of workers, some construction steps will require only a few hours, while others may take a day or more. Read the construction steps and make a rough estimate of the time required for each step based on local conditions. You will then have an idea of when specific workers, materials, and tools must be available during the construction process. Draw up a work plan similar to Table 2 showing construction steps.

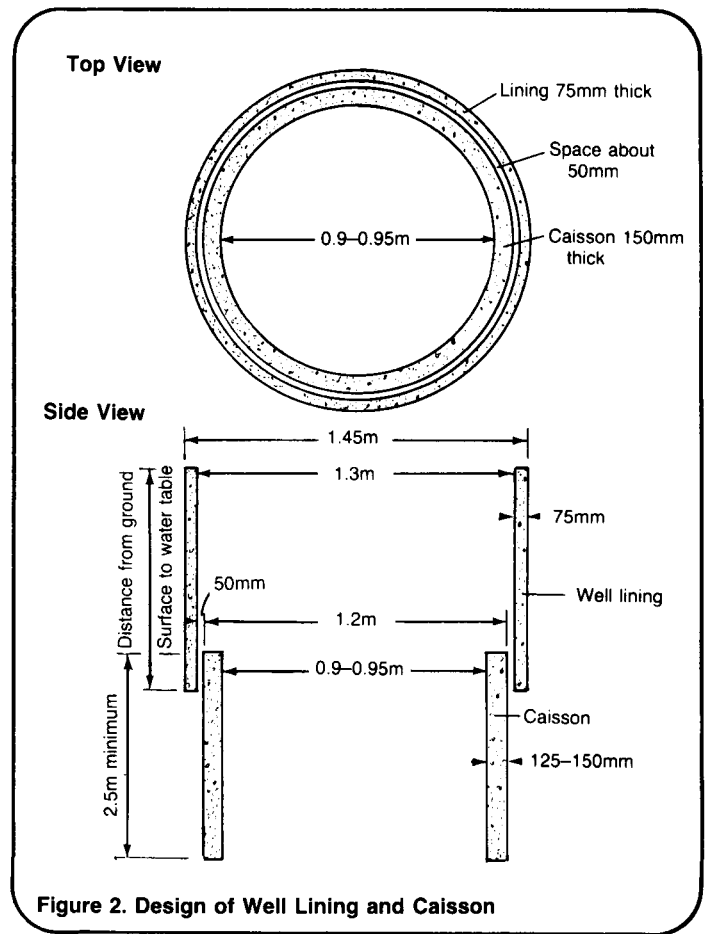

Figure 2. Design of Well Lining and Caisson

Table 1. Sample Materials List

Item	Description	Quantity	Estimated Cost
Personnel	Foreman	1	_____
	Worker, skilled in sinking well	1	_____
	Worker, experienced with concrete	1	_____
	Workers, unskilled	2-4	_____
Supplies	Cement (Portland)	_____ kg	_____
	Sand (clean; fine to 6mm)	_____ m <sup>3</sup>	_____
	Gravel (clean; 6-36mm)	_____ m <sup>3</sup>	_____
	Water (clean and clear)	_____	_____
	Re-rod for lining: 8mm diameter	_____ m	_____
	Re-rod for caissons: 15mm diameter	_____ m	_____
	Materials for storage shed	_____	_____
Equipment	Headframe	_____	_____
	Rope for caissons; 100m x 12mm diameter, steel wire with fiber gore, tensil strength 7kg/cm <sup>2</sup>	_____	_____
	Rope for kibbles: 100 x 6mm diameter	_____	_____
	Rope for trimming rods: 100m x 3mm diameter	_____	_____
	Steel shutters (1.3m diameter x 0.5m high) with wedges and bolts	_____	_____
	Steel shutters (1.3m diameter x 1.0m high) with wedges and bolts	_____	_____
	Steel molds for caisson rings (1.2m outside diameter, 0.95m inside diameter, 0.5m high)	_____	_____
	Templates for molds	_____	_____
	Stretcher for caissons	_____	_____
		_____	_____
		_____	_____

Total Estimated Cost = \_\_\_\_\_

**Table 2. Sample Work Plan for a Hand Dug Well**

Time Estimate	Day	Task	Personnel	Materials/Tools
1 day	1	Locate and prepare well site; assemble materials	Foreman (present during entire construction); 2-4 workers	Measuring tape; drawings; tools and materials for building shed
1 day	2	Erect headframe; set center point and offset pegs; build mixing slab	2-4 workers	Headframe; plumb bob; re-rod; cement, sand, gravel, water; trowel
4 hours	3	Dig shallow excavation; install temporary lining	2-4 workers	Shovels; shutters (1.3m diameter, 1.0m high) spirit level
7 days	3-9	Excavate and trim first lift	4 workers	Shovels; picks; mattock; kibble; top plumbing rod; trimming rods
2 hours	10	Install first set of shutters	4 workers	Shutters (1.3m diameter, 0.5m high); spirit level; trimming rods; shovel
6 hours	10	Install vertical and horizontal re-rods	4 workers	Lengths of re-rod; binding wire; spacing blocks and holding hooks; wire cutters
1 day	11	Install second set of shutters; pour concrete; build curb	4 workers	Oiled shutters (1.3m diameter, 1.0m high); cement, sand, gravel, water; tamping rod; re-rod; burlap covering; mattock
1 day	12	Install third and fourth sets of shutters; pour concrete	4 workers	Sets of oiled shutters; cement, sand, gravel, water
2 days	13-14	Widen top of well; add re-rods; install fifth and sixth sets of shutters; pour concrete; bend back rods and cover with layer of weak mortar	4 workers	Burlap covering; mattock; re-rod; binding wire; sets of oiled shutters; cement, sand, gravel, water
---	---	Construct second and third lifts and lining as needed	4 workers	Materials and tools as needed
1 day	15	Build caisson rings	4 workers	Molds; re-rods; oiled pipes; templates; cement; sand (none if porous concrete), gravel, water
10 days	16-25	Cure caisson rings	----	Wet burlap or straw
2 days	26-27	Install caisson rings	4 workers	Stretcher; spacers; heavy planks; wrench; mortar; trowel
2 days	28-29	Sink caissons into aquifer	4 workers	Shovels, kibble
2 hours	30	Install base plug	4 workers	Precast base plug

### Caution!

1. Workers in the well shaft should wear hard hats for protection.
2. Workers at ground level must be careful not to accidentally drop or kick tools or other materials into the well shaft.
3. A kibble, rather than a bucket or basket, should be used to hoist soil out of the shaft.
4. The well must be dug at the exact location specified by the project designer.

### Construction Steps

1. Using the location map and a measuring tape, locate the well site. Clear the area of any vegetation or debris that might interfere with work.
2. Assemble all laborers, materials, and tools needed to begin construction and arrange the materials in a fashion similar to Figure 3. A proper layout will save time and effort during later construction steps. A shelter should be built to protect tools and some materials from the weather, theft, or being misplaced.

Because the caisson rings must be cured for at least 10 days before they can be lowered into the well shaft, build them first even though they will not be needed until later in the construction process. See step #26.

3. Erect the headframe over the site of the well. The headframe must be sturdy enough to support the caisson rings, which may weigh over 350kg. One type of headframe that has been used successfully is shown in Figure 4. It is made of angle iron and equipped with a winch and brake. The four feet of the headframe must rest on solid ground--place stone slabs or pour concrete under them if necessary. It is important that the headframe not be moved once it is in position and the center point of the well has been fixed.

4. Build a slab for mixing concrete by first leveling an area about two meters square. Spread 50mm of well-tamped gravel, cover with a layer of cement mortar (4 parts sand to 1 part cement), and smooth with a trowel. Form a lip around the outer edge, cover the slab with wet burlap or straw, and keep moist for two or three days.

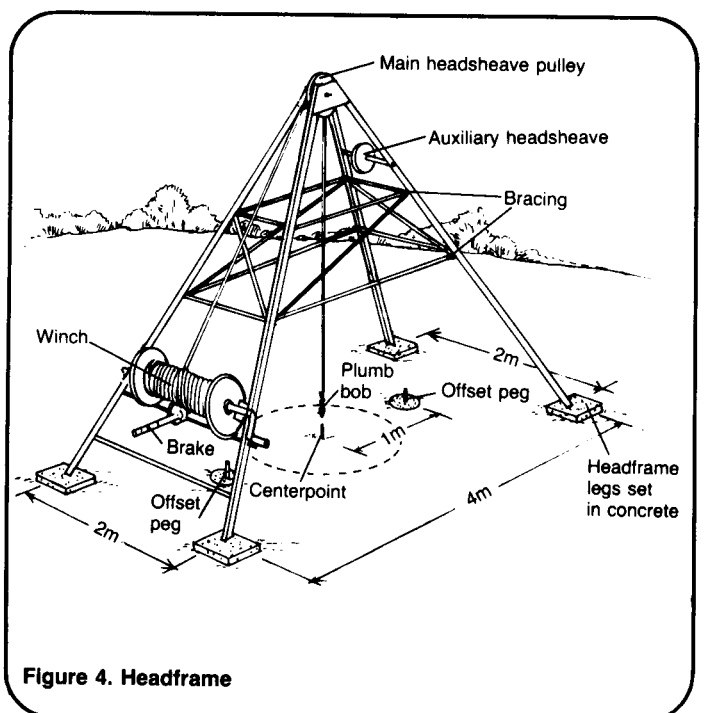
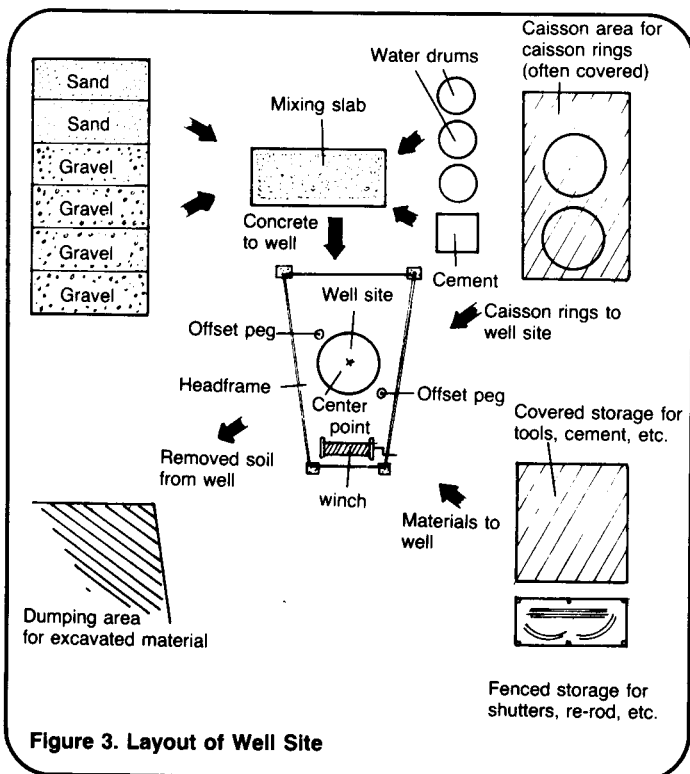

5. Establish the center point of the well by lowering a plumb bob from the headsheave pulley on the side opposite the winch; that is, the side from which the main hoisting rope will descend. Mark this point on the ground with a short length of re-rod. Set offset pegs on opposite sides and exactly 1.0m from the center point. Make the top of these pegs at least 150mm above ground level to make allowance for the temporary lining that will be installed. These pegs should be set in concrete and positioned so that the top plumbing rod will fit over them as in Figure 4. Allow the concrete to set for several days before using the pegs.

6. Mark a circle of 650mm radius around the center point. Carefully excavate within this circle to a depth of 0.9m. Position a set of steel shutters 1.3m in diameter and 1.0m high inside this hole with 100mm projecting above ground to act as a temporary lining. See Figure 5. Be certain that the shutters are exactly in place and that the top is level. Firmly tamp soil around the outside. These shutters will prevent the top of the shaft from crumbling, and they will reduce the risk of tools or materials being accidentally kicked into the shaft.

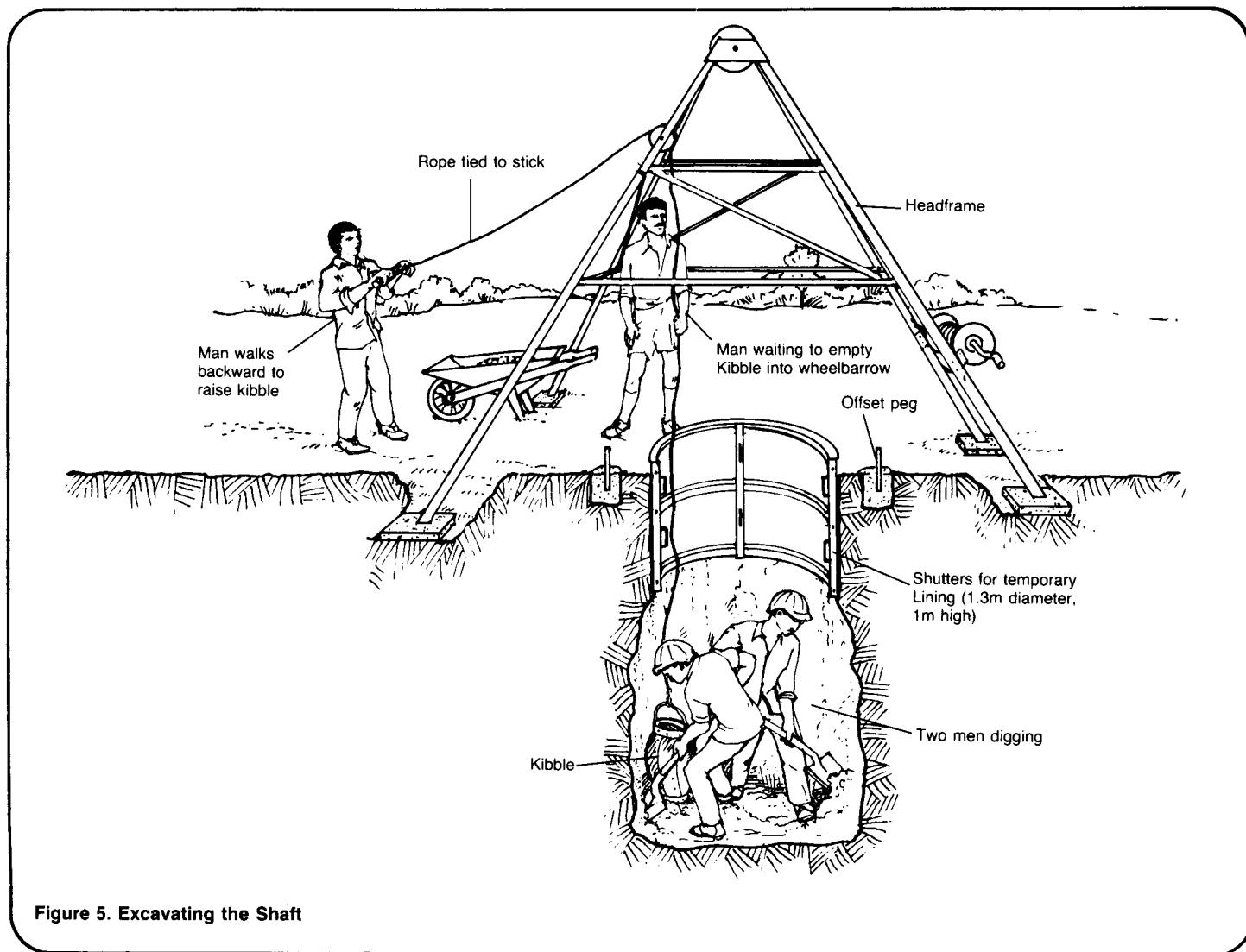

7. Begin excavating the first lift of the well. Normally, two workers using miner's picks and bars and short-handled shovels excavate the soil in layers about 100mm deep, and they keep the bottom of the excavation fairly level at all times. Soil is removed by hoisting it up in a kibble, as shown in Figure 5. The shaft is dug somewhat less than its finished diameter of 1.45m.

Every meter or so the long trimming rods, 1.45m long, are suspended from the top plumbing rod. The workers carefully trim the walls of the shaft so that the trimming rods can freely turn with their ends just missing the shaft walls, as shown in Figure 6. It is important that the trimming be done with extreme care, for even a small addition to the thickness of the lining will increase the amount of concrete used.

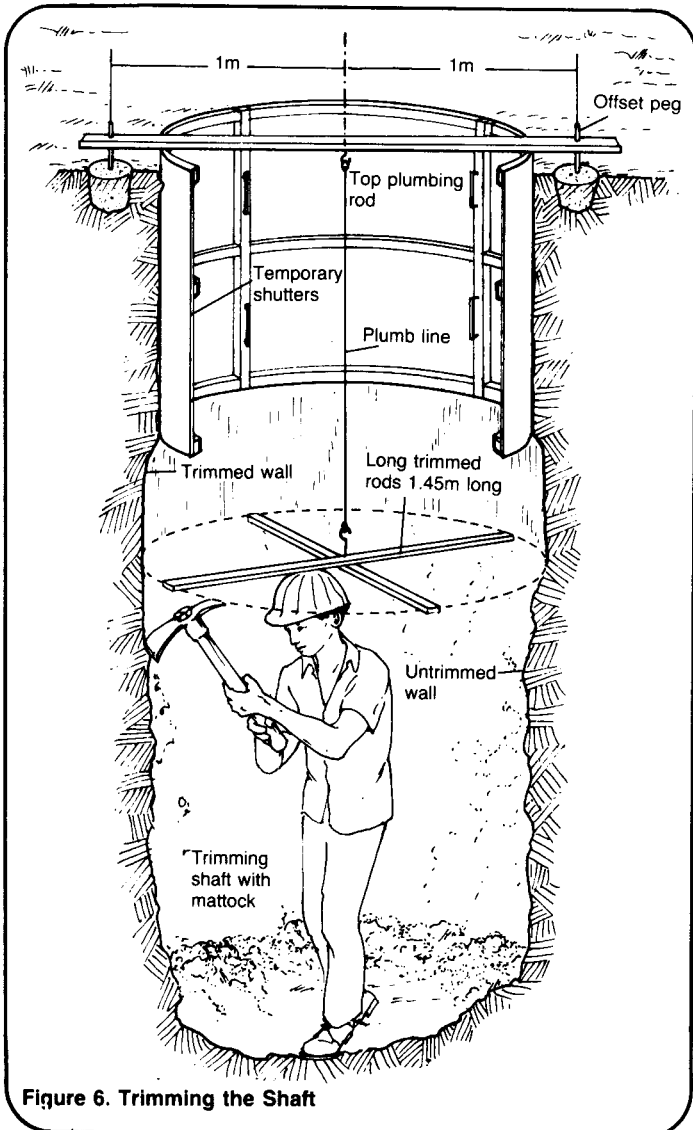

Depending on the condition of the soil, the first lift can be dug as deep as 5.0m, 4.1m below the bottom of the temporary lining. If the soil is crumbly or tends to cave in, the lift must be shallower. If water is struck, stop the excavation and proceed to step 25.

8. A set of shutters, 1.3m in diameter and 0.5m high, is oiled and then lowered to the bottom of the shaft. Set the shutters precisely in place by suspending the short trimming rods 1.3m long and lining up the edges of the shutters directly beneath the ends of the rods. Use a spirit level to be certain that the shutters are level. It is essential that these shutters be exactly in place and perfectly level, or else the entire lining will be out of line. See Figure 7.

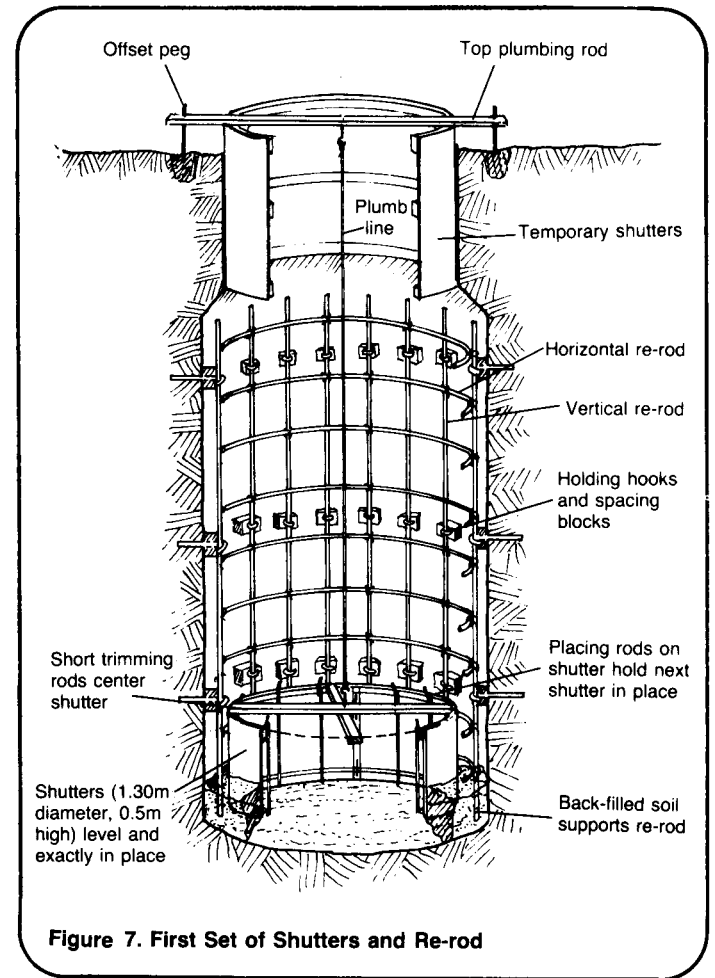

9. Position 20 lengths of vertical re-rod, each length 4.0m long and 8mm in diameter, behind the shutters and around the shaft walls. Fix the rods to the walls about 200mm apart using spacing blocks and holding hooks. Backfill behind the shutters with soil to help hold the rods in place, as shown in Figure 7.

10. On the surface, shape horizontal re-rods into circles 1.38m in diameter. You will need three or four horizontal re-rods for each meter of depth. Lower the re-rods and fasten them to the inside of the vertical re-rods about 250-300mm apart, as shown in Figure 7. They will make the reinforcement cage strong and secure. Use a wire brush to remove all dirt from the re-rods.

11. Oil a set of shutters, 1.3m in diameter and 1.0m high, lower it into the shaft, and position it on top of the first set. Center the shutters with the short trimming rods, 1.3m long, check them with a spirit level, and bolt them in place, as shown in Figure 8.

12. Mix concrete on the mixing slab. Use one part cement, two parts sand, four parts gravel, and enough water to make a workable mix. Lower the concrete in a concrete bucket tied to a rope over the auxiliary headsheave. The main headsheave and a bosun's chair will be used later to raise and lower the workman pouring concrete. When lowering the bucket, be careful that it does not catch on any projection and spill its contents on the workers below.

Pour the concrete behind the shutters as shown in Figure 8. Pour it evenly and in shallow layers to prevent overloading one side. Tamp with a length of re-rod. Fill the space between the shutters and the shaft walls until the concrete is 10-20mm from the top of the shutters, and leave the top of the concrete rough. This will ensure a good bond with the next pour.

13. Temporarily cover the concrete with burlap or other material to keep off soil. Carefully excavate a triangular-shaped groove, 200mm deep and 200mm high at the well face, around the shaft walls just above the shutters. Set re-rod pins into the groove

and fasten to the vertical re-rods. Remove the temporary cover. Fill in the groove with concrete as shown in Figure 8. This forms a curb which will help hold the lining in place and prevent it from slipping.

14. Oil the third set of shutters, 1.3m diameter and 1.0m high, lower it into the shaft, and position it on top of the second set. Center the shutters with the short trimming rods, check them with the spirit level, and bolt them in place. Pour concrete as before, and tamp to be certain all voids are filled with concrete.

15. Oil a fourth set of shutters and repeat the process of lowering and positioning them and pouring concrete as shown in Figure 8.

16. The top of the fourth set of shutters will be about 600mm below the bottom of the shutters being used for temporary top lining. Cover the concrete with burlap to keep off soil and remove the temporary lining. Excavate the sides of the well to a diameter of 1.6m from the surface of the ground down to the top of the fourth shutter. Attach lengths of vertical re-rod to the re-rod already in place. Bend the ends of all re-rods into hooks and overlap the lengths by

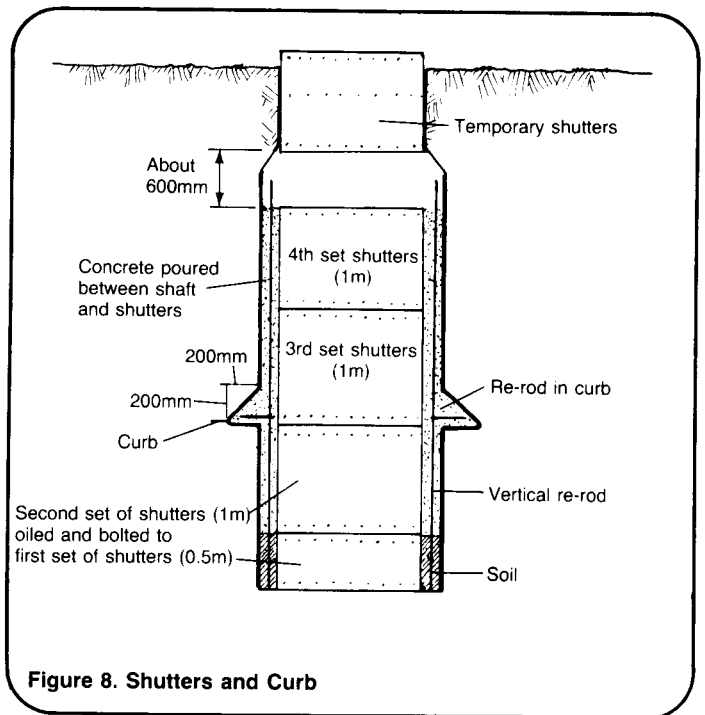

Figure 8. Shutters and Curb

at least 200mm as shown in Figure 9. The new re-rods should protrude above ground about 200mm. Position circles of horizontal re-rods 250-300mm apart and fasten them to the vertical re-rods. Remove the burlap from the concrete.

17. Oil the fifth and sixth sets of shutters in turn, set them in place, check their positioning with trimming rods and a spirit level, and bolt them together. Pour concrete as before, and carefully fill in the space behind the shutters up to ground level as shown in Figure 9. The extra thickness of concrete in the top 1.5m of the lining will provide a solid base for the wellhead. See "Finishing Wells," RWS.2.C.8.

18. Bend back the protruding vertical rods until they are level with the ground. Make a weak mortar mix (1 part cement to 15 parts sand), and use it to cover the re-rods and form a lip around the well as shown in Figure 9. This mortar layer will help keep surface water and debris out of the well, and it can be easily broken away when it is time to build the wellhead.

The first lift is now complete. Leave the shutters in place for about seven days to allow the concrete lining to cure. If you have more shutters, you can begin the second lift at once, leaving the first lift shutters in place. If not, you will have to wait seven days before beginning the second lift.

19. To begin the second lift, remove the earth-filled shutter at the bottom of the first lift, and clean the re-rods with a wire brush.

20. Excavate the second lift to a depth of 4.65m below the bottom of the concrete lining of the first lift. If ground water is encountered before you reach this depth, stop the excavation and proceed to step 25.

21. Position the vertical re-rods in the same manner used in the first lift. Bend the top ends of these re-rods into

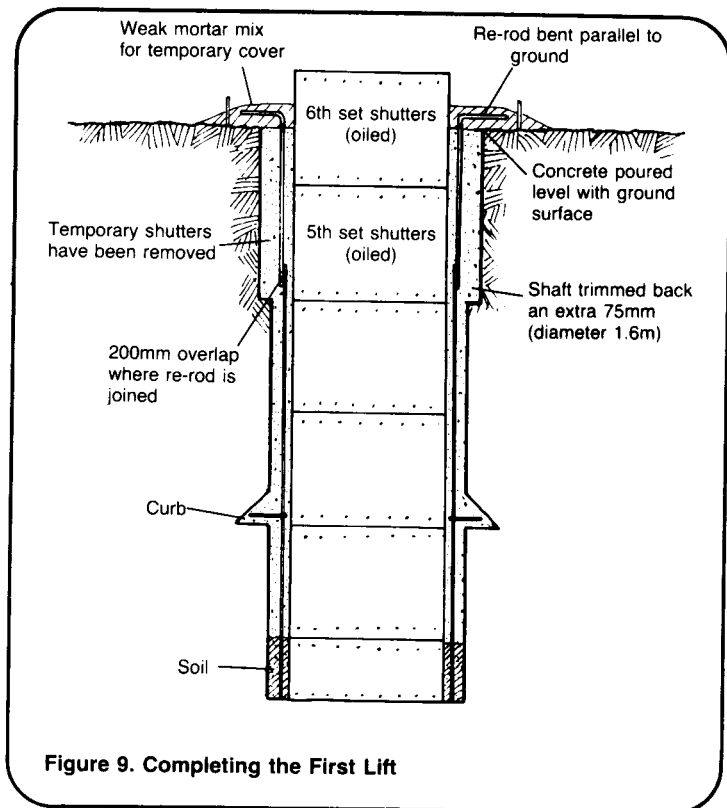

Figure 9. Completing the First Lift

hooks and leave the bottom ends of the re-rods protruding down from the concrete. The lengths should overlap by about 200mm. Fasten them together with wire. Position and fasten circular sections of horizontal re-rods in place.

22. Begin lining the second lift in the same manner as the first. Remember the first set of shutters is 0.5m high and backfilled with soil, and a concrete curb is built just above the second set of shutters.

23. There will be a gap of about 150mm between the top of the fourth set of shutters and the bottom of the concrete lining of the first lift, as shown in Figure 10. To pour concrete into this set of shutters you will need a funnel or scoop made from scrap metal. This will prevent spilling concrete.

24. The gap between lifts should be left open until the entire well is excavated and lined in case there is any movement or shifting of the lining.



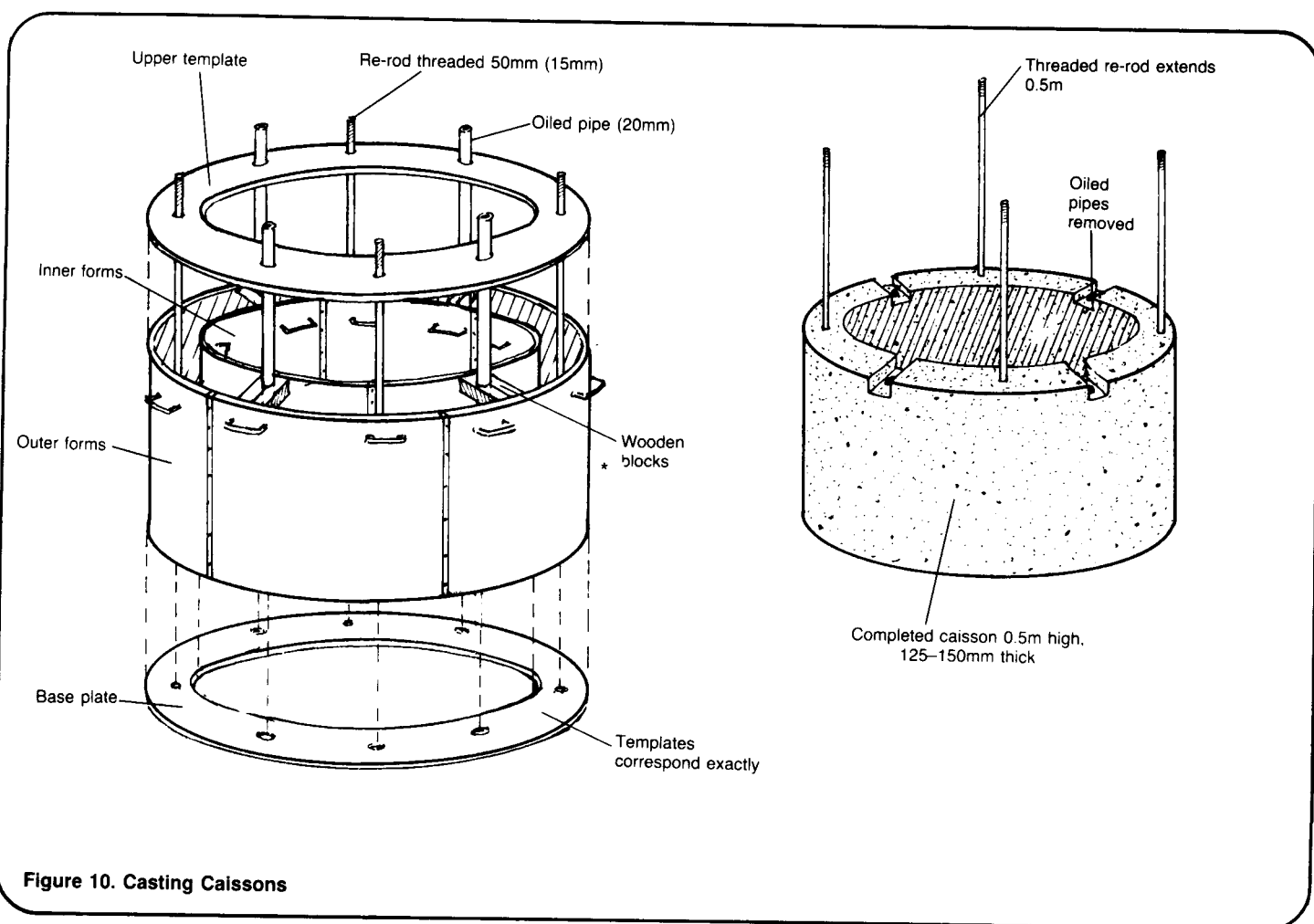

Figure 10. Casting Caissons

These gaps can be used to attach the pipe for a pump or the supports for an access ladder.

When it is time to fill the gaps, use concrete mortar and bricks or stones. Thoroughly seal the entire gap with a coating of plaster to prevent possible contamination by entry of surface water.

25. Continue the process of digging and lining until ground water is reached. If you encounter difficult ground or if the water table is reached before a full lift is excavated, the lift can be made as shallow as 650mm, 500mm for a small set of shutters and 150mm for the gap below the previous lining.

When the aquifer is reached, dig down into it to examine its composition and depth. An auger is a useful tool for this work. If the aquifer is a shallow perched layer, you must sink the well through it to a deeper

aquifer. If you have indeed reached a main aquifer, line this last section of the shaft as before and build an extra-deep curb as shown in Figure 10.

26. The remainder of the well will be sunk using the caisson method. Before you can begin, the lining must be given time to harden so that you can remove the shutters. See Figure 2 for the way in which caisson rings fit into the lining.

The caisson rings may already have been cast as described in step 2. The type of rings used depends on the composition of the aquifer. The rings can be made of porous concrete, standard concrete, or standard concrete perforated with seepage holes.

26a. Cast all types of rings in a mold 0.5m high, with an outside diameter of 1.2m and an inside diameter of 0.90-0.95m. See Figure 10. If standard concrete is to be used, it can be the same mix as was used for the

lining. If the rings are to have seepage holes, you must use special molds with perforations. If porous concrete is to be used, it should be made by mixing one part cement to four parts washed gravel and no sand. The mix must not be overly wet; use only enough water to make it workable. The gravel must be quite clean and of the correct size. It must all pass through a 20mm screen but none of it must pass through a 10mm screen.

26b. To ensure that the caisson rings will fit together when placed in the well shaft, equip each ring with four evenly-spaced re-rods, 15mm diameter and 1.0m long, and four evenly-spaced holes 20mm in diameter. When the rings are set one on top of the other, the re-rods from one ring will fit into the holes of the other. The holes are made with well-oiled pipes, and the pipes and re-rods are held in position by a template. A small block of wood with a hole for the pipe to pass through is positioned to form a recess in the caisson ring for a bolt which will be secured onto the end of each re-rod. Each re-rod is threaded at the top 50mm and has a hole drilled 25mm from the bottom end through which a nail or piece of thick wire is placed. This will prevent the rod from pulling out when weight is placed on it.

26c. Cast the caisson rings in the shade. Insert the re-rods and the pipes that will form the holes. If the rings are to have seepage holes, place rods or wooden pegs through the holes in the sides of the mold.

26d. When the concrete has been in the mold for 12-24 hours, remove the pipes for the holes and, if necessary, the rods or pegs for the seepage holes.

26e. The molds should not be removed for three days, and the caisson rings should not be moved during this time. If porous concrete is being used, the molds should be left in place for seven days.

26f. Remove the caisson rings from their molds. Cure the rings by keeping them moist and in the shade for seven days. If they are made from porous concrete, the rings should be cured for 14 days.

27. Roll the first caisson ring beside the well shaft and tip it on end so that the re-rods are pointing up. Lower the stretcher over two re-rods on opposite sides of the ring. The stretcher must be made of steel or wood and be capable of supporting the weight of the caisson rings, each of which may weigh over 350kg. Fit lengths of 20mm diameter pipes and washers over the re-rods so that the stretcher can be tightly bolted down as shown in Figure 10.

28. Cover the opening of the well shaft with stout logs or planks. Attach the main lowering rope to the U-bolt in the center of the stretcher. Carefully maneuver the caisson ring up onto the logs or planks until it is centered, raise it about 100mm, and remove the planks.

29. Slowly and carefully lower the ring to the bottom of the shaft. The ring must be level and perfectly centered, or you will have difficulty fitting on the other caisson rings. If necessary, raise the ring just off the bottom and wedge pieces of wood underneath until it is level and in position. Only then should you unbolt the stretcher. See Figure 11.

30. Lower the second ring in the same manner as the first. Just before it reaches the projecting re-rods of the first ring, a worker, perhaps sitting on the stretcher, must turn it so that its holes match the projecting re-rods. Partly lower the ring onto the re-rods, then spread a 10mm layer of cement mortar on the top edge of the first ring. Lower the second ring until it rests on the first. The rods of the first ring will project up into the recesses on the top edge of the second ring. Fix bolts on the threaded ends of the re-rods and tighten until the second ring is secure and level. Fill in the recesses and cover the bolt with cement mortar.

31. Continue lowering rings and fitting them together until there are five or six rings in the shaft. See Figure 11.

32. Probe the bottom of the shaft with a pointed length of re-rod to check for hard or soft spots. When excavation starts, there may be a

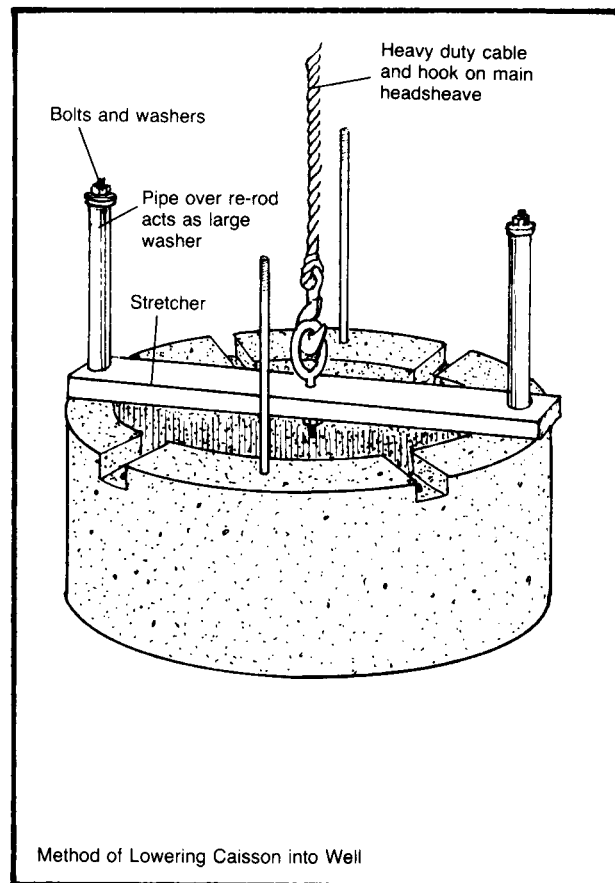
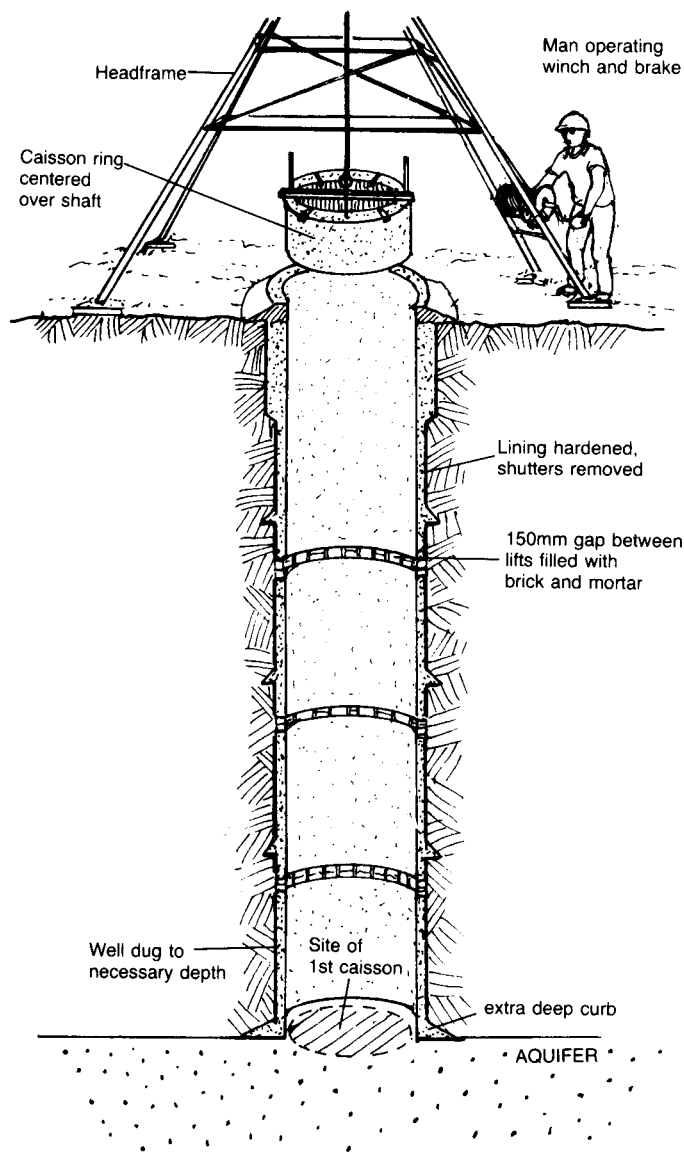

Figure 11. Installing Caissons in Completed Lining

danger that the ground will suddenly give way and that several caisson rings will drop below the bottom of the lining. This is all right as long as the top ring does not drop below the lining.

33. Begin excavating in shallow layers, first in the center of the shaft and then under the ring. Dig evenly around the ring to prevent it from sinking out of line. As you excavate, the well shaft and the caisson rings will gradually sink into the aquifer and the shaft will begin to fill with water. Dig until the water becomes too deep for working, or until you are satisfied that the well will yield sufficient water. See Figure 11.

If you wish to remove water from the shaft while excavating, bail it out with a kibble. Do not pump out water with a mechanical pump, for that can cause the aquifer to collapse.

34. Set a base plug in the bottom of the shaft as shown in Figure 12. The plug can be made of porous concrete precast at ground level, or it can be made from layers of sand and gravel. If it is precast, it should have handles for lifting and removing it. The purpose of the plug is to prevent aquifer materials from rising into the well.

35. Unless the caisson rings have been sunk during the dry season, you may have to deepen the well during

the dry season. If so, you should add more caisson rings at that time.

36. Fill the space between the caisson rings and the concrete lining with small-sized gravel.

37. To build the wellhead and finish the well, see "Finishing Wells," RWS.2.C.8.

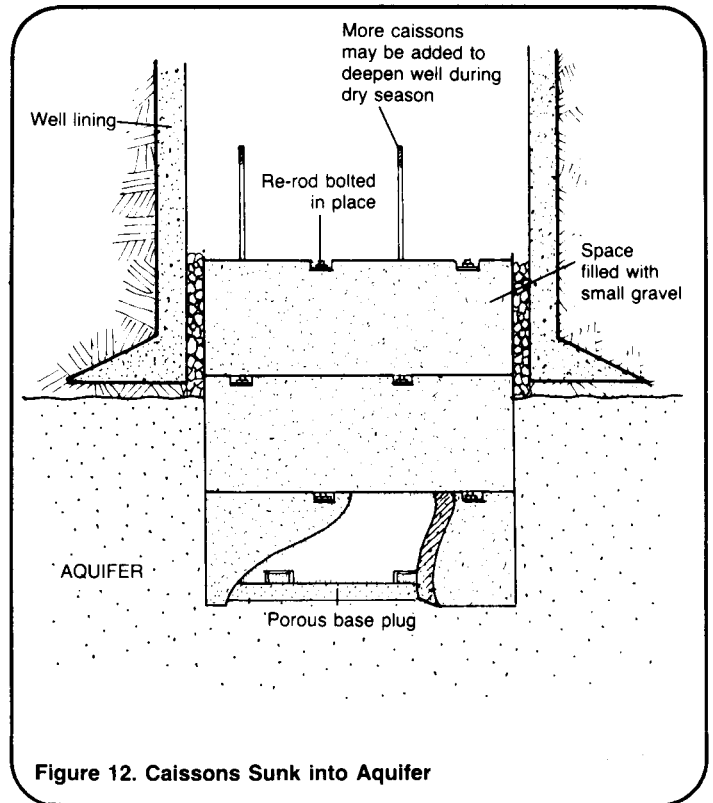

Figure 12. Caissons Sunk into Aquifer

**Technical Notes** are part of a set of "Water for the World" materials produced under contract to the U.S. Agency for International Development by National Demonstration Water Project, Institute for Rural Water, and National Environmental Health Association. Artwork was done by Redwing Art Service. Technical Notes are intended to provide assistance to a broad range of people with field responsibility for village water supply and sanitation projects in the developing nations. For more detail on the purpose, organization and suggestions for use of Technical Notes, see the introductory Note in the series, titled "Using 'Water for the World' Technical Notes." Other parts of the "Water for the World" series include a comprehensive Program Manual and several Policy Perspectives. Further information on these materials may be obtained from the Development Information Center, Agency for International Development, Washington, D.C., 20523, U.S.A.