

# Village Science

by Alan Dick

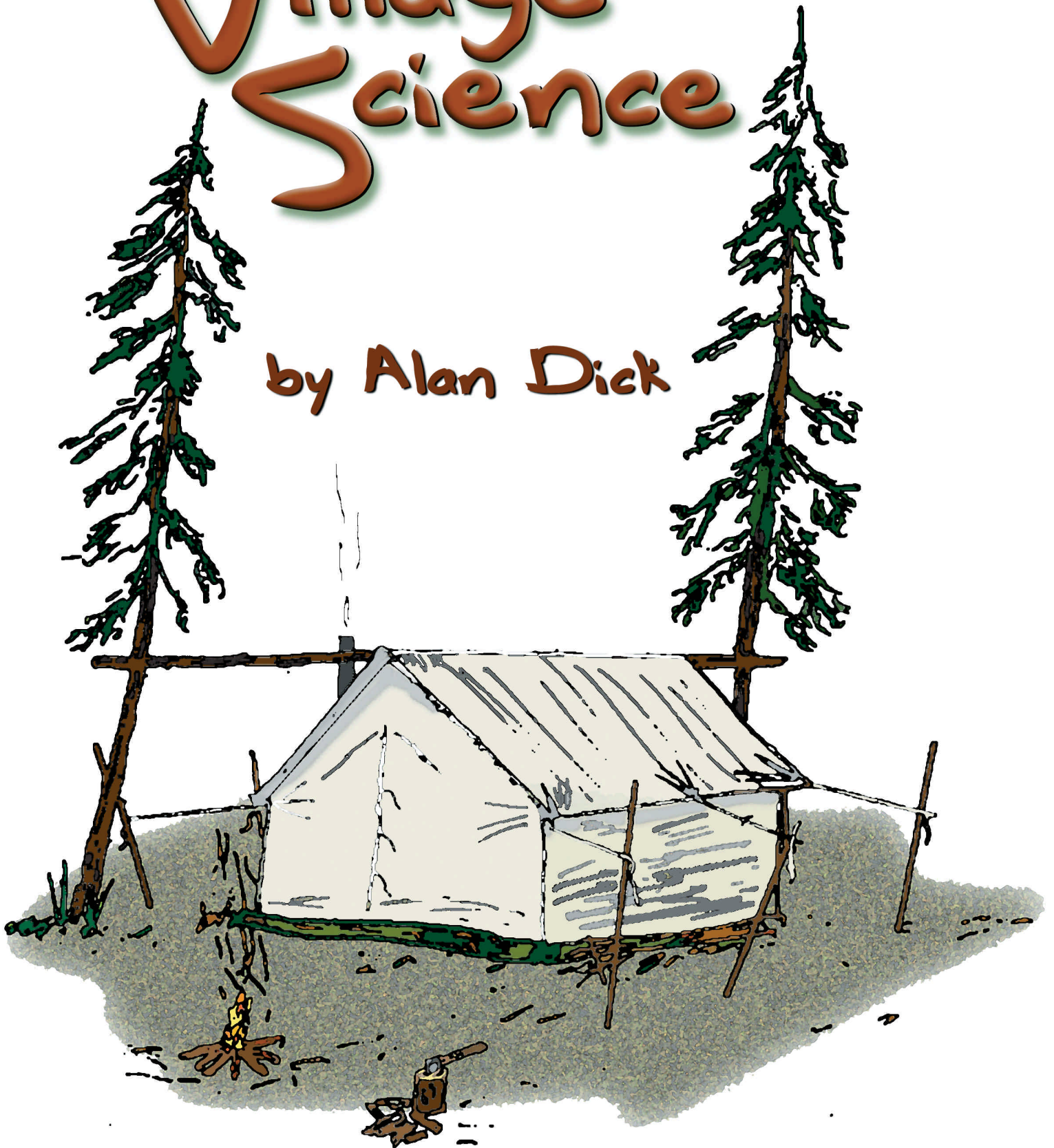

Alaska Native Knowledge Network





Village  
Science

Alan Dick

Alaska NaTive Knowledge NeTwork

Alaska Native Knowledge Network  
University of Alaska Fairbanks  
P.O. Box 756730  
Fairbanks, Alaska 99775-6730

©1997 by Alan Dick  
All rights reserved.  
Printed in the United States of America

Previous pilot edition printed April, 1997  
First printing August, 1999

I thoughtfully dedicate this book to my mentor of many years, Sinka Zaukar of Sleetmute, Alaska.

He was one of the most articulate and intelligent people I have ever met, yet his name can be found in no school records.

As I have written this book, I have heard his voice many times in my head and heart, and have recalled the same images that were present when we talked and did so many things together.

Without him and his perceptions, this book would not exist in any form, nor would my life be remotely the same.



# To The STUdENTs

I wrote this book to share with you some of the things I have learned over the years. If I were to teach you in person, we wouldn't follow the format of this book, but this is the best I can do from here.

I have lived in the Alaska bush since 1966. My wife, Helen, is from Lime Village, a small place with only forty to forty-five people.

We are both over fifty now and have five children, Anna, Elizabeth, William, Rachel, and Wayne. You might know them, or your older brothers or sisters might have played basketball with them. They played their high school years in McGrath. We have eight grandchildren, the oldest is ten and the youngest is almost one. We have lived mostly on the Kuskokwim River from Bethel and Aniak upriver to Sleetmute, Red Devil, Lime Village, McGrath, and Telida.

I have always loved science because it has made the world less threatening. While the world is certainly filled with mysteries that I will never fathom, the basic physical principles by which it works have remained the same for thousands of years. The same principles that keep the earth in orbit around the sun operate in the clutch of a chainsaw. I like that. It makes the physical world more predictable. Understanding science has kept me from being stuck in out in the woods lots of times. I can figure things out.

I have shared my ideas in this book as simply as possible. In my next book, I will show you the thinking skills I used along the way. This book is mainly facts and activities. I hope you enjoy reading and doing it as much as I have enjoyed writing it.

Thanks for using my book.

Sincerely,

Alan Dick





# Skills, Tools & Craftsmanship

Chapter 1: Cutting & Drying Fish

1

Chapter 2: Sharpening Tools

11

Chapter 3: Nails, Pegs, & Lashings

21

Chapter 4: Falling Trees &  
Small-Scale Logging

29

Chapter 5: Guns

35

Chapter 6: Chainsaw Clutch & Chain

47

Chapter 7: Ice pick

53

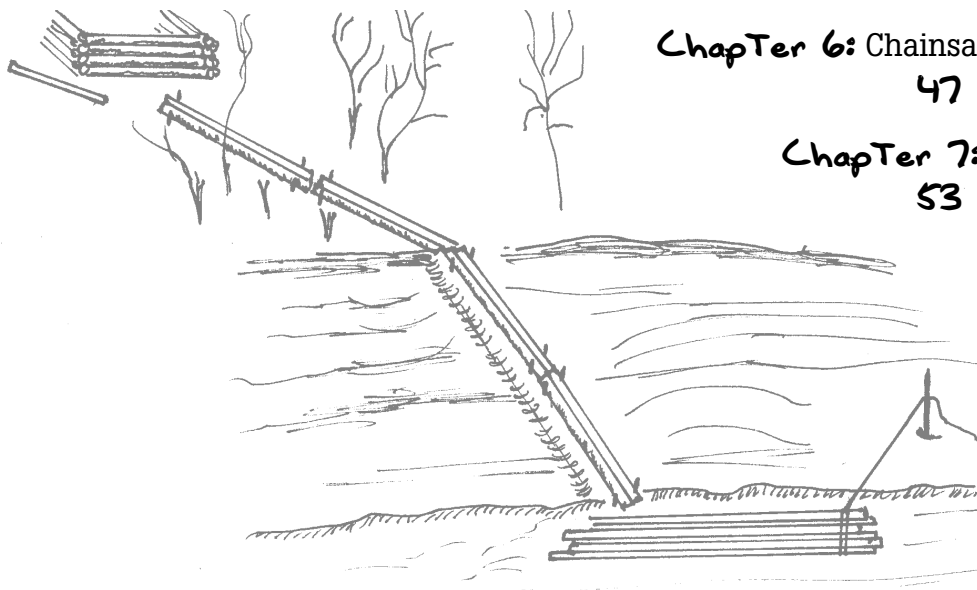
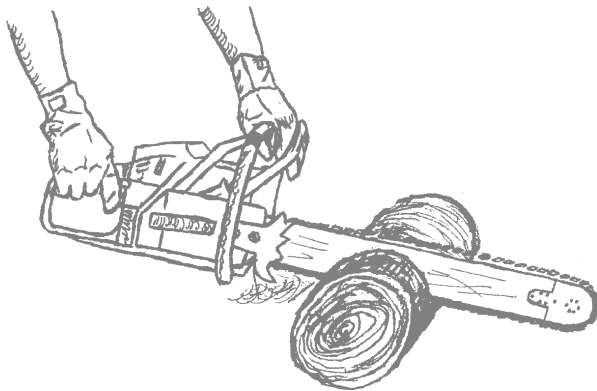



## Chapter 1

# Cutting & Drying Fish



Traditionally, fishing has been the core of subsistence life throughout most of Alaska. Oldtimers always said, "Fish as if you wouldn't catch any animals all winter. Then if you do catch something, you will do well. If you don't catch any animals, you will get tired of fish, but you won't starve."

Until recently, there were no freezers and people had to find ways to preserve the fish they caught. Oldtimers made drying fish an art form. Some families made better fish than others, but all families recognized the life and death issues involved in putting fish away for the winter.

Many of the same principles involved in drying fish also apply to drying moose, caribou, seal, and other meat.

### The Opposition

There is opposition to those who attempt to dry fish:

- Bacteria that cause rotting
- Blowflies that lay eggs that turn to maggots
- Ravens and seagulls



One of nature's purposes for **blowflies** is to consume spawned out salmon so their dead bodies won't contaminate the river for the whole summer. Blowflies and the resulting maggots can remove a whole fish in only a few days. There are more blowflies upriver than downriver because their purpose is naturally fulfilled at or near the spawning ground. Downriver people have much less problems with blowflies than upriver people.

Many people on the coast of Alaska don't use a smokehouse. There are fewer flies and more wind. However, fish hung in the open must be protected from seagulls and ravens.

#### Standards

A 2, 14, 15  
B 1, 3  
C 3  
D 1, 3

#### Concepts

Leverage  
Evaporation  
Friction  
Surface area

### Objectives

Our objective is to put food away when there is an abundance so we might eat in times of lack.

*There are three ways of preserving fish:*

- **Freezing** solidifies the water in the fish and lowers the temperature below which bacteria are active.
- **Salting** in a barrel removes much of the moisture and creates an inhospitable environment for the bacteria.
- **Drying** fish in the presence of cool, dry smoke removes the moisture necessary for bacterial growth.

## Conditions

There are a couple of conditions necessary for fish to rot:

- There must be enough **moisture** for the bacteria to grow. Drying removes the necessary moisture.
- The **temperature** must be above freezing for bacteria to flourish. As the temperature goes up, bacteria become more active. However, fish oil can chemically decompose apart from bacteria at temperatures well below freezing.

### *Blowflies*

There are two conditions necessary for blowflies to reproduce on the fish.

- There must be **moist places** on the fish. Once a crust is formed, the blowfly eggs cannot mature. The first few days of drying are critical to preventing maggots.
- There must be a **healthy environment** for the blowflies to thrive. Smokehouses are constructed to create an environment that the flies cannot stand. They have an excellent sense of smell and easily find the fish, but cannot penetrate the smoke to lay their eggs. We often put the freshly cut fish closest to the smudge pot. Once a crust is formed, those fish can be moved to make room for fresh fish.

Some people leave their fish outside for the first day or two to get a good dry crust on them and then bring them inside the smokehouse. Other people bring their fish straight to the smokehouse. Many people soak the fish in salt and/or sprinkle them with pepper to keep the flies off the fish. Salt and pepper add to the taste after the fish is dry.

### *Compromise*

There is a delicate balance between smoke and fresh air. Many smokehouses have doors and vents that can be opened or closed to control that balance.

There is a tradeoff. If there is a lot of fresh air around the fish in the smokehouse, they dry fast, but it is hard to keep smoke around the fish with a strong breeze blowing.

Rotting is slow. Blowflies are fast. I tend to err on the side of slower drying with adequate smoke.



## Smokehouse Roof

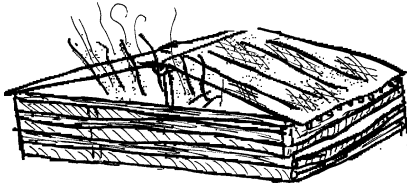

Smokehouse roofs often have a rather shallow pitch to hold smoke down around the fish. Since blowflies need wet or damp fish to lay their eggs, a good smokehouse roof is most important. A leaky roof brings them a banquet. Days later the sun might be shining, but inside the smokehouse it could be raining maggots! Even fish that were once dry can become maggot infested if rained upon. Once they have infested a fish, it is not likely to dry. Smoke repels mature blowflies but not maggots.

People have tried screening in their smokehouses to keep the flies out. This helps a little, but blowflies have an amazing ability to crawl through cracks. Few people who have screened once, try it again.

## Temperature and Materials

Fish need to be kept cool or they will rot. A hot smokehouse creates sour fish. Steel siding absorbs and conducts heat, making the smokehouse very hot in the sun. Much better are plywood, lumber, spruce-bark slabs, or spruce-bark sides. Spruce bark is wonderful. It is cool, and allows a gentle flow of air through the knot holes and other cracks. It is not very durable and definitely not bear proof. Skill is required to remove the bark from the tree in usable pieces. Ask the local elders how it is done.

## Brush

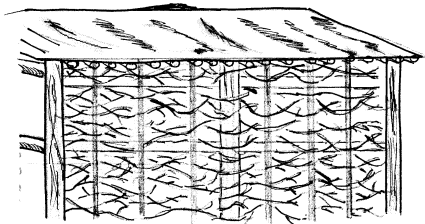

When oldtimers were trying a new place to fish, they didn't want to spend a lot of energy building a smokehouse until they found out if the location was good for fishing. For a temporary smokehouse, they put poles on the sides of the smokehouse and wove brush in and out of those poles. This is an easy and effective way to keep smoke in, but after the brush dries, it is a real fire hazard. I made a smokehouse with brush sides once and was very satisfied. However, the second year, when the brush had dried, it became a firetrap.

## Location

Fish cannot become drier than their surroundings. Damp ground makes damp fish. Most smokehouses are on top of a bank so they can catch a gentle breeze as it blows up and down the river. If the smokehouse is by a creek in a narrow valley, the fish will be damp because of the closeness to the creek. The drier the ground, the better the fish will be. Some oldtimers located their smokehouses on small hills beside the fishing site so the fish could dry well. This meant carrying each fish up the hill, but it was worth the effort.

Most people cut brush and grass surrounding their smokehouses to increase the air flow and to remove where bears might hide.

## Weather

The weather has a tremendous effect on the fishing operation. If the fish isn't dry and put away before wet weather arrives, they are apt to mold. In our region, silver salmon are seldom dried because they arrive during the wetter part of the summer.

If the weather is damp, fish cutters make the blanket fish and strips thinner to dry faster. One time I cut eating fish too thick, not wanting to waste any. I ended up wasting a lot of fish because it became sour before it dried.

### *Smudge Wood and Weather*

Many people like to use alder or cottonwood to smudge the fish. During cold, damp, and rainy weather they use birch because it provides a small amount of heat and helps dry the fish. Birch also adds a different flavor. Very few people use spruce.

## The Secret

The secret is to keep flies out while providing as much **dry, cool air** as possible. Making good dry fish is the result of knowing the fish, the weather, and the environment surrounding the smokehouse. Oldtimers were, and still are, very particular and very proud of their fish.

## Cutting Fish

There are many factors that determine how we cut and prepare dry fish.

- Availability of materials for a good smokehouse
- The ground and surroundings of the fish camp
- Weather
- How full the smokehouse is
- Availability of wood for smoking the fish.

There are many techniques for cutting fish. Everyone has their own method. The main thing is to cut the fish so it can dry quickly by exposing as much surface area to the air.

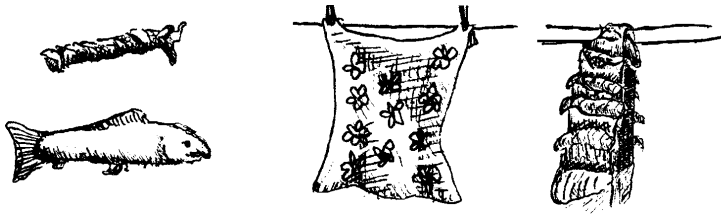

Imagine two wet towels. One is rolled up and hung on the clothes line. The other one is spread wide and hung on the same line. Which one will dry faster?

The one that is spread out will dry faster because it has greater **surface area** exposed to the breeze. The same is true for fish. The more surface area we can expose, the faster it dries.

The traditional way is to cut the flesh away from the backbone and ribs, and score the fish many times to create folds of flesh that hang exposed to the smoke and breeze.

*Dog feed vs. eating fish*

A salmon has five sets of bones. The main difference between eating fish and dog feed is that eating fish (for people) don't include the rib bones. It takes more time and care to separate the meat from the rib bones, but the time is well spent.

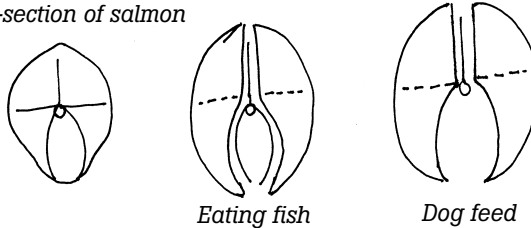
*Cross-section of salmon**Balance*

Whatever cutting style is used, care must be given to ensure that both halves weigh approximately the same. If one side is heavier than the other, the fish will constantly slip off the pole.

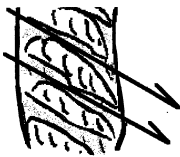
*A Refinement*

If the fish cutter scores the fish down at an angle, it allows moisture a way to run off.

**Fishrafts**

Many families who fish use a fishraft that is tied to the riverbank. They are a good place to store fish and make a convenient, clean place to cut fish. Many people have a fish table on the raft. This saves the backbreaking effort of bending for hours at a time. Many people put gunny sacks or spruce bark on the surface of the table to increase friction with the very slippery fish while they are being prepared. Gunny sacks and spruce bark are easily cleaned by dipping and scrubbing in the river.

Most people use wire mesh between the logs to hold the fish. Moldy fish heads that have been in the fishraft for over three to four days are ready to feed to dogs. Fresh salmon are indigestible and make the dogs sick.

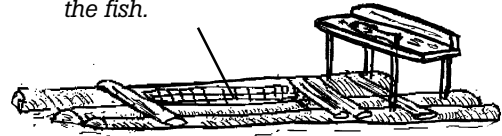
*Wire in the water to hold the fish.***Fishpoles**

Sometimes the fish are too slippery to stay on the pole, particularly if the fish aren't balanced.

I can remember nailing one fish to the pole; I was so frustrated having to hang it up again and again. Later I learned to put grass between the

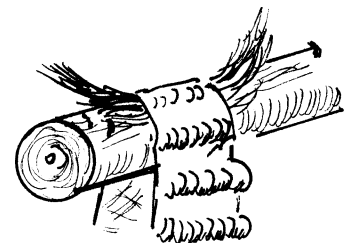

pole and the fish. This increased the friction between the two and actually dried the fish on the point of contact.

Spruce poles are the most satisfactory. The bark is rough enough to hold most fish from sliding.

## Upriver Trick

Fish caught downriver are in good shape—fat and silvery in skin color. Fish caught upriver are very lean. They often dry out brittle and hard to eat. One trick upriver people use is to leave the fish in the fishraft overnight. They must be under water. The enzymes in the fish soften the meat and make the fish better eating when dry. However, this method makes them prone to sour and should only be done in good weather. Sometimes people leave the fish in the raft overnight because they are lazy. Special care must be given to fish or they will easily sour.

## Storing Dry Fish

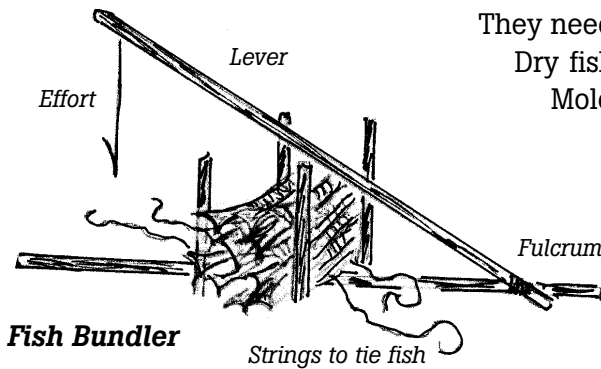

A well ventilated cache is the best place to store dry fish. They need to be off the damp ground and under a good roof.

Dry fish can mold if they become the slightest bit damp.

Moldy fish doesn't taste good at all.

Eating fish needs to be stored in a very dry place. Nowadays people vacuum seal eating fish and store it in the freezer with a little vegetable oil.

This is by far the best way if you have a freezer.

We used to bind dog fish in bundles of forty. We drove four stakes in the ground, stacked fish between the stakes, alternating

head and tail. We used a big lever to crush the fish together, and tied them with rawhide. Damp rawhide works best because it shrinks and tightens when it dries.



## Activities

1. Look at and discuss the smokehouse locations in and around the village. What do they have in common? In what ways are they different? Find some of the older fishcamp sites in your area. Why were they located there?
2. What are the common materials for smokehouse roofing and siding? Are the roofs relatively flat or do they have a steep pitch?
3. Ask what local wood is used for smudge fire. What is that fire called in your village?



4. Ask people in your village what changes they make in their drying process when the weather turns bad.
5. Do people in your village usually bring the fish right into the smokehouse after cutting or do they leave them on poles outside for a few days to get a dry crust?
6. Make a trap for blowflies like a fishtrap. Use a jar with a screen for the funnel. Use a piece of sour fish for bait. Can you reduce the number of blowflies in your area?
7. Cut a fish into three pieces. Put one in the freezer. Score the other and hang it to dry. Leave the third one, as it is, in a warm place. In a day or two, compare the three. What can you say about preserving fish?
8. Leave a fish outside where blowflies can lay their eggs. Once the maggots start to crawl around, bring the fish into the smokehouse and put the fish directly into the smoke. Does the smoke get rid of the maggots? Does the fish ever dry properly? What can you say about prevention being better than a cure?
9. Get samples of different people's fish throughout the village. Being careful not to insult someone's cutting style, compare them. Compare dog fish and eating fish.
10. Why do people cut king salmon in strips rather than flat like red salmon or other eating fish?
11. Try to find some dry dog fish that has the evidence of maggots. Can you see and smell the difference from that part and other unspoiled parts?
12. Ask someone how to cut whitefish in the fall. How is this different from salmon in the summer? Why do you think there are differences? Distinguish between cutting for dogs and for people.
13. Hang fish on a spruce, birch, or willow pole. Can you tell the difference in terms of friction between the pole and fish?
14. How are salmon bundled and stored in your village? If this is a thing of the past, ask how it used to be done.
15. Why do people make and use fishrafts? In your village, what do they use on top of the cutting table to keep the fish from slipping around?
16. Find out about the fermenting methods used in your village for preparing fish heads. Have you ever tried "smelly heads?"



## STUDENT Response

1. What are the two oppositions of those trying to dry fish?
2. What keeps blowflies away?
3. What requirements are there for fish to rot? Which of these is the easiest to remove?
4. What are the factors that determine how we cut and prepare fish?
5. Why is a good roof so important for a smokehouse?
6. What are some of the better materials for smokehouse sides? Why is sheet iron not the best?
7. Describe what makes a location good for a smokehouse.
8. What is the secret of drying fish?
9. \_\_\_\_\_ is increased when we cut fish. This speeds the drying process.
10. What changes need to be made in the way fish are cut during wet weather?
11. What changes might be made in the smudge wood during rainy weather?
12. What type of tree makes the best fishpole? Why?
13. Describe one way of bundling and storing fish.

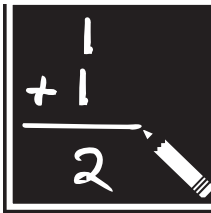

## Math

1. Nick has 7 dogs. He figures that he needs 1 fish per day for each dog from freezeup to breakup, from October 1 through May 7. How many fish does he need to dry for the winter? (He can feed them fresh fish from his net during the summer.)
2. Nick manages to get 1,400 fish. He gives away 2 dogs on January 1. Will he have enough fish to get through breakup on May 7?
3. Marjory has 5 dogs to feed from October 1 through May 7. She plans to cook for her dogs, supplementing with oatmeal. She will only need a half a fish per day for each dog. She has 600 fish. Will she have enough fish to make it to breakup?
4. Nick (from problem #1) has a chance to go to work instead of fishing. He figures that he can make \$1,800 (after taxes) in the time he might be fishing. It costs 50 cents per day to feed a dog. Financially, is he better off fishing or going to work?

5. At 50 cents per day for commercial dog food, how much does it cost to feed a dog from October 1 through May 7 for the life of the dog (12 years)?
6. Henry's smokehouse has poles that are 6 feet long. Each pole can hold 9 fish on average. He counts the poles and finds that he has 127 poles full of fish. He needs 1400 fish to get his dogs through the winter. Can he stop fishing or should he fish more?
7. In Ed's village an average king salmon dries out to 5 pounds of strips. He has 90 pounds of strips, but he needs a total of 150 pounds to get through the winter if he will have enough to give away at Christmas. How many more king salmon does he need?



## Chapter 2

# Sharpening Tools

A sharp tool is truly a thing of beauty. A dull tool is the cause of frustration and discouragement. I wish someone had taught me as a young man how to sharpen things. It took many years to learn. I was often frustrated. I did poor work, and broke many of the projects I was working on.

There is a unique feeling that comes from passing a hand plane over a board, producing a long thin shaving, or passing a sharp knife through a fish, and with a few strokes, have it ready to hang on the rack.

The idea behind sharpening an edge is simple. Reduce the surface area of the blade so it will penetrate the wood, meat, fish, ice etc. with as little effort as possible. A sharp tool penetrates easily. A dull tool has greater surface area on the edge, and resists penetrating.

The difference between sharp and dull is most noticeable when using hand tools. When using power tools the motor does the work.

My wife's grandma tested her knife by holding up a hair. If she could cut the dangling hair with one pass of her knife it was sharp enough for tanning and making rawhide. I have experimented for years trying to learn how to sharpen to that level.

There are three considerations in sharpening a tool:

- At what angle is the edge formed?
- How thick or thin is the actual edge?
- How rough or smooth is the edge and sides of the blade?



### Angle

Many directions for sharpening say, "Sharpen the tool at 30° or 25°." The **material** we are cutting and the **toughness** of the **steel** in the blade determine the best angle to sharpen the edge. I often wonder how the manufacturer could pretend to know what I am cutting.

### Picture the Extremes

How thick or thin should I make the edge?

Imagine trying to chop a tree with a splitting maul. The blade is too thick. It will never penetrate the wood deeply

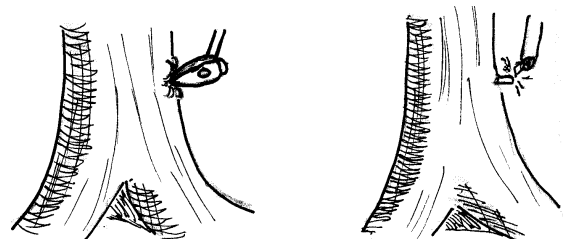

#### Standards

A 15  
B 1, 3  
C 3  
D 1, 3, 4

#### Concepts

Surface area  
Leverage  
Friction

enough to chop down the tree.

Imagine again trying to cut down the same tree with a razor blade. The blade can penetrate the wood fibers, but is so thin it will break on first impact.

Conclusion: if a blade is too thick, even if the edge is sharp, it will take too much energy to penetrate. If the edge is too thin, the blade will break.

#1



*Most of the force is downward, not sideways as desired to part the material*

## Direction of Force

Consider the direction of the force you are using.

If the blade is shaped like #1 on the left, much of the force used to cut (penetrate) is used in pushing the material away. Little of the force is used in parting the material, which is what you want.

If the blade is shaped like #2, the blade will penetrate easily, but the slightest sideways motion or hard obstacle will break the thin steel. This is the shape of a razor blade. It will cut hair (and skin) well enough, but couldn't be considered for wood or bone.

What should the angle be for sharpening a blade? Once you know the quality of steel in the blade and the material you are cutting, then you can figure out the answer to this question.

#2



## The Rule

You want an edge thin enough to penetrate easily, and thick enough to last a while.

If you are sharpening the edge often, you need to thicken it a little. If you are working too hard, thin the edge a little.

## Mixed Material

If we cut only soft wood or meat, it would be easy to figure how to sharpen an edge. However, wood has knots, meat has bones, and so do fish. If we sharpen a knife to cut fish and don't think of the bones, our knife will soon be dull.

## Width of the Edge

The actual width of the edge is very important. If you were to look at a dull edge under a magnifying glass, it would look like this:

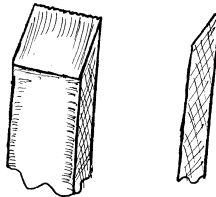

If the surface area of the edge is reduced, the pressure required to penetrate the material is greatly reduced.

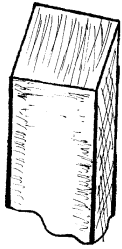

With a sharp edge like the one on the left, the surface area is almost zero, and all the force can be used in separating the material. This makes a tremendous difference if you are cutting fish all day.

If the edge is chipped, it obviously has a large surface area that resists penetrating the wood, meat or fish. One chip in a knife or axe can make a tiring difference.

New axes or other tools always come with an edge that is far too thick. You must thin the edge to your needs.

As you sharpen, there will be a hair of metal that clings to the edge of the blade. In some applications, you will want to remove it, but for cutting fish or meat, that "hair edge" helps sever the meat.

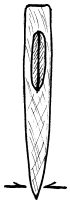

Grind to desired thickness

### Digging Tools

A hoe, pick, or shovel should be sharpened to make digging easier. The thickness of the edge is determined by the kind of dirt you are working. If it is loose soil with no rocks, the edge can be thin to cut roots. If there are hard rocks in the soil, the edge must be thicker.

### Sharpened on One Side

Some tools are sharpened on one side only. Oldtimers used to sharpen their axes on one side for chopping and shaping boat and sled parts. Shovels, hand planes, drills, circular saw blades, etc., are all sharpened on only one side. Traditional tanning and skinning knives, including ulus, are sharpened on one side.

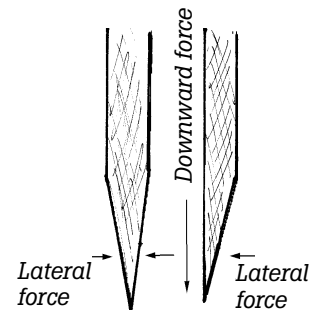

The flat surface of the blade on the right will follow straight down a skin or wood surface without deflecting as the one on the left might.

### Rough or Smooth

If an edge is rough, it will have considerable friction with the surface it is penetrating. When cutting wood, a very smooth surface makes entrance of the blade much easier.

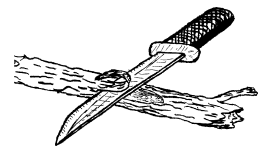

A. Fiber cutting tooth



B. Chisel tooth

### Swede Saw

Years ago, sharpening a Swede (or two-man saw) was an art that everyone knew. Since the advent of chainsaws, it is but a memory, but there are principles involved that apply in other blades. A combination blade for a circular saw has the same teeth as a Swede saw and cuts in an identical manner.

A Swede saw does two things in two directions:

1. The teeth shaped in figure A cut the fibers. They must have this shape as they cut in both directions, forward and backward.
2. The tooth in figure B chisels out the severed fibers. It is very important



Saw teeth "set" to either side of center line

that the chisel teeth be **slightly lower** than the cutting teeth mentioned above.

The chisel teeth remove the severed wood fibers to make room for the cutting teeth to go deeper.

"**Setting**" a saw means bending the tips of the teeth slightly outward so the cut is wider than the thickness of the blade. If there is no set to a blade, friction with the sides of the cut will tire the loggers very quickly. If the set is too wide, the loggers work too hard removing more wood than is necessary.

The sides of the blade must be smooth and rust free. The friction of a rusty saw blade in the cut is tiring, especially when it is a pitchy spruce tree. Some people lubricate the blade with a bar of soap.

## Stones, Files, and Steels

There are three ways to shape a blade:

- With a **file**. Files work well on softer steels.
- With a **stone**. Hand stones do well on hard steels, but don't work as fast as files.
- With a **sharpening steel**. Steels put a good finish cutting edge on a knife to be used for meat or fish. They don't remove much material. They shape and texture the edge. Some sharpening steels are embedded with durable diamonds. Some sharpeners are made of porcelain.

### *Coarse or Fine?*

How much of the blade must be removed?

**Coarse.** If there is much steel that needs to come off, a coarse file or stone is faster. However, caution must be taken with electric grinding wheels. Friction overheats the blade so that it loses its temper<sup>1</sup>, turning the edge soft and blue. It will then dull quite easily. Fine knifemakers grind the blades under water to keep the steel from overheating and to keep the grindstone from plugging with filings.

**Fine.** If there isn't much steel to remove, a fine file or stone is in order to put the finishing touches on the edge.

### *Care of Stones*

Some people oil a hand stone to float the ground steel filings. Other people use saliva. Either method keeps the stone from becoming glazed and plugged. It can't cut steel with the abrasive particles hidden under a layer of debris.

Plugged stone

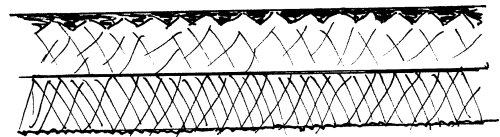

1. Temper means hardness of the steel. Steel can lose its temper or hardness if it is heated and cooled slowly. Temper is created by heating the steel to a given color—blue, red, white—and quickly quenching (cooling) it in cold water. This hardens the steel. Some steels are easy to temper; others because of their low carbon content, are difficult or impossible to temper.



### Care of Files

When filing, it is important to put pressure only on the forward stroke. The teeth are strong in a forward direction. If pressure is applied on the back stroke, the teeth are damaged.

Files must be protected from moisture. They rust easily. Also, they become dull when they impact other hard metals. Oldtimers often wrapped a file in an oily cloth to protect it from rust and contact with other tools.

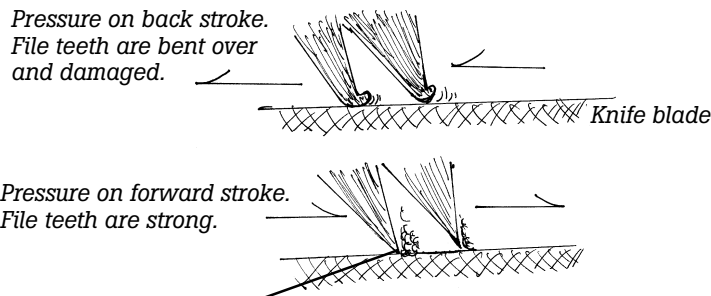

### File or Stone?

How hard is the steel you are sharpening? I prefer to use a file on softer steels. If the steel of the blade is as hard or harder than the file, the file will slip on the blades surface. The result is a damaged file (expensive).

For me, files work much faster than stones. I avoid buying knives and axes that are too hard. Granted, the harder steels keep an edge longer, but they are far more tedious to sharpen.

### Hardened Steel

If an axe strikes a rock, the steel at the point of impact is **hardened**. When an individual goes to file the axe, the hardened spot will destroy the file within a few strokes. Careless people don't understand the damage they do to an axe by driving it into the dirt.

## Sharpening a Chainsaw

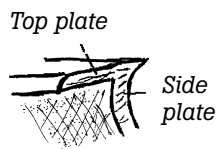

There is nothing mystical about sharpening a chainsaw. Like a Swede saw, it is cutting simultaneously in two directions.

- The side plate severs the fibers.
- The top plate chisels the fibers out of the cut.

### Cutting blocks of wood

The side plate angle is determined by what you are cutting. If you are cutting rather dirty wood, like driftwood, you might want to sharpen the side plate thicker at about 25°. This puts more steel behind the cutting edge for strength. If you are cutting very clean wood, you might be able to sharpen the edge thinner, perhaps 35°. A thinner side plate cuts faster and more efficiently, but dulls easier.

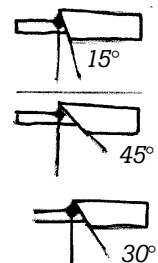

File too small



File too big

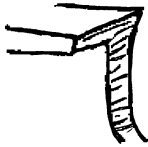

The top plate angle is determined by the file size. A file too small will undercut the tooth, making it very thin. A file too big will make the top plate too thick. It will scrape rather than cut the wood fibers.

### Ripping

Many Alaskans make lumber with a chainsaw. It is rough lumber and puts considerable wear on a saw, but in remote locations, there is no other lumber to be had.

The **top plate angle** is critical. Long shavings are being peeled out with the **grain** of the wood. If the file is too big and the resulting edge is too thick, ripping will be painfully slow.

The side plate angle isn't as important for ripping because ripping goes with the grain of the wood, not across it.

If the log is very clean, I use an undersized file. It gives quick, clean, long shavings (but dulls quickly if any dirt is encountered).

I often peel the trees before I rip them to remove the dirt hidden in the bark from flood waters of the past. Oldtimers peeled the trees before they cut them down with Swede saws to extend the life of the sharpened blade.

### Rakers

The rakers determine how deeply the chainsaw tooth cuts.

If the rakers are too high, the tooth cannot bite into the wood. The operator has to push very hard for the tooth to cut. The increased friction of this effort quickly wears the bar and chain.

If the rakers are filed to the proper length, the weight of the saw is enough to feed the saw into the wood.

If the rakers are too short, the chain will bite too deeply into the wood and frequently get stuck. Rakers that are too short produce very rough lumber and cause excessive clutch wear.

If the rakers are of even height, cutting is smooth.

If the rakers are of uneven height, some teeth will bite more than the others. Cutting is very erratic, putting great stress on the chain. The saw can easily kick back at the operator.

Getting proper raker height isn't important if you are only cutting a few boards. If you are going to rip much lumber at all, it is critical to file rakers to the proper height. For cutting blocks, standard raker height is .025". For ripping, I have filed them .030" to .035".

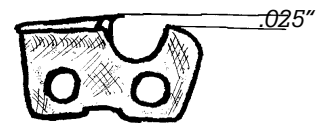



## Activities

**Note: In the following activities you are asked to use tools and blades. There is obvious danger. Be careful!**

1. Collect as many blades as you can. Identify tools for cutting wood, dirt, metal and food. Are they sharpened on one side or both?  
Look at the edges with a strong magnifying glass. Draw several of them.
2. How thick are the edges? Can you find a relationship between the materials they cut and the thickness?
3. Try to sharpen all of the above tools with a file. Are some of the edges harder than others? What do people use to shape and sharpen the harder steel tools?
4. Carefully test the blade of a hand plane with a file. Are both sides equally hard?
5. Tap the above blades with a piece of hard steel. Do any of them ring? (Small blades are hard to test.) What can you say about the steel that rings?
6. Carefully test a dull knife in cutting wood. Bring that same knife to someone who knows how to sharpen. Ask that person to sharpen the knife for you. Try it again. Is the difference noticeable?
7. Try cutting wood with a steak knife. What happens and why?
8. Try shaving a piece of wood with a razor designed for a man's face. Use gloves. What happens and why?
9. Try digging with a dull shovel, particularly in a place with grass or small roots. Sharpen the shovel. Do you notice any difference?
10. Look at a dull edge under a magnifying glass. How is it different from what you expected? Can you understand why pushing such a rough surface into your work is difficult? Now look at a sharp edge with the glass. Even this looks crude. Compare both blades in ten words or less.
11. Scissors don't cut the same way as a knife. Study scissors and describe how they cut.
12. Cut fish with a dull knife. Sharpen it and cut fish again. Estimate what percent of effort was saved by sharpening it.
13. Cut a block of wood with a dull chainsaw, timing the cut. Sharpen the chain and cut the block, again timing the cut. What is the difference?
14. Ask in the village if anyone knows how to sharpen a Swede saw. Ask the person for instructions.
15. Collect different files. What are the differences other than size? Put a piece of paper over the file and with a crayon or lead pencil do a "rubbing" of the file. Compare the imprints from the different files.

16. With an old file, file aluminum (like an old prop). What problem arises?
17. Compare the two sides of a sharpening stone. Which one is for faster and which one for finer sharpening?
18. Sharpen a knife for meat and finish the edge with a butcher's steel. Cut a little meat. Now try the same edge on wood. What do you notice? Strop the edge back and forth on a piece of leather for a while and then try again on both meat and wood. What do you notice? Which edge is better for meat, the rough or smooth one? Which is better for wood?
19. Students should each share a story of a time they cut themselves being careless with a tool.
20. Draw or trace a Swede saw blade identifying the two kinds of teeth. Describe to someone else how each of these relates to a modern chain-saw tooth.
21. Picture in your mind what would happen if a Swede saw blade had only this kind of teeth:



22. Picture what would happen if it had only this kind of teeth:



23. If you can get some beaver or muskrat teeth, test the front and back for hardness. Explain how they are self sharpening.
24. Picture in your mind what is happening when the rakers on a chainsaw chain aren't filed evenly. Can you imagine the jerking of the chain as some teeth bite deeper into the wood than others?
25. Put pressure on a bathroom scale with a fish cutting knife. Record how many pounds you can assert. Now put pressure with an ulu. How many times more pressure is possible with the ulu? Test the whole class. First let students estimate, the test. How many times more pressure can the ulu put than the knife? Average the results. How does the knife serve as a lever?



## STUDENT Response

1. What happens when an edge is too thick?
2. What happens when an edge is too thin?
3. What are the three considerations in sharpening a tool?
4. What two things determine how thick or thin an edge can be?

5. Draw a shovel blade sharpened for rocky ground. Draw one sharpened for ground with no rocks, but lots of roots.
6. What is the difference between cutting meat and wood in terms of the friction of the blade?
7. Draw a Swede saw blade. Which teeth are for cutting fibers and which for chiseling the severed fibers out of the cut?
8. Which is harder: a file or a sharpening stone?
9. An axe of fairly soft steel has a hard spot. What might cause this?
10. Why do people put oil or saliva on a sharpening stone?
11. Why do we put pressure only on the forward stroke of a file?
12. Draw a chainsaw tooth. Label which part severs fibers. Which part chisels the fibers from the cut?
13. What do the rakers do on a chainsaw tooth? What happens if they are too high? Too low?
14. Why should the height of the rakers be the same on all teeth?

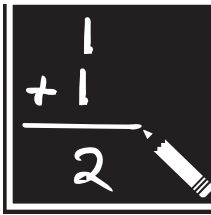

## Math

1. When Sal cuts fish she puts about 15 lbs of pressure on her knife. She finds that sharpening reduces the surface area of her cutting edge by 30%. How much pressure will she apply to do the same work?
2. Hank can cut a block of wood in 30 seconds when his chainsaw is sharp. It takes 1.5 minutes when it is dull. If he can cut a tree into blocks in 25 minutes with a sharp saw, how long will it take with a dull saw?
3. Hank also discovered that he could increase the speed of ripping 35% by filing the rakers on his saw from .025 to .040. If he could cut 350 board feet per day before, how much lumber can he cut with the rakers filed properly?
4. Hank estimated that it would take him 5 days to cut the lumber he needed. Once he filed the rakers, he cut 35% faster than expected. How long will it take him to cut the lumber now?

Let "x" equal the amount he could cut before filing the rakers.

$$[(x + .35x) = 5]$$



## Chapter 3

# Nails, Pegs, & Lashings

In traditional and modern lifestyles, we blend materials together to make homes and tools that best meet our needs. Often the materials are held together by fasteners: nails, screws, pegs, or lashing. Lashing might sound like an old fashioned technique, but it is the method most of us use to keep our shoes on every day.

Can you imagine trying to build a house without nails? Would you use string, glue, wire, rope? Our world would not be the same without nails.

Before there were nails in Alaska, the oldtimers used wooden pins as well as rawhide and root lashings.

In applications, like a dogsled, where the joined parts must be held together with flexibility, lashing works best. When I first came to Alaska, the teacher in Sleetmute made a sled and nailed it together. It didn't last a month. It couldn't flex enough.

**Rawhide lashing** is difficult to prepare and hard to protect from hungry animals of all sizes.

**Spruce roots** are wonderful lashing material, but they take considerable time and effort to collect and prepare.

**Pins.** It takes a long time to make wooden pins, drill the material, and set the pins.

When wood must be held firmly together, nails work well and are easy to drive.

### Standards

A 15  
B 1, 3  
C 3  
D 1, 3

### Concepts

Surface area  
Friction

### Different Nails

Nails are very different from each other for specific reasons. They vary in length, thickness, size of head, surface, coating, and other features.

Usually nails hold two pieces of wood together, or hold another material like tar paper, to wood.

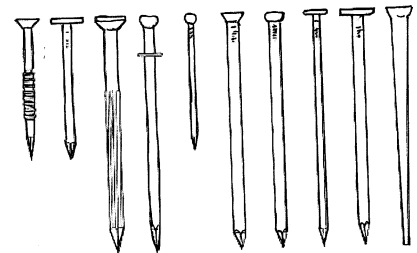

### Length

If a nail is too long, it sticks through both pieces of wood and can catch on clothing as people pass by. If it is too short, it can easily pull out.



### Thickness

If the nail is too thin, it will break under stress or bend before it is driven in. If the nail is too thick, it will split the wood.

### Texture

If the nail is too smooth, it pulls out too easily. If it is too rough, it cannot be removed if need be. "Sinker" nails have a green coating that reduces friction so they sink into the wood quickly. Ring and galvanized nails have very irregular surfaces, and are quite difficult to remove once driven.

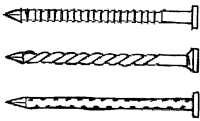

### Head size

If the nail head is too small, it might pull through the wood or material it is holding. Nails that hold foam have huge heads because the foam is so soft.

If the nail head is too big, it is unattractive when used in trim around doors and windows. The surface area of the head should be as small as possible, but adequate to hold the surface of the wood under all conditions of stress.

### Hard and Soft

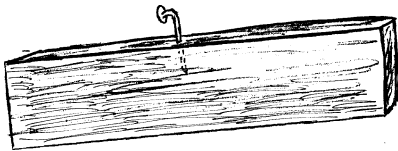

If the nail is too soft, it can't be driven into hard wood. If the nail is too hard, it is expensive to manufacture and purchase. Some nails are hard enough to be driven into concrete. Some screws, like drywall screws, are very hard, but so brittle they easily snap.

All of these variables determine what kind of nail we buy and how we use it.

## Special Nails

There are special nails for special purposes.

We used to nail steel roofing with colored nails with washers to seal out the rain. Now we use screws with washers that hold better in strong winds.

There are nails that have double heads. These *scaffold* (duplex) nails are used to build concrete forms or scaffolds on the sides of buildings. Since the scaffold will be removed when the building is done, there are two heads: one to hold the boards together and another to make removal easy when the job is complete.

Some nails are extremely hard so they can be driven into concrete, holding walls steady on a concrete footing. Concrete nails are often shot by a nail gun powered by a .22 cartridge.







**Ring nails** have their shanks intentionally roughed so they will hold more effectively. Boat builders use them, as the boat constantly works in the waves and current.

Some nails are glued together in a row, held apart by paper like the bullets in a machine gun. They are for **nailguns**. The nailguns drive these nails with 90 lbs of air pressure and nail twenty to fifty times faster than a carpenter nailing by hand. The added expense of the nails is overcome by savings in the carpenter's time.

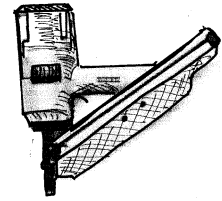

## Materials

Nails are made of different materials. Most are made of iron or steel which rust. Special boat nails are made of brass. Some roofing nails are made of aluminum.

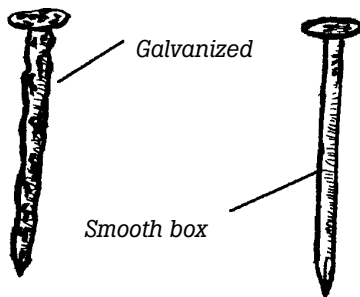

Galvanized (zinc) coating on iron nails protects them from rusting and holds them in place much better than smooth nails. The friction of the rough galvanized surface is much greater than the smooth surface of nails used for framing. Galvanized nails are used on plywood and T1-11 siding. Ungalvanized nails rust, even through paint, leaving long black streaks down the side of the building.

When oldtimers couldn't get galvanized nails for boat building, they put regular iron nails in a can or frying pan and put them in a campfire, allowing them to turn red hot then slightly blue when cooled. When treated like this, they have a hard oxide coating on the outside that resists rust.

## Pulling Nails

There is a trick to pulling nails that are rusted in place over time. Driving them farther in breaks them loose so they can be easily pulled out.

## Holding Power

As the nail is driven into the wood, the wood fibers are bent down, and held down by the shank of the nail. There is friction between the fibers and the surface of the nail. In order to pull the nail out easily, the fibers must be bent upward. A nail comes out smoothly once it is pulled the first half inch.

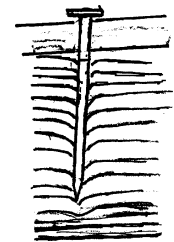

*Fibers bent down*

## Driving Nails

There are two tricks to driving nails so they don't split the wood. If you look at the end of a nail (big ones are more obvious than smaller ones) one side seems wider than the other. If the nail is driven with the grain

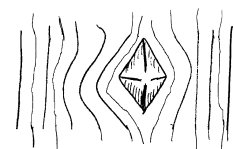

rather than against the grain, it won't easily split the wood. This is particularly important when building in cold temperatures when the wood is frozen.

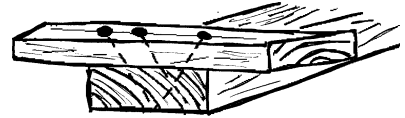

If a nail is first pounded on the point, and then driven into the wood, it doesn't easily split the wood. This is particularly important when the wood is frozen.

### *Extra Holding Power*

The way we drive nails determines how well they hold the wood together. If the nails are driven straight in, they can be pulled straight out. If they are driven in at different angles, they cannot be pulled straight out.

## Size Description

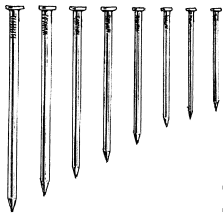

Nails are made in different sizes. Small nails are 2 penny, 4 penny, and 6 penny, written 2d, 4d, and 6d. Larger nails are 8d, 12d, 16d, 20d, etc. Nails have been around for so many centuries, no one knows where the expression "penny" came from.

## Pegs

Log cabins are often constructed without many nails at all. Notched corners and pegs hold the buildings together. Pegs are split from straight-grained dry or driftwood. Dogsleds were often pegged so trappers could take their sleds apart and tie them to the wings of small airplanes for beaver trapping.

The downward pressure on the logs, particularly with a cabin with a heavy sod roof, tend to spread the logs out as the round sides contact each other. (Wooden pegs are a must around doors and windows or the logs will slide off one another.) On the gable ends of the houses, pegs are most important as the heavy ridgepole and the weight of the sod roof press strongly downward.

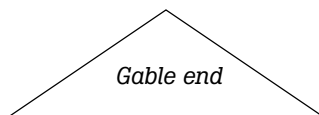

*With pegs*

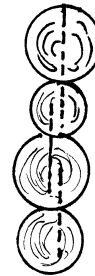

*Without pegs*



## Notching

Bottom logs which are notched to accommodate the top log promote rot, because they tend to collect water that runs down the walls. However, if the top log is notched and the notch hangs down, there is no surface for moisture to gather.

*Top notch log*

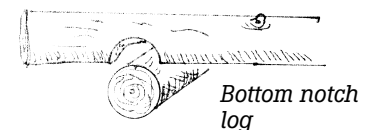

The split sticks in a fishtrap are often notched on one end. The notch and

lashing work together.

## Lashing

Spruce roots are the only proven lashing for fishtraps. As fall fishtraps in the creeks require constant cleaning, nails are a very poor substitute. They split the wood and cut the person's icy hands while cleaning the grass and leaves from the fences.

People have tried nylon and other synthetics for lashing, but they stretch too much. Manila and cotton twine rot too easily.

Roots are free to anyone in country where there are spruce or willows. There are specific knots for different applications. The elders know which ones work best in different situations.

Lashing with strong twine or cord works well on canoes and kayaks as it allows for flexing of the boat in waves and tough situations. Nails tend to split the wood.

While rawhide works well for dogsled lashing, it stretches when it gets wet in the spring and dogs like the taste of rawhide. Braided halibut twine seems to be the modern choice. It doesn't stretch too much, wears very well, and isn't palatable to animals. The nylon ends are commonly burned with a match to keep them from fraying.

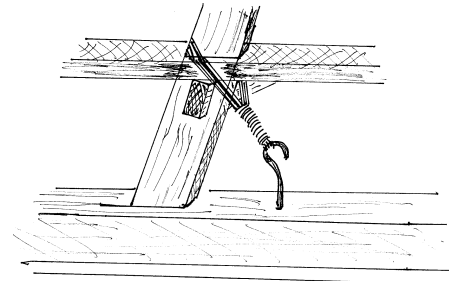

*Rawhide lashing*

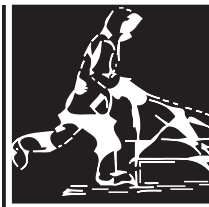

## Activities

1. Make a nail collection. How many different kinds can you find?
2. Try to identify the different purposes of each of the above nails.  
Try filing each nail. Are they harder or softer than the file?
3. File or grind a galvanized nail in one place, exposing the metal underneath. Leave the nail in a warm, damp place with a galvanized nail that hasn't been filed. Does rust appear where the galvanize was removed?
4. Find a building in town where the siding was nailed on with nails that weren't galvanized. Can you see the rust "bleeding" through the paint or down the side of the building?
5. Experiment with different nails: long, short, smooth, and rough. Can you determine why they are different? Drive each one into a board with the head slightly above the surface of the board. Pull them one by one. Do the

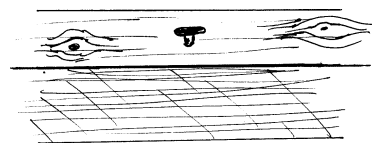

- ring nails or galvanized pull out easier or harder? Can you tell the difference?
6. Draw a nail that would hold two inches of foam to a wood surface? Imagine in your mind what would happen when the head of the nail pressed against the surface of the foam. How would you design a nail for this purpose?
  7. Drive nails into the end grain of a board. Do they hold as well, better, or worse than cross grain?
  8. Look at the point of a spike (end view). Can you see how one side is tapered more than the other? Draw what you see.
  9. Try the tricks mentioned in this chapter to prevent splitting at the end of a board. Do they help to keep the wood from splitting? Use green frozen lumber.
  10. Listen to a good carpenter drive nails on a surface like a floor or roof. How is his nailing different from that of an inexperienced person (apart from speed)?
  11. Research how nails are now made. Find a case of nails. Where were they made? How were nails made before modern machinery?
  12. How much does a pound of nails cost in the village? How much does this come out to for each 6d, 8d, and 16d nail?
  13. Pull some old nails from a board. Does driving them first to loosen them seem to help?
  14. If there is a nailgun in the village, have an experienced person demonstrate. Can ten students drive ten nails as fast as one person with a nail gun? What are the safety features of a nailgun so someone can't be shot with a nail? What are some of the hazards of nailguns? What can you learn about the pressure of the compressor, specifically the difference between a framing gun and a finish gun?
  15. Ask a good carpenter about hammers. What weight hammers are used for different applications? Waffle and smooth faces? What are the differences between steel, wood, and fiberglass handles? Why do people prefer one over another? Which hammers are better in different situations? Why do you think there is such a variety of hammers?
  16. Ask an oldtimer in the village to demonstrate lashing a fishtrap. What lashing material was commonly used? Videotape if possible.
  17. Ask a local sled builder to demonstrate how to lash a sled—crosspieces and stanchion—to the runner. Videotape to show others.
  18. If there is a log cabin in the village, inspect the corners and inspect the pins used. Are they spikes or wooden pins? What kind of wood was used for pins? Ask a local person where the pins were placed in the wall and why. If spikes were used, ask them how the holes were drilled to allow for settling of the logs.



## STUDENT Response

1. What will happen if a nail is too short? Too thick? Too smooth? Too thin?
2. Draw the type of nail that is used on tar paper and roofing shingles.
3. What kind of nail would you use on a boat?
4. Draw the end view of a nail. Show how it should be driven if it is close to the end of a board.
5. Draw a nail that would have high friction in wood. Draw one that would have low friction.
6. Draw a scaffold nail.
7. Why are galvanized nails used?
8. What is the name given to describe the sizes of nails?
9. Why were pegs used in log cabins?
10. Why are spruce roots superior to all other materials for a fishtrap?
11. What is the best lashing for a sled and why?

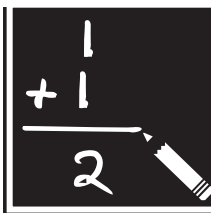

## Math

1. If a 50 lb. case of 8d galvanized nails cost \$57, what is the cost of 27 lbs at the same rate? 150 lbs?
2. Matt wants to use spikes on his cabin rather than wooden pegs. Spikes are \$.50 each. He figures that each log will average 3 spikes. There are 56 logs in the house. How much would wooden pegs save him?
3. If Matt's time is worth \$10 an hour and he can make 12 pegs an hour, which is cheaper?
4. Which is stronger: 4 larger nails with a shear strength of 65 lbs each, or 9 smaller nails with a shear strength of 52 lbs each?
5. Two carpenters frame a whole house. The total time of both workers is 80 hours using a nail gun (40 hours each.) They both make \$18 per hour. Without a nail gun, they will take 98 hours. The special nails for the nailguns cost \$100 more than regular nails. Nailgun rental is \$20 per day for 5 days. Are they saving money?
6. A 50 lb case of 16d galvanized nails costs \$57 delivered to the jobsite. A case of 16d sinker nails cost \$42 delivered, but Al figures that he has to use 20% more nails if he uses sinkers because they don't hold as well. Which is cheaper: sinkers or galvanized?

7. Sinker nails are \$1 a pound delivered to the jobsite. Scaffold nails are \$1.50 delivered. Building scaffolding takes 30 lbs of nails. Scaffold nails save 3 man-hours working at \$12 per hour. Are scaffold nails worth purchasing and using?

## Chapter 4

# Falling Trees & Small-Scale Logging

Without trees, life in most parts of Alaska would be impossible. Areas that don't have trees growing nearby rely on driftwood. Knowing how to fall or, as we say, "knock" trees is an important skill. Almost anyone can get a tree to fall over, but it is difficult to log:

- safely,
- with the trees landing and pointing in the same direction, and
- without getting hung up on other trees.

Instruction and experience help to develop the ability to safely log.

Smaller trees can be pushed down fairly easily by hand or with a long pole once the tree has been cut to the point of falling.

Larger trees, trees leaning in the wrong direction, and trees that can get hung on surrounding trees, pose problems of their own. Sometimes a logger may have all three problems in the same tree.

Few trees grow straight up. Most have grown leaning toward the sunlight, leaning from the wind, or leaning away from competing trees in the vicinity.

### Falling the Tree

1. The first thing to determine when falling a tree is the direction it is leaning. Is this the direction the logger wants it to go? If the answer is "yes", the process is easy.
2. Clear the brush away from the trunk of the tree. There must be room for the logger to work and to escape the falling tree.
3. Cut a notch in the tree perpendicular to the direction the tree is to fall.

The notch should be wide enough to allow the tree to lean over. If the notch is too narrow, the tree will start to fall and then hang on the notch.

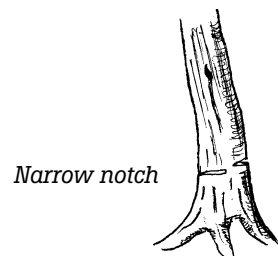
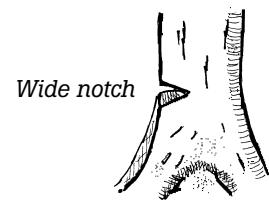

#### Standards

A 15  
B 1, 3  
C 3  
D 1, 3

#### Concepts

Inertia  
Friction  
Leverage

If there is no notch in the front of the tree a terribly dangerous situation exists, particularly if the tree is naturally leaning. When it starts to fall, the trunk of the tree splits throwing the logger and his saw quite a distance.

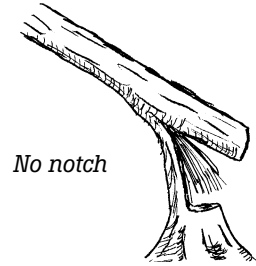

4. From the back of the tree, cut in the direction the tree should fall. If the tree is small it should be cut quickly so the inertia of the tree will carry it to the ground past the clinging branches of nearby trees and brush. If the tree goes down slowly, it will often get hung up before reaching the ground, therefore creating a troublesome or dangerous situation.

## Hinge

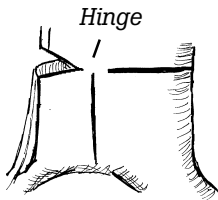

The wood that is left between the notch and the back cut is called the "hinge". If the hinge is too thick, the tree will fall slowly if at all. If the hinge is too thin, or cut completely through, look out! The tree can fall in any direction. The bottom of the tree can jump anywhere. It is a form of "widowmaker." (The logger's wife can easily become a widow.)

If the tree is leaning in a different direction than desired, the logger leaves more wood on one side of the hinge than the other. As the tree starts to fall, the uneven hinge will actually *pull* the tree in the direction the logger desires.

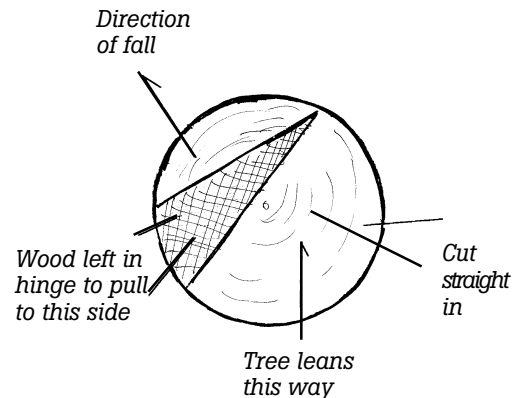

## Wedges

As soon as the saw is deep enough into the back cut, the logger puts a wedge or two in the cut behind the blade. If the tree leans backward, this prevents the saw from pinching. Wedges can drive even the biggest trees in the direction desired. One logger slowly saws the tree while the helper, "swamper", drives the wedges.

Plastic wedges driven with a small axe work best because they can take the impact of the axe without splitting and they don't dull the saw blade if hit by accident. Metal wedges are out of the question for this reason. Plastic wedges are cheap enough to be semi-disposable. Oldtimers used wooden wedges made out of dry spruce or dry tamarack. (Green wood is too soft.) Wooden wedges work as well as plastic, but tend to split after a few uses. The awesome power of a wedge should never be underestimated.

A good logger drives the wedge, waiting until the tree top moves. Then he cuts a little more before driving the wedge again. The logger continues in this manner as it takes time for the tree top to move.

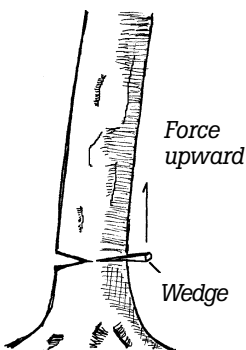



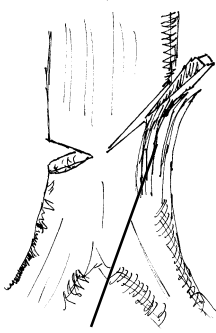

Split stump

It might seem like a waste of time getting trees to fall in a certain direction. When it is time to winch them out of the woods or to cut them up into firewood, having an orderly wood yard or logging operation saves immense amounts of time and frustration.

I used to make the back cut angled downward. This doesn't work with wedges, as they split the stump rather than driving and lifting the tree in the desired direction.

### Wind

When the wind is blowing in the direction the logger wants the trees to fall, the job becomes easy. As the surface area of the branches catch the wind, there is tremendous leverage from high up on the tree. When a strong wind is against the logger, it might be better to go home. Wind places enormous force on trees, making logging unpredictable and dangerous. Live trees have fuller branches, and are more strongly influenced by the wind than dead trees.

### Winter

In winter, trees are more brittle than in warm weather. They can snap and go down faster than in the summer. There is less warning if things aren't going the way the logger plans. Often the snow around the base of the tree makes escaping dangerous.

Many Alaskan logging operators prefer logging in March and April as the trees are cleaned when they are skidded on the snow. Logs skidded summer-time are impossible to clean thoroughly. They dull the saw blade quickly.

### Hangups

Everyone who has logged has hung trees in the branches of nearby trees. It happens. There is no safe solution. With a peavey, the logger can use its leverage, rocking the base of the hung tree, trying to get it to slide through the branches to the ground. This works occasionally.

It is very dangerous to cut down the tree that is hanging up the first one. I have gone home and returned after a wind storm, allowing the wind to wrestle the dangerous tree to the ground rather than risk freeing it myself. With a chainsaw winch, it is sometimes possible to hook onto the tree that is hung and pull it sideways. (I ripped a come-along apart one time trying to winch free a tree that was hung.)

The most dangerous situation exists when a tree has fallen and wedged itself between the trunks of two or three other trees. The hidden pressure on the tree can throw the logger and his saw for a long way when he cuts the tree free from its entanglement (Experience talking).

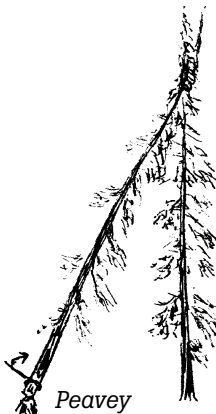

Peavey

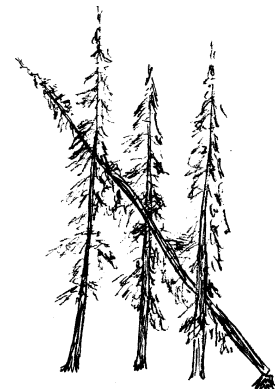

A dangerous situation

## Aftermath

While walking through a logging or wood yard, it is easy to see if the loggers are experienced. Sometimes I am tempted to look for dead bodies. Other times I can see that the logger was something of an artist.

Oldtimers always cleaned up their wood yard when they were done, often burning the branches. Nowadays, the Department of Natural Resources asks people to cut all tree tops to two foot lengths and to scatter branches. This allows them to dry quickly and prevents spruce bark beetle infestation.

## Skidding Logs

Green logs are very heavy. I heard someone say, "Don't think how big a house you want, think how big a log you can handle." Nowadays we have power tools and chainsaw winches. With a chainsaw winch and a snatch block (pulley) up in a tree to keep the front of the log out of the dirt, and minimize friction, one person can easily move forty foot logs.

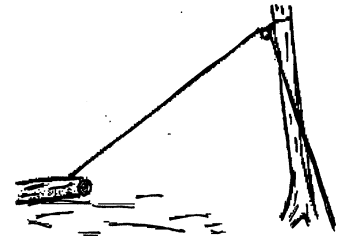

When logging in late May to early July, oldtimers used to fall the tree, limb it, and peel it, then skid the logs out of the woods on the smooth bark. Sometimes they lined up the bark from several trees like a trail to the riverbank. The slippery logs are easy to move on the equally slippery inner bark that was just removed from the trees. Friction is at a minimum.

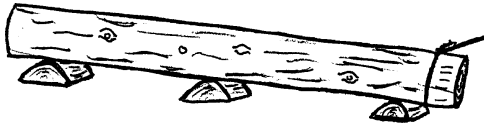

Before chainsaw winches were available, we often cut a spruce tree about six inches in diameter in three foot lengths. We peeled them, and split them in half. Laying them on the ground with the round, smooth side up, we skidded the logs out of the woods on top of them. Overcoming friction is the **total objective**. The surface of the freshly peeled spruce in May and July is like using the best grease available. This is a common way to get logs for fishwheels or fish cutting rafts.

When all logging is done by hand, it is very important to have logs pointing in the right direction. They are so heavy to turn or move.

## Methods of Old

To get peeled logs up the bank from a raft, we first winched the smallest of them bottom (butt) side up. Then we placed two of them side by side, and held them together with stakes driven in the ground. We used this as a trough to winch the next two logs up the bank, once again butt first. We

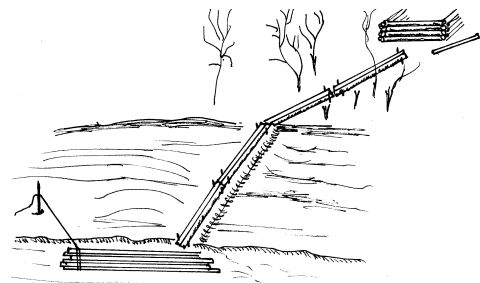

staked them out like the first ones, and continued until there was a trough all the way to the house site. We then winched the logs up the bank on the slippery surface of the peeled logs below. When all the logs were out of the water and in place in the house, we winched the bottom logs up, proceeding all the way to the top. This was another friction reducing technique that kept the logs clean. Dirty logs dull tools quickly.



## Activities

1. Cut a small tree. Have a person push the tree with a pole held ten to twelve feet up the trunk. Does the pole help to push the tree over with enough inertia that it doesn't get hung up?
2. Purchase a couple of plastic wedges. Use them to tip trees that are leaning the wrong way. Make wooden wedges out of dry wood. Compare the results. One person should run the saw and another person drive the wedges.
3. Before falling a tree, stand back and hang an axe head down from your hand at arm's length. It will hang straight down according to gravity. Line the axe handle in your sight against the tree. Can you see any leaning of the tree? Does this help determine how you fall the tree? Some people say this isn't worth doing on flat ground, but helps greatly on a slight hillside. What do you think?
4. Ask local people how they release trees that are hung up.
5. Have a contest. Let several people put a stick in the ground twenty-five feet away from a tree. See who can fall their tree the closest to the stake. Make good use of the trees.
6. Ask local people if they can tell the difference between falling trees in summer and winter. Do they snap more noticeably in the winter?
7. Ask local people what happens if you fall a tree and don't first make a notch in the front of the tree. Do their comments agree with the above text?
8. Try skidding a log on the ground. Put skids underneath as described in the text above. What are the differences?
9. Ask the oldtimers in the village if there are any pictures of the old winches that were used to pull logs up the bank.

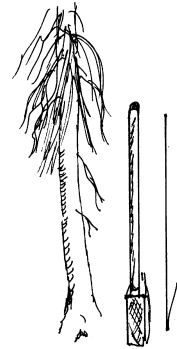

Ask them how they skidded the logs. Did any of them do it in the manner described in the above text?



## STUDENT Response

1. Draw a tree whose center of gravity is leaning to the right.
2. Why would a living tree be more effected by the wind than a dead one?
3. Draw what will happen if there is no notch in the front of the tree.
4. Draw what will happen if the notch on the front of the tree is not V cut, but only as wide as the saw blade.
5. Draw the top view of the stump of a tree that was made to pull to the left.
6. Why is it dangerous to completely cut the hinge when falling a tree?
7. Why is falling trees more dangerous in the winter than in the summer?
8. Why does the logger want the tree to fall fast once it starts to go down?
9. When skidding logs out of the woods, what is the most important thing to avoid? Name one technique for doing this.
10. From the whole lesson, list four things that are dangerous when logging.

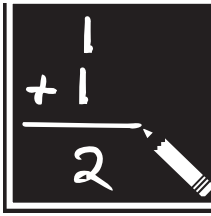

## Math

1. Matt can fall and limb 25 trees a day. He can cut an average of 36' of 6"  $\times$  6" house logs from each tree. His house is going to be 24'  $\times$  32' with 8' high walls (each linear foot of house log = .5 square foot). Approximately how many days must he log in order to get enough logs to make his house out of three-sided logs?
2. Matt is done with his house. He figures that he needs 5 cords of wood to get through the winter. A cord of wood is 4'  $\times$  4'  $\times$  8'. He can cut and split approximately 100 cubic feet of wood a day. How long will it take him to cut and split enough wood for all winter?
3. Harold can fall and raft 100 logs in 7 days. Two men can do the same job in 3 days. He has to take time off his job making \$100 a day to do this. He can pay his nephew \$80 a day to help him. Which is cheaper for Harold: to work alone or hire help?

# Chapter 5

# Guns

Guns have been a part of the lives of Alaskans for many generations. Previous to the development of rifles, shotguns, and handguns, people used bows, snares, harpoons, and traps. The advent of guns changed the lives of Alaskans as new techniques for hunting were developed. Harvesting game became easier than before. Guns were very important trade items in the early days of contact with the Western world. A gun is a very personal item to most people living in remote areas.

A quick look at the guns in a village shows that there are many different makes and models all designed for different applications. Some of the differences are important and some are the result of personal preferences. If we hunt caribou with the same rifle that we hunt ptarmigan, there will be problems. Either the caribou will escape wounded or the ptarmigan will be blown to a pile of feathers, depending on the direction of our error.

## Three Types of Guns

There are basically three types of guns:

**Rifles** usually have a barrel over eighteen inches and have “rifles” (grooves) inside the barrel. They are most often used on animals other than birds. They shoot bullets one at a time for long distances with great accuracy.

**Shotguns** shoot round lead or steel balls of varying sizes. We use shotguns mostly on birds. As birds are often flying fast or sitting low in the water, they are hard to hit with only one bullet. A shotgun throws many smaller lead or steel pellets at the birds, increasing the hunter’s chances of hitting them. While they are quite effective up close, they don’t shoot far at all.

**Handguns** are seldom used for hunting. They don’t have as much power as most rifles and aren’t very accurate for long distances. Handguns are much easier to carry which is why so many Alaskans use them for protection against bears and wolves. They are also used to kill large animals still alive in traps, such as wolves, lynx, and wolverine.

### Standards

A 5, 6, 8a, 16  
B 1, 3  
D 1, 3

### Concepts

Inertia  
Friction  
 $F = MA$   
 $A = R$   
Mass/Density  
Leverage  
Forms of energy

## Bullets

The bullet or cartridge is made of several different parts:

- The bullet
- The primer
- The powder
- The brass (or in the case of a shotgun, plastic) cartridge

## The Bullet

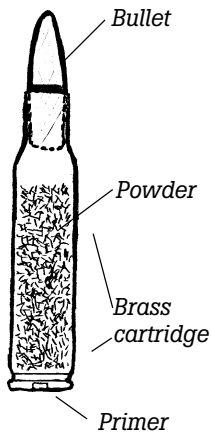

The lead bullets are large and small, hard and soft, naked and jacketed, pointed and blunt. They all have different applications.

### *Size.*

If a bullet is too large it will destroy the meat, like shooting a ptarmigan with a 180 grain .30-06 bullet. If it is too small, it will not do enough damage and will only wound the animal. The diameter of the bullet is referred to as the caliber. A .22 caliber is smaller than .30 caliber which is smaller than .50 caliber.

Bullets are weighed in grains. A .22 is commonly 55 grains. A .30-06 might be 120, 150, 180, or 220 grains. Different shapes make bullets hard to estimate by weight. Accurate measurement is important.

### *Hard and Soft*

If a bullet is too hard, it will penetrate an animal. It will go through it without doing enough damage to stop it. The animal might escape wounded.

If the bullet is too soft, it will spread out (mushroom) on impact, and will not penetrate deep enough to reach vital organs. Again, the result is a wounded animal.

The bullet that is right for the animal will **mushroom** on impact, and still penetrate to do the most damage in the internal organs.

### *Naked and Jacketed*

The rate at which a bullet mushrooms on impact can be controlled by having a copper jacket around the soft lead. A naked lead bullet will splatter too easily if it hits big bones. A completely jacketed bullet will not mushroom at all if it doesn't encounter resistance in the animal. Some people shoot small animals with a large gun, but use jacketed bullets that won't mushroom and damage too much meat.

A .22 caliber bullet is not jacketed, but is covered with a wax to minimize friction as the bullet is driven down the barrel. Without the wax, too much lead would deposit inside the barrel.

### *Pointed and Blunt*

If the bullet is pointed, it will have a minimum of wind resistance, traveling farther and faster, but will be easily deflected. If the bullet is blunt, it will encounter considerable wind resistance, reducing the impact at a distance, but it will go through small obstacles like brush and grass.

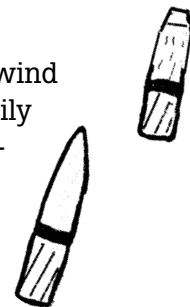

*Mushroomed bullet  
Increases surface  
area and damage.*

## Material

The bullet is almost always made of lead. The high density of lead gives it the most force on impact of any reasonably priced metal. It is also soft enough

to mushroom. Look at lead on the Periodic table. What is its atomic weight?

The jacket around the lead is most often of copper. Copper is harder than lead, holding it together for slower mushrooming. Copper also provides low friction with the barrel of the rifle, a very important consideration if rifles are to last for many years.

Shotgun pellets used for hunting waterfowl are now made of steel. It was determined that waterfowl were eating the lead pellets, poisoning themselves. Steel is less dense than lead, with less ability to bring a bird down. Hunters compensate for this by using one size bigger BB shot.

## The Perfect Bullet

It is easy to see that the choice of bullets depends totally on which animal is being hunted under what conditions. There is no perfect bullet or caliber.

For hunting caribou at a distance, I use a pointed, lighter bullet that is rather soft. For hunting bears in the brush I use a heavy, blunt bullet.

The goal is to effectively and safely harvest animals with no wounded animals escaping. I would rather miss an animal entirely than have it escape wounded.

## Primers



Primers are the small silver colored inserts in the center of the back of the cartridge (except .22s). They are like the caps in a child's toy gun. When they are struck, pressure and friction within cause them to ignite. The primers have little power by themselves. They couldn't drive the bullet out of the barrel. Their job is to ignite the powder which drives the bullet.

Primers can only be used once and must be changed if the cartridge is reloaded. Reloading is inherently dangerous and should only be done under supervision by a trained adult. However, when done sensibly according to the directions, it provides a great savings and sense of satisfaction for the hunter.

## Chain Reaction

How can the little bit of energy we release, as we squeeze the trigger, cause such a noise and drive a bullet with so much force?

Our pressure on the trigger releases the **stored kinetic energy** of the spring behind the firing pin. When this is released, it strikes and releases the **stored chemical energy** of the primer. The ignition of the primer releases the **stored chemical energy** of the powder. This creates high pressure gasses which push the bullet out of the barrel of the rifle. The bullet now has tremendous **kinetic energy**. Our pressure on the trigger releases a chain reaction that loses many forms of stored energy.

A cartridge stores energy until the split second we need it.

## Powder

There are a multitude of powders available. The greatest variables in loading different powders are:

**Quantity.** Obviously, more powder will provide more power or impulse than less powder.

The **surface area** of the powder helps to determine the rate of burn. The same amount of fine powder will burn faster than a like amount of coarse powder.

**Rates.** Different powders burn at different rates. This is most important. If the powder burns too slowly, the bullet will be out of the barrel before the powder is completely consumed. Energy is wasted. If the powder burns too fast, the powder will be burned before the bullet leaves the barrel.

### *Rifle and Handgun Powder*

Rifle powder will not burn fast enough in a handgun. Handgun powder burns far too fast to be loaded in a rifle cartridge in the same quantity.

### *Safety*

Old time Alaskans used to reload their own cartridges, but the lack of proper measuring devices caused many accidents that led people to prefer store-bought ammunition. Proper storage of powder also presented problems.

### *Clean burning*

It is important that powder burns clean. A dirty barrel might explode when bullets force their way down a clogged barrel. Many chemical reactions will create the force necessary to drive a bullet down the barrel, however, modern powders burn quite cleanly.

### *Oxygen or What?*

For years I wondered where the oxygen came from to burn the powder. Later it dawned on me that there is no oxygen. A quick look at the Periodic table of elements shows that sulfur is in the same group as oxygen. In old-time black powder, sulfur, a solid, takes the place of the large amounts of oxygen that would be required to efficiently oxidize (burn) the other elements in the powder.<sup>1</sup> In more modern powders, nitrates take the place of oxygen and sulfur in oxidizing the powder.

## Cartridge

### *Rifle and Handgun*

Most cartridges are made of brass. Brass is soft enough to slip in and out of the rifle's chamber without causing a lot of wear by friction. When fired, the soft brass cartridge expands against the strong heavy steel of the firing chamber which holds it in shape.

1. Sulfur has two free valence electrons like oxygen.



The cartridges of different calibers are unique. They have long and short necks, and bodies which are straight or tapered.

### Shotgun

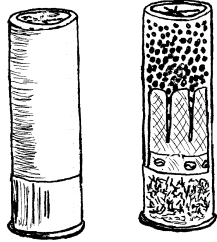

Shotgun shells

Shotgun cartridges have a bit of brass on the back end, but they are made mostly of plastic. The plastic protects and seals, keeping the cartridge dry.

Within the plastic shotgun shell is a plastic cup called “wadding” that holds the pellets. When the primer ignites the powder, the cup and pellets are driven out of the barrel. When it hits the open air, the light plastic wadding slows down and the pellets are carried along their course by inertia. The cup provides very low friction for the pellets to get out of the barrel. Without it, the pellets would jam tightly in the barrel, greatly reducing velocity.

Before plastic, a cotton wad separated the pellets and expanding powder.

### Rifling

A look down the barrel of most shotguns shows that the barrel is perfectly smooth. A shotgun’s pellets are thrown straight out of the barrel.

A rifle is different. The word “rifle” actually means a groove. A look down the barrel of any rifle shows grooves that spiral the full length of the barrel.

Early gunsmiths understood science very well. A round bullet shot out of a barrel with no spinning motion will wander terribly, making accuracy impossible. If a long slim bullet didn’t spin, it would tumble wildly in the air for a short distance.

When a bullet is driven down a spirally grooved barrel, the spinning motion keeps the bullet from wandering. Once the bullet has rotational inertia, it resists changing it’s direction, just like a spinning top or football quarterback’s pass.

Without the grooves (rifles), modern hunting wouldn’t be the same. Long distance shooting would be a matter of chance, rather than skill.

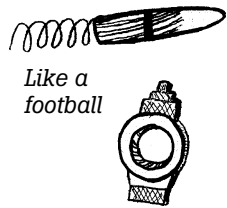

Like a football

### Types of Actions

A rifle or shotgun can have five different types of actions, or ways, of getting the cartridge into the firing chamber.

**Single shot.** This is the simplest action. The gun is opened, and the cartridge is inserted by hand. It is removed by hand after it is fired. Most young people are given a single shot .22 for their first gun as they are safe and simple.

**Bolt-action** rifles are the safest, most reliable, and tend to be the most accurate. They aren’t the fastest to operate, as they require the hunter to take his/her eye off the target to reload. It is very easy to bore sight a bolt action rifle. This will be explained later. Bolt actions don’t seem to work as well for shotguns.

**Pump** actions allow the hunter to continue to eject spent cartridges and insert new ones while his/her eye remains on the target. However, they aren’t

as strong as a bolt and the sliding parts tend to slow down with friction if the gun is at all dirty. They also freeze easily in the winter. Pump-action shotguns have long been favorites for their speed over bolt action, and for reliability and safety over semiautomatics.

**Lever** action is a reliable rifle action, but there are many moving parts and the cartridge isn't locked in as safely as a bolt action. It is very difficult to bore sight a lever action. They have made their way into all of our hearts through Western movies. They are fast. The hunter can lever a cartridge into the chamber without dropping the rifle and taking his eye off the target.

**Semiautomatic.** When they are working, semiautomatic weapons are amazingly fast. However, they are very sensitive to dirt and weather, and tend to malfunction much more than bolt, pump, or lever actions. They are also terribly dangerous. As soon as a bullet is fired, another is there in its place. The hunter must be very careful.

## Handgun Safety

Heavy objects have greater inertia, or resistance to motion than light ones. Handguns, because they are lighter, can be pointed in different directions easily. They are far more dangerous than rifles for this reason.

## Handgun Actions

Handguns have two common actions.

**Revolvers** usually hold six cartridges. They are slower than automatics but are totally reliable. Most wise hunters leave one cartridge out, keeping the hammer on the empty chamber so the handgun cannot be accidentally fired. This leaves five safe shots.

**Semiautomatic** weapons can shoot faster than revolvers with greater ease of holding on the target. Their lack of reliability in Alaska's harsh weather make them more dangerous than rifles.

It would be interesting to discover whether there have been more hunters or bears shot with handguns. In the hands of a mature experienced person, they are useful, but the handgun hazard is often greater than the bear threat.

## Recoil

Our first question about a gun is often, "How hard does it kick?" Obviously, a gun with more powder and a bigger bullet will have more recoil. Action equals reaction. When the bullet is forced out the barrel, the gun is forced backward.

There are other factors that influence recoil. The mass of the gun makes a big difference. A light<sup>1</sup> gun will "kick" considerably more than a heavier gun. For example, if you step out of a small boat onto a dock, the boat will be pushed away and you might fall in the water. If you step out of an oceanliner

1. In this case "light" and "heavy" are in reference to mass, not weight.

onto the dock, the force of your step is the same, but the mass of the oceanliner keeps it from moving away from the dock. In the same way, the lighter gun will move more in response to the bullet leaving the barrel than will a heavy one.

A small person might try a light single shot 12 or 20 gauge shotgun, and be hurt. The same person might be able to shoot a heavier shotgun with less discomfort.

Many guns have a soft rubber recoil pad. This absorbs much of the shock from the gun.

Handguns kick rather hard because they are light and must force the bullet out of the barrel in a very short period of time. While a rifle isn't gentle, it pushes the bullet more gradually and therefore kicks less sharply than a handgun.

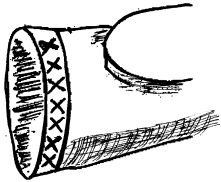

## Bore Sighting

Hunting seasons are getting shorter and shorter. There is little opportunity to make mistakes and still come home with meat. The hunter must be sure his rifle is sighted in properly.

Automatics, pumps, and lever actions are difficult or impossible to bore sight. A bolt action has three distinct advantages here:

1. Remove the bolt.
2. Set the gun down on a rest where the barrel is pointed at an object 100 to 200 yards away.
3. Look down the barrel and sight down the sights. Are they both pointed at the same thing? If they are, the gun is sighted in. If not, move the sights. The bullet will fall a few inches by the time it goes 200 yards. Adjust the sight so it is pointing a few inches above the target at 200 yards and it will fall right into the target.

When bore-sighting, I usually look down the bottom of the barrel, although sighting down the middle of the barrel is almost as good. You are making sure that the line-of-sight of the barrel and line-of-sight of the sights are nearly parallel.

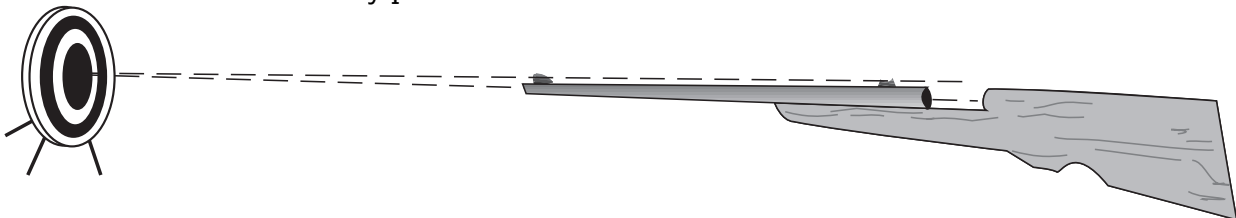

## Sights vs. Scopes

Before scopes were available, open sights were the only choice. Open sights are good because:

- They are reliable.
- They are inexpensive.
- They are easy to fix.



- They aren't easily bumped out of adjustment.

### *Disadvantages*

With open sights, the hunter's eye is trying to focus in three places.

- **Very close.** The rear sight.
- **Near.** The front sight.
- **Far.** The target.

This is difficult enough for people who have good eyes and far more difficult for those who don't.

Scopes have become popular for several reasons:

- They allow the hunter to see the target much more clearly, magnified two to seven times by the lenses.
- A scope allows the hunter to focus on one place . . . the lens close to his eye.
- They seem to "gather light" in the twilight, and allow the hunter to shoot in conditions too dark for open sights.

Scopes have some distinct disadvantages:

- They easily fog and condense. Often hunting is done in bad weather and the scope, in the moment of greatest need, is blurred with moisture even if there has been protection over the lenses.
- They are more easily bumped out of adjustment.
- If they are too high a power, in the brush the hunter cannot see anything but giant leaves and twigs that appear to be tree trunks. A high power scope is dangerous in the brush. It is hard to find the animal as the field of view is so narrow. I once went after a wounded bear in the brush with a high powered scope. Never again.
- They make the gun heavier to carry long distances.
- They are rather expensive.

Whatever a hunter chooses will be determined by his needs and applications.

Shotguns don't have scopes for hunting birds, nor do they have open sights. The shotgun needs to be an extension of the hunter's body. It isn't sighted. It is pointed. If the stock of the shotgun doesn't fit the face and body of the hunter well, he will continually miss. The stock needs to be shaped until the place where the hunter is pointing the gun is the same place he is looking with his eye when he puts the gun to his shoulder. The importance of this cannot be overstated.

In the Lower 48, deer and elk hunters put scopes on shotguns using one-ounce slugs. Slugs don't travel as far as rifle bullets, which is important in highly populated areas.

## **Trajectory**

The trajectory of a bullet is the path that it takes between the gun and the target.

One bullet is dropped from a place 3' from the ground. Another bullet is

shot at the same time from a rifle barrel that is 3' from the ground. The rifle barrel is perfectly parallel to the earth's surface. Which bullet will hit the ground first?

Most people say that the one that is dropped straight down will hit the ground first, but in theory, they both will hit the ground at the same time.<sup>1</sup> The bullet that is shot will travel farther and faster, even though gravity works on both of them identically.

Once a bullet leaves the barrel, it starts to drop. If we want to shoot a long way, we must aim above the target so the bullet will fall down into the target.

Surprisingly, heavy bullets and light bullets fall at the same speed. A light bullet might travel faster, and get to the target sooner, therefore falling less, but a heavy bullet doesn't fall any faster than a light one.

If we are shooting a short distance, we probably won't have to raise the gun much at all. However, after 200 yards, the drop can be considerable. The hunter needs to know his rifle and the facts surrounding the trajectory of the different bullets he shoots from it. He may need to aim six to ten inches above the target to hit it at a great distance.

Some people have made a great study and hobby of guns. The rest of us use them to get meat from the woods to the table. Most important are hunter safety and not losing a wounded animal.

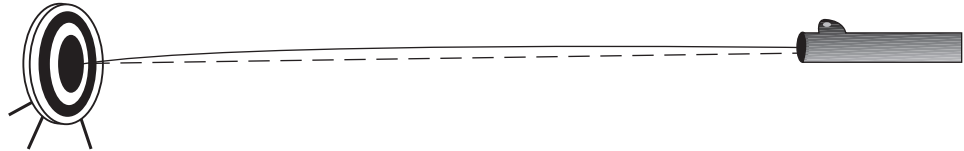

## Activities

1. Ask the people in your village what kinds of guns they have. Is there a favorite manufacturer? Favorite caliber? Favorite action (bolt, lever, semi-auto)? If people don't want to answer, be sensitive. Some people in the bush feel that the government is threatening their rights to have guns and they are reluctant to let people know what they have.
2. Does anyone in your village reload? Ask them about the best bullets and calibers for hunting in your area. Ask them to demonstrate reloading a few cartridges.
3. Start a collection of different cartridges. Do not take them from live ammunition! This is very dangerous. Get them from reloaders in your village, hunters, or from gunshops when you go to town. Research the history of each cartridge. They all have a story.
4. Usually someone has saved a bullet that has been cut out of a moose or

<sup>1</sup> This is in theory. The curvature of the earth would cause the bullet that is shot to fall a greater distance.

- caribou. Ask around the village for one. Can you see the grooves imprinted in the bullet from the rifling in the barrel? Draw the mushroomed bullet. Do you think it hit a bone?
5. Try filing the different parts of the bullet. Is it hard or soft?
  6. Ask your local reloading expert to put a primer in a cartridge and omit the bullet and powder. Let him shoot the primer outside. Do you now have a sense of how little power is in the primer?
  7. Ask your reloading expert to put a little powder on a flat surface and light it with a match. Does it explode or burn quickly? Smell the burned powder.
  8. Scrape the lead on a .22 cartridge with your fingernail. Can you detect the wax to lubricate the bullet?
  9. Handle lead and steel shot from a shotgun. Can you feel the difference in weight?
  10. If a bullet came out of a rifle without spin it would wander. The best way to observe this is to hit a volleyball underhanded in the gym. If you hit it with no spin, people on the receiving end will see it wander, and will have a hard time hitting it. Research what a "knuckle ball" is in baseball and how it is thrown. What is the relationship of this phenomenon to shotgun pellets?
  11. With the bolt removed from a bolt action rifle (to remove all danger) look down the barrel. Can you see the rifling? How do you think police verify that a certain bullet was shot from a certain gun?
  12. Feel the recoil pad on some of the rifles and shotguns in the village. Do you think they would help reduce the kick of the gun? Do you find recoil pads on .22s? Why?
  13. Bore sight a bolt-action rifle according to the directions given in the text. Are the sights or scope on target?
  14. Ask people in your village which they prefer: open sights or a scope. What are their reasons for their preference? Does it vary with the animal hunted?
  15. From a ballistics chart, compare the three top favorite rifles in your village for velocity of bullet, drop of bullet, and foot pounds of energy at 100, 200, and 300 yards. Note the differences for different weight bullets. What are the favorites in your village?
  16. Draw the trajectory of those three favorite rifles and three favorite bullet weights.
  17. Ask the oldtimers what the favorite rifles were long ago and why.
  18. Drop two balls of the same size but different weights at the same time from a given height. Does the heavier one fall faster? Why or why not?
  19. Ask the good hunters in your village whether they shoot with one or both eyes open.

20. Test the students in your class. Which eye is dominant? Do they shoot right handed or left handed? Does anyone shoot right handed with a left eye dominant or vice versa?



## STUDENT Response

1. What are the three types of guns?
2. Draw a loaded cartridge and label the parts: cartridge, powder, primer, and bullet.
3. What are the four differences that must be considered when choosing a bullet?
4. What is the material most often used in making bullets? What is the jacket material?
5. What are primers and what do they do?
6. What energy conversions take place as we squeeze the trigger? What kind of energy is stored in a cartridge?
7. What is the difference between handgun and rifle powder?
8. What element is used in the chemical reaction in a cartridge that replaces oxygen in the burning process?
9. Draw the rifling in the barrel of a rifle.
10. What are four kinds of actions of rifles? Name one advantage of each.
11. What are the two kinds of actions of handguns? Name one advantage of each.
12. In your own words, what is recoil?
13. Draw the side view of the process of bore sighting a rifle.
14. List three advantages of open sights.
15. List three advantages of scopes.
16. Draw the trajectory of a fast bullet.
17. Draw the trajectory of a slow bullet.

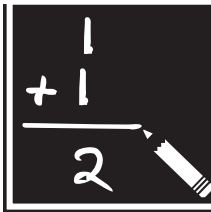

## Math

1. Phil reloads his own shells for \$.30 each. A box of 20 shells costs \$19.95 in the store. His reloading equipment cost \$65. How many years does he have to reload (if he uses an average of 3 boxes a year) in order to pay for his reloading equipment?





## Chapter 6

# Chainsaw Clutch & Chain

Chainsaws have been an important part of the life of Alaskans for the last generation. Prior to that, heavy motor-driven saws were scarcely faster than hand saws. Previous to that, we used Swede saws and two-man saws. For the amount of gas burned, a modern chainsaw can do more work than any other engine. Most houses can be heated on five gallons of gasoline a winter for chainsaw operation. That represents numerous hours with a Swede or two-man saw.

### The Clutch

If the chain on a chainsaw was directly connected to the engine, it would be very dangerous. The chain would turn as soon as the engine started. It would also be hard to start because the starter rope would have to turn the chain and the sprocket as well as the engine.

The clutch allows the engine to turn freely at low rpm<sup>1</sup> without moving the chain. It automatically engages at high rpm. Unlike a four wheeler or truck, the chainsaw operator doesn't have to engage the clutch or put the chainsaw in gear. It happens automatically when the engine gets to a certain speed.

How does the chainsaw clutch work? It uses two physical principles: circular motion (inertia) and friction.

The chainsaw clutch is made of two main parts that are separate when the engine idles slowly:

- The drive shaft, shoes, and spring
- The drum, sprocket, and chain

The drive shaft is connected to the shoes.

The drum and sprocket drive the chain.

At zero or low rpm, the engine shaft, shoes, and

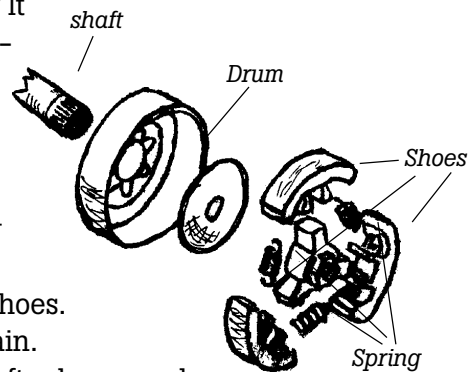

#### Standards

A 6, 8c, 15  
B 1, 3  
D 1, 3

#### Concepts

Inertia  
Friction

1. rpm = revolutions (turns) per minute

*Low speed.  
Shoes are in*



*Outside drum  
does not turn*



*High speed...  
shoes have  
expanded out,  
turning the  
drum*

spring turn together. The drum, sprocket and chain do not.

At high rpm, the engine shaft is connected to the drum and chain. They turn together. The chain cuts because it is now connected to the engine.

How does this work so simply? Science.

When the engine spins slowly, the shoes are held tightly against the engine shaft, and away from the drum by the spring wrapped around them.

When the engine is turning fast, the inertia of the shoes overcomes the force of the spring. The shoes move outward, pressing hard against the drum. Now the engine and chain are firmly connected.

When the shoes are out against the drum and the chain is turning, there must be enough friction between the drum and shoes to allow little or no slipping.

As soon as the engine speed drops, the spring overcomes the inertia of the shoes, pulling them away from the drum. The engine is separate from the chain again.

If the chain is stuck in a tree, and the operator tries to power it out with the engine, heat from friction turns the clutch drum blue and warps it out of shape.

## Chain

The chain has tremendous potential for friction and power loss as it travels around the bar. Energy used overcoming friction is energy that isn't available to remove wood fibers from the log.

There are deep grooves in the bar to keep the chain from flying off the bar, and to keep the chain cutting straight. There is plenty of metal-to-metal contact.

For this reason, there is a constant stream of oil pumped through a hole in the bar to the chain.

If the oil is too thin, it flies off the end of the bar by inertia. This leaves the underside of the bar and chain dry of oil. There will always be a little oil coming off the nose of the bar. However, if the oil is too thin, large amounts will splatter from the nose of the bar. To determine this, the operator revs the engine with the bar pointed at a clean surface (like snow), looking for the oil splatter.

If the oil is too thick, as it might be in the cold of winter, the bar and chain don't get enough oil. There is great wear and power loss due to friction. In subzero temperatures we often thin bar oil with gasoline or kerosene. The operator should listen if the bar sounds dry. If the oil level hasn't gone down considerably when the gas tank is empty, thin the

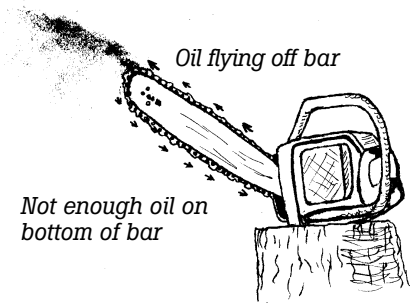
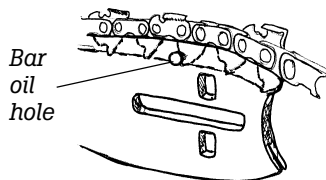
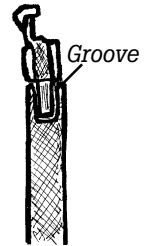

oil until it flows freely at that temperature.

If the oil is the proper consistency, it will pump freely, and will stay with the chain all the way around the bar.

Many saws have an adjustment for the oil flow. Longer bars require more oil than shorter ones. The location of the adjustment isn't always obvious, so refer to the owner's manual.

While many people use 30w motor oil, professional chainsaw bar oil is more effective because it is sticky.

All chainsaw manufacturers discourage the use of old crankcase oil from generators or cars for bar oil. I used to think they just wanted to make money when I bought their expensive bar oil, so I used crankcase oil. What I didn't realize is that there are many iron filings in crankcase oil that cause excessive wear on the bar and chain. Filings can also plug up the oil filter. Once I understood this, I immediately started using bar oil or 30w oil from large containers. Bars and chains last longer with commercial bar oil.

## Tension

Many chainsaw bars have a roller on the nose. This is to reduce power loss to friction. The greatest tension on the chain is between the wood and the sprocket. Most of the time, cutting is done on the bottom of the bar.

When cutting is done on the top of the bar, there is tension along the full length of the bar and chain. Friction on the nose is tremendous. Without a roller nose there would be great power loss. Avoid cutting on top of the bar when possible.

Most professionals turn their bars over daily so the bar will wear evenly on both sides.

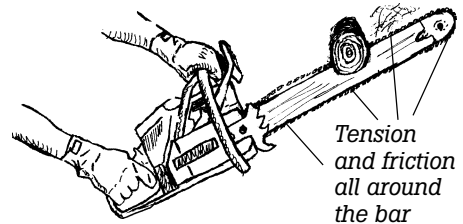
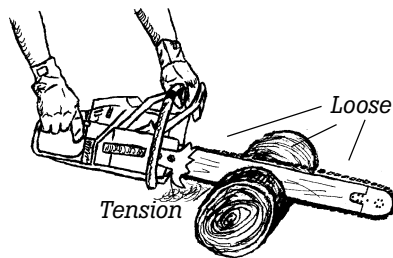

## Chainsaws and Fishtraps

Sometimes we use chainsaws to cut river ice when setting fishtraps through the ice. It doesn't hurt a cold saw to be splashed with cold river water. However, icy water can crack a hot cylinder.

There are often rocks in the ice that will ruin the chain. This is particularly true if the river has frozen, then thawed again. During the warm spell, the ice that was frozen on the gravel bars breaks free, carrying rocks from the bar. It drifts down the river to freeze in a different place.



## Activities

1. Put a weight on a string. Attach a strong rubber band or soft Bungee cord to the string. Hold the loose end of the rubber band and spin the weight around the head. (The dangers of this should be fairly obvious.) Try this with different weights and different strengths of rubber bands. Can the students feel the difference?
2. If students haven't tried the old water-bucket-around-the-head activity, let them try it. This illustrates inertia quite well.
3. There are two types of chainsaw clutches: those with the sprocket on the outside of the clutch and those with the sprocket on the inside. Find one of each kind in the village and draw a top view of each.
4. Do this outside. Get an experienced person to run a saw that has the sprocket on the inside and clutch on the outside. Take the cover off and observe the operation of the clutch. Increase and decrease rpm. Can you see the shoes go in and out? Describe what you see to someone who didn't see the demonstration.
5. Look on the chainsaw in the above activity for the oil flow adjustment. Observe the oil coming out of the saw to supply the bar. Adjust the oil flow. Is the difference obvious? Find the hole in the bar that allows the oil to flow to the chain. Is there a similar hole if the bar is turned over?
6. Get a chainsaw clutch from an old chainsaw. Look at the drum. Does it look blue from being overheated? Look at the shoes. Test them for friction with other materials. Do they look like they are made of high friction material? What do you think that material is? To get the clutch off you will probably have to follow these directions:
  - Remove the sparkplug.
  - Put a screwdriver in the sparkplug hole and turn the engine until you feel the piston is at the bottom of the cylinder. Remove the screwdriver.
  - Cram the cylinder full of nylon or other plastic rope.
 Now you can put a wrench on the nut holding the clutch and the rope will hold the crankshaft from turning.
7. Test the clutch spring for tension. Is it a strong spring? Does it also look blue from overheating? Does it stretch evenly or is it dysfunctional?
8. Imagine what would happen if oil got into the clutch. What problems do you think would occur if this happened when the saw was operating?
9. Get some 30w oil. Heat it by putting the plastic container in very hot water. How thin does it get? Do you think it would stay on the bar well when it is that thin? Cool it in a freezer. Feel it. Do you think it would pump well at this temperature?
10. Get some commercial bar oil. Put a little on your fingers. How is it different from regular 30w oil? Why do you think this is so?

11. Get some crankcase oil. Wrap a magnet in thin plastic wrap. Immerse the tip of the magnet in the old oil and see if you can pick up the iron filings that are supposedly in the crankcase oil.
12. Get a chainsaw bar with a roller nose. Does it have a hole to grease, or is it permanently lubricated?
13. Get several bars and chains, new and old. Test them for side motion and wear. How sloppy is the chain in the bar? Does it tend more toward one side than another? Which part of the bar is worn the most? Does it look like the owners turned the bar over often, or is one side worn more than the other?
14. Draw or trace a side view of a chainsaw chain.
15. Ask people in your village what is the best saw they ever owned and why. What is the favorite bar length?
16. Ask people in the village how they cut wood before chainsaws. If you can, fall and buck a tree using that method.
17. Ask people in the village the names of the chainsaws they know or remember. Make a class list. Find on the map the locations where they were manufactured. (You will need a world map.)
18. Ask in the village if someone can demonstrate how to splice a broken chainsaw chain.
19. Gently file the materials of the bar, clutch drum, clutch shoes, sprocket, chain dogs, and teeth. Which are hard and which are softer than a file?
20. Have a contest to see who can untangle a chainsaw chain the fastest. (This is often a challenge!) Let students tangle a chain, and pass it to the next person to untangle.
21. Get an owner's manual. Draw a picture of two dangerous activities that should be avoided.



## STUDENT Response

1. What might happen if the chain and engine of a chainsaw were always connected?
2. What are the two main parts of the clutch?
3. How does inertia work in a chainsaw clutch?
4. What is around the shoes that keeps them from flying outward at low rpm? What would result if it were too loose? Too tight?
5. Draw a chainsaw clutch where the engine is turning at low rpm and the chain isn't turning.

6. Draw a chainsaw clutch where the engine is turning at high rpm and the chain is turning.
7. If there were low friction between the shoes and drum, what would happen when there was a load on the chain?
8. What happens to the shoes when the engine is slowed down after running at high speed?
9. What is happening when the chain is stuck in the tree and the saw is being run at high rpm?
10. What happens when chain oil is too thin? Explain or draw it.
11. What happens if the chain oil is too thick?
12. How is professional bar oil different from 30w oil?
13. Why is the use of old crankcase oil discouraged?
14. What is a roller nose on a chainsaw bar? What is the purpose?
15. Draw a chainsaw bar and chain as they are cutting a block. Identify the place on the bar where the chain is loose. Identify where it is tight.

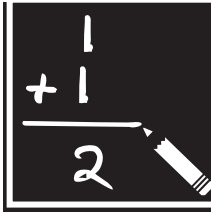

## Math

1. Commercial bar oil is \$3 per quart. Henry bought eight quarts and figured that his bar lasted two times longer than if he used free crankcase oil. A new bar is \$30. Did he save money?
2. Would it be cheaper if he ordered an extra bar from a discount place for \$22 or commercial chain oil for \$2.25?
3. Henry can get bar oil for \$3 a quart, or order in bulk, 5 gallons for \$32, plus \$13 shipping. Is he saving money, and if so, how much? The answer can refer to quarts or 5-gallon buckets.
4. Jesse wants to sell cordwood. He figures that each cord for his chainsaw takes 1 quart of bar oil at \$2.75,  $\frac{3}{4}$  gallon of gas at \$3.50 per gallon including two-cycle oil. Snowmachine costs are about \$21 per cord, including wear and tear. It takes 5 hours to cut and haul a cord. How much should he charge to make the equivalent of \$10 per hour? \$12 per hour?

## Chapter 7

# Ice Picks

Anyone who has tried to make a hole in the ice with an axe knows the importance of an ice pick. People have always needed water from creeks, rivers, and lakes. They have always needed to set fishtraps, nets, and snares under the ice. They have chopped sled trails across ocean ice packs. Oldtimers used an icepick to cross thin ice, picking and listening to the sound of the ice

Years ago, the Department of Fish and Game insisted that beavers be trapped and snared in the winter rather than shooting them in the spring as they always had been. This forced people to pick through many feet of ice in order to set the beaver snares. This was not a traditional method of trapping. Ice pick design became an art of greater importance.

### Weight

The weight and shape of the ice pick make a tremendous difference in the operation.

If an ice pick is too heavy, it will quickly tire the individual lifting and driving the pick into the ice. If the ice pick is too light it will not have enough force to shatter the ice. Force = mass  $\times$  acceleration. The greater the mass, the greater the force. If the pick is too light, the person will have to use the strength of his arms instead of the force of the heavier pick.

A larger and stronger person will prefer a heavier ice pick.

### Shape

The shape of the tip is most important. If the edge is too thick, it will not penetrate the ice.

If the edge is too thin, the pick will penetrate the ice well, shattering the ice around it. However, it will dull quite easily if it hits rocks in the ice or the creek bottom. Every beaver trapper has picked through several feet of ice and hit gravel rather than water!

If the icepick were sharpened on both sides, it would be impossible to widen the sides of the hole. The ice pick would glance off the side. The shape of the tip is critical.

*Too thick*

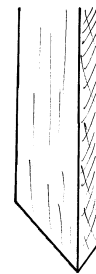

*Too thin*

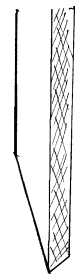

*Sharpened both sides—difficult to widen the hole.*

#### Standards

A 6, 15  
B 1, 3  
C 3  
D 1, 3

#### Concepts

$F = MA$   
Inertia  
Friction  
Surface area

## A Secret

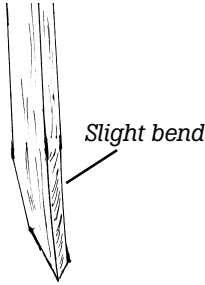

One secret that really sets an exceptional ice pick apart from others is almost unnoticeable. The tip has a slight bend toward the flat side.

If the ice pick is straight, it will penetrate the ice, chopping well. But if there is a slight bend, the tip quivers when it penetrates, shattering much more ice than a straight one could. Ice picks with different designs sound different when they pick the ice.

## Width

The width of the tip is also important. If it is too wide, it will have too much surface area to penetrate the ice. If it is too narrow, it will not effectively cut sticks that are embedded in the ice. This is particularly important around a beaver feed pile.

## Handle

If the handle is too smooth, it will slip out of the person's hands, lost down the hole. If it is too rough, there will be adequate friction to grip, but it will make the person's hands sore. Many people put a knob on the top to keep it from slipping through icy gloves. Others tie the pick to their arm. Many trapping opportunities have come to a quick end when the icy handle slipped through icy gloves and plunged into the dark water.

If the handle is made of steel or aluminum, it will be too cold to grip and will collect so much ice it will be far too heavy. Wooden handles are best. Spruce is the choice material for the handle. It is strong and resists rotting. Although birch is strong, it easily deteriorates.

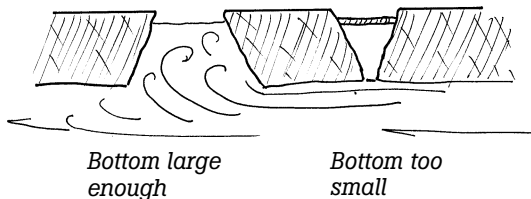
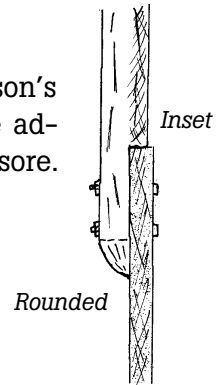

The steel bar is often inset and bolted to the wooden handle. The nose of the wood is rounded to reduce splashing. Getting the hole down to water isn't hard. Once the hole fills with water, it is hard to make it wide at the bottom. If the bottom of the hole is too small, the hole will freeze over quickly for lack of current.

## Quality Steel

The steel of a nail bar is of high quality. Some people use spring steel from a snowmachine. Others use the drive shaft from a snowmachine, or car axle. Others use a wrecking bar. Hit the steel with another piece of metal. If it has a clear ring, it probably is good steel. If it sounds dead, it is probably not good steel.



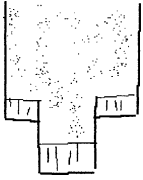

## Commercial Ice Picks

There is a commercial ice pick available that looks like this. I haven't tried one, so am not qualified to comment, although I have heard good stories about them.

## Insights

No one wants to pick more ice than is necessary. Some people return to their beaver set once the hole is skimmed over with ice, and cover it with snow to insulate it from freezing further. In severely cold weather, one fellow allowed the hole to freeze over, then poked a little hole with his knife. He blew into the little hole, leaving an insulating bubble of air between the water and ice, sealed the hole with his tongue, and covered the skim of ice with snow. The next day he had very little ice picking to do, while other trappers spent hours opening the holes again.

These are cold weather techniques.

The art of making an ice pick is almost lost. City water, new technology and low prices for beaver pelts have nearly made ice picking a thing of the past. Many people now use ice augers, both manual and motor driven. Ice augers work well to make holes for fishing but, for many applications, the holes are too small.



## Activities

1. Make an ice pick out of a wrecking bar or other good steel. Before putting a slight bend in the tip, make a few holes in the ice. Then put the slight bend. Observe the difference. Does it widen the hole better with the bend? Can you hear the difference between the two picks?
2. Before rounding the nose of the wood on the handle, leave the wood square. Does it splash once there is water in the hole? Round the nose of the wood and try it again. Does it splash as much?
3. Strap a five to six pound weight to the ice pick you have made. Pick a hole. What differences do you observe? (Ankle or wrist weights might work well.)
4. Try to make a hole in the ice with an axe. What is your experience once the hole fills with water? Can you widen the bottom of the hole?
5. If there is an ice auger in the village, compare the time and effort required to make a hole with the auger to the time it takes to make a similar hole with an ice pick. Which is faster and easier for you? What are the advantages of each?
6. Observe how icy your gloves get when using the ice pick. What will you do to increase friction so you don't lose the ice pick down the hole?

7. Listen closely. Can you hear the difference in the sound of the ice just before you punch through and water comes into the hole?
8. Make an ice pick out of a snowmachine spring over 2" wide. What differences do you see between this ice pick and the first one.
9. Compare the ice pick you have made with a commercially designed ice pick if there is one available. If they are both sharp, which one works better for you?
10. Are there any homemade ice picks in the village? Look at them. What do the tips look like? How wide are they? How heavy are they? What is the average weight? What kind of steel are they made of? Do they ring when struck with another piece of steel? (The wooden handle will deaden the sound to some degree.)
11. What kind of wood is used for the homemade ice pick handles?
12. Talk with the local beaver trappers and, if possible, go out trapping with them. When you get back, describe to someone else what you learned.
13. By inquiry in the village, discover the difference between an ice pick used for walking after freeze-up and one used for beaver trapping.



## STUDENT Response

1. Why is it important to have an ice pick that has enough mass?
2. Draw an edge that is too thick. Draw one that is too thin.
3. Why is a slight bend put in the tip of some ice picks?
4. Why is friction important on the handle?
5. What is the most common material for an ice pick handle and why?
6. What happens if the bottom of a water hole isn't widened?
7. Draw a good ice pick, including handle. Identify the parts.

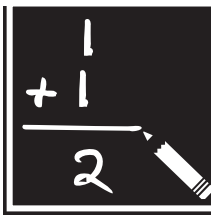

## Math

1. Mike has a chance to go beaver trapping with his uncle. A gasoline-driven ice auger costs \$209. He can make his own ice pick for \$12. If the average price of a beaver pelt is \$25, how many beaver does he have to catch to break even with the cost of the gasoline driven auger?
2. Mike can pick 14 holes a day when the ice is 3' thick. The next year he traps, he finds that the ice is 4' thick. Approximately how many holes will he make if he picks at the same rate?

# Shelters

Chapter 8: Wood Stoves  
57

Chapter 9: Wall Tents  
67

Chapter 10: Steambaths  
71

Chapter 11: Insulation and Vapor Barriers  
75

Chapter 12: Gas lamps & Stoves  
83

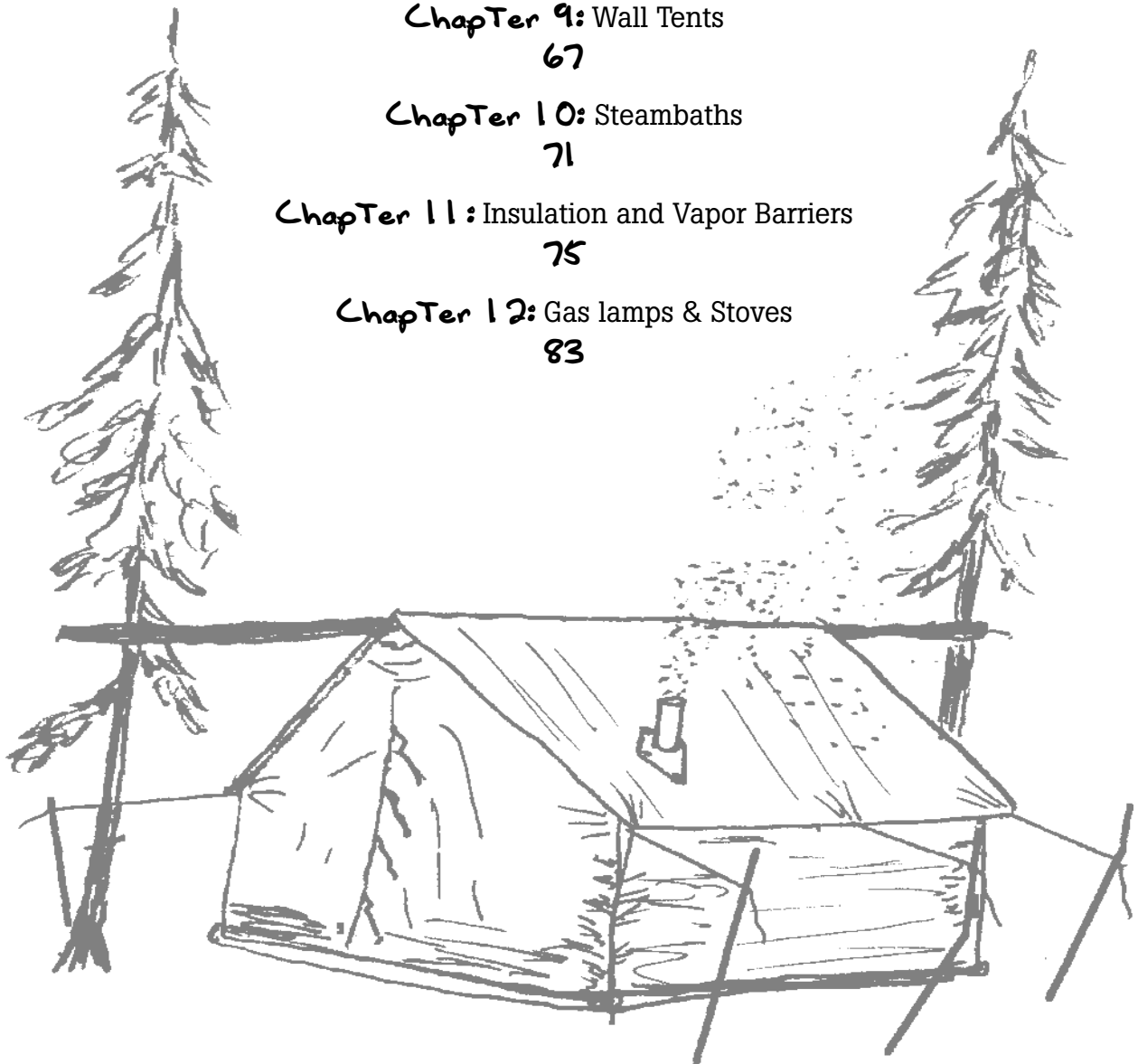



## Chapter 8

# Wood Stoves

Among oldtimers, stove building was an art form . There were different kinds of stoves for different applications: tent stoves, steambath stoves, and stoves for larger and smaller cabins . People developed precise skills in cutting and shaping iron . Many experiments took place and stove construction was a common topic of conversation .

I have spent a lot of time thinking about ways to make a better stove. I have made many different stoves . The ultimate stove always seems to be “the next one I build .”

One time a young girl came into our cabin . I had a stovepipe standing on the floor . She circled it carefully, studying it . She had seen me experiment with so many crazy things she couldn't believe that it was just an ordinary stovepipe standing on the floor . She thought it was another of my wild ideas . I have filled houses with smoke, but have never burned one down .

My study of stoves has given me insight into the ways other things work as well.

## Understanding

There is a process of nature by which wood is developed .

Tree Growth (photosynthesis)

water + carbon dioxide + sun's **energy** (light)  
+ minerals = woodfiber + oxygen

This process takes many years . When we bring a tree home, we are bringing energy stored in the wood from years of the sun's radiant energy. The light energy of the sun is converted to chemical energy in the wood by photosynthesis.

### Releasing the Energy

When we apply heat to the wood in the form of a match and a little burning paper, we start the process by which the chemicals in the wood release their energy. This process is the **opposite** of the process by which the tree grows.

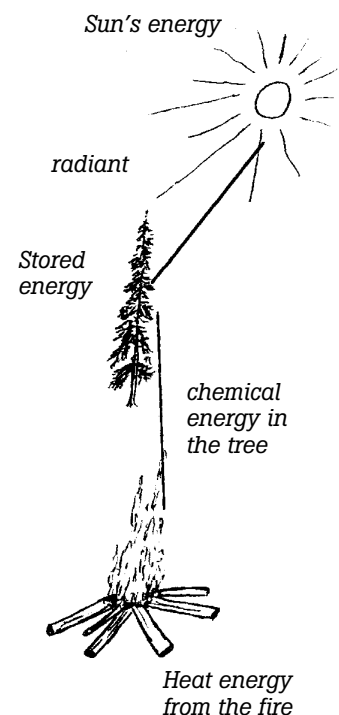

### Standards

### Concepts

*Stored chemical energy*

The stored chemical energy of the wood is changed to heat energy. We use that energy to heat our homes.

### Wood Burning

Wood + Oxygen = Water + Carbon Dioxide + energy (heat) + minerals

When we heat our homes with wood, we are releasing the stored energy of the sun from years past. We receive energy from a time before many of us were born. That is amazing. Energy stored for twenty, thirty, sixty, or eighty years is released in four to five hours.

### Smoke

The smoke from a wood fire contains water, carbon dioxide, carbon monoxide, minerals, and some heat energy. The ashes left in the stove represent the minerals left behind.

## Starting a Fire

*shavings*

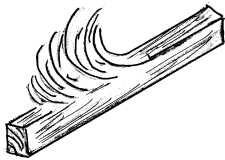

*kindling*

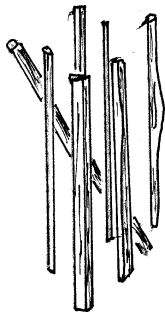

Three things are necessary to have fire:

- Fuel
- Heat
- Oxygen

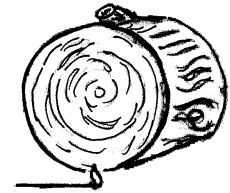

If we try to start a fire by applying a match to a log, it won't burn. The match can't provide enough heat to get the log burning. We have enough fuel and enough oxygen, but not enough heat.

If we start a fire with small pieces of wood, not much heat is required to get them burning. This is why shavings and kindling are used. There is a great amount of surface area that can burn, and not much wood to heat to the kindling temperature. There is sufficient fuel, heat and oxygen.

Once we get the smaller pieces of wood ignited, they provide enough heat to get the larger pieces burning.

Birch bark is an excellent fire starter, but the supply is quickly exhausted close to a cabin. Shavings and kindling are prepared in the evening so a fire can be readily made in the cold morning.

## Increasing Burning

If we want to speed up the burning process, we can increase any one or all three: fuel, heat, oxygen.

### *Increasing Fuel*

Adding wood to a fire increases the amount of heat because more fuel is available to burn.

### *Increasing Air (oxygen)*

Increasing the amount of air (oxygen), makes a fire burn faster. This is why we blow on a camp fire or fan it when it is reluctant to burn.

### Increasing Heat

We can do this by insulating the stove with bricks as we do in modern wood stoves, or moving the pieces of wood closer together.

## Controlling a Fire

**Wood stove.** We control a wood stove by controlling the amount of air allowed into the firebox and controlling the amount and type of wood.

**Campfire.** We control a campfire by spreading the wood apart or bringing it together. We add wood gradually to give a sustained fire.

### Controlling Air

There are two ways to control the air supply in a wood stove:

- At the stove door
- With the damper

The most important feature is an air intake control that doesn't leak air into the fire when it is shut down.

If we close the damper on the stovepipe, the fire slows down. Fire needs oxygen to continue.

The air *intake* is slowed down by the draft in the front of the stove. The air *exhaust* is slowed down by the damper.

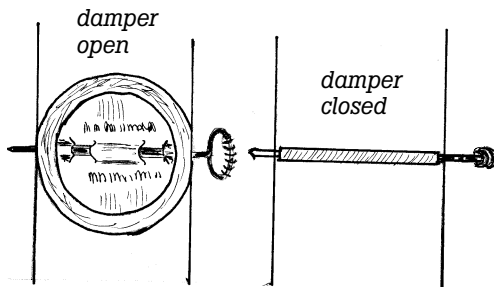

### Controlling Fuel Available

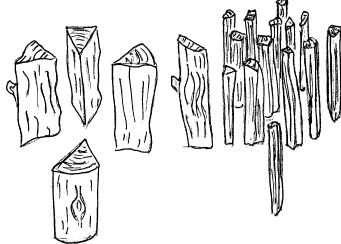

Big pieces burn slower than little ones

We control the fire by the amount, type, and size of fuel we put in. Obviously a stove filled with wood will burn harder than a stove one-quarter full. Dry wood burns faster than green wood. A solid block of wood burns slower than the same block of wood split into many pieces. Wood can only burn on its surface. If we increase the surface area of wood by splitting, it burns much faster.

### Placing the Wood

Before going to bed at night, I put two big logs on the outside of the stove and put the smaller pieces in the middle. The smaller pieces burn out during the night. The big logs are far apart in the stove causing them to burn much slower than if they were close together. Their charred remains are all that's necessary to start the morning's fire.

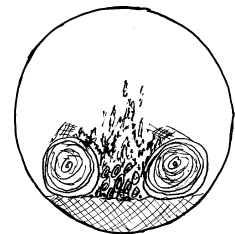

## Mud and Bricks

Dirt in the bottom of the stove is important. As an insulator, dirt keeps the stove from getting too hot on the bottom, endangering the floor. Dirt also retains heat in the stove, keeping the temperature and rate of burning even. It takes a while to warm the dirt, but once it is warm, the retained heat helps

keep the fire going. In the morning, a few burning embers on the dirt base make fire starting an easy task.

Oldtimers avoided putting black rocks in the stove as their water content causes them to explode. Their internal water turns into steam and expands violently. When setting a tent stove in the winter, there is sometimes no choice but to get gravel from the bottom of the waterhole in the creek or river. All other dirt is frozen. The first night is often lively.

Today, most manufactured stoves are lined with bricks. Bricks hold heat, keeping the temperature in the firebox steady.

## Draft

Warm air is thinner and lighter than cold air. Wood stoves draw air into the firebox and, as the air is heated in the fire, it naturally rises up the stovepipe. Modern stoves and stovepipes allow heat into the home while directing the smoke outside.

In traditional Alaskan housing, the smoke rose and exited the house through a hole in the roof.

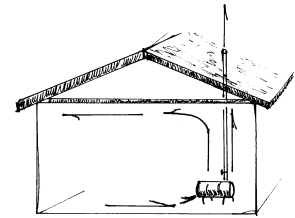

## Considerations in Design

### Size

If a stove is too big, the fire is too far from the stove's surface. It won't throw much heat. Years ago I saw a 100-gallon drum converted to a stove. It consumed huge quantities of wood, and threw little heat. A 55 gallon drum is just right to make a stove for a house.

If the stove is too small, it can't hold enough wood to burn for long. Small stoves also require splitting the wood very small.

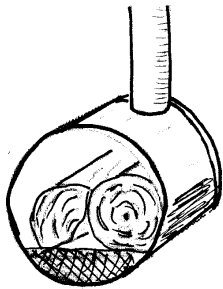

*Stove too small—  
can't hold enough  
wood*

### Surface

If a stove's top surface isn't flat, it is dangerous trying to heat water or cook on it. If the surface is too high above the fire, it will take a long time to boil water. If the surface is too low, the stove cannot hold enough wood. If the surface is black, it will radiate heat well. A light colored stove will not radiate heat well at all.

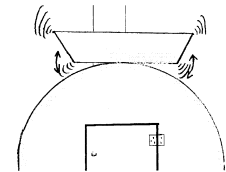

### Stovepipe

If the stovepipe is too large in diameter, it will draw all the hot air up the pipe, and won't throw much heat into the house. If the stovepipe is too small in diameter, the fire can't get enough air to burn well.

If the stovepipe is too short, it can't get enough upward draft and will burn poorly.

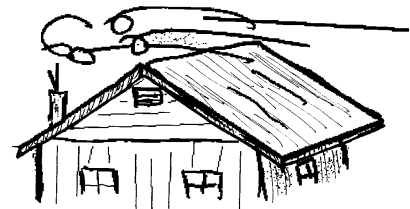



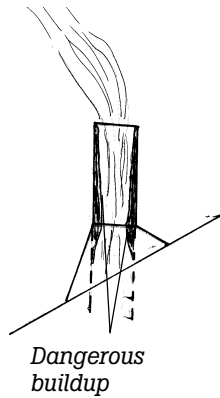

When the wind comes from the opposite side of the house, there is an eddy effect off the roof. The wind blows down the stovepipe and blows smoke into the house. The teacher's quarters in my second village did this. Several times we ran out of the house with tears pouring down our cheeks.

The most dangerous place for highly flammable creosote and soot to accumulate is where the pipe emerges from the building. The smoke is condensed there because the pipe is cooled greatly at that point. This is also where the pipe is closest to the building materials. When a fire occurs in a stovepipe, it is called a "stack fire". Stack fires have burned many Alaskan homes to the ground. Nowadays we use insulated metalbestos pipes. Before metalbestos, we had only black or galvanized pipes, and homemade "roof jacks."

### *Air Control*

If the stove can't control the air flow well, the fire will rage for a while making the house too hot, then it will go out long before morning. If the stove is too airtight the stovepipe will soot up dangerously within a few weeks.

Modern technology has brought us wire brushes to clean our stovepipes. We used to rattle a dog chain tied to a small rope inside the stovepipe.

## **Types of Stoves**

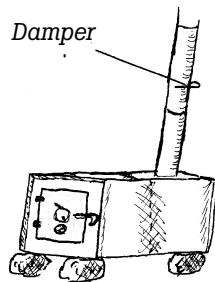

### *Tent Stove*

A tent stove must be light for transport. We used to make stoves out of square five gallon cans. We cut the tops off and put two of them end to end.

A stovepipe damper makes a big difference in controlling the fire in a camp stove. Lacking a commercial damper, we used to slit the stovepipe crosswise with a hacksaw and used a piece of thin metal to slide in and out of the slot as a damper.

Four inch stovepipe is the best for this kind of stove.

### *Half-a-Drum Stove*

This kind of stove is good for a tent if weight of transport isn't a big problem. It is also good for a small cabin.

The top is flat, and it boils water and cooks food well. A five inch stovepipe is best for this kind of stove. The best height, according to the oldtimers, is 14" from bottom to top (not rim to rim). Three white rocks in tripod fashion make good legs.

This is also one of the common types of steambath stove.

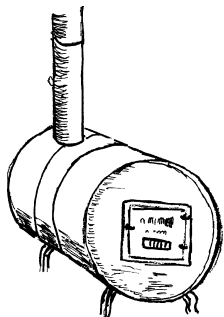
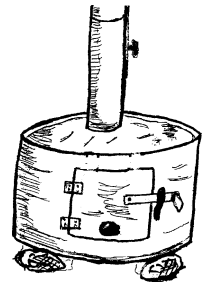

### *Drum Stove*

This stove is better for houses and larger steambaths. A good airtight door is a must for a home. Such stoves hold large quantities of wood, but can they get very hot if the air is not controlled. Commercial doors made from cast iron

are best as the amount of heat generated will warp most homemade doors. This type of stove uses a six-inch stovepipe.

### Modern Commercial Stoves

There are a multitude of commercial stoves available today. For a while they made sense, having fans to increase heat transfer, thermostatically controlled air flow, airtight doors, preheated intake air, and even catalytic converters. Nowadays they are so filled with pollution controlling devices you can't get enough wood in them to heat the house. Some of the features of newer stoves are as follows.

Bimetal helix coil

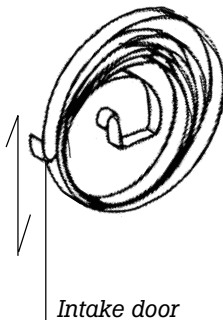

**Thermostatically controlled airflow** Two kinds of metal are bonded together and wound in a spiral. The two metals expand at different rates when heated. It is called a **'bimetal helix coil'**. It requires no electricity to operate. It is connected to the air intake door. When it is cooled, the coil contracts, pulling the air intake door open to the stove. When it is warmed, it expands, allowing the air intake door to fall shut.

**Airtight Doors** If the door isn't airtight, air can leak into the fire, and it will roar until the wood is consumed. Doors used to be sealed with asbestos. The new man-made material tends to shrink and fall out after a while, requiring replacement. Modern stove doors don't compare with the ones that used to be available.

**Preheated Air** If cold air is drawn into the firebox, it slows down the burning of the fuel. Remember, heat is one of the necessary ingredients of burning. Burning is more efficient when the air being introduced into the firebox is warmed first.

**Catalytic Converters** The idea is wonderful. When a stove's air supply is shut down, many gasses are given off from the wood that have tremendous energy potential. They used to be lost up the stovepipe. On the surface of the catalytic converter, in the presence of fresh preheated air, the gasses are burned efficiently... in theory.

In reality, there are problems. The catalytic converters become plugged and soot up. They are damaged when printer's ink or other chemicals are burned in the stove. Often people bypass the catalytic converter or take them out because they function poorly after several months.

## Problems

When we burn **oil** in a stove, we

- allow the stove to have all the air it needs, and
- control the amount of fuel.

In a wood-burning stove, we:

- put a large amount of fuel in the stove, and
- control the fire by restricting the air.

In an airtight stove, this produces incomplete burning. If a stove is not airtight, the fire is seldom at the desired temperature. If we could "leak" the wood gradually into the firebox and allow free airflow in the manner of an oil stove, burning would be more efficient.

### Other inefficiencies

In the front of the log, burning is fairly complete. There is fuel, oxygen, and enough heat. However, when the mixture of smoky gasses go to the back of the log, the air has been exhausted of its oxygen. Many gasses are released from the back of the wood that don't have the opportunity to burn and release their heat. Long logs don't burn as efficiently as shorter ones for this reason.

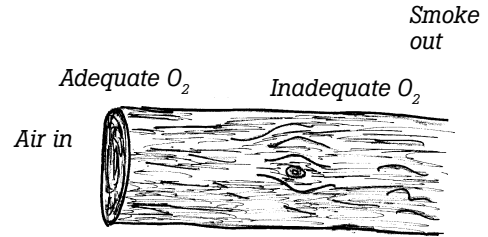

### Damp Wood

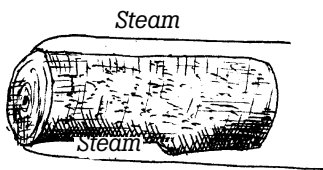

When wood is "green" or the water content is high, there are additional problems. Water boils at 212°F. Wood kindles at about 460°F. Before the wood can burn, the water must be boiled out of the wood. It takes plenty of heat to boil water. So, about 20% of the heat that should be going to our home is going to boil the water out of the wood. Robbery!

Further inefficiency: when the water is boiled away as steam, the steam screens much of the oxygen from contacting the flame.

Green wood has the same potential energy as dry wood, but too much of that energy is used up boiling the water away. This is why many people split wood and let it season for a year or two before burning it. They allow the sun to dry the wood for them. I heard of people falling birch trees in the fall while the leaves are still on the tree and cutting them into pieces several months later. The leaves provide a great surface area to wick-dry the tree. I tried this once. It works well in theory, but it was too hard to maneuver through all the branches with eight to ten trees all tangled together.



## Activities

1. To demonstrate that water is a byproduct of combustion, hold a very cold piece of metal over a small flame. Can you get the water in the smoke to condense on the plate?
2. Hold your hand a safe distance over a candle flame. Can you feel the warm air rising? Can you devise a way to demonstrate this to others, like a pinwheel? (My last pinwheel burst into flames.)
3. Look at the wood stoves in your village. (Does everyone burn oil? Check the steam baths.) Note the controls for air intake. How many different kinds are there? Are most of the doors airtight? What kind of dampers do the stoves have? Do all the stoves have either mud or bricks inside?

4. Find a wood stove with a bimetal helix coil . Heat it with a blow drier or other safe heat source. Watch it close. Cool it with a fan or cold water . Watch it open . Gently file both sides of the coil . Which is harder? Can you guess what kind of metals are used?
5. Put a very green stick of wood on a burning fire (a block from the top of the tree will illustrate well). After ten to fifteen minutes, open the stove door and observe the steam coming from the wood . Can you hear it hiss?
6. Get an old stovepipe that has been used on a wood stove. Scrape the inside. What does the material smell like? Put the material you have scraped on a metal plate and heat it . What happens . Try to burn the material . Does it burn? Was the stove losing heat by not completely burning the wood?
7. Make a campfire . Fan the flame. Does this increase burning? If so, why? Put more wood on the fire. Does the fire burn stronger? Why? Pour water on the fire. What happens and why?
8. Put a candle in a jar. Light it . Put a metal cover on the jar. What happens and why?
9. Discuss the difference between the convenience of burning green wood versus the efficiency of burning dry wood . Ask the oldtimers in the village about the advantages of each .
10. Send for information on modern commercial wood stoves . Discuss the advantages of the different features.
11. Talk to some of the oldtimers in your village about stoves they used to use for travel, for cabins, and homes . Is the information consistent in your area with what I have presented here? If there are differences, why do you think they exist?



## Student Response

1. What things go together to make wood?
2. When your house or tent is heated by a wood fire, where did the energy originally come from?
3. What three things does it take to make a fire?
4. What happens if a fire doesn't get enough air?
5. With a given amount of air, how can you cause wood to burn faster?
6. What does mud in the bottom of the stove do, or firebricks in the modern stoves?
7. Comment about the size of a stove, surface, size of stovepipe, and air intake.

8. In an oil stove we control the flow of fuel. In a wood stove we control the flow of what?
9. What are the disadvantages of burning green wood?

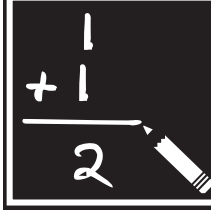

## Math

1. How many cubic feet are in a cord of wood? ( $4' \times 4' \times 8'$ )
2. How many cords are in a pile  $8' \times 5' \times 13'$ ?
3. If green wood has  $\frac{2}{3}$  the available heat as dry wood, and dry wood is \$125 a cord, what is the fair price for green wood if the same value is to be obtained?
4. What is the area of four stovepipes, 4", 5", 6" and 8". Is the area of the 4" pipe  $\frac{2}{3}$  the area of the 6" pipe? (When pi is 3.14)
5. Look at a block of wood. Measure the diameter from the ages of fifteen and sixteen years. Be kind to yourself; use metric measurement. If the block were a perfect circle, what is the area for each year? How much did it increase in one year? Do the same operation between thirty-three and thirty-four years. How much did it increase? How much greater or less was the growth in **area** of the tree when it was younger than when it was older? Figure the difference in volume if the block is .5 meters long.
6. Compute the volume of the inside of three local stoves. Compute the area of the stovepipe of each stove. Is there a relationship (bigger stoves have bigger pipes)?



## Chapter 9

# Wall Tents



Living in a wall tent is very different from living in a house. In some ways it is wonderful. You hear everything that is going on outside . . . dogs, birds, the sound of the river, rain, and more. There is a tremendous sense of freedom.

As there is so little room inside, you want to go outside and be busy. It is hard to be lazy in a tent.

On the other hand, in bear country, sleep in a tent is much lighter than in a cabin. Alert dogs are essential for safety and a good night's sleep.

## Flooring

**Spruce bark** makes an excellent tent floor. It is fairly easy to sweep. It can be removed and shaken outside if necessary. To peel a tree from May to June, it is first ringed low, then ringed as high as the person can reach. A slit is chopped down one side of the tree. The bark is then loosened with a sharpened stick, starting at the bottom, and working around and toward the top.

**Boards and plywood** make a good tent floor, although they need to be nailed down well. As plywood splinters so badly in the weather, I hesitate to use it for tent floor unless it is taken up and stored in a dry place after use.

Some people use **gravel** for a tent floor. All the dust sifts out of sight, so it is self-cleaning. A gravel tent floor always feels cold which is fine during the summer.

**Spruce boughs** make good flooring, particularly in the winter. They insulate well from the cold ground and they smell wonderful. However, they are a fire hazard near the stove.

### Standards

A 15  
D 1, 4

### Concepts

Reflection  
Density

## Stove

A tent is warm as long as the stove is burning, even at  $-30^{\circ}\text{F}$ . The stove needs to:

- be near the door so wood can be easily stacked,
- be close to the ground so the lower areas of the tent are heated,
- be big enough to hold a fire for a while,
- be light enough to transport,
- have a good flat top to cook on,

- be set on rocks or legs to keep it from burning the floor, and
- have a damper to control the fire.

### Sparks



Often sparks will fly out of the top of the stove, land on the tent, and make a hole or start a fire.

One time, at  $-30^{\circ}\text{F}$ , I came back from my trapline, made a fire, and took a nap. I woke up looking at the stars surrounded by a ring of fire. My tent burned beyond repair.

To prevent sparks we used to shoot holes in the top stovepipe with a .22. This allows the sparks a chance to cool before they emerge from the stovepipe. Some people put a screen over the top of the stovepipe, but this hinders the air flow considerably.

We once tried to burn tamarack (lar ch) in a tent stove. It threw so many sparks two of us had to constantly bail water on our tent until the tamarack burned down. No more tamarack! Some people burn dry cottonwood. It doesn't throw as much heat; it makes a lot of ashes, but there are no sparks.

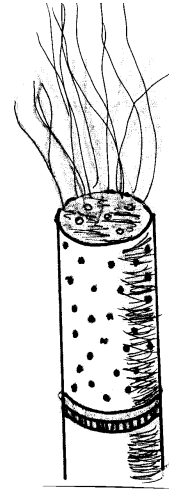

Stovepipe shot with .22

### Foundation

The bottom of the tent must be fastened to logs or boards to prevent the wind from blowing the sides up and to keep drafts out. Mosquitoes have many more opportunities for gaining entrance into a tent than they do in a house.

### Material & Color

A white tent will reflect much of the stove's heat within the walls and will be very warm. A dark tent, green or brown, will absorb much of the radiant heat, and will be cold and damp. The white canvas of a tent is not a good insulator, but it does contain the warm air heated by the stove. It **also reflects** the radiant heat of the wood stove. Oil stoves don't heat tents as well as wood stoves. They don't radiate heat in the same way.

Nylon tents are often frost terribly in cold weather. It would be unwise to put a wood stove in a nylon tent as synthetic fabrics melt with that amount of heat. Sparks destroy nylon in a short time.

Unlike nylon, cotton canvas allows the moisture from cooking and people's breath to pass through. It "breathes." Cotton tents can be treated to be mildew and fire resistant, but both effect the tent's ability to breathe out moisture.



## Rain

Water doesn't run **off** a canvas tent. It generally runs **through** it. That is why there must not be any sagging in the roof when the tent is set. Water settles to the low points and drips inside. A tight tent will shed all water except in a severe driving rain. Rain water passes through the tent and runs down any object that is touching the inside surface.

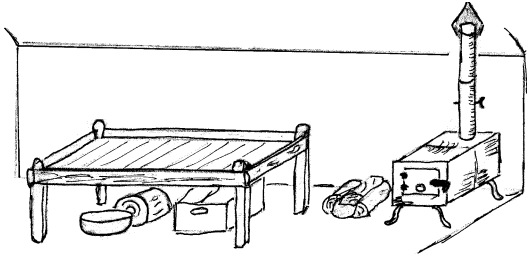

## Beds

In a tent, it is good to have the beds above the floor, as warm air is less dense than cold air and rises. The floor is often cold. This allows for storage under the bed too. The mattress is often grass or caribou skin. They make good, soft, warm bedding.

## Storage

It is very important to dry a tent well before storing it. Tents are made of natural fibers. They rot and mildew easily in storage. If a tent is dried well, the water necessary for bacteria and mold will not be present. Rotting cannot take place.



## Activities

1. Ask the oldtimers in your village what they use for tent floor. If they use spruce bark, get someone to show you how to peel one, although this only works from late May to mid July.
2. Pitch a wall tent. Make the roof nice and tight. How big is it? 10' × 12', 8' × 10'? How high are the walls? When you put the tent away, ask an experienced person to teach you the right way to fold it.
3. Touch the inside of the tent when it is raining. Does it leak down your finger?
4. Make a bed for the tent. Is it warmer on the bed than on the floor?
5. Make a stove for a tent. Make a half-a-drum stove or a five-gallon can stove. We used to use Blazo cans, but square cans are now available from hotels and restaurants where they buy coffee in square five gallon cans. Take your time and make a stove to be proud of.
6. Ask the experienced people in your village about tent stoves and sparks. How do they keep from burning their tent down?
7. What kinds of tents are used in your village now? Many people still use wall tents for hunting camps. How many of the tents are wall tents? How many of them are white? How many of another color? Of the

- canvas wall tents, do any have evidence of mildew? Why or why not?
8. Ask in the village why some people use nylon dome tents?



## STUDENT Response

1. What are four kinds of flooring for a tent? Which is best in the winter on the snow?
2. What wood burns with the most sparks? With the least?
3. What are two techniques to reduce sparks on a tent?
4. Why is a white tent warmer than a dark one?
5. Does water run off or through canvas tent fabric?
6. What are two advantages of having a bed?

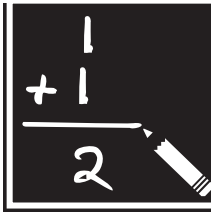

## Math

1. What is the difference in floor space between a 10' × 12' tent and an 8' × 10'?
2. Frank's tent weighs 72 lbs. His stove and pipes weigh another 27 lbs. He can haul 200 lbs in his sled to his trapline. How many pounds of groceries and gas can he haul on the same trip?
3. Ed spent \$225 for a 10' × 12' wall tent with 4' walls. He used it for two seasons, but put it away wet and it rotted. The tent could have lasted eight years if well cared for. How much did the tent cost him per year? How much should it have cost him? Can you put a price tag on his laziness?

## Chapter 10

# Steambaths

Steambaths have been an important part of the lives of most Alaskans for centuries. Beyond the obvious purpose of being a place to get clean, they have been the center for decision making and spiritual functions.

Many good illustrations of science principles are found in the steambath.

### Evaporation

In a steambath, the individual's body perspires attempting to cool by **evaporation**. It takes heat to evaporate water. As our bodies sacrifice water through the skin, the evaporation of that water cools the body.

The perspiration that emits from the skin carries with it toxins and other unclean substances. The individual is cleaned, not just skin deep, but deeper than skin deep.

#### *Increased Circulation*

Some people lightly whip themselves with small bundles of brush. This stimulates blood circulation that helps bring blood to the surface of the skin.

### Wood

Dry wood is very important for a steambath. Damp wood cannot radiate enough heat.

An old man on the Yukon-Kuskokwim Delta used wood scraps from a construction site. Among the wood scraps were pieces of green, pressure-treated lumber. The old man died from the gasses given off. Pressure-treated wood contains arsenic.

### Rocks, steam and condensation

Rocks are important in a steambath because they have enough mass to hold heat and keep the temperature in the bath steady. If there were no rocks, the temperature in the bath would rise and fall quickly.

When water is spilled onto the rocks, the heat in the bath feels more intense. Why?

Evaporation of water requires heat. Condensation releases heat. When we spill water on the rocks, heat is taken from the rocks to evaporate the



#### **Standards**

A 1, 2  
B 1  
D 1, 3, 4

#### **Concepts**

Condensation  
Evaporation  
Surface area

water into steam. When the steam condenses into water on our skin, the latent heat of the steam is released onto our bodies.

### *Kinds of Rocks*

When I first learned about steambaths, people constantly talked about using **white** rocks and warned against using **black** rocks in the bath. Further inquiry showed that many black rocks contain enough water that they will often explode dangerously as the internal water turns to steam. When rocks explode, they sound like a gun blast and pieces of rock fly in every direction.



Most white rocks in Interior Alaska are volcanic (igneous), whereas most of the black ones are sedimentary with considerable water trapped within.

Long ago, before 55 gallon drums were available to heat the baths, people heated rocks in a campfire outside of the bath. They moved heated rocks into the bath, removing the ones that had cooled. This tedious method is still used when people are camping far away from home.

## Hot Air Rises

Everyone who has taken a steambath knows that hot air rises. The higher the individual sits, the higher the temperature. For relief, people often lay as close to the floor as possible.

## Soap

To understand soap, we must understand polar and nonpolar substances.

### *Polar Substances*

Water is a **polar** substance—each molecule is similar to a magnet. One end of the molecule has a partial positive charge, and the other end has a partial negative charge. The materials that dissolve in water are also polar, like salt.

### *Nonpolar Substances*

Some things, like grease, don't dissolve in water. Grease is **nonpolar**. The molecules are not like magnets, they are balanced.

Nonpolar liquids, like oil, will dissolve nonpolar substances, like grease, fat, spruce pitch, and some plastics.

### *Soap Is the Link*

One end of a soap molecule is polar. The other end is nonpolar. It will dissolve a **little** in water. It will dissolve greases, fats, and other nonpolar

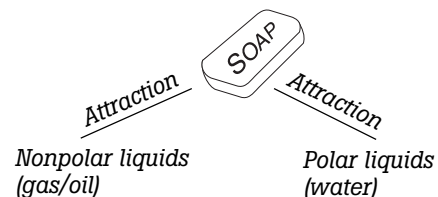

substances . It is a **link** between water and gr easy dirt that water alone cannot remove.

### Conclusion

Showers and bathtub s have replaced the steambath in man y situations, but the s atisfaction of a good steambath cannot b e imitated . Steambaths ar e not likel y to be replaced in time as they pr ovide an ar ena for social events .



## Activities

1. Pour rubbing alcohol into your hand . Blow on it . Does it feel cold? Wh y? Try the s ame thing with a small amount of gasoline. Try now with water. Which cools your hand the most? What causes the cooling?
2. Did/do people in your village whip themsel ves with brush in the steambath? If so, identify the type of brush used in your ar ea.
3. Bring a thermometer into the steambath . What is the temper ature on the floor? A t shoulder height? A t ceiling height?
4. Pour water onto the r ocks . Does the temper ature actual y rise, or does it just feel hotter?
5. Ask the people in your village ab out the b est r ocks for a steambath . Where do they get them? Ask them which r ocks ar e not good, and wh y. Ask someone who knows ab out welding and cutting with an acetylene torch what they can tell you ab out cutting on concr ete. Do you see an y similarities?
6. Try to clean gr ease fr om your hand with water . Try to r emove it with soap . Soak the soap in water . Does it dissol ve? Put the soap in a little stove oil or vegetable oil . Does it dissol ve? What can you s ay about soap dissol ving in b oth oil and water?
7. Ask the oldtimers how they used to make steambaths when they were away fr om the village.
8. Ask the oldtimers if ther e were other r easons for taking steambaths besides cleanliness .
9. Look up "igneous" and " sedimentary". What is the differ ence in their formation .



## STUDENT Response

1. How does perspiring help to cool us off in a steambath?
2. Why do people whip themselves with brush?
3. What causes oxygen deprivation in a steambath?
4. Why are rocks important in a steambath?
5. Why are white rocks desirable rather than black ones?
6. Why is the bath hotter at the ceiling than on the floor?
7. Why does soap work well to remove grease and oily dirt?
8. What are polar and nonpolar substances?

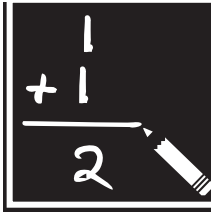

## Math

1. My friend Joe takes a steambath every night of the week. From the time he makes the bath to the time he gets done it takes him about  $2\frac{1}{2}$  hours. What fraction of his life is spent at the steambath?

## Chapter 11

# Insulation & Vapor Barriers

A vapor barrier is usually a sheet of plastic, commonly called "V isquene," through which air and water cannot pass .

A home that has a vapor barrier installed properly will be warm, dry, and will last a long time.

A modern Alaskan house that doesn't have a vapor barrier, or has one installed improperly, will have major problems .

### Rotting

Wood will not rot if it is kept dry . The bacteria that destroy wood fibers need four conditions to grow:

- Wood (their food)
- Oxygen from the air
- Water (moisture)
- Heat

If any of these four is removed, the bacteria cannot grow. In the frame of a house, there is both wood and oxygen. As soon as there is moisture and enough heat, bacteria can grow, destroying the wood fibers. We must keep water out of our ceilings, walls, and floors whether it is water leaking from the roof or water from vapor.

#### Standards

A 2, 9  
B 1  
D 1, 3, 4

#### Principle

Warm air can hold more water vapor than cool air .

When air is warmed, it removes water from other surfaces until it is saturated. This is why we hang our clothes outside in the summer or over the stove in the winter . Warm air removes the water from the clothes by evaporation .

Water that is suspended in air is called **vapor** . When warm air is cooled, it must release some of the water vapor it carries . The water **condenses out of the air** . Heat is released when vapor condenses .

#### Concepts

Evaporation  
Condensation  
Forms of  
energy

## Need for Vapor Barrier in the House

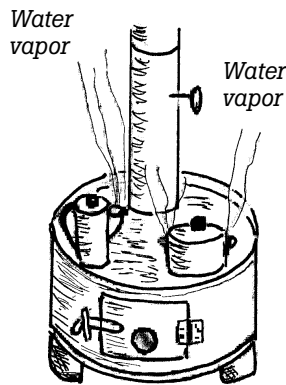

If the air in a house had no vapor, there would be tremendous amounts of static electricity, much of the woodwork would crack, people would have a hard time breathing, and we would often get bloody noses. We see a degree of this when it is  $-40^{\circ}$  or  $-50^{\circ}\text{F}$  and there is very little vapor in the air.

People breathing, coffee pots brewing, and cooking pots all add moisture to the air. When we go outside in the winter we "see our breath." In reality, we see the vapor in our breath condensing. We never see the carbon dioxide and other gasses. When we are inside a warm house, the same amount of vapor is in our breath but we don't see it.

In winter, the vapor of our home freezes on the inside of windows and around cracks in the door.

### Vapor in walls or ceiling

What happens when the vapor in the house enters the walls or ceiling?

As the air passes through the insulation, it cools. Some of the vapor condenses in the insulation. Wet insulation does not insulate as well as dry insulation. The rest of the vapor reaches the outside wall. Frost and water droplets form. Bacteria present immediately start working, breaking down the wood fibers. Rotting begins.

We see the same effect when we breathe through a scarf in very cold weather. Water condenses and freezes on the outside of the scarf.

## Vapor Barrier

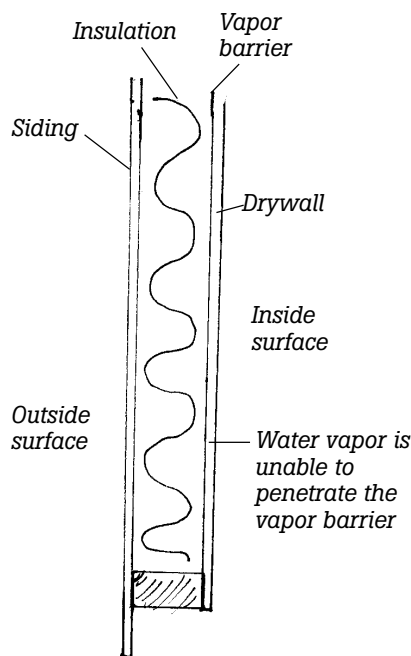

Cross-section of a wall

Warm air carrying large amounts of vapor must be kept from the insulation in our walls and ceilings. This is done by a **vapor barrier** a large sheet of plastic that will not allow air to escape from the room into the walls.

1. insulation is placed in the walls,
2. vapor barrier is stapled over the insulation and studs, and
3. paneling or dry wall is nailed or screwed to the inside surface of the wall.

The vapor barrier keeps the warm air from escaping through cracks into the walls or ceiling.

Some builders don't seal the electrical outlets. Warm air escapes through them into the walls and ceilings doing its damage.

I framed a house. The owner later had major vapor problems in his attic. He blamed me for not cutting enough ventilation holes. However, the problem was caused by tremendous amounts of warm air escaping around the stovepipe into the attic. The solution was to seal around the stovepipe so the warm



moist air couldn't enter the attic space.

## Other Locations in the United States

Interestingly enough, vapor barriers are not used in warmer areas of the United States. Warmer places don't have the severe differences in temperature and vapor content in the air. In Alaska, the thin sheet of plastic vapor barrier, properly installed, can mean the difference between a house lasting a short fifteen to twenty years, or a healthy sixty to a hundred years.

## Vapor Barrier and Insulation Work Together

- A room with insulation but no vapor barrier will soon have vapor and frost in the walls and ceiling.
- A room with a vapor barrier and little or no insulation will frost on all cold spots. A window is, in effect, a vapor barrier without insulation. The frost during cold temperatures is obvious.
- A room that has a good vapor barrier and adequate insulation will keep the moisture necessary for good health in the room, will keep the moisture out of the walls, and will keep the room warm in all parts.

## Insulation

There are several types of insulation adequate for house construction.

- Fiberglass
- Foam
- Sod

Fiberglass insulation actually works two ways:

- It insulates from heat transfer.

Glass does not conduct heat well at all. Put the end of a glass tube in a hot flame, and hold the other end of the tube with bare hands for a long time. If you do the same thing to a copper or steel rod, the heat will quickly be conducted up the rod to your hand.

- Fiberglass traps air.

The glass fibers trap air, preventing circulation. In an open space, air circulates (convection). Warm and cold air constantly mix. When air is trapped in small pockets and prevented from circulating, it is an excellent insulator. The thousands upon thousands of glass fibers woven together keep air from circulating, making a very cozy nest of dead air pockets that insulate the house.

The man-made fibers and down feathers in winter clothing operate on the same principle of creating dead air pockets. That is why wind is so chilling. It blows through the dead air spaces in the fibers, removing the insulating dead air.

### Disadvantages of fiberglass

- It is uncomfortable to install .
- It is destroyed in floods . The insulation on the bottom of a wall gets wet and very heavy. It doesn't dry well at all . With the bottom of the insulation wet and heavy, it sags under the weight, pulling the insulation from the top of the wall .
- Exposed to the outside, small animals constantly carry fiberglass away, making nests with it .

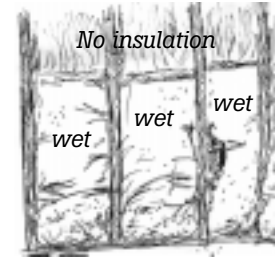

*No insulation*  
*The weight of the wet insulation has caused it to sag down.*

## Foam

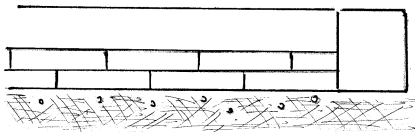

*Foam beneath a concrete slab*

There are many kinds of foam insulation . Some are waterproof, others are not . Some are damaged by sunlight, others are not . Foam has some wonderful insulating qualities for the same reasons fiberglass does . It also adds structural strength to a building that fiberglass does not . Most kinds of foam are unaffected by flooding, frost, and vapor . Foam insulation is excellent for insulating pipes below ground level . It stays completely dry for decades .

Foam insulation in a house is expensive. It is also deadly when it burns, giving off poisonous gasses .

## Sod/Grass

Old time Alaskans insulated their roofs in a different way than we do today. The ridge pole was covered by poles, or split spruce trees. The poles were covered with birchbark and/or grass which shed water .

Sod was placed over the grass, and over the sod, dirt . This type of roof had no vapor barrier, but it " **breathed** ". The vapor passed through the grass, sod and dirt, and into the air . Frost problems were unheard of. Grass grew on these roofs . They were very warm and felt quite cozy .

Unfortunately, sod roofs could not have a steep pitch as the dirt would wash away. Sod roofs were so heavy they needed a very large ridge pole in the middle. The weight of the roof frequently buckled the gable ends, and repairs were often necessary. The wood in sod roofs did rot after a period of time and required replacing .

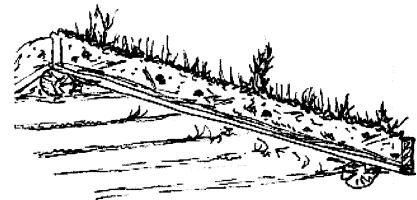

## Roofs

Today's steel roofs are relatively light . They easily shed snow and are completely waterproof . Ceilings are insulated with fiberglass .

### Thermal Conductivity of Different Materials

Glass	.7-.97
Steel	.46
Aluminum	.210
Copper	.386
Wood	.13
Cement	.3-1.8
Down	.02
Water	.58
Air	.026
Fiberglass	.04
Styrofoam	.024

Some houses have icicles hanging from the eaves and others do not. There is a reason for this.

If the roofing material is warmed by the building heat, the snow in contact with that roofing melts. The overlying layer of snow insulates it. The water runs down the roof toward the edge. However, when it gets to the cold uninsulated overhang, it freezes, causing the water to back up under the snow layer.

This goes on for some time until there are large icicles hanging from the edge of the roof and water is seeping into the ceiling of the house. I built a roof like this once, and walked in overflow on my roof at  $-30^{\circ}$ .

Although this is very damaging, people continue to build roofs in Alaska in this manner, particularly in Anchorage.

The solution is to make sure there is cold air circulating between the roofing material and the insulation. That way no heat can escape to melt the snow.

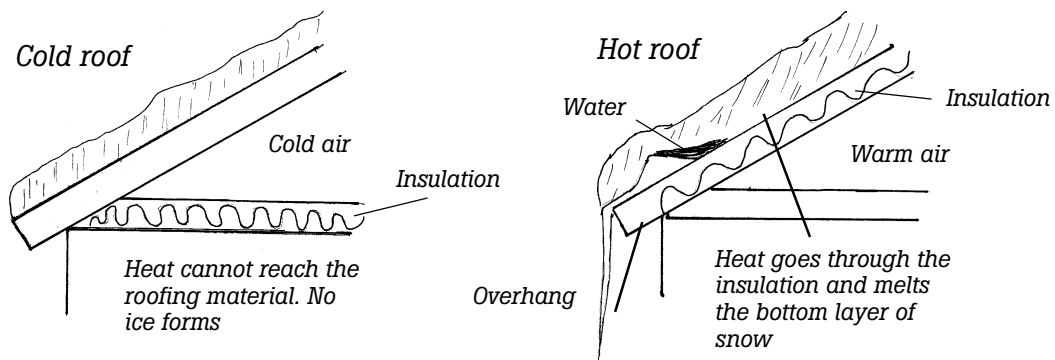

### "R" Rating

The R rating of insulation tells how well it does its job. Two inches of foam is usually R10. Six inches of fiberglass is R19. R32 is very good insulation.



### Activities

1. While in a warm house, close the cover on a jar. Bring the jar outside or put it in a freezer. Is there condensation inside the jar when it is cooled? Bring the jar into the warm house again. What happens?
2. Breathe on a plate or piece of metal that has been cooled outside in subzero temperatures. What happens. Bring it inside and watch what happens. Where does the frost go?
3. The next time it gets  $-40^{\circ}$  or  $-50^{\circ}\text{F}$ , scuff your feet on a rug and touch a doorknob. Is there a spark? Why do you think this doesn't happen when it is warm?

4. The next time it gets very cold, put a blanket against the bottom of a cold window and leave it overnight. What happens? Why?
5. During cold weather, observe windows that are single, double, and triple pane. What difference do you see?
6. How are winter shoe packs with felt liners like a wall without a vapor barrier? What happens in very cold weather when you try to take the liners out of the boots after wearing them all day? Why does this happen? Can you think of a way of preventing this?
7. Compare shoe packs with felt liners to the white "bunny" boots or VB (vapor barrier) boots as they are called. What are the similarities and differences?
8. Check the houses in the village. Ask what kind of insulation is in the walls and ceiling. Is there a vapor barrier?
9. Check the roof of an old abandoned cabin in your area. What kind of insulation was in the walls and ceiling?
10. Try to find an old abandoned log cabin with a sod roof. Study the roofing materials.
11. Test wet and dry insulation (wet & dry socks?) for their conductivity of heat.
12. Ask the oldtimers how they could detect a bear hole during winter months. Does one of these signs relate to condensation?
13. Put a glass tube or other piece of glass in a hot flame. Does it conduct heat well? Compare this with a metal coat hanger or other piece of long metal. Compare these with wood.
14. Visit a house under construction or talk to local carpenters. Do you see the vapor barrier? What do the carpenters say about vapor barriers?
15. Ask oldtimers about sod roofs. Were they warm? Did they leak?
16. Submerge a piece of closed cell foam (usually blue or pink) after weighing it. Leave it under water for a few days. Weigh it again. Did it absorb any water? What is the R factor of two inches of foam?



## STUDENT Response

1. What four things do the bacteria require that cause wood to rot?
2. What is vapor?
3. What would happen if there were no vapor in the air of our homes?
4. Which can hold more water vapor: warm or cold air?
5. What happens to the vapor in warm air when the air is cooled?

6. What happens when vapor gets into the walls of our homes?
7. Draw a cross section of a wall that has insulation and a vapor barrier.
8. What things in our homes naturally put water vapor into the air?
9. If you tried to explain the use of a vapor barrier simply to someone who didn't know, what simple rules would you give them?
10. What two things make fiberglass good insulation?
11. What are the three disadvantages of fiberglass insulation?
12. What are two disadvantages of foam insulation?
13. Draw a cross section of a sod roof. Did the oldtimers use a vapor barrier?

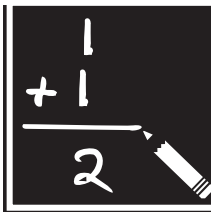

## Math

1. A roll of visquene is 8'  $\times$  100 feet. Assuming there are no overlaps (in reality there are). How many rolls of visquene are necessary to put a vapor barrier in a house 24'  $\times$  36', with walls 8' high. The outside walls and ceiling need a vapor barrier. How many square feet will be left over for overlap and other purposes?
2. The above house needs \_\_\_\_\_ square feet of visquene. It comes in rolls of 12'  $\times$  100 for \$47.21 or rolls of 8'  $\times$  100' for \$29.52. What is the best combination of rolls that can be purchased and what is the total cost?
3. Two inches of foam has an *R* factor of 10. Six inches of fiberglass has an *R* factor of 19 (round off to 20.) A piece of foam is 2'  $\times$  8' and costs \$14. Fiberglass costs \$37 for a bundle that contains 78 square feet. Which is the better insulation buy for a square foot?
4. A building has 1276 square feet to insulate with six inches of fiberglass. The price of fiberglass landed on the jobsite is \$.47 per square. What is the cost of insulating the house?
5. Hank was building a 40'  $\times$  56' shop. He wanted to pour the concrete floor over 4" of foam. Each piece of foam is 2"  $\times$  2'  $\times$  8'. How much would this cost if he could get the foam for \$1.09 each? (Round off if you like.)



## Chapter 12

# Gas Lamps & Gas Stoves

For many years, before electricity was made available to Alaska villages, people used gas lamps and stoves as everyday household items. Now, they are used on hunting and camping trips and in fishcamps, but seldom in homes. A magazine stated, "Gas lamps hiss and clank and blind you just like civilization." Not everyone agreed with that, but everyone does agree that they hiss and clank. Gas lamps give a strong white light, making bright spots and dark shadows in a room. Today hunters use them to follow a blood trail in the dark, and fishermen use them to spear fish at night.

One of the few good things about a gas lamp is that you can turn it off and jump in bed before the light goes out.

### Main Parts

There are three main parts to a gas lamp:

- The tank
- The generator
- The mantle

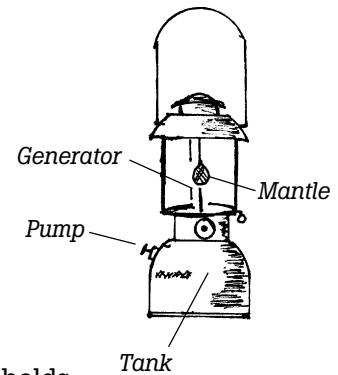

### Tank

The tank holds the fuel. The pump creates and holds the pressure that forces the fuel up, over and through the generator.

### Standards

A 1, 2  
B 1  
D 1, 4

### Generator

The generator is responsible for preheating the fuel and air.

#### Preheating the Fuel

As the fuel passes through the heated generator, it actually boils, turning into a vapor in the generator. If the fuel burned as a cool spray, it wouldn't have enough **surface area** to burn thoroughly. When it is vaporized in the

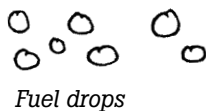

### Concepts

Evaporation  
Surface area  
Forms of energy

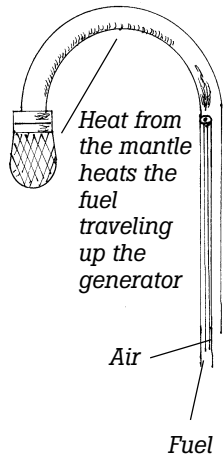

generator, it is broken into tiny droplets with great surface area. The vapor emerges through the screen which spreads the vapor evenly into the mantle where it is burned. The generator is to the gas lamp what a carburetor is to an engine. They both mix fuel and air in the proper amounts.

### Importance of vaporizing the fuel

If you try to ignite a block of wood with a match, it has too much mass and not enough surface area to sustain burning. If you split it into small pieces, and make shavings to further increase the surface area, that same block of wood will burn quickly and thoroughly. This same principle is applied when liquid fuel is heated to a vapor, or, drastically increasing the surface area available for combustion.

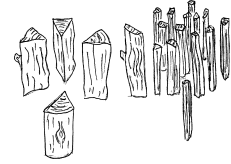

## Practical Proofs

This point is illustrated when we first light the lamp. It burns with a rough yellow flame until the heat from that flame preheats the fuel in the generator.

It is again illustrated when the generator is dirty. The soot on the generator insulates the fuel from the heat of the flame. It takes a long time for the fuel to vaporize. As soon as the generator is cleaned, it will again conduct heat to the fuel to vaporize it.

Gasoline mixed with two-cycle oil spoils a generator almost instantly.

## Preheating the Air

Preheating the air as it passes through the generator is important because there are three things necessary for fire to occur:

- Fuel
- Air (oxygen)
- Heat

If one of these is removed, the fire will go out. If the air is cold, it will slow the burning. Preheating the air in the generator helps keep the temperature high enough to support combustion.

## Temperature

Glass keeps the heat in

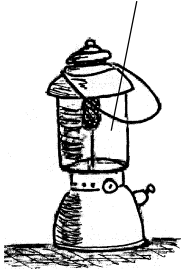

In homes, people often removed the glass that surrounds the generator and mantle as it gets in the way of lighting the lamp. The lamp is brighter without it. However, we use gas lamps to spear whitefish at night in the fall. Without the glass to retain heat within the lamp, the lamp doesn't get warm enough to burn well at all. Only with the glass in place to retain heat do they work in low temperatures.

When fishing at night, we put the lamps in a five-gallon can that is open on one side. This keeps the light out of our eyes, reflects more light ahead, and holds heat for the lamp.



## Danger

The heat above a burning gaslamp in the house is so great there is a considerable fire hazard. People often put shiny reflectors between the rising heat and the wood frame of the house. Lamps are hung on metal hooks far below wood surfaces.

Reflector

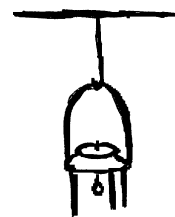

## Mantle



The mantle material, which is really an ash, is very fragile. If there were no mantle, a gas lamp would be like a blow torch. There would be considerable heat, but little light from the flame. As the heat of the flame heats the mantle, it glows brightly, changing much of the heat energy to light energy. Older mantles actually contained radioactive materials.

Burn a new mantle outside, and don't breathe the fumes.

## Screen

There is a screen at the mouth of the generator where the fuel and air pour into the mantle. The screen does two jobs.

- It spreads the fuel/air mixture so combustion is even.
- It retains heat so combustion takes place on or around its surface. It is not a chemical catalyst.

If a screen is damaged the lamp gives off a roaring sound and combustion is uneven.

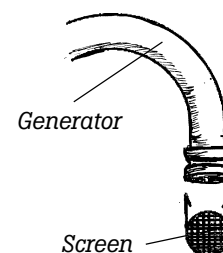

## Gas Stove

A gas stove works the same as a gas lamp, except there is no mantle. The desired result is heat to cook with, not light to see by.

The fuel comes from the pressurized tank through the generator which passes through the flame. As the fuel is heated, it turns to a vapor. When it emerges, it burns with a hot blue flame.

Generator over flame

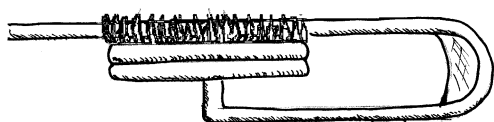

The color of the flame indicates what is being produced by the combustion of the fuel.

When fuel is burned and carbon monoxide is produced, the flame is yellow.

A carbon dioxide flame is blue.

A yellow flame produces **only one-third** of the heat energy of a blue flame!

Recently, we were traveling in our van. I wondered if I should get a gas stove or a propane stove. I decided on a gas stove. Propane under pressure can leak in the small area of the van and explode. The pressure of a gas stove

can be released. It is safe to store in tight places. Gas stoves aren't as convenient as propane stoves. Gas stoves are lighter and cheaper to carry on camping trips in the boat and sled than propane stoves and tanks.



## Activities

1. Put a little (room temperature) gas lamp fuel in your hand. Blow on it. Does it feel cold? Why? Put a little room temperature stove oil in your hand. Blow on it. Does it feel as cold? Why? Can you explain why we don't use stove oil in a gas lamp?
2. Cut two identical blocks of wood. Split one into four parts. Split the other into small kindling. Make two campfires of the same size. Put the split pieces of the first block on one and the split pieces of the second on the other. Which burns faster? How much faster? What can you say about increasing the surface area of fuel?
3. First light an old gas lamp. Let it cool down, then take the generator out. If you are careful you can do it without breaking the mantle. Is it black with soot? Scrape it clean with a pocket knife or sandpaper. Reinstall it, and light the lamp again. Can you tell the difference between before and after? What is the difference and why?
4. Observe. What do you suppose the little needle is for on the end of the generator you just removed?
5. Get someone with the necessary knowledge to show you how to replace a mantle. While the old mantle is off, inspect the screen. Does it have any holes?
6. If possible, research what kind of material is used in the mantle of a gas lamp. How is the material unique?
7. Pump the tank full of pressure. Release the pressure. Lubricate the pump with a few drops of oil, and pump the tank again. Is there a difference? Why?
8. Ask people in your village if they use gas lamps outdoors in the past. Do they still use them in hunting, whaling, or fishcamps?
9. Light a gas stove. Identify the parts of the flame that are producing carbon dioxide. Identify the parts of the flame that are producing carbon monoxide.
10. With the same amount of water at the same temperature in the same teapot, time how long it takes to boil water on the gas stove, on a propane stove, and on an electric stove. Which is faster? Which do you think is more convenient? Which do you think is safer in the house?
11. With pliers, hold a piece of a broken mantle in the flame of a candle or gas stove. Does it glow?



## STUDENT Response

1. What are the three main parts of a gas lamp?
2. What is the main purpose of the generator?
3. What happens to fuel in the generator?
4. Draw a picture of fuel as a liquid and the same amount of fuel as a vapor.
5. Why does the generator pass over the flame in both the gas lamp and gas stove?
6. The screen in a gas lamp does two things. What are they?
7. Why do whitefish hunters have a hard time with their gas lamps in cold temperatures and what is the cure?
8. What color is the flame when carbon monoxide is produced? What color is the flame when carbon dioxide is produced?
9. Which is more efficient in the production of heat: combustion to carbon monoxide or combustion to carbon dioxide? By what ratio?

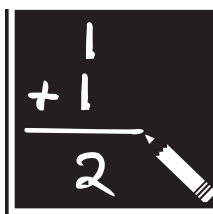

## Math

1. If a blue propane flame gives off 1500 BTU<sup>1</sup> how many BTU are given off if the air adjustment is wrong and the flame is completely yellow? (Blue flame:  $C O_2 = x$  BTU, Yellow flame:  $C O_2 = \frac{1}{3}x$  BTU)
2. A 5 gallon can of Blazo fuel costs \$38. It lasts Mark 3 months in his trapping cabin. A bottle of propane lasts him 7 months at home. Propane is \$1.05. Which is cheaper per month?
3. Gas lamps don't work well with leaded gas. But Blazo fuel is \$8 a gallon, and leaded gas is \$2.25 a gallon. New generators are \$1.98 apiece. Mark is wondering if it is cheaper to burn cheaper fuel and change generators once a week or whether it is cheaper to burn the correct fuel. Which method is cheaper if a gallon of fuel lasts three weeks?

1. BTU is British Thermal Units, a measurement of heat.



# Ways & Means of Travel

Chapter 15: Piloting a Boat  
89

Chapter 16: Boat Design  
97

Chapter 17: Magneto & Spark Plugs  
107

Chapter 18: Carburetors  
115

Chapter 19: Compression  
121

Chapter 20: Outboard Motor Lower Unit  
127

Chapter 21: Outboard Motor Cooling System  
137

Chapter 22: Dog Sleds  
143

Chapter 23: Snowmachine Tracks  
155

Chapter 24: Snowmachine Clutch  
161

Chapter 25: Snowshoes  
167

Chapter 26: Winter Trails  
173

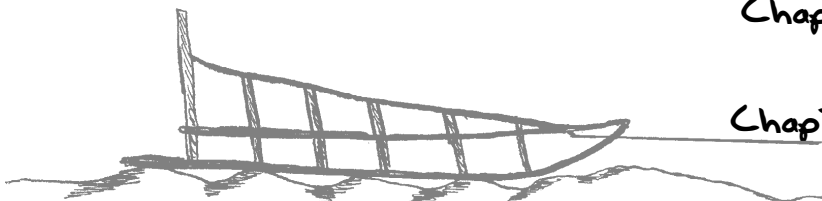
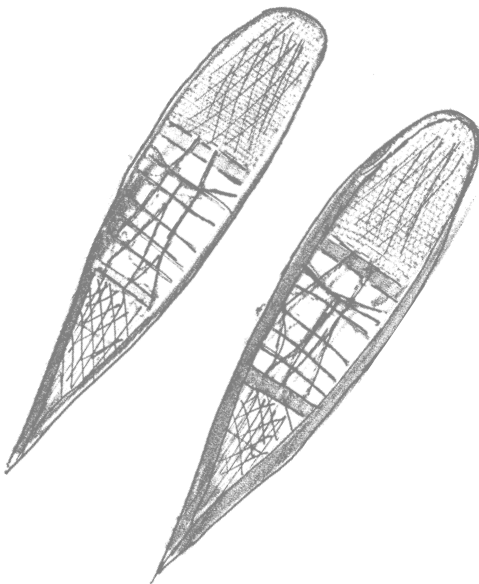
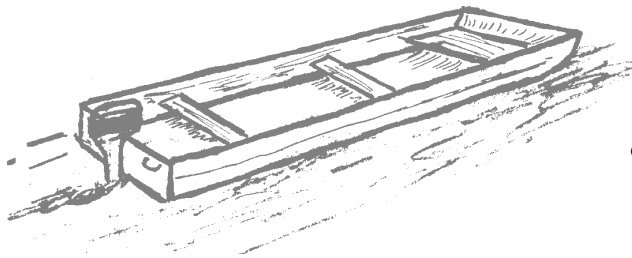



## Chapter 15

# Piloting a Boat

### Reading Skills

Most Alaskans live or hunt on rivers. On almost every Alaskan river there are a few people who really know how to pilot a boat. They are river scientists who operate by basic principles the rest of us need to learn.

Once we are able to read a book, we have the skills to read other books. Once we are able to read a certain river, we discover that we have the skills to read other rivers also. The signs and patterns are common to all rivers. Repeated travel helps us learn the river better. However, a good pilot can travel a completely strange river and sight read it the same way you would read a new book.

With identical boats, an experienced pilot can go from one place to another faster than an inexperienced pilot. How is this possible? He understands the forces working for and against his boat, for and against the river.

### Three Main Forces

There are three main forces working on the water in a river.

- **Gravity** pulling the water downward towards the sea. The steeper the incline, the greater the velocity of the water.
- **Momentum** of the water goes around a bend. Inertia causes most of the water to go to the outside of the bends.
- **Friction** with banks and river bottom.

The river channel is often deeper on the outside of bends. On the inside of the bends, the current is slack.

Look at the following drawings of a typical bend in a swift river. The two forces, gravity and inertia, are sometimes working together and sometimes competing. In the first drawing, the slope of the river isn't too steep, so inertia carries most of the water to the **outside** of the bend, creating a swift deep channel there.

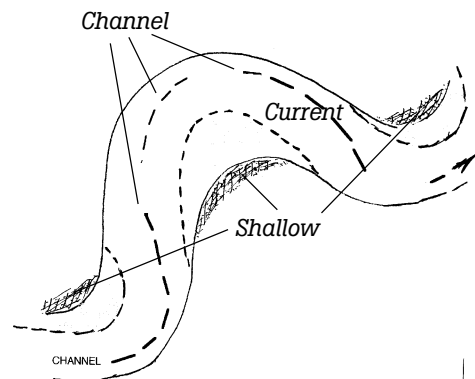

#### Standards

A 5, 6, 15  
B 3  
C 3  
D 1, 2, 3

#### Concepts

$F = MA$   
Inertia  
Friction

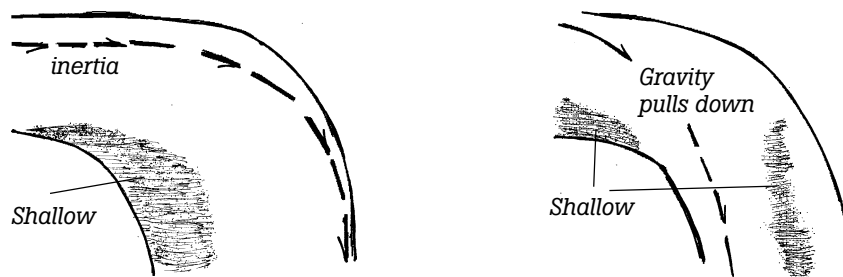

In the second drawing, the slope the water is flowing down is steep. Inertia is working to carry water to the outside of the bend, but the drop is so great, gravity forces the water to fall to the shortest distance which is on the inside of the bend. Gravity overrides inertia.

If the pilot understands these two forces and how they interact, he can understand almost all river situations in Alaska.

### Islands Formed

When the current slows, and its ability to carry sediment also decreases, an island or sandbar forms in the middle of the river. The channel goes to either or both sides of the island.

Other islands are formed when the river channel erodes its way through the banks, separating large land segments.



### Pilot's Priorities

As the pilot looks at the river while going upstream, the priorities are:

1. Water deep enough for his boat and motor
2. Shortest distance
3. The least resistance from the current

The pilot looks at the stretch of water in front of the boat. Math and science blur together as decisions are continually made figuring the best path to travel. Where are the snags, eddies, slack current, straightest paths, and shallowest waters?

### The Current Varies

The current is slower close to the riverbank than in the middle of the river. Friction with the riverbank and bottom of the river in the shallow places slows the current. If you measure the current across a river, you will find that it varies tremendously from place to place.



Salmon are aware of this and travel the path of least resistance in their journey upstream. They prefer the shallows at night because they feel safe, but swim on the bottom in the middle of the river during daylight in order to avoid detection.

The current might be six miles per hour (mph) in the middle, eight mph five feet from the cutbank, and two to three mph right against the bank, two mph on the sandbar side of the river in the shallow places, and minus two mph in the eddy.

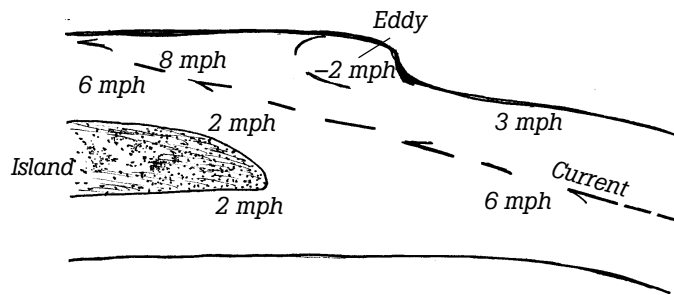

A good river pilot takes advantage of all **slack current**. Against a cutbank, the water swirls backwards due to friction with the bank. Sometimes the stumps and brush keep a good pilot away from those back currents, but traveling close to the cutbank adds several miles per hour to the boat's speed as it goes upstream.

### Eddies

The water swirls backwards **in eddies**. The current is actually going in the opposite direction from the rest of the river. Good pilots search for eddies.

Fish rest in eddies and use the current to assist in the upstream effort. The opposing currents hold a net in perfect position to catch the fish as they head upstream. Because of this, good pilots watch out for nets as they travel the eddies.

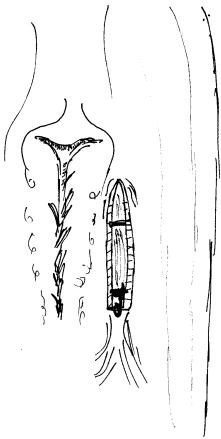

### Using Rocks and Snags

The current swirls in low pressure areas behind rocks and snags. A good pilot enters a place with slack current behind a rock, gains speed, and shoots out before crashing into the rock.

In very shallow water, an experienced pilot knows that the water is deeper right beside snags and rocks, as the water intended for the snag is diverted aside, creating a mini-channel deep enough for the boat.

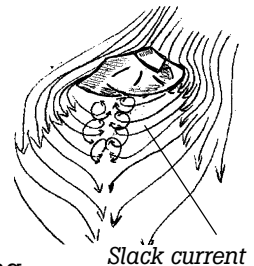

## Efficiency

A pilot must decide which path upriver gives the least resistance. Obviously it isn't worth crossing a wide river to get a little help from an eddy. There is a constant give and take in this regard, constant decision-making by the pilot.

### Ground Effect

A boat lifts when traveling in shallow water. The pilot hears the motor speed up as the boat lifts. The shallower the water is, the more lift there is, but there is also a greater chance of hitting bottom. This is why the pilot pays close attention to the sound of the motor.

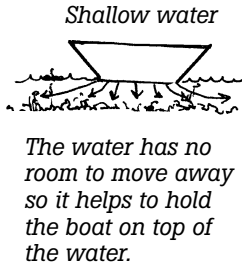
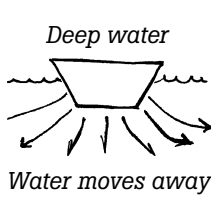

When the boat is in deep water, the water is pushed down and away from the bottom of the boat. The boat sinks to some extent. This happens even with a planing boat.

In shallow water, the water is pushed downward and away from the bottom of the boat, but it cannot move downward because the bottom of the river is solid. The boat pushes down. The water and bottom push up.

### Waves

Some waves are caused by the current moving around underwater obstructions. Surface waves are created by wind blowing over the water's surface. When the current and wind are moving in the same direction, the waves are small. When the current and waves go against each other, the combined velocities can be great, causing large waves. This explains why some sections in a river can have no waves, and another section of the same bend can have whitecaps. On one section of the river, the wind blows directly against the current. On another section it is crosswise. In another section, the wind is blowing with the current.

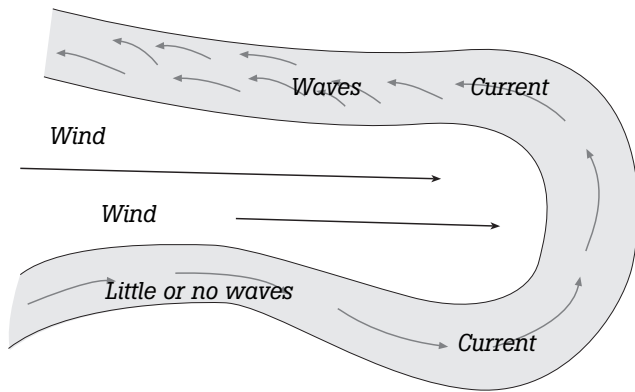

This is particularly distressing when rafting logs or firewood. The pilot feels totally safe on one section of the river, rounds a bend, and gets into huge whitecaps that threaten the safety of the boat and raft.

Wind generated waves are smaller against the bank. Why is this? The current against the bank is slower than it is in the middle of the river, and therefore the combined velocities of the wind and water is less. The waves in the middle are bigger because the combined velocities of the unobstructed wind and current going against each other are greater.

### Friction

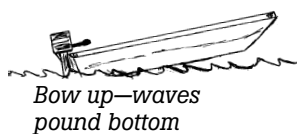
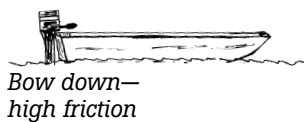

Another consideration of piloting a boat concerns the friction of the boat against the water. The more surface that is in contact with the water, the more friction there is.

A boat that has the bow too low will have a lot of surface to create friction.

A boat that has the bow too high will plow the water, and pound in the waves. A good pilot adjusts the angle of the boat by shifting the load and changing the tilt on the engine.

## Trapped Air

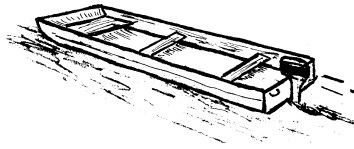

*Jon boats have ridges that trap air under the boat*

Waves trap air under the boat. The air, once under the boat, becomes flat bubbles that tremendously reduce the friction with the water. This effect is very noticeable when coming from a small creek onto a larger river on a windy day. The boat accelerates when it hits the small choppy waves and breaks free from the drag of smooth water. The boat decelerates considerably when it comes from a river with small choppy waves and enters a smooth creek.

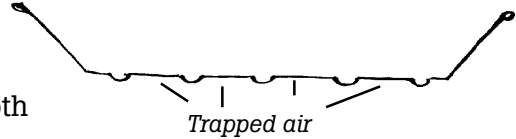

## Reading the River

It is very hard to read a river when it is windy. Whatever sign might be presented by the snags and rocks is masked by the waves from the wind. It is like trying to read a book in the dark.

It is also very hard to read a river when there is little or no current. Some of my greatest disasters have been on windy days or in dead water.

When there is adequate current, shallows, rocks, and stumps all give sign of their presence and are easy to read.

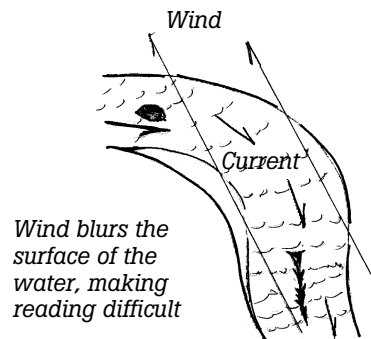

*Wind blurs the surface of the water, making reading difficult*

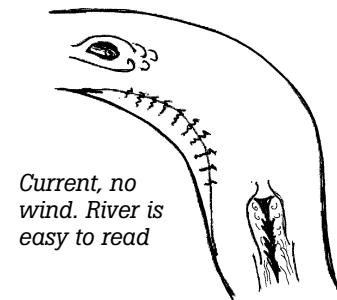

*Current, no wind. River is easy to read*

## Upstream vs Downstream

Going upstream in a swift river is easy because all the obstacles are obvious and the boat is traveling slowly against the current allowing time to look and think.

Going downstream is another story. The rocks and other obstacles are covered with water. The boat is going so fast there is little reaction time. Going downstream is more difficult and dangerous.

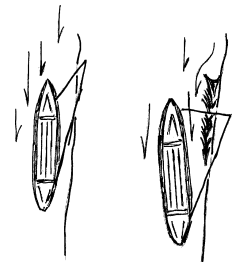

*Lining up with two ropes*

## Lining Up

Years ago, people pulled their boats up the river. The tops of the banks were cleared of brush. They were lined with hard packed trails. Even today, people who break

down while downriver from their village sometimes line up to get home. With one rope, the boat is very hard to steer. Two ropes easily steer the boat in and out around snags and obstacles.

## Travel at Dusk

Good pilots learn to protect their night vision, as it is quite easy to read the channel in twilight even after the sun has gone down. The glare from the surface of the water highlights all of the signs the pilot is looking for. It takes most people fifteen to twenty minutes to develop night vision.

Artificial lights are a hindrance unless they are extremely bright. The glare from the water makes visibility worse and ruins night vision. It is important to have running lights, not for the pilot's vision, but so boats will not collide.

Years ago a boatload of people ran over a swimming moose at night. Five people drowned. Travel in full darkness is not wise at all.



## Activities

1. Watch a video about a swift river or go to a swift section of a local river. Discuss the route you would go to take advantage of all the areas with slack current. Draw a map of a section of that river. Ask one of the elders in your village which way they would travel if they were piloting a boat on that stretch of river.
2. Imagine that you are a salmon going upstream in that river. Color the path you would swim during the day in blue. Color the path you would swim at night in black.
3. Draw a typical stretch of river in your location, or where you go to hunt. In your imagination, estimate the current in different parts of the river.
4. If it is possible, measure the current in a cross section of that river. If you have no way to accurately measure, release a stick on the sandbar side, timing how long it takes to pass a certain point downstream. Do this again, releasing the same stick in several points across the river from the original release point. Measure the time it takes to reach the same downstream point. Compare their results.
5. At each of the above points measure the depth of the river. The easiest way might be to put a weight on a string, putting a knot at every foot in a string. Counting the knots as they slip through the fingers will give the depth in feet.
6. Observe islands in your river. Do you think the river widened, depositing the islands, or did the island occur because the river cut a new channel? Either might be the case.
7. The next time there are waves on your river caused by wind, note the

bends they occur on, the direction of the wind, and the relationship of the wind to the current. Where are the biggest waves? Are the waves as large by the shore?

8. If possible, drive the boat from a river where there are choppy waves into a creek where the water is flat. Can you feel the difference in the speed of the boat?
9. While piloting a boat in deep water, set the throttle so the boat is barely on step. Cruise to the sandbar side of the river and notice the increase in speed of the boat and motor. Be careful not to hit bottom!
10. Listen and watch closely the next time you are in a boat. Hum in tune with the motor. Does the pitch of the motor get higher when you pass through shallow water? In and out of eddies? Do you think this effect is more noticeable with a planing or displacement boat?
11. Ask the people in your village about the dangerous places on your local rivers. What stories can they tell about close encounters?
12. Pour water out of a teapot that has a spout. Observe. Where is the strongest flow of water? Which is stronger, gravity or momentum?
13. Put a piece of plywood on a slant. Pour water from the teapot across the top end. Observe and mark where most of the water flows. Tilt the plywood up and down changing the angle, again observing and marking the greater flow of water. At what angle does gravity exert the greater force, pulling the flow of water downward instead of yielding to momentum? Try to keep the water flow and pressure the same while changing the angle.
14. Design a boat that would trap air under the boat so it will travel on a cushion of air.

*Plywood not too steep*

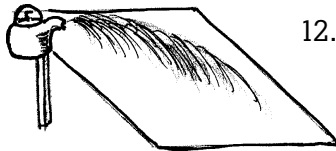

*Momentum is strong. Water pours out.*

*Plywood steep*

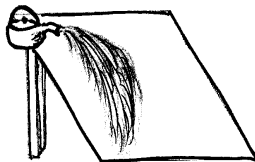

*Gravity is stronger pulling water down more.*

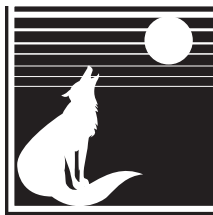

## STUDENT Response

1. What are the two main forces working on the water in a river?
2. Draw a typical bend in a local river. Identify the deep and shallow places. Estimate what the current will be in five places on the river.
3. Why is the current next to a river bank slower than the current in the middle?
4. In the picture to the right, tell how fast you think the water might be going in the different places circled if the current in the middle is 6 mph.

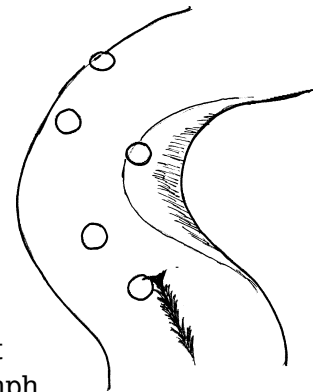

5. What are the three priorities a pilot operates by when traveling upstream?
6. Draw a picture of a typical bend in a river. Draw a big rock in the middle of the river. Draw the path a boat might take.
7. Draw a picture showing a boat in ground effect and another in deep water.
8. Why are the waves caused by wind larger in the middle of the river than on the sides of the river?
9. Draw a picture of a boat that is traveling at the best angle for waves.
10. Draw a picture of a boat that is traveling at the best angle for calm water.
11. Why do small choppy waves help a boat travel a little faster?
12. What are three things to remember or do when traveling at dusk?

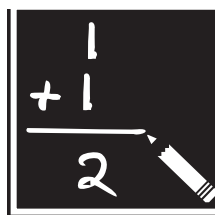

## Math

1. Pete can travel the from the store to his cabin in 3.5 hours. His son can make the same trip in 4 hours. If gas is \$3 per gallon and the motor uses 4 gallons per hour, how much more does it cost his son to make the same trip?
2. A boat travels at 16 mph relative to the water. The river's current averages 9 mph. How long will it take to make a round trip of 22 miles each way? What is the total time of the 44 mile trip?
3. A boat travels at 16 mph. How long will it take to make a round trip of 22 miles each way across a lake? What is the total time of the 44 mile trip?
4. Compare the trip in current and the trip on the lake. Why do you think there is a difference?
5. An outboard motor uses 4 gallons per hour. It can go 21 miles per hour. How many miles per gallon does it use?
6. Another outboard uses 3.2 gallons per hour, and goes 18 miles per hour. Which outboard is more economical?
7. Which of the above outboards is more economical going upstream for 72 miles on a river with an average current of 12 miles per hour?

## Chapter 16

# Boat Design

Most Alaskans live or hunt on rivers. Boats are an inseparable part of our lives.

There are basically two kinds of boats, each serving a specific purpose:

- Planing boats
- Displacement boats

### Planing Boats

**Planing boats**, once they get enough speed, skim on top of the water. They go fast and are good for light loads.

Planing boats usually have a wide flat bottom, allowing the boat enough surface area to get on top of the water. When a boat climbs on top of the water we say it is “**planing**” or “**on step**”.

#### *Compromise*

A **V** bottom is good for breaking waves, but provides less lift. It planes to a limited extent.

Some planing boats have a **V bow** (front) to cut the waves, and a flat

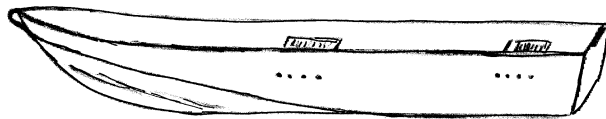

bottom in the **stern** (back) for lift. This is a common compromise.

A **V** bow is helpful when the ice is running. The V bow parts the ice, going to one side or the other of the ice pack. A flat bottom boat constantly climbs on the ice pack. The passengers have to get out and push the boat off the ice.

#### *Downriver or Big Lakes*

People who travel in big lakes or big rivers usually have boats with a **V** bow because the wind causes big waves in open places. A flat bow pounds on big waves, loosening rivets or nails, giving a very uncomfortable ride.

Lake and downriver boats usually have much higher sides than upriver boats where there are smaller waves. Downriver boats usually have a high transom (back end) and use long shaft motors. These adaptations keep the large waves out of the boat.

#### **Standards**

A 6, 15  
B 3  
C 3  
D 1, 2, 3

#### **Concepts**

$F = MA$   
Inertia  
Friction  
Surface area

### *Upriver or on Smaller Lakes*

People who boat in smaller lakes and narrower rivers prefer boats that are flat on the bottom from front to back. This kind of planing boat skims on top of the water especially in shallow conditions.

Boats designed for small lakes and rivers usually have lower sides, low transom and short shaft motors.

High sides:

- Are often a hindrance to getting in and out of the boat.
- Add weight which is critical in shallow water.
- Cause the boat to blow around a lot in a side wind, making steering difficult.

### *Disadvantages of Planing Boats*

The disadvantages of planing boats are significant.

They need a motor big enough to go fast enough to get on step. If the load is too heavy, a planing boat is like a raft, slow very hard to push. Big motors use more gas per hour and cost more to buy and repair. On step, they are economical.

There is a sharp breaking point where a planing boat will either be on step or plowing water trying to get on step. Sometimes fifty pounds makes the difference between planing at thirty mph or plowing at twelve mph.

We used to figure the gas consumption of a motor at full throttle by dividing the horsepower by ten. A forty horsepower would use four gallons an hour. A twenty horsepower used two gallons an hour. Modern motors do better than that. Perhaps dividing the horsepower by twelve would be a more accurate estimate of gallons per hour. The new four-cycle outboards are even more efficient, perhaps dividing horsepower by fifteen to get gas consumption per hour. Fuel prices are so high now, fuel economy is an important aspect of buying an outboard motor.

Planing boats are terribly difficult to pole up shallow creeks. The wide stern seems to drag all the water in the creek behind it. There is a lake behind our village. In the creek to the lake, there is a shallow section we call "divorce country" because many husbands and wives get in big arguments trying to pole their planing boats through there. Oldtimers easily poled their planing boats through to the lake.

## **Displacement Boats**

A displacement boat has gentle, gradual lines that cut through the water. It has a smooth shape to push the water out of the way as gradually as possible. A sailboat is an excellent example. A displacement boat cannot go as fast as a planing boat, but it can carry a much bigger load with a small motor.

Oldtimers built and used displacement boats hauling hundreds of pounds with three to five horsepower motors. Canoes, kayaks, and umiaks are also displacement boats. Before motors arrived in Alaska, people poled wooden boats up the river. Often they lined up, pulling the displacement boats by



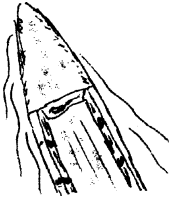

Gradual turns of a displacement boat cut the water



Blunt bow plows water

ropes. They cleared the banks of brush for long sections of river in order to do this. I have had to line up several times to get home after breaking down.

My wife's family used to build displacement boats thirty-two feet long, three and one-half feet wide with a very narrow stern. They hauled all their winter fuel and food up a very swift river, using only five to fifteen horsepower motors. They were slow but hauled an enormous load.

### *Envisioning the Difference*

Picture this in your mind: Pat the surface of water with your hand. Gradually do this faster and faster. The faster you do this, the more resistant the water seems. The slower you do this, the less resistant the water seems.

A planing boat travels on the water so fast the water resists downward motion, keeping the boat on the surface.

The displacement boat is designed to push the water out of the way slowly so the water is less resistant. It cuts the water

If you put a big motor on a displacement boat, it will go somewhat faster, but not as fast as you might think. At low speeds the resistance of the water is minimal. If you have a displacement boat, you need a small motor and a lot of patience.

The oldtimers had a lot of time, but not much money. Nowadays we have more money, and limited time. If hard times come to Alaska again, I will immediately switch to a displacement boat with a small motor.

Actually, each family needs two boats, one planing boat to make quick trips with light loads, and a displacement boat to haul loads, fish, hunt, and go logging.

### *The Same Thing Said Another Way*

As a planing boat travels quickly over the water, the **momentum** of the water and its viscosity keeps the water from moving out of the way quickly. The boat travels on top of the water. A planing boat interacts with the water so suddenly the inertia of the water gives the boat lift.

As a displacement boat travels **through** the water, the momentum of the water will greatly resist the forward motion of the boat unless the curves of the boat are gentle, allowing the water time to move out of the way. A good displacement boat interacts with the water gently, gradually and gracefully.

### *Traditional Craft*

Canoes, kayaks, and umiaks are displacement boats. When the individual is providing the power from his own arms, he can readily tell if the boat is well designed or not.

**Upriver canoes.** If the bottom is perfectly straight, the canoe will hold a straight course across a lake, but will be hard to turn in a creek. Usually we put a little "rocker" in the bottom, perhaps one inch in a fourteen- to sixteen-foot canoe.

If the canoe is too wide, it is hard to paddle or pole. However, the more narrow it is, the tipper it is. Far upriver in swift current, people preferred to

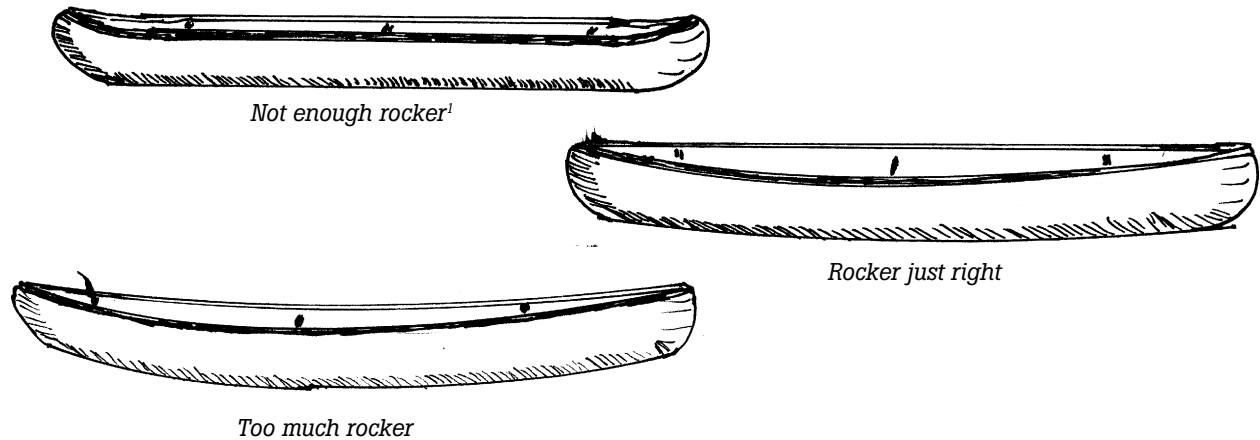

Front



Back

pole the canoes with a small pole in each hand. It is easier to pole against the solid bottom than to paddle against flowing water.

A round bottom canoe is easier to paddle, but is very tippy. People skilled in handling canoes preferred round bottom canoes, but the rest of us are better off with flatter-bottom craft.

Years ago, people hunted from canoes. Many Native-built canoes were very narrow. There are many funny stories about people shooting a shotgun sideways out of a canoe. Shooting over the bow pushed the canoe backward. Shooting sideways flipped the canoe over!

Poling boats were wide in the front and narrow in the back, allowing the one poling to steer in any direction.

### Sides

Boat builders have to decide at what angle to lean the sides out. If the sides are too straight, the boat is strong like angle iron, but resists turning. When a load is added, the boat sinks down considerably.

The best angle is determined after the conditions are identified and the length of the boat decided upon.

If the sides lean out too much, the boat will turn easily, and will haul a load well. The boat, in effect, gets wider and wider as the load is applied. However, the boat will not have much strength in waves. It will tend to bend and twist, breaking up in a few years from the stress.

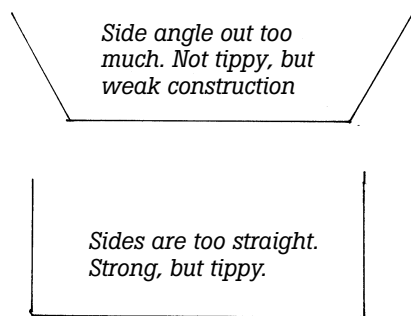

### Resistance

Both planing and displacement boats come in contact with the water. The rougher the surface is, the greater the resistance is. The resistance between

1. Some boats have a perfectly straight bottom. Rocker refers to a slight bend downward. Sometimes people put one inch or so of rocker in some boats.

the boat and the water is an example of friction. This friction can cost many gallons of gas over a boating season. Any energy spent in overcoming unnecessary friction is wasted energy.

There are several ways to reduce friction.

A wooden boat can be sanded and painted. Oldtimers used to dry the boat and blowtorch the “hair” that develops on the bottom and sides of a wooden boat. Aluminum boats can be lightly sanded.

Painting a boat, whether aluminum or wooden, reduces friction.

There are different types of paint. Marine paints are very expensive because they contain copper compounds that prevent barnacles and marine growth. In locations where this isn't a problem, a considerable amount of money can be saved by using paint that doesn't contain toxic copper compounds.

Now, village people use epoxy resin and fiberglass finishes over wood. These provide protection for the wood, and greatly reduce friction with the water. Years ago, spruce pitch was used as a sealant. It also smoothed out rough surfaces.

## Materials

There are five common materials for boat building, each with its advantages and disadvantages.

### *Lumber*

Lumber boats are inexpensive and strong, especially if the builder has cut and seasoned his own lumber. They are repairable by the builder too. Unfortunately, they require considerable maintenance including painting and caulking. They often leak. They are heavy. Knots occasionally fall out, leaving big holes. Eventually they rot, even if they have been carefully maintained. Wooden boats have been in Alaska since the whipsaw made lumber possible.

### *Plywood*

Plywood boats replaced lumber boats for a while before aluminum boats arrived. Plywood has the same qualities of a lumber boat except they tend to leak far less if properly caulked. Without modern glues and caulking, plywood boats are not practical.

Some people build boats using AC plywood. While the glue is the same as in marine plywood, the quality of the core of the plywood is poor. Marine plywood is smooth on both sides and has a core made of high quality wood. It is very expensive. When I build a boat that is something of an experiment, I use AC plywood because it is cheaper. My new design might not be worth the expense of better material. When I am sure of the design, I use high quality marine plywood.

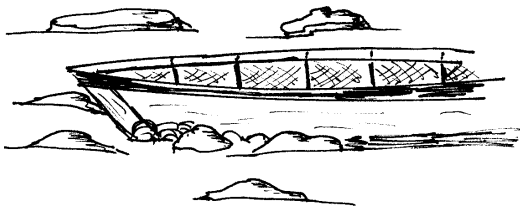

Both plywood and lumber boats are easily destroyed when run in the ice.

### *Aluminum*

Aluminum is an excellent material for boats. It doesn't rust or rot. It is light and doesn't absorb water or leak. It is unharmed when run in ice, and is easy to drag over ice flows. Aluminum boats can last a lifetime if handled carefully.

Unfortunately, with aluminum, the owner can't design his own boat for his own purposes unless he has a custom boat made at considerable expense. Aluminum is a bit noisy for hunting. This is particularly noticeable with aluminum canoes. Aluminum is very difficult or impossible for an owner to repair properly. Welding aluminum has long been an obstacle for the common person. Some aluminum boats have leaky rivets that plague the owner.

With hard use, aluminum boats crack in the transom, on the ribs, and in the bow where the boat contacts the beach.

### *Fiberglass*

Fiberglass boats are fairly new to Alaska, at least where I am from. Fiberglass is unharmed by running in the ice and slides well over ice flows. It provides a low friction surface with the water. Fiberglass is strong, and low maintenance, but does add considerable weight to a boat. Fiberglass is easy to repair and is easy to apply if the simple directions are followed. Fiberglass bonds well with new lumber and plywood, but usually separates when applied to an old painted boat, even if it is sanded well.

There is one brand of fiberglass boat built in the Lower 48 that can haul an awesome load. The low friction surface of fiberglass combined with the wide bottom providing lift give this boat a very respectable performance. Freight costs on fiberglass boats purchased from Outside are high.

### *Skin boats*

Although no longer common in many parts of Alaska, skinboats are still the whaler's choice in Barrow and the Arctic. Skins are very strong and flexible. They don't get ice buildup in cold temperatures and are repairable by the owner. Other than labor, they are free. The disadvantages are:

- Animals, including your own dogs, want to eat your boat. To store it out of the reach of animals often exposes the boat to drying wind and sunlight.
- The skins require frequent oiling.
- The skins deteriorate within a few years.
- Skin boats are labor-intensive to build. However, this often brings people of a village together.

Brief mention should be given to inflatable boats. They aren't practical for village people, but they do fit in airplanes and can be inflated at remote locations. Many can be driven by outboard motors.

Even less mention will be made of the hideously noisy airboats that plague some of Alaska's rivers.





## Activities

1. Look at the different boats in the village. Identify the planing boats and displacement boats. Some fishing boats are a compromise between the two.
2. What is the average length and width of the boats in your village? What is the average height of the sides in the middle of the boat? What is the average angle outward of the sides, in both the middle and back? What is the average angle backward of the transom?
3. Ask a local boat builder what happens if the transom doesn't have enough angle.
4. What are the different materials used in boat construction in your village?
5. How does the style of boat in your village compare with those in the description in the above text? Are they downriver boats, upriver boats, ocean boats, a combination, or something different?
6. Talk with a local boat builder about boat design. Does he agree or disagree with some of the thoughts in the above text?
7. Look at a canoe if one is available. Are the turns and curves gradual? Compare this with a planing boat. Which would you rather paddle or pole upstream?
8. Ask the oldtimers about shooting out of a canoe. What precautions must be taken?
9. Try poling a planing boat upstream in swift water. Paddle or pole a canoe in the same place. Compare the effort.
10. Compare the bottoms of the boats in your village. Feel them if you can. How rough or smooth are they? If they are rough, how did they get that way? How would you reduce the friction on each one? Do boats in your area need paints with copper compounds to prevent organic growth?
11. Students should slap the surface of a small body of water with their hand, a board, or paddle. Increase the speed with which it is slapped. Notice that it seems to become "solid" the faster it is slapped. How does this apply to a planing boat.
12. Carve a displacement or planing boat from soap or cottonwood bark.
13. Ask oldtimers how they hauled big loads long ago. How is that different from today?
14. Draw an upriver boat. Draw a downriver boat. Which do you prefer?
15. Ask oldtimers how they built canoes or kayaks. What are the effects of changing width? Length? Did they put a rocker in the bottom? How

high were the sides? What were the problems they had with materials? Today we weld and use synthetic caulking. How did they fix leaks long ago?

16. Ask around the village to find out the gas consumption of the new four-cycle outboards. How many gallons per hour for each horsepower rating? Divide the horsepower by the gallons to find the ratio. Compare this with the gas consumption of newer two-cycle motors.
17. Compare the difference in purchase price of a two-cycle and a four-cycle outboard. The four-cycles are more expensive. What is the price of gas in your community? Can you figure how many gallons of gas a four-cycle would have to burn to pay for the difference in purchase price? This isn't a simple problem. You will probably have to do it as a class, but it is one everyone must take into account when buying a motor.
18. Ask in your village how much the boats cost. Compare the cost of the different kinds of boats with each other. Ask people how long each kind of boat lasts (plywood, fiberglass, aluminum, etc.). In the long run, what is the cheapest kind of boat? Is it also the most useful kind of boat? Do people still make their own boats? Why?

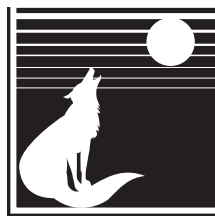

## STUDENT Response

1. What are the two different kinds of boats?
2. Which of these two is better for carrying a big load with a small motor?
3. Which of these two kinds of boats is better for running around with a light load?
4. What is the most important thing to remember in designing a displacement boat?
5. A planing boat is better when it is wide or slim?
6. Which planing boat will get on step faster, one with a flat bottom or one with a **V** bottom?
7. Which planing boat will give a smoother ride in rough water, one with a flat bottom or one with a **V** bottom?
8. Which is better for your location? Why?
9. What are the advantages of high sides on a boat? What are the disadvantages?
10. What is the force called that slows a boat with a rough bottom? How is this remedied with a wooden boat?

11. There are four common materials used in boat construction. List them and one advantage of each.

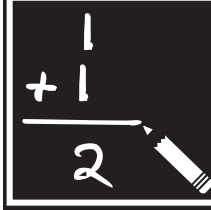

## Math

1. One boat travels 20 miles upstream in a swift river where the average current is 10 mph. The boat's speed relative to the water is 20 mph. The boat makes a round trip. Another identical boat and motor travels 40 miles on a lake where there is no current. There is no wind acting on either boat. Question: Do they both make the trip in the same time, or is there a difference? If there is a difference, why?
2. Plywood costs \$35 a sheet landed in the village. Screws to build a boat are \$4.50 a pound. Paint is \$22.5 a gallon. The lumber to build the ribs and other parts is \$1.25 a board foot. Five gallons of fiberglass resin flown into the village is \$89. The fiberglass cloth is \$3.00 a linear foot. How much would it cost to build a boat 24' long? The boat is 4' wide and will take six sheets of plywood. It will require 4 pounds of screws and three and a half gallons of paint (only available in gallons.) Add 10% for incidental expenses like calking, glue, paint brushes etc. An aluminum boat is \$3,200 landed in the village. Which is cheaper? Considering that an aluminum boat lasts twice as long, which is cheaper?





## Chapter 17

# Magneto & Spark Plugs

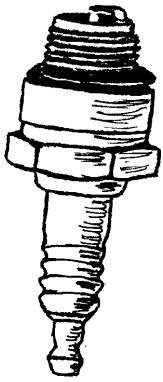

Almost everyone in Alaska has been stuck one time or another because of “bad plugs.” Spark plugs are so important that airplanes have two spark plugs in each cylinder, each fed by a different magneto.

Every engine that is fueled by gasoline has spark plugs, whether it is a four wheeler, a chainsaw, or an old-time gasoline washing machine. In a diesel engine the compression is so great that heat generated by compression ignites the fuel.

Healthy spark plugs can make the difference between riding home or walking, boating home or drifting.

### How Spark Plugs Work

The simple explanation is:

- The magneto generates electric current in the primary coil.
- The secondary coil increases the voltage<sup>1</sup> of that current.
- The spark plug sparks, igniting the fuel.
- The fuel burns.
- The gasses expand, driving the piston.
- Work is done.

### *Generating Electricity in the Magneto*

If a powerful magnet is passed by many wires, a current is produced. There is a permanent magnet on the spinning flywheel. When it spins past the primary coil of wire, a current is generated which passes down the wire under pressure towards the spark plug in the cylinder. The energy of motion is changed to electrical energy.

### *Secondary Coil*

Unfortunately, at this point, even though there are enough electrons traveling down the wire, they are not at high enough voltage to cause the spark plug to spark.

1. Voltage is like pressure that is behind electricity as it travels through a wire. High voltage is like high pressure. Low voltage is like low pressure.

#### **Standards**

A 6, 9, 15  
B 3  
D 1, 3

#### **Concepts**

Forms of  
energy  
Surface area

The electrons from the magneto pass through the secondary coil. The result is that fewer electrons come out of the secondary coil but they come out with more **voltage** (pressure). These electrons arrive at the spark plug just in time to ignite the fuel and air mixture. The voltage going into the secondary coil might be as low as 50 volts coming out as high as 15,000 volts,

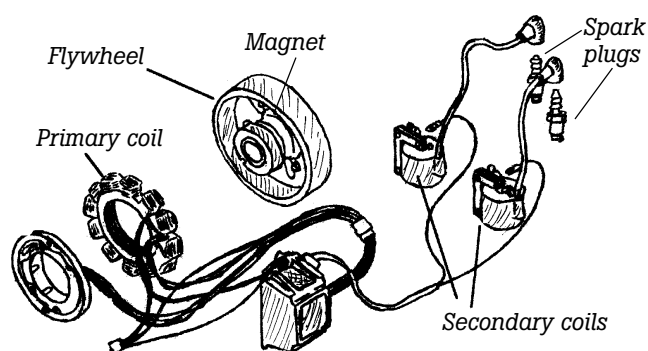

### *The Spark Ignites Fuel and air Mixture*

In the cylinder, the piston has just come to the top of its stroke. All of the air and gasoline droplets have been compressed very close together to burn more efficiently.

Zap! The spark plug sparks. The first droplets of gasoline are ignited by the heat of the spark. They ignite the ones next to them, and in a chain reaction, they ignite the ones next to them. The expanding gasses that result from the ignition of the gasoline forcefully drive the piston downward.

*Ignition Too Early.* If the spark plug ignites the fuel before the piston gets to the top of the stroke, the piston will be forced backwards causing great stress on the engine.

*Perfect Timing.* In reality, the spark plug ignites the fuel a few degrees before TDC (top dead center). It takes a fraction of a second to ignite the fuel. In that very brief time, the piston is at TDC and very efficient ignition takes place, burning the fuel thoroughly all the way down the cylinder.

*Ignition Too Late.* If the spark plug ignites the fuel after the piston is at the top, combustion will be late and all the fuel will not burn before the piston gets to the bottom. The unburned fuel will be pushed out of the cylinder.

Different fuels (marine gas, aviation gas, 100/130) burn at different rates. This is why timing must be changed when fuel is changed. Some fuels require more advance spark than others. It is like the difference between pistol and rifle powder in firearms. Some powders burn faster than others.

## High Voltage

It is important to understand why high voltage is necessary for the spark plug. Air is not a good conductor of electricity. In the atmosphere, a spark of 12,000 volts can jump a gap of .025". Under pressure, like in a cylinder, it is harder for the spark to jump the gap. The pressure inside the cylinder of a two-cycle engine, like a chainsaw, outboard, and simple snowmachine, is about seven times greater than our atmosphere.

A spark plug that can spark in the open air may not be sparking at all in

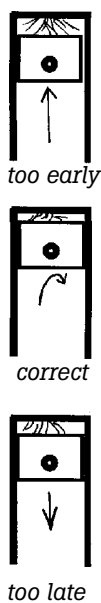

the cylinder. It took me three days to learn this as I cranked and cranked on a motorcycle.

The strength of the spark is revealed in the color. A red or yellow spark is weak and probably will not spark in the cylinder. A blue or white spark is strong and has enough voltage to fight across the spark plug gap even under pressure within the cylinder.

## Reasons for Spark Plugs Not Igniting Fuel

There are two main reasons that a spark plug will not fire well if the voltage is present for a good spark.

- The gap is not set properly.
- There is carbon on the plug, shorting it out.

### The Gap



Gap too big



Gap too small

If the gap on the spark plug is too close, there isn't enough spark exposed to the fuel/air mixture. The result will be a slow rate of burn. This doesn't sound important, but when there are 100 ignitions a second, time is important.

If the gap on the spark plug is too big, the voltage may not be strong enough to force the spark across the large gap. The resistance is too great.

When the gap in the plug is correct, the strongest possible spark is exposed to the largest surface of fuel/air mixture.

Carbon buildup

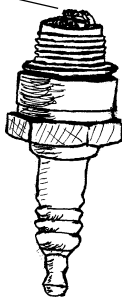

### Carbon on the plug

Carbon is formed when fuel isn't completely burned. Carbon is a good conductor of electricity. The brushes on electric motors are made of carbon because it conducts electricity well.

If there is carbon on the side of the center post in the spark plug it will take the easiest path, traveling through the carbon, not sparking across the gap as we desire.

Electrons flow down the carbon on the porcelain

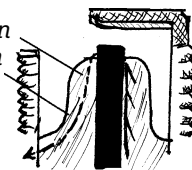

## Troubleshooting

When an engine will not start, spark plugs often tell the story.

- If the plugs are a golden brown, they have been burning well at the proper temperature.
- If the plugs are damp with gas, the fuel is present, but was not ignited. Possible spark problems.
- If the plugs are dry, there is no fuel to ignite, indicating fuel problems.
- If the plugs are black, there are several possible reasons:
  - The fuel mixture is too rich, or
  - The spark is too weak to cause complete combustion.
  - The wrong kind of two-cycle oil could be causing the problem.

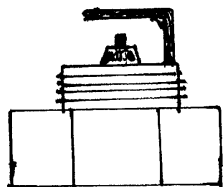

*Dirty spark plug*



When snowmachines first became popular in the late sixties and early seventies, we had terrible problems because we used out-board motor oil. It didn't burn completely in the colder winter temperatures.

- Too much oil in the fuel mixture (two-cycle engines). Some engines call for a 20:1 mixture, others 50:1, and yet others 100:1. While too much oil will cause carbon problems in the engine, not enough oil will destroy it! It is far better to err by putting too much oil.
- The plugs are too "cold" for the engine. Hotter plugs are hotter during operation. Colder plugs are colder during operation. If a plug is black, perhaps the engine needs a hotter plug that will retain more heat to burn off the carbon. If a plug is scorched white, it requires a colder plug. This is very important with air-cooled engines. We run snowmachines in temperature differences of over 80°. The machine's ability to retain and get rid of heat is drastically changed during those conditions.
- If the plug is not retaining enough heat, it will carbon. If it is retaining too much heat, the cylinder could get too hot and burn a hole in the piston. It might be necessary to use colder plugs in warm weather, and a hotter plug in colder weather.

If the plugs have white spots on them, it could indicate water in the fuel.

If a plug is black with carbon and won't fire, it can be heated red hot in a Coleman or propane stove to burn the carbon off. This will make the plug usable for a short time. Some people sandblast plugs to remove carbon. This does get the carbon off, but leaves a rough surface quickly collect more carbon.

What could weaken the voltage to the spark plug?

- Dirty or worn magneto coil
- Improper distance between the magnet on the flywheel and the magneto coil
- Broken or dirty wire connections
  - from the magneto to secondary coil,
  - from the secondary coil to the spark plug, or
  - from the coil to the ground.
- Secondary coil shorting out inside.
- Dirty or cracked spark plug.

All gasoline engines use spark plugs. The system that generates the spark is very simple and uses simple electrical principles. A little attention and understanding will prevent or solve a lifetime of mechanical problems.



## Activities

1. Collect as many different kinds of spark plugs as you can find in the village. How many different kinds do you find? How many different companies are represented by the plugs? What differences do you notice among them? How many different kinds of engines do these plugs represent?
2. Compare the length of the plugs, the length exposed within the cylinder, the length of the threads, and the diameters. Why do you think there are such differences? Can you find some plugs that are golden brown, some black, and some that burned too hot? (You may not, as the golden and white ones might be still in machines.)
3. What are the differences in the identification numbers of hot and cold plugs from the same manufacturer? If you can't tell by looking, a manual will tell the difference.
4. Find old flywheels. Test the magnets for strength. Are they strong or weak magnets?
5. Get an old and a new spark plug of the same kind. Put the plug wire of an engine (chainsaw is easiest) on each plug. Hold the base of the plug against the cylinder of the engine, and crank the engine over. Do you see a difference in the color of spark in the new and old plug? (It is hard to see the spark in a bright location.)
6. Find a plug that will not fire in the above manner because of carbon and dirt. Carefully clean the center post with a hairpin, or other slim object. Can you clean it well enough to give a hot blue or white spark?
7. Close the gap on an old plug, and test it against the cylinder. Did the color of the spark change when the gap was made smaller?
8. Look up the recommended spark plug gap for three or four different engines. The recommended gap should be in the manual for the machine. Pick some high and some low compression engines. Why do you think there are some differences in the recommended gaps?
9. Find out about sandblasting spark plugs. Ask how long a sandblasted plug will stay clean and why.
10. Put the end of a fouled spark plug in the flame of a propane or Coleman stove until it turns red hot. Carefully let it cool. Test the spark before and after this. What difference do you see in the spark? Why do you think this is so?
11. Find a coil that people say is bad. Is there anything visible to indicate that it doesn't work well?
12. On a working engine, pull the wire that goes from the magneto to the coil. While holding the wire, ground your hand against the cylinder and pull the starter rope. Put that wire back and pull the wire from the

spark plug. Put a screwdriver handle up the spark plug cap and again ground your hand against the cylinder. Pull the starter rope again. Do it slowly! Can you feel the difference in voltage? (You should!) This will be uncomfortable, but shouldn't hurt unless you pull very fast.

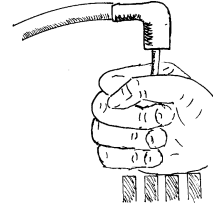

13. Ask around the village to see if anyone knows the difference between a generator and an alternator. What is the difference?
14. Draw a cylinder whose timing is too advanced. Draw one whose timing is too slow. Look in an owner's manual of a four-cycle engine and find how many degrees before top dead center (BTDC) the timing should be set.



## STUDENT Response

1. Make a simple drawing of the parts of the spark system of an outboard motor from magneto to spark plug.
2. Where is the electricity generated in an engine?
3. Where is the voltage increased?
4. What does the spark plug do in an engine?
5. Draw and label three cylinders, one firing too soon, one firing too late, and another firing at the proper time.
6. Explain why a spark might jump the gap in open air, and not in the cylinder.
7. What colors indicate the hottest sparks?
8. What colors indicate the weakest sparks?
9. What two things could keep a spark plug from firing well?
10. List five things that could make the spark plug black with carbon?
11. Draw a picture showing how a dirty plug allows the spark to ground out, not jumping the gap.
12. What kind of plug should be used in an air-cooled engine during cold weather? Why?
13. Why would an outboard be able to use one type of plug all the time, and a snowmachine need different plugs in different seasons?
14. List five things that could cause the voltage to a spark plug to be weak.

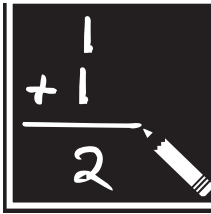

## Math

1. The voltage generated by a magneto is 50 volts. The coil increases this to 15,000 volts. If the magneto is fixed so that it now generates 75 volts. How many volts will the coil produce?





## Chapter 18

# Carburetors

Engines need fuel to burn, but also need proper amounts of oxygen to burn the fuel. Carburetors mix air and fuel in the proper amounts to ensure efficient combustion in the engine.

Only in outboard motor operation does the speed remain fairly constant. In chainsaws, four-wheel ATVs, and snowmachines, the engine speed is constantly changing.

Mixing fuel and air properly at all rpms is a challenge.

### Improper Mixture

#### *Too Much Fuel*

If there is too much fuel (too rich), combustion will not be complete, power will diminish, and carbon will quickly build up in the cylinder.

#### *Not Enough Fuel*

If an engine doesn't get enough fuel (too lean), it will lose power, fade under load, and overheat. Proper mixture at all speeds is important. A lean engine, running too hot, is self destructing as parts warp, wear, and break.

We must also remember that a two-cycle engine mixes the oil and fuel. An engine that is lean on fuel is also lean on oil. If it is lean on oil, friction does its irreversible damage.

### Parts of a Carburetor

#### **Standards**

A 2, 15  
B 3  
D 1, 3

There are seven important parts of a carburetor.

- Air cleaner
- Choke
- Carburetor throat and jets
- Throttle butterfly
- Needle valves
- Float or other regulating system
- Throttle cable

#### **Concepts**

Bernoulli's  
principle  
Evaporation  
Surface area

#### *Air Cleaner*

The air cleaner is an important part of the carburetor system, especially in chainsaws where there is so much sawdust in the air. If sawdust or dirt are

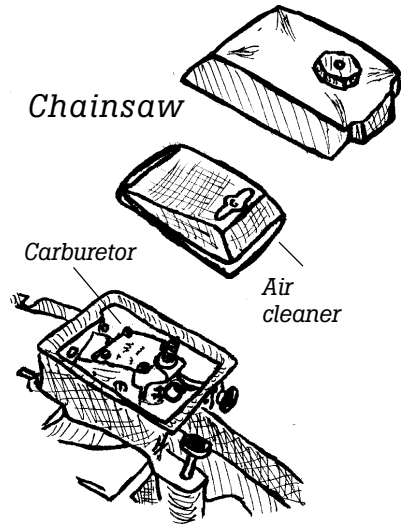

Chainsaw

Carburetor

Air cleaner

drawn into the carburetor, the carburetor plugs up and sawdust quickly wears and destroys the engine.

If the air cleaner is covered with dirt, the air supply is reduced and more fuel is drawn into the cylinder. The engine runs far too rich. An outboard isn't operated in dusty conditions. Four-wheel ATVs and chainsaws need frequent attention. The air cleaner on a snowmachine can be covered with snow or frost.

*Throat of the Carburetor*

The throat of the carburetor is nothing more than a narrowed tube. When air passes through the narrow part, the air must speed up.

Bernoulli's principle says that as a liquid or gas speed up, the pressure is reduced. Because the velocity of the air in the carburetor throat is increased, the pressure is reduced.

As the fast flowing air passes quickly over the high and low speed jets, fuel is pushed through the jets into the low pressure air stream from the bowl below. By the time the fuel is in the cylinder, it has been thoroughly mixed with the air (oxygen).

*Carburetor throat*

*Air flow speeds up—  
pressure is reduced*

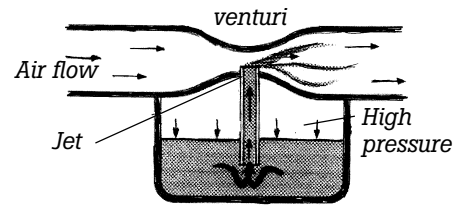

*Atmospheric pressure pushes gas up through the jet*

Throttle butterfly

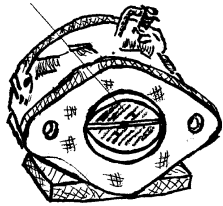

*Throttle Butterfly*

The throttle butterfly is connected to the throttle cable. As the throttle cable is pulled, the butterfly opens and closes, controlling the airflow. The amount of air and speed of the air flowing over the jets is changed.

*Needle valves*

As an engine needs more fuel at higher speeds, there are actually two jets, one for low speed and one for high speed. The low speed jet feeds fuel into the air stream at low speeds. At higher speeds, they do both.

There is a screw that adjusts the amount of gas available to the jet. It is called the "needle valve" because the end of it is thin like a needle. Small adjustments of the screw allows precise amounts of fuel to pass the needle valve and go to the jet.

needle valve



Years ago, both the high and low speed needle valves were adjustable. Now, except on chainsaws, only the low speed needle valve can be adjusted.

When an engine runs lean, the first thing people do is tinker with the needle valves. The main cause of fuel starvation is dirty fuel in the carburetor or a clogged fuel filter. Once an engine is tuned, it seldom needs needle valve

adjustment except for extreme temperature differences. Most engines with two needle valves can be roughly adjusted by gently closing both needle valves, and opening  $\frac{3}{4}$  to 1 complete turn. The low speed valve is adjusted first, then the high speed.

### Choke

A cold engine needs more fuel than a hot engine. The remedy for this is the choke. The choke reduces the area the airflow passes through. As with the throttle, the velocity of the air increases, and more fuel is pushed into the throat of the carburetor. When the engine is running and warm, the choke is no longer needed.

### Float or Other Regulating System

Although carburetors are different in some aspects, the principles they operate by are the same. There are basically two kinds of shut-off systems:

1. Those with a float shut off. They operate in an upright position only. Snowmachines, four-wheel ATVs, outboards use carburetors with a float that controls the amount of gasoline available to the carburetor. When the bowl is full of gas, the float rises and shuts off the fuel intake to the carburetor. When the amount of fuel in the bowl drops, the float also drops, allowing more fuel to come into the carburetor.
2. Those that can be operated in any direction (omnidirectional). These are found in chainsaws, although many of the early snowmachines had them. Air pressure and crankcase pressure open and close small valves and chambers that allow the saw to get the proper amount of fuel at any throttle setting in any position. If a chainsaw had a float, it couldn't be turned upside down and continue running.

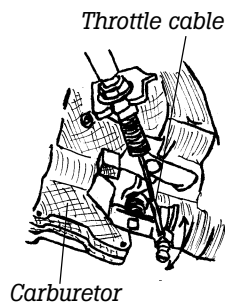
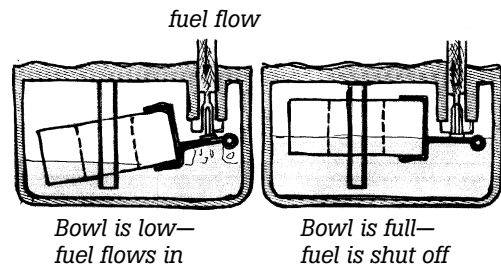

### Throttle cable

The throttle cable is a stiff wire that slides within a covering. This attaches the throttle to the carburetor, so the operator is constantly in control of the speed of the engine.

### Surface Area of Fuel

It is important that there is great surface area for the fuel to burn. Burning can only take place on the surface of fuel.

If you split a dry block of wood into many small pieces, it will burn much faster

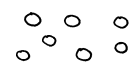

Big drops—  
low surface  
area



Small drops—  
high surface  
area

than if it is burned in one whole piece. Liquid fuel, like gasoline, will burn quicker if it has more surface area. If a stream of gasoline is injected into the cylinder, it burns much slower than the same amount of gasoline that has been sprayed into a mist.

### Oil Injection

Like snowmachines, newer outboard motors have oil injectors that mix the fuel and oil. The ideal oil/gas mix is different at high and low rpm's. The oil injection varies the amount of oil at different speeds.

### Icing

Heat is required to turn a liquid into a vapor. Assume the carburetor, fuel, and air are at fifty degrees. The fuel is vaporized in the carburetor. It takes heat to evaporate a liquid to a vapor. The heat comes from the carburetor walls. As this process continues, the carburetor actually gets ten to fifteen degrees colder than the outside air. The carburetor cools the air passing through the carburetor throat.

Fuel vaporizes  
requiring heat

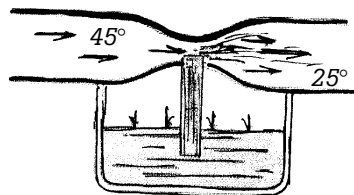

As warm air holds more moisture than cooler air, the air, now cooled in the carburetor, releases its moisture. It can actually form ice in a carburetor when the outside temperature is forty to sixty degrees!

This is why airplane engines have a "carb heat" control to inject warm air, melting any ice formed in the carburetor.



### ACTIVITIES

1. Find an old carburetor from any machine that utilizes a float. Identify the parts. Identify how the float controls the amount of gas in the bowl. Is there an artificial rubber seal to shut off the flow of fuel? Take the needle valves out. Draw the shape of the tip. Don't touch the tip with a file, but touch the side of the needle valve. Is it hard or soft? Can you find a screen in the fuel line within the carburetor? What do you think would happen if this became plugged?
2. Look at the air cleaner on several chainsaws. Can you see how the air flow might be slowed down by a dirty air cleaner? How does the owner's manual say to clean it?
3. Look in the owner's manual of a chainsaw. What is the standard setting for the needle valves? (If no chainsaw is available, try to find another engine that has a carb with a high and low speed needle valves.)
4. Take the bar and chain off a chainsaw. Replace the clutch cover (for safety reasons). Remove the cover from the carburetor. Start the engine. Find the idle set screw. Adjust it when the engine is idling. What happens?

5. Set the high-speed needle valve too rich and then speed the engine up. Can you hear the sound when it is getting too much gas? Now shut the high-speed needle valve down. Speed the engine again. Can you hear the weak sound it makes? These two sounds will help you tune engines in the future. Remember them.
6. We usually set the needle valve halfway between the points where we can hear the lean weak sounds and the rich sounds. Then we open the needle valve  $\frac{1}{4}$  turn. This insures that the engine isn't too lean. Why do you think there are springs on the needle valves if they aren't moving parts?
7. While the chainsaw is running without a bar and chain, remove the air cleaner. Pull the choke lever. Can you see the choke butterfly? Why do you think choking a warm engine kills it?
8. While the chainsaw is running, pull the throttle. Look in the carburetor. Can you see the throttle butterfly moving?
9. Put a little gasoline in your hand, and blow on it. Does it feel hot or cold? Why? Can you understand carb icing now?
10. The next time you are in a small plane, ask the pilot to show you the carb heat knob. Ask him why the engine loses a little power when it is applied. Does this explain why pilots don't run with carb heat all the time?
11. Cut two identical blocks of wood. Split one into four parts, and the other into kindling. Make two separate campfires and burn them at the same time. Which one burns faster? Explain to someone else why fuel is sprayed into the carburetor in a fine mist.
12. Ask people in the village about the carburetors that came with the first snowmachines. Are the ones available now better?



## STUDENT Response

1. A carburetor mixes what and what?
2. What happens if there is too much fuel? Not enough fuel?
3. Why is a carburetor that isn't getting enough gas particularly harmful in a two-cycle engine?
4. Draw a carburetor and identify the parts.
5. What is the purpose of the air cleaner and what happens when it is dirty?
6. Describe Bernoulli's principle in your own words.
7. What does the throttle do?

8. What do the needle valves do?
9. What does the choke do?
10. What does the float do?
11. Why is it important to increase the surface area of fuel?
12. What is carb icing?

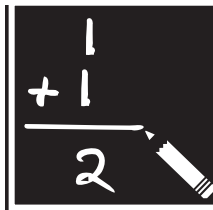

## Math

1. A carburetor is set too rich. It uses 7% more gas than it should. The operator spends \$127 on gas in one month. How much could he save by tuning his carburetor?  $1.07x = 127$
2. The pressure in an airplane carburetor throat is 12.9 psi. Atmospheric pressure is 14.7 psi. What is the difference in pressure? The plane climbs; the atmospheric pressure is now 14.2 psi. What is the pressure difference now?

## Chapter 19

# Compression

There are some fairly simple, yet important events that take place in an engine. One of these is the compression of the fuel/air mixture.

### Why Compression is Necessary

There are three things required for burning to take place:

- Heat
- Fuel
- Air (specifically oxygen)

If any of these are reduced or removed, the fire will slow down or go out.

### Example

Picture a campfire burning strongly. Air is flowing freely to the flame. There is enough fuel (wood) to burn. The heat from the fire keeps itself going. Each piece of wood, as it burns, warms itself and the wood nearby.

Someone stumbles by the fire, and kicks the wood, scattering it. The fire starts to go out.

There is still oxygen. The amount of fuel available is adequate but the fuel is too far apart for the burning pieces to continue to **heat** each other. Each stick of wood is not heating its neighbor as well as it did when they were close together in the center. If the wood is pushed to the center again, the fire resumes its strong flame.

### The Example Applied

The same principle is applied in a cylinder. The air (oxygen) and fuel (gasoline) are well mixed in the carburetor. They enter the cylinder, but fuel particles and oxygen are far apart. When the piston comes up in the cylinder, the air molecules and fuel particles are forced close together. When one or two droplets are ignited by the spark plug, the chain reaction is set off. Com-

#### Standards

A 1, 8a, 15  
B 3  
D 1, 3

#### Concepts

Surface area  
Forms of energy



Wood close



Wood scattered

Compressing

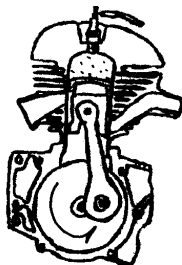

bustion is thorough and quick. When a gas is compressed, as in a cylinder, heat is generated as the molecules collide much more in tighter space. This gets the fuel/air mixture close to the burning point even before the spark ignites them.

## Piston Rings

Every engine has a piston that compresses the fuel and air. Every piston has rings that **seal** around the sides of the piston preventing gasses from escaping. Some pistons have two rings, others three. Piston rings are made of very hard steel that slide up and down in the cylinder walls. They have a greater potential for friction wear than any other engine part.

Compressed

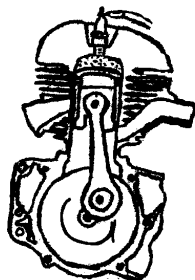

Piston rings

## Lubrication

In a two-cycle engine where the gas and oil are mixed, the oil in the gas ensures the lubrication of the upper cylinder walls.

In a four-cycle engine, lubrication of cylinder walls is from oil splashed by the crankshaft churning in the oil pan.

In a diesel engine, there is splash lubrication of the cylinder walls by oil in the crankcase, but diesel fuel is, by nature, more of a lubricant than gasoline. The fuel itself helps in lubricating the upper cylinder walls.

In the late 60s I worked at Red Devil mine. The boss told me to fuel up the diesel tractor. It had two engines: a gasoline engine that started the big diesel engine. It had two fuel tanks. Through ignorance, I put gasoline in the diesel tank and almost got fired. As it was, my mistake was discovered soon enough, but I contaminated fifty-five gallons of fuel by mixing gasoline and diesel fuel in the same tank. Gasoline would have burned in the diesel engine, but it would have destroyed it through friction on the cylinder walls. The old rust bucket tractor had no labels on the tanks anyway.

When piston rings wear, the result is compression loss that results in great power loss. The rings are a very important part of an engine. They are also the first to be damaged if there is improper lubrication.

## Heat Retention

It is important for the cylinder walls to be hot enough to promote combustion, but cool enough that they don't melt or warp the metal. This is why the cooling system in all engines is so important.

## Heat

Heat in a material is the sum total of all the kinetic energy of all the molecules. When we say something is "hot" we are actually saying that there are frequent collisions of the atoms and molecules as they vibrate in a mate-



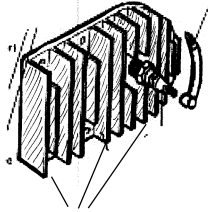

The fins provide a lot of surface area from which heat can be lost

rial. When we say that something is “cold” we are really saying that the collisions decreased and the molecules have slowed down.

When we increase the pressure of a gas, we are increasing the temperature. The molecules are closer together and must collide more. Some of the kinetic energy of the piston is converted to heat energy.

### Gasoline Engines and Spark Plugs

Standard atmospheric pressure is 14.7 psi. If the compression ratio is 8:1, the pressure in the cylinder is  $8 \times 14.7$  psi or 117.6 psi. At a ratio of 10:1 the pressure in the cylinder is  $10 \times 14.7$  psi or 147 psi. Under that pressure, the temperature is raised considerably.

### Diesel Engines

Diesel engines have no spark plugs to ignite the fuel. In the cylinder, the pressure is so great the temperature is very high. The pressure is so great (16:1 or 234 psi) that the temperature becomes high enough to ignite the fuel without a spark plug.

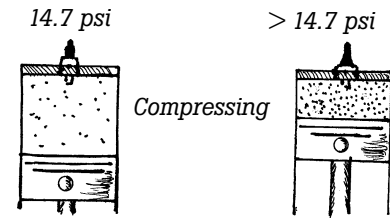

### Conclusion

Compression brings fuel particles together in an engine, heating them, and giving them the opportunity to burn more rapidly. The principle of compression is easy to understand, but is worth mentioning as there is considerable power loss and inefficiency resulting from decreased compression from bad piston rings or head gasket leakage.



## Activities

1. Get an old piston that still has rings. How many rings does this piston have? Compress the rings. Can you see how they would seal the piston in the cylinder? Is the groove in the piston a tight fit for the rings? Is there a post in the groove that keeps the piston ring from turning around in the groove? Why do you think this is so?
2. Ask some of the local mechanics why cylinders are honed before installing new rings. Ask them to demonstrate how to get the piston and rings in a cylinder. What caution must be exercised?
3. File a old piston ring. Is it hard or soft? File the piston. Is it hard or soft?
4. Pull the spark plug from an engine (like a chainsaw). Put your finger over the spark plug hole, and pull the starter rope. Can you feel the compression? If you can get a compression tester, test the pressure in the cylinder. Some compression gauges give pressure but don't indi-

- cate the ratio. If a cylinder has 105.8 psi, what is the compression ratio?
5. Make a campfire with good dry wood. Push the sticks close together. Pull them apart. Does the fire burn faster if the wood is closer?
  6. Draw a piston in a cylinder at the bottom of the stroke and the top of the stroke. Measure the volume in each position. What is the compression ratio? Now draw a piston in a cylinder that has a high compression ratio.
  7. Get a hand pump and pump a bicycle tire. Is it hot? Where does the heat come from?
  8. If you can get a simple compression tester, test the compression in a snowmachine, outboard, four wheeler, and chainsaw. What is the difference between them?
  9. Some engines have a head gasket and others do not. Ask a local person who does mechanics which local machines do and which don't. How can he tell if the head gasket is damaged? Where is it most often damaged? Can you use any gasket material for a head gasket? Why?
  10. Talk to the local power plant operator about the compression in a diesel engine. How does the fuel get into the engine if the pressure is so great? Does a diesel engine have a carburetor? Why?
  11. Research how compression is achieved in a jet turbine engine.

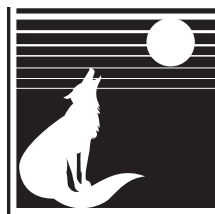

## STUDENT Response

1. What three things are necessary for something to burn?
2. If a campfire is burning too slowly, what can you do to make it burn faster besides adding more wood?
3. Why is compression necessary?
4. What is the purpose of piston rings?
5. Draw a cylinder where the fuel is not compressed.
6. Draw a cylinder with the fuel compressed.
7. What is the approximate compression ratio of a gasoline engine?
8. What does psi mean?
9. What can cause compression loss?

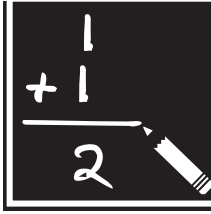

## Math

1. If the compression ratio is 9:1 and atmospheric pressure is 14.7 psi, how many psi is there in the cylinder when the piston is at the top of the cylinder?
2. If the compression ratio is 16:1 in a diesel engine, what is the pressure in psi?
3. The compression ratio in a chainsaw is supposed to be 7:1, but the rings are bad and there is a 15% compression loss. What is the psi in the cylinder?
4. The compression in a diesel engine is 17:1. How much pressure must the fuel pump generate if the fuel is injected when compression is at its greatest? Greater than \_\_\_\_\_.



## Chapter 20

# Outboard Motor Lower Unit

Those of us who have piloted Alaska's waters with an outboard have learned the importance of having a good lower unit. All the power of the motor<sup>1</sup> is sent to the lower unit. Great forces work through the lower unit. When it works well, all goes well. When it is damaged, everything comes to a halt. Some people have jet units to drive their boats, but they have cost, weight and maintenance problems that keep them out of the reach of most village people. The simple outboard with a lower unit will be around for many years to come.

Lower units are expensive to repair or replace. For those reasons alone, it is important to understand them.

### Gears

The engine turns the drive shaft, but the drive shaft isn't spinning in the same direction as the prop.

How then is the direction of the shaft's rotation changed? The pinion gear on the end of the drive shaft drives both the forward and reverse gears **at the same time**. All three gears turn together.

#### Pinion Gears

The pinion gear is smaller, with less teeth. It turns  $2\frac{1}{2}$  times for every revolution of the forward and reverse gears. The prop and prop shaft are therefore turning slower, but with more power (torque) than the engine. The engine has

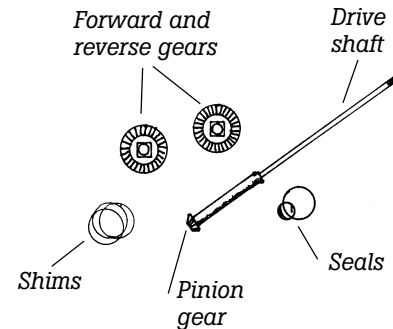
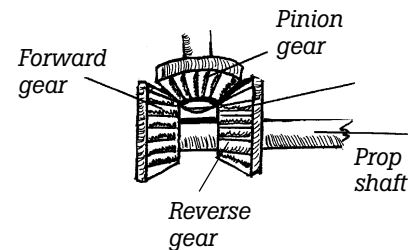

#### Standards

A 15  
B 3  
D 1, 3

#### Concepts

Friction  
Mechanical  
advantage  
Leverage  
Inertia  
Mass

<sup>1</sup> While we call them outboard motors, they are really engines. Electric motors are motors, and piston driven engines are different. However, here we will use the commonly used term outboard *motor* in order to be understood.

a mechanical advantage of 2.5 to 1 over the prop.

### Shifting

How can the forward and reverse gears turn at the same time? Inside the forward and reverse gears is the prop shaft which has four large "dogs". When the shift lever is moved, the dogs connect with either the forward or reverse gears. Only one of them can engage the drive shaft at a time. The dogs are strong. If the forward and reverse gears were always engaging and disengaging with the pinion gear, they would break off in a moment.

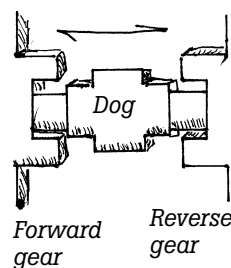

Even though the dogs are thick and made of tough metal, they can be chipped if shifted when the engine is running fast. When this happens, pieces of metal flow through the lower unit grease, causing other chips and bearing wear. Avoid chipping the shift dogs by slowing the engine to the lowest rpm before shifting.

Rap the lower unit on the edge of a table

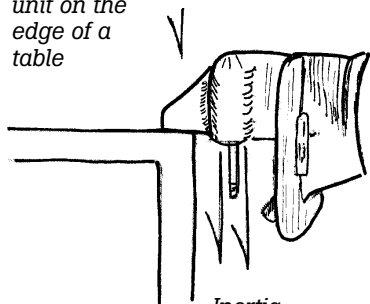

Inertia drives the gears out

### Disassembly

Taking a lower unit apart isn't hard. Describing the process is hard. With the prop off, look around the prop shaft and see a ring that is screwed into the housing. Often there is a locktab to keep it from unscrewing by itself. With the locktab removed, the ring can be unscrewed. See a local expert if you need help in this. With the ring removed, turn the lower unit with the prop shaft down. Holding a hand over the prop shaft so parts don't fall on the floor, rap the whole lower unit on a bench or block of wood, hitting on the skeg. Inertia quickly drives the gears, seals, and other parts into the waiting hand. Science in action!

### Grease

Without lower unit grease, friction would destroy the gears and bearings in the lower unit within minutes. If the grease is too thick, it can't get into the small places and prevent the metal from wearing. If the grease is too thin, it doesn't protect the metal parts from grinding each other. Lower unit grease is specifically designed to work well even if there is a little water in the lower unit.

An oldtimer had no lower unit grease, so he put wheel bearing grease in his lower unit. All the gears and bearings were spoiled within two hours.

It is good to change lower unit grease often, as the little metal chips that break off can continue to cause great damage. Fresh grease prevents unnecessary wear.

The transmission in a helicopter has a magnet to pick up small pieces of metal that float about before they damage the unit. Newer outboards have a similar magnet on the drain plug to pick up chips and filings. Many

snowmachine chain cases have a magnet on the end of the dipstick to pick up loose particles that would cause excessive wear.

### Changing Grease

There are two holes through which the grease is injected into the lower unit. Drain the old grease out of the bottom hole. Fill the lower unit from the bottom until the grease comes out the top hole. If it is filled from the top after inserting the bottom screw, there are many air bubbles. It never would fill completely.

### Seals

Around the prop shaft and around the drive shaft there is constant motion. Seals keep the water out and the grease in.

The seals must be snug against the moving shafts. Good, healthy, soft seals help to keep the grease in and water out. Since water is not a lubricant, friction in a greaseless environment will destroy the lower unit in minutes.

### Shafts

There are two shafts in a lower unit.

- The drive shaft
- The prop shaft

The drive shaft runs from the bottom of the crankshaft to the lower unit.

The prop shafts bend when impacted with the bottom is great enough. Once the shaft is bent, the shaft and prop vibrate because the prop is not turning in a perfect circle. If this continues, seals wear out from the vibration and water enters the lower unit. The bearings wear excessively from vibration. To tell if the prop shaft is bent or not, roll it on a table. If so, it wobble as it rolls.

If vibration is allowed to continue, replacing the bent shaft with a straight one will still allow in some vibration because the bearings will be worn.

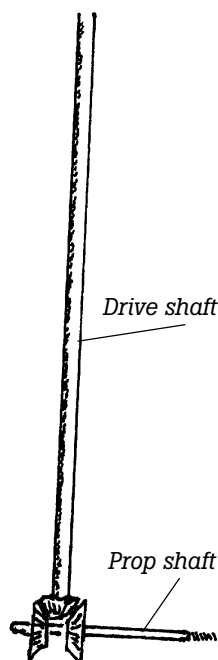

### Cavitation

If the lower unit is **not deep enough** in the water the prop “catches air”, or more accurately, “cavitates”. The prop spins in the water, not giving much thrust at all.

If the lower unit is **too deep** in the water, it will hit the bottom too easily and will present more drag than is necessary.

The height of the back of a boat is critical. A quarter of an inch can make a difference. One time while traveling in the ice I took seven hours when another boat made the trip in three hours. My motor was cavitating when chunks of ice were trapped between the boat and lower unit; his was not.

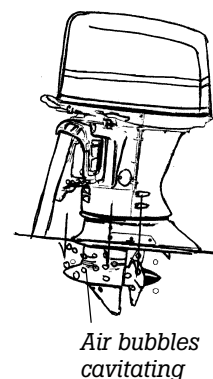

Why does this happen? Behind the moving prop is a high pressure area created by the prop pushing water backwards. In front of the prop there is a

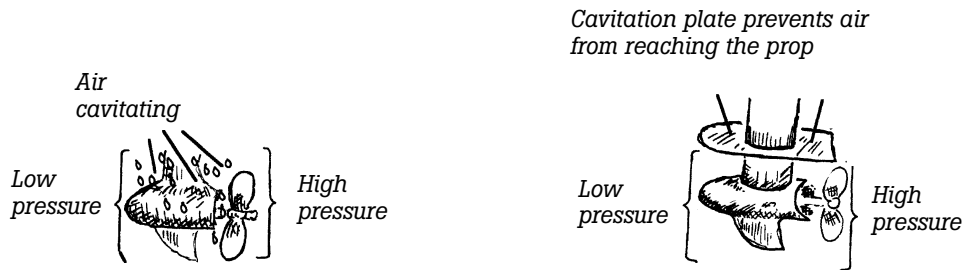

low pressure area as the water is being drawn away by the prop. If the pressure in front of the prop gets below 14.7 psi, the pressure of the atmosphere pushes air from the surface of the water to the prop. The prop spins in a pocket of air, and lose its thrust. The flat plate above the prop is designed to keep the air from doing just that. It is called the "anti-cavitation plate." Without it the motor catches air, or cavitates, greatly frustrating the pilot.

Even with the anti-cavitation plate, cavitation occurs in fall-time when floating leaves and grass stick on the front of the lower unit, breaking the smooth flow of water. The water pressure in front of the prop is drastically reduced. The air is then driven by atmospheric pressure around the anti-cavitation plate, causing the prop to spin in a pocket of air.

### Housing Shape

The lower unit has to be big enough to hold the gears, and small enough to present the least resistance possible. If the gears are too small, they break easily. If they are too big, pushing the oversized lower unit through the water takes energy away from the forward motion of the boat.

The front of the lower unit allows water to flow smoothly to the prop intake for the water pump.

The skeg on an outboard protects the prop from impact. If it were shorter, it would expose the prop to obstacles in the water. If it were longer, it would hit the bottom. If it were thinner, it would easily break off. If it were thicker, it would cause too much drag. The angle of the skeg deflects the lower unit from rocks and logs.

Smooth design allows water to flow easily

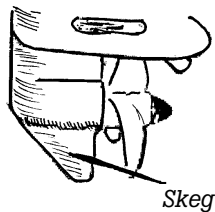

### Trim Tab

The prop spins in one direction causing the motor pull to one side, making steering tiring. On most motors, particularly the big ones, there is a little fin that hangs down behind the prop to counteract that pulling while the boat is in motion. By turning the fin to one side or the other, the twisting of the motor is offset.

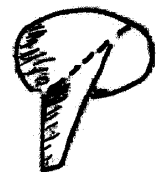



Interestingly enough, this fin is made of zinc. When outboards are in salt water, there is a great chance of a chemical reaction, like a battery, “eating” one metal on the motor. The fin is made of a zinc that **sacrifices** itself. It is “eaten” before the other more valuable motor parts. It might need to be replaced at some time if the motor is in salt water, but it is cheap and easy to replace.

## Props

Props come in different sizes and pitches. The size of the motor determines the diameter of the prop. The size and load on the boat determine the pitch.

On each prop there are two numbers. For example:  $10 \times 11$  or  $10 \times 13$ .

The first number is the **diameter** of the prop. A smaller motor will usually have a smaller diameter prop.

The second number tells how far the prop would move forward in one revolution if there were no slippage in the water. This is the pitch.

A  $10 \times 11$  prop is a work prop. It will go forward eleven inches in one revolution. It will push a heavy load. However, the engine turns too fast if there is no load in the boat.

A  $10 \times 13$  prop is more of a speed prop. It will go forward thirteen inches in one revolution. It will cause a light boat to go fast, but it will work the engine too hard if there is a big load.

Most pilots have extra props to account for the different load conditions under which the boat might operate.

### *Balancing the Load and Prop*

The load determines the engine’s speed.

If the load is too large, the rpm is too low and there is great stress on the motor.

If the load is too light, the rpm is too high, and the motor will self destruct from the inertia of the piston as it goes up and down.

Long ago, pistons were made of steel, but their great mass kept engine rpm under 2,000.

Pistons are now made from aluminum because aluminum is light. Modern engines turn 5,000 to 12,000 rpm.

If the prop doesn’t have enough pitch, the engine will turn too fast.

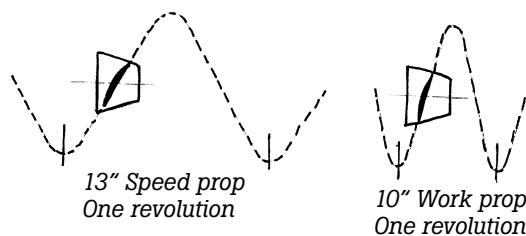
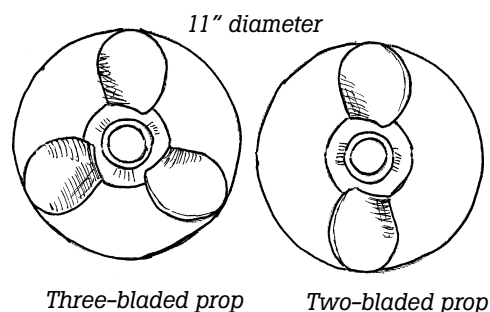

If the prop is has too much pitch, the engine will turn too slow.

Balancing the prop to the load and controlling the engine's speed is critical for the life of the engine.

*A Problem Overcome*

Older motors had **shear pins**.

When a prop hits bottom or an obstacle, the force of impact is great. Action equals reaction. There is a great action driven by the engine, and a great reaction when the prop hits bottom.

If there were no shear pin, the prop would be damaged and the pinion gear might break on impact. Designers put a metal pin through the prop shaft that was weaker than the gears. This pin was the only connection between the prop and the shaft.

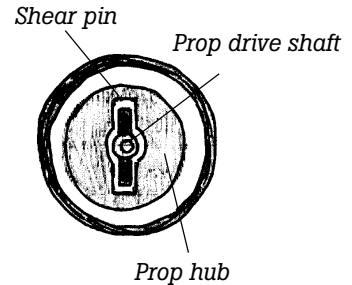

On impact, the shear pin broke and was inexpensive to change. However, when it broke in rough or dangerous water, which it often did, there was furious paddling to safety.

*New Solution*

Manufacturers tried different innovations and came up with the **slip prop**. A look at the end view of a prop shows the blades, the hub, an artificial rubber ring, and the inside bushing that has splines and slips over the prop shaft. When the prop hits the bottom, the prop shaft can still spin in the middle while the blades slip on the artificial rubber ring.

*Artificial rubber ring allows slipping*

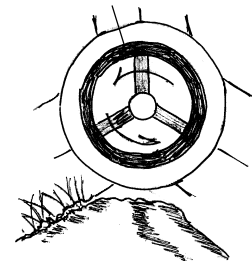

*Problem*

The slip prop supposedly saves the gears from breaking and the prop from being severely damaged. However, when the prop is new, the ring is stiff, and too much stress is communicated to the gears. When the prop is old, the rubber slips too easily, even when the motor is accelerating. It would be nice to have a way to adjust the tension on the rubber ring to fit the boating conditions, but manufacturers haven't gotten that far yet.

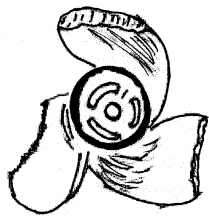

Once the prop has hit bottom several times, it bends and chips. If the prop is out of balance, it will vibrate, damaging the bearings and seals. It is possible to shape the prop again by tapping it with a hammer on a solid surface. It can also be filed, however, it is important to file the front of the prop, giving a flat surface in the back to push against the water.

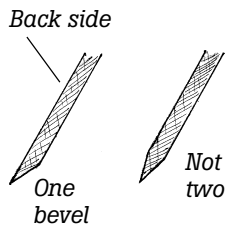

*Materials*

One time I bought a brass prop. I thought it might be better. Wrong! Brass props are okay in salt water, but their mass is so great small chips result in severe vibration. The inertia of a heavy brass prop is much greater than a

light aluminum one. The vibration was so great from the brass prop, it snapped my prop shaft in a very short time.

Many people are using stainless steel props, as they are tougher, and last longer. However, the owner of a prop shop recently told me that aluminum props are cheaper in the long run. Aluminum easily deforms. Stainless steel is much tougher, but the damage is transmitted to the gears, which are far more expensive and difficult to change. It is better to change aluminum props than lower unit gears.

## Conclusion

Most outboard motor problems that we have faced in our part of Alaska are lower unit problems. We travel shallow rocky rivers and lower units give out long before the upper units wear. Understanding them and treating them carefully helps lengthen their life, saving money and long trips poling, paddling, or drifting home.



## Activities

1. Find a complete lower unit. Identify the parts, prop shaft, drive shaft, anti-cavitation plate, skeg, water intake, and engine exhaust.
2. Look at the motors in the village, new ones and old ones. In what ways are they similar? In what ways are they different? Trace the changes in outboards through time. Ask oldtimers about inboard engines. How were they better? How are outboards better?
3. Compare the lower units made today and those of years ago. Ask the oldtimers about the advantages of the shear pin type lower units. Is there one in a cache somewhere? Why did the outboard manufacturers change from shear pins to slip props?
4. What kind of metal do you think the gears are made of? Try to file them. Are they hard or soft? Try to file the drive and prop shafts. Are they hard or soft?
5. Feel the seals. Are they soft? Are they worn? What holds the seals tight against the shaft?
6. Find the intake for the water pump. Why do you think the holes aren't bigger?
7. On a complete lower unit, turn the prop as if the boat were going forward. One side of the prop has low pressure coming from the top; the other side has low pressure coming from the bottom. Identify each. If the prop were to cavitate, which side will it cavitate on?
8. Look at a prop shaft with the gears attached. Explain to someone else how the motor shifts from forward to neutral to reverse. Try to draw

this so someone else can understand by your picture.

9. Change grease in a lower unit. Make sure the bolts are tight once you are done. Did you see the new grease pushing some old grease out of the upper hole? Did bubbles come out too? Are you confident that the lower unit is full of grease? Was there any water in the lower unit when you first drained it?
10. Stir a clean magnet in the grease that has just been drained from a lower unit. Are there any metal chips? (Cover the magnet with thin plastic wrap before doing this to facilitate cleaning.) Rub some of this grease between your fingers. Rub some new grease between your fingers. Can you feel a difference in friction? In thickness (ability to keep metal parts from touching each other)?
11. Tap an old drive shaft with another piece of metal. Does it ring, indicating high carbon steel? How was it attached to the end of the crankshaft so it wouldn't spin? Ask someone what these are called.
12. Roll an old prop shaft on the table. Look closely. Does it wobble, indicating that it is bent? What do you think happened to the seals if the shaft was bent?
13. Try paddling a boat with the motor up, out of the water, and then lower the motor. Paddle again. Note the resistance of the lower unit. Can you now see why design and size are so important? Imagine the resistance at high speeds.
14. Imagine that the prop has just hit a big rock. What parts absorb the stress and shock?
15. Where does the exhaust leave the engine? Why doesn't it exhaust into the air?
16. Check five to ten props in the village. What is the average pitch? Are these mostly working boats or speed boats? Do you see any relationship between the prop diameter and the horsepower?
17. Does anyone in your location have a jet boat? Talk with them about the advantages and disadvantages of jet units. Why don't more people have a jet unit?

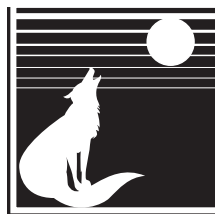

## STUDENT Response

1. What gear is at the end of the driveshaft that turns both the forward and reverse gears?
2. Why is lower unit grease important?
3. Should you fill the lower unit with grease from the bottom or the top hole?

4. What do seals do?
5. Why are the thin shims important in a lower unit? Explain or draw.
6. What are the two shafts that turn in a lower unit?
7. Draw a picture of cavitation.
8. What does the skeg do?
9. What does the trim tab do that is behind the prop?
10. A prop is marked  $11 \times 13$ . What do each of these two numbers mean?
11. One prop is marked  $13 \times 13$  the other is  $11 \times 13$ . Which is the speed prop? Which is the work prop?
12. Why is it important to balance the load and the rpm?
13. Describe or draw a prop that has a shear pin.
14. Describe or draw a slip prop from the rear view.
15. What happens when a prop gets out of balance?

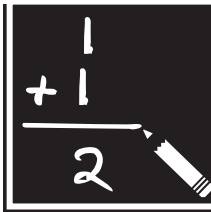

## Math

1. Consider that an outboard usually turns 5,500 rpm. How many revolutions per second is this? Can you even imagine something moving up and down that fast? How many times a minute can you clap your hands? How many times faster is a piston? (Time and count yourself for a minute.)
2. Find some old forward, pinion, and reverse gears in the village. Count the teeth on each. How many are there on the pinion gear? On the forward gear? If the forward gear turns one time, how many times has the pinion gear turned?
3. Using the information you discovered from the above question, if the engine is turning 5,000 rpm, how many rpm is the prop turning?
4. The pinion gear in my motor turns  $2 \frac{1}{2}$  times for every turn of the forward gear. The engine is turning 5,000 rpm. How fast in rpm is the prop turning?
5. Find the cost of a new outboard motor. Find the cost of a new lower unit for the same motor. What percentage of the cost of the whole motor is the lower unit? (A 30-horsepower Mariner costs \$3,200 and a whole new lower unit costs \$1,356. Use this example if you can't find your own figures.)
6. Pat has to buy parts for his lower unit. Pinion gear \$32, forward gear \$45, seals \$5.75, reverse gear \$45, new prop shaft \$37, new prop \$127, and grease \$3.75. How much did it cost him to hit the rock?

7. A new stainless steel prop is \$250. An aluminum prop is only \$105. The stainless prop lasts two times longer than the aluminum. Which is more economical?
8. A speed prop supposedly goes forward 13" for every revolution, but in reality it only goes 6.5". What percentage of efficiency is this?
9. Frank can get a second hand lower unit for \$675 or a new one for \$1,172. The used one will last two seasons and the new one will last four. Which is more economical?
10. Aluminum props used to cost \$15 each in 1972. Now they are \$120. What percent increase does this represent?

## Chapter 21

# An Outboard Cooling System

As gasoline is burned in an outboard motor, the temperature quickly rises in and around the piston and cylinder. The chemical energy of the fuel is changed to the energy of motion of the piston, as well as heat and sound. If the heat were not carried away, it would soon warp and melt engine parts. The engine may run again, and seem all right for a while, but the damage is never reversed. Engines don't heal like people, plants, and animals.

Airplanes, chainsaws, and most snowmachines rely on air flow to carry the heat away.

Outboard motors can efficiently use water for cooling. Water has greater mass and is a better conductor of heat than air.

Automobiles, trucks, and high-tech snowmachines are also water-cooled.

The water comes into the outboard's engine through the lower unit, which is below water level as the boat is moving. Without a pump of some kind, water couldn't flow up to the engine. The water pump is the heart of the cooling system.

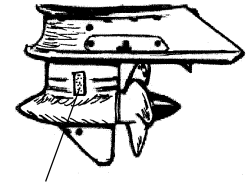

Water intake

### Main Parts

There are three main parts to the pump:

- Bottom plate
- Impeller
- Housing

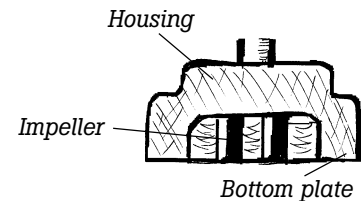

### Operation

If the impeller were exactly in the center of the housing, it would turn with the drive shaft, spinning water within the housing, but it would not pump water.

However, it is designed with an offset impeller. When the impeller turns, it has a lot of room on one side of the pump, and not much room on the other.

### Standards

A 15  
B 3  
D 1, 3

### Concepts

Mass  
Forms of  
energy  
Friction

As the drive shaft and impeller spin, water enters on the side that has a lot of room, and is pressured out on the side that doesn't have much room.

While this seems very simple, it is the basis upon which many other kinds of pumps work, particularly fuel pumps.

*Low pressure.  
Water is drawn  
into pump*

*Offset Impeller*

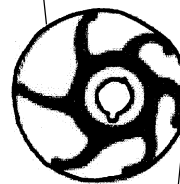

*High pressure. Water  
is forced from pump  
to engine*

## Screen

A screen protects the opening to the water pump on the lower unit. It keeps grass, sticks, and small stones from plugging the cooling system, and destroying the engine.

## Thermostat

When an engine is cold, it doesn't run well at all. Ignition requires three things: fuel, oxygen, and heat. If any of these is lacking, combustion will not occur efficiently. The thermostat prevents the cooling water from getting to the cylinder walls until there is enough heat for efficient combustion. Once the cylinder temperature is up, the thermostat allows the cooling water to flow from the water pump through the water jacket and out the exhaust. If a small stone gets jammed in the thermostat, it can be stuck closed which causes the engine to overheat, or it can be stuck open, making warmup very difficult.

If a motor overheats from cooling system failure, quickly remove the spark plugs and pour oil into the cylinder to keep the piston rings from ceasing up in the cylinder. Gently pull the starter rope to keep parts moving.

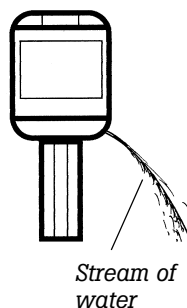

## Indicator

On the side of most motors there is a small hole that emits a stream of water. This is only an indicator that the water pump is working. Most of the water that comes from the cylinders is exhausted through the lower unit. During cold weather, the indicator might freeze even though the pump is working well.

## Considerations

Many of Alaska's rivers are silty. Friction with the silty water wears the impeller and housing much quicker than clear water. Some water pump housings are lined with very durable chromium steel. Others are made of soft aluminum. Aluminum wears quickly and the jagged pieces of the worn housing cut the impeller to pieces.

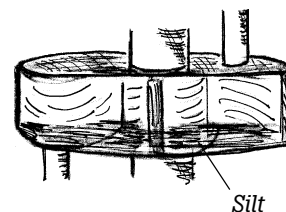



When the motor is stopped and left in an upright position, silt in the water settles to the bottom of the water pump. When the engine is started again the impeller is severely worn by the silt. To prevent this, good pilots tilt their motor up after stopping. This drains the water pump.

A good pilot doesn't do this when the temperatures are freezing. The motor is left down with the pump below the water line to keep it from freezing and cracking. Fortunately the silty rivers become clear once freezing temperatures cause the water level to drop. The hazard of silt in the pump no longer exists. It is important, however, to pull the starter rope very slowly before starting the engine in cold weather. To pull on the starter rope quickly when the water pump is frozen could strip the connection between the impeller and the driveshaft, ruining the impeller and stranding the pilot.

When a water pump freezes, pour hot water on the lower unit housing until it is thawed. Usually one teapot of boiling water is enough to free it. Some people pour a little gas in a coffee can, throw in a match, and hold the burning gasoline under the lower unit with pliers. Gasoline is very dangerous and this method is not recommended.

Inexperienced pilots often hit bottom, running their motors in the mud trying to get to deeper water. Even if there isn't gravel to damage the prop, the water pump draws tremendous amounts of silt, wearing the impeller and housing.

## Common Problems

The most common problems with water pumps are:

- Worn impellers
- Worn housings
- Bottom plates that are worn rough and thin by silt

An oldtimer made a scoop from a metal can and bolted it in place of the intake screen on the lower unit. He removed the worn impeller in the pump. Forward motion of the boat forced water into the scoop up through the upper unit. As long as he ran full throttle in forward he had enough water to cool the engine. It was a good temporary solution.

Some people bail water on their engines to cool them until they get home. This cools the outer jacket of the engine, but doesn't cool the cylinder walls well at all. The operator might get home, but not without internal damage to the engine.

An extra impeller and housing are not too expensive to have as spare parts in a tool box as they are so important to an engine's operation.

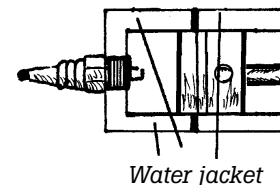
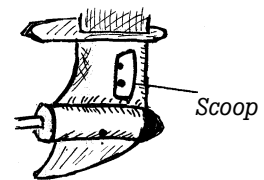



## ACTIVITIES

1. Take a water pump apart. Identify the three main parts. What causes the impeller to turn as the shaft turns?
2. Touch the bottom plate of the water pump with a file. Is it harder or softer than the file? Why do you think this is so?
3. There are two types of metal that water pumps are made of. Find examples of each. Why do you think there is a difference?
4. Put an impeller in a pump housing. With a stick in place of the drive shaft, turn the impeller. Watch the impeller blades extend and compress. Imagine the water coming in the side where the blades are extending and leaving the side where it is compressing.
5. Find the intake for the water on the lower unit. Is there a screen of any kind? Why do you think the screen is there? Ask people in the village what it is for and what would happen if it were missing.
6. Check the copper tubing that carries the water from the pump to the upper unit. Are there seals where it connects to each?
7. Can you find the thermostat? They are in different places on different motors. If possible, remove it. Alternately, pour hot and cold water on it. Can you see it move in response to the temperature difference?
8. If you live near a silty river, collect some water and let it settle overnight. Is there sediment on the bottom of the container? Pour most of the water off and rub your hand on the bottom of the container. Can you see why silt will wear the impeller inside the pump housing?



## STUDENT RESPONSE

1. What would happen to an outboard if water didn't circulate around the cylinders? Is this change permanent?
2. What are the three parts of a water pump?
3. With a drawing of the top view, show how a water pump works.
4. What is the purpose of the screen on the lower unit?
5. What is the purpose of a thermostat? How can it malfunction?
6. What does the indicator do? If it is plugged, does that mean the water pump isn't working?
7. Why should an outboard motor be tilted up when not in use? During what season is this not so?

8. A water pump doesn't work. The operator improvises a way to get home. What are the consequences if the improvised water cooling system doesn't work?

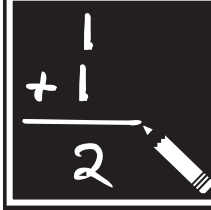

## Math

1. A cheap aluminum impeller housing costs \$12. An expensive stainless steel one costs \$37. However, a housing made from stainless steel lasts 4 times longer. Which is cheaper in the long run?



## Chapter 22

# Dog Sleds

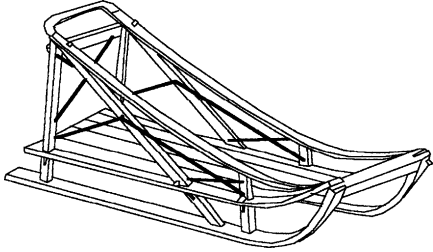

If a great computer tried to develop a better dogsled than the ones oldtimers made, it would fail. Dogsleds are an engineering masterpiece. New materials have opened up new possibilities, but the factors involved are the same.

Dogs are available as an energy source in other parts of the world, but aren't used because more powerful animals are available, like horses, donkeys, and oxen. Since those animals aren't practical in the arctic, dogs were the best source of power until the advent of the snowmachine. Each dog can get himself from point **A** to point **B**, but pulling a load greatly reduces the distance that each dog can go. Sled design and dog mushing has to be a science to maximize the limited energy available from a team of dogs.

Dog mushing is a constant study in energy conservation.

Snowmachines seem to have power to waste, but the same scientific principles that apply to dog sled design also apply to snowmachine sleds.

## Energy Considerations

The dogs are pulling against several forces.

- **Friction** of the runners against the surface of the snow.
- **Lifting** the sled and load up banks and hills, although every round trip, or trip from sea level to sea level averages out to level ground.
- **Inertia** of the load as the sled accelerates and decelerates with the uneven surface of the snow.
- To keep the sled on the trail.
- A very small amount of **wind resistance**.

### Standards

A 6, 15  
B 3  
C 3  
D 1, 3

### Concepts

A = R  
Inertia  
Leverage  
Surface area  
Friction  
Forms of energy

## Runners and Friction

High friction runners tire the dogs very rapidly. Of course, the bigger the load is, the higher the friction will be.

## Before Plastic

Before plastic we used hard steel runners in warm weather and wooden runners in cold weather.

Steel runners were very good for spring travel, swimming creeks and

crossing thawed lakes, but came to a halt on bare tundra. Megafriction! In the spring we traveled for miles and miles on tundra, trying to avoid bare ground, going from patches of snow to glaciated creeks back to patches of snow. The difference in friction between snow and tundra is tremendous!

Steel runners were also very high friction in cold weather. They groaned like an old fishwheel. And woe unto the musher in cold weather who didn't avoid fresh dog excrement on the trail. It froze to the steel runners and was the equivalent of setting an anchor.

The hard ironwood runners used in cold weather were imported from the lower 48 then to Alaska. They were fairly low friction in very cold weather once they got a glaze on them. Some people used pine tar to make them run smoother, but it soon wore off.

Lacking ironwood, many oldtimers split a green spruce tree in half, peeled it, and used that for runners. The icy outside of the tree had very low friction with the trail's surface. However, the rounded runners sank a little deeper in the trail than flat ones would. The icy runners also dried out on cold nights, so we had to push the sled into deep fresh snow to protect the runners from drying.

The oldtimers also knew that spruce trees that grow on hillsides have a streak of **hardwood** on the downhill side that forces the tree to grow straight up rather than straight out from the hillside (geotropism). That hardwood is also good for sled runners.

Often we tipped our sled over in the morning and iced the runners with a rag and a can of warm water. There was speculation whether sugar made the icy film more durable. Long ago, urine was used, but it isn't good for hunters and trappers who are trying to minimize the impact of their own presence.

### *Changing Weather*

The above wood runners worked well in cold weather, but woe unto the musher who traveled far with wood runners and the weather turned warm! Wood runners are very high friction in wet snow. Bolts, inset one-half inch, hung down like a dozen thin brakes as the wood wore away in the mild temperatures.

This is a part of the good old days we would just as soon forget. The only solution was to put wood runners over steel runners preparing for all types of weather. This worked, but made the sled heavier. We spent many hours changing runners as the weather changed.

Very long ago, oldtimers used bone for runners. I understand that bone provided low friction, but was very difficult to attach to the sled.

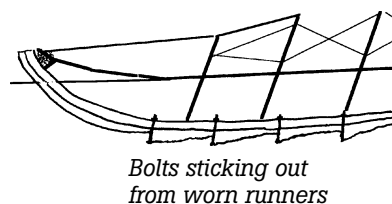
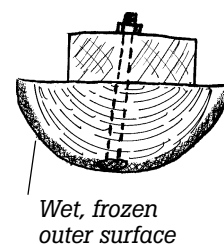
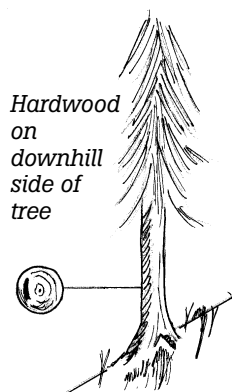

### Modern Materials

Today we have the choice of many plastics. While some are better than others for low friction and durability, plastic has low friction at all temperatures; it is strong, light, and dog excrement doesn't adhere. It is easy to attach<sup>1</sup> and fairly durable.

Exposed mountain rocks destroy a pair of plastic runners quickly as the sharp rocks haven't been smoothed and tumbled like river rocks. If the musher avoids exposed rocks, plastic lasts for a long time.

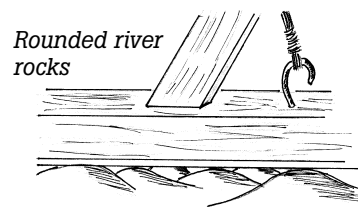
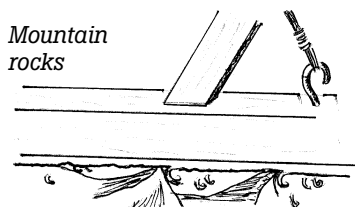

Plastic runners have more friction on the tundra than they do on snow, but they are a hundred times better than steel or wood! We have traveled many miles on bare ground with plastic runners and a considerable load with only a few dogs. Plastic runners are unaffected by water and give considerable strength to the sled's frame as they are flexible and durable.

### Mountain Travel

Traveling in the mountains can be dangerous. It is hard to climb hills and mountains with a dog sled. Dogs get discouraged, and are occasionally injured pulling on the hard-packed, windswept snow.

Going down a mountain pass is another story, particularly if traveling on a sidehill.

There are several techniques to use. The main thing is to:

- Reduce the pulling power of the dogs.
- Increase the friction of the sled as much as possible.

#### Reducing Pulling Power

Dogs are afraid of being run over by the sled on a steep hill or mountain.

- Attach a dogchain between the sled and the wheel dogs. This puts a distance between them and the sled. They don't feel threatened by the sled and pull too hard trying to get away.
  - Unhook the towline from the dogs harness and hook it to their neckline. They can't pull as hard with their collar as they can their harness.
  - Sometimes we turned a few dogs loose if we could trust them not to run away. Minimize power!



Chains between dogs and sled

1. Be certain to put plastic on when it is warm. Plastics expand greatly when heated. If you put runners on cold, they will expand in warm temperatures, creating bulges that fill with snow.

### *Increase Friction*

- To prepare the sled, we wrapped chains loosely, spiraling down the sled runners. This greatly increased the friction.
- On steeper mountains, we wrapped them as shown on the left, in front of the rear stanchion on both sides of the sled. This usually slows the sled enough to make a safe descent.

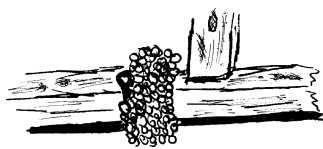

Roughlocked  
chain

You could imagine what would happen if we put the roughlocked chain on the front of the sled. The inertia of the back end of the sled would cause it to pass the front, like jamming the front brake of a bicycle.

The snow on the mountains isn't consistent. There are places where it seems as hard as concrete from the wind, and places where it is soft. It is easy to run over the dogs or tip over and start tumbling.

### *Sidehill*

If the trail involves going down the side of a mountain, it can be complicated. The sled will tend to slide sideways down the slope. When traveling on a sidehill, we put more roughlocking on the uphill side of the sled. As the dogs pull, the sled pulls unevenly, holding it on the sidehill angle.

Once the sled gets out of control and starts tumbling down the mountain, tremendous injury and damage to your sleds and dogs likely.

## **Rhythm**

If you were to jump around wildly, you would tire quickly. Overcoming the inertia of the erratic movements would require tremendous energy. If you were to dance for hours, you wouldn't get as tired because the rhythmic motion is smooth, coordinated, and very energy efficient.

The same principle works with dogs. If they can get and keep a **rhythm**, they can travel for many miles. If the sled is jerking, it throws them out of stride causing them to tire quickly. Overcoming the inertia of the erratic sled is exhausting for them. The main job of the musher is to kick, push and steer in a way that the sled goes as smoothly as possible, without jerking, tugging, and breaking the dogs' rhythm. An inexperienced musher kicking out of rhythm with the dogs can actually slow the sled. He thinks he is helping to propel the sled, adding his force to the dogs efforts, but he is being counter productive by breaking their rhythm.

Mushers have noticed, like cross country skiers and runners, that their kick has far more power if they follow through on their kick backwards, even after their foot has left the ground. Action equals reaction. When the leg is forced quickly backward in the air, the opposite reaction is the sled going forward. Cross country coaches often instruct their runners, "kick, kick." They are using the same science principle.

Action = Reaction

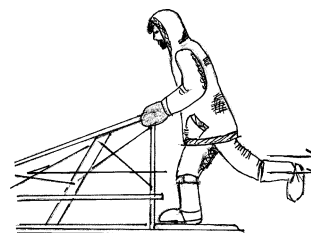



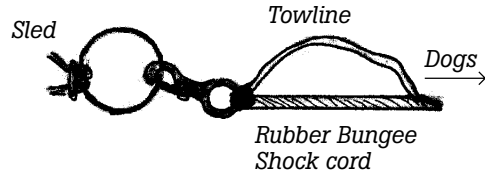

Most mushers today put a shock cord in the towline. This helps to absorb some of the impact of the bumps and jerking of the sled. Maintaining the dogs' rhythm is the secret to endurance. Violating physics principles results in tired dogs.

## Turning

Turning the sled takes energy from the dogs. This is why the musher usually puts his/her strongest dogs nearest to the sled. Once the sled gets off the trail, particularly with a big load, it takes considerable energy to get it back on. The most efficient way is to stay on the trail. It is important to rig and build the sled so that it steers well.

### Bridle

If the bridle were attached to the very front of the sled, it would steer easily, but some of the dog's energy would be pulling the sled downward, greatly increasing friction.

If the bridle were attached in the middle of the sled, it wouldn't have the leverage to steer as the sled weaves from side to side on the trail, or navigates trees in a portage.

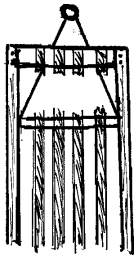

*Bridle attached properly.*

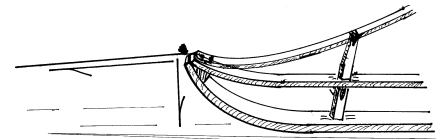

*If the towline is attached to the front crosspiece, the downward pull wastes energy and increases the friction on the runners.*

The secret is to have the bridle attached as near to the front as possible to facilitate steering, but have it back enough that the towline is pulling slightly upward. It is also very important to have the ring of the bridle perfectly centered. If it gets off center, even a little bit, the sled will always tend to pull to one side, tiring dogs and driver.

### Sidehill Secret

When traveling on a sidehill, the sled tends to slide downhill, exhausting and frustrating the musher and dogs and complicating travel, especially with a load. Oldtimers overcame this by putting a stick in the loop of the bridle on the downhill side, thus shortening that side of the bridle. This caused uneven pulling from the downhill side of the bridle, helping it follow the dogs. When travel returned to flat ground, the stick was removed, and the centered bridle pulled straight again.

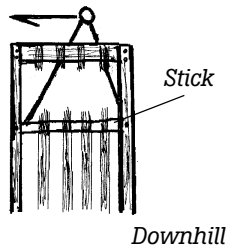

### Rocker

One of the most important things in a longer sled (over eight feet) is having a little "rocker" in the runners. One-fourth to three-eighths of an inch is all that's necessary.

If the runners are perfectly straight, or worse yet, high in the middle and low on the ends, it will be **very hard** to steer. It will always tend to go straight.

If there is too much rocker, the sled will continually swing back and forth, requiring constant energy to steer. It will have no ability to head straight and stay that way.

I have made both of these mistakes.

The sled with too much rocker had a twelve-foot runner, and it was still hard to keep on the trail. The sled that had no rocker was a ten-foot nightmare that couldn't follow the dogs around the slightest corner.

## Ninety Years Ago

Before the fishwheel made feeding larger dog teams possible, men often traveled with only two or three dogs. The men had to pull too. The backs of the sleds had no place for a person to stand. The individual took his place in harness in front of the sled, behind the dogs.

From this position, steering was a problem so they bolted and lashed a long pole on the right side that could **lever** the sled onto the trail. Braking from that position was very difficult, as might be imagined.

Mule skimmers and farmers in the Lower 48 used the terms, "gee" and "haw" in commanding their animals to go right or left. They brought the terms to Alaska. The pole on the right side was called a "gee pole." From this we get the Alaskan term "gee pole spruce." They

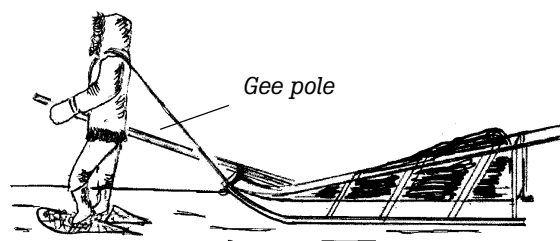

were the toughest trees to use to lever the sled from side to side onto the trail.

When the trail was good, the man rode a single or double ski in front of the sled instead of walking with snowshoes. It wasn't until fairly recently that men rode on the back of the sled. The single ski was similar to today's snowboard. Care was taken to wax or oil the wooden skis and snow board to reduce friction as much as possible.

## Loading the Sled

Keeping in mind the need to save dog's energy in steering, most of the load in a sled should be in the very back. This keeps the front of the sled light, so the dogs can lever it onto the trail.

In March and April, when the packed trail becomes higher than the soft surrounding snow, steering becomes very difficult with a load.

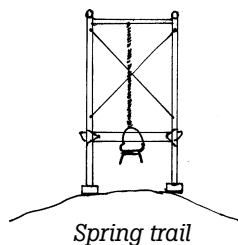

Spring trail

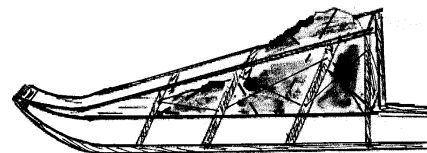

Load in back

## Moving a Big Load

Nowadays most mushers run around with empty or nearly empty sleds. We used to load a whole bull moose or three caribou in a sled and make it home with four dogs. That involved science principles, particularly when the sled got stuck. Static friction, the friction of something not yet moving, is much greater than kinetic friction, the friction of something that is already moving. Once the inertia of the stationary sled has been overcome, and static friction has been replaced by kinetic friction, the dogs can keep a big load moving without much effort. Once the sled is stuck, either from bumping a tree or sliding off the trail, three things must be overcome:

1. Inertia
2. Static friction
3. The weight of the sled back onto the trail.

All of this amounts to an energy drain on the dogs and driver.

To get going after sliding off the trail with a big load, pull about a foot of slack in the towline and let go while yelling at the dogs. When they hit the end of that foot of slack, the force of their weight and startup speed jerks the sled, overcoming inertia and static friction.

We had to be careful using this trick with the dogs. They can exert tremendous force, sometimes breaking snaps and towlines. That meant a long walk home as the dogs took off alone.

This same principle is used today in snowmachines where there is a spring in the sled hitch. The force of the machine hitting the end of the spring jerks the sled loose. Without the six inch spring, the snowmachine would spin out before it overcame the inertia and friction of the sled.

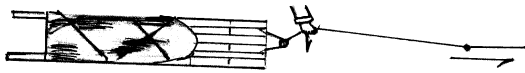

## Sled Length

A longer sled is heavier and harder to steer, but on a rough trail it glides over the bumps that a smaller sled would dip into.

This saves tremendous energy for the dogs, as an erratic small sled breaks the dog's rhythm and quickly tires them.

A longer sled has more surface area on the runners than a shorter one. On a hard trail, this produces more friction. On a soft trail, it means more surface to keep the sled up. It takes a lot of energy to compress snow, and there is no return on the energy expended. Longer sleds sink far less than short ones. As a longer sled is harder to steer, it needs a little more rocker in the runners.

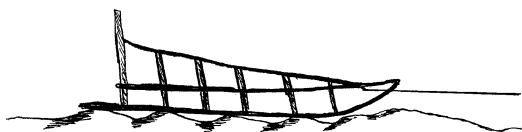

*A long sled glides over bumps*

Once the sled sinks up to the crosspieces, the resistance is so great that travel is almost impossible. Modern sleds that have a plastic belly aren't affected this way, but long ago, this was the cutoff point for travel. Once the crosspieces were dragging, we had to walk ahead with snowshoes.

## The Bend

A sled that has too abrupt a bend will constantly jerk the dogs backward. The forces from hitting a bump with a sled of this design are very negative.

The amount of upturn and degree of bend depend on the country being traveled.

*Gentle turn up glides over bumps*

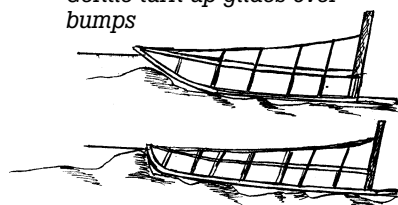

*Blunt turn up impacts bumps*

## Brakes

I used to think of the brake as “negative dog feed”. The chemical energy of dog feed converts to the energy of motion on the trail. The motion and inertia of the moving sled must be **preserved**. A brake is a friction device to overcome that motion.

We made brakes from iron similar to the ones today. Tools and materials were at a minimum, and brake manufacture was an art form.

The problem is to have a brake that will work equally well on clear ice and soft snow.

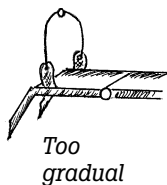
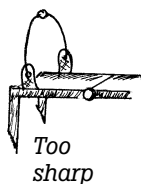

To stop on clear ice, sharp points must dig in at the proper angle. If the angle is too gradual, it will slide over the surface. If the angle is too sharp, it can hook logs and stumps, rip off the sled, and endanger the musher.

Stopping on a hard packed trail is fairly easy, but fall time on clear ice, or traveling in the windswept mountains, the challenges are far greater.

To stop in powder snow, there has to be enough surface area to provide the resistance to slow the sled.

Some people now use pieces of cleated snowmachine tracks for a brake.

## Summary

There is no perfect sled. How you design a sled depends on your purpose and conditions. Every adjustment is a tradeoff.

There is a limited amount of energy available from a dog team. That energy must be conserved as much as possible if the musher is going to haul a load or travel the distance. Sled design and operator skills make all the difference. With the same dogs and an efficient sled, a good musher can go two or three times farther than an inexperienced one.



## ACTIVITIES

1. If there are any dog teams in your area, study the sleds. What is the length? Is there rocker in the runners? What are the sleds used for: racing, cross country, hauling loads?
2. Study the snowmachine sleds and hitches in your area. What are the features people look for? What materials are best?
3. What did people there use for runners before plastic became available? Before that, what did they use? Ask about different weather conditions. Does their experience compare with the above text?
4. Ask the oldtimers how they determined where to put the bridle of the sled and why they did it that way.
5. What is the load most often hauled now by sleds in your village? What used to be the main load?
6. Ask people in your area why they switched from dogs to snowmachines. What are the advantages and disadvantages of each?
7. Watch dogs as they train. What rhythms do you see? Do all the dogs in the team go from a walk to a trot to a full run at the same speed? Watch the team on uneven ground. Why is the musher pushing?
8. Try pushing the different sleds in your village. Which runners are best and why?
9. Roughlock the runners of a sled. Try to push or pull it.
10. Try roughlocking a sled's runners and going down a small hill. Roughlock only one side. Try again.
11. Ask the oldtimers in your area how they traveled in the mountains with dogs.
12. Push an empty sled. Load it and push it again. Is there a difference in getting it going? Is there a difference once it is going?
13. Put most of the load in the sled on the front. Try to pull it around corners. Now put the same load in the back of the sled. Pull it around the same course. What is the difference?
14. Put a temporary bridle on a sled. Move it from center. Pull the sled. Is the difference obvious?
15. If possible, try a long, short, and medium sled (eight, ten, and twelve foot) on a rough trail. What differences do you observe?
16. Get a big load in a sled and hook up a few dogs. Let them try to get the load going. Stop. Pull slack in the towline, and command the dogs to pull. When they hit the end of the slack, there is a jerk (as in the chapter "Moving a Big Load".) Is there an easier way you know of to get the sled going with a big load?

17. Put a fisherman's scale on the end of a line from a small sled. How many pounds do you have to pull to break the sled free from static friction? How many pounds is the sled pulling once it is moving? Of course, some of the resistance while the sled is stopped is from inertia, but much is static friction.
18. Look at the sled brakes in the village or ask the oldtimers what they used for a brake. Were the conditions mostly powder snow or clear ice?



## STUDENT Response

1. What five things are dogs pulling against when they pull a sled?
2. What kind of runners did the oldtimers have for warm and cold weather?
3. What were some of the local alternatives to ironwood runners imported from South America?
4. Why have we changed to plastic?
5. Draw a picture of roughlocking.
6. Describe inertia as it relates to driving a dog sled.
7. Why is rhythm important?
8. What happens if a long sled doesn't have any rocker in the runners?
9. What happens if the sled has too much rocker?
10. What happens if the bridle on the sled isn't centered? Explain or draw the result.
11. Draw a picture that illustrates the advantages of a long sled on a rough trail.
12. Thinking of the four things that a dog is working against, tell as much as you can about making the dog's job easier and increasing the miles traveled in a day.
13. Draw the top view of a sled that would be pulled by a man and two dogs. Include the method by which he would steer.
14. Why is traveling in March or April difficult?
15. What two forces have to be overcome to get a sled moving?
16. Draw a picture showing the disadvantage of a sled with a bend in the runner that is too abrupt.
17. What is the purpose of a sled brake?

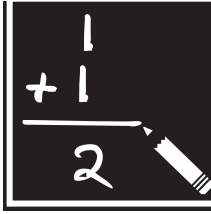

## Math

1. A sled has a runner that is in contact with the snow for 8.5 feet. Each runner is 2" wide. (Remember, there are two runners.) The sled, including driver and load, weigh 275 lbs. What is the pressure in psi of the runners? What would it be if the runners were 1.75" wide? 3" wide?





## Chapter 23

# Snowmachine Tracks

Snowmachines have been in villages long enough that few people under thirty can remember when dog teams were the main form of transportation.

It wasn't until science and technology developed good material for a track that snowmachines had a chance of being practical. A book on the Klondike Gold Rush described a powered vehicle that the builder thought could travel over snow. It had a large steel track with big teeth. The first journey of this steam-powered vehicle was its last. It dug straight down into the earth, unable to get out.

### Material

A track made of steel is too heavy for the light engines used in snowmachines. Besides, a steel track would become an icy mass as soon as it got into overflow.

Natural rubber stretches too much to be good material for a track, and it dissolves in gas and oil. Kevlar provides flexibility, strength, relatively low weight, and durability. The strength of the track is increased by putting nylon cords in the track material. This is like putting steel in concrete. The combination of materials is far stronger than either of the materials separately. The nylon prevents the track from tearing, and the Kevlar keeps the nylon from wearing.

Oldtimers understood this same principle. They put beaver fur in spruce gum when they patched a hole in a boat. The beaver fur strengthens the same way the nylon and Kevlar fibers do in the snowmachine track.

### Choosing a Track

There are several factors involved in choosing a track:

#### *Length*

A longer machine tends to glide over the tops of the bumps and "floats" more on powder snow. However, if the track is too long it will be hard to steer in tight places and takes more power to turn the track.

Short tracks are better for hard trails and sharp corners, as in racing. If the track is too short, the machine will get stuck in soft snow. A short machine tends to give a jerky ride because it goes in and out of all the bumps.

#### **Standards**

A 8c, 15  
B 3  
D 1, 3

#### **Concepts**

Surface area  
Friction

### Width

If the track is too narrow, the machine will be tippy. If it is too wide, it will be hard to steer and require a lot of power to drive it. It will also be too wide for the driver to straddle.

### Thickness

If the track is too thin, it will tear. If it is too thick it will take too much power to drive it, especially in cold weather when everything is stiff. Wise operators elevate the rear of the machine and spin the track for a short time before traveling. This loosens the track and prevents burning the belt on cold starts.

### Surface

The surface of the track is very important. If a track is too smooth, there isn't enough friction with the surface of the snow, and it will spin out. If the track is too rough, like a machine with racing cleats, it will dig down and get stuck in powder snow.

Cleated track



Some tracks have steel cleats across the width. They can pull large loads on hard trails without spinning out. Unfortunately, cleated tracks can slide sideways. A young man who went sideways off a windswept mountain top with a brand new machine. He lived, but the machine was destroyed.

Racing machines often have **stars** bolted on the track surface. They resist spinning out and they don't slide sideways.



Star

### Overall

Basically, if the track is too large, it takes a lot of power to drive it. If it is too small, the machine sinks in powder snow, or it spins out when pulling a load because there isn't enough surface area in contact with the snow.

There is no perfect track, since one is good for one condition and not good for another. The main things to consider are the surface area, how much flotation and contact are needed, and how much friction is needed. The use of the machine will determine which track to get.

## Suspension

### Bogie Wheels

Bogie wheels

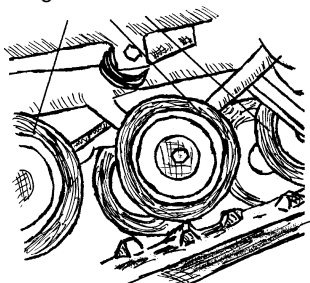

The first snowmachines that came to Alaska had bogie wheels inside the track. A snowmachine track is similar to a truck tire. The truck tire is held in shape by air pressure. The snowmachine track is held open by springs, wheels, and rails.

Bogie wheel suspension is good because it causes the track to fit the contour of the trail, keeping as much of the track in contact with the trail as possible, increasing the surface area that is exerting fric-

tion. However, bogie wheels represent a lot of springs, bearings, and other moving parts that need maintenance. There aren't many machines left that use them.

### Slide Rails

Most newer machines have slide rails that are held in place by a few strong springs. The track actually slides on the rails that are made from a very low friction material called Hifax, a form of Teflon.

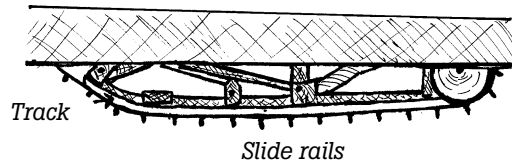

Slide rails will wear out rather quickly if there isn't a little snow lubricating them particularly on gravel. On a hard trail, a good driver occasionally runs into powder snow to lubricate the slide rails.

Without Hifax or some similar low-friction material, slide rails would not be possible.

### Skis

Snowmachine skis take a terrible beating and are expected to operate under many different conditions. They not only steer the machine, but they give flotation in powder snow.

They must have enough surface area to keep the front of the machine up, and must also be able to steer on clear ice. Actually, they are designed to have very little friction in a forward direction, and as much friction as possible sideward. Within recent years, manufacturers have produced plastic skins to fit under the skis. They provide a little more surface area for flotation, but their main purpose is to reduce friction with the snow. They work amazingly well.

Some people run their machines on bare tundra, and report that plastic skins are a tremendous improvement. Of course, they don't last long on gravel roads.

Most skis have a very hard steel skey down the middle that is designed to help the machine track on hard or icy trails. The skey is made of very durable carbide steel.

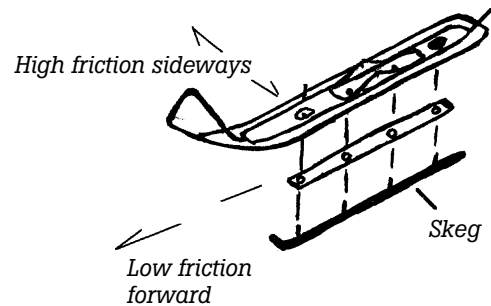

### Belly Plastic

In the effort to make snowmachines more efficient while breaking trail, manufacturers have made sheets of plastic to fit under the belly of the machines to reduce friction. The plastic provides protection from impact with obstacles.

The belly plastic offers that kind of help by reducing friction in powder snow in critical moments.



## Activities

1. Put gasoline on a rubber band. What happens? Put a rubber band outside in the cold. How flexible is it below zero? Why aren't tracks made of real rubber?
2. Look at the different snowmachine tracks in the village. How do they compare in length and width? Do some have metal cleats? Do any have racing stars? Of all the different kinds, which is the most popular in your village?
3. Measure the surface area of the tracks plus surface area of the skis of different machines. Compare the surface area to the weights given in the snowmachine specifications. How many pounds per square inch does each one represent? Are there relationships between the psi of trail machines contrasted with racing machines?
4. Draw the patterns of the bottom of the tracks. Compare them. Compare them with four-wheeler tire patterns. Are there any similarities?
5. Find old tracks around the village. Compare their thickness. Diagnose why each one broke (cracking, wear in certain places). Try bending a piece of track that has been out in the cold. Try bending the same piece of track once it has been inside for a while. How much difference is there? Speculate how much more power it takes to turn a cold track than a warm one.
6. Carefully try to cut a piece of snowmachine track. Can you appreciate the technology that made it this tough?
7. Ask the people in the village what they do when a track breaks far away from home.
8. What uses have people found for discarded snowmachine tracks in your village?
9. Compare the suspension systems of the machines in your village. Do some still have bogie wheels? Talk to people that own the two different kinds. What are the advantages of each? Find a discarded slide rail. Does it look like it wore out because of snow or gravel? Try to cut it with a knife. Is it hard? What uses have people discovered for used slide rails? Inquire how much new slide rails cost and how hard they are to install. Identify the part of the track that slide rails run against. How is this different from the rest of the track? Are the bearings on the bogie wheels sealed bearings? What do you think happens when the seals go bad? What can you learn about increasing the life of bearing seals?
10. Look at the skis on different machines in your village. Talk with people who use the plastic skins that fit under the skis. What do they say?

What is the surface area of the average ski? Compare skegs on the different skis.

11. Measure the distance between the skis on different machines. Is there a difference? If so, why do you think this is so? What do snowmachine owners say about skis being close together or farther apart? Is it important? If so, under what conditions?
12. Talk to several people who have installed the sheets of plastic under the belly of the snowmachine. Do they notice a significant difference? Why did they install the plastic in the first place?
13. When did snowmachines first come to your village? Ask the older people how they have changed over the years. What about them has improved? What about them has not improved? Why do they think machines are better than dogs?



## STUDENT Response

1. Why wouldn't a track made out of natural rubber last on a snowmachine in Alaska?
2. Why are there nylon cords in the track as well as Kevlar?
3. What is the problem with a very large track?
4. What is the problem with a small track?
5. What is the problem with a track that is too smooth? Too rough?
6. What kind of track would you want to operate in deep powder snow?
7. What kind of track would you want for racing? For pulling big loads on hard trails?
8. Skis are designed to have very little friction in a \_\_\_\_\_ direction, and considerable friction in a \_\_\_\_\_ direction.
9. What is the purpose of skis besides steering?
10. Why do some people put plastic skins on skis?
11. Why do some people have belly plastic installed?

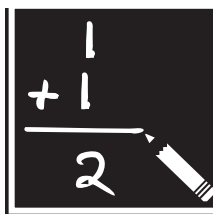

## Math

1. A machine weighs 375 lbs. The track is 15"  $\times$  47" in contact with the trail. The skis are 5"  $\times$  30" each with plastic shoes. What is the average psi of this machine on the surface of the snow?

2. A racing machine weighs 489 lbs. The track is 15"  $\times$  40" in contact with the snow. The skis are 5"  $\times$  24" each. What is the average psi on the surface of the snow?
3. A long track uses 25% more energy to turn than a short one. Turning a short track represents 9% of a machine's effort. If Pete usually spends \$350 a year on gasoline approximately how much is he paying for the convenience of having a long track?
4. Having plastic ski skins and plastic on the belly of a machine saved 12% of a machine's effort. They cost \$75 to purchase. If Moxie usually spends \$425 for gas on his trapline, will the plastic on the skis and belly pay for themselves in the first year?

## Chapter 24

# Snowmachine Clutches

Snowmachine clutches are a genius of invention. They do so much so simply.

All engines attempt to match the engine speed to the load on the engine.

- Trucks, cars, and most four-wheel ATVs have to shift gears as they accelerate and decelerate.
- An outboard motor has only forward, neutral, and reverse. The pilot of an outboard motor must change props in order to “change gears” from a work prop to a speed prop.
- Some airplanes can change the pitch of the prop as they fly. Others have a fixed prop.
- A chainsaw clutch is like a one speed transmission. The chain is either stopped or it is turning at the same speed as the engine.

None of these compare to a snowmachine clutch which is **constantly sensitive** to the load and force generated by the engine, **balancing** them in a constant flow of mechanical advantage. It is truly a beautiful thing to watch. A few models of four-wheel ATVs use the same type of clutch.

### Pulleys of Different or Same Size

#### Standards

A 6, 15  
B 1, 3  
D 1, 3

#### Concepts

Friction  
Inertia  
Mechanical  
advantage

1. If two pulleys of the same size are connected by a belt, as one turns, the second one will turn at the same speed with the same power available at the shaft.
2. If a smaller pulley turns a larger one, the larger one will turn slower, but with more power available at the shaft.
3. If a bigger pulley turns a smaller one, the smaller one will turn much faster than the bigger one but with less power available at the shaft.

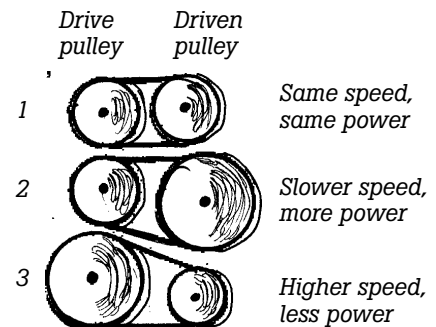

### *Example of Shifting a Truck*

In low gear, a truck engine turns fast, but the wheels turn slowly. The truck goes slowly, but with power.

In higher gears, the engine turns more slowly, but the wheels are turning fast. There is less power to accelerate in higher gears, but the speed of the truck is much greater.

## Effect of Load on an Engine

### *Overload*

If an engine is overloaded, the speed of the engine (rpm<sup>1</sup>) is reduced, and there is tremendous **stress** on all of the drive components.

### *Underload*

If an engine doesn't have enough load, it can turn so fast (high rpm) that it can self destruct. The inertia of the piston going up and down at a speed too great for the engine will stress all of the internal parts.

### *Conclusion*

**The load on the engine governs the speed of the engine.**

For an engine to run efficiently, it must be balanced with the load. We wouldn't try to go 60 mph down the highway with a truck in first gear, nor would we try to start the truck in fourth gear.

## Parts

A snowmachine clutch is made of two pulleys and a wide belt:

- The **drive pulley** is on the end of the engine crankshaft.
- The **driven pulley** drives the chain that connects to the track.
- The **belt** connecting the two pulleys is strong enough to transmit the energy of the engine to the track. It has enough friction with both pulleys that it won't slip, except in extraordinary circumstances (as occurs when the track is frozen down.) The belt must be extremely strong yet flexible, even in very cold temperatures.

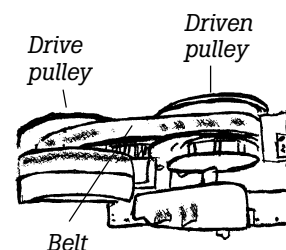

## Description of Low and High Gear

1. When the snowmachine is starting to move, the engine is turning rather fast, but the track is turning slowly. There is ample power to get the machine going.
2. When the machine is accelerating, the engine speed is reducing and the track speed is increasing.

1. Revolutions per minute.



3. When the machine is at a cruising speed, the engine slows down and the track turns quickly.

The size of the drive and driven pulleys change while the machine is running.

### *Idling*

When the machine is stopped, the engine turns, but the belt and track do not. The drive pulley is spread apart.

### *Starting*

When the engine is accelerated, the drive pulley closes together pinching the belt, connecting the engine to the track. The machine moves forward, with the drive pulley small, and the driven pulley large. The machine's speed is low, but the torque is high. This is like low gear in a truck.

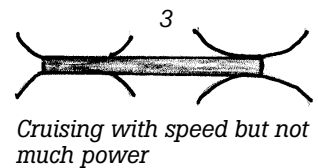
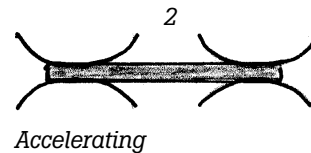
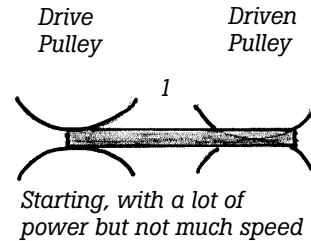

### *Accelerating*

As the machine accelerates, the engine speed increases, and the drive pulley closes together, making the drive pulley bigger. This spreads the driven pulley, making it a smaller pulley. At this point the drive and driven pulleys might be the same size. This is like second gear in a truck.

### *Cruising*

When the machine is at cruise speed, the drive pulley is closed together, making it a large pulley. The driven pulley is spread apart, making it a smaller pulley. This is like high gear in a truck. The track is going fast, but the engine is not. This speed is more fuel efficient with less wear and vibration. The larger drive pulley is driving the smaller driven pulley.

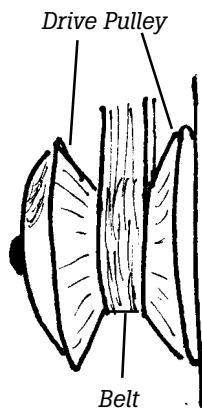

### *Decelerating*

As the machine encounters resistance, whether it is a hill or soft trail, the engine is slowed by the load against it. The drive pulley slows down, and spreads apart. The driven clutch is then driven together by its springs. This is like downshifting to a lower gear in a truck. The engine speed increases and the track speed is reduced, giving more power for the machine to work against the resistance.

We might ask why cars and trucks don't have this kind of transmission if it is so good. The belt system isn't strong enough or efficient enough for large engines and large loads.

## The Drive Clutch Responds to the Load on the Engine

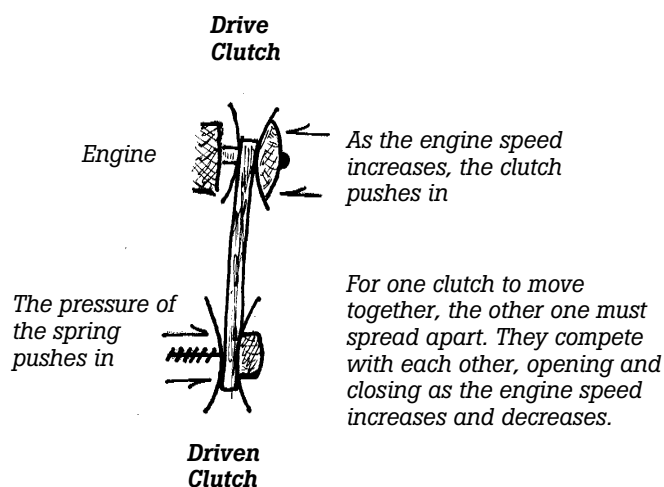

The drive pulley has weights that move out when the engine speed increases. They force the movable half of the drive clutch towards the other half, making it, in effect, a larger pulley.

When a load is encountered, the engine speed drops, and the springs within the clutch push it apart, in effect making it a smaller pulley.

The force of the weights in the drive clutch balance with the force of the springs in both the drive and driven clutches. Those forces flow against each other, constantly keeping the load and force of the engine in balance. Block up the rear end of a snowmachine, and observe the clutch working as the track spins above the ground.

## Maintenance

There is a beautiful **balance** between the pressure of the springs and the force of the weights in the drive clutch. If any of the parts are not well lubricated, that balance will be hindered.

It is important to use polar grease that will not get too thick in very cold weather. The clutch should be sensitive to load, and not be sensitive to temperature.

### *Adjusting the clutch*

Most machines have a way to tighten or loosen the spring of the driven clutch. Stronger or weaker springs can be installed.

If the spring in the driven clutch is too strong, it resists spreading. In effect, it gives the machine more power, but causes the engine to operate at a higher rpm than is healthy. If the spring is too weak, the driven clutch spreads easily. Top speed is easily reached, but the engine stresses and is weak in acceleration.



## Activities

1. Remove the clutch guard from a machine and identify the parts.
2. Block the back of the machine up or suspend it so the track is free from the ground. With students at a safe distance, start the engine. Acceler-

ate and decelerate the engine. Can you see the clutch responding automatically to the throttle changes?

3. Watch the drive clutch. Is it bigger at low or high rpm?
4. Watch the driven clutch. Is it bigger at low or high rpm?
5. Is clutch movement smooth or erratic? If it is not smooth, what does this indicate?
6. At below zero temperatures, put polar grease between your fingers on one hand and regular grease between the fingers of the other hand. Can you feel the difference?
7. What would slip if the track were frozen down and the engine accelerated? Do you see evidence of this around the clutch?
8. Remove and replace a drive belt. Compare a worn and a new belt for width. Find the price of a new belt.
9. Can you see the weights in the drive clutch? If this isn't possible, try to find an old one that has been taken apart. Describe how centrifugal force causes the drive clutch to close together. Draw what you imagine happening.
10. Compress the spring from both the drive and driven pulleys. Are they stronger or weaker than you thought? Is there a way to tighten the spring on the driven pulley on the machine you are looking at?
11. Improvise some pulleys, even if you have to use a rubber band as a drive belt. Use different size thread spools as pulleys if you can't find anything else. Predict how many turns the driven spool will turn when the drive spool turns once.
12. Drive a four-wheel ATV, accelerating through the gears. While doing this, try to imagine what would be happening to the drive and driven pulleys if it had a snowmachine clutch. (Actually, Polaris six-wheelers have a clutch like a snowmachine.)
13. Do you think this kind of clutch would work on an outboard motor, giving better performance?



## STUDENT Response

1. How do each of the following attempt to balance the engine speed with the load?
  - Trucks, cars, & four wheelers
  - Outboard motors
  - Airplanes
2. What are the three main parts of a snowmachine clutch?
3. Which clutch is on the end of the engine's driveshaft?

4. Draw a picture of a big pulley driving a smaller one. If the big pulley turns once, will the little one turn more or less than one turn?
5. Draw a picture of a smaller pulley driving a bigger one.
6. Draw a picture of two pulleys of the same size.
7. Which of the above pictures illustrates an engine starting to move?
8. Which one of the above illustrates an engine at cruise speed?
9. What is the main advantage of a snowmachine clutch over a truck transmission?
10. Why couldn't it be used on a truck or car?
11. What is the advantage of a snowmachine clutch over a chainsaw clutch?
12. What is the governor on an engine? What happens if there isn't enough load on an engine? What happens if there is too much load on an engine?
13. What two things does the snowmachine clutch balance?
14. Why is good lubrication important in a snowmachine clutch?

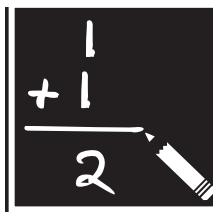

## Math

1. A pulley 3" in diameter turns a pulley 2" in diameter. If the first one turns 50 complete revolutions, how many revolutions does the second one turn?

## Chapter 25

# Snowshoes

Snowshoes have been a part of the traditional culture in interior Alaska for more years than we can trace.

The design of snowshoes has varied from location to location, controlled mostly by the needs, conditions, and materials at hand.

### Basic Idea

The idea behind snowshoes is fairly simple: Increase the surface area of a person's foot so they can walk on top of the snow rather than penetrating to the bottom. The number of snowflakes holding up the person is increased when the surface area is increased. Without snowshoes, the number of snowflakes is rather small. With snowshoes, the number of snowflakes is greatly increased.

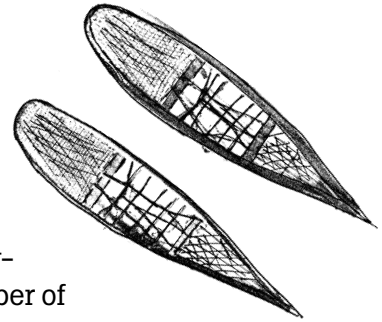

This sounds easy, but designing a shoe that:

- is light and strong,
- will be comfortable to use in deep or packed snow,
- is easy to put on and take off,
- will keep the traveler on top of the snow, but
- won't accumulate snow on its surface.

All of these amount to an engineering feat.

### Size and Shape

How big should snowshoes be? If they are too wide, the person will walk bowlegged. If they are too narrow, they won't have enough surface area to support the traveler.

If they are too short, they will not have enough surface area to support the person. Traveling in soft snow will be very difficult. If they are too long, they will be too heavy, and difficult to use in the brush.

If they don't have enough turn-up in the front, they dive into the snow, and cause the traveler to constantly fall. If they have too much turn up, they won't provide enough area on a harder surface to support the traveler.

#### Standards

A 1, 15  
B 1, 3  
C 3  
D 1, 3

#### Concepts

Surface area

## Two Types

There are basically two types of snowshoes, trail and bearpaw. Trail snowshoes are usually ten inches wide and fifty-six inches long including the tail. Bearpaws are shorter and rounded on both ends.

The front of trail snowshoes are upturned for deep powder snow. The rounded shape of the bearpaws give a little bounce to the traveler's step on hard packed snow, acting like a mini-trampoline.

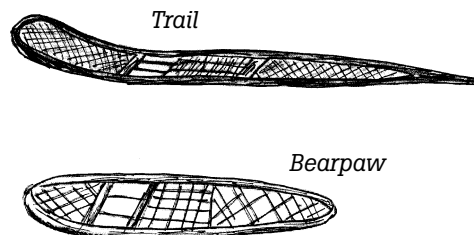

One  
square  
inch

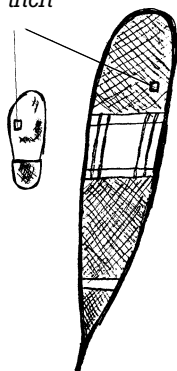

## PSI

The pressure that snowshoes exert on the snow can be described in pounds per square inch (psi). A heavier person will sink deeper on the same pair of snowshoes than a lighter person because the pounds per square inch of snowshoe surface is greater.

Both a lighter and a heavier person sink deeper in powder snow because the strength of the snow is less than the strength of packed snow.

The optimum size of snowshoes depends on the traveler, snow conditions, and use. If the traveler is fairly light or usually travels on hard-packed or drifted snow, small shoes will be enough.

Once the traveler sinks deeper than his knees, traveling becomes very difficult. In powder snow, I have never found a pair of snowshoes that I thought were too big except in a few experiences fighting through brush.

Oldtimers purposely used smaller snowshoes to break trail a good trail for dogs or other people following behind.

When they ran down a moose, they often used very large snowshoes (six feet) to stay on top of the snow and conserve their energy.

### Balance

The front of some snowshoes dive into the snow, tripping the traveler. To prevent this:

- The front of the snowshoe has more surface area than the rear.
- The front of the snowshoe is turned up.
- The rear has more weight.

These three features work together to keep the front of the snowshoes from diving.

### The Tail

Some trail model snowshoes have a long tail. It serves an important purpose. The tail keeps the snowshoe pointing forward, like the keel on a canoe



or tail on a kite. Without the tail, the snowshoe would swing from side to side, particularly in the brush, getting hung up, slowing and frustrating the traveler.

### *Mesh*

The mesh underfoot obviously needs to be bigger and stronger than that in the front and back.

Powder snow demands mesh in the front and back that is smaller and more tightly woven to provide adequate surface area. Wetter or coarser snow demands mesh that is thicker and more durable against abrasion.

## **Materials**

### *Frames*

A well-chosen birch tree is tougher than all commercial woods sawn from a tree.

Not every birch tree is adequate. Oldtimers spent days and months looking for the right tree with the proper grain that was flexible, durable and with no knots.

Once they found the tree they were looking for, they split the snowshoe frame from the tree. This left the strength of the natural grain intact. Sometimes hot water or steam were used to bend the frame. Great care was used to avoid overheating. Heating and steaming weaken the wood.

Commercial snowshoe frames are made from hickory or ash. The wood is sawn from planks rather than split, so the grain of the frames are greatly weakened. All first growth ash and hickory are gone from the United States as well as most of the second growth. The hickory and ash harvested now are from small, third-growth trees.

Manufacturers have experimented with aluminum alloys. They are very light and strong. It doesn't take much imagination to know what happens in overflow.

### *Webbing*

For webbing, oldtimers used the skin from the belly of a spring moose. This is the strongest and toughest skin available.

There is a real art to making the rawhide as it takes two people working well together... a true test of a marriage or friendship!

We used to skin moose very carefully. Nowadays, it is hard to find a good skin to work on.

Untreated rawhide stretches when it is wet. Unfortunately, dogs like to eat rawhide and more than a few travelers have cursed their dogs for eating their snowshoes.

Weaving the webbing to snowshoes in a way that is appropriate for local snow conditions is an art.

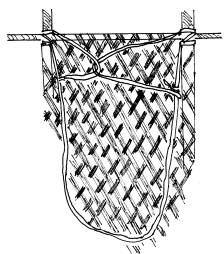

### *Bindings*

Commercial bindings available today are functional, but the bindings on the old time snowshoes were light and could be put on or removed in seconds without using hands. Manila rope treated with linseed or vegetable oil works best for Native-style bindings because it is quiet and doesn't stretch like synthetics. Rawhide stretches too much when wet.

Few things are more miserable than snowshoe bindings that don't work properly.

There are some good quality modern bindings, but they are very expensive. Complex buckles and straps make travel on thin ice very dangerous. Traditional Native bindings come off with a twist of the foot.

### *Noise*

Oiling snowshoes reduces noise when hunting. The friction of wood to wood, or rawhide to wood produces enough noise to alert animals, particularly in very cold weather. The sound of snow being compressed is loud enough in cold weather. Creaking snowshoes make matters much worse.

### *Care*

Linseed oil discourages animals from eating the snowshoe webbing. Snowshoes are usually kept outside in a cool dry place, above the reach of animals. While birch has great strength, it tends to rot easily, and oil helps prevent this. As the best snowshoes are very light, the traveler must walk carefully to avoid breaking the frames.



## Activities

1. Time someone walking a given distance in deep snow without snowshoes. Then time the same person with snowshoes.
2. Try different kinds of available snowshoes (trail, bear paw) on different snow conditions. Which is easier and why? Which is easier in the brush? On a snowmachine trail? On windswept snow? In powder?
3. Try different kinds of bindings. Which seem better to you? This test is invalid unless you walk under many different conditions: packed trail, in the brush, up hills, in deep powder, etc. Which bindings and snowshoes are the quietest?
4. Compute the psi of individuals wearing winter boots and again with a pair of snowshoes (their weight divided by the area of the boots or snowshoes).
5. Ask some of the oldtimers in your village what kinds of snowshoes they used and why. What did they do to the rawhide (oil, varnish, etc.) to make it waterproof?



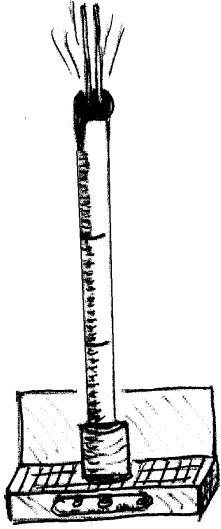

*A simple steamer*

6. Ask an oldtimer how to pick a good birch tree for snowshoes. How could they tell the grain of the wood and the toughness of the fiber?
7. Take two pieces of birch from the same tree. They should be carved about the same size, similar to the frame of a snowshoe. Cut them two to three feet long for this test. Steam one. Bend them both. Which bends easier? Which breaks first? (An easy steamer is made from a coffee can with two inches of water in the bottom with stovepipes extending to the desired length.)
8. How did they make rawhide in your village? How was the skin cleaned and how was it split into thin strips? Does anyone still know how to do this? Try to learn if there is a skin available.
9. If a pair of homemade snowshoes is available, try to discover the pattern followed to lash the webbing. What did oldtimers do to protect it from wearing?
10. Study the different kinds of snowshoes described in catalogs and resource materials. What kinds of traditional snowshoes were used in other regions of the North? Can you guess their winter weather by the design? Look at the following picture. What kind of snow conditions do you think this snowshoe was designed for?

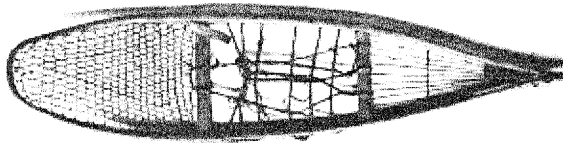

11. What kind of snowshoes do you think are best for walking home on a snowmachine trail? Time someone walking with these snowshoes for a mile. Time someone without snowshoes. Who walks faster?
12. Some oldtimers knew how to make emergency snowshoes. Ask the old people in your village if they ever used that kind.



## STUDENT Response

1. What is the idea behind snowshoes? Use the term "psi".
2. With the same snowshoes, who will sink more deeply into the snow: a person eighty pounds or someone one hundred and ten pounds?
3. Which is better for hard packed snow: bear paw or trail snowshoes?
4. Which is better for powder snow: bear paw or trail snowshoes?
5. Why would someone want smaller snowshoes even if the snow is soft, deep powder?

6. What purpose does the tail of the snowshoe have?
7. Why aren't commercially-made snowshoe frames strong?
8. What kind of skin was the toughest to use for traditional lashing? What is the disadvantage of this kind of lashing?
9. Why did oldtimers oil their snowshoes?

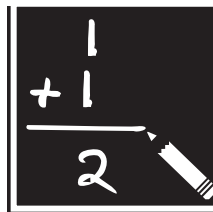

## Math

1. What is the psi of a person weighing 175 lbs on snowshoes that have 400 square inches.
2. What is the psi of the same person wearing boots with 48 square inches? Snowshoes increase the surface area the person is exerting force upon by how many times?
3. On a trail snowshoe, measure the surface area in front of the individual's toe. Measure the surface area behind the individual's heel. Which is greater?
4. Compute the psi of the smallest person in the class if they have a standard pair of 10"  $\times$  56" snowshoes. How big would the snowshoes have to be for the largest person in the class to have the same psi therefore sinking the same distance into the snow? You will have to figure the area of the snowshoes out in several different parts, circles, squares and triangles.
5. A homemade snowshoe weighs 2.2 lbs. Another one made by the Army is 3.0 lbs. If someone's step is 2' and there are 5,280 feet in a mile, how many extra pounds are lifted in a mile? How many extra pounds are lifted on a hunting trip where the person walks 7.4 miles?

## Chapter 26

# Winter Trails

Nowadays people effortlessly travel many miles with snowmachines. Long ago we had only foot power or dog power. We had to carefully guard the energy available to travel.

It takes considerable energy to compress snow and make a trail. Breaking trail then and now are vastly different.

### Trails Set Up

When it is cold a trail will set up overnight. We used to make trail one day with an empty sled or snowshoes, and return the next day to haul a load. Overnight the snow crystals bond together, making a hard surface on the trail that supports the dogs and sled.

#### *Strategy in Hauling Meat on Wood*

Years ago, when we shot a moose or caribou, we often removed the entrails and organs, and left the animal until the next day. Even at  $-30^{\circ}$  the animal doesn't freeze if the stomach cavity is banked with snow. We snowshoed a trail home, constantly thinking of the return trip the next day with dogs. No sharp turns or big trees in the way! When we returned the next day, the trail we had snowshoed was fairly hard. We then butchered the moose or caribou and headed home on the packed trail. This method also has the advantage of giving the meat a chance to cool slowly, resulting in more tender meat.

#### *Traveling Strategy*

Much of the oldtimers' traveling strategy was based on the fact that trails set up overnight. When snow was really deep, they often made camp early and snowshoed out several miles, returning after dark. The next morning, the trail was hard and easy traveling for the distance they had snowshoed.

While snowmachines offer power we never considered possible before, there are conditions when they cannot pull a load or break trail at the same time. Often an operator will break trail the night before, and return the next day with the load.

#### **Standards**

A 1, 8c, 15  
B 1, 3  
C 3  
D 1, 3

#### **Concepts**

Forms of energy  
 $F = MA$   
Reflection

### Breaking Trail

Breaking trail is difficult for man, dogs, and machines. It takes considerable energy to compact the snow. With dogs, I would much rather haul a big

load on a hard trail than break trail with an empty sled. Once the dogs are up to their belly in snow, forward motion grinds to a halt.

For dogs and machine alike, the most enjoyable trail to drive on is a hard trail that has just received two inches of fresh powder. The dogs have good footing, but the bumps are minimized by the **cushion** of fresh snow that also provides a very low friction surface. Machines also enjoy the soft cushion of fresh powder.

### Wind-Covered Trail

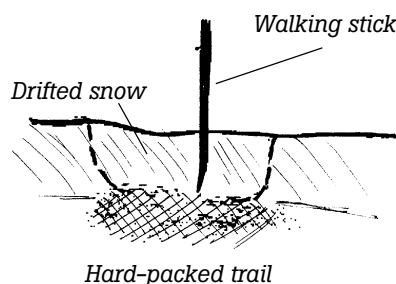

A trail seldom blows completely over in the timber, but will often be obliterated in the open places. Oldtimers walked with snowshoes, probing with a stick, to find the hardened trail in the open places. A good snowmachine operator can feel the hidden trail under the machine.

Often trail markers are placed on both sides of open places so travelers know where to enter the brush or timber.

At night, the shadows of a windblown trail can often be seen in the headlights of a snow machine or headlamp.

### High-Centered Trail

A trail that is obliterated in January or February will show up later as the soft snow around it settles.

- The traveler breaks trail.
- The wind blows more snow into the trail.
- The traveler packs that snow down.
- The wind blows snow into the trail again.

As the snow around the trail settles in March and April, it is hard to stay on the high trail. The sled or snowmachine tends to slip to one side or the other.

That is why wise travelers make a wide trail from December through February, as they know a narrow trail will give them problems later.

This process leaves a trail that is high, wide, and hard to travel on. Snow on either side of the trail is low and soft.

However, in late spring, when the snow is gone from the tundra, a well-packed trail will still remain, giving the traveler a highway of snow surrounded by moss and bare ground. The high trail that was a problem in March and early April becomes a blessing in late April.

When a snowmachine runs over a trail, it goes up and down with the terrain. As it comes down after a bump, the impact, or force of the machine, compresses the snow. This makes the depression on the far side of the bump deeper.

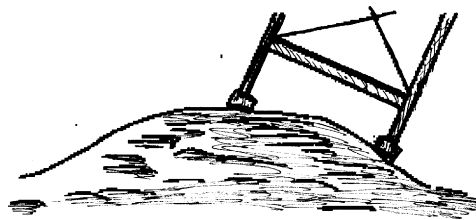

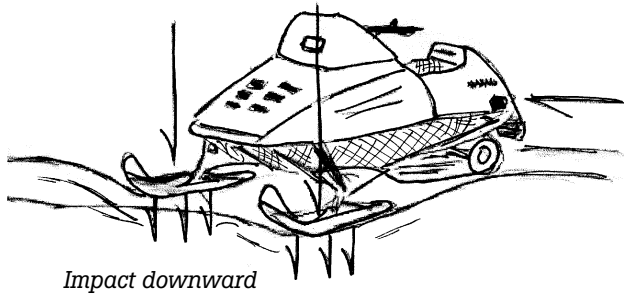

Impact downward

-\*

There is no way to avoid this phenomena. Since **force equals mass times acceleration**, the heavier a machine is and the faster it is going, the quicker it will ruin the trail. The effect can be minimized by going slowly but, sooner or later, someone will have to break a new trail, and the process will start over.

Downhill skiers know quite well how “moguls” come into being. Dog sleds and cross country skiers seldom travel fast enough with enough weight to have this type of problem.

## Overflow

When river or lake ice settles or when creeks overflow, water seeps on top of the ice but under the insulating blanket of snow.

Once the overflow is exposed to the cold air by a passing sled or machine, it freezes quickly. The next time the traveler comes by, there is a rough, hard, icy highway to travel on.

Overflow has always been a problem in the late winter and spring months.

Once the machine is stuck, put brush under the machine providing surface area to stay above the water. Get momentum again and don't stop short of safety.

Ruined backs and frozen feet are always possible during efforts to get snowmachines out of overflow, which can be a foot deep at  $-30^{\circ}\text{F}$ .

Dogs don't get stuck in overflow the way snowmachines do, though their feet ice up with snowballs. When they pull the ice off, they also pull hair, making their feet sore. Dogs with webbed feet suffer more than others.

## Bad Ice

When traveling on bad ice with dogs, we often string the dogs out with a long towline, single file rather than double. This keeps the combined weight of the team, sled and driver over a larger area. If the sled falls through, there are several dogs far ahead on solid ice who can pull the sled out.

Of course, when dogs are spread out like this, it is very difficult to travel in the timber. Some dog or someone will get slammed into a tree as the leader is



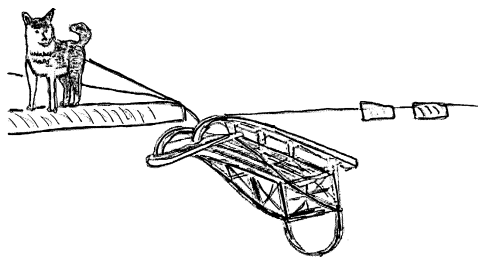

around a bend in the trail others haven't approached yet.

If the front of the sled goes under the ice, the traveler is in **big** trouble, so it is important to keep the front up when this happens. The harder the dogs pull, the more difficult it is to get the front of the sled above the ice.

Swimming across creeks was standard practice in the spring. The driver needs to get up on the railing of the sled, keeping the back of the sled down, the front up, hoping the creek isn't too deep. Some of the dogs get across the creek and onto solid ground when the sled is entering the water. If this looks marginal, the driver can extend the towline with a long dog chain. This assures that some dogs are on solid ground when the sled hits the water.

Snowmachines don't have the luxury of being able to swim, although they can skim on water for a ways if they have enough inertia. Some drivers have overestimated the ability of their machine to travel on thin ice and water. They get a cold bath and a long walk home.

## Sunny and Cloudy Days

In winter, when the sun is shining, there are shadows everywhere that indicate any unevenness of the snow's surface. The light is coming from one source in one direction. When the sky is overcast or foggy, it is very difficult to see uneven features in the terrain. The snow's surface looks flat because light is reflected in all directions. There are no shadows. This makes travel somewhat dangerous. One time I almost walked off an eight-foot bluff. Everything looked flat. On an overcast day, it is hard to see the indentations on the river that could indicate that the ice has melted away beneath the snow's surface. It is safer to travel new country on sunny days.

## Fall and Spring Ice

Fall time, the ice is healthy. Fairly thin ice can hold considerable weight. During the spring, when the warmed overflow water has seeped into the river or lake, the ice has turned to long crystals that don't hold together. Ice two feet thick can crumble under a man's weight.

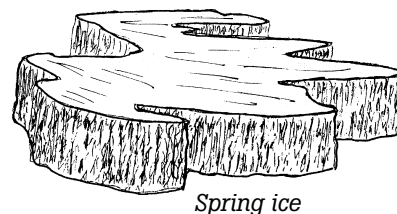

## Activities

1. Break trail with snowshoes in powder snow. Walk back along the same trail within an hour. Walk the same trail the next day if it has been cold. What differences do you notice?

2. Ask oldtimers in the village how they used the fact that trails set up overnight in planning their travels.
3. Ask old people in the village how they can tell which way a moose or caribou has gone even after the track is blown over. How does this relate to the above activities?
4. Observe trails as they emerge “high centered” in March. Ask oldtimers if this was as big a problem with dog teams as it is with snowmachines.
5. Stand on a packed trail. With your eyes closed and a long stick in your hand, can you feel the trail and walk for 200 yards? Do you think you could find a trail that is blown over on a lake or the river by this method?
6. Design a rig that could be pulled behind a snowmachine that would smooth out the bumps in the snowmachine trail. Think about hidden stumps and the need to adjust height.
7. Ask the experienced snowmachine operators in your village for stories about overflow. How do they get out when they get stuck? What months does overflow start in your area?
8. Find out if there are people in your village who fell through the ice and how they survived.
9. How do people get snowmachines out that fall through the ice? Do the machines usually run after they have been underwater for a while? How do people know where to look for the machine in the open water?
10. After breakup, check the ice chunks on the sides of the river. Break them with a stick. Can you see how different it is from the fall ice? Do you think two feet of that kind of ice is strong?
11. From the oldtimers, ask about five places that usually have bad ice in your area. How do they tell bad ice right after freeze-up? During the winter after snow covers the ice? In the spring?
12. Draw a picture of overflow as you imagine it under the snow on the river.



## STUDENT Response

1. Why did people with dog teams break trail one day and haul a load the next day?
2. Which is harder: breaking trail with an empty sled or hauling a load on a firm trail?
3. How did oldtimers find a trail that was blown over?
4. Draw the process that causes a trail to become high centered in March and April.

5. Why doesn't overflow freeze under the snow?
6. What did dog mushers do when traveling on bad ice?
7. What is the difference between fall and spring ice?

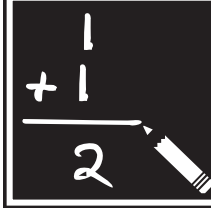

## Math

1. Force = mass  $\times$  acceleration. A snowmachine has  $\frac{1}{3}$  of its weight on the front skis. It weighs 357 lbs. Another machine has  $\frac{1}{4}$  of its weight on the front skis. It weighs 402 lbs. Which machine impacts the trail harder when going over a bump?
2. Fall ice is 12 times stronger than spring ice. If Aaron can walk on ice  $2\frac{1}{2}$ " thick in the fall, how thick must ice be in the spring to be safe?



# Science Concepts Found in This Book

In order to understand this book and make the connection between science as it is understood and applied in the village and science as practiced by Western scientists, it is important to have a basic understanding of both views and the vocabulary associated with both.

Few explanations of science concepts are given in the text as you will probably go through the book in a different order than it is presented here. When you read words in the text, it is assumed that you know the concept. If you don't, or if you need a refresher, come to this section and review the science concept.

The purpose of this book is not to replace existing physics and chemistry books. For more detailed explanations, any simple high school text will make things clearer and give good examples.

## Newton's Three Laws

Isaac Newton identified three physical laws that have been influencing man, the earth, and the universe from the beginning of time. They are simple.

### **Inertia**

The law of inertia says that an object continues in its state of rest or continues in uniform motion in a **straight line** until it is acted upon by an outside force. Something at rest will tend to stay at rest. Something in motion will tend to stay in motion.

Put a  $3 \times 5$  card over the top of a glass or cup. Put a penny in the center of the card. Snap the card with your finger. What happens to the penny? This demonstrates inertia of an object at rest.

Travel in a boat, fourwheeler, or snowmachine at a constant speed. Throttle down or put on the brakes. Why does your body go forward when the machine slows down? This demonstrates that a object in motion (your body) will stay in motion until acted upon by an outside force.

*Centrifugal force*

You notice that the law of inertia says that an object continues in uniform motion in a **straight line**. When an object is spun around, like a model airplane on a string, it has a tendency to go in a straight line, pulling against the string. The force of an object to fly away from the center when spun in a circle is called centrifugal force. Centrifugal means “fly away from center.”

**F = MA**

The second law that Newton described was  $F = MA$ .

Force = Mass  $\times$  Acceleration.

If an object is accelerated or decelerated, the force causing that change can be measured by multiplying the mass times the rate of acceleration or deceleration.

We deal with forces all day, every day. You travel thirty miles per hour on a fourwheeler. You stop. Are you hurt? That depends on the **rate** of deceleration. If you stop in ten seconds you are not hurt. If you stop instantly when the fourwheeler hits a tree, you very well might be.

For a planing boat, there is a critical point where the **rate** water is pushed away is high enough that the water seems to become “solid” and the boat gets “on step”, that is, on top of the water rather than plowing through it.

*Mass vs Weight*

The mass of something and the weight are different. The mass of something refers to how much matter is in the object. It has just as much mass in outer space as it does on earth. The weight refers to how much gravity is pulling on something. An object could weigh ten pounds here on earth, weigh nothing in outer space, yet the mass would be the same in both places.

As simple scientists here on earth, we often inaccurately refer to them as the same.

*Acceleration*

Acceleration is defined as distance (feet) per second squared.

ft/seconds<sup>2</sup>

Herein is one of the most important concepts in all science. With many forces, as one variable is increased, the result increases in the same proportion. With equations that involve acceleration, the result is **squared**. When a variable is increased, the result is squared or reduced by the square.

Let’s look at an example. An object with a mass of ten is at rest. It is accelerated to ten feet per second.

In one case, it is accelerated to that speed in four seconds.

In another case it is accelerated in twice that time, eight seconds.

Is the force cut by one-half because the time of acceleration is doubled?

NO! The force required is reduced by one-quarter.

This explains why there is a very critical speed at which an airplane will either fly or stall. The **rate** at which the air is pushed out of the way is **squared**. The difference in lift at fifty-six mph and sixty mph can be great.

## A = R

The third law that Newton described was  $A = R$ . Every action has an equal and opposite reaction. As a bullet hits an animal, the force against the animal by the bullet is acknowledged. But the animal also exerts an equal force on the bullet. It is slowed down from very high velocity to zero velocity.

A woodsman swings an axe at a tree. The axe exerts a force against the tree. The tree exerts a force against the axe.

Each action has an equal and opposite reaction. In the above examples the reaction is damaged flesh and severed wood.

## Friction

Friction is the resistance to motion between two surfaces that are in contact. We spend much of our lives trying to increase or decrease friction. Without friction it is impossible to light a match. If we don't avoid friction, a chainsaw might not last an afternoon. I have always regarded the understanding of friction as most important in the North. Since the wheel is very impractical without roads and hard surfaces, sleds and boats have been pushed and pulled in their respective seasons for thousands of years. Friction has made fires, hindered motion, and inserted itself into traditional life in a multitude of ways.

Friction has two causes:

1. Molecular attraction between two surfaces. The molecules actually form a slight electromagnetic bond with each other.
2. Rough surfaces interlock with each other. The rough spots on one surface mesh with the rough spots on the other. Material is ripped from each surface, and there is a constant chattering between the two materials.

There are two types of friction:

1. **Static friction**. Two surfaces are in contact, but are not moving against each other.
2. **Sliding (kinetic) friction**. Two surfaces are in contact and are moving against each other.

Static friction is greater than kinetic friction. When you get a sled going on the snow, there are two things you are overcoming:

- Inertia
- Static friction

As the sled is moving, inertia is overcome. There is kinetic friction, but kinetic friction is much less than static friction. It is easier to keep a sled moving than it is to get it in motion.

### **Pressure and weight influence friction**

While the friction of two surfaces can be measured, the friction can be increased or decreased by increasing or decreasing the weight or pressure between the two. If you drag a file cabinet across the floor, the friction will be reduced if the drawers are removed to reduce the pressure between the two sliding surfaces.

### **Different surfaces**

Different surfaces have different amounts of friction. An unpeeled log is very hard to drag through the woods. The same log peeled will drag easily. High and low friction.

There are times when we want to increase friction. We put sand or sawdust in paint on stairs to roughen the surface so we won't slip. Brakes on snowmachines are designed to induce friction to slow down the machine. The kinetic energy of the machine is changed to heat energy in the brake.

There are times when we try to avoid friction like in bearings and on sled runners.

### **Byproducts of friction**

Friction is a force acting against motion. There is no movement without friction on the earth. Some movements might minimize friction, but all movements involve some amount. The byproducts of friction are mostly heat but occasionally sound. Rub your hands together when they are cold. Do they get warm? This is a product of friction. Listen to a fishwheel that isn't lubricated. Can you hear it groan? This sound is the product of friction.

## **Surface Area**

Surface area is simply the area of an object that is exposed. A hand that is closed and one that is open are not different in any way except that the surface area is different. The mass, chemical composition, density, etc. are the same in both hands. Mittens and gloves cover the same hand, but their surface area is different.

Understanding surface area is important to us for three main reasons.

1. **Heat transfer and loss** are greatly influenced by the surface area exposed to the heat differences. A chainsaw head has fins to increase surface area to get rid of heat. A winter traveler curls his hand in his mittens to reduce the surface area that can lose heat.
2. The **pressure** exerted on a surface is described in terms of **pounds per square inch**. How many square inches is the force being exerted upon? Snowshoes increase the surface area a person's weight is distributed upon. A knife decreases the surface area a worker's efforts are distributed upon.
3. The surface area that is exposed where a **chemical reaction** can take place often determines **how rapidly the reaction can occur**. When we make shavings to start a fire in the morning, we are simply increasing the surface area upon which combustion can occur.

## Forms of Energy

There are six forms of energy available to the common person:

- Heat
- Light
- Chemical
- Kinetic (motion)
- Electrical
- Sound

Nuclear energy is not part of our daily lives in Alaska.

The six forms of energy can be converted, one to another. Some of the conversions are quite simple and common. Others are very difficult. Electricity converts easily to all of the other forms of energy. It would be quite difficult to convert sound to other forms of energy. This subject is addressed mostly in the section on generators.