

# Constructing A 6 Inch Reflector



Photos by George Tilton

The most popular amateur telescope, versatile 6-inch reflector is both portable and quite easy to use.

**T**HE 6-inch  $f/8$  Newtonian reflecting telescope is probably the most popular star gazing instrument in use by amateur astronomers. This is easily understood when we examine the instrument in more detail.

The "6-inch" refers to the diameter of the objective or main mirror of the telescope and thus affects the diameter of the main telescope tube. The figure " $f/8$ " is an optical expression derived from the ratio between the focal length and the diameter of the telescope mirror. In this case, the focal length is 48 inches or 8 times the mirror diameter of 6 inches.

The name "Newtonian" refers to the over-all design of this type of reflecting telescope in which rays from the objective or main mirror are focused onto a smaller mirror known as the "diagonal." The diagonal is set further up in the telescope tube at a  $45^\circ$  angle to the main mirror and the eyepiece. Its function is to reflect the focused rays from the objective into the eyepiece where they are refocused and

magnified for close viewing of the image.

It is enough to say that the Newtonian design is simply the most practical and least expensive for nonprofessional instruments. The word "reflecting," of course, distinguishes this scope from a *refractor* in which the light rays are "bent" through and focused behind a lens instead of being "bounced" away from and focused in front of a mirror.

Since the above description pretty well fixes the size of our reflector we can see one reason for its popularity. It's about the largest telescope you can comfortably carry. Larger reflecting instruments—up to 8 inches in diameter—are almost always semiportable, with usually a permanent mount and perhaps a transportable main tube. Much larger reflectors—those over 8 inches in mirror diameter—require the construction of a permanent observatory.

Another obvious reason for the popularity of Newtonian reflectors this size or smaller is price. To buy a completely finished and assembled 6-inch reflector of



Back view of mirror mount shows tension bolts for adjusting tilt. Clips hold mirror in the mount.

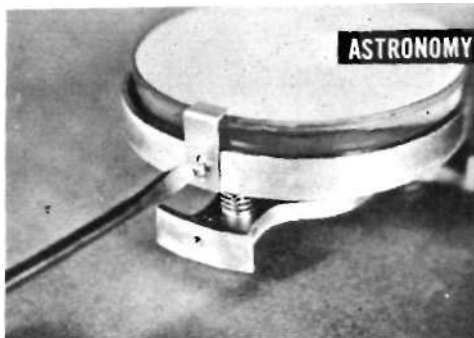

ASTRONOMY

Mirror is mounted tight in holding ring; add shims at edges if needed. Attach retaining clips.

Courtesy Edmund Scientific Co.

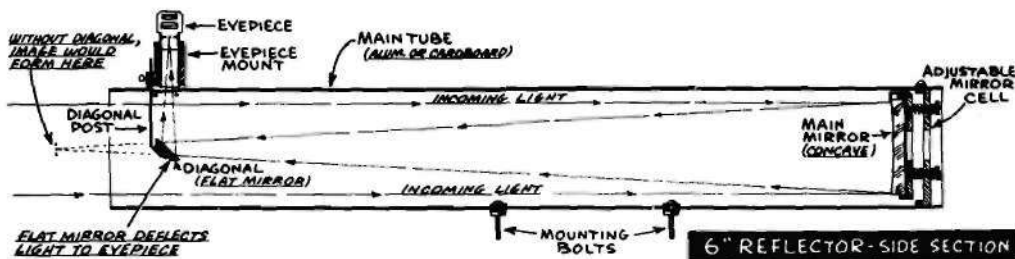

### SIX-INCH REFLECTOR — \$150

(as illustrated in this chapter — includes finished mirror and mount)

Pyrex Parabolic 6" Mirror	\$59.50
6" Mirror Mount	7.50
7" O.D. Aluminum Tube	15.00
Eye-piece Mount	8.50
Elliptical Mirror Diagonal	3.75
Mirror Diagonal Holder	1.00
Equatorial Mount and Tripod	39.50
Kellner Eyepiece 28 mm F.L.	7.95
6-Power Finder Scope, Bracket	8.00

(Above prices are quoted by Edmund Scientific Co., Barrington, New Jersey)

### SIX-INCH REFLECTOR — \$27

(Economy Kit—with unground mirror blank, and minus telescope mount)

6" Mirror Kit with Eyepiece-lenses and mirror diagonal	\$11.95
6" Mirror Mount	7.50
7 $\frac{3}{8}$ " O.D. Cardboard Tube	4.00
Eye-piece Tubing	.50
Eye-piece Mount	2.50
Diagonal Holder	1.00

(Above prices are quoted by Edmund Scientific Co., Barrington, New Jersey)

this type would cost you about \$200. Prices of larger instruments soar drastically for the finished product. You can, however, own a high quality instrument for a fraction of the price if you build or assemble your own telescope. The object of this chapter is to help you do just that.

**REFLECTOR TELESCOPE KITS**—You will note that there are two lists of parts printed on these pages. There is an

economy kit of parts for around \$27 and another kit, illustrated here, for \$150. Why the large difference? Primarily, it is the difference between buying a finished parabolic mirror and grinding your own. Grinding astronomical mirrors is a fascinating hobby in itself. It does, however, require a healthy degree of skill and patience. We have chosen, therefore, to illustrate the assembly of scope parts that requires only the use of simple hand tools and a minimum of time. If you elect to grind your own mirror, the telescope assembly instructions shown here will still apply.

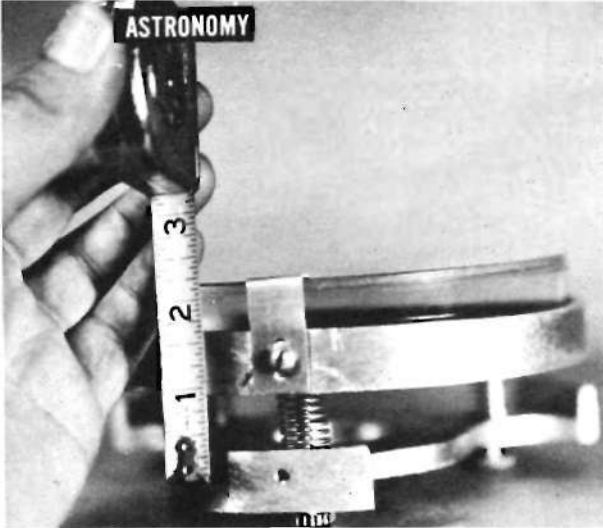

Measure distance from mounting hole to mirror surface then store the mirror until final assembly.



Drill mirror mount holes 1-2" from end of main tube. Mirror must be mounted squarely in the tube.

Check exact FL of mirror and subtract sum of "A" and "B" (see text) to find the eyepiece location.

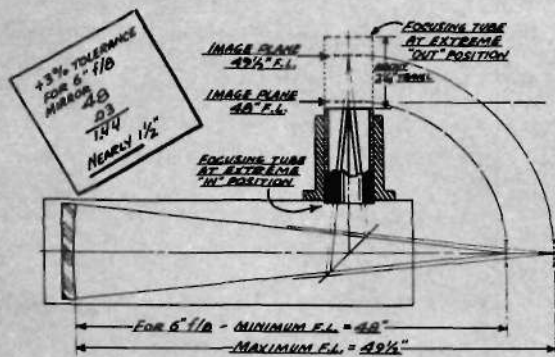

Courtesy Edmund Scientific Co.

Eyepiece must be located exactly by measuring from point representing front surface of mirror.

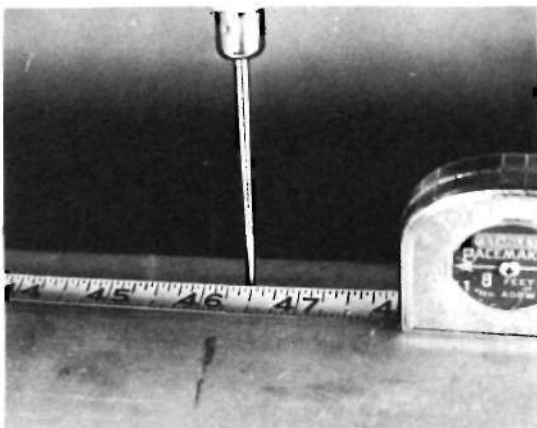

Draw a circle with diameter barely larger than diameter of the travelling eyepiece tube in mount.

Drill a pilot hole and cut out circle. Use a large bit or an adjustable hole cutter if available.

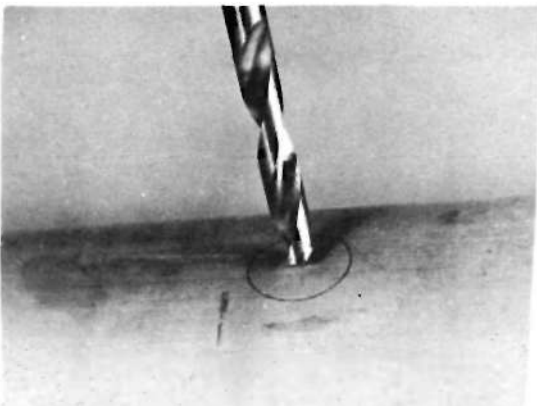
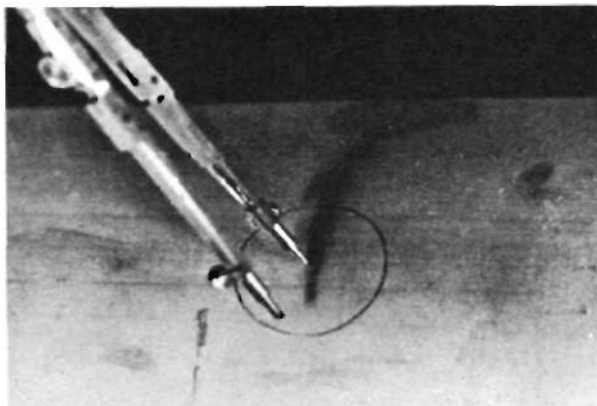

Another price factor is the inclusion of a good equatorial mount. You can build your own simple mount or purchase a less expensive altazimuth mount. But we highly recommend an equatorial mount for the serious star gazer. As you become more and more advanced in the science of astronomy, you will need an equatorial mount and you can save a considerable amount of money if you purchase one at the start.

With an equatorial mount you can use setting circles—accessories that allow you to "dial" the exact sky object you want to see by checking its location in a star atlas. A clock drive—essential for any type of asti'ography more complicated than snapping a picture of the moon—also requires an equatorial mount.

Having acquired your telescope parts, you are ready to go to work. First, let's

examine our assemblage of optical equipment.

Basically, we have a big mirror and its mount that will occupy the lower end of a large aluminum tube and a small mirror and eyepiece holder that will occupy the upper end. The correct placement of these parts in the tube is our only major assembly problem and the key to this problem is the focal length of the main mirror.

Our large mirror, being concave, will converge light rays from the sky to a point in front of it—the focal point. A small, concentrated image will form at this point, which your eyepiece, in turn, will enlarge to the view you see when you actually observe the heavens. The small diagonal

Mousetail hack saw blade with pistol grip can be used to cut hole. Aluminum is easy to work.

Alter rough cutting, smooth to perfect circle with semiound file. Check with the eyepiece rube.

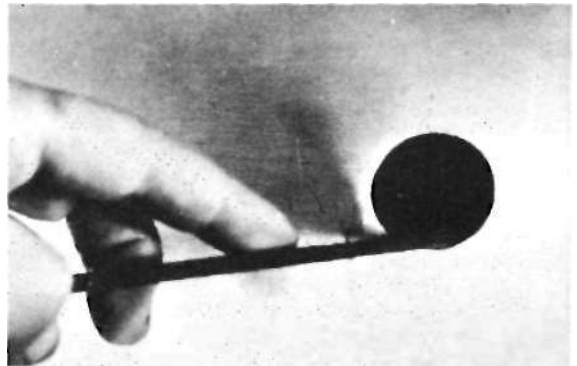
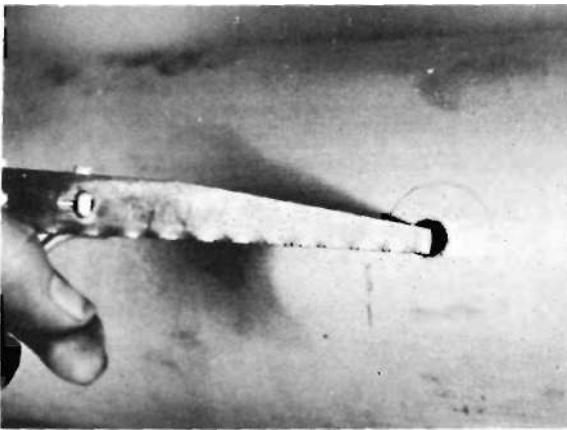

Circle is notched for rack on eyepiece tube and holes are drilled for bolts holding the mount.

Finished cutout for eyepiece mount. The hole at middle left is for the diagonal mirror holder.

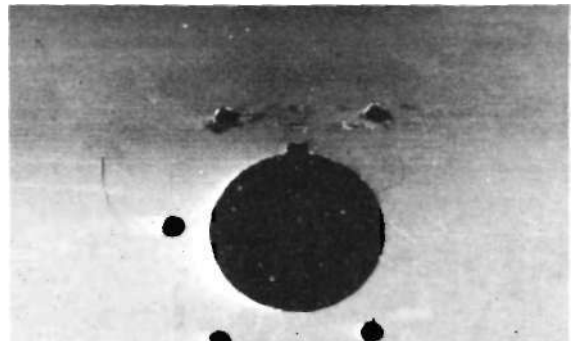
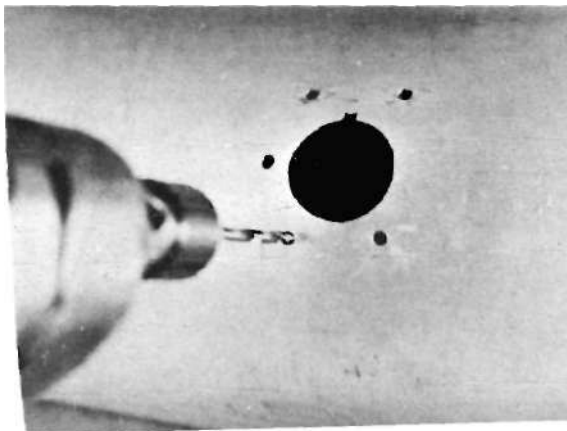

Check fit of eyepiece mount to holes drilled. Make any corrections before painting the main tube.

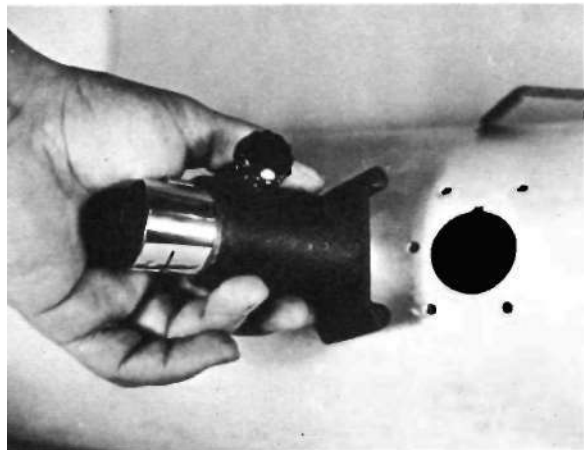

Diagonal mirror is cemented to holder while protected by tissue. Use a strong glue like epoxy.

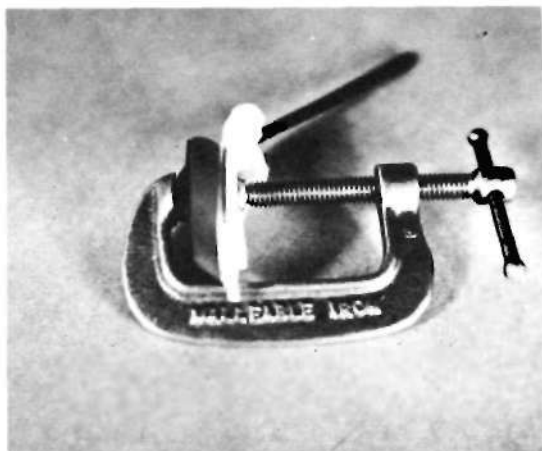

Completed diagonal mirror cemented to holder is shown below. Next step is to insert in mount.

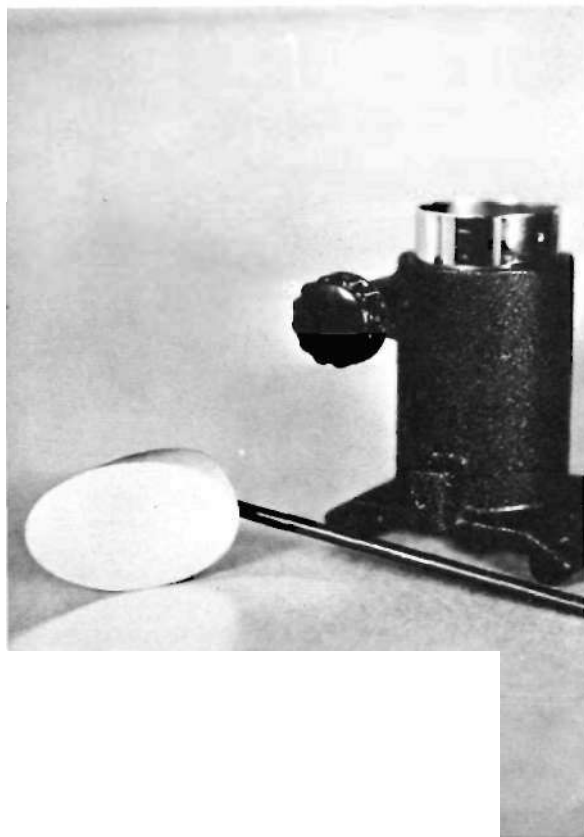

Diagonal mirror holder extends through rack and is held in place by a set screw on eyepiece mount.

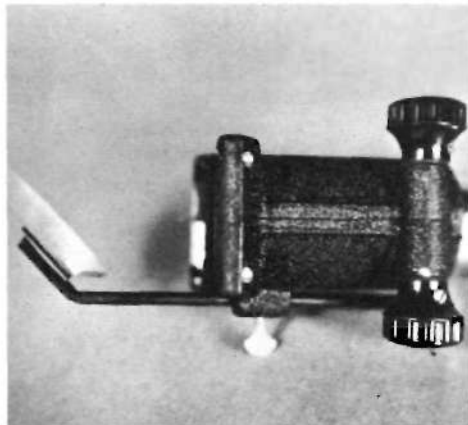

Next step is to drill holes in scope tube to secure it to the carriage of the equatorial mount.

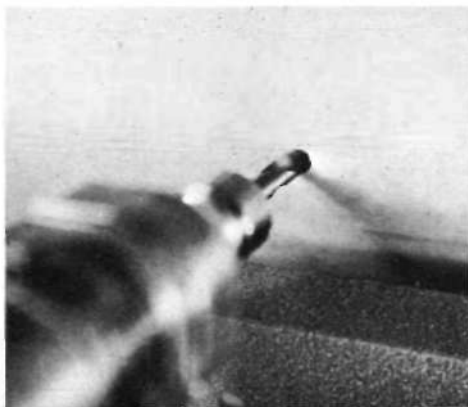

mirror catches the image at this point and reflects it into the eyepiece tube. To do this, the focal point must be placed just outside the eyepiece tube of the eyepiece mount when this tube is at its furthest "in" position. The reason for this location is that eyepieces, having their own focal points of varying lengths, must have room to focus on the image or focal point formed by the big mirror. A short focal length (high power) eyepiece will focus close to this "in" position, but longer focal length (low power) eyepieces will need more "out" travel and will focus when the eyepiece tube is extended to nearly its full length or furthest "out" position.

Now we know where we want the focal point of the main mirror but have to figure out how to get it there. Before proceeding, it should be mentioned that manufactured mirrors may vary slightly in focal length from the given figure. A tolerance of about

an inch and a half is generally allowed. A 48-inch focal length mirror may actually be of 49-inch f.L., therefore. A small sticker on the back of the mirror usually gives the exact figure, *which you should check carefully*. The main tube should be slightly longer than this focal length. We used a 5-foot tube, but this could have been cut to 50 inches.

**BEFORE DRILLING** into your tube, place the main mirror in its mount. Now measure the distance from any one mounting hole on the mirror-mount to the front edge of the mirror. Jot this figure down for future reference. You may now put your mirror away in a safe place as you will not need it

**Although the location of the finder scope is not critical, it must be parallel to the main tube.**

**Locate and drill holes for finder bracket at point out of the way of the main scope eyepiece.**

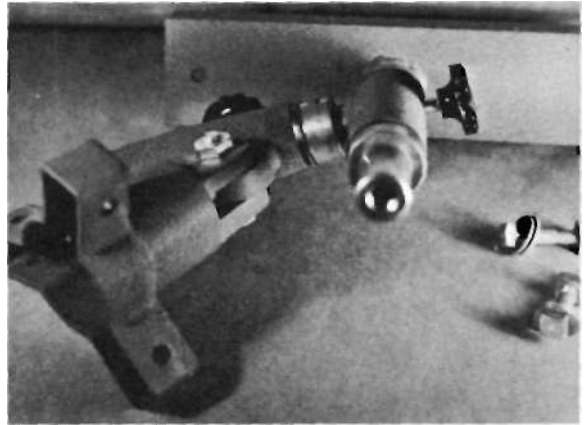
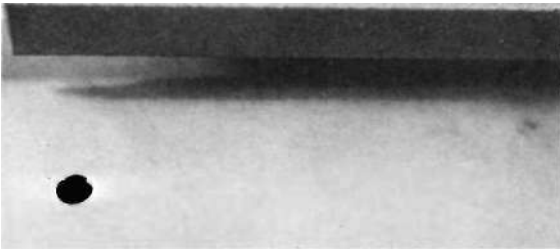

**Line up mount and tube holes. Mount must be on side of tube opposite eyepiece for best viewing.**

**Main tube is tightly attached to the head of equatorial mount using  $\frac{1}{2}$ " dia. 2" stove bolts.**

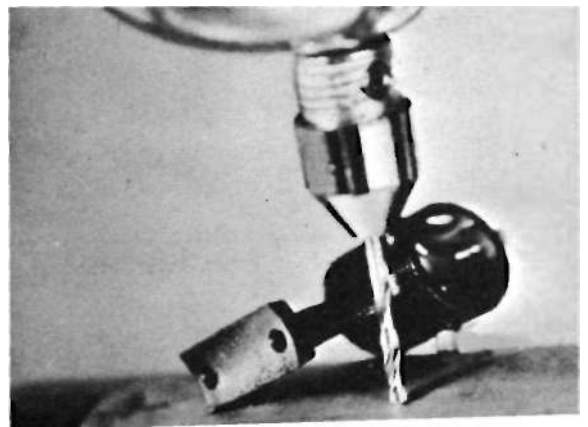
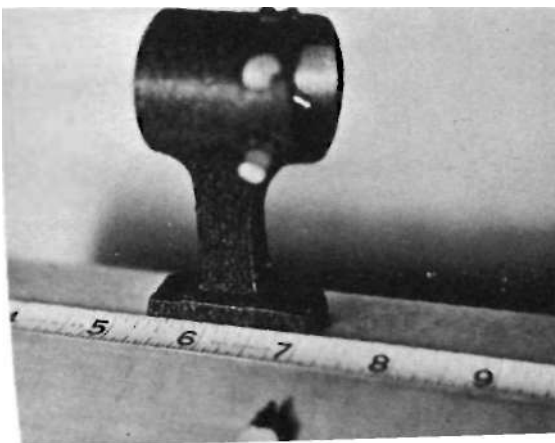

Bracket for the finder is shown with mounting bolts. Three set screws permit finder adjustment.

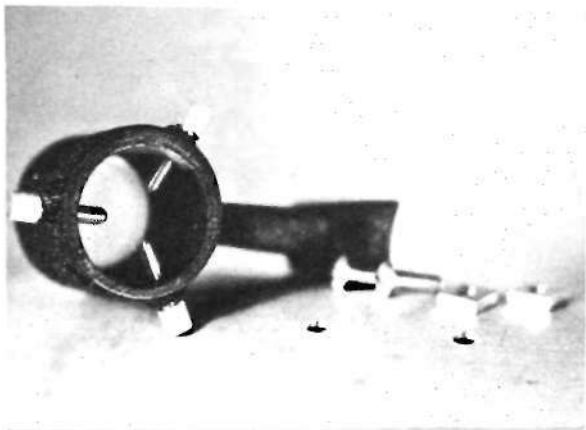

Finder telescope is simply slipped into mounting bracket and adjusted for the best operation.



Equatorial mount (parts shown below) is better for observing than an altazimuth or other type.

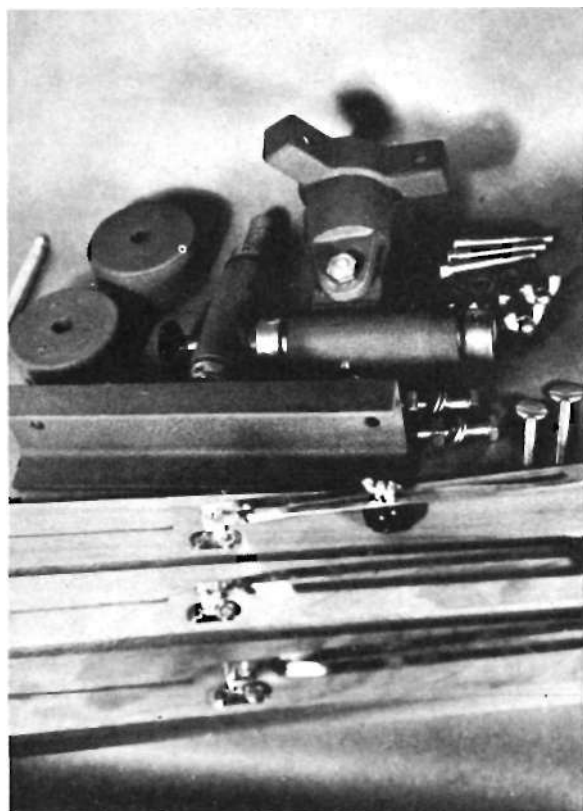

A sturdy tripod is absolutely essential for observing; vibration makes any viewing impossible.

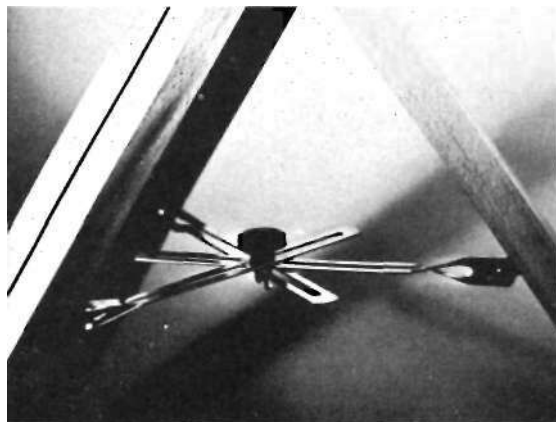

Adjusting knob on legs of tripod makes it possible to level the head on a variety of terrain.

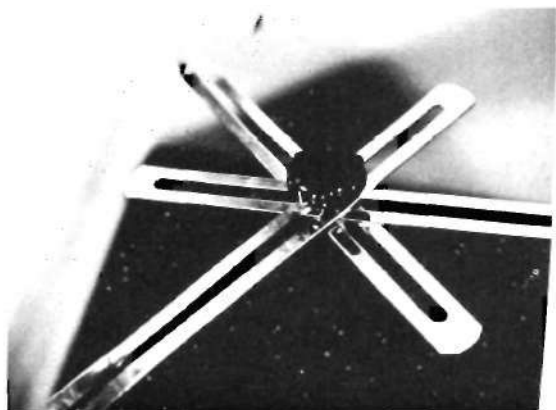



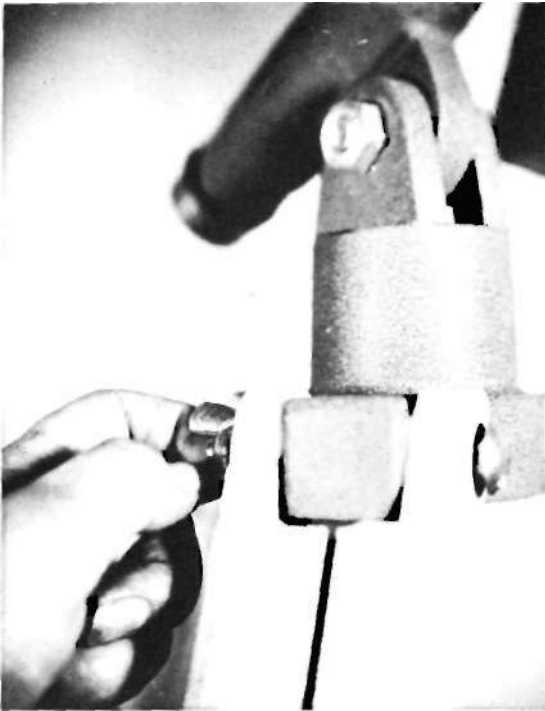

The equatorial mount is bolted to tripod. It permits scope to be set parallel to the earth's axis.

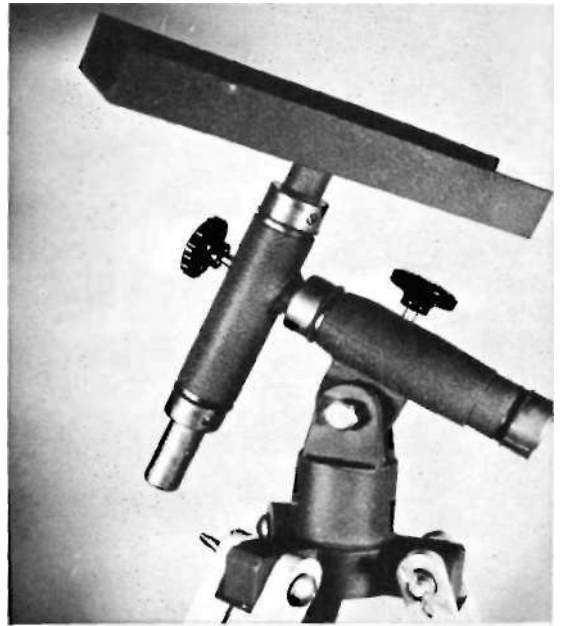

Completed equatorial mount looks like this. The scope carriage must be parallel to polar axis.

Polar axis must be set for latitude of observer. Check the mount head to see that it is level first.

Set a protractor at your local angle of latitude and clamp it to an ordinary carpenter's level-

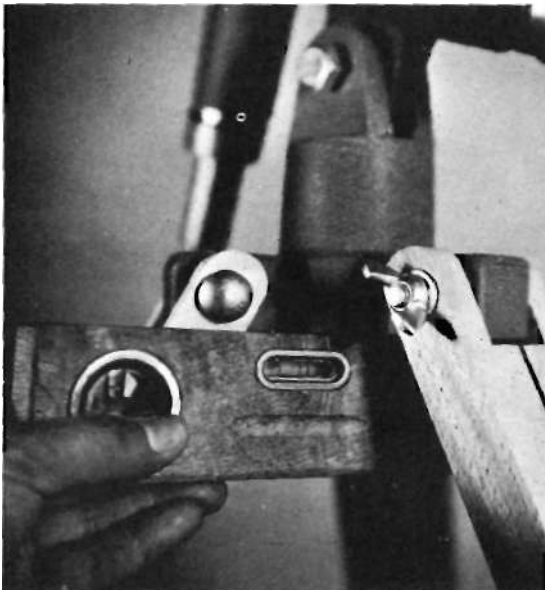





Check your latitude before adjusting polar axis as shown here and in the diagram at the right.

After adjustment, balancing weights are attached to the declination axis shaft on the equatorial.

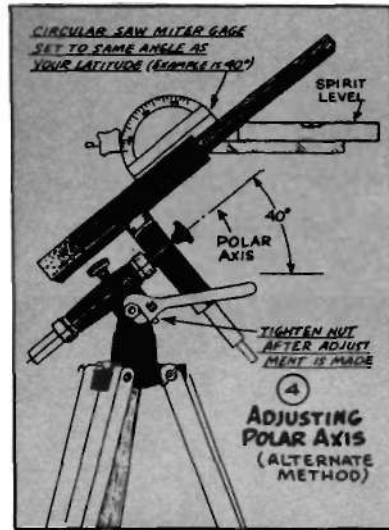

Courtesy Edmund Scientific Co.

After painting, mount scope on carriage with strong bolts. Use washers and tighten bolts evenly.

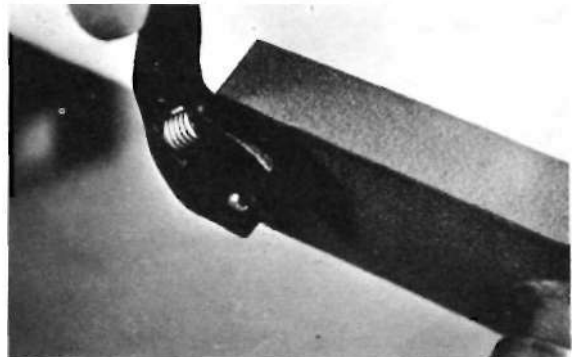

Completed equatorial mount on tripod with scope attached gives sturdy platform for best viewing.

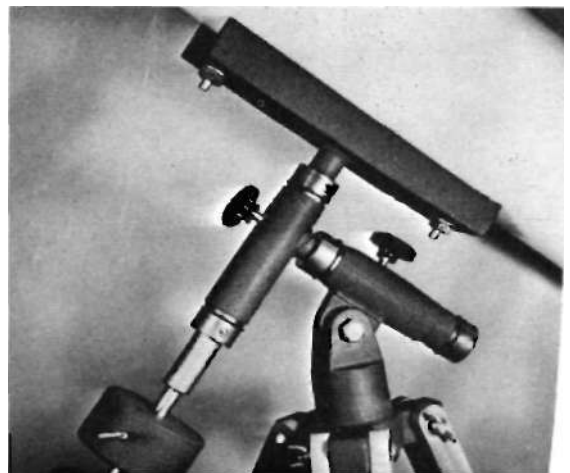

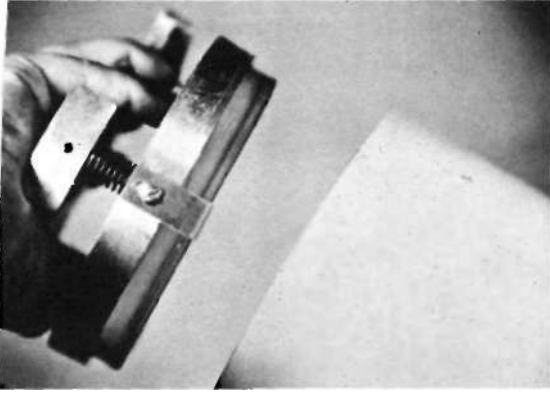

Secure the telescope mirror in its mount before bolting it into position at lower end of tube.

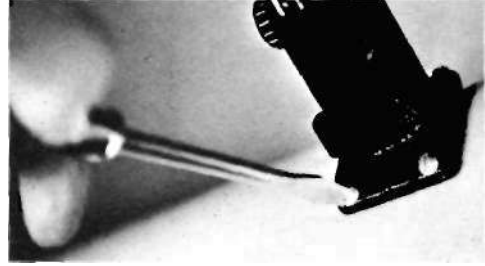

Attach the eyepiece holder to the tube. From inside the tube, next insert the diagonal mirror.

again until ready for the final assembly.

Next, drill the holes in the big tube that will hold your mirror-mount. The exact distance from the lower end of the tube is not critical; one of two inches is sufficient. *It is essential, however, that the mirror sits squarely in the tube.* Now, from any one of these mounting holes, measure along the tube the distance you have jotted down. *Mark this point with great care.* It shows you the position the front surface of your main mirror will occupy within the tube and it is *the point from which you will measure to locate the position of your eyepiece mount.*

Now for some simple, but vital, arithmetic. Measure the outside diameter of your main tube (in this case, 7 inches) and divide by 2. Let's call this figure "A." Next, place the rack-and-pinion eyepiece mount on the exterior of the main tube and measure the distance from the surface of the main tube to a point about a quarter of an inch above the end of the eyepiece tube at its fullest "in" position. Let's call this measured number figure "B." Add figure "A" and figure "B." Then subtract the sum of these two figures from the focal length of your main mirror. That's the end of your arithmetic. Take the final figure and measure along your main tube from the point you jotted down and marked with such great care as described in the preceding paragraph. This point is the exact center of a circular hole you will cut out of the main tube to receive the moving tube of your eyepiece rack-and-pinion mount.

Read all of the above paragraph over before doing any of the work on your telescope tube. *It is the most critical step in the whole assembly of your instrument.*

Further assembly is relatively simple and can be done by closely following the step-by-step photographs. Here are a few pointers:

Remember that when drilling holes to attach the main tube to the equatorial mount that these holes should be on just the opposite side of the main tube from the eyepiece rack-and-pinion mount holes. This will give you the most comfortable position when observing with your eyepieces for most sections of the sky. You may center the main tube on the carriage of your equatorial mount or find a more delicate balance by assembling all optical parts and locating a fulcrum where the entire assembly balances.

Remember to level the head of the equatorial mount before setting the polar axis to an angle equal to your own latitude.

Paint the exterior of your scope any color *but the interior color must be the flattest optical black possible.* Exterior is perhaps most often a clear white, which is easiest to see on a dark night.

Collimation of your optical system when completely assembled can be done in a variety of ways. Sketches in this chapter show a simple, effective method.

Weights on the declination axis of the equatorial mount may be adjusted to balance the main tube assembly so that it swings freely on the polar axis. •

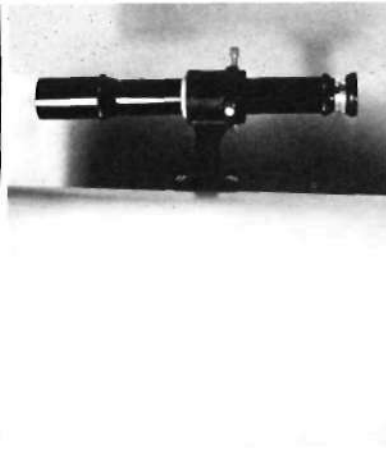
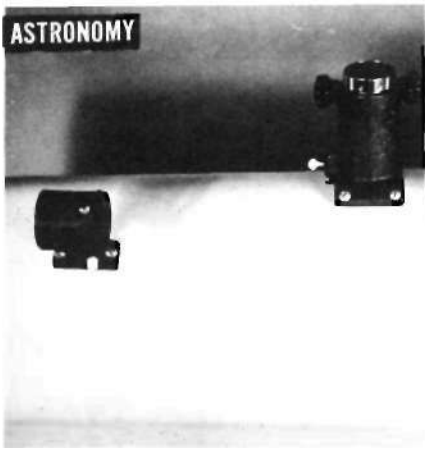
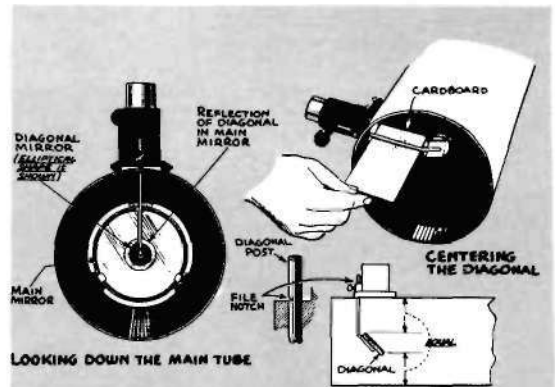

Photo shows one possible location for finder where it won't interfere with operation of regular eyepiece. Finder bracket is left, the eyepiece at right.

Finder scope is inserted in place parallel to main scope tube as shown here. Finder is centered with the main scope optics by means of the three setscrews shown.

Final step in adjusting the telescope finder is to focus it on an object at infinity. The finder is indispensable in aiming the main scope for observation purposes.

The small diagonal mirror must be exactly centered in the main tube. Follow the sketch (right).



Adjust tension screws to center main mirror. Reflection of the diagonal serves as a guide (right).

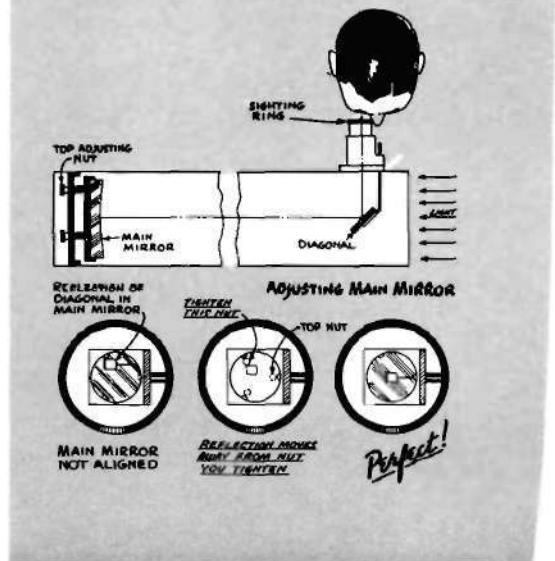

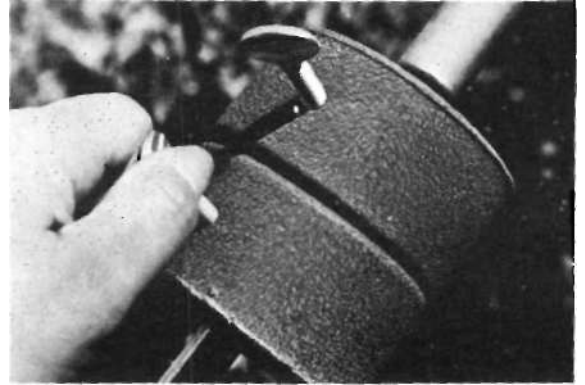
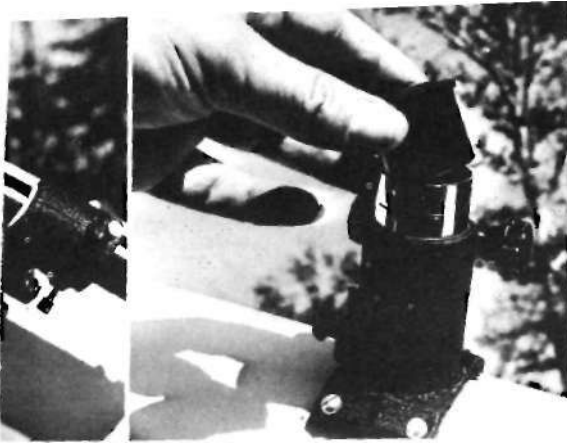

Final steps include insertion of eyepiece (above) and adjustment of counterbalance weights (right) to offset weight of main tube and optics. Entire assembly should swing freely on the polar axis.



Finished high-quality 6-inch reflector looks like this. In addition to being a popular instrument for the serious observer, scope can be used for astrophotography with addition of clock drive and camera assembly.

