CHAPTER 4

FISHING OPERATIONS

A.	CHOOSING THE FISHING GROUND	52
B.	FISHING INSIDE THE REEF	53
C.	FISHING OUTSIDE THE REEF	54
D.	CHECKING THE DEPTH	56
E.	ANCHORING UP	58
F.	POSITIONING THE BOAT AT ANCHOR	60
G.	HOOKING AND HAULING FISH	62
H.	BOATING THE FISH	64
I.	HAULING THE ANCHOR	66
J.	DRIFTING WITH WIND AND CURRENT	68

SECTION 4A: CHOOSING THE FISHING GROUND

The fishing trip should always be planned ahead, so that the fishing area chosen allows the fisherman to take advantage of the weather, sea condition, tide and seasons.

Using charts

Many fishermen already have their favourite fishing spots and can navigate to them using some of the techniques described in section 1C. For those wanting to scout out new grounds or explore unknown areas, marine charts exist for most locations in the Pacific. Some areas are covered in a lot more detail than others, but in all cases charts give information on the locations of reefs and islands, depths, and sometimes currents. This information can be used by the fishermen to pick promising spots. Always consult charts before setting off, and take them with you on the boat in case the weather or other fishing conditions change. Your nearest Fisheries office, marine department, navy base or coastguard station can help you obtain charts of your area.

Use marine charts on shore and on the boat

A marine chart provides information on...

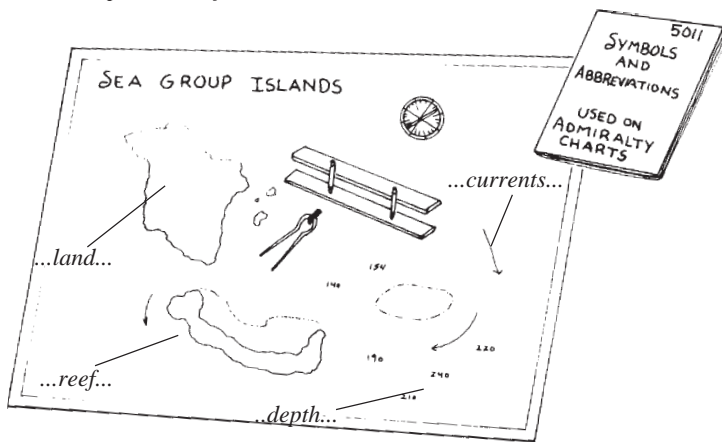

...and many other things useful to a deep-bottom fisherman

Charts can be kept dry onboard inside a length of PVC pipe...

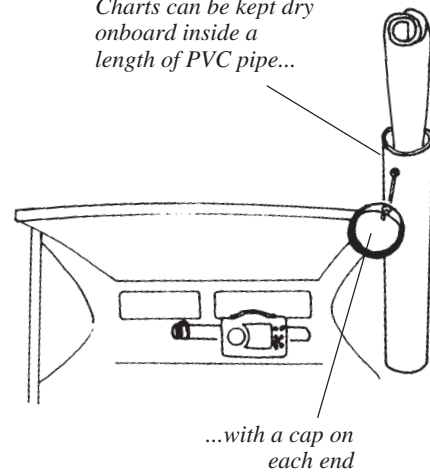

The soundings on a marine chart give information on the water depth, the steepness of the slope of the sea floor, and whether the bottom is rough and craggy or smooth and even. This information allows the fisherman to guess at possible good fishing sites, which he can then check out more thoroughly using an echo-sounder, or by actual fishing. More information on understanding echo-sounder readings is given in section 4D.

Allowing for the weather

Always check the weather before going fishing. Try to get the latest weather forecast from the radio or newspaper. Plan to fish in a location which will give you shelter from the prevailing wind, and which allows you to run to safety if the weather worsens.

Wind

If the wind is blowing more than about five knots it will be the main factor controlling the position of the boat while fishing at anchor. Plan your fishing trip so that you can take advantage of the prevailing wind and use it to fish the depth or area you want. More detail on using wind and current to position the boat is given in section 4F.

Before setting off, get the weather forecast...

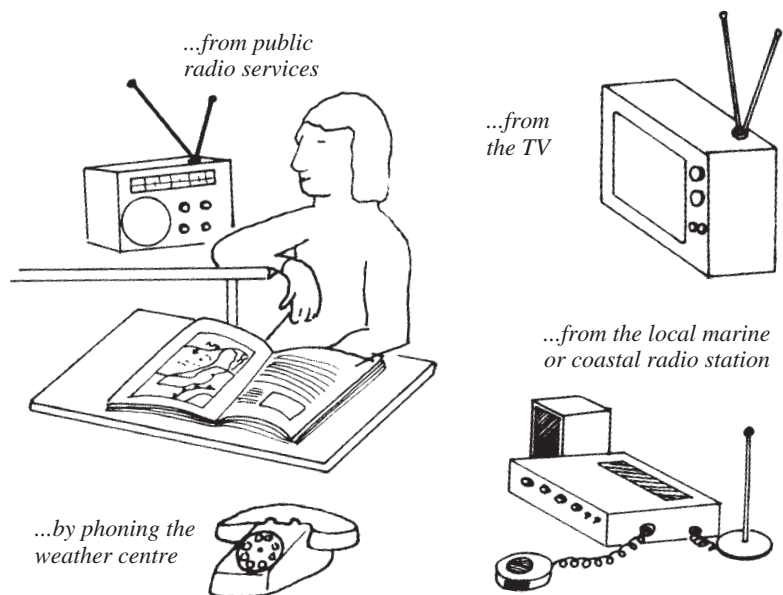

SECTION 4B: FISHING INSIDE THE REEF

Bottom fishing inside barrier reefs is not really 'deep-bottom' fishing, since the water depth very seldom exceeds 100 m, and true deep-bottom species are not caught. Nevertheless, the same techniques can be used and will often give good catches.

Lagoon waters

Fishing in the waters of the lagoon has a number of attractions. It usually involves less travelling time, and allows a quicker run for home if the weather looks uncertain. Anchoring and fishing tend to be easier because of the shallower depths, and the fish caught are normally well known and acceptable among the local population. An experienced fisherman who knows the area can take advantage of spawning runs and other seasonal events to improve his catches.

However, there are disadvantages to lagoon fishing. In many areas, fishing pressure is heavy because most local fishermen fish in the lagoon. Fish tend to be smaller on average than those taken outside the reef. In some areas, certain species may be dangerous to eat or sell due to the possibility of ciguatera poisoning, particularly the larger fish, which may make up a big part of the catch weight.

Most of the catch when lagoon fishing will consist of small snappers, emperors and groupers, mainly less than 3 kg in weight. Although the odd bigger fish will also be caught from time to time, it is sensible to use fairly light gear when lagoon fishing so as to be able to catch the smaller size fish. Handlines of 50–70 kg test nylon monofilament, or a braided line of the same strength, are often more practical for shallow water fishing than handreels. A 25–50 kg test monofilament terminal rig with small-sized hooks, such as size 9 or 7 tuna circles, is good tackle for this situation. If small barracuda or other fish with sharp teeth start to bite off the hooks, then change to a similar strength terminal rig made from light cable. This will prevent gear loss, but the cable trace will probably catch fewer fish than the nylon.

Lagoon waters may be overcrowded with too many fishermen

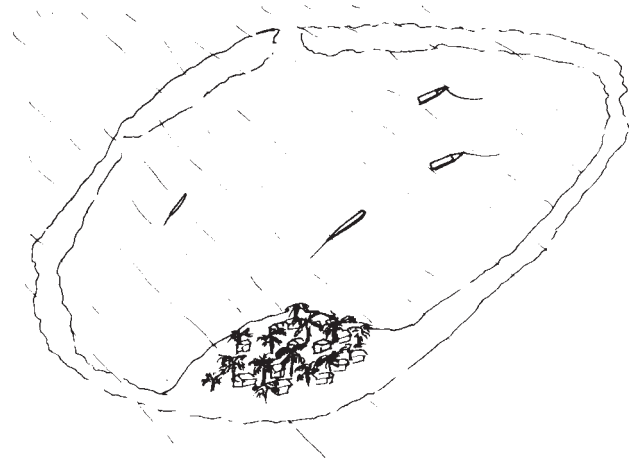

Passes

Bottom fishing close to breaks or passes in the reef is a compromise between 'true' deep-bottom fishing, and lagoon fishing. The safety factor is higher inside the reef than outside, but larger fish, and species more normally found outside the reef, can often be caught. Ciguatera poisoning can still be a problem, particularly among the larger fish.

Fishing in strong tidal currents close to reef passages...

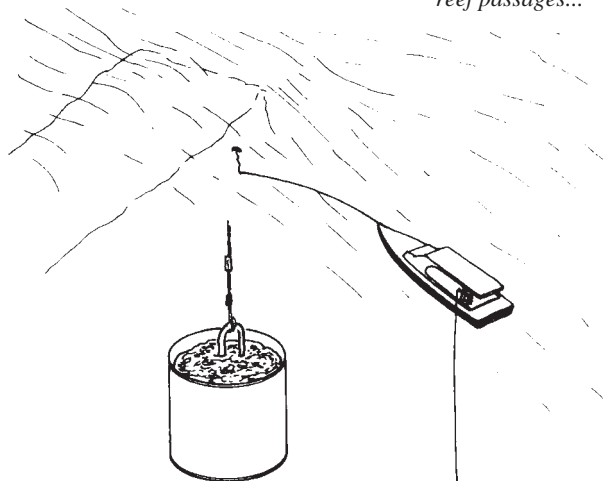

...may need extra heavy weights to get the gear to the bottom

When fishing in or close to passes, the catch will consist of some of the larger snapper, emperor and grouper species, the exact types depending on fishing depth and the distance from the true outer reef zone. Green jobfish are often caught in numbers in this zone, and so are some pelagic species, such as yellowfin tuna and Spanish mackerel, especially at night. Because of the presence of these larger fish, heavier gear is required for fishing close to passes. Cable terminal gear is normally used, 50–100 kg test and rigged with size 7, 6 or 5 tuna circle hooks or equivalent.

One problem with fishing close to reef passes is that tidal currents can be very strong and can make fishing difficult. It may be necessary to use extra heavy weights on the terminal rigs just to get the gear to the bottom in the face of the strong tidal flow.

SECTION 4C: FISHING OUTSIDE THE REEF

'True' deep-bottom fishing takes place outside the barrier reef. Depths of 400 m or more can be fished and many of the species caught are found only below 150 or 200 m.

The reef slope

Beyond the area where ocean swells break on the reef, the sea bed slopes down rapidly to the ocean floor, which may be many hundreds or perhaps thousands of metres deep. The slope is generally not so steep closer to the surface, but changes to a steeper gradient at a depth often around 80–100 m. Below this depth the slope may be almost vertical or it may be relatively gradual, with ledges or areas of even depth. The sea floor may be smooth and sandy or muddy, or it may be rocky, or very rough, with underwater hills and valleys.

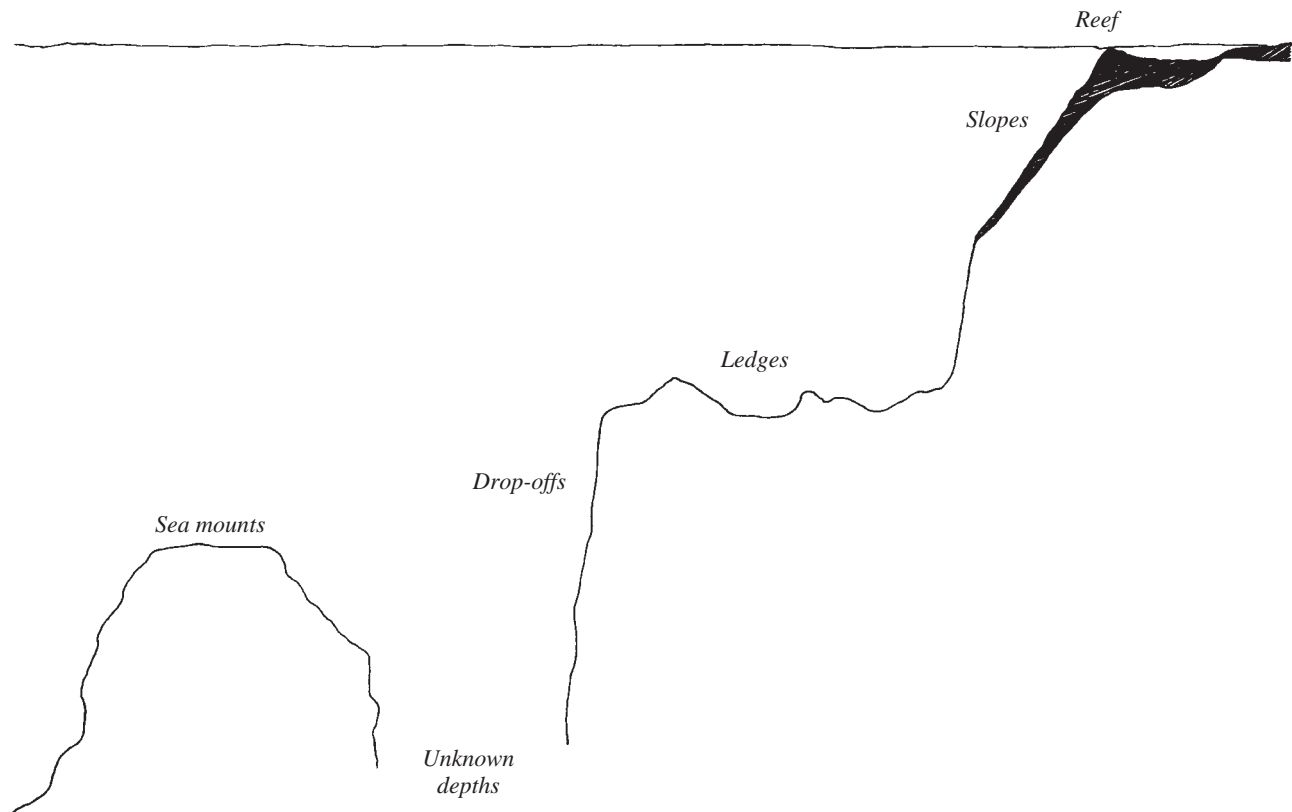

Deep-bottom fishing covers the whole range of the slope, from the upper levels of 40 m or less, to the maximum fishable depth, which under the right conditions may be up to 600 m (although more usually 400 m).

Usually the fisherman aims to fish a particular depth or depth range which he knows (or hopes) will be productive. To do this, he tries to anchor or drift so that the action of wind or current will keep his boat in waters of the desired depth (see sections 4F). Once there, fishing goes ahead but it is almost sure that the lines fish in a range of depths, as the boat swings on its anchor or drifts over bottom irregularities.

Fishing the reef slope, there is always the possibility of hooking very large powerful fish or those with sharp teeth. It is therefore usual to use terminal gear made from heavy cable, and medium to large hooks, at least when exploring new areas. In places where large or toothy fish are rare, smaller hooks and nylon traces can be used and these will generally be more effective than the heavier gear.

When deep-bottom fishing, the boat almost always swings around....

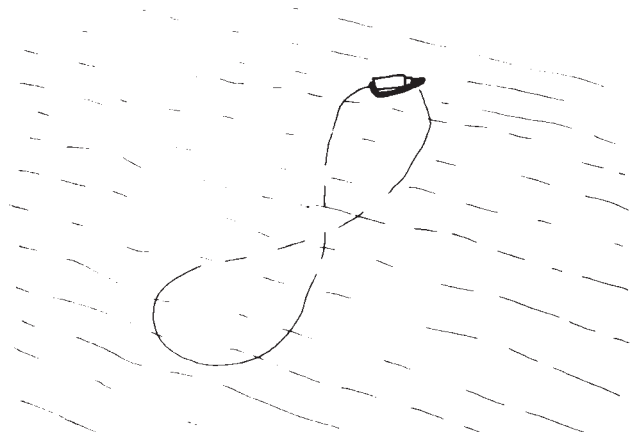

...so the lines end up by fishing in a variety of depths

Sea-mounts

Sea-mounts are underwater banks or mountains, sometimes very large. Fishing these areas is the same, in principle, as fishing the reef slope. The main difference is that, since there is no emerging reef or land, it is easier to take advantage of wind and current to anchor in a place that will allow the boat to drop back onto the desired fishing depth.

Currents over and around seamounts can be strong and complicated.....

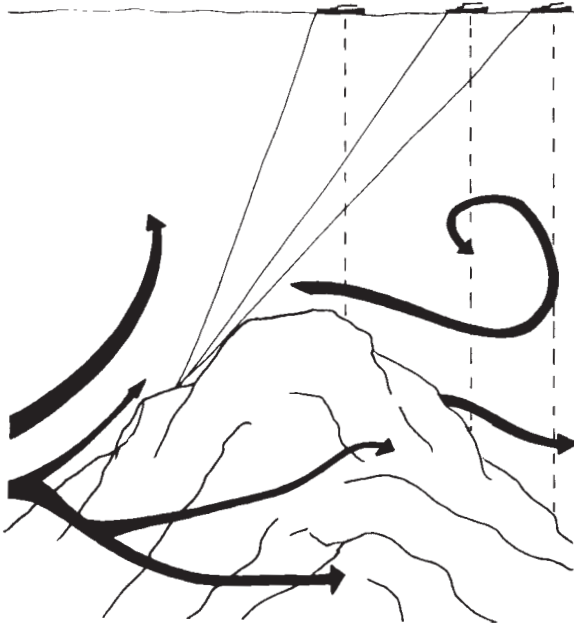

The species of fish caught will depend very much on the fishing depth, the sea bed type, the slope of the sea floor, and other factors. The species composition of the catch from two apparently similar seamounts can be quite different, even when they are close to each other. Fishing itself sometimes has a rapid effect on the fish population on seamounts, with changes in the species composition being noticed once the seamount is found and becomes more heavily fished.

Currents over and around sea-mounts can be very strong and complex. Extra heavy anchoring gear and heavy fishing weights may be needed to overcome their effects.

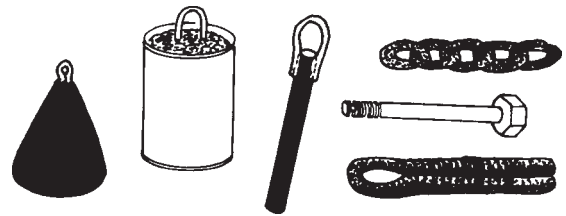

...and may dictate the use of extra-heavy fishing weights

Fishing depth

In general, when exploring a new fishing area, it pays to anchor in relatively shallow water and start fishing somewhere around the 80 m mark. Fishing is easier in shallower water, and if you can catch enough fish there, then there is no need to take on the extra work of fishing deeper. If this zone does not seem to be productive, the anchor rope can be slacked off, allowing the boat to move to a deeper area. In this way the fisherman can work deeper bit by bit until the fishing is good.

Normally fishing starts in 80 m or so depth...

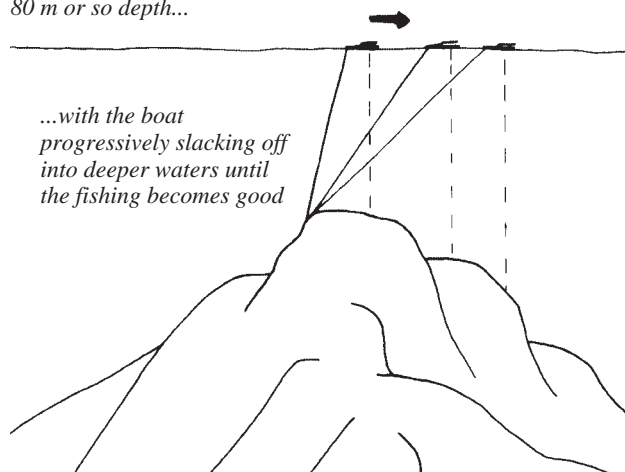

The most productive zone is normally from 150–250 m

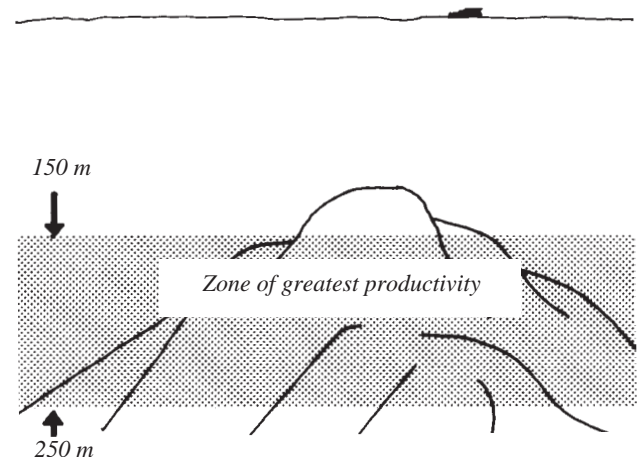

The most productive fishing depth in many locations lies somewhere between 150 and 250 metres, although good catch rates may be taken outside this range. Generally speaking, there are greater numbers of smaller fish in the upper parts of the fishable depth range, with smaller numbers of larger fish in the deeper parts. For this reason, it is usual to use larger hooks when fishing deeper. The best fishing depth depends on the location and the type of fish you want to catch. Section 4F gives more information on how to get yourself into the right fishing depth.

SECTION 4D: CHECKING THE DEPTH

It is important to have a good idea of the depth when anchoring up to start fishing, and to keep a close watch while the fishing continues. In this way the fisherman quickly discovers which are the most productive fishing depths, and can return if the boat drifts into the wrong depths.

Using handreels

If the boat is equipped with fishing reels of any kind, the fishing depth can be measured by counting the number of times the reel turns before the sinker hits bottom. You need to know how much line the reel takes up or pays out each turn. This can be easily measured by just unwrapping one turn and measuring it with a tape measure one day while on shore. Most wooden handreels take up between 1 and 1.5 metres per turn. To estimate the depth just multiply the number of turns needed to touch bottom by the length of one turn.

Depth can be estimated by counting the turns of a handreel...

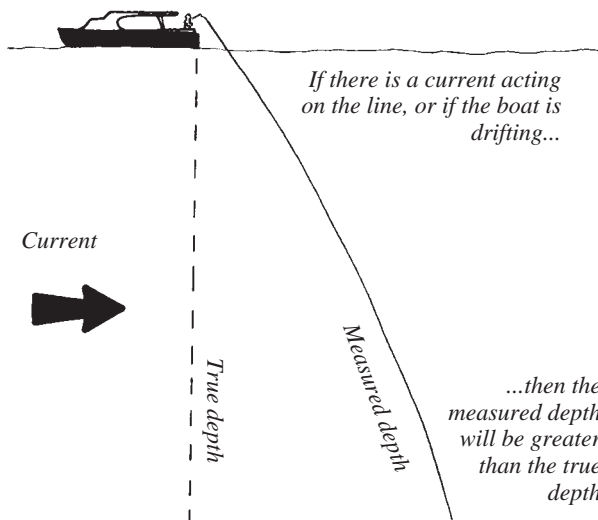
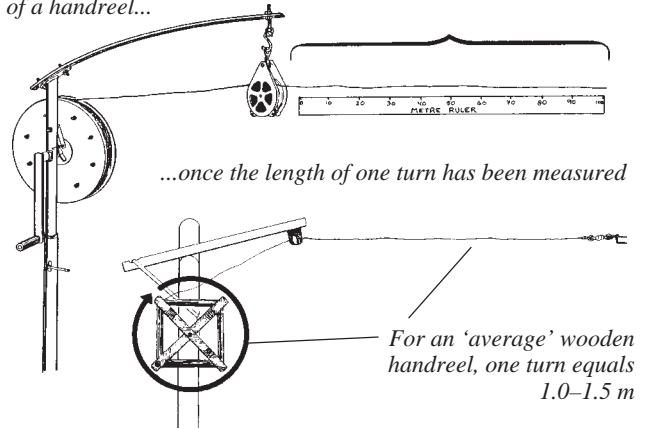

Allowing for current

When using any type of line to measure the depth, the current will act on the line to pull it away from the vertical. This means you have to pay out extra line to allow for the current. If the boat is swinging or drifting, this may add further to the amount of extra line you have to pay out. Especially when drift fishing, or in a strong current, the line may hang in a curve, making it hard to judge the angle of the line, or the water depth.

When estimating depth using a fishing line, therefore, remember that the true depth cannot be any greater than the measured depth, but may be less, possibly by a great deal. If the fishing line is at a 45° angle to the vertical, then the true depth will be only 70% of the measured depth. The nearer the line is to the vertical, the less will be the error.

Rugged bottom

Using fishing lines to measure depth can also give a false reading if you are fishing over a sea floor that has a lot of vertical relief. Depending on the seabed shape, the boat could be anchored in one depth, lying in another, and fishing in a third. The effect of current and vessel swing on the fishing line makes it very difficult to estimate the true fishing depth under these circumstances.

The shape of the seafloor can affect the depth estimate...

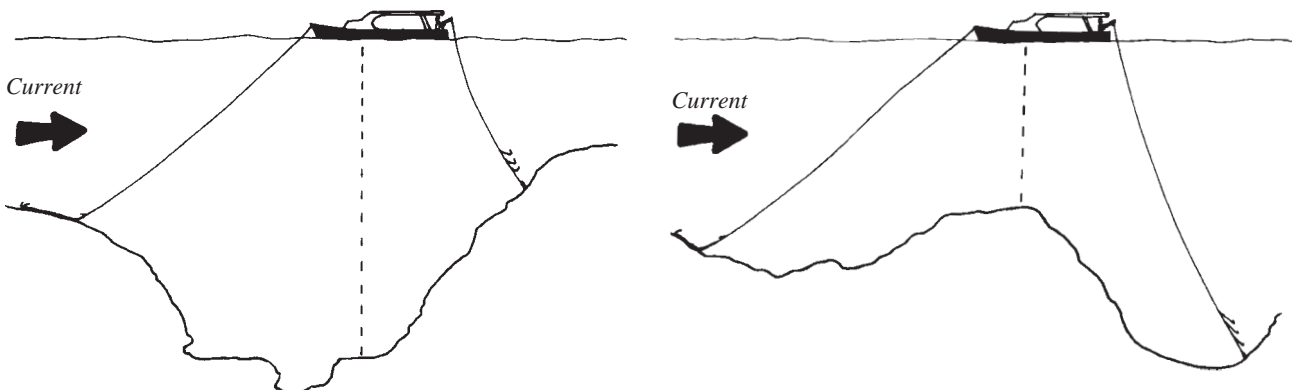

...in these diagrams anchoring depth, depth under boat, true fishing depth, and measured fishing depth are all different

Echo-sounder

The best way of all to measure depth quickly and accurately is to purchase an echo-sounder. Unfortunately, the cost of echo-sounders suitable for small boats in Pacific locations is quite high (up to 1,000 US dollars or more, depending on model, exchange rates, local import duties, etc.). This puts them out of the reach of many fishermen. However, for the commercial operator, an echo-sounder is a valuable asset which soon repays the owner's investment in fishing time gained.

Section 3F provides basic information on echo-sounders. Knowing a little about how the echo sounder signal 'reads' its target helps the fisherman get the maximum information from the depth display or paper trace.

The signal

The sound signal travels out from the transducer in all directions. In order to avoid receiving unwanted echoes coming back from all these directions, the transducer is focussed so as to receive mainly those echoes coming more or less vertically upwards from the sea floor. The transducer's sensitive zone takes the shape of a cone whose angle is usually around 20° , although this varies between echo sounder models. The sounder therefore picks up mainly those echoes which are bounced back from within its cone of sensitivity.

Signals go out in all directions, and return as echoes...

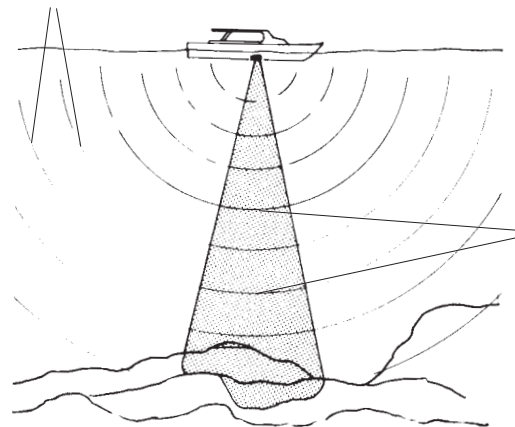

...but only those within the sounder's cone of sensitivity will be registered

Steep or irregular bottoms

If the seabed is very steeply sloping there may be depth variations inside the area of the cone. In this case, the echo from the shallowest depth will be received first, and those from the deepest part last. The result on the display screen is a closely grouped series of signals, which may merge into a single thick band, which indicates the depth range within the cone.

On a sloping seafloor...

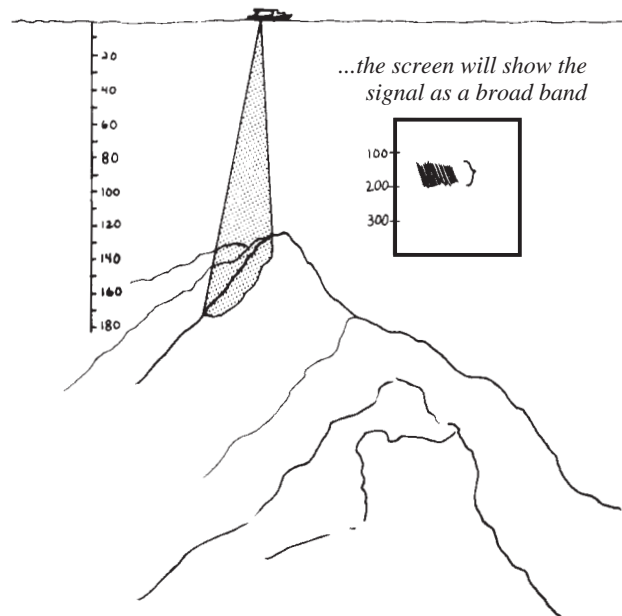

On a very irregular seafloor...

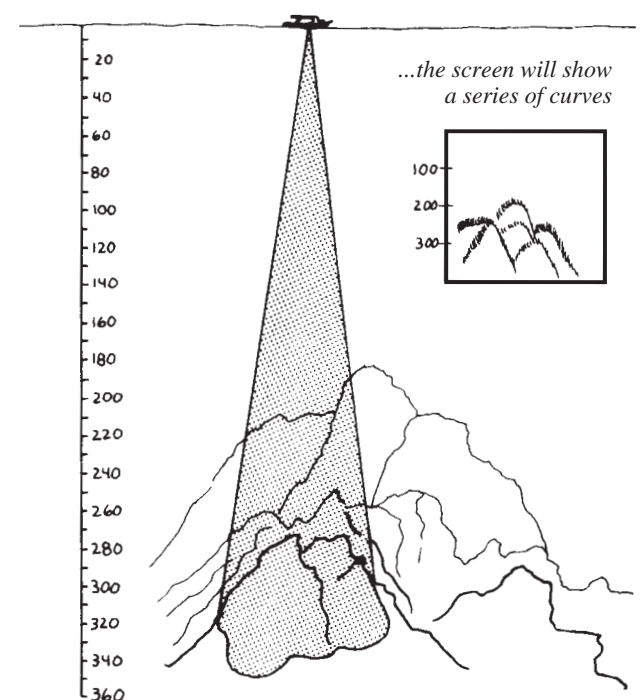

If the bottom is very irregular, there may be great depth variations inside the cone area. This is particularly true in deep water, where the area covered by the cone is greater than in shallower water. In this case, individual peaks and troughs inside the cone may be detected separately by the sounder. On the display screen this results in a series of curves at widely spaced intervals.

SECTION 4E: ANCHORING UP

The chosen fishing grounds are located using charts, depth soundings, landmarks and bearings, or your own experience. Once there, the first job is to anchor up ready for fishing.

Allowing for wind and current

By anchoring upwind or up-current of the chosen fishing spot, the wind or current can be used to carry you back over it. You therefore have to decide which of these two forces is going to have the greatest effect on your boat.

If the wind is blowing more than about 10 knots, it will almost certainly affect you more than the current. If the wind is less than this, then either one could be more important, depending on the current strength.

To estimate the effect of the current, lower one of your fishing lines 10–20 m (10 turns of the handreel) down over the side, with just the swivel or clip normally used to attach the terminal rig, but no additional weight, while drifting.

If the line goes more or less straight up and down, you are drifting with the current. This means the current is the main thing controlling your movement, so you should plan to anchor up-current of the fishing spot. The current direction can normally be seen from the direction of the boat's drift, as well as the fact that the line will never be quite vertical but will hang at a slight angle, in the down current direction.

If the fishing line hangs out from the boat at a fairly steep angle, this means that the wind is the main thing controlling your movement, so you should plan to anchor upwind of the fishing spot. However, the current may still affect your position, and it is wise to allow for this by heading slightly up-current too.

To test the influence of wind and current on the boat's movement...

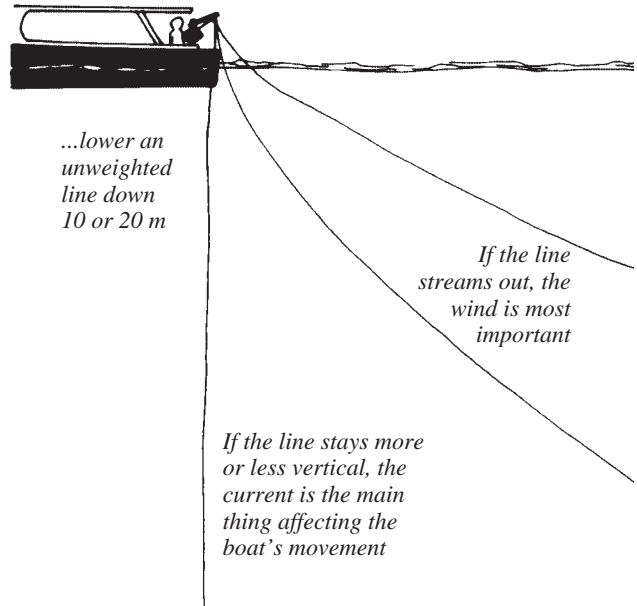

When the current is the main factor controlling drift...

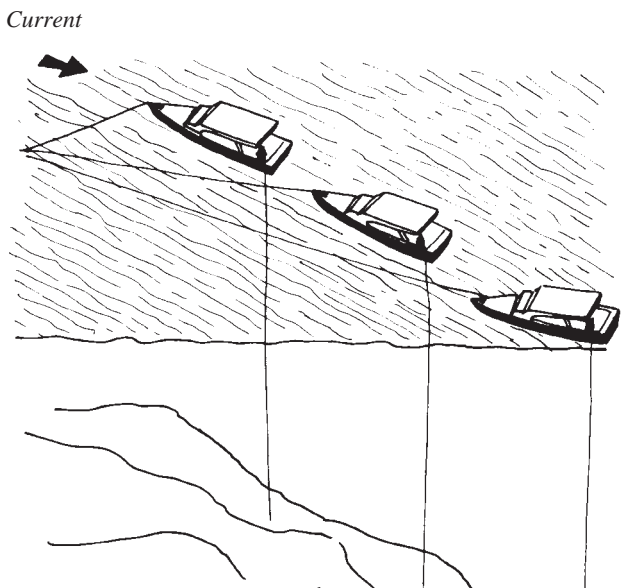

...head into the current, anchor, and then allow the boat to drift back as required

When the wind is the main factor controlling drift...

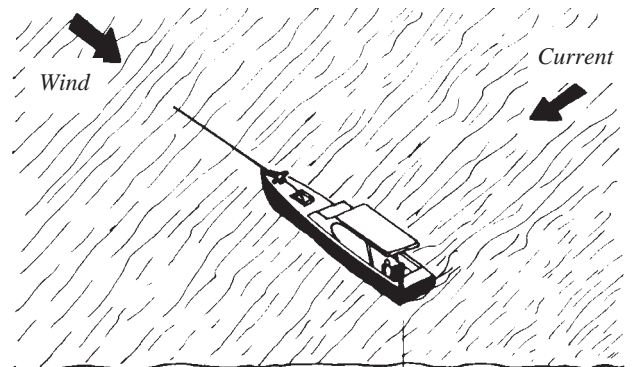

...head into the wind before dropping anchor...

...but remember also to allow for the direction of the current

Picking the anchoring spot

Once you have decided in which direction to go in order to anchor, head in that direction until you are a suitable distance away from where you want to fish. If you have an echo-sounder, run it as you move, to get an idea of the bottom shape and depth. The right distance depends on the anchoring depth. Plan to be at least twice as far from the fishing spot as the depth of the water you are anchored in, more in strong wind or current conditions. This allows you plenty of space to drop back on the anchor rope without overshooting the fishing spot. It also puts the anchor rope at a shallow angle and makes it less likely to pull out.

The distance from the anchor spot to the fishing spot...

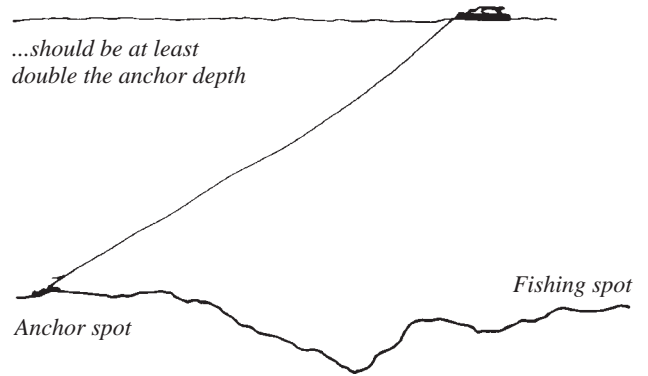

Whenever possible, anchor in water shallower than the fishing depth, so that less time and effort is required to set and, especially, to haul the anchor. If the bottom shape does not permit this, you may have to anchor in the same depth of water as the fishing spot, or even deeper. Whenever possible attach a float to the anchor rope once the anchor has settled, to make the job of hauling the rope easier. This is especially important when fishing in deeper water, to keep the rope off the bottom.

Always try to anchor in water shallower than the fishing spot...

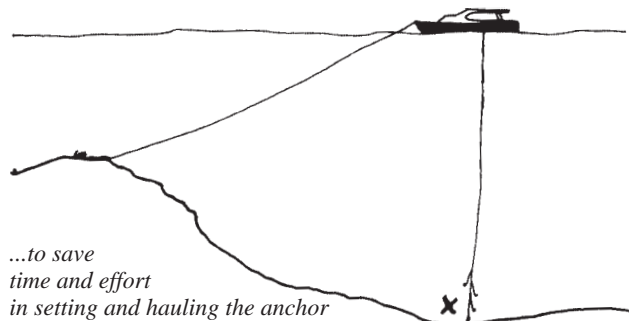

If anchoring deeper than the fishing spot...

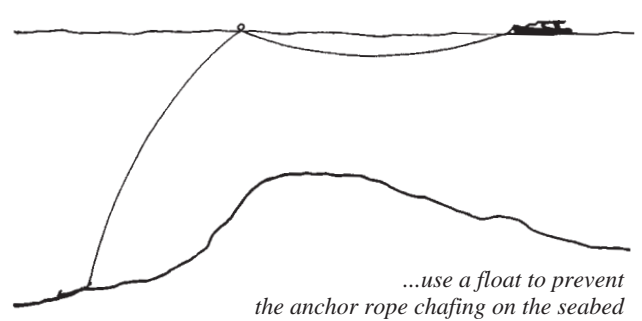

Anchoring procedure

Normal anchoring procedure is to head slightly past the place where you will drop the anchor, into the wind or current. The anchor is then dropped, and by the time it hits bottom the boat will have been pushed back over the anchor spot.

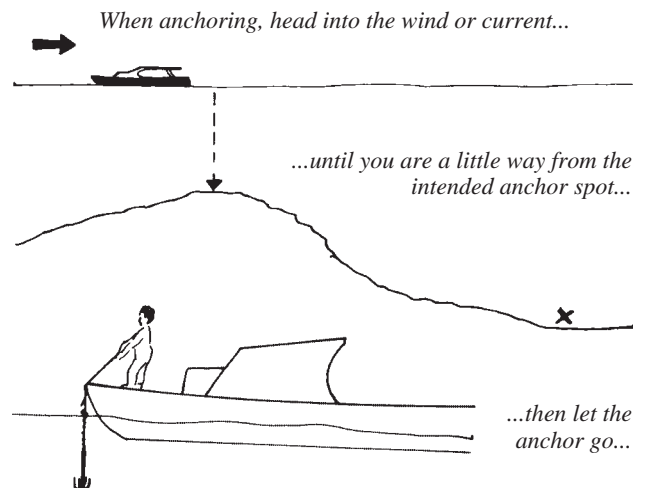

The anchor and chain is lowered over the bow of the boat and then let go. One crew man should control the anchor rope as it runs out, preventing any tangles or knots from going over the side. If this does happen he should pull the tangle back in and free it, otherwise it will not be possible to haul the anchor by the labour-saving method shown in section 4I.



The rope will stop running out fast once the anchor hits the bottom. The anchor man should then hold on to the rope until it pulls fairly tight, then slowly pay out extra rope until the right fishing depth is reached.

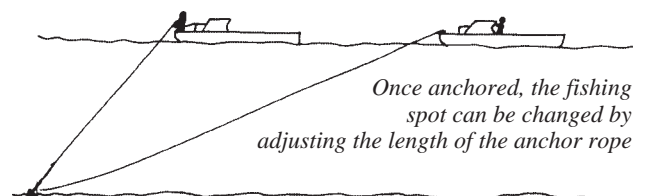

Once this happens, the rope is tied off at the bow of the boat, and fishing can start in earnest. If the fishing turns out to be no good, either pull in or let out anchor rope to change fishing spots, or haul the anchor and move.

SECTION 4F: POSITIONING THE BOAT AT ANCHOR

Both wind and current affect the way the boat will lie at anchor. The way in which a particular boat is affected will depend on its area above and below the waterline. It is important to allow for these forces so that the boat ends up resting over the area the fisherman wants to fish.

In general, if the wind is less than about 10 knots, and the current is weak, the boat will lie back at anchor in the wind. These are the best fishing conditions, because the wind can be used to control the fishing depth. The stronger the wind or current, the more the boat will swing around, in a figure-of-eight motion, through a range of fishing depths.

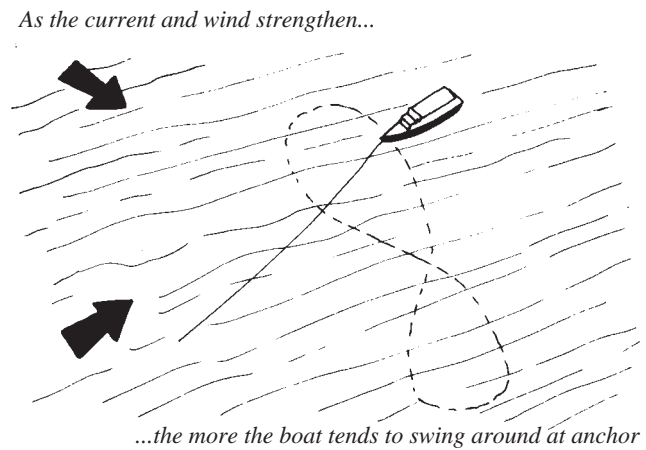
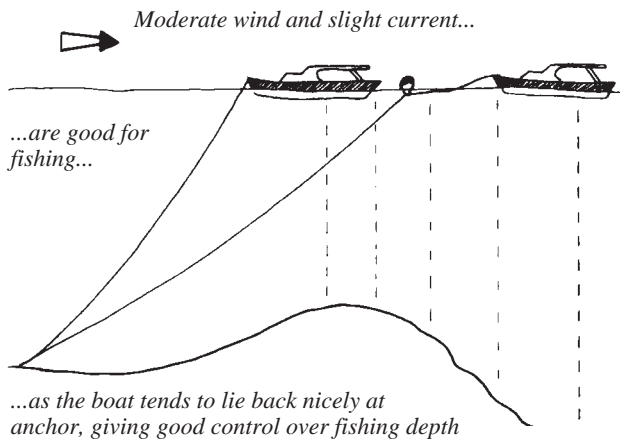

Weak winds and currents make anchoring easy but it may not be possible to use wind or current to push the boat back at anchor into the right fishing depth. Under these circumstances the boat may rest above the anchor spot, so that the fishing lines keep catching the anchor rope.

In weak winds and currents, the boat may not want to lie back over the fishing spot...

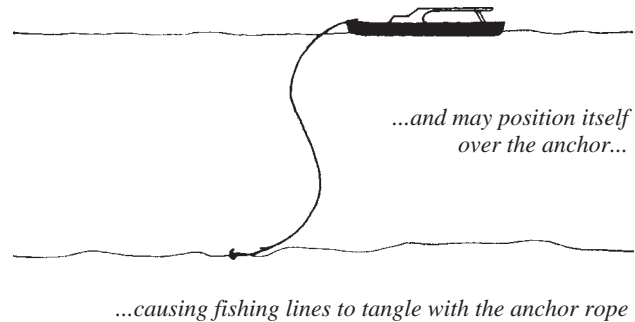

If the current is running along the reef, with flat calm weather or the wind blowing in the opposite direction then this is the ideal time to try drift fishing, preferably using a sea-anchor (see section 4J).

Fishing the leeward side of a reef or seamount...

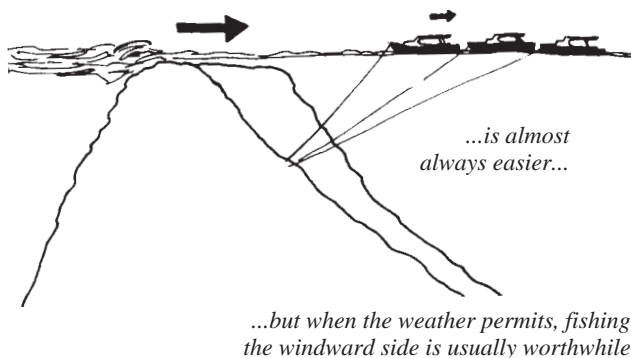

Fishing leeward and windward slopes

Except in flat calm weather, fishing in the lee of a reef is a lot easier than trying to fish on the windward side. By anchoring in the shallower water close to the reef, the wind can be used to carry the boat back towards deeper water. Slacking off more anchor rope allows the boat to fall further back, and increases the fishing depth. Fishing a leeward slope therefore gives the fisherman good control over his fishing depth, as well as making anchor hauling easier (see section 4I).

If there is little or no wind, or if the wind is not blowing in its usual direction, it may be possible to fish areas that are normally to windward. These areas often have steep slopes that make anchoring difficult, but fishing there is almost always worthwhile. Windward slopes are often more productive than leeward ones, and get fished less because the wind usually prevents fishing. So, on the odd occasion that fishing is possible, catches can be very good. Since fishing on these slopes is generally done when there is little or no wind, this is again a good time to try drift-fishing with a sea-anchor.

Using an anchor bridle

If the current is stronger than about 1 knot, and the wind is less than about 10 knots, then the current will probably be the main thing controlling the boat's position. The boat will tend to hang back at anchor, but the combined effects of wind and current may cause the boat to rest at an angle to the anchor rope, making fishing awkward or uncomfortable.

Under these conditions, an anchor bridle can be used to help position the boat in the right spot. To use a bridle, the boat is first anchored as normal. A short section of rope is then tied between the anchor line and a strong point on the side of the boat, and tightened up. This has the effect of turning the boat side-on relative to the anchor, and the current. The current then acts on the side of the boat something like the wind on a kite, causing the boat to swing off to one side.

When the current is the dominant factor affecting the boat...

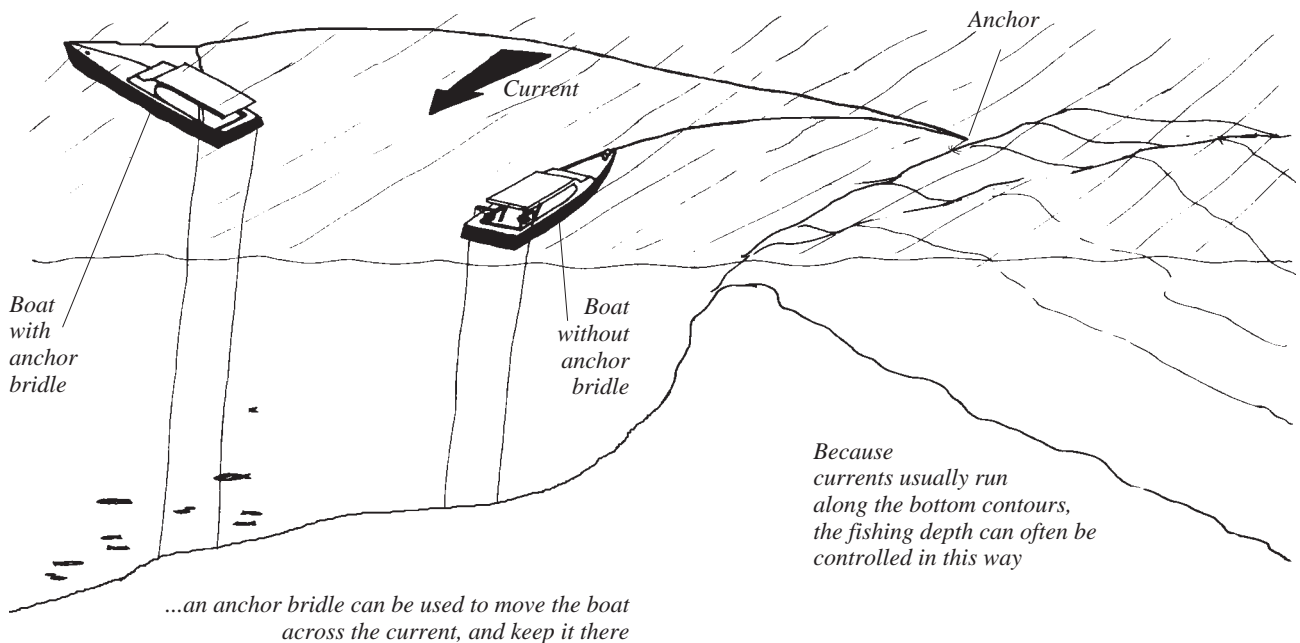

By adjusting the length of the bridle, and thus the angle of the boat to the current, the force of the current can often be used to manoeuvre the boat into the correct fishing depth. This can be especially useful when fishing on long, fairly straight stretches of reef-slope. In such situations the current usually runs along the reef, so fishing depth can be adjusted quite easily using this method.

Strong winds and currents

When both the wind and the current are too strong, fishing can be difficult or impossible. If the current and wind are in the same direction, the anchor may drag or be repeatedly pulled out. If they are in different directions, the boat will swing a great deal, and it may be impossible to stay in the right fishing depth for any length of time. Strong currents can also prevent the fishing line from reaching the bottom.

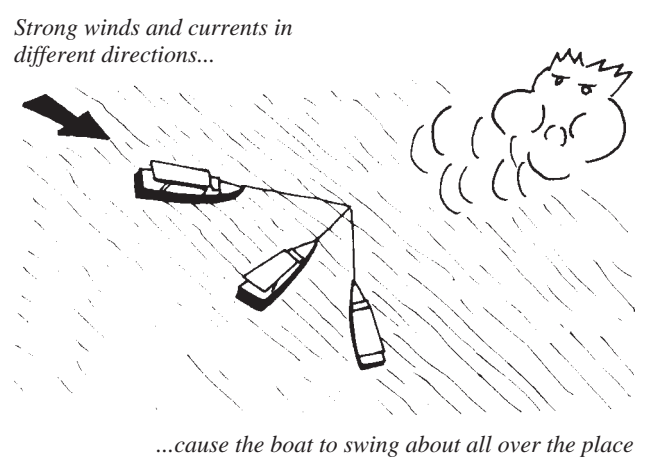
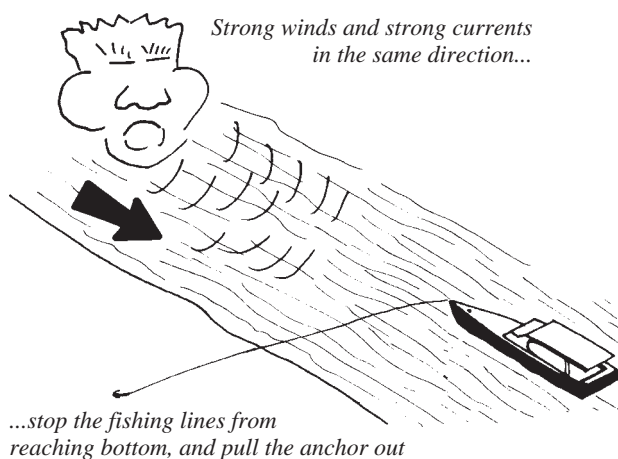

SECTION 4G: HOOKING AND HAULING FISH

Being prepared

Once the boat is at anchor, all the crew should be ready to start fishing straight away. In particular, all the gear should have been prepared, the bait cut, etc., on the trip out. Arriving at the fishing spot and then spending time preparing gear is a waste of precious fishing time. The only thing you should have to do before fishing is attach the terminal rig and sinker to the line and bait the hooks.

Checking depth

At least one crewman should be given the job of depth checking each time he hauls up and resets his line. This is done by counting the turns on the handreel, as described in section 4D. This enables the crew to know what depths the boat is swinging about in, or whether the boat is dragging anchor into deeper water. Checking in this way should still be done even if you have an echo-sounder. The sounder only tells you the water depth under the boat. The lines may be fishing in a different depth altogether because of boat movement and current.

To prevent tangling...

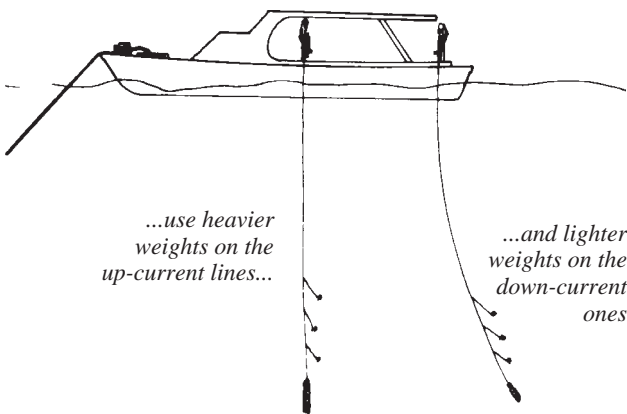

Holding bottom

Once the sinker has reached the seabed, most of the weight will go off the line. If the fisherman continues to pay out more line, the terminal rig and slack line will sink to the bottom and may hook up on rocks and coral. Too much slack line will also prevent the fishermen from feeling when the fish are biting.

It is therefore very important to keep the line tight. In a big swell, this may mean repeatedly paying out and hauling in line as the boat rises and falls. This can be tiring and frustrating but is the only way to fish efficiently and prevent bottom hook-ups.

The crew should be ready to fish as soon as the fishing spot is reached

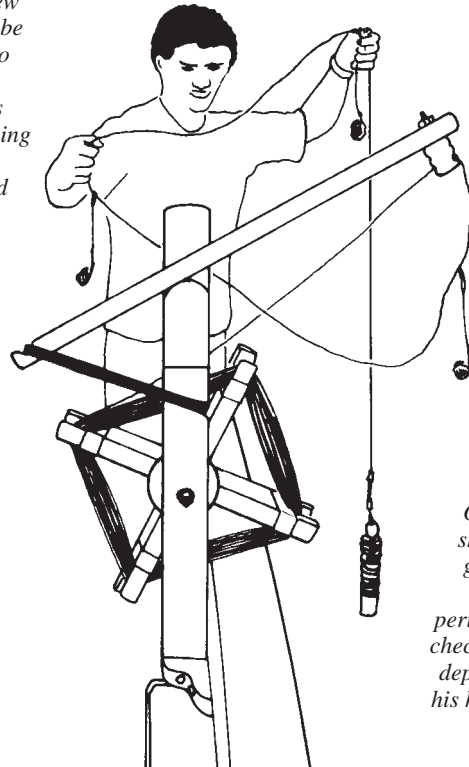

One man should be given the job of periodically checking the depth using his handreel

Getting the lines down

The best way to commence fishing is to have one person get his line in the water first, using a medium sinker (0.5–1 kg). From the way the line lies, the rest of the crew can then see how strong the current is and in which direction it is running. All the lines should be weighted heavily enough so that the current does not drag them too far from the boat and out of the desired fishing depth. When there is little or no current, all the lines can use the same-size weights. When the current is strong, however, those fishermen furthest up-current should use the heaviest weights, so that their lines will not be carried back and tangle with other lines further down current.

Always keep the fishing lines tight...

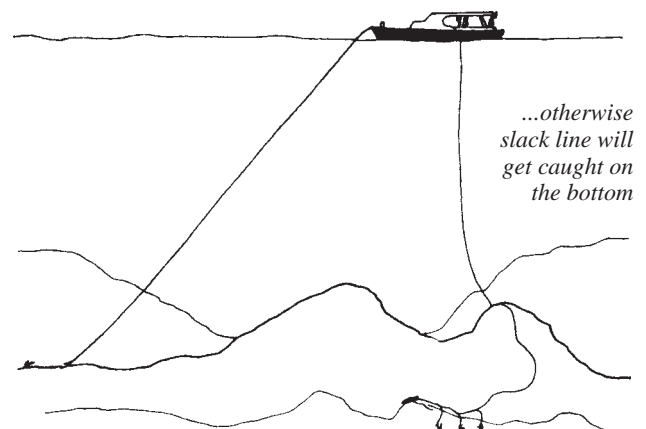

Feeling the bites

There is no mistaking the bite of a large fish, which can be powerful enough to almost pull you out of the boat. But feeling smaller bites when fishing in deep water can be difficult, and is something which comes only with practice. When fishing with braided lines bites can be felt quite easily, but nylon is stretchy and does not transmit the feel of the bites to your fingers very clearly. The heavy fishing sinker tends to damp down the jerk of the line as the fish tugs at the bait. If the sinker is dragging or bumping across the bottom as the boat moves, the bumps can be mistaken for bites. A strong current will make bites even harder to feel.

The main thing in feeling bites is to keep the line tight, so that the weight is just resting on the bottom, but the terminal rig is kept off the seabed. Make sure the line is not against the gunwale or side of the boat, as this will prevent you feeling the bites. Use a re-bar or lead sinker which is heavy enough not to bounce around too much. If using a length of chain as a sinker, the movement of the chain links may mask the jerks of the fish. Otherwise, feeling the bites of the smaller fish is a question of concentration, practice, and experience.

Get used to feeling the line...

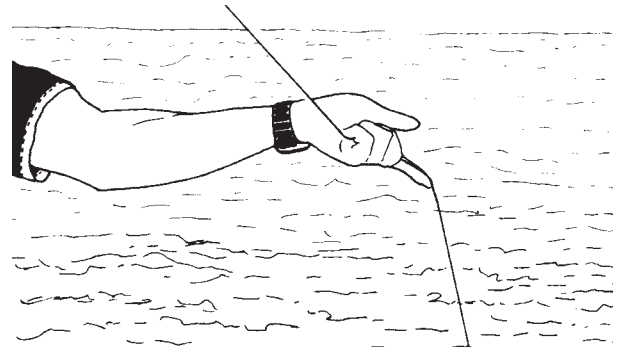

...and learning to distinguish bites from other 'noise'

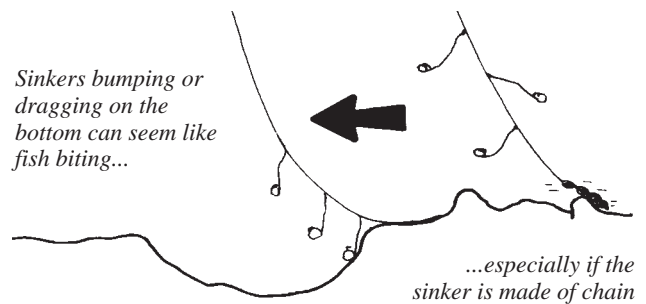

Sinkers bumping or dragging on the bottom can seem like fish biting...

...especially if the sinker is made of chain

Checking the line

Although bites can be difficult to feel, it is usually a lot easier to tell if one or more fish are actually hooked on the line. Nevertheless, small fish may go undetected so you should always check your hook regularly—at least every 15 minutes—to see if you have a fish or whether you may have lost all your bait. Hauling in should be done smoothly, at a comfortable speed which you can keep up without stopping until the terminal rig is on board. Handlines should be hauled in with a hand-over-hand motion, dropping the line on the deck in front of your feet. Handreels should always be wound evenly.

When a fish bites, give the handreel three or four rapid turns...

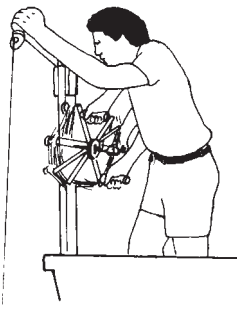

...to make sure the hook is set...

...then wind the fish evenly to the surface without stopping

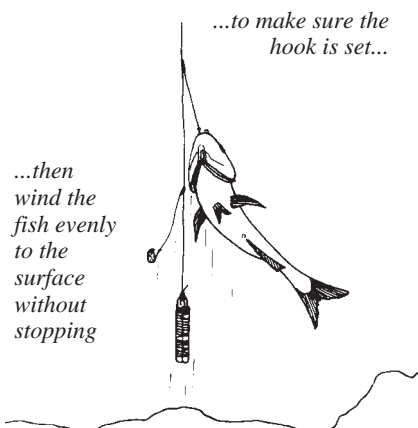

Striking

Striking when a fish bites means pulling on the line, the instant the bite is felt, to set the hook in the fish's mouth.

Striking in deep water is very difficult, partly because the bites are hard to feel, and partly because the usual type of fishing line, nylon monofilament, is very stretchy. This means that when you pull on the line, it stretches before the other end responds to the pull—by which time the fish may be gone.

Nevertheless, when you do feel a good bite, it is worth striking by rapidly hauling in 4 or 5 metres of line. There is always a good chance that the fish has the bait in its mouth or throat, but is not yet hooked. Striking can set the hook before the fish has a chance to change its mind and spit out the bait and hook.

Avoid jerking the line as this can pull the hook from the fish's mouth. Stopping takes the pressure off the fish and may allow it to escape. Fish caught in deep water usually inflate with air on the way up, due to the expansion of their swim bladder. If you stop hauling, the fish keeps on floating up and this can cause bad tangles in the line, or allow the fish to float off the line. Once you have started hauling, make sure tension is kept on the line at all times, and do not stop until the fish is at the surface.

SECTION 4H: BOATING THE FISH

The time when a fish is being lifted from the water into the boat is the time when it is most likely to be lost. Extra weight may come on to the hooks, and tear them from the fish's mouth, or the fish may unhook itself as it thrashes in panic. It is therefore important to boat the fish in a smooth, efficient manner, where necessary using a net, gaff or other landing tool (see section 3G).

Fish size

The size of the fish can usually be estimated while it is being hauled in. When it first comes into view as it is brought towards the boat, the size can be confirmed and a decision made as to whether a net or gaff will be needed. In fact most deep-bottom fish are subdued when they reach the surface because of the inflation of their swim bladder that occurs when they are hauled up from the deep. This also causes them to float belly-up, making them a lot easier to grasp through the gills and lift aboard.

As a general rule, fish under about 10 kg can be lifted straight into the boat or netted, while fish over 10 kg should be gaffed. Very large fish may need two or more of the crew, with a gaff each, to boat them. The largest fish and many sharks may be too strong or dangerous to gaff, but can be noosed by two or three crew working together.

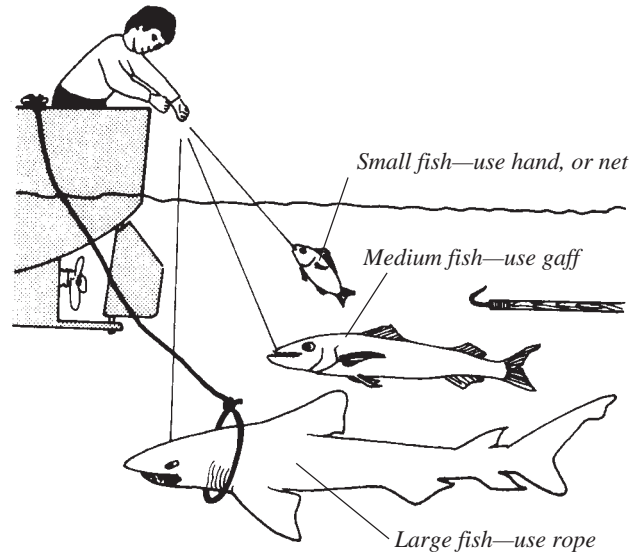

Lifting and netting

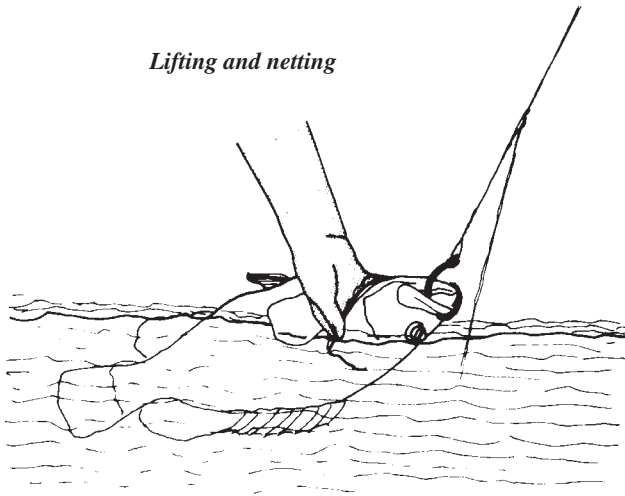

Lifting and netting

Lifting fish aboard by hand is a simple operation, but is dangerous with sharp-toothed fish. If the fish can be seen to be properly hooked, the terminal rig should be grasped a foot or two in front of the hook and the fish lifted smoothly out of the water and into the killing box or other receptacle. If it looks as if the fish could fall off the hook, then it should be grasped in the gills and lifted aboard.

When netting, the terminal rig is grasped in the same place, and the net brought up over the tail and body of the fish from behind.

Gaffing

Gaffing is by far the most popular method of boating fish. Some different types of gaff are described in section 3G.

Whenever possible, the fish should be gaffed in the head. This avoids damage to the flesh, and may help stun or kill the fish.

A fish gaffed through the body has more leverage to use when thrashing about, and may succeed in leaping off the gaff and back into the water. Even if it does not escape it will almost certainly bruise or cut itself, lowering its flesh quality and market value in the process.

Gaffing

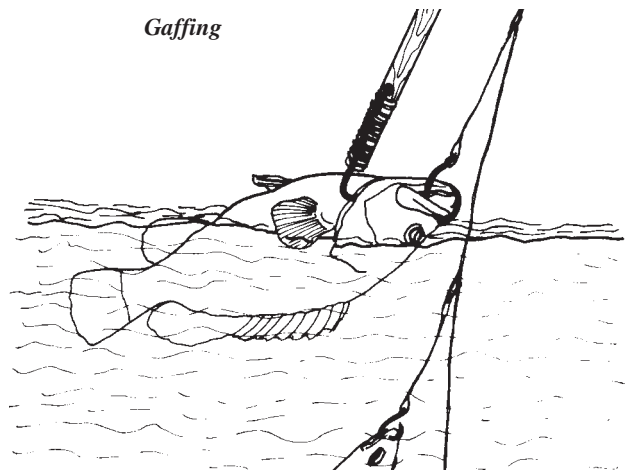

Gaff actions

The actions of the two main types of gaff, the 'L-gaff' and the 'J-gaff', are shown below. The L-gaff is used mainly on smaller-sized fish, and the action is to strike down on the fish from above. The J-gaff is more common and is better for larger, heavy fish. The gaffer reaches over and beyond the fish with the gaff, and then pulls back towards the boat, sinking the point home. The fish can then be hauled aboard with both hands on the gaff handle.

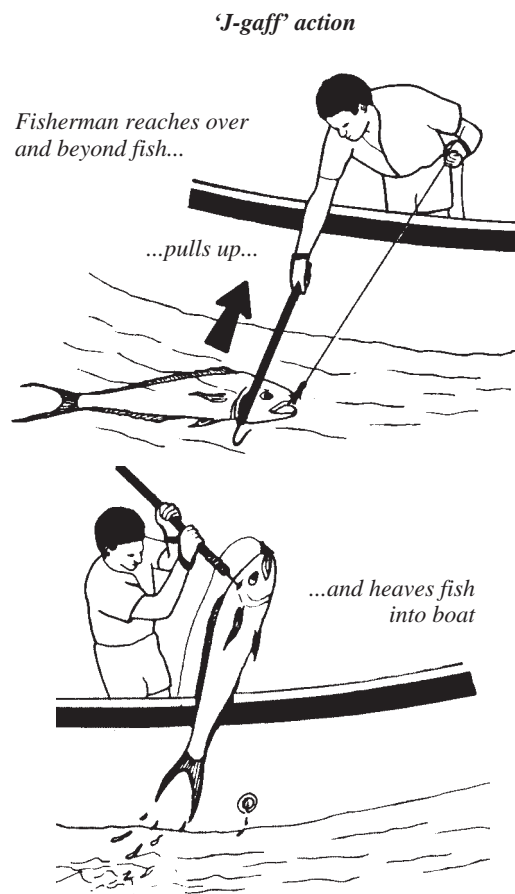
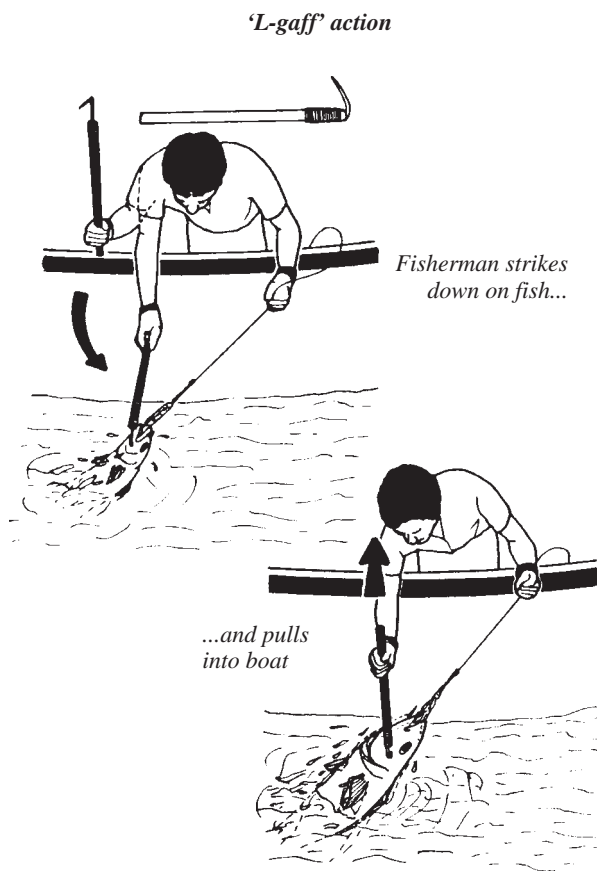

Noosing

Noosing is mainly used as a way of manhandling sharks or other fish which are too large to be brought aboard by one or two men using gaffs. A length of stiff sinking rope should be used—longline cord is ideal. The rope is passed around the line on which the shark is hooked, and the end is then tied in a bowline knot around the standing part of the rope. This forms a noose which is then opened up wide and allowed to slide down the line and into the water. The shark is held close to the water surface using the fishing line, and the noose is manoeuvred over its head, with the help of gaffs if necessary, until it is around the gill area. It is not necessary to get the rope back over the shark's fins—this is just about impossible with some long-finned types. Once the noose is around the gill area, it is pulled tight, and the shark can then be hauled aboard, or just tied off until it dies.

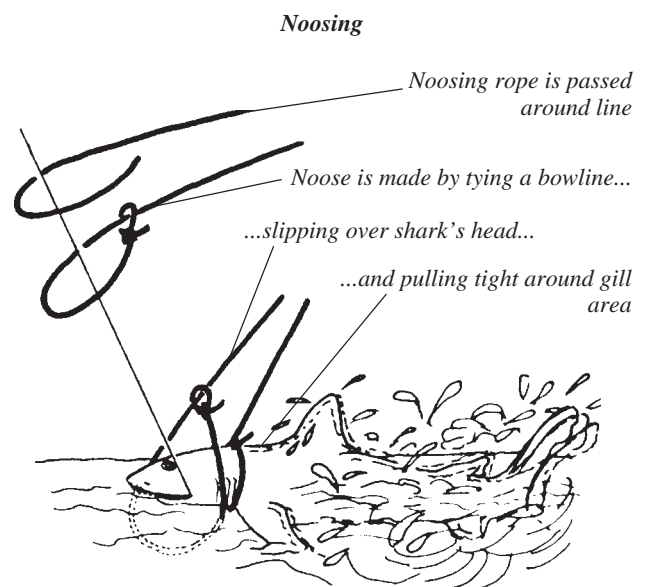

Unhooking

Once the fish is on board, it should be lifted straight into the box or a part of the boat where it can be controlled for unhooking. The hooks can be removed by hand, or with the aid of pliers and a knife, depending on the type of fish and the way it is hooked. A circle hook should be removed by rotating it out of the fish's mouth, in a motion which is the reverse of that used when baiting the hooks (see section 2L).

SECTION 4I: HAULING THE ANCHOR

After fishing, or when changing fishing spots, it is necessary to haul up the anchor, sometimes from water several hundred metres deep. This section shows a simple way to take the back-breaking labour out of doing this job by hand.

Anchor gear

The anchor must be a grapnel-type fishing anchor made from reinforcing rod, as shown in section 3E. Other types of anchor may be too strong and solid to break out if stuck on the bottom. Normally the anchor should have a short length (3–4 m) of chain connected to it.

Other gear required for the job is also shown in section 3E. The anchor rope is attached to the end of the chain. A no-return barb, made of stiff wire, is lashed to the anchor rope, 1–2 metres from where it joins the chain, so that it points back toward the anchor. A large float of 30 kg or greater buoyancy, and shackle with which to clip it onto the anchor rope, complete the gear list.

Breaking out

To break out the anchor, first take any slack out of the rope by hand hauling while gently motoring the boat forward. Once the rope cannot be easily pulled in any further, tie it off to a strong point on the boat. Then slowly motor forward, into the wind or current, until you have passed over the anchor and the rope pulls tight behind the boat. Keep going for 30 seconds or a minute. If there is no apparent resistance holding the boat back, this means the anchor is free of the bottom.

The anchor man takes up the slack...



...secures the anchor rope to a strong point...

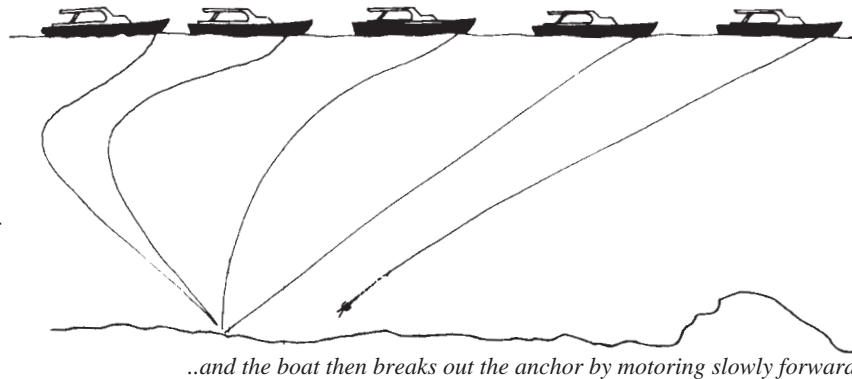
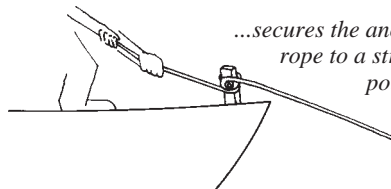

Because the prongs of this type of fishing anchor bend easily, it very seldom gets stuck. However, on rare occasions the chain, or the chain end of the anchor, may get stuck on rocks and refuse to break out. If this happens, try pulling in a different direction, or circling to free the anchor. Have a crewman pull up and down on the rope to shake the chain free. One of these methods will usually free a stuck anchor.

If the anchor gets stuck...

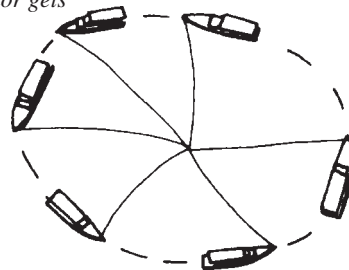

...change direction, or motor in a circle to break it out

Raising up

When the anchor is free, turn the boat in the direction of deep water and speed up to 5 or 6 knots. Keep travelling at this speed for 1 or 2 minutes, longer if you have a lot of rope out. Travelling at this speed causes the rope, chain and anchor to rise in the water, until they are being towed along behind the boat just a few metres below the surface.

Once the anchor has broken free, motor the boat fast forward...

...so that the anchor gradually rises to the surface



Attaching the anchor buoy

After a minute or two of towing, clip the buoy onto the anchor rope using the shackle. The buoy should be able to slide freely along the anchor rope.

Throw the buoy over the side, where it will be dragged back along the anchor rope by the resistance of the water. This will gradually raise the rope the last few metres to the surface as the buoy slides along the anchor rope towards the anchor.

Once the anchor rope is more or less horizontal...

...shackle the buoy onto it...

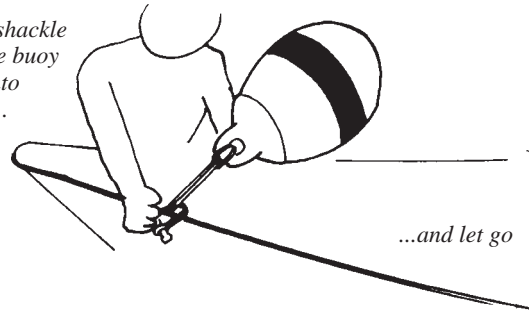

...and let go

Towing the anchor

After 2–3 more minutes of towing, the buoy will come up against the anchor chain, from where it can go no further. At this point, the buoy will plough through the water, throwing up a lot of spray. The boat can now stop, turn around, and start hauling in the rope.

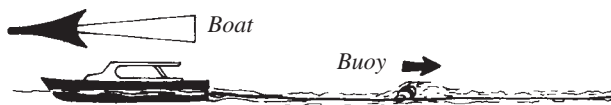

Water resistance will cause the buoy to slide along the anchor rope as the boat continues to move forward

The buoy will eventually come up against the anchor...

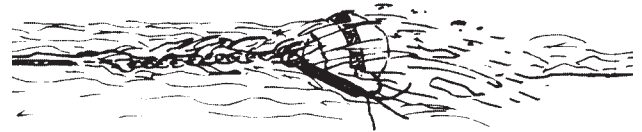

...at which time it gets dragged through the water, throwing up spray

The anchor will try to sink as soon as the boat stops, but this causes the no-return barb on the rope to trap on the buoy shackle. The anchor therefore finishes up hanging from the buoy just a couple of metres below the sea surface

When the boat stops, the anchor will immediately try to sink...

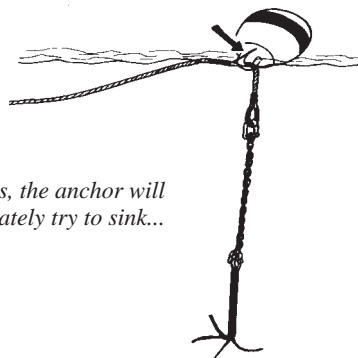

...but will be prevented from doing so by the 'no-return' barb

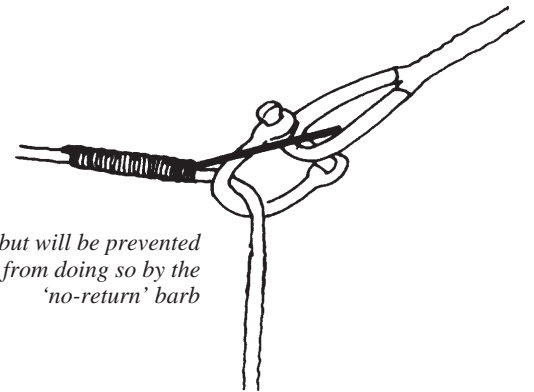

Hauling in

To recover the anchor, a crewman stands in the bow of the boat, hauling in the floating anchor rope as the boat motors towards the anchor, until the buoy is reached. The buoy, chain and anchor are then brought aboard, and the buoy is unshackled from the rope.

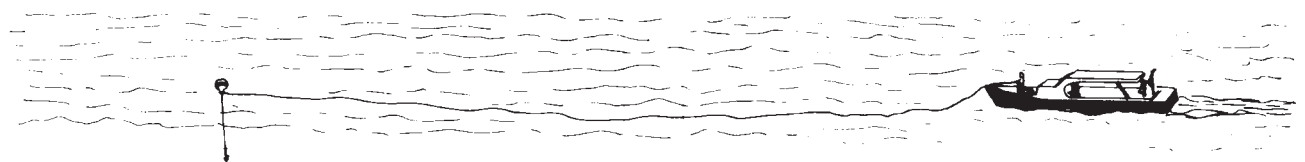

Straightening the anchor

The final job is to check the anchor and bend back into the correct shape any prongs that may have been straightened out if the anchor got stuck on the bottom. The anchor is then ready to be reset at the next location.

Any prongs that have been straightened out by becoming hooked on the bottom...



...can easily be bent back into shape by hand

SECTION 4J: DRIFTING WITH WIND AND CURRENT

Fishing from an anchored position is the most usual method of deep-bottom fishing. However, under the right conditions fishing can be carried out by drifting, and this may allow you to fish areas not normally possible from an anchored boat.

The best conditions for drift fishing are when there is little or no wind (less than 5 knots for most boats) and when the surface current is either running parallel to the reef and the bottom contours, or is so weak as to have no effect on the boat. It is possible to drift-fish in stronger breezes, but only when the wind is blowing in the same direction as the current.

Under these conditions, the boat tends to drift along the depth contours. Once the boat is moved to the desired depth and allowed to drift, it will stay in the same depth for a good length of time. If the wind or current are in the wrong direction, it will quickly drift out of the desired depth range.

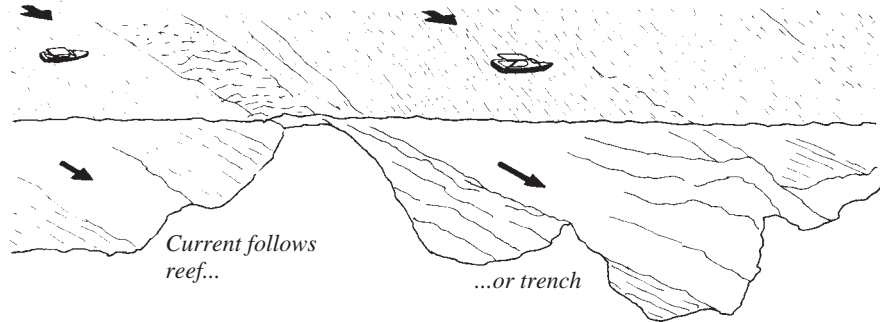

If the wind is very light, and the drift is controlled by the current, fishing is reasonably easy. The surface current has much the same effect on the lines as it does on the boat, forcing them along in the same direction, and keeping them more or less vertical. If there are strong sub-surface or bottom currents, it may be necessary to pay out plenty of extra line to account for this.

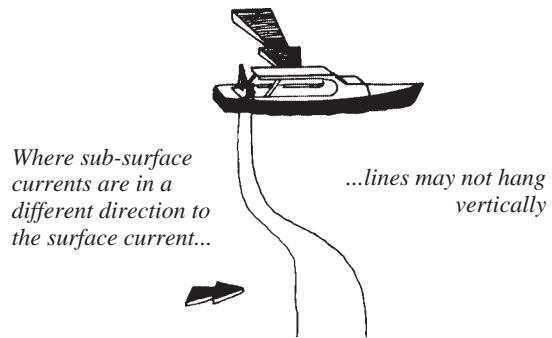
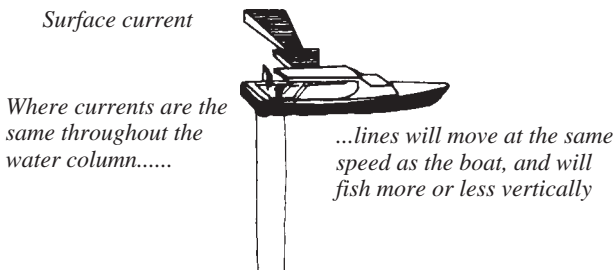

Strong wind makes drift fishing difficult

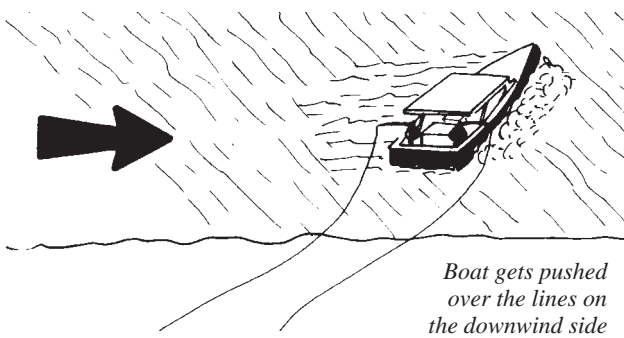

If it is the wind which is controlling the drift, fishing can be much harder, because the boat may be moving in a different direction to the surface current. This tends to pull the lines away from the vertical, and forces the fishermen to pay out a lot of extra line to reach the bottom. Those fishermen on the downwind side will have their lines pulled under and against the hull of the boat, making it hard to feel the bottom or any bites on the line. Under such circumstances, therefore, fishing should only be done from the up-wind side of the boat.

The harder the wind is blowing, the faster will be the drift, and the greater the problem. One way to counter the problem is to slow down the speed of the drift. A simple way of doing this is tie one or more strong buckets (not cheap plastic ones, whose handles will quickly pull out) on to short lengths of rope and trail them in the water from the boats bow. This not only slows down the rate of movement, but swings the boat's bow into the wind, reducing rolling and making fishing more comfortable.

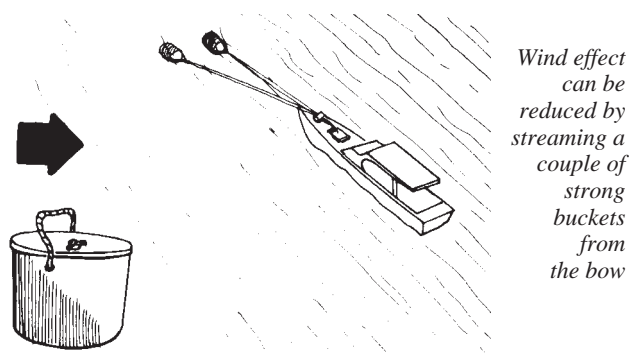

A better solution, but a more expensive one, is a sea-anchor. This consists of a cone of canvas or other strong material (see section 3E) which acts like a parachute in the water. (In fact old cargo parachutes are sometimes used as sea anchors). The sea-anchor greatly increases the boat's underwater surface area, putting the boat under the control of the surface current, rather than the wind. If the current and the wind are moving in opposite directions, a sea-anchor can often be used to keep the boat more or less stationary or moving only slowly.

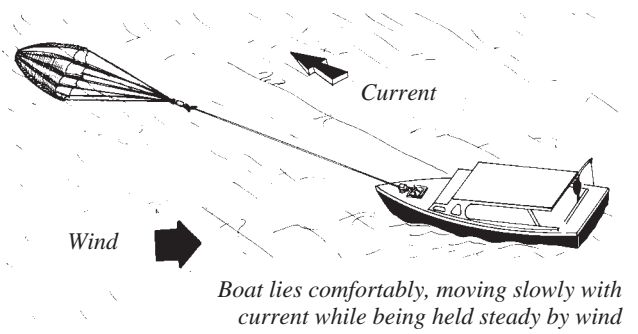

As well as being a generally useful fishing tools, sea-anchors add to the safety of small-boat fishing operations.

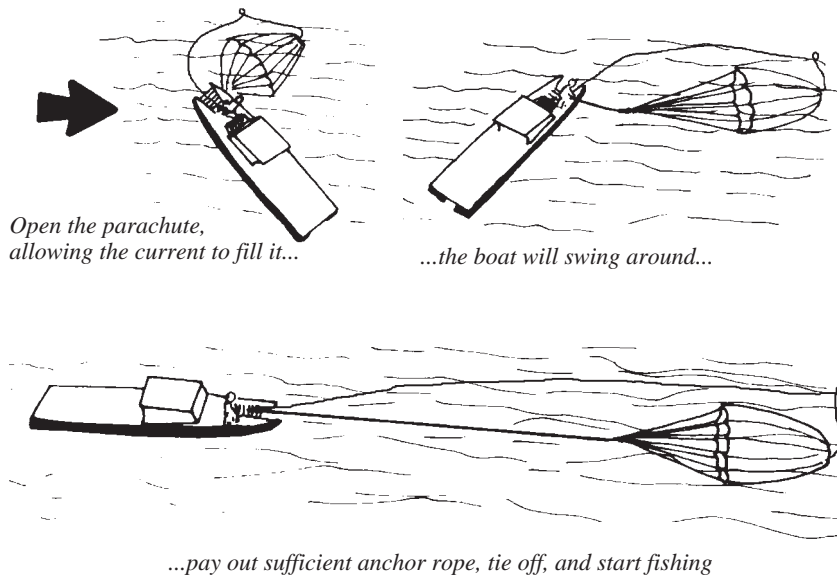

Setting the sea anchor is straight forward enough. It is simply lowered over the bow of the boat, with the anchor man keeping the opening of the parachute turned into the current to help it fill quickly. The trip-line and float attached to the apex of the sea-anchor are also paid out as the sea-anchor fills, and allowed to float free with no tension on them. Once some resistance is felt, the anchor rope is paid out until the anchor is 10–15 metres away, and the rope tied off. The whole procedure can be made faster if the boat is put into reverse gear for a few seconds. An experienced crew can set a sea anchor in less than a minute and be ready to fish.

Depending on the strength and direction of the surface and sub-surface currents, the fishing lines may be carried forward or aft of the boat as they are lowered to the bottom. To avoid tangles it is important that the up-current lines should have heavier sinkers than the down-current ones.

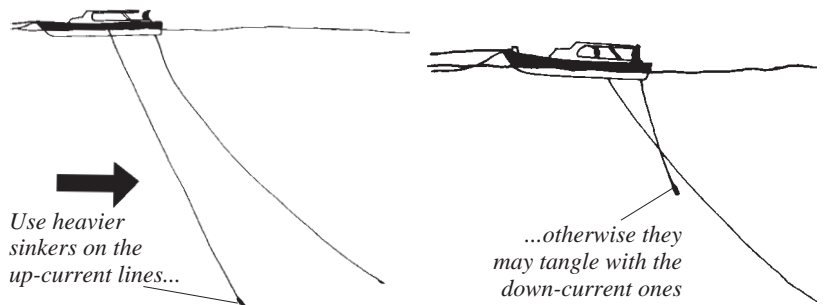

Hauling a sea anchor is almost as quick and easy as setting it. Hauling in the trip rope turns the parachute around, folding it shut as it is hauled in.

