

Power Generation

BY

- EZRA S. KRENDEL** *Emeritus Professor of Operations Research and Statistics, University of Pennsylvania*
- R. RAMAKUMAR** *Professor of Electrical Engineering, Oklahoma State University*
- C. P. BUTTERFIELD** *Chief Engineer, Wind Technology Division, National Renewable Energy Laboratory*
- ERICH A. FARBER** *Distinguished Service Professor Emeritus; Director Emeritus Solar Energy and Energy Conversion Laboratory, University of Florida*
- KENNETH A. PHAIR** *Senior Mechanical Engineer, Stone and Webster Engineering Corp.*
- SHERWOOD B. MENKES** *Professor of Mechanical Engineering, Emeritus, The City College, The City University of New York*
- JOSEPH C. DELIBERT** *Retired Executive, The Babcock & Wilcox Co.*
- FREDERICK G. BAILY** *Consulting Engineer; formerly Technical Coordinator, Thermodynamics and Applications Engineering, General Electric Co.*
- WILLIAM J. BOW** *Director (Retired), Heat Transfer Products Dept., Foster and Wheeler Energy Corp.*
- DONALD E. BOLT** *Engineering Manager, Heat Transfer Products Dept., Foster and Wheeler Energy Corp.*
- DENNIS N. ASSANIS** *Professor of Mechanical Engineering, University of Michigan*
- CLAUS BORGNAKKE** *Associate Professor of Mechanical Engineering, University of Michigan*
- DAVID E. COLE** *Director, Office for the Study of Automotive Transportation, Transportation Research Institute, University of Michigan*
- D. J. PATTERSON** *Professor of Mechanical Engineering, Emeritus, University of Michigan*
- JOHN H. LEWIS** *Technical Staff, Pratt & Whitney, Division of United Technologies Corp.; Adjunct Associate Professor, Hartford Graduate Center, Rensselaer Polytechnic Institute*
- ALBERT H. REINHARDT** *Technical Staff, Pratt & Whitney, Division of United Technologies Corp.*
- LOUIS H. RODDIS, JR.** *Late Consulting Engineer, Charleston, SC*
- DANIEL J. GARNER** *Senior Program Manager, Institute of Nuclear Power Operations*
- JOHN E. GRAY** *ERCI, International*
- EDWIN E. KINTNER** *GPU Nuclear Corp.*
- NUNZIO J. PALLADINO** *Dean Emeritus, College of Engineering, Pennsylvania State University*
- GEORGE SEGE** *Technical Assistant to the Director, Office of Nuclear Regulatory Research, U.S. Nuclear Regulatory Commission*
- PAUL E. NORIAN** *Special Assistant, Regulatory Applications, Office of Nuclear Regulatory Research, U.S. Nuclear Regulatory Commission*
- ROBERT D. STEELE** *Manager, Turbine and Rehabilitation Design, Voith Hydro, Inc.*

9.1 SOURCES OF ENERGY

Contributors are shown at the head of each category.

Introduction (STAFF CONTRIBUTION)	9-3	Geothermal Power (BY KENNETH A. PHAIR)	9-17
Alternative Energy, Renewable Energy, and Energy Conversion: An Introduction (STAFF CONTRIBUTION)	9-4	Stirling (Hot Air) Engines (BY ERICH A. FARBER)	9-20
Muscle-Generated Power (BY EZRA S. KRENDEL, AMENDED BY STAFF)	9-4	Power from the Tides (STAFF CONTRIBUTION)	9-21
Wind Power (BY R. RAMAKUMAR AND C. P. BUTTERFIELD)	9-5	Utilization of Energy of the Waves (STAFF CONTRIBUTION)	9-22
Power from Vegetation and Wood (STAFF CONTRIBUTION)	9-10	Utilization of Heat Energy of the Sea (STAFF CONTRIBUTION)	9-22
Solar Energy (BY ERICH A. FARBER)	9-11	Power from Hydrogen (STAFF CONTRIBUTION)	9-23
		Direct Energy Conversion (BY ERICH A. FARBER)	9-24
		Flywheel Energy Storage (BY SHERWOOD B. MENKES)	9-27

9-2 POWER GENERATION

9.2 STEAM BOILERS

by Joseph C. Delibert

Fuels Available for Steam Generation	9-29
Effect of Fuel on Boiler Design	9-29
Slag and Ash	9-29
Soot Blower Systems	9-31
Ash and Slag Removal	9-32
Stokers	9-32
Pulverizers	9-32
Burners	9-34
Cyclone Furnaces	9-35
Unburned Combustible Loss	9-35
Boiler Types	9-36
Furnaces	9-37
Superheaters and Reheaters	9-41
Economizers	9-43
Air Heaters	9-43
Steam Temperature, Adjustment and Control	9-44
Operating Controls	9-45
Boiler Circulation	9-45
Flow of Gas through Boiler Unit	9-46
Performance	9-47
Water Treatment and Steam Purification	9-48
Steam Purification	9-51
Care of Boilers	9-52
Codes	9-52
Nuclear Boilers	9-53

9.3 STEAM ENGINES

Staff Contribution

Work and Dimensions of the Steam Engine	9-54
---	------

9.4 STEAM TURBINES

by Frederick G. Baily

Steam Flow through Nozzles and Buckets in Impulse Turbines	9-57
Low-Pressure Elements of Turbines	9-60
Turbine Buckets, Blading, and Parts	9-62
Industrial and Auxiliary Turbines	9-64
Large Central-Station Turbines	9-68
Steam Turbines for Combined Cycles	9-69
Steam-Turbine Performance	9-69
Installation, Operation, and Maintenance Considerations	9-73

9.5 POWER PLANT HEAT EXCHANGERS

by William J. Bow, assisted by Donald E. Bolt

Surface Condensers	9-75
Air-Cooled Condensers	9-81
Direct-Contact Condensers	9-81
Air Ejectors	9-82
Vacuum Pumps	9-83
Cooling Towers	9-84
Dry Cooling Towers, with Direct-Contact Condensers	9-86
Spray Ponds	9-86
Closed Feedwater Heaters	9-86
Open, Deaerating, and Direct-Contact Heaters	9-89
Evaporators	9-89

9.6 INTERNAL COMBUSTION ENGINES

by Dennis N. Assanis, Claus Borgnakke, David E. Cole,
and D. J. Patterson

General Features	9-90
------------------	------

Analysis of Engine Process	9-91
U.S. Automobile Engines	9-94
Foreign Automobile Engines	9-96
Truck and Bus Engines	9-97
Tractor Engines	9-98
Stationary Engines	9-99
Marine Engines	9-99
Small Industrial, Utility, and Recreational Vehicle Gasoline Engines	9-100
Locomotive Engines	9-102
Aircraft Engines	9-102
Wankel (Rotary) Engines	9-102
Fuels	9-104
Gas Exchange Processes	9-106
Fuel-Air Mixture Preparation	9-108
Combustion Chambers	9-111
Spark Ignition Combustion	9-114
Combustion Knock	9-115
Output Control	9-117
Cooling Systems	9-117
Lubrication	9-118
Air Pollution	9-119

9.7 GAS TURBINES

by John H. Lewis and Albert H. Reinhardt

Introduction	9-124
Fuels	9-124
Thermodynamic Cycle Basis	9-125
Brayton Cycle Variations	9-126
Configuration Variations	9-128
Waste Heat Recovery Systems	9-129
Operating Characteristics	9-130
Gas-Turbine Components	9-131
Applications	9-132

9.8 NUCLEAR POWER

by Louis H. Roddis, Jr., Daniel J. Garner, John E. Gray, Edwin E.
Kintner, and Nunzio J. Palladino, supplemented by George Sege
and Paul E. Norian of the NRC

Fission and Fusion Energy	9-133
Nuclear Physics	9-133
Utilization of Fission Energy	9-135
Properties of Materials	9-138
Fission Reactor Design	9-140
Nuclear Power Plant Economics	9-142
Nuclear Power Plant Safety	9-145
Nuclear Power Plant Licensing	9-146
Other Power Applications	9-148
Nuclear Fusion	9-148

9.9 HYDRAULIC TURBINES

by Robert D. Steele

General	9-149
Reaction Turbines	9-151
Impulse Turbines	9-155
Reversible Pump/Turbines	9-157
Model Tests	9-158
Cavitation	9-159
Speed Regulation	9-159
Auxiliaries	9-160
Computer-Aided Design	9-160
Turbine Tests	9-160

9.1 SOURCES OF ENERGY

Contributors are shown at the head of each category.

REFERENCES: Latest available published data from the following: "Reserves of Crude Oil, Natural Gas Liquids, and Natural Gas in the U.S. and Canada," American Petroleum Institute. "Annual Statistical Review—Petroleum Industry Statistics," American Petroleum Institute. Worldwide Issue, *Oil & Gas Jour.* annually. "Potential Supply of Natural Gas in the U.S.," Mineral Resources Institute. Colorado School of Mines. Coal resources in the United States, *U.S. Geol. Surv. Bull.* 1412. Geological Estimates of Undiscovered Recoverable Oil and Gas Resources in the U.S., *U.S. Geol. Surv. Circ.* 725, United Nations Statistical Office, "Statistical Yearbook," New York, U.N. Department of Economic and Social Affairs. Bureau of Mines, Metals, Minerals, and Fuels, vol. I of "Minerals Yearbook" published annually. "Coal Data," National Coal Association. "International Coal," National Coal Association. Annual Technical Literature Data Base, *Power*, McGraw-Hill.

INTRODUCTION

Staff Contribution

Global energy requirements are supplied primarily by fossil fuels, nuclear fuels, and hydroelectric sources; about 1 to 2 percent of global requirements are supplied from other miscellaneous sources. In the United States in 1994, total domestic power requirements were supplied approximately as follows: 70 percent fossil fuel (of which coal accounted for 58 percent), 20 percent nuclear fuel, 10 percent from hydroelectric sources, and less than 1 percent from all other sources. In spite of the large increase in nuclear generated power, both in the United States and globally, coal continues to be the major fuel consumed.

In the United States, new power plants constructed at this time are designed to consume fossil fuels—primarily coal, many with gas, and a few with petroleum. The situation with regard to nuclear power is complicated by a number of circumstances; see Sec. 9.8. Energy statistics and accompanying data stay current for a short time. Bear in mind that when quantities of known reserves of fuel of all types are stated, there is implied the significant matter of whether they are, indeed, producible in a given economic climate. Estimates for additional reserves remaining to be discovered are available, by and large, only for the United States. At any given time, the situation with regard to estimates of recoverable fuel sources is subject to wide swings whose source is manifold: national and international politics, environmental concerns, significant progress in energy conservation, unsettled political and social conditions in locations within which reside much of the world reserves of fossil fuels, economic impact of financing, effects of inflation, and so on. The references cited, in their most current form, will provide the reader with realistic and authoritative compilations of data.

Fossil Fuels

Petroleum Proved reserves of crude oil and natural gas liquids in the United States, based upon estimated discovered quantities which geological and engineering data demonstrate with reasonable certainty to be recoverable in future years from presently known reservoirs under existing economic and operating conditions, are published annually by the American Petroleum Institute. Estimates of additional remaining producible reserves which will be discovered, proved, and produced in the future from the total original oil in place, are derived by *U.S. Geol. Surv. Circ.* 725 from present and projected conditions in the industry.

Estimates of proved crude oil reserves in all countries of the world are published by *Oil and Gas Journal*. New discoveries are continually adding to and changing proved reserves in many parts of the world, and these estimates are indicative of producible quantities.

Natural Gas Proved reserves of natural gas in the United States, based upon the same definition as for crude oil and natural gas liquids, are estimated annually by the American Gas Association. The estimated

total additional potential supply remaining to be discovered is prepared by the Potential Gas Committee, sponsored by the Potential Gas Agency, Colorado School of Mines Foundation, Inc.

Estimates of proved reserves of natural gas in all countries of the world are published by *Oil and Gas Journal*. As with crude oil, large additional natural gas reserves are currently being discovered and developed in Alaska, the arctic regions, offshore areas, northern Africa, and other locations remote from consuming markets. Valid estimates of additional probable remaining reserves in the world are not available.

Coal (See also Secs. 7.1 and 7.2.) Authoritative information about reserves of coal is presented in *Geol. Surv. Bull.* 1412, Coal Resources of the United States. Remaining U.S. proved reserves (1974) of bituminous, subbituminous, lignite, and anthracite have been estimated by mapping and exploration of areas with 0 to 3,000-ft overburden. The U.S. Geological Survey (USGS) estimates probable additional resources in unmapped and unexplored areas with 0 to 3,000-ft overburden and in areas with 3,000- to 6,000-ft overburden. Slightly more than one-half of the proved reserves are considered producible (at this time) because of favorable depth of overburden and thickness of coal strata. Approximately 30 percent of all ranks of coal are commercially available in beds less than 1,000 ft deep. The USGS estimates that about 65 percent contains less than 1 percent sulfur; most of the low-sulfur coals are located west of the Mississippi. *USGS Bull.* 1412 also estimates global coal resources, but in view of the questionable validity of much of the global data, it can but offer gross approximations. (See Sec. 7.1.)

Shale Oil The portion of total U.S. reserves of oil from oil shale, measured or proved, considered minable and amenable to processing is estimated to be over 150 billion bbl (30 billion m³), based upon grades averaging 30 gal/ton in beds at least 100 ft thick (*USGS Bull.* 1412). Most oil shale occurs in Colorado. No commercial production is expected for many years. World reserves occur largely in the United States and Brazil, with small quantities elsewhere.

Tar Sands Large deposits are in the Athabasca area of northern Alberta, Canada, estimated capable of producing 100 to 300 billion bbl (15.9 to 47.7 billion m³) of oil. About 6.3 billion bbl (1.0 billion m³) has been proved economically recoverable within the radius of the present large mining and recovery plant in Athabasca. Commercial quantities of oil have been produced there since the 1960s. Sizable deposits are lo-

Table 9.1.1 Major U.S. Coal-Producing Locations

Anthracite and semianthracite
Pennsylvania

Bituminous coal

Illinois
West Virginia
Kentucky
Colorado
Pennsylvania
Ohio
Indiana
Missouri

Subbituminous coal

Montana
Alaska
Wyoming
New Mexico

Lignite

North Dakota
Montana

cated elsewhere; they have not been exploited to date, meaningful data for them are not available, and there is no report of those other deposits having been worked. (See Sec. 7.1.)

Nuclear Fuels

Uranium Reserves of uranium in the United States are reported by the Department of Energy (DOE). The proved reserves, usually presented in terms of quantity of U_3O_8 , refer to ore deposits (concentrations of 0.01 percent, or 0.0016 oz/lb ore, are viable) of grade, quantity, and geological configuration that can be mined and processed profitably with existing technology. *Estimated additional resources* refer to uranium surmised to occur in unexplored extensions of known deposits or in undiscovered deposits in known uranium districts, and which are expected to be discovered and economically exploitable in the given price range. The total of these uranium reserves would yield about 3,000 tons of U_3O_8 . United States uranium resources are located mainly in New Mexico, Wyoming, and Colorado.

Thorium Total known resources of thorium, the availability of which is considered reasonably assured, are estimated in the millions of tons of thorium oxide. Additional actual reserves will increase in response to the demand and concomitant market price. Most of the larger known resources are in India and Brazil. There seems to be little prospect of significant requirements for thorium as a nuclear fuel in the near future.

Hydroelectric Power

Hydroelectric and Pumped Storage for Electric Generation Although most available sites for economical production of hydroelectric energy have been developed, some additional hydroelectric capacity will be provided at new sites or by additions at existing plants. Increased pumped storage capacity will be limited by the availability of suitable sites and a dependable supply of economical pumping energy. The flexibility of operation of a pumped storage plant in meeting sudden load changes and its ability to provide high inertia spinning reserve at low operating cost are additional benefits that can weigh heavily in favor of this type of installation, particularly in the future if (when) the proportion of nuclear capacity in service increases. At this time, hydro and pumped storage account for about 10 percent of electricity generated by all sources of energy in the United States.

World installed hydropower capacity presently is located about 40 percent in North America and 40 percent in Europe.

ALTERNATIVE ENERGY, RENEWABLE ENERGY, AND ENERGY CONVERSION: AN INTRODUCTION Staff Contribution

REFERENCES: AAAS, *Science*. Hottell and Howard, "New Energy Technology—Some Facts and Assessments," MIT Press. Fisher, "Energy Crises in Perspective," Wiley-Interscience. Hammond, Metz, and Maugh, "Energy and the Future," AAAS.

Many sources of raw energy have been proposed or used for the generation of power. Only a few sources—fossil fuels, nuclear fission, and elevated water—are dominant in practical applications today.

A more complete list of sources would include fossil fuels (coal, petroleum, natural gas); nuclear (fission and fusion); wood and vegetation; elevated water supply; solar; winds; tides; waves; geothermal; muscles (human, animal); industrial, agricultural, and domestic wastes; atmospheric electricity; oceanic thermal gradients; oceanic currents. There are others.

Historically, wood, muscles, elevated water, and wind were prominent. These sources were superseded in the industrial era by fossil fuels, with nuclear energy the most recent addition. This dominance rests in the suitability of the thermal sources for practical stationary and transportation power plants. Features of acceptability include reliability, flexibility, portability, maneuverability, size, bulk, weight, efficiency, economy, maintenance, and costs. The plant for transportation service

must be self-contained. For stationary service there is wider latitude for choice.

The dominant end product, especially for stationary applications, is electricity, because of its favorable distribution and control features. However, there is no practical way of storing electric energy. Electricity must be generated at the instant of its use. Reliability and continuity of service consequently dictate the need for reserve, alternate, and inter-connection supports. Pumped storage, coal piles, and tanks of liquid and gaseous fuels, e.g., offer the necessary continuity, flexibility, and reliability.

Raw energy sources, other than fuels (fossil and nuclear) and elevated water, are particularly deficient in this storage aspect. For example, wind power is best for jobs that can wait for the wind, e.g., pumping water or grinding grain. Solar power, to avoid foul weather and the darkness of night, could call for desert locations or extraterrestrial satellites.

Despite such limitations an energy-intensive society can expect to see increasing efforts to harness many of the raw energy sources cited. Several of these topics are treated in the following pages to show the factual and technical progress that has been made to adapt sources to practicality.

MUSCLE-GENERATED POWER

by Ezra S. Krendel, Amended by Staff

REFERENCES: Whitt and Wilson, "Bicycling Science," 2d ed., MIT Press. Harrison, Maximizing Human Power Output by Suitable Selection of Motion Cycle and Load, *Human Factors*, 12, 1970. Krendel, Design Requirements for Man-Generated Power, *Ergonomics*, 3, 1960. Wilkie, Man as a Source of Mechanical Power, *Ergonomics*, 3, 1960. Brody, "Bioenergetics and Growth," Reinhold.

The use of human muscles to generate work will be examined from two points of view. The first is that of measuring the energy expended in gross, long duration physical activities such as marching, forestry work, freight handling, and factory work. The second is that of determining the useful mechanical work which can be performed by specified muscle groups for brief or extended periods of time in well defined work situations, such as pedaling or cranking.

Labor

Over an 8-h day for a 48-h week, a useful norm for a 35-year-old laborer for total power expenditure, including basal metabolism energy, is 0.49 hp (366 W). Of this total expenditure, approximately 0.1 hp (75 W) is available for useful work. A 20-year-old man can generate about 15 percent more power than this norm, and a 60-year-old man about 20 percent less. The total energy or power expenditure is needed for determining nutritional requirements for classes of labor. A rule of thumb for power developed by European males can be expressed as a function of age and duration of effort in minutes for work lasting from 4 to about 480 min, assuming that 20 percent of the total output is useful power.

Age, years	Useful horsepower (t in min)
20	$hp = 0.40 - 0.10 \log t$
35	$hp = 0.35 - 0.09 \log t$
60	$hp = 0.30 - 0.08 \log t$

For a well-trained man, useful power production by pedaling, hand cranking, or a combination of the two for working durations of from 20 to 120 s may be summarized as follows (t is in seconds):

Arms and legs	$hp = 4.4t^{-0.40}$
Legs only	$hp = 2.8t^{-0.40}$
Arms only	$hp = 1.5t^{-0.40}$

There are examples of well-trained athletes generating between 1.5 and 2 hp for efforts of 5 to 20 s, using both arms and legs to generate power.

For pedaling efforts of from 1 to about 100 min, the useful power generated may be expressed as $hp = 0.53 - 0.13 \log t$ (t is in minutes).

Work scheduling, either as rhythmic work activity or with rest stops for recuperation, the temperature and humidity of the environment, and the detailed nature of the laborer's diet are factors which influence ability to generate and maintain the above nominal power values. These considerations should be factored in for specific work situations.

Steady State and Transient

When a human and a passive mechanism are working together to generate power, the following conditions obtain: Energy is available both from stores residing in the muscles [a total usefully available energy of about $0.6 \text{ hp} \cdot \text{min}$ (27 kJ), usually applied in transient bursts of activity] and from the oxidation of foods (for producing steady state power). For an aerobic transient activity, energy production depends on the mass of muscle which can be brought into effective contact with the power transmission mechanism. For example, bicycle pedaling is an effective use of a large muscle mass. For steady-state activity, assuming adequate food for fuel energy, power generated depends on the oxygen supply and the efficiency with which oxygenated blood can be transported to the muscles as well as on the muscle mass.

The **physiological limit**, determined by oxygen-respiration capacity, for steady-state useful mechanical power generation is between 0.4 and 0.54 hp (300 and 400 W), depending on the man's physical condition.

Useful power production may be achieved by such methods as rowing, cranking, or pedaling. The **highest values** of human-generated horsepower using robust subjects have been achieved using a rowing assembly which restrained nonuseful motions of the torso and major limbs. Under these conditions up to 2 hp (1,500 W) was generated over intervals of 0.6 s, and averages of about 1 hp (750 W) were generated over 2 min.

In order to approach an optimal **conversion efficiency** (mechanical work/food energy) of 25 percent, a mechanism would be required to store and to transmit energy from the body muscle masses when they were operating at optimal efficiency. This condition occurs when the force exerted by the muscle is about one-half of its maximum and the speed of muscle movement one-quarter of its maximum. Data on both force and speed for a given set of muscles are best measured in situ. Optimal conversion efficiency and maximum output power do not occur together.

Examples of High Output

Data for human-generated power come from measurements of subjects with different kinds of training, skill, body builds, diets, and motivation using a variety of mechanical devices such as bicycles, ergometers, and variations on rowing machines. For strong, healthy young men, aggregations of such data for power produced in an interval t of 10 to 120 s can be approximated as follows:

$$hp = 2.5t^{-0.40}$$

For world-class athletes this becomes $hp = 0.25 + 2.5t^{-0.40}$. These values can be exceeded for bursts of power of less than 10 s. For long-term efforts of from 2 to about 200 min, the aggregated data for useful power generated by strong, healthy young men can be approximated as follows (t in minutes):

$$hp = 0.50 - 0.13 \log t$$

For world-class athletes this becomes $hp = 0.65 - 0.13 \log t$. The pilot of the Gossamer Albatross, who flew 22 mi from England to France in 2 h 55 min on August 12, 1979 entirely by pedal-generated power, sustained an output of about $\frac{1}{2}$ hp (250 W) during the flight.

Maximum power output occurs at a load impedance of 5 to 10 times the size of the human being's source impedance.

Brody has developed detailed nomograms for determining the energetic cost of muscular work by farm animals; these nomograms are useful for precise cost-effectiveness comparisons between animal and mechanical power generation methods. A 1,500- to 1,900-lb horse can work continuously for up to 10 h/day at a rate of 1 hp, or equivalently

pull 10 percent of its body weight for a total of 20 mi/day, and retain its vigor to an advanced age. Brody's work allows the following approximations for estimating the useful power output of work animals of varying sizes: The ratio of the power exerted in maximal energy production for a few seconds to the maximum steady-state power maintained for 5 to 30 min to the power produced in sustained heavy work over a 6- to 10-h day is approximately 25:4:1. For any one of these conditions, it has been found that, for healthy, mature specimens,

$$hp_{\text{animal}} = hp_{\text{man}}(\text{mass of animal/mass of man})^{0.73}$$

Thus, from the previously given horsepower magnitudes for men, one can compute the power generated by ponies, horses, bullocks, or elephants under the specified working conditions.

WIND POWER

by R. Ramakumar and C. P. Butterfield

REFERENCES: NREL technical information at Internet address: <http://gopher.nrel.gov.70>. AWEA information at Internet address: [avea.wind-net@notes.igc.apc.org](http://www.avea.wind-net@notes.igc.apc.org). Hansen and Butterfield, Aerodynamics of Horizontal-Axis Wind Turbines, *Ann. Rev. Fluid Mech.*, **25**, 1993, pp. 115–149. Touryan, Strickland, and Berg, "Electric Power from Vertical-Axis Wind Turbines," *J. Propulsion*, **3**, no. 6, 1987. Betz, "Introduction to the Theory of Flow Machines," Pergamon, New York. Eldridge, "Wind Machines," 2d ed., Van Nostrand Reinhold, New York. Glauert, "Aerodynamic Theory," Durand, ed., 6, div. L, p. 324, Springer, Berlin, 1935. Richardson and McNerney, Wind Energy Systems, *Proc. IEEE*, **81**, no. 3, Mar. 1993, pp. 378–389. Elliott et al., "Wind Energy Resource Atlas," Wilson and Lissaman, Applied Aerodynamics of Wind Power Machines, Oregon State University Report, 1974. Eggleston and Stoddard, *Wind Turbine Engineering Design*, New York, Van Nostrand Reinhold. Spera, *Wind Turbine Technology*, ASME Press, New York. Gipe, "Wind Power for Home and Business," Chelsea Green Publishing Company. Ramakumar et al., Economic Aspects of Advanced Energy Technologies, *Proc. IEEE*, **81**, no. 3, Mar. 1993, pp. 318–332.

Wind is one of the oldest widely used sources of energy. Although its use is many centuries old, it has not been a dominant factor in the energy picture of developed countries for the past 50 years because of the abundance of fossil fuels. Recently, the realization that fossil fuels are in limited supply has awakened the need to develop wind power with modern technology on a large scale. Consequently, there has been a tremendous resurgence of effort in wind power in just the past few years. The state of knowledge is rapidly increasing, and the reader is referred to the current literature and the NREL Internet address cited above for information on the latest technology. Wind energy is one of the lowest-cost forms of renewable energy. In 1995, more than 1,700 MW of wind energy capacity was operating in California, generating enough energy to supply a city the size of San Francisco with all its energy needs. European capacity was almost the same. For the latest status on worldwide use of wind energy, the reader is referred to the American Wind Energy Association (AWEA) at the Internet address cited above. The fundamental principles of wind power technology do not change and are discussed here.

Wind Turbines The essential ingredient in a wind energy conversion system (WECS) is the wind turbine, traditionally called the windmill. The predominant configurations are **horizontal-axis propeller turbines (HAWTs)** and **vertical-axis wind turbines (VAWTs)**, the latter most often termed **Darrieus rotors**. In the performance analysis of wind turbines, the propeller devices were studied first, and their analysis set the current conventions for the evaluation of all turbines.

General Momentum Theory for Horizontal-Axis Turbines Conventional analysis of horizontal-axis turbines begins with an axial momentum balance originated by Rankine using the control volume depicted in Fig. 9.1.1. The turbine is represented by a porous disk of area A which extracts energy from the air passing through it by reducing its pressure: on the upstream side the pressure has been raised above atmospheric by the slowing airstream; on the downstream side pressure is lower, and atmospheric pressure will be recovered by further slowing of the stream. V is original wind speed, decelerated to $V(1 - a)$ at the turbine

disk, and to $V(1 - 2a)$ in the wake of the turbine (a is called the interference factor). Momentum analysis predicts the axial thrust on the turbine of radius R to be

$$T = 2\pi R^2 \rho V^2 a(1 - a) \quad (9.1.1)$$

where air density, ρ , equals $0.00237 \text{ lbf} \cdot \text{s}^2/\text{ft}^4$ (or $1.221 \text{ kg}/\text{m}^3$) at sea-level standard-atmosphere conditions.

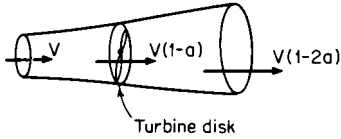

Fig. 9.1.1 Control volume.

Application of the mechanical energy equation to the control volume depicted in Fig. 9.1.1 yields the prediction of power to the turbine of

$$P = 2\pi R^2 \rho V^3 a(1 - a)^2 \quad (9.1.2)$$

This power can be nondimensionalized with the energy flux E in the upstream wind covering an area equal to the rotor disk, i.e.,

$$E = \frac{1}{2} \rho V^3 \pi R^2 \quad (9.1.3)$$

The resulting power coefficient is

$$C_p = \frac{P}{E} = 4a(1 - a)^2 \quad (9.1.4)$$

This power coefficient has a theoretical maximum at $a = \frac{1}{3}$ of $C_p = 0.593$. This result was first predicted by Betz and shows that the load placed on a windmill must be optimized to obtain the best power output: If the load is too small (small a), too much of the power is carried off with the wake; if the load is too large (large a), the flow is excessively obstructed and most of the approaching wind passes around the turbine.

This derivation includes some important assumptions which limit its accuracy and applicability. In particular, the portion of the kinetic energy in the swirl component of the wake is neglected. Partial accounting for the rotation in the wake has been included in the analysis of Glauert with the resulting prediction of ideal power coefficient as a function of turbine tip speed ratio $X = \Omega R/V$ (where Ω is the angular velocity of the turbine) shown in Fig. 9.1.2. Clearly, the swirl is made up of wasted kinetic energy and is largest for a high-torque, low-speed turbine. Actual farm, multiblade, and two- or three-bladed turbines show somewhat lower than ideal performance because of drag effects neglected in ideal flow analysis, but the high-speed two- or three-bladed turbines do tend to yield higher efficiency than low-speed multiblade windmills.

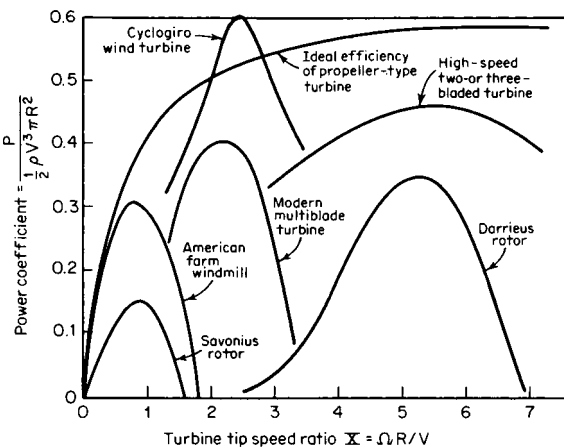

Fig. 9.1.2 Performance curves for wind turbines.

Blade Element Theory for Horizontal-Axis Turbines Wilson and Eggleston describe blade element theory as a mechanism for analyzing the relationship between the individual airfoil properties and the interference factor a , the power produced P , and the axial thrust T of the turbine. Rather than the stream tube of Fig. 9.1.1, the control volume consists of the annular ring bounded by streamlines depicted in Fig. 9.1.3. It is assumed that the flow in each annular ring is independent of the flow in all other rings.

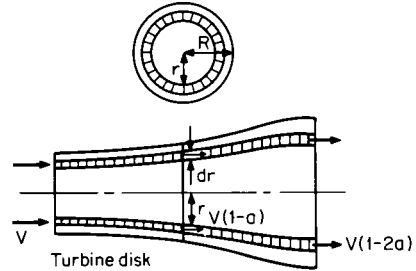

Fig. 9.1.3 Annular ring control volume.

A schematic of the velocity and force vector diagrams is given in Fig. 9.1.4. The turbine is defined by the number B of its blades, by the variation of chord c , by the variation in blade angle θ , and by the shape of blade sections $a' = \omega/(2\Omega)$, where ω is the angular velocity of the air just behind the turbine and Ω is the turbine angular velocity. Also W is the velocity of the wind relative to the airfoil. Note that the angle ϕ will be different for each blade element, since the velocity of the blade is a function of the radius. In order to keep the local flow angle of attack $\alpha = \theta - \phi$ at a suitable value, it will generally be necessary to construct twisted blades, varying θ with the radius. The sectional lift and drag coefficients C_L and C_D are obtained from empirical airfoil data and are unique functions of the local flow angle of attack $\alpha = \theta - \phi$ and the local Reynolds number of the flow. The entire calculation requires trial-and-error procedures to obtain the axial interference factor a and the angular velocity fraction a' . It can, however, be reduced to programs for small computers.

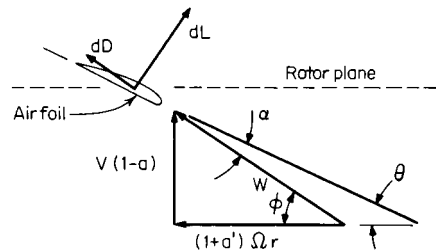

Fig. 9.1.4 Velocity and force vector diagrams.

A typical solution for steady-state operation of a two- or three-bladed wind axis turbine is shown in Fig. 9.1.2. When optimized, these turbines run at high tip speed ratios. The curve shown in Fig. 9.1.2 for the two- or three-bladed wind turbine is for constant blade pitch angle. These turbines typically have pitch change mechanisms which are used to feather the blades in extreme wind conditions. In some instances the blade pitch is continuously controlled to assist the turbine to maintain constant speed and appropriate output. Turbines with continuous pitch control typically have flatter, more desirable operating curves than the one depicted in Fig. 9.1.2.

The traditional U.S. farm windmill has a large number of blades with a high solidity ratio σ . (σ is the ratio of area of the blades to swept area of the turbine πR^2 .) It operates at slower speed with a lower power coefficient than high-speed turbines and is primarily designed for good starting torque.

The curves depicted in Fig. 9.1.2 representing the performance of high- and low-speed wind axis turbines are theoretically predicted performance curves which have been experimentally confirmed.

Vertical-Axis Turbines The Darrieus rotor looks somewhat like an eggbeater (Fig. 9.1.5). The blades are high-performance symmetric airfoils formed into a gentle curve to minimize the bending stresses in the blades. There are usually two or three blades in a turbine, and as shown in Fig. 9.1.2, the turbines operate efficiently at high speed. Wilson shows that VAWT performance analysis also takes advantage of the same momentum principles as the horizontal axis wind turbines. However, the blade element momentum analysis becomes much more complicated (see Touryan et al.).

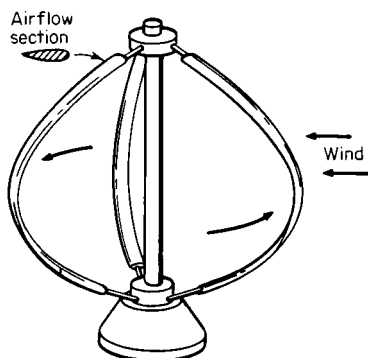

Fig. 9.1.5 Darrieus rotor.

Care must be taken not to overemphasize the aerodynamic efficiency of wind turbine configurations. The most important criterion in evaluating WECSs is the power produced on a per-unit-cost basis.

Drag Devices Rotors utilizing drag rather than lift have been constructed since antiquity, even though they are bulky and limited to low coefficients of performance. The Savonius rotor is a modern variation of these devices; in practice it is limited to small sizes. Eldridge describes the history and theory of this type of windmill.

Augmentation Occasionally, the use of structures designed to concentrate and equalize the wind at the turbine is proposed. For its size, the most effective of these has been a short diffuser (hollow cone) placed around and downwind of a wind turbine. The disadvantage of such augmentation devices is the cost of the bulky static structures required.

Rotor Configuration Trends Hansen and Butterfield describe some trends in turbine configurations which have developed from 1975 to 1995. Although no single configuration has emerged which is clearly superior, HAWTs have been more widely used than VAWTs. Only about 3 percent of turbines installed to date are VAWTs.

HAWT rotors are generally classified according to rotor orientation (upwind or downwind of the tower), blade articulation (rigid or teetering), and number of blades (generally two or three). **Downwind turbines** were favored initially in the United States, but the trend has been toward greater use of **upwind turbines** with a current split between upwind (55 percent) and downwind (45 percent) configurations.

Downwind orientation allows blades to deflect away from the tower when thrust loading increases. Coning can also be easily introduced to decrease mean blade loads by balancing aerodynamic loads with centrifugal loads. Figure 9.1.6 shows typical upwind and downwind configurations along with definitions for blade coning and yaw orientation.

Free yaw, or passive orientation with the wind direction, is also possible with downwind configurations, but yaw must be actively controlled with upwind configurations. Free-yaw systems rely on rotor thrust loads and blade moments to orient the turbine. Net yaw moments for rigid rotors are sensitive to inflow asymmetry caused by turbulence, wind shear, and vertical wind. These are in addition to the moments caused by changes in wind direction which are commonly, though often incorrectly, considered the dominant cause of yaw loads.

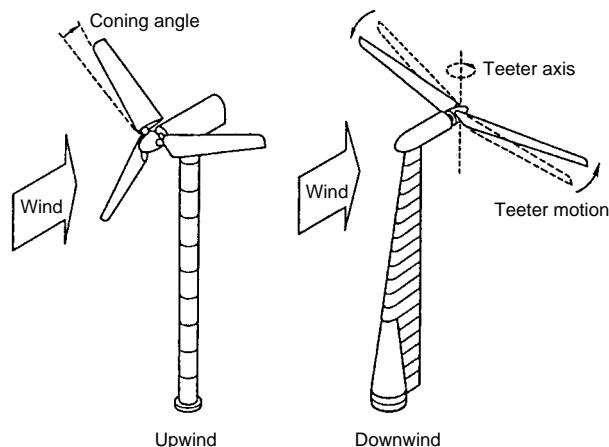

Fig. 9.1.6 HAWT configurations. (Courtesy of Atlantic Orient Corp.)

Some early downwind turbine designs developed a reputation for generating subaudible noise as the blades passed through the tower shadow (tower wake). Most downwind turbines operating today have greater tower clearances and lower tip speeds, which result in negligible infrasound emissions (Kelley and McKenna, 1985).

Blade Articulation Several different rotor blade articulations have been tested. Only two have survived—the three-blade, rigid rotor and the two-blade, teetered rotor. The rigid, three-blade rotor attaches the blade to a hub by using a stiff cantilevered joint. The first bending natural frequency of such a blade is typically greater than twice the rotor rotation speed $2p$. Cyclic loads on rigid blades are generally higher than on teetering blades of the same diameter. Richardson and McNerney describe a 33-m, 300-kW turbine currently under development which reflects a mature version of this configuration.

Teetered, two-blade rotors use relatively stiff blades rigidly connected to a hub, but the hub is attached to the main drive shaft through a **teeter hinge**. This type rotor is commonly used in tail rotors and some main rotors on helicopters. Two-blade rotors usually require teeter hinges or flexible root connections to reduce dynamic loading resulting from nonaxisymmetric mass moments of inertia. In normal operation, the cyclic loads on the teetering rotor are low, but there is risk of teeter-stop bumping (“mast bumping” in helicopter terminology) that can greatly increase dynamic loads in unusual situations.

Number of Blades Most two-blade rotors operating today use teetering hinges, but all three-blade rotors use rigid root connections. For small turbines (smaller than 50-ft diameter) rigid, three-blade rotors are inexpensive and simple and have the lowest system cost. As the turbines become larger, blade weight (and hence cost) increases in proportion to the third power of the rotor diameter, whereas power output increases only as the square of the diameter. This makes it cost-effective to reduce the number of blades to two and to add the complexity of a teeter hinge or flex beams to reduce blade loads. In the midscale rotor size (15 to 30 m), it is difficult to determine whether three rigidly mounted blades or two teetered blades are more cost-effective. In many cases, the choice between two- and three-blade rotors has been driven by designers’ lack of experience and the potential risk of high development cost rather than by technical and economic merit. Currently 10 percent of the turbines installed are two-bladed, yet approximately 60 percent of all new designs being considered in the United States are two-blade, teetered rotors.

Design Problems A key design consideration is survival in severe storms. Various systems for furling the rotor, feathering the blades, or braking the shaft have been employed; failure of these systems in a high wind has been known to cause severe damage to the turbine.

A different, but related, consideration is the control of the turbine after a loss of electrical load, which also could cause severe overspeeding and catastrophic failure.

The other major cause of mechanical failure is the high level of vibration and alternating stresses. Loosening of inappropriately chosen fasteners is common. Fatigue considerations must be taken into account, especially at the rotor blade root.

Resonant oscillations are also possible if exciting frequencies and structural frequencies coincide. The dominant exciting frequency tends to be the blade passage frequency, which is equal to the number of blades times the revolutions per second. An important structural frequency in HAWTs is the natural frequency of the tower. One design approach is to make the tower so stiff that the exciting frequency is always below the lowest natural frequency of the tower. Another is to permit the tower to be more flexible, but manage the speed of the turbine such that the exciting frequency is never at a structural frequency for any significant length of time.

Use of Wind Energy Conversion Systems Historically, wind energy conversion systems were first used for milling grain and for pumping water. These tasks were ideally suited for wind power sources, since the intermittent nature of the wind did not adversely affect the operation.

The largest impact of wind power on the energy picture in the developed countries of the world is expected to be in the generation of electric power. In most cases, this involves feeding power into the power grid, and requires induction or synchronous generators. These generators require that the rotor turn at a constant speed. Wind turbines operate more efficiently (aerodynamically speaking) if they turn at an optimum ratio of tip speed to wind speed. Thus the use of variable-speed operation, using power electronics to obtain constant-frequency utility-grade

ac power, has become attractive. Richardson describes the modern use of variable speed in wind turbines.

Gipe explains that in remote locations, where the power grid is not accessible and the first few units of electric energy may be very valuable, dc generation with storage and/or wind and diesel "village power systems" have been used. These systems are now being optimized to supply stable, constant-frequency ac electric energy.

Power in the Wind Since wind is air in motion, the power in wind can be expressed as

$$P_w = \frac{1}{2} \rho V^3 A \quad (9.1.5)$$

where P_w = power, W; A = reference area, m^2 ; V = wind speed, m/s ; ρ = air density, kg/m^3 . Since V appears to the third power, the wind speed is clearly very important. Figure 9.1.7 is a map of the United States showing regions of annual average available wind power.

The wind speed at a location is random; thus it can be modeled as a continuous random variable in terms of a density function $f(v)$ or a distribution function $F(v)$. The Weibull distribution is commonly used to model wind:

$$F(v) = 1 - \exp [-(v/\alpha)^\beta] \quad (9.1.6)$$

$$f(v) = \beta(v^{\beta-1}/\alpha^\beta) \exp [-(v/\alpha)^\beta] \quad (9.1.7)$$

In Eqs. (9.1.6) and (9.1.7), α and β are two parameters which can be adjusted to fit available data over the study period, typically one month. They can be calculated from the sample mean m_v and the sample variance σ_v^2 using the following equations:

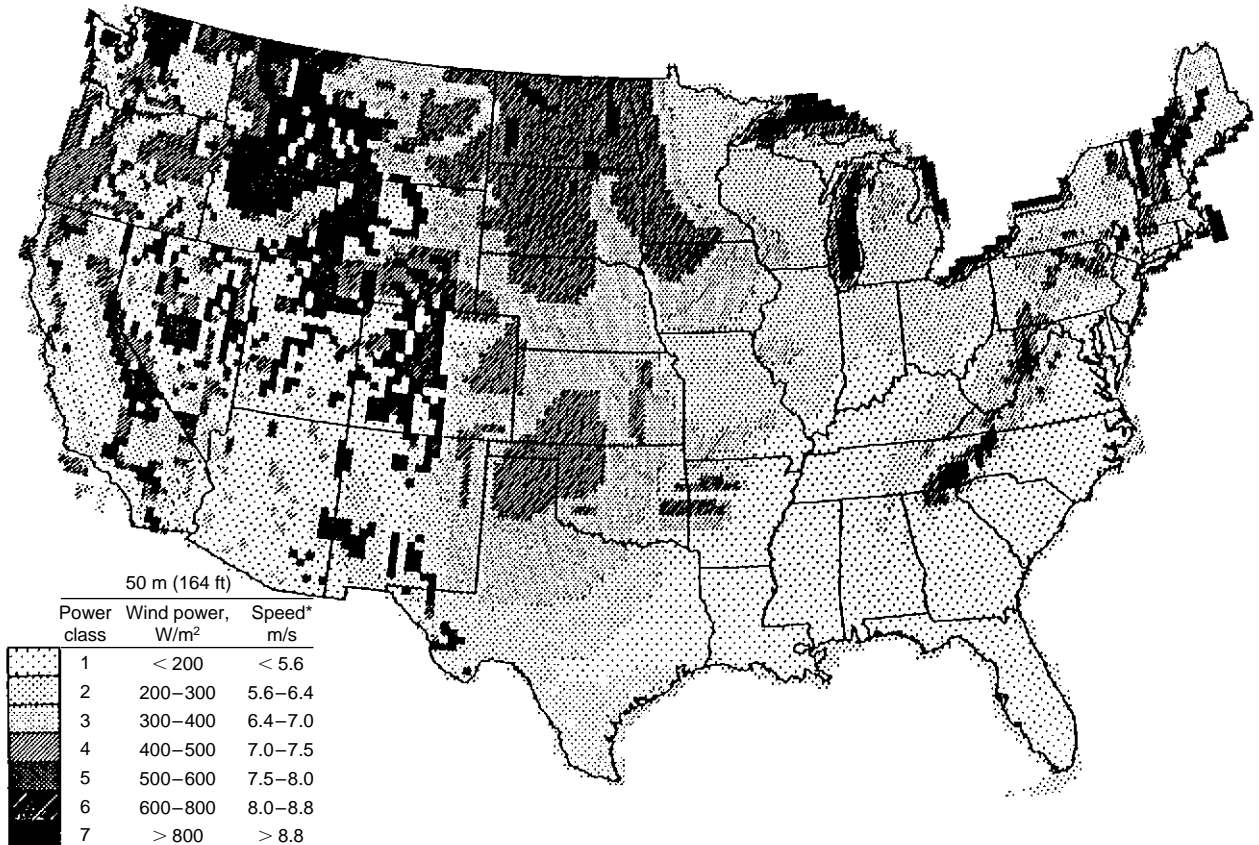

*Equivalent wind speed at sea level for a Rayleigh distribution.

Fig. 9.1.7 Gridded map of annual average wind energy resource estimates in the contiguous United States. Grid cells are $\frac{1}{4}^\circ$ latitude by $\frac{1}{2}^\circ$ longitude.

$$m_v = \alpha\Gamma(1 + 1/\beta) \tag{9.1.8}$$

$$(\sigma_v/m_v)^2 = \Gamma(1 + 2/\beta)/\Gamma^2(1 + 1/\beta) - 1 \tag{9.1.9}$$

Typically, the sample mean is the only piece of information readily available for many potential sites. In such cases, a knowledge of the variability of the wind speed can be used to select an appropriate value for β , which can be used in (9.1.8) to obtain α . A good compromise value for β is about 4 for wind regimes with low variances.

In addition to α and β , several other parameters are used to characterize wind regimes. Some of the important ones are listed below.

$$\begin{aligned} \text{Mean cubed wind speed} &= \langle v^3 \rangle \\ &= \int_0^\infty v^3 f(v) dv \end{aligned} \tag{9.1.10}$$

$$\begin{aligned} \text{Cube factor } K_c &= (\langle v^3 \rangle)^{1/3} / m_v \\ &= \alpha^3 \Gamma(1 + 3/\beta) \\ &\text{for Weibull model} \end{aligned} \tag{9.1.11}$$

$$\text{Average power density} = P_{av} = \frac{1}{2} \rho \langle v^3 \rangle \quad \text{W/m}^2 \tag{9.1.12}$$

$$\text{Energy pattern factor} = K_{ep} = \langle v^3 \rangle / m_v^3 = K_c^3 \tag{9.1.13}$$

Values of K_{ep} range from 1.5 to 3 for typical wind regimes.

The annual average available wind power for the contiguous United States is shown in Fig. 9.1.7. The values shown must be regarded as averages over large areas. The possibility of finding small pockets of sites with excellent wind regimes because of special terrain anywhere in the country should not be overlooked. The variability of the wind can also be shown in terms of a speed duration curve. Figure 9.1.8 shows the wind speed duration curve for Plum Brook, OH, for 1972.

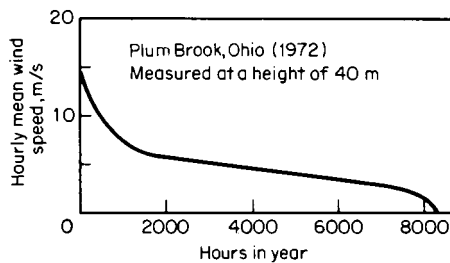

Fig. 9.1.8 Wind variability at Plum Brook, OH (1972).

Wind speed varies with the height above ground level (Fig. 9.1.9). Anemometers are usually located at a height of 10 m above ground level. The long-term average wind speed at height h above ground can be expressed in terms of the average wind speed at 10-m height using a one-seventh power law:

$$(v/v_{10m}) = (h/10)^{1/7} \tag{9.1.14}$$

The power $1/7$ in the power law equation above depends on surface roughness and other terrain-related factors and can range from 0.1 to 0.3. The value of $1/7$ should be regarded as a compromise value in the absence of other information regarding the terrain. Clearly, it is advantageous to construct an adequately high support tower for a wind energy conversion system.

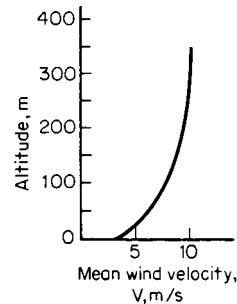

Fig. 9.1.9 Typical variation of mean wind velocity with height.

Table 9.1.2 shows average and peak wind velocities at locations within the continental United States.

Wind to Electric Power Conversion The ease with which wind energy can be converted to rotary mechanical energy and the maturity of electromechanical energy converters and solid-state power conditioning equipment clearly point to wind-to-electric conversion as the most promising approach to harnessing wind power in usable form.

The electric power output of a wind-to-electric conversion system can be expressed as

$$P_e = \frac{1}{2} \rho \eta_g \eta_m \eta_p A C_p V^3 \tag{9.1.15}$$

Table 9.1.2 Wind Velocities in the United States

Station	Avg velocity, mi/h	Prevailing direction	Fastest mile	Station	Avg velocity, mi/h	Prevailing direction	Fastest mile
Albany, N.Y.	9.0	S	71	Louisville, Ky.	8.7	S	68
Albuquerque, N.M.	8.8	SE	90	Memphis, Tenn.	9.9	S	57
Atlanta, Ga.	9.8	NW	70	Miami, Fla.	12.6	—	132
Boise, Idaho	9.6	SE	61	Minneapolis, Minn.	11.2	SE	92
Boston, Mass.	11.8	SW	87	Mt. Washington, N.H.	36.9	W	150
Bismarck, N. Dak.	10.8	NW	72	New Orleans, La.	7.7	—	98
Buffalo, N.Y.	14.6	SW	91	New York, N.Y.	14.6	NW	113
Burlington, Vt.	10.1	S	72	Oklahoma City, Okla.	14.6	SSE	87
Chattanooga, Tenn.	6.7	—	82	Omaha, Neb.	9.5	SSE	109
Cheyenne, Wyo.	11.5	W	75	Pensacola, Fla.	10.1	NE	114
Chicago, Ill.	10.7	SSW	87	Philadelphia, Pa.	10.1	NW	88
Cincinnati, Ohio	7.5	SW	49	Pittsburgh, Pa.	10.4	WSW	73
Cleveland, Ohio	12.7	S	78	Portland, Maine	8.4	N	76
Denver, Colo.	7.5	S	65	Portland, Ore.	6.8	NW	57
Des Moines, Iowa	10.1	NW	76	Rochester, N.Y.	9.1	SW	73
Detroit, Mich.	10.6	NW	95	St. Louis, Mo.	11.0	S	91
Duluth, Minn.	12.4	NW	75	Salt Lake City, Utah	8.8	SE	71
El Paso, Tex.	9.3	N	70	San Diego, Calif.	6.4	WNW	53
Galveston, Tex.	10.8	—	91	San Francisco, Calif.	10.5	WNW	62
Helena, Mont.	7.9	W	73	Savannah, Ga.	9.0	NNE	90
Kansas City, Mo.	10.0	SSW	72	Spokane, Wash.	6.7	SSW	56
Knoxville, Tenn.	6.7	NE	71	Washington, D.C.	7.1	NW	62

U.S. Weather Bureau records of the average wind velocity, and fastest mile, at selected stations. The period of record ranges from 6 to 84 years, ending 1954. No correction for height of station above ground.

where P_e = electric power output, W; η_g and η_m = efficiencies of the electric generator and the mechanical interface, respectively; η_p = efficiency of the power conditioning equipment (if employed). The product of these efficiencies and the coefficient of performance (Fig. 9.1.2) usually will be in the range of 20 to 35 percent.

The electrical equipment needed for wind-to-electric conversion depends, above all, on whether the aeroturbine is operated in the constant-speed, nearly constant-speed, or variable-speed mode. With constant-speed and nearly constant-speed operation, the power coefficient C_p in Eq. (9.1.15) becomes a function of wind speed. If variable-speed mode is used, it is possible to operate the turbine at a constant optimum C_p over a range of wind speeds, thus extracting a larger fraction of the energy in the wind.

Synchronous and induction generators are ideally suited for constant-speed and nearly constant-speed operation, respectively. Variable-speed operation requires special and/or additional electrical hardware if constant-frequency utility-grade ac power output is desired. Most of the early prototypes employed constant-speed operation and synchronous generators. However, power oscillations due to tower interference and wind shear effects can be nearly eliminated by operating the turbine and the generator in variable-speed mode over at least some limited range of speeds. It appears likely that large (greater than 100-kW) wind-to-electric systems may employ some kind of a variable-speed constant-frequency power generation scheme in the future.

Several options are available for obtaining constant frequency utility-grade ac output from wind-to-electric systems operated in the variable-speed mode. Some of the schemes suggested are: permanent magnet alternator with output rectification and inversion, dc generator feeding a line commutated (synchronous) or force commutated inverter, ac commutator generator, ac-dc-ac link, field modulated generator system, and slip ring induction machines operated as generators with rotor power conditioning. The last type is also known as a double output induction generator or simply a doubly fed machine. In general, the simpler the electrical generation scheme, the poorer the quality of the constant-frequency ac output. For example, synchronous inverters are very simple, are economical, and have been popular in small (less than 50 kW) commercial units; however, they have power quality and harmonic injection problems, and they absorb (on the average) more reactive voltamperes from the utility line than the watts they deliver. The latter is also a problem with simple induction generators. Schemes such as the field modulated generator system and doubly fed machine deliver excellent power quality, but at a higher cost for the hardware.

Economics Costs of wind energy systems are often divided into two categories: annualized fixed costs and operation and maintenance (O&M) costs. Annualized fixed costs are comprised primarily of the cost of capital required to purchase and install the turbines. In addition, they include certain fixed costs such as taxes and insurance. O&M costs include scheduled and unscheduled maintenance and the leveled cost for major equipment overhauls.

The initial capital cost of a wind turbine system includes the cost of the turbine, installation, and balance of plant. Turbine costs are often expressed in terms of nameplate rating (\$/kW). In 1995, utility-grade turbines cost on the order of \$800 per kilowatt. Installation and balance of plant costs add approximately 20 percent. The cost of capital varies, but (in 1995) was often estimated as 8 percent per annum for wind energy projects. Other fixed costs were estimated at around 3 percent of the installed turbine cost. The **fixed charge rate (FCR)**, combined capital and other fixed costs, was approximately 11 percent per annum. O&M costs in modern wind farms are around \$0.01 per kilowatthour (1995).

In addition to capital and O&M costs, an economic assessment of wind energy systems must account for system performance. A commonly used parameter that describes the production of useful energy by wind and other energy systems is the **capacity factor C**, also called the **plant factor** or **load factor**. It is the ratio of the annual energy produced (AEP) to the energy that would be produced if the turbine operated at full-rated output throughout the year:

$$C_f = \frac{\text{AEP}}{8,760 P_r} \quad (9.1.16)$$

where AEP is in kWh, 8,760 is the number of hours in 1 year, and P_r is the unit's nameplate rating in kW.

In order of decreasing importance, C_f is affected by the average power available in the wind, speed vs. duration curve of the wind regime, efficiency of the turbine, and reliability of the turbine. Variable-speed turbines which tend to have low cut-in speeds and high efficiency in low winds exhibit better capacity factors than constant-speed turbines. Modern utility-grade turbines at good sites (class 4) can achieve capacity factors in the range of 25 to 30 percent.

The combination of cost and performance can be used to calculate the cost of energy (COE) as follows:

$$\text{COE} = \frac{\text{FCR} \times \text{ICC}}{8,760 C_f} + (\text{O\&M}) \quad (9.1.17)$$

where FCR is the fixed charge rate for the cost of capital and for other fixed charges such as taxes and insurance, ICC is the installed capital cost of the turbine and balance of plant in dollars per kilowatt. This method is useful to estimate the cost of energy for different technologies or sites. However, for investment decisions, more detailed analyses that include the effects of various investment strategies, tax incentives, and environmental factors should be performed. Ramakumar et al. discuss the economic aspects of advanced energy technologies, including wind energy systems.

POWER FROM VEGETATION AND WOOD

Staff Contribution

Vegetation offers, by photosynthesis, a natural process for the storage of solar energy. The efficiency of the photosynthetic process for the conversion of the sun's rays into a usable fuel form is low (less than 2 percent is probably realistic). Wood, wood waste, sawdust, hogged fuel, bagasse, straw, and tanbark have heating values ranging to $10,000 \pm$ Btu/lb (see Sec. 7.1). They may be incinerated for disposal as waste material or burned directly for the subsequent production of steam or hot water, most often used in the processing activities of the plant, e.g., hot water soak of logs for plywood peeling and steam for drying in paper mills. In food processing, fruit pits and nut shells have been used to generate a portion of the in-house requirements for steam.

The alternative to direct burning of the so-called biofuels lies in their possible conversion to gaseous fuel by gasification at high temperature in the presence of air. Pyrolytic treatment can render biofuels to fractions of liquids and gases that have thermal value. In both cases, the solid residue remaining also has some thermal value which can be utilized in normal combustion.

Tree farming, with controlled growth and cutting, proposes to balance harvesting plans to load demands; e.g., Szego and Kemp (*Chem. Tech.*, May 1973) project a 400-mi² "energy plantation" to serve a 400-MW steam electric plant. Such proposals would utilize proved steam power plant cycles and equipment for novel breeding, growing, harvesting, preparation, and combustion of vegetation. (See also Sec. 7.1.)

The **photosynthesis process** is basic to all agricultural practice. The human animal has long known how to convert grain to alcohol. It can be said that as long as we can grow green stuff we should be able to harness some of the sun's energy. The prohibition era in the United States saw many efforts to use the alcohol production capacity of the nation to offer alcohol as a substitute or supplementary fuel for internal combustion engines. Ethanol (C₂H₅OH) and methanol (CH₃OH) have properties that are basically attractive for internal combustion engines, to wit, smokeless combustion, high volatility, high octane ratings, high compression ratios ($R_v > 10$). Heating values are 9,600 Btu/lb for methanol and 12,800 Btu/lb for ethanol. On a volume basis these translate, respectively, to 63,000 and 85,000 Btu/gal for methanol and ethanol. Gasoline, by comparison, has 126,000 Btu/gal (20,700 Btu/lb). (See Sec. 7 for values.) The blending of ethanol and methanol with gasolines (9 \pm gasoline to 1 \pm alcohol) has been used particularly in Europe since the 1930s as a suitable internal combustion engine fuel. The miscibility of the lighter alcohols with water and gasoline introduces corrosion

problems for engine parts and lowers the octane number. Higher-carbon alcohols (e.g., butyl) which are immiscible with water are possible blending substitutes, but their availability and cost are not presently attractive. Such properties as flash point would introduce further problems. While these constitute some of the unsolved technical problems, the basic principle of harnessing the sun's energy through vegetation will continue as a provocative challenge not only in the field of power generation but also as a solution for the perennial farm problem of waste disposal.

SOLAR ENERGY

Erich A. Farber

REFERENCES: Daniels, "Direct Use of the Sun's Energy," Yale. ASHRAE, "Solar Energy Use for Heating and Cooling of Buildings." Duffie and Beckman, "Solar Engineering of Thermo Processes," Wiley, Lunde, "Solar Thermal Engineering," McGraw-Hill. Kreider and Kreith, "Solar Heating and Cooling," McGraw-Hill. ASHRAE, "Handbook of Fundamentals, 1993," "Handbook of Applications, 1982." Yellott, Selective Reflectance, *Trans. ASHRAE*, **69**, 1963. Hay, Natural Air Conditioning with Roof Ponds and Movable Insulation, *Trans. ASHRAE*, **75**, part I, p. 165, 1969. Backus, "Solar Cells," IEEE. Bliss, Atmospheric Radiation near the Surface of the Ground, *Solar Energy*, **5**, no. 3, 1961. Yellott, Passive and Hybrid Cooling Research, "Advances in Solar Energy—1982," American Solar Energy Soc., Boulder. Haddock, Solar Energy Collection, Concentration, and Thermal Conversion—A Review, *Energy Sources*, **13**, 1991, pp. 461–482. "Proceedings of the Intersociety Energy Conversion Conferences," annual (with the 29th in 1994), The University of Florida, "Erich A. Farber Archives." "European Directory of Renewable Energy, Suppliers and Services 1994," James & James Ltd., London, England.

Notation

A, R, T = subscripts denoting absorbed, reflected, and transmitted solar radiation

C = concentration ratio

c = subscript denoting collector cover

c_p = specific heat of fluid, Btu/(lb · °F)

I_{DN} = direct normal solar intensity, Btu/(ft² · h)

I_d = diffuse radiation, Btu/(ft² · h)

I_o = radiation intensity beyond earth's atmosphere, Btu/(ft² · h)

I_r = reflected solar radiation, Btu/(ft² · h)

I_{SC} = solar constant; normal incidence intensity at average earth-sun distance, Btu/(ft² · h)

I_t = total solar radiation, Btu/(ft² · h)

L = latitude, deg

m = air mass

o, i = subscripts denoting outgoing and incoming fluid conditions

q = rate of heat flux, Btu/(ft² · h)

q_l = heat flow through insulation, Btu/(ft² · h)

T_p = temperature of absorbing surface, °R

U = overall coefficient of heat transfer, Btu/(ft² · h · °F)

w_f = flow rate of collecting fluid, lb/(h · ft²)

ϕ = solar azimuth, deg from south

α, ρ, τ = absorptance, reflectance, and transmittance for solar radiation

β = solar altitude, deg

δ = solar declination, deg

ϵ = emittance for long-wave radiation

γ = wall-solar azimuth, deg

λ = unit of wavelength, μm

Σ = angle of tilt from horizontal, deg

θ = incident angle, deg, from perpendicular to surface

Introduction and Scope

The sun exerts forces upon the earth and radiates solar energy produced within the sun by nuclear fusion. A small fraction of that energy is intercepted by the earth and is converted by nature to heat, winds, ocean currents, waves, tides; makes plants grow, some of which over millions of years produced fossil fuels (oil, coal, and gas); and creates biomass which can be burned to generate heat and/or power. Solar energy is

implicit in many subject areas treated elsewhere in the Handbook; only the more direct uses such as water heating, space heating and cooling, swimming pool heating, solar distillation, solar drying and cooking, solar furnaces, solar engines, solar electricity generation, and solar assisted transportation will be treated here. The total field is widely termed *alternative or renewable sources of energy and their conversion*.

Solar Energy Utilization Solar energy reaches the earth's surface as shortwave electromagnetic radiation in the wavelength band between 0.3 and 3.0 μm ; its peak spectral sensitivity occurs at 0.48 μm (Fig. 9.1.10). Total solar radiation intensity on a horizontal surface at sea level varies from zero at sunrise and sunset to a noon maximum which can reach 340 Btu/(ft² · h) (1,070 W/m²) on clear summer days. This inexhaustible source of energy, despite its variability in magnitude and

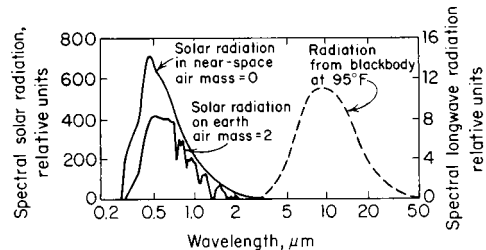

Fig. 9.1.10 Spectral distribution of solar radiation and radiation emitted by blackbody at 95°F (35°C).

direction, can be used in three major processes (Daniels, "Direct Use of the Sun's Energy," Yale; Zarem and Erway, "Introduction to the Utilization of Solar Energy," McGraw-Hill): (1) **Heliothermal**, in which the sun's radiation is absorbed and converted into heat which can then be used for many purposes, such as evaporating seawater to produce salt or distilling it into potable water; heating domestic hot water supplies; house heating by warm air or hot water; cooling by absorption refrigeration; cooking; generating electricity by vapor cycles and thermoelectric processes; attaining temperatures as high as 6,500°F (3,600°C) in solar furnaces. (2) **Heliochemical**, in which the shorter wavelengths can cause chemical reactions, can sustain growth of plants and animals, can convert carbon dioxide to oxygen by photosynthesis, can cause degradation and fading of fabrics, plastics, and paint, can be used to detoxify toxic waste, and can increase the rate of chemical reactions. (3) **Helioelectrical**, in which part of the energy between 0.33 and 1.3 μm can be converted directly to electricity by photovoltaic cells. Silicon solar batteries have become the standard power sources for communication satellites, orbiting laboratories, and space probes. Their use for terrestrial power generation is currently under intensive study, with primary emphasis upon cost reduction. Other methods include thermoelectric, thermionic, and photoelectromagnetic processes and the use of very small antennas in arrays for the conversion of solar energy to electricity (Antenna Solar Energy to Electricity Converter/ASETEC, Air Force Report, AF C FO 8635-83-C-0136, Task 85-6, Nov. 1988).

Solar Radiation Intensity In space at the average earth-sun distance, 92.957 million mi (150 million km), solar radiation intensity on a surface normal to the sun's rays is 434.6 ± 1 Btu/(ft² · h) ($1,370 \pm 3$ W/m²). This quantity, called the solar constant I_{SC} , undergoes small (± 1 percent) periodic variations which affect primarily the shortwave portion of the spectrum (Abbott, in Moon, Standard Polar Radiation Curves, *Jour. Franklin Inst.*, Nov. 1940). Recent measurements using satellites give essentially the same results. Since the earth-sun distance varies throughout the year, the intensity beyond the earth's atmosphere I_o also varies by ± 3.3 percent (Table 9.1.3). The great seasonal variations in terrestrial solar radiation intensity are due to the earth's tilted axis, which causes the solar declination δ (the angle between the earth's equatorial plane and earth-sun line) to change from 0° on Mar. 21 and Sept. 21 to -23.5° on Dec. 21 and $+23.5^\circ$ on June 21.

In passing through the earth's atmosphere, the sun's radiation is partially and selectively absorbed, scattered, and reflected by water vapor

Table 9.1.3 Annual Variation in Solar Declination and Solar Radiation Intensity beyond the Earth's Atmosphere

Date	Jan. 1	Feb. 1 Nov. 10	Mar. 1 Oct. 13	Apr. 1 Sept. 12	May 1 Aug. 12	June 1 July 12	July 1
Declination, deg	-23.0	-17.1	-7.7	+4.4	+15.0	+22.0	+23.1
Ratio, I_o/I_{sc}	1.033	1.029	1.017	1.000	0.983	0.971	0.967
Intensity I_o , Btu/(ft ² · h) (W/m ²)	449	447	442	435	427	422	420
	1,416	1,409	1,393	1,370	1,347	1,331	1,324

and ozone, air molecules, natural dust, clouds, and artificial pollutants. Some of the scattered and reflected energy reaches the earth as diffuse or sky radiation I_d .

The intensity of the direct normal radiation I_{DN} depends upon the clarity and the amount of precipitable moisture in the atmosphere and the length of the atmospheric path, which is determined by the solar altitude β and expressed in terms of the air mass m , which is the ratio of the existing path length to the path length when the sun is at the zenith. Except at very low solar altitudes, $m = 1.0/\sin \beta$.

Figure 9.1.10 shows relative values of the spectral intensity of solar radiation in space for $m = 0$ (Thekaekara, *Solar Energy* outside the Earth's Atmosphere, *Solar Energy*, 14, no. 2, 1973) and at sea level (Moon, Standard Solar Radiation Curves, *Jour. Franklin Inst.*, Nov. 1940) for a solar altitude of 30° ($m = 2.0$). Table 9.1.4 shows the variation at 40° north latitude throughout typical clear summer (June 21) and winter (Dec. 21) days of solar altitude and azimuth (measured from the south), direct normal radiation, total solar irradiation of horizontal and vertical south-facing surfaces.

The total solar irradiation reaching a terrestrial surface is the sum of the direct, diffuse, and reflected components: $I_t = I_{DN} \cos \theta + I_d + I_r$, where θ is the incident angle between the sun's rays and a line perpendicular to the receiving surface and, I_r is the shortwave radiation reflected from adjacent surfaces.

Direct beam solar radiation intensity is measured by **pyroheliometers** with collimating tubes to exclude all but the direct rays from their sensors, which may use calorimetric, thermoelectric, or photovoltaic means to produce a response proportional to the irradiation rate. Similar but uncollimated instruments called **pyranometers** are used to measure the total radiation from sun and sky; when their sensors are shaded from the sun's direct rays, they also can measure the diffuse component.

Incident Angle Determination The incident angle θ affects both the direct solar intensity and the solar optical properties of the irradiated surface. For a flat surface tilted at an angle Σ from the horizontal, $\cos \theta = \cos \beta \cos \gamma \sin \Sigma + \sin \beta \cos \Sigma$. For vertical surfaces, $\Sigma = 90^\circ$; so $\cos \theta = \cos \beta \cos \gamma$; for horizontal surfaces, $\Sigma = 0^\circ$ and $\theta = 90^\circ - \beta$. (See ASHRAE, "Handbook of Fundamentals," for values of solar altitude, azimuth, and direct normal radiation throughout the year for 0 to 56° north latitude.)

Solar Optical Properties of Transparent Materials When solar radiation with total intensity I_t falls on a transparent material, part of the energy is reflected, part is absorbed, and the remainder is transmitted. At any instant,

$$I_t = q_\tau + q_A + q_R = I_t(\tau + \alpha + \rho)$$

The sum of the solar optical properties τ , α , and ρ must equal unity, but the individual values depend upon the incident angle and wavelength of the radiation, the composition of the material, and the nature of any coatings which may be applied to the surfaces.

For uncoated single-strength ($\frac{3}{32}$ -in or 2.4-mm) clear window glass (Fig. 9.1.11), solar transmittance at normal incidence ($\theta = 0^\circ$) is approximately 0.90, but the transmittance for longwave thermal radiation ($5 \mu\text{m}$) is virtually zero. Thus glass acts as a "heat trap" by admitting solar radiation readily but retaining most of the heat produced by the absorbed sunshine. This "greenhouse effect," which is also exhibited but to a lesser degree by some plastic films (see Whillier, Plastic Covers for Solar Collectors, *Solar Energy*, 7, no. 3, 1964), is the basis for most heliothermal processes. Heat absorbing glass [$\frac{1}{4}$ in (6.3 mm) thick (Fig. 9.1.11)], which absorbs more than 50 percent of the incident solar radiation, is widely used by architects to reduce the heat and glare admitted through unshaded windows. Reflective coatings (Yellott, Selective Reflectance, *Trans. ASHRAE*, 69, 1963) have been developed to serve similar purposes.

For all types of glass, transmittance falls and reflectance rises as θ exceeds about 30° . Absorptance increases somewhat owing to the increased path length and then drops off sharply toward zero as θ exceeds 60° .

Absorptance and Emittance of Opaque Surfaces Opaque materials absorb or reflect all the incident sunshine. The absorptance α for solar radiation and the emittance ϵ for longwave radiation at the temperature of the receiving surface are particularly important in heliotechnology. For a true blackbody, the absorptance and emittance are equal and do not change with wavelength. Most real surfaces have reflectances and absorptances which vary with wavelength (Fig. 9.1.12). Aluminum foil has a consistently low absorptance and high reflectance over the entire spectrum from 0.25 to $25 \mu\text{m}$, while black paint has a high absorptance and low reflectance. White paint, however, has low

Table 9.1.4 Solar Altitude and Azimuth, Direct Normal Radiation, and Total Solar Radiation on Horizontal and Vertical South-Facing Surfaces, June 21 and Dec. 21, for 40° North Latitude

June 21, declination = +23.45°							
Time: A.M.: P.M.	6; 6	7; 5	8; 4	9; 3	10; 2	11; 1	12; 12
Solar altitude, deg	14.8	26.0	37.4	48.8	59.8	69.2	73.5
Solar azimuth, deg	108.4	99.7	90.7	80.2	65.8	41.9	0.0
Direct normal irradiation, Btu/(ft ² · h)	154	215	246	262	272	276	278
Total irradiation, Btu/(ft ² · h)							
On horizontal surface	60	123	182	233	273	296	304
On vertical south surface	10	14	16	47	74	92	98
Dec. 21, declination = -23.45°							
Time: A.M.: P.M.	6; 6	7; 5	8; 4	9; 3	10; 2	11; 1	12; 12
Solar altitude, deg			5.5	14.0	20.7	25.0	26.6
Solar azimuth, deg			53.0	41.9	29.4	15.2	0.0
Direct normal irradiation, Btu/(ft ² · h)			88	217	261	279	284
Total irradiation, Btu/(ft ² · h)							
On horizontal surface			14	65	107	119	143
On vertical south surface			56	163	221	252	263

Values adapted from ASHRAE, "Handbook of Applications," 1982.

shortwave (solar) absorptance, but beyond 3 μm its absorptance and reflectance are virtually the same as for black paint.

Solar collectors require a high α/ε ratio, while surfaces which should remain cool, such as rooftops or space vehicles, should have low ratios

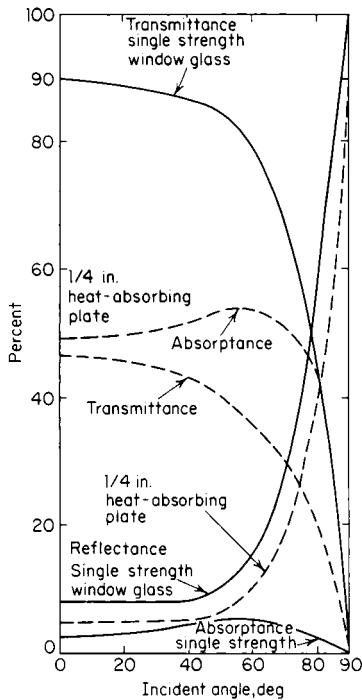

Fig. 9.1.11 Variation with incident angle of solar optical properties of 3/32-in (2.4-mm) clear glass and 1/4-in (6.3-mm) heat-absorbing glass.

since their objective usually is to absorb as little solar radiation and emit as much longwave radiation as possible. Special surface treatments have been developed (see ASHRAE, "Solar Energy Use for Heating and Cooling of Buildings," 1977) for which the ratio α/ε is above 7.0, making them suitable for solar collectors; others with ratios as low as 0.15 are useful as heat rejectors for space applications (see Table 9.1.5). In addition, the absorptance can be changed and controlled by paint

Table 9.1.5 Solar Absorptance, Longwave Emittance, and Radiation Ratio for Typical Surfaces

Surface or material	Shortwave (solar) absorptance α	Longwave emittance ε	Radiation ratio, α/ε
Flat, oil-based paints:			
Black	0.90	0.90	1.00
Red	0.74	0.90	0.82
Green	0.50	0.90	0.55
Aluminum	0.45	0.90	0.50
White	0.25	0.90	0.28
Whitewash on galvanized iron	0.22	0.90	0.25
Building materials:			
Asbestos slate	0.81	0.96	0.84
Tar paper, black	0.93	0.93	1.00
Brick, red	0.55	0.92	0.59
Concrete	0.60	0.88	0.68
Sand, dry	0.82	0.90	0.92
Glass	0.04–0.70	0.84	
Metals:			
Copper, polished	0.18	0.04	4.50
Copper, oxidized	0.64	0.60–0.90	1.03–0.71
Aluminum, polished	0.30	0.05	6.00
Selective surfaces:			
Tabor, electrolytic	0.90	0.12	7.50
Silicon cell, uncoated	0.94	0.30	3.13
Black cupric oxide on copper	0.91	0.16	5.67

composition (grain material and size, binder, thickness etc.) and surface configuration, both large and small.

Equilibrium Temperatures for Concentrating Collectors When a surface is irradiated, its temperature rises until the rate of solar radiation absorption equals the rate at which heat is removed from the surface. If no heat is intentionally removed, the maximum temperature which can be attained by a blackbody (α = ε) is found from $I_{DN}C\alpha = 0.1713\epsilon(T_p/100)^4$, where C is the concentration ratio. Figure 9.1.13 shows the variation of blackbody equilibrium temperatures for earth and near space where $I_{DN} = 320$ and $I_o = 435$ Btu/ft²·h (1,000 and 1,370 W/m²).

For flat plate collectors, $C = 1.0$; so their maximum attainable temperatures are below 212°F (100°C) unless a selective surface is used with α/ε > 1.0, or both radiation and convection loss are suppressed by the use of multiple glass cover plates. Only the direct component of the total solar radiation can be concentrated, and concentrating collectors must follow the sun's apparent motion across the sky or use heliostats

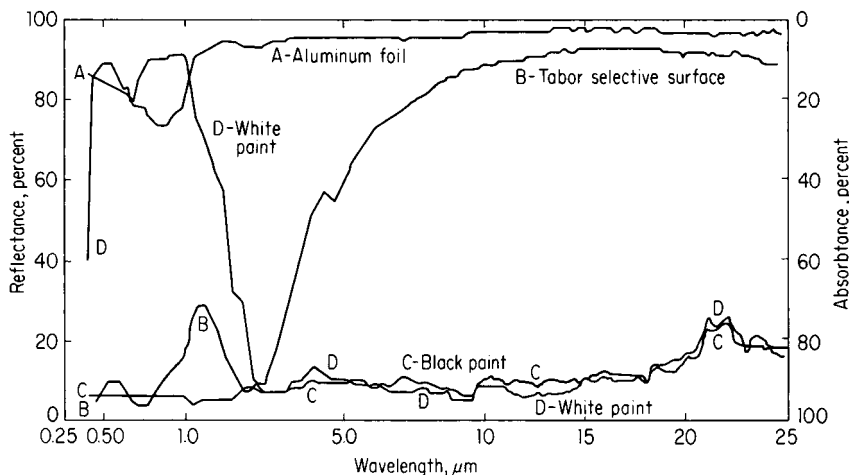

Fig. 9.1.12 Variation with wavelength of reflectance and absorptance for opaque surfaces.

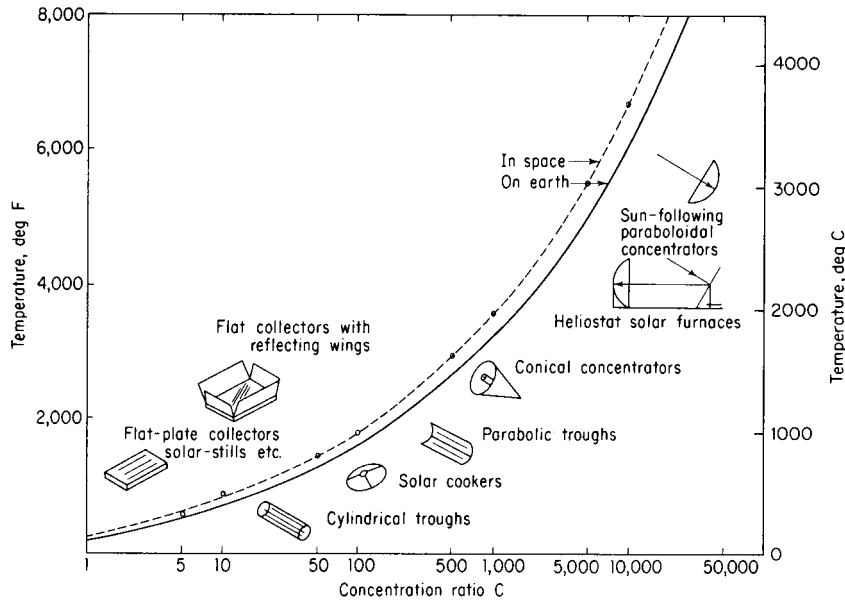

Fig. 9.1.13 Variation with concentration ratio of equilibrium temperatures for earth and space.

which serve the same function. Diffuse radiation cannot be concentrated effectively.

Flat-Plate Collectors Direct, diffuse, and reflected solar radiation can be collected and converted into heat by flat-plate collectors (Fig. 9.1.14). These generally use blackened metal plates which are finned, tubed, or otherwise provided with passages through which water, air, or

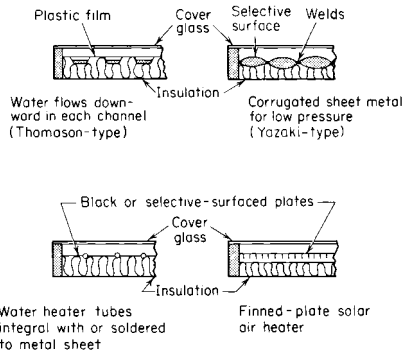

Fig. 9.1.14 Typical flat-plate solar radiation collectors.

other fluids may flow and be heated to temperatures as much as 100 to 150°F (55 to 86°C) above the ambient air. The actual temperature rise may be estimated from the heat balance for a unit area of collector surface:

$$q_A = I_T \tau_c \alpha_p = w_f c_p (t_o - T_i) \div q_l + U(t_p - t_a)$$

The loss from the back of the collector plate q_l can be minimized by the use of adequate insulation. The radiation component of the loss from the upper surface can be reduced (Zarem and Erway, "Introduction to the Utilization of Solar Energy," McGraw-Hill; ASHRAE, "Solar Energy Use for Heating and Cooling of Buildings") by using selective reflectance coatings with high α/ϵ ratios and by using covers which are transparent to solar radiation but opaque to longwave emissions (see Table 9.1.6). Both convection and radiation can be reduced by the use of honeycomb structures in the airspace between the cover and the collector plate (see Hollands, Honeycomb Devices in Flat-Plate Solar Collec-

Table 9.1.6 Transmittance and Overall Heat-Transfer Coefficients for Collectors with Glass and Plastic Covers

Type and number of covers	None	One glass	One plastic	Two glass	Two plastic
Solar transmittance	1.00	0.90	0.92	0.81	0.85
Overall coefficient U	3.90	1.12	1.30	0.71	0.87

tors, *Solar Energy*, 9, no. 3, 1965). For the transparent covers, glass is best since it lets through the shortwave solar radiation but stops the longwave radiation given off by the collector plate. Plastics do not have this trapping characteristic, do have a shorter life, may lose their transparency, and outgas when heated. The fumes may condense on other surfaces, forming a film to reduce the collector performance.

Applications of Heliotechnology

Solar Drying Probably the largest use of solar energy over the centuries—the drying of agricultural crops, evaporation of ocean and salt lake ponds for salt production, etc.—has led more recently to more efficient dryers. The newer dryers prevent rain and dew from rewetting the materials. Simple inexpensive solar dryers—essentially transparent covers—sometimes are supplemented by air heaters providing hot air to dry crops, fish, etc., especially in tropical regions where daily rains prevent efficient natural drying. They are used for curing wood and to remove moisture from mining ores (especially if they have been washed) to reduce shipping costs. Some uneconomical mining operations have been made profitable by the use of solar drying.

Swimming Pool Heating Probably the widest U.S. commercial application of solar energy today is in swimming pool heating. To extend the swimming season, a transparent cover floating on the surface of the pool, with as few air bubbles underneath as possible, will raise the temperature of the water by up to 20°F (11°C). Flat-plate type of heaters on roofs, often made of rubber or plastics, can be used instead of or in addition to the pool cover. Approximately 1,000 Btu/ft²·day (3.1 kWh/m²·day) can be expected on average from a reasonably good collector. Since in many places a fence is required around a pool, the fence can incorporate collectors. They are not as efficient because of less favorable orientation, but they serve a dual purpose. The developing countries are interested in solar swimming pool heating since they lack fossil fuels and the currency to buy them, but want to attract tourists with modern conveniences.

Solar Ponds If water in ponds or reservoirs contains salts in solution, the warmer layers will have higher concentrations and, being heavier, will sink to the bottom. The hot water on the bottom is insulated against heat losses by the cooler layers above. Heat can be extracted from these ponds for power generation. Large solar ponds have been used in the Mideast along the Dead and Red seas, along the Salton Sea; a number of artificial ponds have been established elsewhere. The inexpensive extraction of heat at over 200°F (94°C) still requires improvement. Solar ponds are, effectively, large inexpensive solar collectors. Their heat can be used to power vapor engines and turbines; these, in turn, drive electric generators.

Solar Stills Covering swimming pools, ponds, or basins with airtight covers (glass or plastic) will condense the water vapors on the underside of the covers. The condensate produced by the solar energy can be collected in troughs as distilled water. Deep-basin stills have a water depth of several feet (between approximately 0.5 and 1.5 m) and require renewal only every few months. Shallow-basin stills have a water depth of about 0.5 to 2.0 in (approximately 1 to 5 cm) and have to be fed and flushed out frequently. Solar stills can be designed to also collect rainwater (in Florida this can double the freshwater production). If the supply water is not contaminated and only too high in solids content, it can be mixed with the distilled water to increase the actual output. This is often done for farm animal water and water used for irrigation.

The glass-covered roof-type solar still (Fig. 9.1.15a) is in wide use in arid areas for the production of drinking water from salty or brackish sources. The sun's rays enter through the cover glasses, warm the water, and thus produce vapor which condenses on the inner surface of the cover. The water droplets coalesce and flow downward into the discharge troughs, while the remaining brine is periodically replaced with a new supply of nonpotable water. Daily yield ranges from 0.4 lb/ft² (2 kg/m²) of water surface in winter to 1.0 lb/ft² (5 kg/m²) in summer (Daniels, "Direct Use of the Sun's Energy," Yale, p. 174).

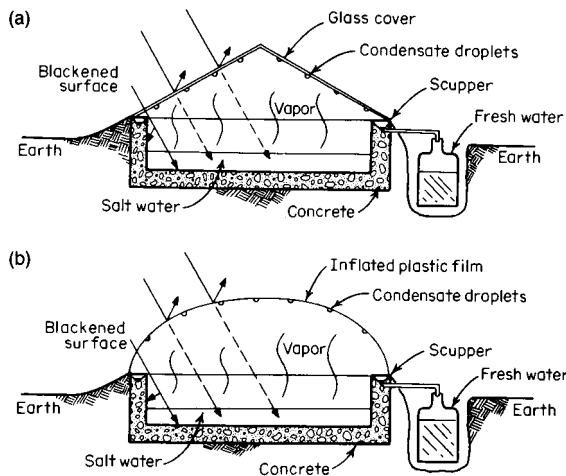

Fig. 9.1.15 Shallow-basin horizontal-surface solar stills. (a) Glass-covered roof type; (b) inflated plastic type.

Inflated plastic films (Fig. 9.1.15b) have also been used to cover solar stills, but their greatest success has been achieved in controlled-environment greenhouses where the vapor which transpires from plant leaves is condensed and reused at the plant roots. Stills made of inflatable plastic also are equipment in survival kits, on lifeboats, etc. Wicks in some of the solar stills can improve their performance. Most plastics have to be surface-treated for this application to produce film condensation (for good solar transmission) rather than dropwise condensation, which reflects a considerable fraction of the impinging solar radiation.

Solar Water Heaters These can be the pan (batch) type—a tank or

basin with transparent cover—or tube collector type, described previously. The simple thermosiphon solar water heater (Fig. 9.1.16) with a glass-covered flat-plate collector is used in thousands of homes all over the world, but mainly in Australia, Japan, Israel, North Africa, and Central and South America. Under favorable climatic conditions (abun-

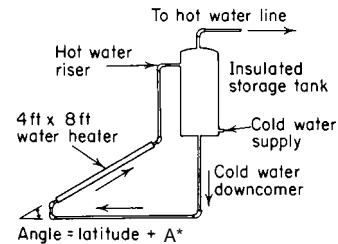

Fig. 9.1.16 Thermosiphon type of water heater. (*The collector angle A depends on the latitude. More favorable orientation toward the winter sun when days are shorter can produce the same amount of hot water all year round. In Florida, A is 10°.)

dant sunshine and moderate winter temperatures) they can produce 30 to 50 gal (110 to 190 L) of water at temperatures up to 160°F (70°C) in summer and 120°F (50°C) in winter. Auxiliary electric heaters are often used to produce higher temperatures during unfavorable winter weather.

In the United States and Europe, solar collectors are usually placed on the roof, with the hot water storage tank lower. This requires a small circulating pump. The pump is controlled by a timer, a temperature sensor in the collector, or a differential temperature controller. Ideally, the pump runs when heat can be added to the water in the tank.

To protect the system from freezing, the collectors are drained, manually or automatically. The system can also be designed with a primary circuit containing antifreeze and effecting heat transfer with a heat exchanger in the tank, or by use of a double-walled tank. Another method for protection is a dual system, in which the water drains from the collectors when the pump stops. This is the preferred method for large systems.

Auxiliary heaters, usually electric, are used often in solar water heaters to handle overloads and unusually bad weather conditions.

Solar House Heating and Cooling House heating can be accomplished in temperate climates by collecting solar radiation with flat-plate devices (Fig. 9.1.14) mounted on south-facing roofs or walls (in the northern hemisphere). Water or air, warmed by solar radiation, can be used in conventional heating systems, with small auxiliary fuel-burning apparatus available for use during protracted cloudy periods. Excess heat collected during the day can be stored for use at night in insulated tanks of hot water or beds of heated gravel. Heat-of-fusion storage systems, which use salts that melt and freeze at moderate temperatures, may also be used to improve heat storage capacity per unit volume.

Solar air conditioning and refrigeration can be done with absorption systems supplied with moderately high-temperature (200°F or 93°C) working fluids from high-performance good flat-plate collectors. The economics of solar energy utilization for domestic purposes become much more favorable when the same collection and storage apparatus can be used for both summer cooling and winter heating. One such system (see Hay, *Natural Air Conditioning with Roof Ponds and Movable Insulation*, *Trans. ASHRAE*, 75, part I, 1969, p. 165) uses a combination of shallow ponds of water on horizontal rooftops with panels of insulation which may be moved readily to cover or uncover the water surfaces. During the winter, the ponds are uncovered during the day to absorb solar radiation and covered at night to retain the absorbed heat. The house is warmed by radiation from metallic ceiling panels which are in thermal contact with the roof ponds. During the summer, the ponds are covered at sunrise to shield them from the daytime sun, and uncovered at sunset to enable them to dissipate heat by radiation, convection, and evaporation to the sky.

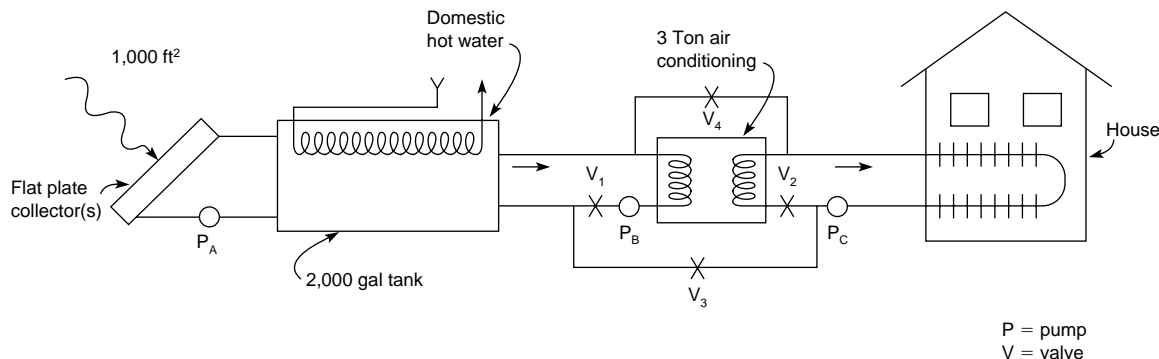

Fig. 9.1.17 Schematic of typical solar house heating, cooling, and hot water system.

Figure 9.1.17 is a schematic of a more typical active solar house heating, cooling, and hot water system. Flat-plate collectors, roughly 1,000 ft² (93 m²) to provide both 3 tons of air conditioning and hot water, properly oriented on the roof (they can actually be the roof), supply hot water to a storage tank (usually buried) of about 2,000 gal (about 7,570-L) capacity. A heat-exchanger coil, submerged in and near the top of the tank, provides domestic hot water. When heat is needed, the thermostat orders the following: Valves V_1 and V_2 close, V_3 and V_4 open, and pump P_C circulates hot water through the house as long as required. When cooling is required, the thermostat orders the following: Valves V_1 and V_2 open, V_3 and V_4 close, and pumps P_B and P_C feed hot water to the air conditioner, which, in turn, produces chilled water for circulation through the house as long as needed. This system can be used over a wide range of latitudes, and only the heating and cooling duty cycles will change (i.e., more heating in the north and more cooling in the south). The proper orientation of the collectors will depend upon the duty cycles. In the northern hemisphere, the collectors will face south. When used mostly for heating, they are inclined to the horizontal by latitude plus up to 20°. When they are used mostly for cooling, the inclination will be latitude minus up to 10°. The basic idea is to orient the collectors more favorably toward the winter sun when mostly heating and more favorably toward the summer sun when mostly cooling. The collectors can be made adjustable at extra cost. Air can be used instead of water with rock bin storage and blowers instead of pumps. Blowers require more energy to run.

The air conditioner can be a conventional type, driven by solar engines or solar electricity, or preferably an absorption system (e.g., low-temperature NH₃/H₂O), a jet air conditioning system, a liquid or solid desiccant system, or other direct energy conversion systems described later (in "Direct Energy Conversion").

Solar cooking utilizes (1) a sun-following broiler-type device with a metallized parabolic reflector and a grid in the focal area where cooking pots can be placed; (2) an oven-type cooker comprising an insulated box with glass covers over an open end which is pointed toward the sun. When reflecting wings are used to increase the solar input, temperatures as high as 400°F (204°C) are reached at midday. Large solar cookers for community cooking in third world country villages can be floated on water and thus easily adjusted to point at the sun. For cooking when the sun does not shine, oils or other fluids can be heated to a high temperature, 800°F (around 425°C), with a solar concentrator when the sun shines, and then stored. A range similar to an electric range but with the hot oil flowing through the coils, at adjustable rates, is then used to cook with solar energy 24 h/day.

Solar Furnaces Precise paraboloid concentrators can focus the sun's rays upon small areas, and if suitable receivers are used, temperatures up to 6,500°F (3,600°C) can be attained. The concentrator must be able to follow the sun, either through movement of the paraboloid reflector itself (Fig. 9.1.13) or by the use of a heliostat which tracks the sun and reflects the rays along a horizontal or vertical axis into the concentrator. This pure, noncontaminating heat can be used to produce

highly purified materials through zone refining, in a vacuum or controlled atmosphere. This allows us to grow crystals of high-temperature materials, crystals not existing in nature, or to do simple things such as determining the melting points of exotic materials. Other methods of heating contaminate these materials before they melt. With solar energy the materials can be sealed in a glass or plastic bulb, and the solar energy can be concentrated through the glass or plastic onto the target. The glass or plastic is not heated appreciably since the energy is not highly concentrated when it passes through it.

Solar furnaces are used in high-temperature research, can simulate the effects of nuclear blasts on materials, and at the largest solar furnace in the world (France) produce considerable quantities of highly purified materials for industry.

Power from Solar Energy During the past century (Zarem and Erway, "Introduction to the Utilization of Solar Energy," McGraw-Hill) many attempts have been made to generate power from solar radiation through the use of both flat-plate and concentrating collectors. Hot air and steam engines have operated briefly, primarily for pumping irrigation water, but none of these attempts have succeeded commercially because of high cost, intermittent operation, and lack of a suitable means for storing energy in large quantities. With the rapid rise in the cost of conventional fuels and the increasing interest in finding pollution-free sources of power, attention has again turned to parabolic trough concentrators and selective surfaces (high α/ϵ ratios) for producing high-temperature working fluids for Rankine and Brayton cycles. Because of the cost of Rankine engines, often operating on other than water-based working fluids, Stirling engines (discussed later) and other small engines (phase shift), turbines, gravity machines, etc., have been developed, their application and use being directly related to the cost and availability of fossil fuels. The price of crude oil rose from \$2.50 to \$32.00 per barrel during the period from 1973 to the 1980s, and it stands at about \$18.00 per barrel now (1995). When fossil fuel costs are high, solar energy conversion methods become competitive and attractive.

Flat-plate collectors utilizing both direct and diffuse solar radiation can be used to drive small, low-temperature Stirling engines, which operate off the available hot water; in turn, the engines can circulate water from the buried storage tank through the collectors on the roof. These engines have low efficiency, but that is not quite so important since solar energy is free. Low efficiency generally implies larger, and thus more expensive, equipment. The application cited above is ideal for small circulating electric pumps powered by solar cells.

Concentrating collector systems, having higher conversion efficiencies, can only utilize the direct portion of the solar radiation and in most cases need tracking mechanisms, adding to the cost. A 10-MW plant was built and had been operating in Barstow, CA until recently. That plant was used both for feasibility studies and to gather valuable operating experience and data. Although intrinsically attractive by virtue of zero fuel cost, solar-powered central plants of this type are not quite yet state of the art. Proposed plants of this and competitive types require

abundant sunshine most of the time; obviously, they are not very effective on cloudy days, and their siting would appear to be circumscribed to desertlike areas.

Direct Conversion of Solar Radiation to Electricity Photovoltaic cells made from silicon, cadmium sulfide, gallium arsenide, and other semiconductors (see "Solar Cells," National Academy of Science, Washington, 1972) can convert solar radiation directly to electricity without the intervention of thermal cycles. Of primary importance today are the silicon solar batteries which are used in large numbers to provide power for space probes, orbiting laboratories, and communication satellites. Their extremely high cost and relatively low efficiency have thus far made them noncompetitive with conventional power sources for large-scale terrestrial applications, but intensive research is currently underway to reduce their production cost and to improve their efficiency. Generation of power from solar radiation on the earth's surface encounters the inherent problems of intermittent availability and relatively low intensity. At the maximum noon intensity of 340 Btu/(ft² · h) (1,080 W/m²) and 100 percent energy conversion, 10 ft² (1.1 m²) of collection area would produce 1 thermal kilowatt, but with a conversion efficiency of 10 percent, the area required for an electrical kilowatt approaches 100 ft² (9.3 m²). Thus very large collection areas are essential, regardless of what method of conversion may be employed. However, the total amount of solar radiation falling on the arid southwestern section of the United States is great enough to supply all the nation's electrical needs, provided that the necessary advances are made in collection, conversion, and storage of the unending supply of energy from the sun.

Solar Transportation Presently the best application of solar energy to transportation seems to be electric vehicles, although solar-produced hydrogen could be used in hydrogen-propelled cars. Since there is not enough surface area on these vehicles to collect the solar energy needed for effective propulsion, storage is needed. Vehicles have been designed and built so that batteries are charged by solar energy. Charging is by Rankine engine-, Stirling engine-, or other engine-driven generators or by photovoltaic panels. A number of utilities, government agencies, municipalities, and universities have electric vehicles, cars, trucks, or buses, the batteries in which are charged by solar energy. For general use a nationwide pollution-free system is proposed, with solar battery charging stations replacing filling stations. They would provide, for a fee, charged batteries in exchange for discharged ones. A design objective to help implement this concept would require that the change of batteries be effected quickly and safely. Electric cars with top speeds of over 65 mi/h (88 km/h) and a range of 200 mi (320 km) have been built. Regenerative braking (the motor becomes a generator when slowing down, charging the batteries), especially in urban driving, can increase the range by up to 25 percent.

Closure Our inherited energy savings, in the form of fossil fuels, cannot last forever; indeed, an energy income must be part of the overall picture. That income, in the form of solar energy, will have to assume a larger role in the future. Fossil fuels will definitely fade from the picture at some time; it behooves us to plan now for the benefit of future generations.

For the successful application of solar energy, as with any other source of energy, each potential use must be analyzed carefully and the following criteria must be met:

1. Use the minimum amount of energy to do the task (efficiency).
2. Use the best overall energy source available.
3. The end result must be feasible and workable.
4. Cost must be reasonable.
5. The end result must fit the lifestyle and habits of the user.

Schemes which have failed in the past have violated one or more of these criteria.

In utilizing conventional fossil fuels, the energy conversion equipment is a capital cost to which must be added the periodic cost of fuel. Solar energy conversion systems, likewise, represent a capital cost, but there is no periodic cost for fuel. To be competitive, solar capital costs must be less than the total cost of a conventional plant (capital cost plus fuel). There exist circumstances where this is, indeed, the case. Financing will continue to look favorably on such investments.

There are several reasons why solar energy conversion has not had a wider impact, especially in the fossil-fuel-rich countries: lack of awareness of the long-term problems associated with fossil fuel consumption; the fact that solar energy conversion equipment is not as available as would be desirable; the current continuing supply of fossil fuels at very competitive prices; and so forth. There will come a time, however, when the bank of fossil fuels will have been exhausted; solar energy conversion looms large in the future.

A significant consideration with regard to fossil fuels is the realization that they constitute an irreplaceable source of raw materials which ought really to be husbanded for their greater utility as feedstocks for medicines, fertilizers, petrochemicals, etc. Their utility in serving these purposes overrides their convenient use as cheap fossil fuels burned for their energy content alone.

GEOTHERMAL POWER
by Kenneth A. Phair

REFERENCES: Assessment of Geothermal Resources of the United States—1978, *U.S. Geol. Surv. Circ. 790*, 1979, "Geothermal Resources Council Transactions," vol. 17, Geothermal Resources Council, Davis, CA. Getting the Most out of Geothermal Power, *Mech. Eng.*, publication of ASME, Sept. 1994. "Geothermal Program Review XII," U.S. Department of Energy, DOE/GO 10094-005, 1994.

Geothermal energy is a naturally occurring, semirenewable source of thermal energy. Thermal energy within the earth approaches the surface in many different geologic formations. Volcanic eruptions, geysers, fumaroles, hot springs, and mud pots are visual indications of geothermal energy.

Significant **geothermal reserves** exist in many parts of the world. The U.S. Geological Survey, in *Circ. 790*, has estimated that in the United States alone there is the potential for 23,000 megawatts (MW) of electric power generation for 30 years from recoverable hydrothermal (liquid- or steam-dominated) geothermal energy. Undiscovered reserves may add significantly to this total. Many of the known resources can be developed using current technology to generate electric power and for various direct uses. For other reserves, technical breakthroughs are necessary before this energy source can be fully developed.

Power generation from geothermal energy is cost-competitive with most combustion-based power generation technologies. In a broader picture, geothermal power generation offers additional benefits to society by producing significantly less carbon dioxide and other pollutants per kilowatt-hour than combustion-based technologies.

Electric power was first generated from geothermal energy in 1904. Active worldwide development of geothermal resources began in earnest in 1960 and continues. In 1993, the capacity of geothermal power plants worldwide exceeded 6,000 MW. Table 9.1.7 lists the installed capacity by country.

Table 9.1.7 Worldwide Geothermal Capacity, 1993

Country	Capacity installed,
	MW
United States	2,913
Philippines	894
Mexico	700
Italy	545
New Zealand	295
Japan	270
Indonesia	142
El Salvador	95
Nicaragua	70
Iceland	45
Kenya	45
Others	65
Total	6,079

SOURCE: From "Geothermal Resources Council Transactions," vol. 17, Geothermal Resources Council, Davis, CA. 1993.

Geothermal power plants are typically found in areas with “recently” active volcanoes and continuing seismic activity. In 1994 and 1995, significant additional geothermal power generation facilities were installed in Indonesia and the Philippines. Many countries not included in Table 9.1.7 also have significant geothermal resources that are not yet developed.

Although geothermal energy is a renewable resource, economic development of geothermal resources usually extracts energy from the reservoir at a much higher rate than natural recharge can replenish it. Therefore, facilities that use geothermal energy should be designed for high efficiency to obtain maximum benefit from the resource.

Geothermal Resources Geothermal resources may be described as hydrothermal, hot dry rock, geopressed, or magma.

Hydrothermal resources contain hot water, steam, or a mixture of water and steam. These fluids transport thermal energy from the reservoir to the surface. Reservoir pressures are usually sufficient to deliver the fluids to the surface at useful pressures, although some liquid-dominated resources require downhole pumps for fluid production. Hydrothermal resources may be geologically closed or open systems. In a closed system, the reservoir fluids are contained within an essentially impermeable boundary. Communication and fluid transport within the reservoir occur through fractures in the reservoir rock. There is little, if any, natural replenishment of fluids from outside the reservoir boundary. An open system allows influx of cold subsurface fluids into the reservoir as the reservoir pressure decreases. Hydrothermal reservoirs have been found at depths ranging from 400 ft (122 m) to over 10,000 ft (3,050 m).

Hot dry rock resources are geologic formations that have high heat content but do not contain meteoric or magmatic waters to transport thermal energy. Thus water must be injected to carry the energy to the surface. The difficulty in recovering a sufficient percentage of the injected water and the limited thermal conductivity of rock have hindered development of hot dry rock resources. Because of the vast amount of energy in these resources, additional research and development is justified to evaluate whether it is technically exploitable. In 1994 research and development of hot dry rock resources was proceeding in Australia, France, Japan, and the United States.

Geopressed resources are liquid-dominated resources at unusually high pressure. They occur between 5,000 and 20,000 ft (1,500 and 6,100 m), contain water that varies widely in salinity and dissolved minerals, and usually contain a significant amount of dissolved gas. Pressures in such reservoirs vary from about 3,000 to 14,000 lb/in² gage (21 to 96 MPa) with temperatures between 140°F (60°C) and 360°F (182°C). The largest geopressed zones in the United States exist beneath the continental shelf in the Gulf of Mexico, near the Texas, Louisiana, and Mississippi coasts. Other zones of lesser extent are scattered throughout the United States.

Magma resources occur as formations of molten rock that have temperatures as high as 1,300°F (700°C). In most regions in the continental United States, such resources occur at depths of 100,000 ft (30,500 m) or more. However, in the vicinity of current or recent volcanic activity, magma chambers are believed to be within 20,000 ft (6,100 m) of the surface. The Department of Energy initiated a magma energy research program in 1975, and an exploratory well was drilled in the Long Valley Caldera in California in 1989. The drilling program was planned in four phases to reach a final depth of 20,000 ft (6,100 m) or a temperature of 900°F (500°C), whichever is reached first. The first phases have been completed, but the deep, and most significant, drilling remains to be done.

Exploration Technology Geothermal sites historically have been identified from obvious surface manifestations such as hot springs, fumaroles, and geysers. Some discoveries have been made accidentally during exploring or drilling for other natural resources. This approach has been replaced by more scientific prospecting methods that appraise the extent, as well as the physical and thermodynamic properties, of the reservoir. Modern methods include geological studies involving aerial, surface, and subsurface investigations (including remote infrared sensing) and geochemical analyses which provide a guide for selecting spe-

cific drilling sites. Geophysical methods include drilling, measuring the temperature gradient in the drill hole, and measuring the thermal conductivity of rock samples taken at various depths.

Resource Development Extraction of fluids from a geothermal resource entails drilling large-diameter production wells into the reservoir formation. Bottom hole temperatures in hydrothermal wells and hot dry rock formations can exceed 450°F (232°C). Geopressed resources have lower temperatures but offer energy in the form of fluids at unusually high pressures that frequently contain significant amounts of dissolved combustible gases. Although research and development projects continue to seek ways to efficiently extract and use the energy contained in hot dry rock, geopressed, and magma resources, virtually all current geothermal power plants operate on hydrothermal resources.

Production Facilities For most projects, a number of wells drilled into different regions of the reservoir are connected to an aboveground piping system. This system delivers the geothermal fluid to the power plant. As with any fluid flow system, the geothermal reservoir, wells, and production facilities operate with a specific flow vs. pressure relationship. Fig. 9.1.18 shows a typical steam deliverability curve for a 110-MW geothermal power plant.

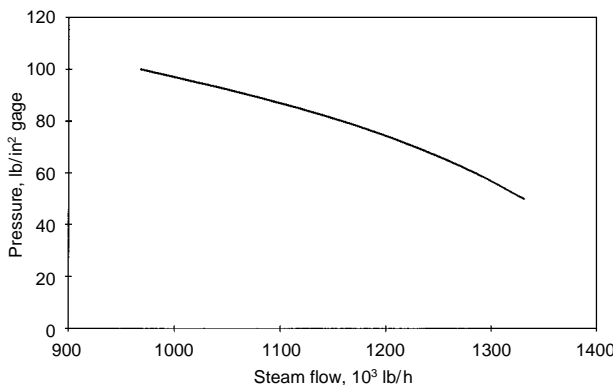

Fig. 9.1.18 Typical deliverability curve; steam flow to power plant [1,000 lb/h = (453 kg/h)] vs. turbine inlet pressure [100 lb/in² gage (689 kPa gage)].

Resource permeability; the number, depth, and size of the wells; and the surface equipment and piping arrangement all contribute to make the deliverability curve different for each power plant. Production of geothermal fluids over time results in declining deliverability. For one-half or more of the operating life of a reservoir, the deliverability can usually be held constant by drilling additional production wells into other regions of the resource. As the resource matures, this technique ceases to provide additional production. The deliverability curve begins to change shape and slope as deliverability declines. The power plant design must be matched to the deliverability curve if maximum generation from the resource is to be achieved.

Geothermal Power Plants A steam-cycle geothermal power plant is very much like a conventional fossil-fueled power plant, but without a boiler. There are, however, significant differences. The turbines, condensers, noncondensable gas removal systems, and materials used to fabricate the equipment are designed for the specific geothermal application. With geothermal steam delivered to the power plant at approximately 100 lb/in² gage (689 kPa), only the low-pressure sections of a conventional turbine generator are used. Additionally, the geothermal turbine must operate with steam that is far from pure. Chemicals and compounds in solid, liquid, and gaseous phases are transported with the steam to the power plant. At the power plant, the steam passes through a separator that removes water droplets and particulates before it is delivered to the turbine. Geothermal turbines are of conventional design with special materials and design enhancements to improve reliability in geothermal service. Turbine rotors, blades, and diaphragms operate in a wet, corrosive, and erosive environment. High-alloy steels, stainless

steels, and titanium provide improved durability and reliability. Still, frequent overhauls are necessary to maintain reliability and performance. The high moisture content and the corrosive nature of the condensed steam require effective moisture removal techniques in the later (low-pressure) stages of the turbine. Scale formation on rotating and stationary parts of the turbine occurs frequently. Water washing of the turbine at low-load operation is sometimes used between major overhauls to remove scale.

Most geothermal power plants use direct-contact condensers. Only when control of hydrogen sulfide emissions has been required or anticipated have surface condensers been used. Surface condensers in geothermal service are subject to fouling on both sides of the tubes. Power plants in The Geysers in northern California use conservative cleanliness factors to account for the expected tube-side and shell-side fouling. Some plants have installed on-line tube-cleaning systems to combat tube-side fouling on a continuous basis, whereas other plants mechanically clean the condenser tubes to restore lost performance.

Noncondensable gas is transported with the steam from the geothermal resource. The gas is primarily carbon dioxide but contains lesser amounts of hydrogen sulfide, ammonia, methane, nitrogen, and other gases. Noncondensable gas content can range from 0.1 percent to more than 5 percent of the steam. The makeup and quantity of noncondensable gas vary not only from resource to resource but also from well to well within a resource. The noncondensable gas removal system for a geothermal power plant is substantially larger than the same system for a conventional power plant. The equipment that removes and compresses the noncondensable gas from the condenser is one of the largest consumers of auxiliary power in the facility, requiring up to 15 percent of the thermal energy delivered to the power plant. A typical system uses two stages of compression. The first stage is a steam jet ejector. The second stage may be another steam jet ejector, a liquid ring vacuum pump, or a centrifugal compressor. The choice of equipment selected for the second stage is influenced by project economics and the amount of gas to be compressed.

The chemicals and compounds in geothermal fluids are highly corro-

sive to the materials normally used for power plant equipment and facilities. The chemical content of geothermal fluids is unique to each resource; therefore, each resource must be evaluated separately to determine suitable materials for system components. Carbon steel usually will degrade at alarmingly high rates when exposed to geothermal fluids. Corrosion-resistant materials such as stainless steel may perform satisfactorily, but may experience rapid, unpredictable local failures depending upon the composition of the geothermal fluid. Based on experience with a number of geothermal resources:

Carbon steel with a corrosion allowance is usually suitable for transporting dry geothermal steam.

Geothermal condensate and cooling water usually require corrosion-resistant piping and equipment.

Because noncondensable gas is also corrosive, special materials are usually required.

Copper is extremely vulnerable to attack from the atmosphere surrounding a geothermal power plant. Therefore, copper wire and electrical components should be protected with tin plating and isolated from the corrosive atmosphere.

Within the context of these generalities, the fluids at each resource must be evaluated before construction materials are chosen.

The steam Rankine cycle used in fossil-fueled power plants is also used in geothermal power plants. In addition, a number of plants operate with binary cycles. Combined cycles also find application in geothermal power plants. The basic cycles are shown in Fig. 9.1.19.

The direct steam cycle shown in Fig. 9.1.19a is typical of power plants at The Geysers in northern California, the world's largest geothermal field. Steam from geothermal production wells is delivered to power plants through steam-gathering pipelines. The wells are up to 1 mi or more from the power plant. The number of wells required to supply steam to the power plant varies with the geothermal resource as well as the size of the power plant. The 55-MW power plants in The Geysers receive steam from between 8 and 23 production wells.

A flash steam cycle for a liquid-dominated resource is shown in

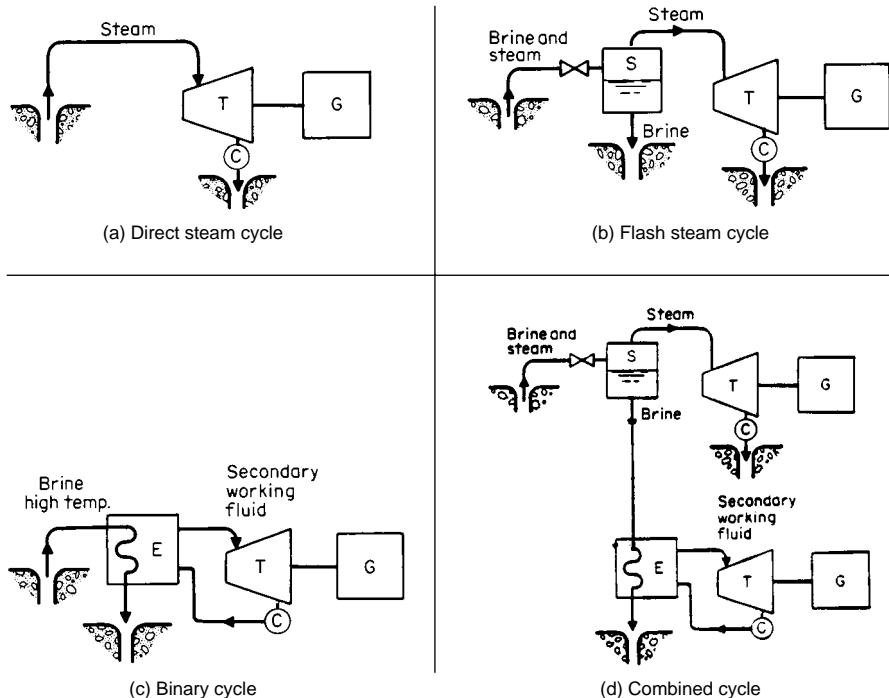

Fig. 9.1.19 Geothermal power cycles. T = turbine, G = generator, C = condenser, S = separator, E = heat exchanger.

Fig. 9.1.19b. Geothermal brine or a mixture of brine and steam is delivered to a flash vessel at the power plant by either natural circulation or pumps in the production wells. At the entrance to the flash vessel, the pressure is reduced to produce flash steam, which then is delivered to the turbine. This cycle has been used at power plants in California, Nevada, Utah, and many other locations around the world. Increased thermal efficiency is available from the use of a second, lower-pressure flash to extract more energy from the geothermal fluid. However, this technique must be approached carefully as dissolved solids in the geothermal fluids will concentrate and may precipitate as more steam is flashed from the fluid. The solids also tend to form scale at lower temperatures, resulting in clogged turbine nozzles and rapid buildup in equipment and piping to unacceptable levels.

A binary cycle is the economic choice for hydrothermal resources with temperatures below approximately 330°F (166°C). A binary cycle uses a secondary heat-transfer fluid instead of steam in the power generation equipment. A typical binary cycle is shown in Fig. 9.1.19c. Binary cycles can be used to generate electric power from resources with temperatures as low as 250°F (121°C). The binary cycle shown in Fig. 9.1.19c uses isobutane as the heat-transfer fluid. It is representative of units of about 10-MW capacity. Many small modular units of 1- or 2-MW capacity use pentane as the binary fluid. Heat from geothermal brine vaporizes the binary fluid in the brine heat exchanger. The binary fluid vapor drives a turbine generator. The turbine exhaust vapor is delivered to an air-cooled condenser where the vapor is condensed. Liquid binary fluid drains to an accumulator vessel before being pumped back to the brine heat exchangers to repeat the cycle. Binary-cycle geothermal plants are in operation in several countries. In the United States, they are located in California, Nevada, Utah, and Hawaii.

A geothermal combined cycle is shown in Fig. 9.1.19d. Just as combustion-based power plants have achieved improved efficiencies by using combined cycles, geothermal combined cycles also show improved efficiencies. Some new power plants in the Philippines use a combination of steam and binary cycles to extract more useful energy from the geothermal resource. Existing steam-cycle plants can be modified with a binary bottoming cycle to improve efficiency.

Cycle optimization is critically important to maximize the power generation potential of a geothermal resource. Selecting optimum cycle design parameters for a geothermal power plant does not follow the practices used for fossil-fueled power plants. While a higher turbine inlet pressure will improve the efficiency of the power plant, a lower turbine inlet pressure may result in increased generation over the life of the resource. The resource deliverability curve (Fig. 9.1.18) is used with turbine and cycle performance predictions to determine the flow and turbine inlet pressure that will yield maximum generation. The technical optimum must then be subjected to an economic analysis to identify the best parameters for the power plant design. Because the shape and slope of the deliverability curve vary from resource to resource, the optimum turbine inlet conditions will likewise vary.

Direct Use There are substantial geothermal resources with temperatures less than 250°F (121°C). While these resources cannot currently be used to generate electric power economically, they can be used for various low-temperature direct uses. Services such as district heating, industrial process heating, greenhouse heating, food processing, and aquaculture farming have been provided by geothermal fluids. For these applications, corrosion and fouling of surface equipment must be addressed in the system design.

The **geothermal heat pump (GHP)** is another direct use of the earth's thermal energy. The GHP, however, does not require a high-temperature geothermal reservoir. The GHP uses essentially constant-temperature groundwater as a heat source or heat sink in a conventional, reversible, water-to-air heat pump cycle for building heating or cooling. The ground, groundwater, and local climatic conditions must be included in the design of a GHP for a specific location. Systems are currently available for residential (single- and multifamily) dwellings, offices, and small industrial buildings.

Environmental Considerations Geothermal fluids contain many chemicals and compounds in solid, liquid, and gaseous phases. For both

environmental protection and resource conservation, spent geothermal liquids are returned to the reservoir in injection wells. This limits the release of compounds to the environment to a small amount of liquid lost as drift from the cooling tower and noncondensable gases. Problems with arsenic and boron contamination have been encountered in the immediate vicinity of cooling towers at geothermal power plants. The noncondensable gases, composed primarily of carbon dioxide, usually also contain hydrogen sulfide. Along with its noxious odor, hydrogen sulfide is hazardous to human and animal life. Although many geothermal power plants do not currently control the release of hydrogen sulfide, others use process systems to oxidize the hydrogen sulfide to less toxic compounds. A number of the process systems produce 99.9 percent pure sulfur that can be sold as a by-product. Using geothermal energy for power generation and other direct applications provides environmental benefits. Carbon dioxide released from a geothermal power plant is approximately 90 percent less than the amount released from a combustion-based power plant of equal size, and they create little, if any, liquid or solid waste.

STIRLING (HOT AIR) ENGINES

by Erich A. Farber

Hot air engines, frequently referred to as Stirling engines, are heat engines with regenerative features in which air; other gases such as H₂, He, N₂; or even vapors are used as working fluids, operating, theoretically at least, on the Stirling or Ericsson cycle (see Sec. 4.1) or modifications of them. While the earlier engines of this type were bulky, slow, and low in efficiency, a number of new developments have addressed these deficiencies. Stirling engines are multifuel engines and have been driven by solid, liquid, or gaseous fuels, and in some cases with solar energy. They can be reciprocating or rotary, include special features, run quietly, are relatively simple in construction (no valves, no electrical systems), and if used with solar energy, produce no waste products. (See Walker, "Stirling Engines," Clarendon Press, Oxford; *Proceedings*, 19th Intersociety Energy Conversion Engineering Conference, Aug. 1984, San Francisco.)

The Philips Stirling Engines The Philips Laboratory (in Holland) seems to have developed the first efficient, compact hot air or Stirling engine. It operates at 3,000 r/min, with a hot chamber temperature of 1,200°F (650°C), maximum pressure of 50 atm, and mep of 14 atm (14.1 bar). The regenerator consists of a porous coil of thin wires having 95 percent efficiency, saving about three-fourths of the heat required by the working fluid. The exhaust gases preheat the air, saving about 70 percent of this loss.

Single-cylinder engines, up to 90 hp (67 kW), and multicylinder engines of several hundred horsepower have been constructed with mechanical efficiencies of 90 percent and thermal efficiencies of 40 percent. Heat pipes incorporated in the designs improve the heat transfer characteristics. Philips Stirling engines have been installed in clean-air buses on an experimental basis. Exhaust estimates for an 1,800-kg car are C_xH_y, 0.02 g/mi (0.012 g/km); CO, 1.00 g/mi (0.62 g/km); NO (25 percent recirculated), 0.16 g/mi (0.099 g/km).

Much of the efforts at Philips in recent years have gone into Stirling engine component development, special design features, and even special fuel sources. Engines with rhombic drive were replaced by double-acting machines with "wobble-plate" or, as later referred to, as "swash plate" drive, reducing the weight and complexity of the design. Work with high temperature, efficient hydrogen storage in metallic hydrides offers the possibility of using hydrogen as fuel for transportation applications.

GMR Stirling Thermal Engines A cooperative program between the Philips Research Laboratory and General Motors Corporation resulted in the development of several engines. One, weighing 450 lb (200 kg) and operating at mean pressure of 1,500 lb/in² (103.4 bar), produces 30 hp (22 kW) at 1,500 r/min with a 39 percent efficiency and 40 hp (30 kW) at 2,500 r/min with a 33.3 percent efficiency. Another weighing 127 lb (57 kg) and operating at a mean pressure of 1,000 lb/in²

(6.9 MN/m²), produces 6 hp (4.5 kW) at 2,400 r/min with a 29.6 percent efficiency and 8.63 hp (6.4 kW) at 3,600 r/min with a 26.4 percent efficiency.

One such engine was used for a portable Stirling engine electric generator set; another was installed in a Stirling engine electric hybrid car. A 360 hp (265 kW) marine engine was delivered to the U.S. Navy. Another 400-hp (295-kW) engine with special control features was built and tested, and could reverse its direction of rotation almost instantaneously.

Ford-Philips Stirling Engine Development In 1972, Ford Motor Company and Philips entered into a joint development program and developed Stirling engines which were installed experimentally in their current automobile models.

MAN/MWM Stirling Engines The German company Entwicklungsgruppe Stirlingmotor MAN/MWM, in cooperation with Philips, developed a single acting engine with rhombic drive which developed 30 hp (22 kW) at 1500 r/min and formed the basic test unit for a four-cylinder 120-hp (88-kW) engine. Some double acting engines have been developed. In cooperation with the Battelle Institut, Frankfurt, a 15-kVA Stirling engine hydroelectric generator was developed. It operated at 3,000 r/min, pressurized with helium, with an efficiency of 25 percent.

United Stirling Engines United Stirling AB (Sweden) in cooperation with Philips developed Stirling engines for boats, including those of the Swedish Royal Navy, and engines for buses. One generated 200 hp (145 kW) at 3,000 r/min and a mean helium pressure of 220 atm (22.3 MN/m²).

Internally Focusing Regenerative Gas Engines These engines, conceived at the Solar Energy Laboratory of the University of Wisconsin, use solar energy, concentrated by a parabolic reflector and directed through a quartz dome upon an internal absorber. This reduces the heat losses, since the engine has no external high-temperature heat transfer surfaces. A small working model of this engine has been built at Battelle Memorial Institute and was demonstrated driving a small fan.

Fractional-Horsepower Solar Hot Air Engines The Solar Energy and Energy Conversion Laboratory of the University of Florida has developed small ($\frac{1}{4}$ to $\frac{1}{2}$ hp; 0.186 to 0.25 kW) solar hot air engines (some of them converted lawnmower engines). The actual power output of the engines is determined by the size of the solar concentrator rather than by the engine. Some of these engines are self-supercharging to increase power. Water injection, self-acting, increased power by 19 percent. The average speed of the closed-cycle engines is about 500 r/min; average conversion efficiency is about 9 percent. Open-cycle engines separate the heating process from the working cycle, allowing the design of high-speed or low-speed engines as desired. Any heat source can be used with these engines, such as solar, wood, farm wastes, etc. They are simple, rugged, and designed for possible use in developing countries.

The Stirling Engine for Space Power General Motors Corporation, under contract to the U.S. Air Force Aeronautical Systems Command, adapted the GMR Stirling engine to possible space applications. A 3-kW engine was built utilizing NaK heated to 1,250°F (677°C) as a heat source and water at 150°F (66°C) as the cooling medium. The engine is pressurized to a mean pressure of 1,500 lb/in² (103.4 bar), giving an efficiency of 27 percent at 2,500 r/min. The weight of this solar energy conversion system is 550 lb (249 kg). Chemical, nuclear, or other energy sources can also be used.

Free-Piston Stirling Engines The free-piston Stirling engines, pioneered principally by William Beale, consist of displacer and power pistons, coupled by springs, inside one cylinder. They are relatively simple, self-starting, and if pressurized, can be hermetically sealed. The power piston can be coupled to a pump piston since the motion is reciprocating. Single- and double-acting engines have been designed, built, and demonstrated for water pumping and electricity generation. Some of the engines are presently under evaluation by the U.S. Agency for International Development for possible use in developing countries. They can use alternative energy sources, principally solar energy.

Closed-Environment Stirling Engines A number of Stirling engines have been developed to utilize energy sources which do not re-

quire coupling to the external environment. Such engines can be powered by specially prepared fuel sources or by stored energy.

Artificial-Heart Stirling Engines Considerable interest has been shown in the possible use of Stirling engines either to assist weakened hearts or to replace them if they have been damaged beyond repair. The program is supported by the National Heart Institute and has involved many organizations (e.g., Philips, Westinghouse, Aerojet-General, McDonnell-Douglas, University of California, Washington State University). Most of the engines are powered by nuclear fuel sources.

Low-Temperature Stirling Engines In many applications, low-temperature sources such as exhaust gases from combustion, waste steam, and hot water from solar collectors are available. Several groups (University of Florida, University of Wisconsin, Zagreb University in former Yugoslavia, etc.) are working on the development of low-temperature Stirling engines. Models for demonstration have been built and their performance has been evaluated.

Heat Pump and Cryocooler Stirling Engines A Stirling engine can be driven by any mechanical source or by another Stirling engine, and when so motored becomes a heat pump or cooler, depending upon the effects desired and utilized. Special duplex designs for Stirling engines lend themselves especially well for these applications. A number of private companies and public laboratories are involved in this development. Philips manufactured small cryocoolers in the past and sold them throughout the world.

Liquid Piston Stirling Engines Liquid piston engines are extremely simple. The basic liquid piston Stirling engine consists of two U tubes. A pipe connects the two ends of one of the U tubes with one end of the other. The unconnected end of the second U tube is left open. Both U tubes are filled with liquid, thus forming the liquid pistons. The closed U tube liquid acts as the displacer and the other as the power unit. The section of the connecting pipe between the displacer U tube ends contains the regenerator. This engine is referred to as the basic **Fluidyne**. Even though these engines have been around for a long time much development work is still needed. Their efficiencies are still extremely low.

Closure During their history, Stirling engines have experienced periods of high interest and rapid development. Stirling Engines for Energy Conversion in Solar Energy Units (Trukhov and Tursunbaev, *Geliotehnika*, **29**, no. 2, 1993, pp. 27–31) summarizes the performance of 15 Stirling engines. With supply temperatures of about 600°C, their output varies from 0.55 to 43.2 kW, their speed varies from 833 to 4,000 r/min, and their conversion efficiencies vary from 12.5 to 30.3 percent. Development work continues on some problem areas (seals, hydrogen embrittlement, weight, etc.). Interest in the potential of these engines remains high, as indicated by an average of about 50 Stirling engine papers presented and published yearly in each of the 1991 (26th) through 1994 (29th) "Proceedings of the Intersociety Energy Conversion Conferences."

POWER FROM THE TIDES Staff Contribution

REFERENCES: The Rance Estuary Tidal Power Project, *Pub. Util. Fty.*, Dec. 3, 1964. *Mech. Eng.*, Ap. 1984. ASCE Symposium, 1987: Tidal Power. Gray and Gashus, "Tidal Power," Department of Commerce, NOAA, Water for Energy, *Proc. 3d Intl. Symp.*, 1986.

The tides are a renewable source of energy originating in the gravitational pull of the moon and sun, coupled with the rotation of the earth. The consequent portion of the earth's rotation is a mean ocean tide of $2 \pm$ ft (0.6 m). The seashore periodic variation of the tides averages 12 h 25 min.

Tidal power is derivable from the large periodic variations in tidal flows and water levels in certain oceanic coastal basins. Suitable configurations of the continental shelves and of the coastal profiles result in reflection and resonance that amplify normally small bulges to ranges as high as $50 \pm$ ft ($15 \pm$ m).

Principal tidal-power sites include the North Sea [12 ft (3.6 m) average tidal range]; the Irish Sea [22 ft (6.7 m)]; the west coast of India [23 ft (7 m)]; the Kimberley coast of western Australia [40 ft (12 m)]; San Jose Bay on the east coast of the Argentine [23 ft (7 m)]; the Kislaya Guba (Kisgalobskaya Bay) near the White Sea (no data); St. Michel (including the Rance estuary) on the Brittany coast of France [26 ft (8 m)]; the Bristol Channel (Severn) in England [32 ft (9.8 m)]; the Bay of Fundy (including the Chignecto Bay between New Brunswick and Nova Scotia and the Minas Basin in Nova Scotia) [40 ft (12 m)]; Passamaquoddy Bay between Maine and New Brunswick [18 ft (5.5 m)].

The harnessing of the tides reaches back into ancient history. Tidal mills, typically with undershot water wheels, were used in New England raceway estuaries, with reversible features for ebb and flood conditions. These power applications were suitable for purposes such as grinding grain, but their number and size were small. In recent times the unique tidal ranges to $50 \pm \text{ft}$ ($15 \pm \text{m}$) have prompted many studies, proposals, and projects for most of the regions cited above. The attraction for the utilization of tides to generate electric power lies in the facts that there results no air or thermal pollution, the source is effectively inexhaustible, and the construction work related to the tidal power plant is relatively benign in its environmental impact. Despite these efforts for the generation of electricity, there are only four tidal power developments in actual service (1995)—the Rance estuary in France (240,000 kW), the Kislaya Guba in Russia (400 kW), the Bay of Fundy in Canada (20,000 kW), and a small pilot plant in Kiangshia, China.

Developments take one of two general forms: **single-basin or multiple-basin**. A single-basin project, such as the Rance, has a dam, sluices, locks, and generating units in a structure separating a tidal basin from the sea. Water is trapped in the basin after a high tide. As the water level outside the basin falls with the tide, flow from the basin through turbines generates power. Power also may be generated when a basin emptied during a low tide is refilled on a rising tide. Numerous variations in operation are possible, depending on tide conditions and the relationship between the tide cycles and the load cycles. Pumping into or out of the basin increases the availability of the installed capacity for peak load service. A multiple-basin development, such as projected for Chignecto or Passamaquoddy, generally has the power house between two basins. Sluices between the sea and the basins are so arranged that one basin is filled twice a day on high tide and the other emptied twice a day on low tide. Power output can be made continuous.

The amount of **energy available** from a tidal development is proportional to the basin area and to the square of the tidal range. Head variations are large in tidal projects during generating cycles and on a daily, monthly, and annual basis owing to various cosmic factors. Intermittent power, as from all single-basin plans and from two-basin plans with low-capacity factor, implies that the output can best be utilized as peaking capacity. Because of low heads, particularly toward the end of any generating cycle when pools have been drawn down, the cost of adding generating units only to tidal projects is well over the total installation cost of alternative peaking capacity. To be economically competitive with alternative capacity, the tidal projects must produce enough energy to pay the power-plant costs and also to pay for the dams and other costs, such as general site development, transmission, operation, and replacements.

The **risks and uncertainties** involved in designing, pricing, building, and operating capital-intensive tidal works, and the technological developments in alternative types of generating capacity, have tended to defeat tidal developments. Civil works are too extensive; transmission distances to load centers are too great; the required scale of development is too large for existing loads; the coordination of system demands and tidal generation requires interconnections for economic loading; the ultimate capacity of all the world's tidal potential is practically insignificant to meet the world's demands for electricity. In addition, the matter of interrupting tidal action and storage of tidewaters in large basins for extended periods of time raises the possibility of saltwater infiltration of adjacent underground fresh water supplies which, in many cases, are the source of drinking water for the contiguous areas.

UTILIZATION OF ENERGY OF THE WAVES

Staff Contribution

According to Albert W. Stahl, USN (*Trans, ASME*, **13**, p. 438), the total energy of a series of **trochoidal deep-sea waves** may be expressed as follows: hp per ft of breadth of wave = $0.0329 \times H^2 \sqrt{L} (1 - 4.935H^2/L^2)$, where H = height of wave, ft, and L = length of wave between successive crests, ft. For example, with $L = 25$ ft and $L/H = 50$, hp = 0.04; with $L = 100$ ft and $L/H = 10$, hp = 31.3. Not much more than a quarter of the total energy of such waves would probably be available after reaching shallow water, and apparatus rugged enough for this purpose would doubtless be unable to utilize more than a third of this amount. **Wave motors** brought out from time to time have depended for their operation largely on the lifting power of the waves.

Gravity waves may be only a few feet high yet develop as much as 50 kW/ft of wavefront. Historical wave motors utilize (1) the kinetic energy of the waves by a device such as a paddle wheel or turbine or (2) the potential energy from devices such as a series of floats or by impoundment of water above sea level. Few devices proposed utilize both forms of energy. Jacobs (*Power Eng.*, Sept. 1956) has analyzed the periodic fluctuation of “**seiching**” of the water level of harbors or basins where, with a resonant port, a 1,000-ft wavefront might be used to achieve a liquid piston effect for the compression of air, the air to be subsequently used in an air turbine.

The principle of using an oscillating column of displaced air has been employed for many years in buoys and at lighthouses, where the wave-actuated rise and fall of the column of air actuated sound horns. A wave-actuated air turbine and electric generator have been operating on the Norwegian coast to study feasibility and to gather operating data. Another similar unit has been emplaced recently off the Scottish coast, and while serving to provide operational data, it also feeds about 2 MW of power into the local grid. If the results are favorable, this particular type of unit may be expanded at this site or emplaced at other similar sites.

A variation of capture of sea wave energy is to cause waves to spill over a low dam into a reservoir, whence water is conducted through water turbines as it flows back to sea level. Any attempt to channel significant quantities of water by this method would require either a natural location or one in which large concrete structures (much of them under water) are emplaced in the form of guides and dams. The capital expenses implicit in this scheme would be enormous.

The extraction of sea wave energy is attractive because not only is the source of energy free, but also it is nonpolluting. Most probably, the capture of wave energy for beneficial transformation to electric power may be economically effected in isolated parts of the world where there are no viable alternatives. Remote island locations are candidates for such installations.

UTILIZATION OF HEAT ENERGY OF THE SEA

Staff Contribution

REFERENCES: Claude and Boucherot, *Compt. rend.*, 183, 1926, pp. 929–933. *The Engineer*, 1926, p. 584. Anderson and Anderson, *Mech. Eng.*, Apr. 1966. Othmer and Roels, Power, Fresh Water, and Food from Cold, Deep Sea Water, *Science*, Oct. 12, 1973. Roe and Othmer, *Mech. Eng.*, May 1971. Veziroglu, “Alternate Energy Sources: An International Compendium.” Department of Commerce, NOAA, Water for Energy, *Proc. 3d Intl. Symp.*, 1986.

Deep seawater, e.g., at 1-mi (1.6-km) depth in some tropical regions, may be as much as 50°F (28°C) colder than the surface water. This difference in temperature is a fundamental challenge to the power engineer, as it offers a potential for the conversion of heat into work. The Carnot cycle (see Sec. 4.1) specifies the limits of conversion efficiency. Typically, with a heat source surface temperature $T_1 = 85^\circ\text{F}$ (545°R , 29.4°C , 303 K), and a heat sink temperature T_2 50° lower, or $T_2 = 35^\circ\text{F}$

(495°R, 1.7°C, 275 K), the ideal Carnot cycle thermal efficiency = $(T_1 - T_2)/T_1 = [(545 - 495)/545]100 = 9.2$ percent.

Some units in experimental or pilot operation have demonstrated actual thermal efficiency in the range of 2 to 3 percent. These efficiencies, both ideal and actual, are far lower than those obtained with fossil or nuclear fuel-burning plants. The fundamental attraction of **ocean thermal energy conversion (OTEC)** is the vast quantity of seawater exhibiting sufficient difference in temperature between shallow and deep layers. In reality, the sea essentially represents a limitless store of solar energy which manifests itself in the warmth of seawater, especially in the top, shallow layers. Water temperatures fluctuate very little over time; thus the thermodynamic properties are relatively constant. In addition, the thermal energy is available on a 24-h basis, can be harnessed to serve a plant on land or offshore, provides "free" fuel, and results in a nonpolluting recycled effluent.

Consider the extent of the ocean between latitudes of 30°S and 30°N, and ascribe a temperature difference between shallow and very deep waters of 20°F. The theoretical energy content comes to about 8×10^{21} Btu. Of this enormous amount of raw energy, the actual amount posited for eventual recovery in the best of circumstances via an OTEC system is a minuscule percentage of that total. The challenge is to develop practical machinery to harness thermal energy of the sea in a competitive way.

The concept was put forward first in the nineteenth century, and it has been reduced to practice in several experimental or pilot plants in the past decades. There are three basic conversion schemes: closed Rankine cycle, open Rankine cycle, and mist cycle. In the closed cycle, warm surface water is pumped through a heat exchanger (boiler) which transfers heat to a low-temperature, high-vapor-pressure working fluid (e.g., ammonia). The working fluid vaporizes and expands, drives a turbine, and is subsequently cooled by cold deep water in another heat exchanger (condenser). The heat exchangers are large; the turbine, likewise, is large, by virtue of the low pressure of the working fluid flowing through; enormous quantities of water are pumped through the system. In the open cycle, seawater itself is the working fluid. Steam is generated by flash evaporation of warm surface water in an evacuated chamber (boiler), flows through a turbine, and is cooled by pumped cold deep water in a direct-contact condenser. The reduction of heat-transfer barriers between working fluid and seawater increases the overall system efficiency and requires smaller volumes of seawater than are used in the closed cycle. Introduction of a closed-cycle heat exchanger into the open-cycle scheme results in a slightly reduced thermal efficiency, but provides a valuable by-product in the form of freshwater, which is suitable for human and animal consumption and may be used to irrigate vegetation. A plant of this last type operates in Hawaii and generates 210 kW of electric power, with a 50-kW net surplus power available after supplying all pumping and other house power. This plant continues to provide operational and feasibility data for further development.

The mist cycle mimics the natural cycle which converts evaporated seawater to rain which is collected and impounded and ultimately flows through a hydraulic turbine to generate power.

Problems encountered in the implementation of any OTEC system revolve on material selection, corrosion, maintenance, and significant fouling of equipment and heat-transfer surfaces by marine flora and fauna. Although development of OTEC systems will continue, with a view to their application in fairly restricted locales, there is no prospect that the systems will make any significant impact on power generation in the foreseeable future.

POWER FROM HYDROGEN

Staff Contribution

REFERENCES: Stewart and Edeskuty, *Alternate Fuels for Transportation*, *Mech. Eng.*, June 1974. Winshe et al., *Hydrogen: Its Future Role in the Nation's Energy Economy*, *Science*, **180**, 1973.

Hydrogen offers many attractive properties for use as fuel in a power plant. Fundamentally it is a "clean" fuel, smokeless in combustion with no particulate products, and if burned with oxygen, water vapor is the sole end product. If, however, it is burned with air, some of the nitrogen may combine at elevated temperature to form NO_x , a troublesome contaminant. If carbon is present as a fuel constituent, or if it can be picked up from a source such as a lubricant, the carbon introduces further contaminant potentials, e.g., carbon monoxide and cyanogens.

Basically the potential cleanliness of combustion is supported by other properties that make hydrogen a significant fuel, to wit, prevalence as a chemical element, calorific value, ignition temperature, explosibility limits, diffusivity, flame emissivity, flame velocity, ignition energy, and quenching distance.

Hydrogen offers a unique calorific value of 61,000 Btu/lb (140,000 kJ/kg). With a specific volume of 190 ft³/lb (12 m³/kg) this translates to 319 Btu/ft³ (12,000 kJ/m³) at normal pressure and temperature, 14.7 lb/in² absolute and 32°F (1 bar at 0°C). These figures, particularly on the volume basis, introduce many practical problems because hydrogen, with a critical point of -400°F (33 K) at 12.8 atm, is a gas at all normal, reasonable temperatures. When compared with alternative fuels, results are as shown in Table 9.1.8.

These figures demonstrate the volumetric deficiency of gaseous hydrogen. High-pressure storage (50 to 100 atm) is a dubious substitute for the gasoline tank of an automobile. Liquefaction calls for cryogenic elements (Secs. 11 and 19). Chemical compounds, metallic hydrides, hydrazene, and alcohols are potential alternates, but practicality and cost are presently disadvantageous.

Hydrogen has been used to power a number of different vehicles. Its use as a rocket fuel is well documented; in that application, cost is no concern. Experimental use in automotive and other commercial vehicles with slightly altered internal combustion engines has not advanced beyond very early stages. Aircraft jet engines have been powered successfully for short flight times on an experimental basis, and it is conjectured that the first successful commercial application of hydrogen as a source of power will be as fuel for jet aircraft early in the twenty-first century.

In spite of the demonstrated thermodynamic advantages inherent in

Table 9.1.8 Bulk and Calorific Power of Selected Fuels (Approximate and Comparative)

Fuel	State	Sp. wt., lb/ft ³	Sp. gr.	Btu/lb	Btu/ft ³	Btu/gal
Hydrogen	Gas (NTP)	0.0052	0.07	61,000	320	(40)
Natural gas	Gas (NTP)	0.042	0.67	24,000	1,000	(130)
Gasoline (reg., 90 oct.)	Liquid	46	0.72	20,500	950,000	125,000
Ethanol (99 oct.)	Liquid	49	0.79	12,800	620,000	82,000
Methanol (98 oct.)	Liquid	49	0.79	9,600	480,000	64,000
Hydrogen	Liquid (36°R, 14.7 lb/in ² abs)	4.4	0.07	56,000	240,000	32,000
Coal	Piled	50	0.8	12,000	600,000	80,000

hydrogen as a source of power, in the current competitive economic market for fuels, hydrogen still faces daunting problems because of its high cost and difficulties related to its efficient storage and transportation.

DIRECT ENERGY CONVERSION

by Erich A. Farber

REFERENCES: Kaye and Welsh, "Direct Conversion of Heat to Electricity," Wiley. Chang, "Energy Conversion," Prentice-Hall. Shive, "Properties, Physics and Design of Semiconductor Devices," Van Nostrand. Bredt, Thermoelectric Power Generation, *Power Eng.*, Feb.-Apr. 1963. Wilson, Conversion of Heat to Electricity by Thermionic Conversion, *Jour. Appl. Phys.*, Apr. 1959. Angrist, "Direct Energy Conversion," Allyn & Bacon, Harris and Moore, Combustion—MHD Power Generation for Central Stations, *IEEE Trans. Power Apparatus and Systems*, 90, 1971. Roberts, Energy Sources and Conversion Techniques, *Am. Scientist*, Jan.-Feb. 1973. Poule, Fuel Cells: Today and Tomorrow, *Heating, Piping, and Air Conditioning*, Sept. 1970. Fraas, "Engineering Evaluation of Energy Systems," McGraw-Hill. Kattani, "Direct Energy Conversion, Addison-Wesley. Commercialization of Fuel Cell Technology, *Mech. Eng.*, Sept. 1992, p. 82. The Power of Thermionic Energy Conversion, *Mech. Eng.*, Sept. 1993, p. 78. Fuel Cells Turn Up the Heat, *Mech. Eng.*, Dec. 1994, p. 62. "Proceedings of the Intersociety Energy Conversion Conferences," published yearly with the 29th in 1994.

In contrast to the conventional thermal cycle for the conversion of heat into electricity are several more direct methods of converting thermal and chemical energy into electric power. The methods which seem to have the greatest potential possibilities are thermoelectric, thermionic, magnetohydrodynamic (MHD), fuel cell, and photovoltaic. The principles of operation of these processes have long been known, but technological and economic obstacles have limited their use. New applications, materials, and technology now provide increased impetus to the development of these processes.

Thermoelectric Generation

Thermoelectric generation is based on the phenomenon, discovered by Seebeck in 1821, that current is produced in a closed circuit of two dissimilar metals if the two junctions are maintained at different temperatures, as in thermocouples for measuring temperature. A thermoelectric generator is a low-voltage, dc device. To obtain higher voltages, the elements must be stacked. Typical thermocouples produce potentials on the order of 50 to 70 $\mu\text{V}/^\circ\text{C}$ and power at efficiencies on the order of 1 percent.

Certain semiconductors have thermoelectric properties superior to conductor materials, with resultant improved efficiency. The criterion for evaluating material characteristics for thermoelectric generation is the **figure of merit Z** , measured in $(^\circ\text{C})^{-1}$ and defined as $Z = S^2/(\rho K)$, where S = Seebeck coefficient, $\text{V}/^\circ\text{C}$; ρ = electrical resistivity, $\Omega \cdot \text{cm}$; K = thermal conductivity, $\text{W}/(^\circ\text{C} \cdot \text{cm})$.

An ideal thermoelectric material would have a high Seebeck coefficient, low electrical resistivity, and low thermal conductivity. Unfortunately, materials with low electrical resistivity have a high thermal conductivity since both properties are dependent, to some extent, on the number of free electrons in the material. The maximum conversion efficiency of a thermoelectric generator is a function of the figure of merit, the hot junction temperature, and the temperature difference between the hot and cold junctions.

In some types of thermoelectric materials, the voltage difference between the hot and cold junctions results from the flow of negatively charged electrons (n type, hot junction positive), whereas in other types, the voltage difference between the cold and hot junctions results from the flow of positively charged voids vacated by electrons (p type, cold junction positive). Since the voltage output of a typical semiconductor thermoelectric couple is low (about 100 to 300 $\mu\text{V}/^\circ\text{C}$ temperature difference between the hot and cold junctions), it is advantageous to use both p - and n -type materials in constructing a thermoelectric generator. The two types of materials make it possible to connect the thermojunctions in series electrically and in parallel thermally (Fig. 9.1.20).

Typical semiconductor thermoelectric materials are compounds and alloys of lead, selenium, tellurium, antimony, bismuth, germanium, tin, manganese, cobalt, and silicon. To these materials, minute quantities of

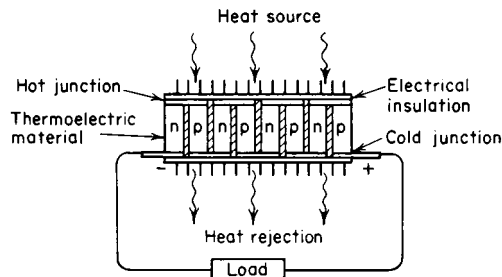

Fig. 9.1.20

"dopants" such as boron, phosphorus, sodium, and iodine are sometimes added to improve properties. Typical Z values for the more commonly used thermoelectric materials are in the range of 0.5×10^{-3} to $3.0 \times 10^{-3} (^\circ\text{C})^{-1}$. The onset of deleterious thermochemical effects at elevated temperatures, such as sublimation or reaction, limit the materials' application. Bismuth telluride alloys, which have the highest Z values, cannot be used beyond a hot-side temperature of about 300°C without encountering undue degradation. Silicon-germanium alloys have high-temperature capability up to $1,000^\circ\text{C}$ that can take advantage of higher Carnot efficiencies. However, these alloys possess low Z values. Optimized designs of thermoelectric junctions using semiconductor materials have resulted in experimental conversion efficiencies as high as 13 percent; however, the efficiency of practical thermoelectric generators is lower, e.g., 4 to 9 percent. Materials which have higher figures of merit (2 or 3×10^{-3}) and which are capable of operating at higher temperatures (800 to $1,000^\circ\text{C}$) are required for an appreciable improvement in efficiency.

Thermoelectric-generation technology has matured considerably through its application to nuclear power systems for space vehicles where modules as large as 500 W have been used. It is also used in terrestrial applications such as gas pipeline cathodic protection and power for microwave repeater stations. Development work continues, but the use of this technology is expected to be limited to special cases where power source selection criteria other than efficiency and first cost will dominate.

Thermoelectric Cooling

The **Peltier effect**, discovered in 1834, is the inverse of the Seebeck effect. It involves the heating or cooling of the junction of two thermoelectric materials by passing current through the junction. The effectiveness of the thermojunction as a cooling device has been greatly increased by the application of semiconductor thermoelectric materials. Typical applications of thermoelectric coolers include electronic circuit cooling, small-capacity ice makers, and dew-point hygrometers, small refrigerators, freezers, portable coolers or heaters, etc. These devices make it possible to preserve vaccines, medicines, etc., in remote areas and in third world countries during disasters or military conflicts.

Thermionic Generation

Thermionic generation, proposed by Schlichter in 1915, uses a thermionic converter (Fig. 9.1.21), which is a vacuum or gas-filled device with a hot electron "emitter" (cathode) and a cold electron "collector" (anode) in or as part of a suitable gastight enclosure, with electrical connections to the anode and cathode, and with means for heating the cathode and cooling the anode. A thermionic generator is a low-voltage dc device.

Figure 9.1.22 is a plot of the electron energy at various places in the converter. The abscissa is cathode-anode spacing, and the ordinate is electron energy. The base line corresponds to the energy of the electrons

in the cathode before heating. Heating the cathode imparts sufficient energy to some of the electrons to lift them over the **work function barrier** (retaining force) at the surface of the cathode into the interelectrode space. (The lower the work function, the easier it is for an electron

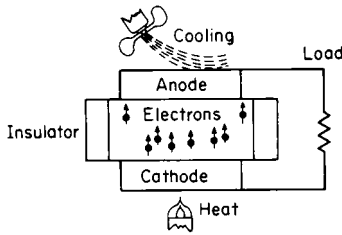

Fig. 9.1.21

to escape from the surface of the cathode.) If it is assumed that the electrons can follow path *a* to the anode with only a small loss of energy, they will “drop down” the work function barrier as they join the electrons in the anode still retaining some of their potential energy (**Fermi level**), which is available to cause an electric current to flow in the external circuit. The work function of the anode should be as small as possible. The anode should be maintained at a lower temperature to prevent anode emission or back current. This pattern presumes that the electrons could follow path *a* from the cathode to the anode with little interference. Since, however, electrons are charged particles, those in the space between the cathode and anode form a space charge barrier, as shown by *b*. This space charge barrier limits the electrons emitted from the cathode. Space charge formation can be reduced by close spacing of the cathode and anode surfaces or by the introduction of a suitable gas atmosphere that can be ionized by heating and thus neutralize the space charge. In vacuum-type thermionic converters, the spacing between cathode and anode must be less than 0.02 mm to get as many as 10 percent of the electrons over to the cathode and to achieve an efficiency of 4 to 5 percent. In gas-filled converters, the negative electron space charge is neutralized by positive ions. Cesium vapor is used for this purpose. At low pressure, it will also lower the work function of the

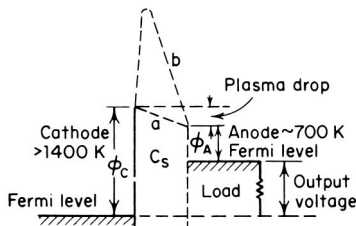

Fig. 9.1.22

anode, and at high pressure, it can, in addition, be used to adjust the work function of the cathode. Efficiencies as high as 17 percent have been obtained with gas-filled converters operating at a cathode temperature of 1,900°C (2,173 K). The output voltage is 1 to 2 V, so the units must be connected in series for reasonable utilization voltages.

Thermionic development results have been encouraging, but major technical challenges remain to be resolved before reliable, long-life converters become available. Effort has been focused on problem areas such as the limited life of emitter materials, leaktightness of the converter, and dimensional stability of the converter gap. Studies of thermionic converters incorporated into nuclear reactors and as a topping cycle for fossil fuel fired steam generators as well as for space and solar applications have received the greatest attention.

Fuel Cells

The **fuel cell** is an electrochemical device in which electric energy is generated by chemical reaction without altering the basic components

(electrodes and electrolyte) of the cell itself. It is a low-voltage, dc device. To obtain higher voltages, the elements must be stacked. The fact that electrode and electrolyte are invariant distinguishes the fuel cell from the primary cell and storage battery. The fuel cell dates back to 1839, when **Grove** demonstrated that the electrolysis of water could be reversed using platinum electrodes. The fuel cell is unique in that it converts chemical energy to electric energy without an intermediate conversion to heat energy; its efficiency is therefore independent of the thermodynamic limitation of the Carnot cycle. In practical units, however, its efficiency is comparable with the efficiency of Carnot limited engines.

Figure 9.1.23 is a simplified version of a hydrogen or hydrocarbon fuel cell with air or oxygen as the other reactant. The fuel is supplied to the anode, where it is ionized, freeing electrons, which flow in the external circuit, and hydrogen ions, which pass through the electrolyte to the cathode, which is supplied with oxygen. The oxygen is ionized by

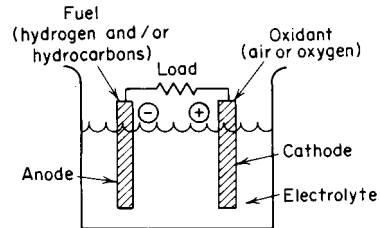

Fig. 9.1.23

electrons flowing into the cathode from the external circuit. The ionized oxygen and hydrogen ions react to form water. Electrodes for this type of cell are usually porous and impregnated with a catalyst. In a simple cell of this type, chemical and catalytic action take place only at the line (**notable surface of action**) where the electrolyte, gas, and electrode meet. One of the objectives in designing a practical fuel cell is to increase the notable surface of action. This has been accomplished in a number of ways, but usually by the creation of porous electrodes within which, in the case of gas diffusion electrodes, the fuel and oxidant in gaseous state can come in contact with the electrolyte at many sites. If the electrolyte is a liquid, a delicate balance must be achieved in which surface tension and density of the liquid must be considered and gas pressure and electrode pore size must be chosen to hold their interface inside the electrode. If the gas pressure is too high, the electrolyte is excluded from the electrode, gas leaks into the electrolyte, and ion flow stops; if the gas pressure is too low, drowning of the electrode occurs and electron flow stops.

Fuel cells may be classified broadly by operating temperature level, type of electrolyte, and type of fuel. Low-temperature (less than 150°C) fuel cells are characterized by the need for good and expensive catalysts, such as platinum and relatively simple fuel, such as hydrogen. High temperatures (500 to 1,000°C) offer the potential for use of hydrocarbon fuels and lower-cost catalysts. Electrolytes may be either acidic or alkaline in liquid, solid, or solid-liquid composite form. In one type of fuel cell, the electrolyte is a solid polymer.

Low-temperature fuel cells of the hydrogen-oxygen type, one a solid-polymer electrolyte type, and the other using free KOH as an electrolyte, have been successfully applied in generating systems for U.S. space vehicles. High-temperature fuel cell development has been primarily in molten carbonate cells (500 to 700°C) and solid-electrolyte (zirconia) cells (1,100°C), but no significant practical applications have resulted.

Considerable study and development work has been done toward the application of fuel cell generating systems to bulk utility power systems. Low-temperature cells of the phosphoric acid matrix and solid-polymer electrolyte types using petroleum fuels and air have been considered. Cell efficiencies of about 50 percent have been achieved; but with losses in the fuel reformers and electrical inverters, the overall system efficiency becomes of the order of 37 percent. In this application

fuel cells have environmental advantages, such as low noise, low atmospheric emissions, and low heat rejection requirements. Additional development work is necessary to overcome the disadvantage of high catalyst costs and requirements for expensive fuels. More than 50 phosphoric acid fuel cell units, having a capacity of 200 kW, are in use. Companies in Canada, Germany, and the United States have demonstrated fuel cells in passenger bus propulsion systems. They are cooperating now on the development of proton exchange fuel cells. Other U.S. and Japanese companies are developing power plants for transportation.

Magnetohydrodynamic Generation

Magnetohydrodynamic generation utilizes the movement of electrically conducting gas through a magnetic field. Normally, it results in a high-voltage, dc output, but it can be designed to provide alternating current. In the simple open-cycle MHD generator (Fig. 9.1.24), hot, partially ionized, compressed gas, which is the product of combustion, is expanded in a duct and forced through a strong magnetic field. Electrodes in the sides of the duct pick up the potential generated in the gas, so that current flows through the gas, electrodes, and external load. Temperature in excess of 3,000 K is necessary for the required ionization of gas, but this can be reduced by the addition of a seeding material such as potassium or cesium. With seeding, the gas temperature may be reduced to the order of 2,750 K. The temperature of the gas leaving the generator is about 2,250 K. Although the efficiency of the basic MHD channel is

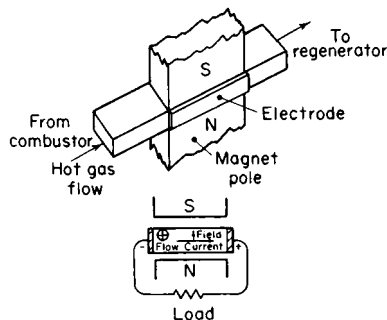

Fig. 9.1.24

on the order of 70 percent, only a portion of the available thermal energy can be removed in the channel. The remainder of the energy contained in the hot exhaust gas must be removed by a more conventional steam cycle. In this combined-cycle plant, the exhaust gas from the MHD generator is passed sequentially through an air preheater, the steam superheater and boiler, and an economizer and stack gas cooler. The air preheater is necessary to raise the temperature of incoming combustion air to some 1,900 K in order to obtain the initial gas temperature of 2,750 K.

The potential improvement in efficiency from the use of MHD generator in a combined-cycle plant is in the order of 15 to 30 percent. An overall steam plant efficiency of 38 percent could be raised to some 45 to 54 percent. Contrasted to other methods for direct conversion, MHD generation appears best suited to large blocks of power. For example, an MHD generator 75 m long with an average magnetic field of 5 T (attained by means of a superconductive magnet) would have a net output of about 1,000 MW dc at 5 to 10 kV. Typically, this would provide topping energy for a steam plant of about 500 MW.

Although the MHD topping cycle offers the highest peak cycle temperature and thermodynamic cycle efficiency of any system that has been studied, none of the generators tested have yielded enough efficiency to account for even half of the power required to supply oxidant to the combustor. Serious materials problems have also been experienced, with severe erosion, corrosion, and thermal stresses in the electrodes and insulators. Slow progress in the solution of these and other difficulties diminishes the prospect for a viable MHD system in the foreseeable future.

Closed-cycle MHD generators are also under study for bulk power generation. They are of two types: first, one in which the working fluid is an inert gas such as argon seeded with cesium; and second, the liquid-metal type in which the working fluid is a helium-sodium mixture. Closed-cycle MHD generation offers the potential for high efficiency with considerably lower peak cycle temperatures, lower pressure ratios, and lower average magnetic-flux density.

Photovoltaic Generation

Photovoltaic generation utilizes the direct conversion of light energy to electric energy and stems from the discovery by Becquerel in 1839 that a voltage is generated when light is directed on one of the electrodes in an electrolyte solution. Subsequent work using selenium led to the development of the photoelectric cell and the exposure meter. It results in low-voltage direct current. To obtain higher voltages, the elements must be stacked.

Photovoltaic effect is the generation of electric potential by the ionization by light energy (photons) of the area at or near the *p-n* junction of a semiconductor. The *p-n* junction constitutes a one-way potential barrier which permits the passage of photon-generated (–) electrons from the *p* to the *n* material and (+) “holes” from the *n* to the *p* material. The resulting excess of (–) electrons in the *n* material and (+) holes in the *p* material produces a voltage at the terminals comparable to the junction potential.

Solar cells have been a useful source of electricity since about 1960 and have enjoyed widespread use for small amounts of electric energy in remote locations. They have proved particularly well suited for use in spacecraft; in fact, much of the effort in photovoltaic R&D has been funded by the space program. Solar cells have been applied also to remote weather monitoring and recording stations (some of them equipped with transmitters to send the data to collecting stations), traffic control devices, buoys, channel markers, navigational beacons, etc. They can also be used for applications such as battery chargers for cars, boats, flashlights, tools, watches, calculators, and emergency radios. Cost reduction through the use of polycrystalline or thin-film techniques constitutes a major development effort.

A commercially available solar cell is constructed of a 0.3-mm-thick silicon wafer (2×2 cm or 2×6 cm) that is doped with boron to give it a *p*-type characteristic. It is then diffused with phosphorus to a depth of about 10^{-4} cm (*n*-type layer), and subsequently electrically contacted with titanium-silver or gold-nickel. Contacting on the light exposure side is limited to maximize transmission of light into the cell. The cell is coated with antireflection material to reduce losses due to light reflection. The cell is then electrically coupled to the intercell circuit by soldering. The method of fabricating solar cells is complex and expensive.

The efficiency of a photovoltaic cell varies with the spectrum of the light. The maximum theoretical efficiency of a single-junction, single-transition silicon cell with solar illumination is about 22 percent. Actual cell performance has been realized at 12 to 15 percent efficiency at 0.6 V open circuit and 0.02 W/cm². Advanced cells using materials such as gallium arsenide and cadmium telluride offer maximum theoretical efficiencies above 25 percent. Further cell efficiency improvement is being investigated by concentrating the sunlight with a Fresnel lens or parabolic mirror and by selecting the light spectrum.

Factors reducing the efficiency of conversion of light energy into electricity using solar cells include: (1) the fact that only a certain bandwidth of the solar spectrum can be effective, (2) structural defects and chemical impurities within the materials, (3) reflection of incident light, and (4) cell internal resistance. These factors lower the overall efficiency of solar arrays to about 6 to 8 percent. Another drawback is the intermittent nature of the solar source, which necessitates the use of an energy storage facility.

It is commonly agreed that substantial investments will be necessary to make solar cell energy conversion economically competitive with terrestrial fossil fuel fired or nuclear power plants. Space applications remain a practical use of this technology, since long life and reliability override cost considerations.

Other Energy Converters

Each of the converters described in the following section has characteristics which makes it suitable for specific tasks. Some produce low-voltage direct current and must be stacked for higher voltage output. Other converters produce high-voltage direct or alternating current depending upon their design. High voltages can be used to drive Klystron or X-ray tubes, or similar equipment, and can be transmitted without step-up transformers. Some medium- or low-temperature converters can be used in low-grade energy (heat) applications; in medical practice, e.g., body heat can drive heart pacemakers, artificial heart pumps, internal medicine dispensing devices, and organ monitoring equipment.

Electrohydrodynamic Converters When positive ions are transported by neutral hot gases against an electric field, high potential differences result. The charges produced by the ions do work when allowed to flow through a load. These devices are also called **electro-gas-dynamic (EGD)** converters. If the gases are allowed to condense, producing small liquid droplets, the devices are often referred to as **aerosol EGD** converters. A number of different basic designs exist.

Van der Graaff Converter This device operates on the same principle as the EHD converter, except that a belt is used instead of hot gases to transport the ions against an electric field. Very high potential differences are produced, which may be utilized in high-energy particle accelerators, atom smashers, artificial lightning generators, and the like.

Ferroelectric Converters Certain materials exhibit a rapid change in their dielectric constant k around their Curie temperature. The voltage produced by a charge is the charge divided by the capacitance, or $V = Q/C$. The variation between capacitance and dielectric constant is expressed by $C_h = (k_h/k_c)C_c$, where $c = \text{cold}$ and $h = \text{hot}$.

A capacitor containing ferroelectric material is charged when the capacitance is high. When the temperature is changed to lower the dielectric constant, the capacitance is lowered, with an accompanying increase in voltage. The charge is dissipated through a load when the voltage is high, resulting in the performance of work. Barium titanate, e.g., can produce a fivefold voltage swing between temperatures of 100 and 120°C. Thermocycling could be produced by the sun on a spinning satellite.

Ferromagnetic Converters Ferromagnetic material is used to complete the magnetic circuit of a permanent magnet. The ferromagnetic material is heat-cycled through its Curie point, producing flux changes in a coil wrapped around the magnet. The operating conditions can be selected by the Curie temperature of the ferromagnetic material. Gadolinium, e.g., has a Curie point near room temperature.

Piezoelectric Converters When axisymmetric crystals are compressed parallel to their polar axes, they become polarized; i.e., positive charges are generated on one side, and negative charges are generated on the other side of the crystal. The induced compressive stresses can be produced mechanically or by heating the crystal. The resulting potential difference will do work when allowed to flow through a load. In a reverse process, imposing a potential difference between the ends of the crystal will result in a compressive stress within the crystal. The imposition of alternating current will result in controlled oscillations useful in sonar, ultrasound equipment, and the like.

Pyroelectric Converters Some materials become electrically polarized when heated, and the conversion of heat to electricity can be utilized as it is in piezoelectric converters.

Bioenergetic Converters Energy requirements for medical devices used to monitor or control the performance of human organs (heart, brain, etc.) range from a few microwatts to a few watts. In many cases, body heat is sufficient to operate an energy converter which, in turn, will power the device.

Nernst Effect Converters When heat flows through certain semiconductors exposed to a magnetic field perpendicular to the direction of heat flow, an electric potential difference will be induced along a third orthogonal axis. This conversion of heat to electricity can be utilized to do work. In a reverse fashion, crossing a magnetic and an electric field will produce a temperature difference (Ettinghausen effect, the reverse of the Nernst effect). This reverse conversion is useful in electric heating, cooling, and refrigeration.

Thermophotovoltaic Converters A radiant heat source surrounded by photovoltaic cells will result in the radiant energy being converted to electricity. Source radiation and photovoltaic cell characteristics can be controlled to operate anywhere in the spectrum.

Photoelectromagnetic Converters When certain semiconductors (Cu_2O , for example) are placed in a tangential magnetic field and illuminated by visible light, there will result an electric potential difference along an axis orthogonal to the other two axes. The resulting flow of electric current can be used to do work.

Magnetothermoelectric Converters A magnetic field applied to certain thermoelectric semiconductors produces electric potential differences, useful in power generation.

Superconducting Converters The phase transition in a superconductor can be utilized similarly to a ferroelectric converter. Thermal cycling of the superconductor material will produce alternating current in the coil surrounding it. An idealized analysis for niobium at 8 K yields a conversion efficiency of about 44 percent.

Magnetostrictive Converters Changes in dimensions of materials in a magnetic field produce electric potential differences, thus converting mechanical energy to electricity. The effects can be reversed by combining an electric field with a magnetic field to produce dimensional changes.

Electron Convection Converters When a liquid is heated (sometimes to the boiling point), electrons and neutral atoms are emitted from the liquid surface. The flow of vapor transports the electrons upward, where they are collected on screens. The vapor condenses and recycles into the liquid pool. High electric potential differences can be produced in this manner between the screens and the liquid pool, allowing the subsequent flow of current to do work. The process is similar to that for EGD converters.

Electrokinetic Converters Certain fluids flowing through capillary tubes due to pressure gradients produce an electric potential difference between the ends of the capillaries, converting flow (kinetic) energy to electricity.

Particle-Collecting Converters When an alpha, beta, or gamma particle emitter is surrounded by a collector surface, an electric potential difference is produced between the emitter and the collector. Biased screen grids can improve the performance.

EHD Water Drop Converter Two separate streams of water coming from the same reservoir, in falling, are allowed to break up into droplets. At the breakup points, each stream is surrounded by a short metal cylinder. Each cylinder is connected electrically to a screen at the bottom of the opposite stream. High potential differences are produced between the two metal cylinders.

Photogalvanic Converters Photochemical reactions often produced by solar radiation (especially at the shorter wavelengths) can be used to generate electricity. Concentration of solar energy can increase the power of the converters considerably. The actual processes are similar to those in fuel cells.

The field of instrumentation provides other techniques which could become useful as energy conversion devices. While many of the methods cited and described above are not economically competitive with conventional conversion methods in current use, some are adapted to unique situations where the matter of cost becomes inconsequential. Certainly, it is expected that as progress is made in the field of energy conversion, certain techniques will be refined to greater practicality, and others will be developed.

FLYWHEEL ENERGY STORAGE by Sherwood B. Menkes

REFERENCES: The Oerlikon Electrogyro: Its Development and Application for Omnibus Service, *Auto Eng.*, Dec. 1955. Beams, Magnetic Bearings, *SAE Automotive Congress Proc.*, Jan. 1964. Beachley and Frank, Electric and Electric-Hybrid Cars, SAE paper 730619, Mar. 1973. Clerk, The Utilization of Flywheel Energy, SAE Paper 711A, June 1963. Lawson and Hellman, Design and Testing of High Energy Density Flywheels for Application to Flywheel/Heat Engine Hybrid Drives, SAE Paper 719150, Aug. 1971. Post and Post, Flywheels, *Sci. Am.*,

Dec. 1973. Rabenhorst, Primary Energy Storage and the Super Flywheel, Johns Hopkins University, TG 1081, Oct. 1970. Weber and Menkes, Flywheel Energy Propulsion and the Electric Vehicle, Paper 7458, Electric Vehicle Symposium, Feb. 1974. Ashley, UT and BMW Collaborate on Flywheel Systems, *Mech. Eng.*, Aug. 1994. Olszewski, Eisenhaure, Beachley, and Kirk, On the Fly or under Pressure, *Mech. Eng.*, June 1988. Ashley, Flywheels Put a New Spin on Electric Vehicles, *Mech. Eng.*, Oct. 1993. Flywheels Are Back, *Compressed Air Mag.*, June 1993.

For many years a **flywheel** has been defined as a heavy wheel which is used to oppose and moderate by its inertia any fluctuation of speed in the machinery with which it revolves. Shafts in many different kinds of machinery are subjected to torque loading that is not uniform throughout a work cycle. By utilizing a flywheel, the designer can incorporate a smaller driving motor, and achieve a smoother operation.

Until recently, design of flywheels has not posed any serious difficulties, for work cycles have been relatively short, and the flywheel functioned solely to regulate speed. The kinetic energy has been relatively small. Concentration of material in a massive rim provides the maximum moment of inertia for a given amount of material.

Within the last few years, as a result of concern about fuel shortages and environmental pollution, suggestions have been made to utilize unconventional energy sources. Accordingly, there is much interest in the use of flywheels to store large amounts of kinetic energy. *Thus the flywheel is proposed as a major storage device, rather than as a means to effect speed regulation.*

As Post and Post observed, old concepts often reappear in technology as our needs change. Flywheels were probably first used as energy storage devices in the potter's wheel, perhaps 5,000 years ago. The spindle was vertical; there was a head, on which clay was placed, and a separate flywheel below. The flywheel was used to store enough energy to turn rapidly and for a long time.

A power plant is designed to operate most efficiently under a set of stated conditions. When it is necessary to operate the plant at off-design conditions, efficiency decreases, often quite severely. If the plant is operated only at high efficiency, and the excess energy is stored until it is needed, fuel is conserved. In addition, certain sources of energy (solar radiation, wind, etc.) become attractive provided that we can deal effectively with the question of storing energy *thus freely available* until such time as it can be used.

The flywheel is an attractive energy storage concept for several reasons: (1) it is simple; (2) it is possible to store and abstract energy readily, either by mechanical means or by using electric motors and generators; (3) high power rates are practicable; (4) there is no stringent limitation on the number of charge and discharge cycles that can be used; (5) reliability promises to be high; and (6) maintenance costs should be low.

Modern flywheel technology is in its infancy. The first symposium on the state of the art was held in November 1975. Any specific application will require consideration of technical alternatives and a cost analysis. The following must be evaluated in each case: (1) how much energy can be stored per unit weight or volume of flywheel material, which in turn controls (2) the size flywheel required, (3) relative importance of friction losses and associated inefficiency, (4) system safety, and (5) nature of controls and systems needed to provide the proper interface between source of energy and the demand for it.

A uniform flat disk with a central hole was suggested to replace the massive rim flywheel, but the resultant dynamic stress distribution limits its use.

Improved stress distribution (for an **isotropic material**) can be effected by thickening the flywheel toward the center and making it possible to achieve a constant tangential stress distribution. The energy density capability of a flywheel in which constraints other than those due to stress considerations are removed can be calculated from

$$T = K_s \sigma / \rho$$

in which T is the specific energy, K_s a flywheel shape factor, σ the material working stress, and ρ the material density. For a solid metal wheel, the ideal shape is one in which K_s is unity. Lawson reports that

Lockheed has achieved a shape factor of 0.832; such a wheel constructed of *maraging steel* results in a T value of 52 Wh/kg.

The parameter T is useful to compare candidate energy storage concepts. Table 9.1.9, prepared by Weber and Menkes as part of a feasibility study of a flywheel powered local-duty automobile, indicates the range of possible values. Note the inclusion of the *Oerlikon gyrobus*, the first vehicular application of flywheel energy storage. Advanced anisotropic materials offer great promise as flywheel materials, and many organizations are now engaged in the design and development of fiber composite flywheels. These high-strength fibers, which include E glass, PRD - 49 (Kevlar), S glass, fused silica, and others, dictate radical changes in design concepts.

The size range for suggested flywheels is considerable, as are the recommended speed and energy capacity. Some applications are discussed below.

Central Stations Long-range energy storage in central stations is accomplished by storing fuel (coal, oil, or gas), using a hydro reservoir and, more recently, cryogenic tanks. The basic problem is brought about by **highly fluctuating power demand**. A typical electric utility load cycle has a peak on weekdays nearly double the demand at night, while there are no comparable peak demands on weekends.

Considerations of economy and efficiency make it attractive to increase the base capacity of the central station, to generate and store excess energy when it is available, and to draw on the stored energy when it is needed. One technique, in limited use, employs a pumped hydrostorage installation. The principal advantage there is that while the potential energy of fluid is stored at a higher elevation, there is no continuous loss of energy; this cannot be said for flywheel energy storage. Furthermore, pumped hydrostorage systems are completely safe and make use of existing technology both to store and to abstract the energy.

Unfortunately, *severe geographical constraints* limit the use of pumped hydrostorage as a *universal solution*.

Flywheels offer a good alternative to *pumped hydrostorage*, on the grounds of (1) compactness, (2) high power density, (3) reliability and low maintenance, (4) unlimited cycle life, and (5) good thermal compatibility with the environment. Several technological advances must be achieved, however, before flywheel energy storage becomes cost-effective. These *necessary* improvements are: (1) development of low-cost, high-energy-density composite rotors, (2) development of very low-friction bearing systems, and (3) development of improved motor generator systems and controls.

The first two factors are self-evident; the last is not. A generator must extract energy from a constantly decelerating flywheel, and then feed it into a power network at constant voltage and frequency. The generator must either invert the variable-frequency input to the desired frequency

Table 9.1.9 Energy Density T for Various Storage Elements

Storage element	Wh/kg
Internal combustion engine system	550*
Electrochemical storage:	
Lead-acid	18-33
Nickel-cadmium	26-40
Silver-zinc	66-132
Zinc-air (experimental)	110-176
Sodium-sulfur (experimental)	154-220
Lithium-halide (experimental)	220
Flywheels:	
Gyreacta transmission	0.7†
Oerlikon gyrobus	7.0†
4340 steel	26
Maraging steel	55
Advanced anisotropic materials	190-870
Hydraulic accumulator	7-15
Natural elastic band	9

* Based on specific fuel consumption of 0.5 lb/(bhp · h) and engine weight equal to that of gasoline carried.

† Systems actually operated.

or use some other scheme to accomplish the same result. Several systems are being developed which will do this.

Transportation Applications Ground transport vehicles are powered, by and large, exclusively by internal combustion engines. In passenger vehicles in particular, the thermal efficiency of the cycle is of the order of 10 to 15 percent. The waste of fossil fuel distillates and the concomitant problem of air pollution are well documented. Accordingly, it is attractive to consider the possibility of generating electricity at a remote site, and *providing on-board energy storage*. Under certain circumstances, an auxiliary supply can be maintained external to the vehicle (as in a third rail), but for reasonable route flexibility, a self-contained store of energy is required.

A number of suggestions have been made which are in various stages of development. At one extreme is an *all-electric local-duty vehicle*; at the other is a *hybrid heat engine and flywheel energy storage* without electric energy utilization at all. An intermediate arrangement would use a *heat engine, a flywheel, and an electric traction motor* drive system.

In the **all-electric vehicle**, major design problems include (1) development of a passive bearing system with an ultra-low-energy drain, (2) an increase in energy density capability of flywheels to provide reasonable *range and speed*, (3) a design safe enough to withstand collisions, and (4) development of a compact and efficient motor generator unit.

In the **heat engine flywheel hybrid** with entirely mechanical means of using flywheel energy, no new technology is needed. Such a vehicle can make fairly impressive gains in fuel economy, especially by means of *regenerative dynamic braking*. The major difference between this and

conventional vehicles lies in the need for a *continuously variable transmission unit* coupled to the flywheel.

A **modification of the all-electric vehicle** would require the addition of a small heat engine, perhaps 25 percent the size of those now in use. This heat engine can be operated at maximum efficiency, with the storage element being used to supply energy for acceleration. The driver could switch to all-electric mode for urban driving or short trips.

Greater attention is being paid to hybrid vehicles utilizing flywheels in conjunction with either an all-electric vehicle or a combined internal combustion/electric battery drive vehicle. Together with continuing attention given to flywheel material and construction, efforts are being made to introduce electric drive vehicles for passenger automobiles within the next several years in several states. Those efforts are accompanied by continued advances in high-strength composite materials for flywheels, frictionless magnetic bearings, high-efficiency motor generators, and continued miniaturization of power components and control electronics. The reference to Olszewski et al. is particularly instructive as to recent data and design details which have met with some success in the continuing development work in this generic area.

Regenerative dynamic braking is in use in the New York subway system; a **flywheel trolley coach** was developed for the city of San Francisco.

The output from an **exotic source**—sun or wind—is cyclical in nature. Exploitation of this type of energy source, especially for generating electric power, must be accompanied by suitable “flywheel” energy storage devices. Toward that end, rotating flywheels may hold promise for small units adaptable to residential use, especially in remote areas.

9.2 STEAM BOILERS

by Joseph C. Delibert

REFERENCES: The Babcock & Wilcox Co., “Steam—Its Generation and Use.” Combustion Engineering, Inc., “Combustion—Fossil Power Systems.” Staniar, “Plant Engineering Handbook,” McGraw-Hill. Powell, “Water Conditioning for Industry,” McGraw-Hill. “Boiler and Pressure Vessel Code,” “Power Test Code for Steam Generating Units,” American Society of Mechanical Engineers. Also, *Proceedings* of the ASME, the Joint Power Generation Conference, and the American Power Conference.

FUELS AVAILABLE FOR STEAM GENERATION

(See also Secs. 7, 9.1, and 9.8.)

A large variety of materials and heat sources can be used for steam generation. In the absence of other considerations, boilers are designed to use the most economical fuel or combinations of fuels available. These include natural gas, residual oil, and coal. Some typical solid fuels are: anthracite coal, bituminous and subbituminous coal, coke breeze, fluid petroleum coke (4 to 5 percent volatile), lignite, low-temperature fluid coal char (with auxiliary fuel), petroleum coke (9 to 14 percent volatile; with auxiliary fuel), pipeline slurry, wood and bark, and bagasse and other agricultural wastes. Other less common energy sources, many suitable for steam generation, are described in Sec. 9.1.

Sources of fuel nearest the plant are generally favored, but the spread of oil and gas pipelines throughout the United States and improved efficiency of coal transportation (unit trains, pipeline slurry) have greatly altered regional use patterns. Restrictions by the Environmental Protection Agency (EPA) on air and water pollution (Sec. 18) and the potential for interruption of oil supplies must also be considered. Many industries use their by-products for steam generation. Paper mills burn the black liquor from the cooking of wood pulp. Steel mill boilers may be fired with blast furnace and coke oven gases. Oil refineries burn lean CO gas, a waste product, in combination with a richer gas. The increased cost of basic fuels has caused many other industries to consider

the use of their own combustible or heat-bearing by-products. The use of municipal wastes for steam generation is also accelerating (Sec. 7.4).

EFFECT OF FUEL ON BOILER DESIGN

Fuel is the governing factor in boiler design. Clean natural gas leads to the simplest design. If it is the only fuel, the boiler can be relatively small and compact. When solid or liquid fuels are to be used, the boilers will be larger because of the need to provide the required furnace volume for combustion and to accommodate ash and slag. Also, unless the fuel is low in sulfur content, the resultant combustion products will contribute to air pollution and must be reduced to approved levels before release. Equipment for this purpose can be large and expensive (Secs. 17.5 and 18). Some manufacturers offer **fluidized-bed firing** which uses a mixture of fine coal and limestone to trap most of the sulfur compounds in the ash. The equipment is not yet in general use.

Depending on the type of firing, considerable amounts of fly ash may be carried to the stack. Fly ash collectors and electrostatic precipitators are usually required to meet governmental requirements (Sec. 18). Oxides of nitrogen can also contribute to air pollution. These are formed from both fuel-bound nitrogen and the nitrogen contained in the combustion air. Nitric oxide omission can be controlled primarily by equipment design and operating techniques without appreciable impact on costs (Secs. 4, 7, and 18).

SLAG AND ASH

Boilers fired with pulverized coal can be designed for either dry-ash or slag-tap operation. The dry-ash type is particularly suited for coals with high ash-fusion temperatures. The ash impinging on the water-cooled furnace walls can be readily removed. The slag-tan furnace uses coals

having low ash-fusion temperatures and is designed to have high temperatures near the furnace floor, thus keeping the ash molten for tapping.

When sintered or fused, ash forms deposits on furnace walls, boiler surfaces, and superheater tubes, thus reducing heat absorption, increasing draft loss and possibly causing overheating of tubes. Two general types of slag deposition can occur on furnace walls and convection surfaces. **Slagging** takes place when molten or partially fused ash particles entrained in the gas strike a wall or tube surface, become chilled, and solidify. Coals with low ash-fusion temperatures [i.e., those that are plastic or semimolten at temperatures less than 2,000°F (1,093°C)] have a high potential for slagging. Although normally confined to the furnace area, slagging can occur in the convection sections if proper design and operating parameters are not observed.

Fouling occurs when the volatile constituents in the ash condense on fly-ash particles, convection tubes, and existing ash deposits, at temperatures which keep the volatile constituents liquid and allow them to react chemically to form bonded deposits.

Slagging and fouling characteristics can be evaluated from the chemical composition of the ash by empirically determined relationships. The amount and the chemical and physical characteristics of coal ash vary over a wide range, not only from mine to mine, but also from different parts of the same mine. Thus, in design of boilers or selection of new coal sources for existing units, it is essential to have a thorough knowledge of the coal ash characteristics. Considerable data have been accumulated over the years, much of it based on eastern coals. Western coals are being used more extensively, and new criteria, often at variance with eastern experience, are being developed (Heil and Durrant, *Proc. JPGC*, 1978).

Coal ash may be classified as **eastern** or **lignitic**. By definition, if $MgO + CaO$ is greater than Fe_2O_3 , the ash is lignitic. If it is smaller, the ash is bituminous. This is important because subbituminous coal can have a lignitic type ash. Ash from eastern coals generally falls in the bituminous category while that from the west tends to be lignitic. Some of the parameters used to evaluate the effect of an ash on furnace slagging and deposition on both furnace walls and convection surfaces include:

Ash fusion temperatures

Iron content and ferritic percentage

$$\frac{(\text{Fe}_2\text{O}_3) \times 100}{\text{Fe}_2\text{O}_3 + 1.11\text{FeO} + 1.43\text{Fe}}$$

Silica ratio

$$\frac{(\text{SiO}_2) \times 100}{\text{SiO}_2 + \text{Fe}_2\text{O}_3 + \text{CaO} + \text{MgO}}$$

Base/acid ratio B/A

$$\frac{\text{Fe}_2\text{O}_3 + \text{CaO} + \text{MgO} + \text{Na}_2\text{O} + \text{K}_2\text{O}}{\text{SiO}_2 + \text{Al}_2\text{O}_3 + \text{TiO}_2}$$

Dolomite percentage

$$\frac{(\text{CaO} + \text{MgO}) \times 100}{\text{Fe}_2\text{O}_3 + \text{CaO} + \text{MgO} + \text{Na}_2\text{O} + \text{K}_2\text{O}}$$

Viscosity

Sintered strength

The preferred procedure for determining ash fusion temperatures is outlined in ASTM Standard D-1857, which defines and provides procedures to determine **initial deformation temperature (IDT)**, **softening temperature (ST)**, **hemispherical temperature (HT)**, and **fluid temperature (FT)**.

Iron has a significant effect on the behavior of coal ash. In the completely oxidized form it tends to raise fusion temperatures; in the lesser oxidized form it tends to lower them (Fig. 9.2.1). The iron content and its degree of oxidation also have a great influence on the viscosity, which increases with ferritic percentage. Liquid slag is not troublesome

as long as it remains a true liquid with a viscosity below 250 poise. The most troublesome form is plastic slag which is arbitrarily defined to exist in the region where the viscosity is 250 to 10,000 poise.

Slagging Indices The most accurate indicator of potential slagging for eastern or western coals is the viscosity-temperature relationship of

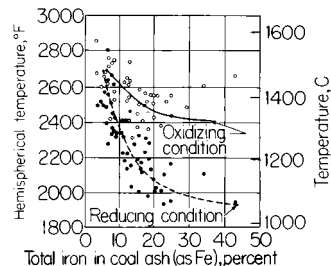

Fig. 9.2.1 Influence of iron on hemispherical temperature of ash.

the ash (Moore and Ehrler, *Proc. ASME*, WAM, 1973). Since viscosity measurements are costly and time-consuming, means have been developed to calculate furnace slagging potential from chemical analyses. For *eastern bituminous coals* the index is $(B/A)S$, where S is the percent sulfur, as S , on the dry-coal basis. The potential of ash with an index less than 0.6 is low; 0.6 to 2.0, medium; 2.0 to 2.6, high; above 2.6, severe.

For *lignitic-type ash*, slagging indices are based on fusion temperatures: $[\text{max HT} + 4(\text{min IDT})]/S$, where the temperatures are the highest and the lowest reducing or oxidizing temperatures. Indices less than 2,100°F (1,149°C) are classed as severe slagging; 2,100 to 2,250°F (1,149 to 1,232°C), high; 2,250 to 2,450°F (1,232 to 1,343°C), medium.

Fouling Indices The volatile constituents of the ash (i.e., Na_2SO_4 or $\text{CaSO}_4 \cdot \text{Na}_2\text{SO}_4$) cause fouling and can be used as an indication of the fouling potential of a given coal. Two factors that affect fouling are deposit hardness and rate of deposition. Ash fusion temperatures bear little relation to the tendency to form bonded deposits (Fig. 9.2.2). Deposit hardness is affected by the chemical composition, temperature,

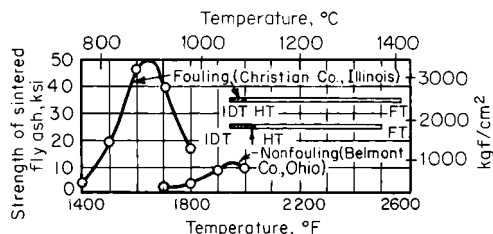

Fig. 9.2.2 Comparative sintered strengths and ash fusion temperatures for a fouling and a nonfouling coal.

and, to some extent, time. The rate of deposition is dependent on the volatile constituents and the amount of ash in the coal. Sintering strength of the ash, as determined in the laboratory, is an indication of how hard a deposit might become at different temperatures and has been used to predict fouling potential. Since these tests are expensive, the sintering strength has been related to the chemical composition (Fig. 9.2.3). (See Attig and Duzy, *Proc. Amer. Pwr. Conf.*, 1969). For *eastern coals* the **chemical index** is $(B/A) \times \text{Na}_2\text{O}$ where Na_2O is the weight percent in the ash prepared in accordance with ASTM D-271. For an index less than 0.2, fouling potential is low; 0.2 to 0.5, medium; 0.5 to 1.0 high; above 1.0, severe.

For *lignitic ash*, Na_2O is the determinant. Fouling tendency is low to medium for less than 3 percent, high for 3 to 6 percent, and severe for over 6 percent.

Additives such as dolomite, lime and magnesia are effective in reducing the sintered strength of ash (Fig. 9.2.4). Dolomite is also effective in

neutralizing the acid in the flue gas and eliminating condensation and subsequent plugging in the cold end of air heaters.

The ash content of residual fuel oil seldom exceeds 0.2 percent but this relatively small amount is capable of causing severe problems of deposits on tubes and corrosion. To predict the effect of oil ash on slagging

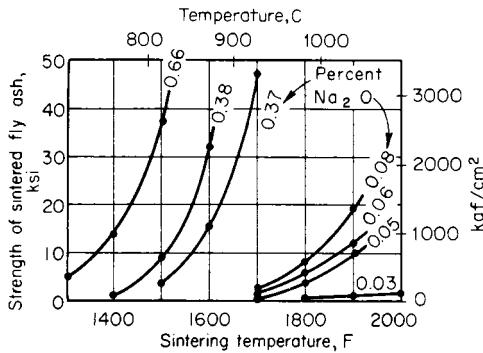

Fig. 9.2.3 Effect of sodium oxide content of coal on the sintered strength of fly ash.

and tube bank fouling, several variables are considered, including (1) ash content, (2) ash analysis, (3) melting and freezing temperatures of the ash, and (4) the total sulfur content. When oil is burned, complex chemical reactions occur, resulting in the formation of various oxides,

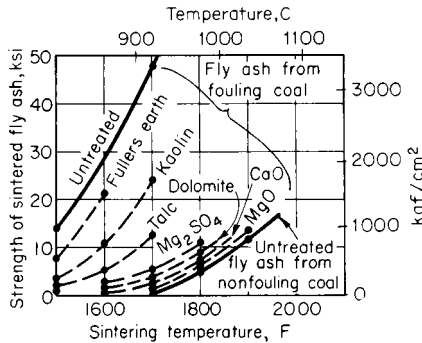

Fig. 9.2.4 Effect of additives on the sintered strength of fly ash (1 part additive to 4 parts fly ash).

Table 9.2.1 Analyses of Ash from Heavy Fuel Oil

	Analysis, %		
	Troublefree fuel oil	Troublesome fuel oils	
Ferric oxide, Fe ₂ O ₃	56	8	6
Silica, SiO ₂	25	9	5
Alumina, Al ₂ O ₃	6	4	1
Lime, CaO	3	10	1
Magnesia, MgO	9	3	2
Vandium pentoxide, V ₂ O ₅		1	39
Alkali sulfates	1	65	46
	Melting point in air		
Constituent	°F	°C	
V ₂ O ₅	1,274	690	
Na ₂ SO ₄	1,625	885	
MgSO ₄	2,165	1,185	
CaSO ₄	2,640	1,449	
Fe ₂ O ₃	2,850	1,566	

vanadates, and sulfates. Many of these have melting points between 480 and 1,250°F (249 and 677°C), falling within the range of tube metal temperatures in the furnaces and superheaters of oil-fired boilers. As indicated in the analyses of Table 9.2.1, some oil ashes with high alkali sulfates can be troublesome. Dolomite added in quantities equal to the weight of the ash can be used to produce a softer slag which can be removed easily by soot blowing. In some installations air heater corrosion and pluggage and acid stack discharge are also minimized by dolomite additives.

SOOT BLOWER SYSTEMS

While slagging and fouling of coal- and oil-fired boilers can be minimized by proper design and operation, auxiliary equipment for cleaning furnace walls and removing deposits from convection surfaces must be supplied to maintain capacity and efficiency. Steam or air jets from the soot blower nozzles dislodge the dry or sintered ash and slag, which then fall into hoppers or travel along with the gaseous products of combustion to the removal equipment.

Types of soot blowers vary with their location in the boiler unit, the severity of ash or slag conditions, and the arrangement of the heat-absorbing surfaces.

Furnace walls are generally cleaned with wall blowers (Fig. 9.2.5) which project a nozzle assembly into the furnace for blowing and then retract it behind the wall tubes for protection after operation.

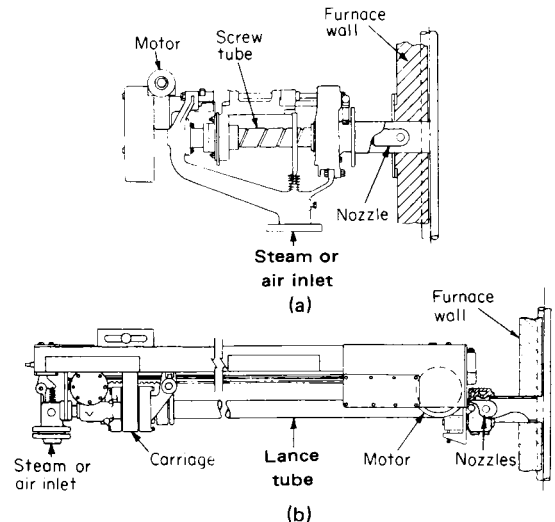

Fig. 9.2.5 Retracting soot blowers. (a) Furnace wall blower; (b) long-lance blower.

Tube banks in high-gas-temperature zones, such as slag screens, superheaters, and reheaters, where slag or sintered ash may accumulate, are generally cleaned by long-lance retracting-type blowers (Fig. 9.2.5). The lance, which rotates or oscillates as it advances into the boiler, is fitted with large nozzles to supply a powerful cleaning action and is retracted from the boiler for protection when it is not operating.

Tube banks located in low-gas temperature zones, including the economizer and boiler sections, where uncooled metals have satisfactory life and ash removal is easier, usually can be cleaned by multiple-nozzle rotating-type soot blowers (Fig. 9.2.6). However, long-lance retracting-type blowers may be necessary for very wide boilers, for extended cleaning ranges, or where the ash tends to pack or cake.

Soot blowers for air heaters generally are arranged to blow through the plate or tube assemblies with single- or multiple-nozzle elements moving in an arc or straight-line motion. These blowers may also supply water for washing the air-heater surface.

Additives to soften oil slag for easier removal by soot blowers may be

introduced as a slurry spray through long-lance retractable blowers or through separate spraying equipment.

Automatic controls for soot blower systems often are used and can be arranged to operate the blowers in a prescribed sequence at time intervals adjusted to blower-cleaning requirements or to receive signals from the blower unit's instruments and controls so as to operate the soot blowers selectively in the various heat-absorbing sections in order to maintain the required cleanliness and heat absorption.

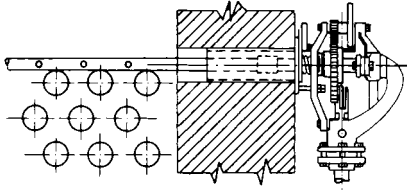

Fig. 9.2.6 Rotating soot blower with multiple nozzles.

ASH AND SLAG REMOVAL

Dust collectors (see also Sec. 18) are required for all large coal-burning blower units in order to reduce atmospheric pollution. The amount of ash entrained in the flue gas varies from about 80 percent of the ash in the coal for dry-ash pulverized-coal firing to approximately 50 percent for slag-tap pulverized-coal firing, and from 20 to 30 percent for cyclone-furnace firing. **Mechanical separators** and **electrostatic dust collectors** (Fig. 9.2.7) may be used in series, but most pulverized-coal-fired units use only electrostatic collectors. The fly ash from spreader-stoker-fired units is coarse, and consequently, mechanical separators generally are used. Although the gas-dust loading is low in cyclone-furnace boilers, electrostatic dust collectors are usually required to meet the restrictions on air pollution.

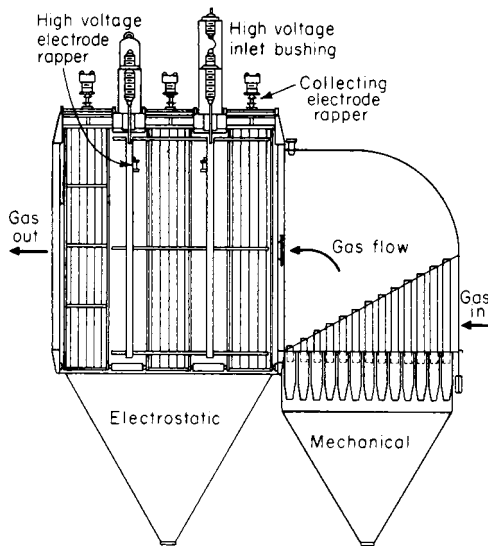

Fig. 9.2.7 Mechanical and electrostatic dust collectors in series.

The **bottom ash** recovered from the ashpits of chain-grate and spreader-type stokers is usually sold for cement-block aggregate. **Slag** from slag-tap furnaces can be used as a black granular coating for asbestos roofing shingles, as a mixture containing slag, fly ash, lime, and water for Poz-o-pac roads, or as an antiskid material for icy roads.

Fly ash presents disposal problems because of its low density and the consequent large volume which must be handled. It is not suitable for fill materials unless quickly covered. However, it can be utilized as an

admixture, replacing 20 to 30 percent of portland cement, and as a lightweight aggregate after sintering.

STOKERS

Almost any coal can be burned successfully on some type of stoker. In addition, waste materials and by-products such as coke breeze, wood waste, bark, agricultural residues such as bagasse, and municipal wastes can be burned either as a base or auxiliary fuel.

The grate area required for a given stoker type and capacity is determined by the maximum allowable burning rate per square foot, established by experience. The practical limit to steam output for stoker-fired boilers is about 400,000 lb (181,600 kg) per hour.

Chain- and **traveling-grate stokers** have been extensively used to burn noncoking coals, but only a few installations have been made in recent years because of their slow response to load changes, possible loss of ignition on swinging loads, high ashpit heat losses, high excess-air requirements, and limitations on size.

Spreader stokers with continuous-ash-discharge traveling grates (Fig. 9.2.8), intermittent-cleaning dump grates, or reciprocating continuous-cleaning grates are capable of burning all types of bituminous and lignitic coals. The fines are burned in suspension, and the larger fuel particles are burned on the grate. The use of a thin, fast-burning fuel bed provides rapid response to variations in load. Rotating mechanical feeding and distributing devices are generally used with spreader stokers. These stokers operate with low excess air and high efficiencies when the carbon in the fly ash is reinjected above the grate. However, relatively low gas velocities through the boiler are necessary to prevent fly-ash erosion, and fly-ash collectors should be used to reduce air pollution.

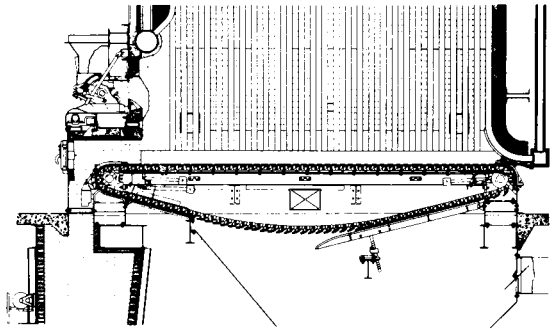

Fig. 9.2.8 Spreader stoker with traveling grate.

Single- or double-retort **underfeed stokers** with side ash dump and multiple-retort underfeed stokers with rear ash discharge are well suited for the burning of coking coals. These stokers operate best at steady loads. Both the ashpit heat loss and the maintenance are high.

PULVERIZERS

Pulverized coal firing is rarely used for boilers of less than 100,000 lb (45 t*) per hour steaming capacity since the use of stokers is more economical for those capacities. Most installations use the direct-fired system in which the coal and air pass directly from the pulverizers to the burners, and the desired firing rate is regulated by the rate of pulverization. Some types of direct-fired pulverizers are capable of grinding as much as 100 tons (91 t) per hour (Fig. 9.2.9). **Primary air** enters the pulverizer at temperatures that may run 650°F (343°C) or higher, depending on the amount of moisture in the coal and the type of pulverizer. The pulverizer provides the active mixing necessary for drying. The percentage of volatile matter in the fuel has a direct bearing on the

* 1 metric ton (t) = 1,000 kg = 2,205 lb.

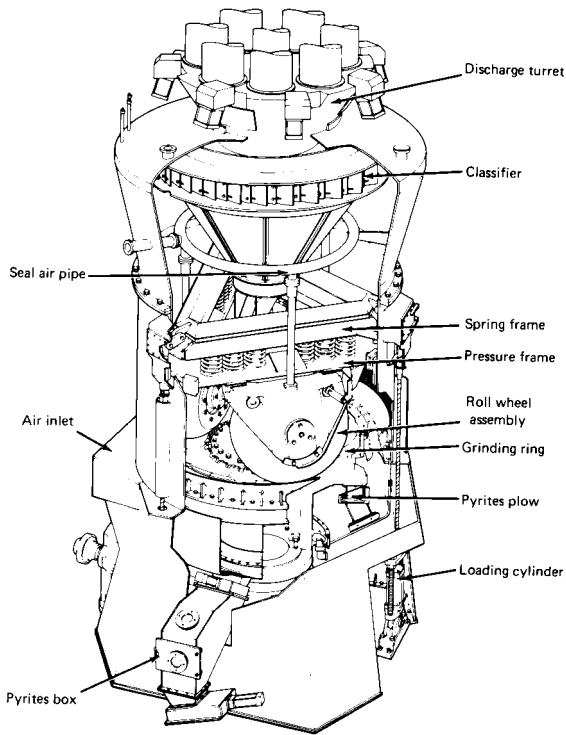

Fig. 9.2.9 Slow-speed pulverizer, roll-and-race type.

recommended primary-air-fuel temperature for combustion. The generally accepted safe values for pulverizer exit fuel-air temperatures are:

Fuel	Exit temperature	
	°F	°C
Lignite	120–140	49–60
High-volatile bituminous	150	66
Low-volatile bituminous	150–175	66–79
Anthracite	175–212	79–100

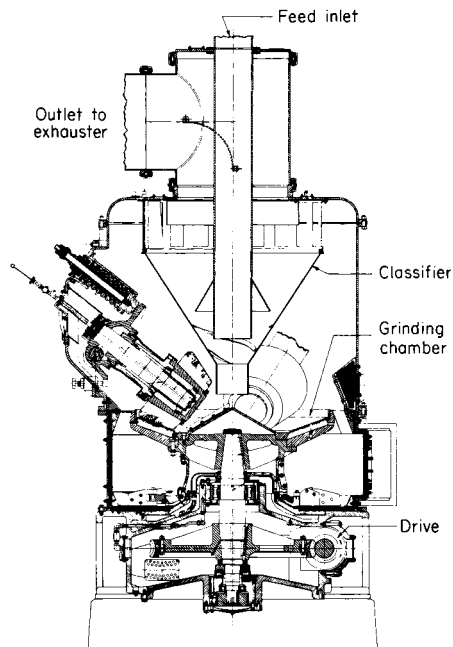

Fig. 9.2.11 Medium-speed pulverizer, roller type.

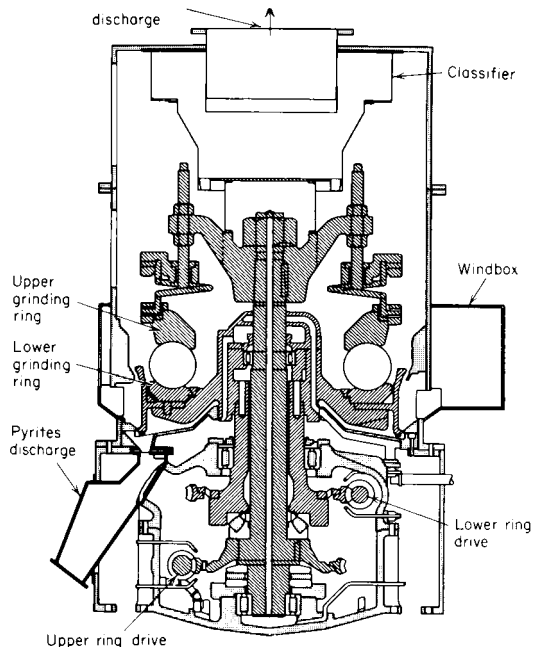

Fig. 9.2.10 Medium-speed pulverizer, contrarotation ball-and-race type.

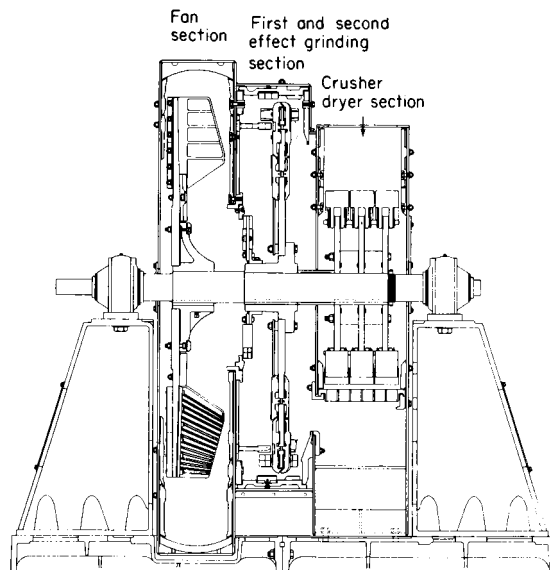

Fig. 9.2.12 High-speed pulverizer, attrition type.

The three principal types of pulverizers may be classified as *slow speed* (below 75 r/min), *medium speed* (75–225 r/min), and *high speed* (above 225 r/min). Figure 9.2.9 shows a slow-speed pulverizer using the roll-and-race principle. Medium-speed pulverizers are generally of either the ball-and-race type (Fig. 9.2.10) or the bowl-and-roller type (Fig. 9.2.11). High-speed pulverizers are usually of the attrition type (Fig. 9.2.12).

When a variety of coal is to be used, the pulverizer should be sized for the coal that gives the highest **base capacity**, which is the desired capacity divided by the **capacity factor**, a function of the **grindability** of the coal and the **fineness** required (Fig. 9.2.13). Capacities are established by testing with coals of different grindability. The required fineness of pulverization varies with the type of coal and with the size and kind of furnace. It usually ranges from 65 to 80 percent through a 200-mesh screen. [The U.S. Standard sieve 200-mesh screen has 200 openings per linear inch, resulting in a nominal aperture of 0.0029 in (0.074 mm).] The ASTM equivalent is 74 μm .

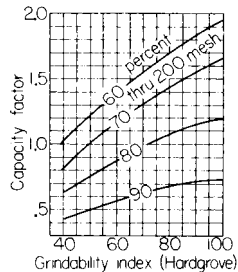

Fig. 9.2.13 Pulverizer capacity factors for varying fineness and grindability; medium-speed, ball-and-race type of pulverizers.

BURNERS

The primary purpose of a fuel burner is to mix and direct the flow of fuel and air so as to ensure rapid ignition and complete combustion. In pulverized-coal burners, a part (15 to 25 percent) of the air, called **primary air**, is initially mixed with the fuel to obtain rapid ignition and to act as a conveyor for the fuel. The remaining portion, or **secondary air**, is introduced through registers in the windbox (Fig. 9.2.14). This circular-

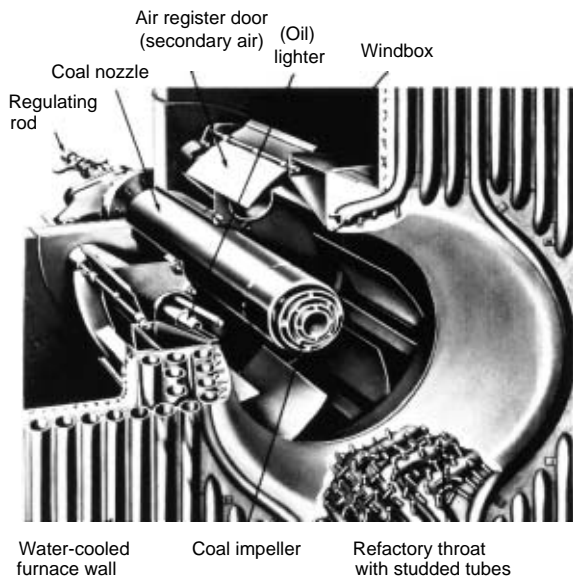

Fig. 9.2.14 Circular burner for pulverized coal, oil, or gas.

type burner is designed to fire coal and can be equipped to fire any combination of the three principal fuels if proper precautions are taken to prevent coke formation on the coal element when oil and coal are being burned. This design has a capacity up to 165 million Btu/h (41,600 kcal/h) for coal and higher for oil or gas.

Oil, when fired, can be atomized by the fuel pressure or by a compressed gas, usually steam or air. Atomizers utilizing fuel pressure generally are of the **uniflow or return-flow mechanical types**. The uniflow type uses an oil pressure of 300 to 600 lb/in² (21 to 42 kgf/cm²) at the maximum flow rate and is limited to an operating range of about 2 to 1. If a load range greater than 2 to 1 is required, the return-flow type of atomizer is used. This type of atomizer uses oil pressures up to 1,000 lb/in² (70 kgf/cm²) and provides an operating range of as much as 10 to 1 under favorable conditions. Steam- and air-type atomizers also provide an operating range of approximately 10 to 1, but with a relatively low oil pressure (300 lb/in²; 21 kgf/cm²). The steam consumption required for good atomization usually is less than 1 percent of the boiler's steam output.

Natural gas and some process gases [provided they are sufficiently clean and have a calorific heating value of more than 500 Btu/ft³ (4.45 kcal/m³)] can be burned by admission through a perforated ring, through radial spuds or through a centrally located center-fire-type fuel element. The center-fire fuel element can be removed for cleaning; consequently, restrictions on gas cleanliness are less severe for this type burner.

The circular pulverized-coal burner (Fig. 9.2.14) uses two or three

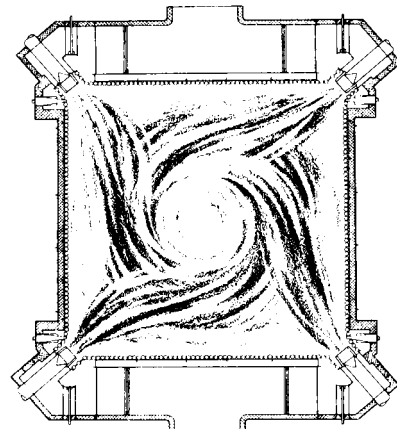

Fig. 9.2.15 Corner fired tangential tilting burners for pulverized coal, oil, or gas. (a) Plan section; (b) burners tilted down; (c) burners tilted up.

fuel nozzles and provides the excellent ignition characteristics of the circular burner. Gas, when fired in these burners, is introduced through fixed-spud-type elements located in the burner throat, and return-flow or steam- or compressed-air-type atomizers are used for firing oil.

When corner-fired burners (Fig. 9.2.15) are used, the mixing of fuel and combustion air takes place in the furnace (Fig. 9.2.15a). Oil and gas also can be fired in these burners by inserting fuel elements in the corner ports adjacent to the pulverized-coal nozzles. The burner tips can be tilted, as shown in Fig. 9.2.15b and c, to control the steam temperature.

A properly designed pulverized-coal installation should operate satisfactorily over a range of 2 or 3 to 1 without the need of auxiliary fuel to maintain ignition and without increasing or decreasing the number of burners in service. If some of the pulverizers and burners on large units are taken out of service as the load decreases, it is possible to operate at ratings down to one-sixth of full-load steam flow without the use of auxiliary fuel.

Blast-furnace and coke-oven gas burners are usually of the circular type, in which the gas is introduced either through a centrally positioned nozzle or through an annular port surrounding the coal nozzle, or of the intertube type, where the fuel and air ports are alternated across the width of the burner.

CYCLONE FURNACES

The cyclone furnace is designed to burn low-ash fusion coals and to retain most of the coal ash in the slag, which is then tapped from the furnace, thus preventing the passage of the ash through the heat-absorbing surfaces. The coal, crushed to 4-mesh size, is admitted with primary air in a tangential manner to the primary burner (Fig. 9.2.16). The finer particles burn in suspension while the coarser particles are thrown by centrifugal force to the outer wall of the cyclone furnace. The wall surface with its sticky coating of molten slag retains most of the particles of coal until they burn and leave their molten ash on the wall. The molten ash drains into the boiler furnace and then, through an opening in the boiler furnace floor, into the slag-collecting tank.

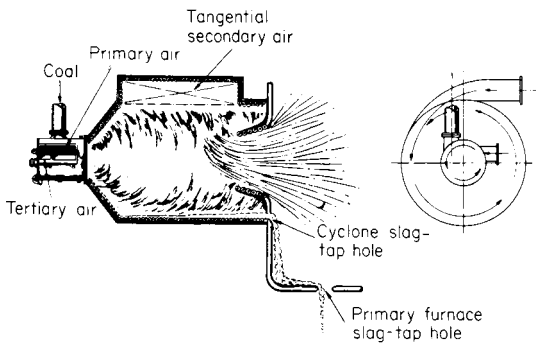

Fig. 9.2.16 Cyclone furnace.

The secondary air, which is admitted tangentially at the top of the cyclone, vigorously scrubs the coal particles on the wall, and combustion is completed at a firing rate of about 1/2 million Btu/(ft³ · h) [4,450 kcal/(m³ · h)]. The primary-furnace walls (consisting of fully studded tubes) also are wetted with molten ash and help to catch ash particles that are not retained in the cyclone furnaces. Gas, when available, can be burned by injection through openings at the bottom of the secondary-air ports. Oil is burned by spraying it axially into the cyclone through the primary burner or by firing it tangentially through an oil element located in the secondary-air port.

Figure 9.2.24 shows a boiler fired with twenty-three 10-ft-diam cyclone furnaces.

UNBURNED COMBUSTIBLE LOSS

The unburned combustible loss in the fly ash from pulverized-coal firing varies with the furnace-heat liberation, type of furnace cooling, use

of slag-tap or dry-ash removal, volatility and fineness of the coal, excess air, and type of burner (see Fig. 9.2.17). There is practically no combustible in the fluid slag from slag-tap furnaces. Although the hopper refuse from dry-ash furnaces usually is low in combustible, the combustible may be appreciable in some cases. The fly ash from cyclone-furnace boilers has a very low combustible content, varying from an equivalent 0.03 percent efficiency loss when burning Illinois coal to 0.15 percent for Ohio coal.

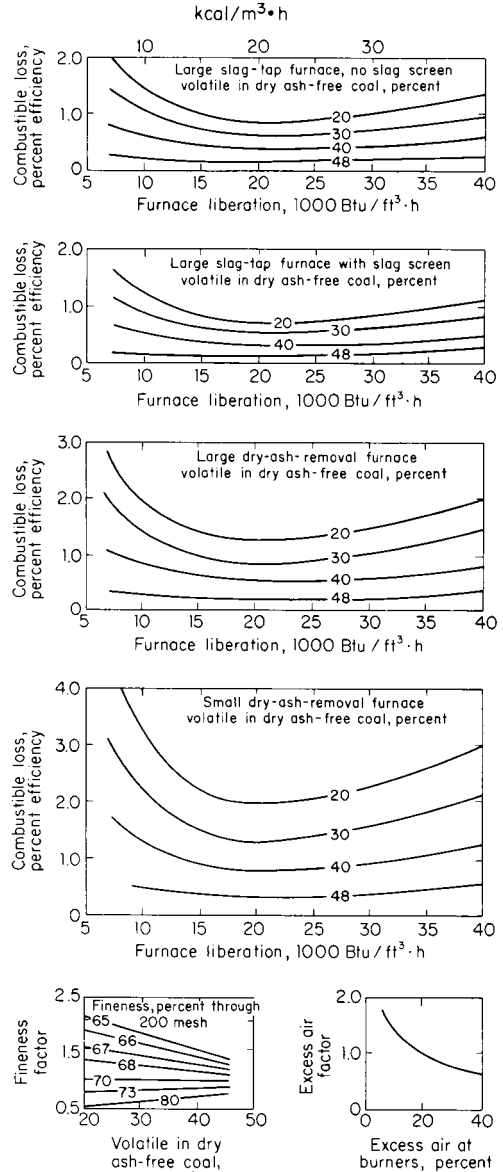

Fig. 9.2.17 Principal factors affecting combustibility loss for pulverized coal firing in various types of furnaces.

Fly-ash combustible from spreader stokers varies widely with the rating, size, and type of coal burned. The combustible carryover at high rates of firing is relatively large, but reinjection of the fly ash is common and the loss in efficiency can be reduced as shown in Fig. 9.2.18.

The combustibility loss in the fly ash from solid fuels is determined by

withdrawing a representative sample of fly ash and flue gas from the boiler outlet flue, or stack, at the same velocity in the sampling tip as the gas velocity in the flue (see ASME Test Code). The rates of flue-gas flow and fly-ash collection are measured, and the dust loading in pounds per 1,000 lb of flue gas is then calculated. The combustible in fly ash also can be measured. The data in Fig. 9.2.19 can be used for rapid determination of efficiency loss when the dust loading and amount of combustible are known.

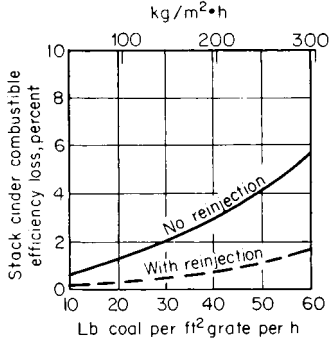

Fig. 9.2.18 Combustible efficiency loss, spreader stoker.

BOILER TYPES

The greater safety of **water-tube boilers** was recognized more than 100 years ago, and water-tube boilers have generally superseded the fire-tube type except in special cases such as small package-boiler designs and waste-heat boiler designs for medium- and low-pressure applications.

Water-tube boilers are available in a wide range of capacities—from as low as 5,000 lb (2.3 t) to as high as 9,000,000 lb (4,082 t) of steam per hour. By coordinating the various components—boilers, furnaces, fuel burners, fans, and controls—boiler manufacturers have produced a broad series of standardized and economical steam generating units, with capacities up to 550,000 lb (249 t) of steam per hour, burning oil or natural gas. For capacities up to 200,000 lb (90.7 t) per hour most units can be shipped by rail or truck as a completely shop-assembled package (Fig. 9.2.20). For larger units, barges or selected ocean vessels may be used if the site is suitably located. Beyond the limits for shop assembly, greatest economy is obtained by using modularized sections and shipping large assembled components. The two-drum-type boiler shown in Fig. 9.2.21, which comes in capacities up to 1,200,000 lb (544 t) per hour, is one example of modularized design.

Boilers utilizing banks of tubes directly connected to the steam and water drums are, in general, limited to a maximum steam pressure of 1,650 lb/in² (116 kgf/cm²), since the wide tube spacing required to maintain high drum-ligament efficiency reduces the effectiveness of heat absorption.

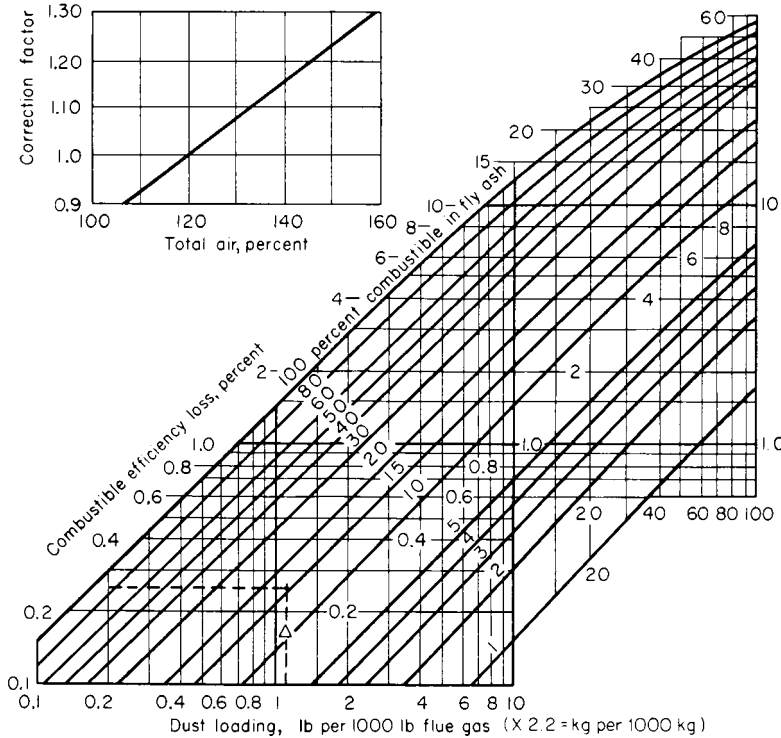

Fig. 9.2.19 Chart for determining combustible efficiency loss in fly ash. Heat loss in percent from combustible in fly ash is

$$\left[\frac{DL(C/100)(14,600)}{10,000,000/[7.6(TA/100) + 0.9] + [DL(C/100)(14,600)]} \right] \times 100$$

where DL = dust loading, lb/1,000 lb flue gas (× 2.2 = kg/1,000 kg); C = combustible in fly ash, percent; TA = total air, percent.

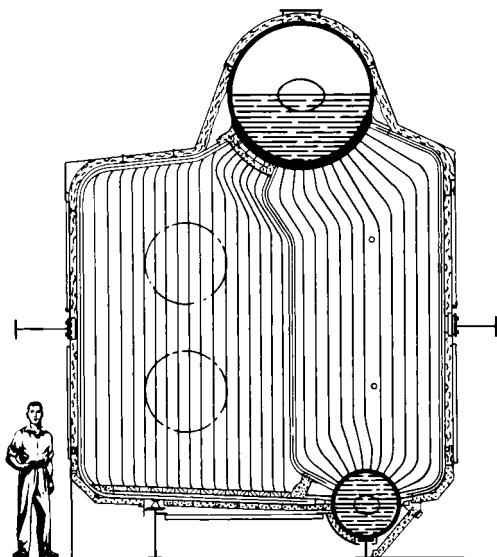

Fig. 9.2.20 Water-tube package boiler, single-pass gas.

Many designs of high-pressure, high-temperature, utility-type boilers, ranging from capacities of 500,000 to 9,000,000 lb (230 to 4,100 t) of steam per hour, are used, but they can generally be classed as radiant-type boilers. In radiant boilers, little or no steam is generated by convection-heat-absorbing surfaces since virtually all the steam is generated in the tubes forming the furnace enclosure walls from heat radiated to these tubes from the hot combustion gases. Figure 9.2.22 illustrates a large oil- and/or gas-fired natural-circulation type radiant-boiler unit,

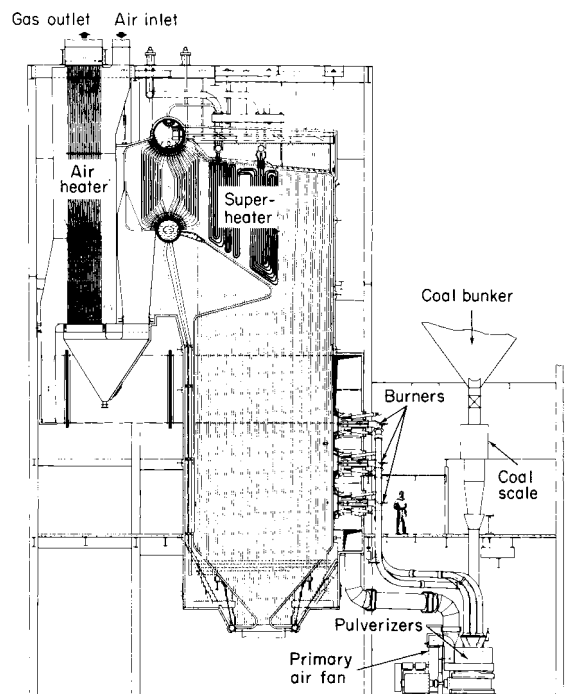

Fig. 9.2.21 Two-drum type of boiler designed for pulverized-coal firing.

and Fig. 9.2.23 shows a tangentially pulverized coal-fired, supercritical-pressure, combined-circulation type of boiler. The cyclone furnace forced-flow, once-through unit shown in Fig. 9.2.24 is known as a universal pressure boiler, since it can be designed for operation at pressures either above or below the critical pressure (3,206 lb/in²; 225 kgf/cm²).

Drum-type natural or assisted-circulation boilers are restricted to a maximum pressure of about 2,600 lb/in² (183 kgf/cm²) at the superheater outlet because of circulation and steam separation characteristics. However, once-through forced-flow-type boilers are not restricted to any pressure plateau by circulation limits.

In once-through forced-flow boilers, the water generally flows from the economizer to the furnace-wall tubes, then to the gas-convection-pass enclosure tubes and the primary superheater. Usually, the transition to the vapor phase (if operation is below the critical pressure) begins in the furnace circuits and, depending upon the operating conditions and the design, is completed either in the gas-convection-pass enclosure or in the primary superheater. The steam from the primary superheater passes to the secondary (and possibly to a tertiary) superheater. One or more reheaters are provided to reheat the low-pressure steam.

In addition to boilers for the conversion of energy in conventional fuels (coal, oil, and gas) to steam for power, heating or process use, many boilers have been developed for special requirements.

Waste-heat and exhaust-gas boilers utilize the sensible heat in the gas to generate steam. In the recovery of heat from the gas, water-tube boilers, often in conjunction with superheaters and economizers, are generally used; but fire-tube boilers may be used for cooling process or other gases when the containment of pressurized gas is a factor and the steam requirements are small.

High-temperature-water boilers provide hot water, under pressure, for space heating of large areas. Water is circulated at pressures up to 450 lb/in² (31.6 kgf/cm²) through the generator and the heating system. The water leaves the generator at subsaturated temperatures ranging up to 400°F (200°C). The boilers usually incorporate a water-cooled furnace and convection-gas-pass enclosure, with the convection-heat-absorbing surface arranged in sections similar to those of an economizer. Sizes generally range up to 60 million Btu/h (15,120 kcal/h) for package units, and field-erected units can be designed for much higher capacities.

The exhaust CO gas from oil refinery fluid catalytic-cracking units is used as the fuel for carbon monoxide boilers. Generally, a cylindrical furnace is used to contain the pressurized gas and the CO burners are arranged tangentially to increase the residence time of the gas in the furnace. The furnace walls are water cooled and tubes are refractory covered to promote ignition. Conventional-type gas and/or burners are provided for startup, for continuous pilots, and for the generation of steam when the cracker is out of service.

Recovery-type boilers are designed specifically for the recovery of chemicals in the spent cooking liquors from kraft, sulfite, soda, and other papermaking processes. The liquor is fired in a water-cooled furnace, either in suspension or in a smelt bed on the furnace floor. The chemicals, depending upon the process, are recovered from the smelt or the flue gas in a form which permits economical conversion for reuse.

FURNACES

A furnace is an enclosure provided for the combustion of fuel. The enclosure confines the products of combustion and is capable of withstanding the high temperatures developed and the pressures used. Its dimension and geometry are adapted to the rate of heat release, the type of fuel, and the method of firing so as to promote complete burning of combustible and provide suitable disposal of the ash.

Water-cooled furnaces are used with most boiler units and for all types of fuel and methods of firing. Water cooling of the furnace walls reduces the transfer of heat to the structural members and, consequently, their temperature can be limited to that which will meet the requirements of strength and resistance to oxidation. Water-cooled tube con-

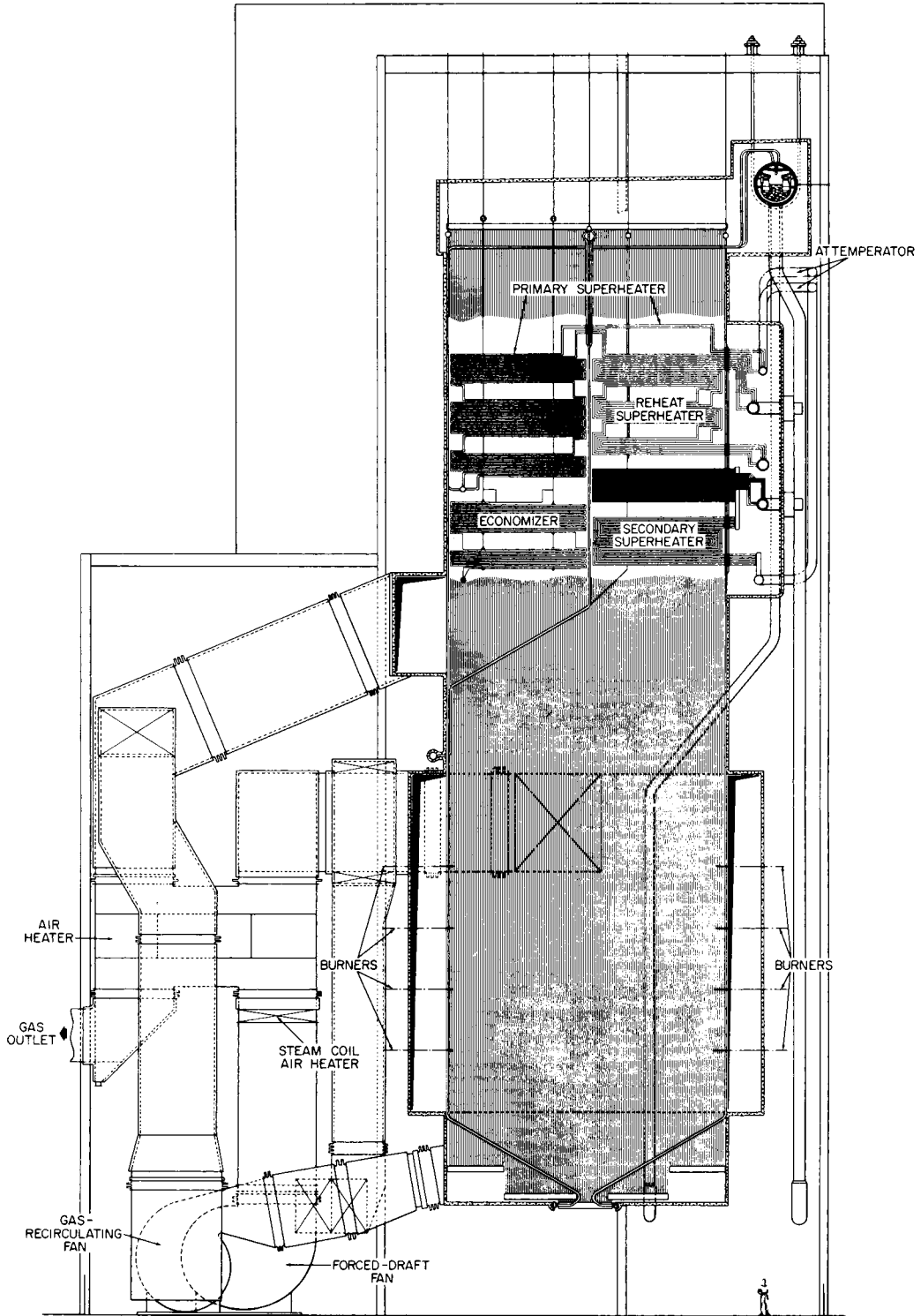

Fig. 9.2.22 Natural circulation radiant boiler, oil- and gas-fired; 4,200,000 lb (1,900 t) steam per hour; 2,600 lb/in² (183 kgf/cm²) pressure; 1,005°F (540°C) steam temperature; 1,005°F (540°C) reheat steam temperature.

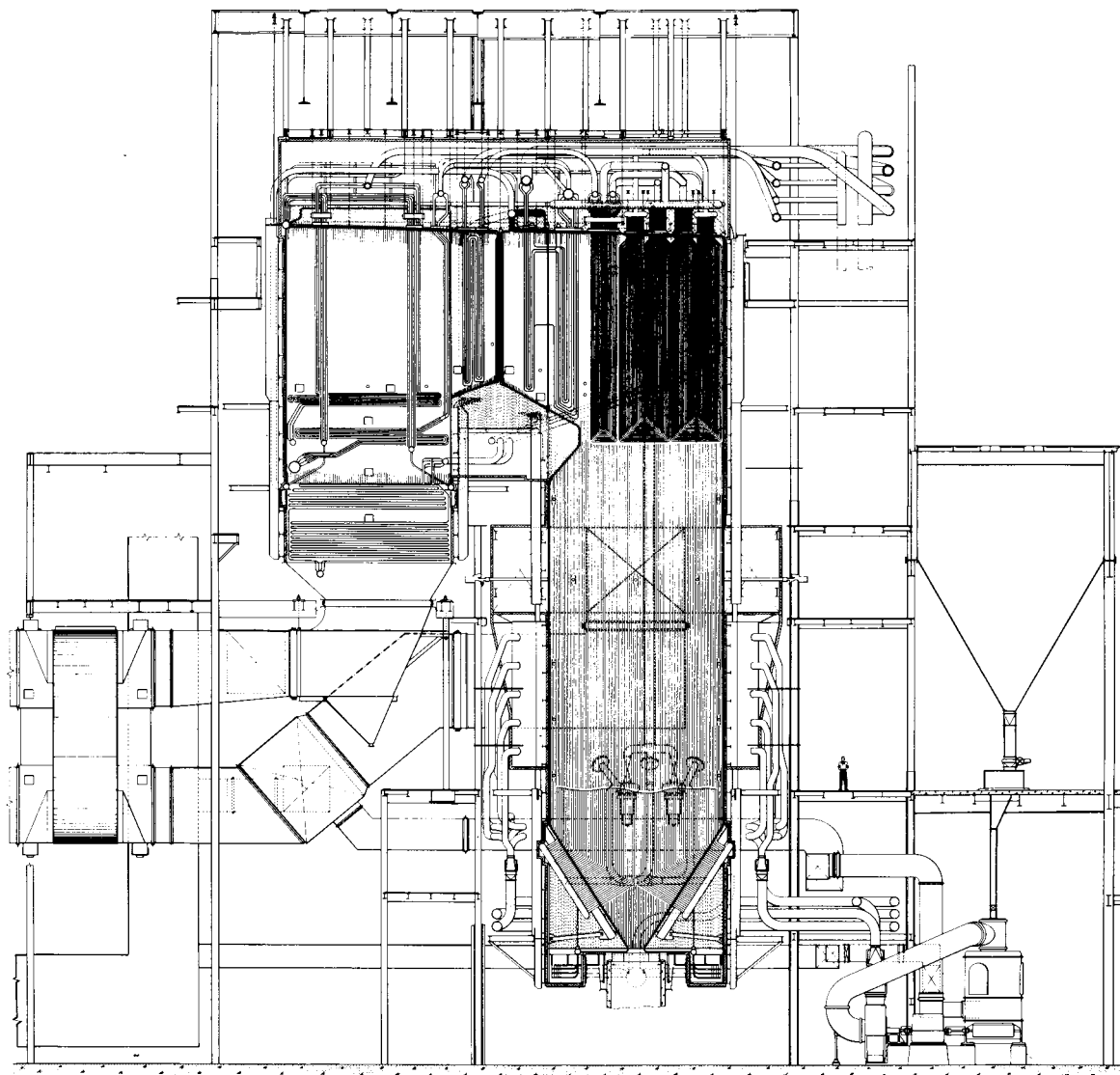

Fig. 9.2.23 Once-through boiler with combined circulation; twin pressurized furnaces; pulverized coal tangentially fired; 6,400,000 lb (2,900 t) steam per hour; 3,650 lb/in² (257 kgf/cm²) pressure; 1,003°F (539°C) steam temperature; 1,003°F (539°C) reheat steam temperature.

structions facilitate large furnace dimensions and optimum arrangements of roofs, hoppers, arches, and mountings for burners; and the use of tubular screens, platens, or division walls to increase the amount of heat-absorbing surface in the combustion zone. The use of water-cooled furnaces reduces the external heat losses; these losses for conventional-type furnaces are shown in Fig. 9.2.37.

Heat-absorbing surfaces in the furnace receive heat from the products of combustion and, consequently, contribute directly to steam generation while lowering the furnace exit-gas temperature. The principal mechanisms of heat transfer take place simultaneously. These include intersolid radiation from the fuel bed or fuel particles, nonluminous radiation from the products of combustion, convection heat transfer from the furnace gases, and heat conduction through deposits and tube metals. (See also Sec. 4.) The absorption effectiveness of the furnace surfaces is influenced by the deposits of ash or slag.

Furnaces vary in shape and size, in the location and spacing of burners, in the disposition of heat-absorbing surface, and in the arrangement of arches and hoppers. Flame shape and length affect the geometry of radiation and the rate and distribution of heat absorption by the water-cooled surfaces.

Analytical solutions of the transfer of heat in the furnaces of steam-generating units are extremely complex, and it is most difficult to calculate furnace outlet-gas temperature by theoretical methods. Nevertheless, the furnace outlet-gas temperature must be accurately predicted, since this temperature determines the design of the remainder of the boiler unit, particularly that of the superheater and reheater. The calculations must therefore be based upon test results supplemented by data accumulated from operating experience and by judgments predicated upon knowledge of the principles of heat transfer and the characteristics of fuels and slags.

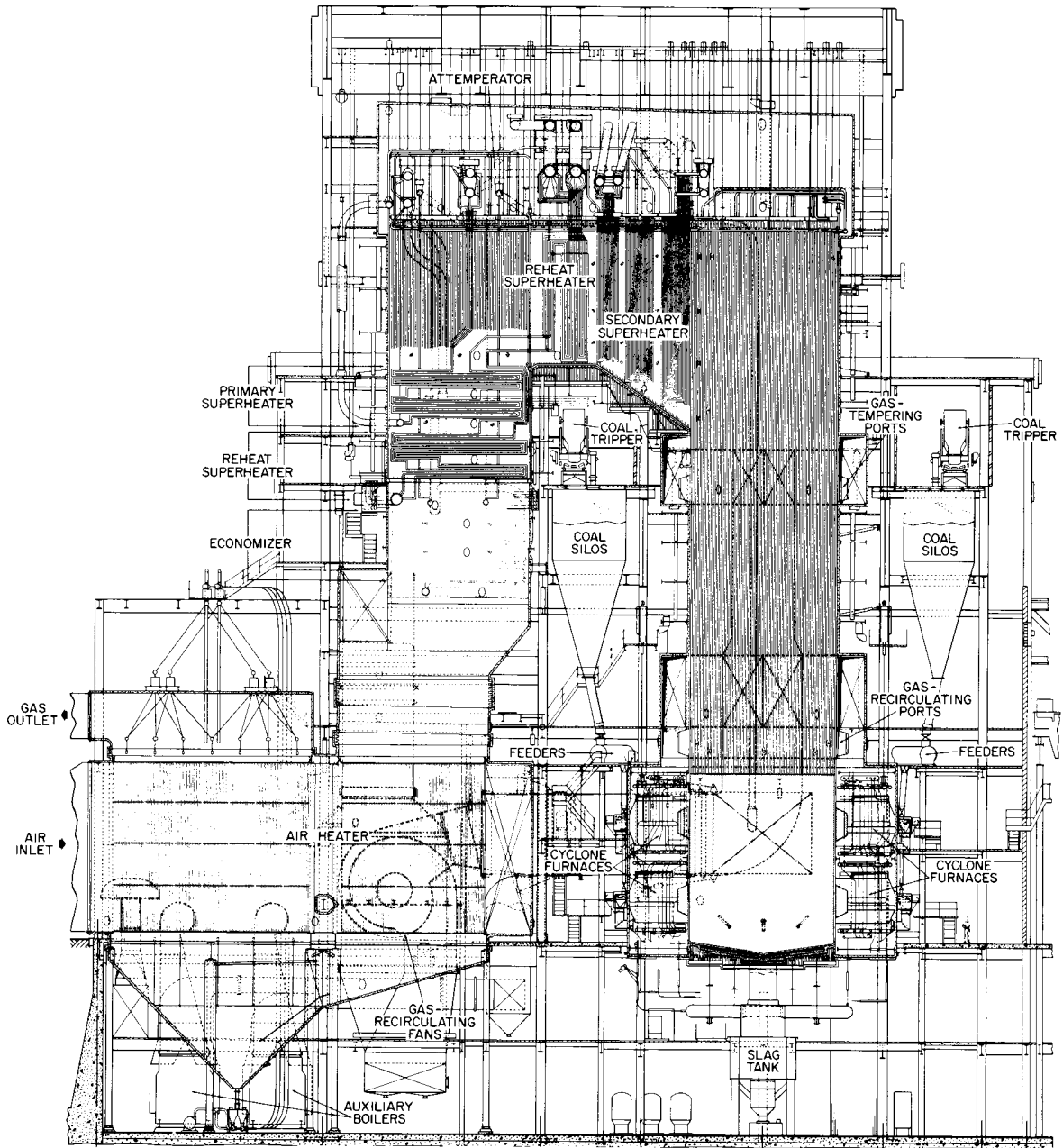

Fig. 9.2.24 Universal Pressure boiler; pressurized cyclone furnace, coal-fired; 8,000,000 lb (3,640 t) steam per hour; 3,650 lb/in² (257 kgf/cm²) pressure; 1,003°F (539°C) steam temperature; 1,003°F (539°C) reheat steam temperature.

The curves in Figs. 9.2.25 and 9.2.26 show the gas temperatures at the furnace outlet of typical boiler units when firing coal, oil, and gas. The furnace exit-gas temperatures vary considerably with coal firing because of the insulating effect of ash and slag deposits on the heat-absorbing surfaces. The amount of surface is the major factor in overall furnace heat absorption, and the heat released and available for absorption per hour per square foot of effective heat-absorbing surface is

therefore a satisfactory basis for correlation. The heat released and available for absorption is the sum of the calorific heat content of the fuel fired and the sensible heat of the combustion air, less the sum of the heat unavailable owing to the unburned portion of the fuel and latent heat of the water vapor formed from moisture in the fuel and the combustion of hydrogen.

Furnace-wall tubes often are pitched on close centers to obtain maxi-

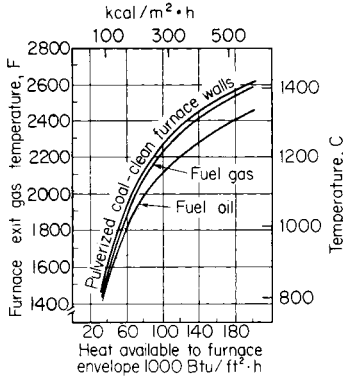

Fig. 9.2.25 Approximate gas temperatures at water-cooled furnace outlet with different fuels.

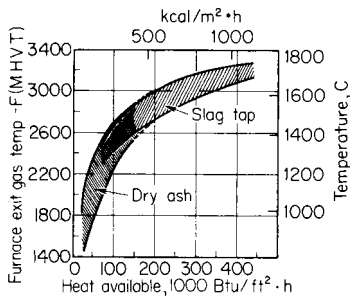

Fig. 9.2.26 General range of furnace exit gas temperatures, pulverized-coal firing. (MHVT = multiple-shield, high-velocity thermocouple.)

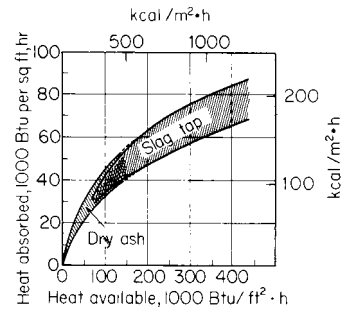

Fig. 9.2.28 General range of average heat absorption rate in water-cooled pulverized-coal-fired furnaces.

Furnace walls must be adequately supported with provision for thermal expansion and with reinforcing buckstays to withstand the lateral forces caused by the difference between the furnace pressure and the surrounding atmosphere. The furnace enclosure must prevent air infiltration when the furnace is operated under suction and gas leakage when the furnace is operated at pressures above atmospheric.

SUPERHEATERS AND REHEATERS

The addition of heat to steam after evaporation, or change of state, is accompanied by an increase in the temperature and the enthalpy of the fluid. The heat is added to the steam in boiler components called superheaters and reheaters, which are comprised of tubular elements exposed to the high-temperature gaseous products of combustion.

The advantages of superheat and reheat in power generation result from thermodynamic gain in the Rankine cycle (see Sec. 4) and from the reduction of heat losses due to moisture in the low-pressure stages of the turbine. With high steam pressures and temperatures, more useful energy is available, but the advances to high steam temperature often are restricted by the strength and the oxidation resistance of the steel and the ferrous alloys currently available and economically practical for use in boiler pressure-part and turbine-blade constructions.

The term superheating is applied to the higher-pressure steam and the term reheating to the lower-pressure steam which has given up some of its energy during expansion in the high-pressure turbine. With high initial steam pressure, one or more stages of reheating may be employed to improve the thermal efficiency.

Separately fired superheaters may be used, but superheaters usually are installed as an integral part of the steam-generating unit and broadly classified as **radiant** or **convection** types, depending upon the predominant method of heat transfer to the heat-absorbing surfaces.

The quantity of heat absorbed and the amount of superheat attained

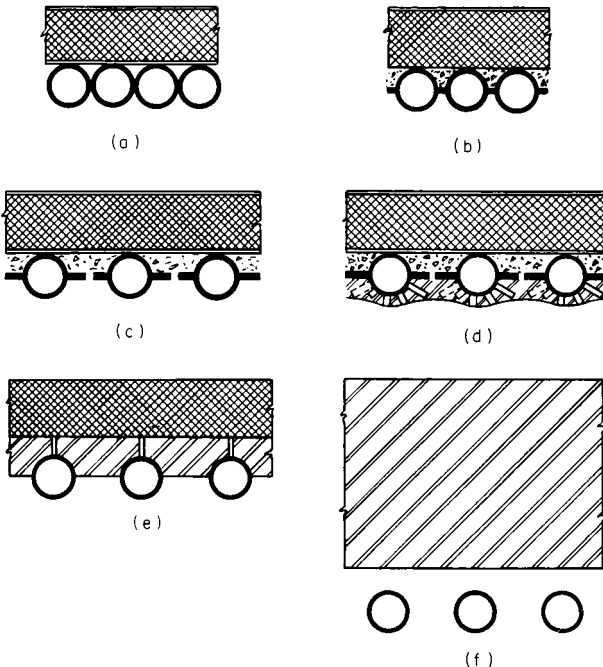

Fig. 9.2.27 Water-cooled furnace wall construction types. (a) Tangent tube wall; (b) welded membrane tube wall; (c) flat studs welded to sides of tubes; (d) full stud tube wall, refractory-covered; (e) tube and tile wall; (f) tubes spaced from refractory wall.

are dependent upon the size, location, and arrangement of the heat-absorbing surfaces; the temperature differentials between the gas, the tube metal, and the steam; and the heat-transfer coefficients. Steam-temperature characteristics of radiant- and convection-type superheaters are shown in Fig. 9.2.29, as well as the effect of using a combination of these types to produce a more uniform steam temperature over a wide operating range.

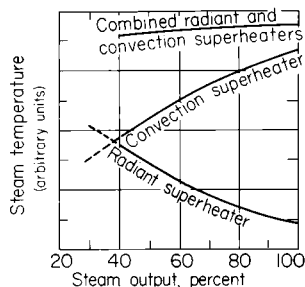

Fig. 9.2.29 Comparative radiant and convection superheater characteristics.

Superheaters of the predominantly **radiant type** usually are arranged for direct exposure to the furnace gases and, in some designs, form a part of the furnace enclosure. In other designs, the surface is arranged in the form of tubular loops or platens, on wide lateral spacing, extending into the furnace. Such surface is exposed to high-temperature furnace gases traveling at relatively low velocities, and the transfer of heat is principally by radiation.

Convection-type superheaters are installed beyond the furnace exit where the gas temperatures are lower than those in the zones where radiant-type superheaters are used. The tubes are usually arranged in the form of parallel elements on close lateral spacing and in tube banks extending partially or completely across the width of the gas stream, with the gas flowing through the relatively narrow spaces between the tubes. High rates of gas flow and, thus, high convection heat-transfer rates are obtained at the expense of gas-pressure drop through the tube bank.

Superheaters, shielded from the furnace combustion zone by arches or wide-spaced screens of steam-generating tubes, which receive heat by radiation from the high-temperature gases in cavities or intertube

spaces and also by convection due to the relatively high rate of gas flow through the tube banks, have both radiant and convection characteristics.

Superheaters may utilize tubes arranged in the form of hairpin loops connected in parallel to inlet and outlet headers; or they may be of the continuous-tube type, where each element consists of a number of tube loops in series between the inlet and outlet headers. The latter arrangement permits the use of large tube banks, thus increasing the amount of heat-absorbing surface that can be installed and providing economy of space and reduction of cost. Either type may be designed for the drainage of the condensate which forms within the tubes during outages of the unit, or they may be used in pendent arrangements which are not drainable but, usually, have simpler and better supports. Nondrainable superheaters require additional care during start-up to remove the condensate by evaporation. Both types require that every tube have sufficient steam flow to prevent overheating during operation. In start-up, when flow is insufficient, gas temperatures entering the superheater must be controlled to limit tube metal temperatures to safe values for the material used.

The heat transferred from high-temperature gases by radiation and convection is conducted through the metal tube wall and imparted by convection to the high-velocity steam in the tubes. The removal of heat by the steam is necessary to keep the tube metals within a safe temperature range consistent with the temperature limits of oxidation and the creep or rupture strength of the materials (see Sec. 5). Allowable design stresses for various steels and alloys, as established by the ASME Code, are listed in Table 9.2.2 (see also Sec. 6). The practical use limit for each material also is indicated. Current editions of the code should be checked for latest revisions. For economic reasons, it is customary to use low-carbon steel in the steam inlet sections of the superheater and, progressively, more costly alloys as the metal temperatures increase.

The rate of steam flow through superheater tubes must be sufficiently high to keep the metal temperatures within a safe operating range and to ensure good distribution of flow through all the elements connected in parallel circuits. This can be accomplished by arrangements which provide for multiple passes of the steam flow through the superheater tube banks. Excessive steam-flow rates, while providing lower tube-metal temperatures, should be avoided, since they result in high pressure drop with consequent loss of thermodynamic efficiency. As a general guide, the range of the steam-flow rates required for various steam and gas temperature conditions is shown in Table 9.2.3.

Table 9.2.2 Superheater and Reheater Tubes—Maximum Allowable Design Stress, lb/in² ($\times 0.070307 = \text{kgf/cm}^2$)

Material	ASME spec. no. and type	Temp, °F (°C)							
		900 (482)	950 (510)	1,000 (538)	1,050 (566)	1,100 (593)	1,150 (621)	1,200 (649)	1,300 (704)
Carbon steel	SA210, grade C	5,000	3,000						
Carbon moly	SA209, T1a	13,600	8,200						
Croloy ½	SA213, T2	12,800	9,200	5,900					
Croloy 1¼	SA213, T11	13,100	11,000	6,600	4,100				
Croloy 2¼	SA213, T22		11,000	7,800	5,800	4,200			
Croloy 5	SA213, T5				4,200	2,900	2,000		
Croloy 9	SA213, T9				5,500	3,300	2,200	1,500	
Croloy 304H	SA213, TP 304H				9,500	8,900	7,700	6,100	3,700
Croloy 32H	SA213, TP 321H				10,100	8,800	6,900	5,400	3,200

SOURCE: ASME Code, 1983.

Table 9.2.3 Range of Steam Mass Flow Values of Convection Superheaters

Temp, °F (°C)	Steam mass flow	
	Steam	Gas
Less than 750 (399)	1200 (649)	lb/(h · ft ² flow area) 75,000–150,000 kg/(m ² · s) 102–204
700–800 (371–426)	1600 (871)	250,000–350,000 340–475
800–900 (426–482)	2400 (1316)	400,000–500,000 545–680
900–1,000 (482–538)	2400 (1316)	500,000–600,000 680–816
1,000–1,100 (538–593)	2400 (1316)	700,000 and higher 950

The spacing of the tubular elements in the tube bank and, consequently, the rate of gas flow and convection heat transfer are governed primarily by the types of fuel fired, draft-loss considerations, and the fouling and erosive characteristics of fuel ash carried in the gas stream. With clean gases, or in the low-gas-temperature zones of coal-fired units, a gas flow rate of about 6,000 lb/(h · ft²) [8.2 kg/(m² · s)] of free-flow area is generally within economic limits. In the higher-gas-temperature zones, 1,600 to 2,300°F (871 to 1,260°C), the adherence and the accumulation of ash deposits can reduce the gas-flow area and, in some cases, may completely bridge the space between tubes. Thus, as gas temperatures increase, it is customary to increase the tube spacings in the tube banks to avoid excessive draft loss and to facilitate ash removal.

ECONOMIZERS

Economizers remove heat from the moderately low-temperature combustion gases after the gases leave the steam-generating and superheating/reheating sections of the boiler unit. Economizers are, in effect, feedwater heaters which receive water from the boiler feed pumps and deliver it at a higher temperature to the steam generator. Economizers are used instead of additional steam-generating surface, since the feedwater and, consequently, the heat-receiving surface are at temperatures below the saturated-steam temperature. Thus, the gases can be cooled to lower temperature levels for greater heat recovery and economy.

Economizers are forced-flow, once-through, convection heat-transfer devices, usually consisting of steel tubes, to which feedwater is supplied at a pressure above that in the steam-generating section and at a rate corresponding to the steam output of the boiler unit. They are classed as horizontal- or vertical-tube types, according to geometrical arrangement; as longitudinal or crossflow, depending upon the direction of gas flow with respect to the tubes; as parallel or counterflow, with respect to the relative direction of gas and water flow; as steaming or nonsteaming, depending on the thermal performance; as return-bend or continuous-tube, depending upon the details of design; and as bare-tube or extended-surface, according to the type of heat-absorbing surface. Staggered or in-line tube arrangements may be used. The arrangement of tubes affects the gas flow through the tube bank, the draft loss, the heat-transfer characteristics, and the ease of cleaning.

The size of an economizer is governed by economic considerations involving the cost of fuel, the comparative cost and thermal performance of alternate steam-generating or air-heater surface, the feedwater temperature, and the desired exit-gas temperature. In many cases, it is more economical to use both an economizer and an air heater.

The temperatures of the economizer tube metals generally approximate those of the water flowing within the tubes, and thus with low feedwater temperatures, condensation and external corrosion are encountered in those locations where the tube-metal temperature is below that of the acid or water dew point of the gas (see Fig. 9.2.30). Internal

corrosion and pitting also may be experienced if the feedwater contains more than 0.007 ppm of dissolved oxygen. Therefore, it is imperative to maintain feedwater temperatures above the dew-point temperature of the gas and to provide suitable deaeration of the feedwater for the removal of oxygen.

AIR HEATERS

Air heaters, like economizers, remove heat from the relatively low-temperature combustion gases. The temperature of the inlet air is less than that of the water to the economizer, and thus it is possible to reduce the temperature of the gaseous products of combustion further before they are discharged to the stack.

The heat recovered from the combustion gases is recycled to the furnace with the combustion air and, when added to the thermal energy released from the fuel, is available for absorption by the steam-generating unit, with a resultant gain in overall thermal efficiency. The use of preheated combustion air accelerates ignition and promotes rapid and complete burning of the fuel.

Air heaters are usually classed as **recuperative** or **regenerative**. Both types utilize the convection transfer of heat from the gas stream to a metal or other solid surface and the convection transfer of heat from this surface to the air. In recuperative air heaters, exemplified by the tubular or plate types (Fig. 9.2.31), the stationary metal parts form a separating boundary between the heating and cooling fluids, and the heat passes by

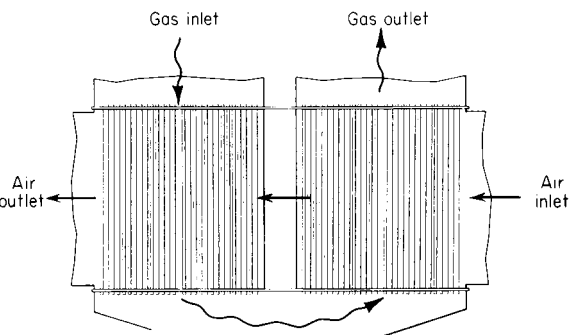

Fig. 9.2.31 Recuperative-type tubular air heaters, two gas passes, single air pass.

conduction through the metal wall. There are two commonly used types of regenerative air heaters (Fig. 9.2.32). In Fig. 9.2.32a, the heat transfer members are moved alternately through the gas and air streams undergoing successive heating and cooling cycles and transferring heat by the thermal-storage capacity of the members. The other type of regenerative air heater (Fig. 9.2.32b) has stationary elements, and the alternate flow of gas and air is controlled by rotating the inlet and outlet connections.

Recuperative and regenerative air heaters may be arranged either vertically or horizontally and for either parallel or counterflow of the gas and air. The gases are usually passed through the tubes of tubular air heaters to facilitate cleaning, although in some designs, particularly for marine installations, the air flows through the tubes.

Improved heat transfer and better utilization of the heat-absorbing surfaces are obtained with a counterflow of the gases and the use of small flow channels. Regenerative type air heaters readily lend themselves to these two principles and thus offer high capability in minimum space. However, regenerative air heaters have the disadvantages of air leakage into the gas stream and the transport of fly ash into the combustion air system. Tubular-type recuperative air heaters do not encounter these problems.

The products of combustion from most fuels contain a high percentage of water vapor, and thus condensation will be experienced in air heaters if the exposed metal surfaces are cooled below the dew point of

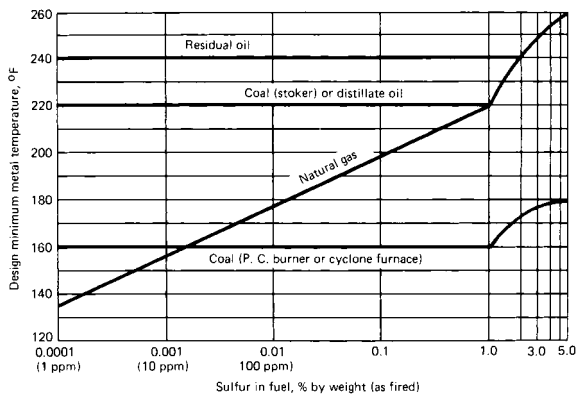
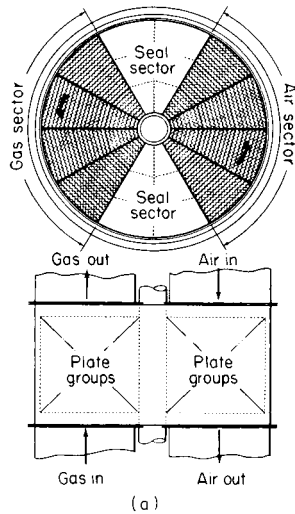
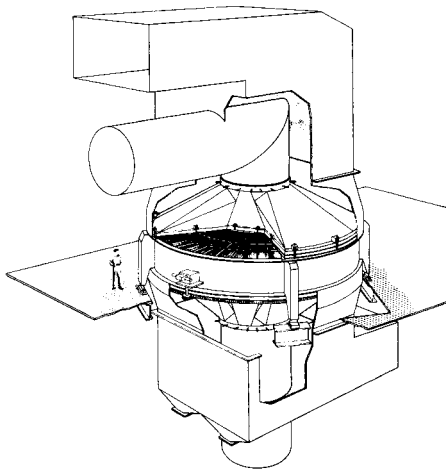

Fig. 9.2.30 Limiting metal temperatures to avoid external corrosion in economizers or air heaters when fuel containing sulfur is burned.

the gas. Minute concentrations of sulfur trioxide in the gases, originating from the combustion of sulfur and varying with the sulfur content of the fuel and the method of firing, combine with the water vapor in the combustion gases to form sulfuric acid, which may condense on the metal surfaces at acid-dew-point temperatures as high as 250 to 300°F (121 to 149°C), well above the water dew point (Huge and Piotter, *Trans. ASME*, 1955). Such condensation leads to corrosion and/or the fouling of the gas-flow area. It is most likely to occur during the winter when the entering-air temperature is low, and at low operating loads or in localized sections at the cold-air inlet if there is poor distribution of the air or the gas flowing through the air heater. Corrosion and fouling can be prevented by the use of auxiliary steam-heated air heaters located ahead of the air inlet, by recirculating heated air from the outlet duct, or by bypassing a portion of the cold air to reduce the airflow through the air heater. Both recuperative and regenerative air heaters often are designed with separate corrosion sections arranged to facilitate the replacement of the vulnerable cold-end portions.



(a)



(b)

Fig. 9.2.32 Two designs of rotary regenerative air heaters.

STEAM TEMPERATURE, ADJUSTMENT AND CONTROL

The control of steam temperatures is vital to the life of high-temperature equipment and to the economy of power generation. Actual, or operat-

ing, steam temperatures below the design temperature reduce the thermodynamic efficiency and increase fuel cost, and temperatures above the design temperature reduce the margins of reserve in the strength of tubes, headers, piping, valves, and turbine elements. Further, sudden or extreme temperature variations may cause destructive stresses, particularly in rotating equipment.

It is sometimes necessary, because of the complexities involved in the design evaluation of heat-transfer rates and fuel characteristics, to modify installed equipment to obtain the required steam temperatures. Such changes might involve the installation of baffles for the distribution of gas through the superheater and the removal, or addition, of tubular elements in the superheater or in those components preceding the superheater which affect the temperature of the gas to the superheater. Therefore, it is desirable, and usually essential, to provide some means of controlling steam temperature to compensate for the variations in fuel, heat transfer, and surface cleanliness conditions encountered during operation. These may include (1) damper control of the gases to the superheater and/or reheater; (2) recirculation of the low-temperature gaseous products of combustion to the furnace to change the relative amounts of heat absorbed in the furnace, in the superheater, and/or in the reheater; (3) selective use of burners at different elevations in the furnace or the use of tilting burners to change the location of the combustion zone with respect to the furnace heat-absorbing surface; (4) attemperation or controlled cooling of the steam at superheater inlet, at superheater outlet, or between the primary and secondary stages of the superheater; (5) control of the firing rate in divided furnaces; and (6) control of the firing rate relative to the pumping rate of water in forced-flow once-through boilers.

The speed of response differs for the various methods, and the control of steam temperature by gas bypass or flame position is slower than that by spray-water attemperation. The operating controls for these methods can be arranged for manual, automatic, or combination adjustment, and the use of more than one method often facilitates the maintaining of constant steam temperature over a wider range of boiler load (Fig. 9.2.33).

The attemperation of superheated steam by direct-contact water spray (Fig. 9.2.34) results in an equivalent increase in high-pressure steam generation without thermal loss. Spray attemperation requires the use of

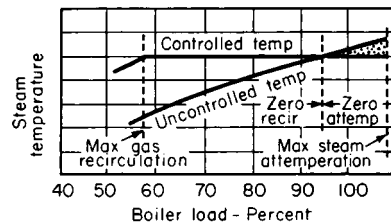

Fig. 9.2.33 Steam temperature control by flue gas recirculation and attemperation.

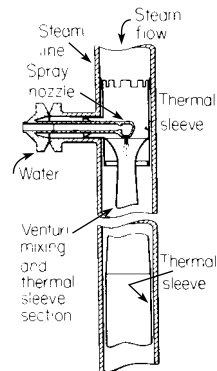

Fig. 9.2.34 Spray-type direct-contact attemperator.

essentially pure water, such as condensate, to avoid impurities in the steam. Submerged-type attemperators, when used, are generally restricted to relatively low-pressure boilers operating with steam temperatures of 850°F (454°C) or less. Usually, spray attemperators are not used for the control of reheat-steam temperature since their use reduces the overall thermal-cycle efficiency. They are, however, often installed for the emergency control of reheat-steam temperatures.

Ash and slag deposits on superheater and reheater surfaces reduce heat transfer and lower steam temperatures. Similar deposits on the furnace walls and steam-generating surface ahead of the superheater and/or reheater also reduce heat transfer to those surfaces, resulting in higher-temperature gas to the superheater and reheater and, consequently, increased steam temperatures. Thus the control of surface cleanliness is an important factor in the control of steam temperature.

Increased excess air results in higher steam temperatures because of reduction in furnace radiant-heat absorption, the greater amount of gas, and the increased convection heat transfer in the superheater and/or reheater. Operation with feedwater temperatures below that anticipated also results in increased steam temperatures because of the greater firing rate required to maintain steam generation.

OPERATING CONTROLS

(See also Sec. 16.)

The need for operating instruments and manual or automatic controls varies with the size and type of equipment, method of firing, and proficiency of operating personnel.

Safe operation and efficient performance require information relative to the (1) water level in the boiler drum; (2) burner performance; (3) steam and feedwater pressures; (4) superheated and reheated steam temperatures; (5) pressures of the gas and air entering and leaving principal components; (6) feedwater and boiler-water chemical conditions and particle carryover; (7) operation of feed pumps, fans, and fuel-burning and fuel-preparation equipment; (8) relationship of the actual combustion air passing through the furnace to that theoretically required for the fuel fired; (9) temperatures of the fuel, water, gas, and air entering and leaving the principal components of the boiler unit; and (10) fuel, feedwater, steam, and air flows so as to monitor operating conditions continuously and to make such adjustments as might be necessary.

Control of the various functions to maintain the desired operating conditions may be accomplished on small-capacity boilers by the manual adjustment of valves, dampers, and motor speeds. Most oil- and gas-fired package boilers are equipped with automatic controls to purge the furnace, to start and stop the burners, and to maintain the required steam pressure and water level. The operating requirements of utility and large industrial boilers dictate the use of automatic controls for the major variables, such as feedwater flow, firing rate, and steam temperature. The type of boiler and its components generally establishes the basic mode of control. Analog controls of either the pneumatic or the electric type are available. Digital control is being used more extensively.

Sequence controls often are applied in the start-up of utility boilers to program the furnace purge, burner light-off, and burner control. Interlocks are essential to ensure the proper starting and firing sequence and to alarm or automatically shut down the unit in the event of the failure of essential auxiliaries.

BOILER CIRCULATION

Adequate circulation in the steam-generating section of a boiler is required to prevent overheating of the heat-absorbing surfaces, and it may be provided naturally by gravitational forces, mechanically by pumps, or by a combination of both methods.

Natural circulation is produced by the difference in the densities of the water in the unheated downcomers and the steam water mixture in the heated steam generating tubes. This density differential provides a large circulating force (curve A, Fig. 9.2.35). The downcomers and the heated circuits are so designed that the friction, or resistance to flow,

through the system balances the circulating force at the desired total circulating flow.

The forced-recirculation or assisted-circulation type boiler uses a steam drum similar to that used with natural-circulation boilers. The

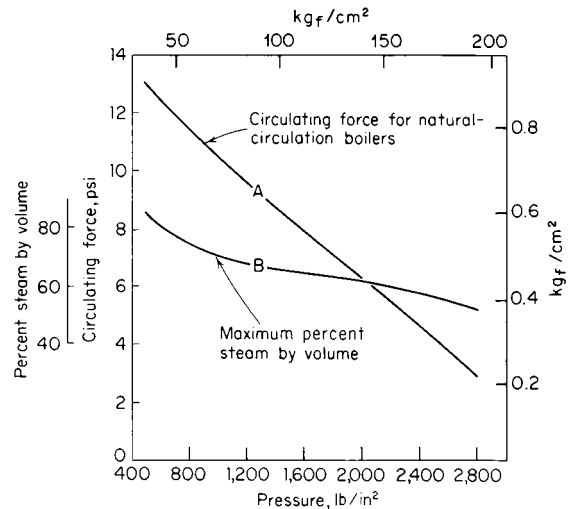

Fig. 9.2.35 Maximum percent steam by volume and circulating force for natural-circulation boilers.

supply of water to the furnace walls and the boiler surfaces flows from this drum to a circulating pump, which supplies the pressure necessary to force the water through the water-steam mixture circuits and then back to the drum, where the steam and water are separated. The total quantity of water pumped usually is 4 to 6 times the amount of steam evaporated, as shown in Fig. 9.2.36. The recirculating pump produces a differential pressure of 30 to 40 lb/in² (2.1 to 2.8 kgf/cm²), and the power required is equivalent to about 0.5 percent of the heat input to the boiler. Resistor orifices are required at the entrance to each tube, or circuit, to control flow distribution.

In assisted-circulation designs, the velocities or flows are independent of boiler rating, thus facilitating the use of smaller connecting piping and, sometimes, smaller-diameter furnace-wall tubing than that used with natural-circulation units. Both drum-type natural- and assisted-circulation boilers operate with essentially saturated steam temperatures in all parts of the steam-evaporating sections, and they can be used for drum operating pressures ranging up to approximately 2,800 lb/in² (197 kgf/cm²).

In natural- and assisted-circulation boilers, it is essential to wet the inside surfaces continually with water of the two-phase water-steam mixture to prevent overheating these heat-absorbing surfaces.

Satisfactory cooling of the heat-absorbing steam-generating surfaces is dependent upon the pressure, heat flux, water-steam mass velocity, percent steam by weight (quality), tube diameter, and the tube's internal geometry. The heat flux is one of the most predominant of these parameters, and the rate of furnace heat absorption at the maximum firing rate generally dictates design considerations.

In forced-flow once-through boilers, the water from the feed supply is pumped to the inlet of the heat-absorbing circuits. Evaporation, or change of state, takes place along the length of the circuit, and when evaporation is completed the steam is superheated. These units do not require steam or water drums and, in most cases, use relatively small-diameter tubes. The boilers can be started rapidly owing to the elimination of the drums and the reduced amount of metal. The water flow to the unit is the same as the steam output (Fig. 9.2.36), and fluid velocities greater than those needed for natural- or assisted-circulation units must be used at full load so as to maintain adequate velocities at the low loads and, thus, satisfactory tube-metal temperatures at all loads.

The transition from a liquid to a vapor at, or above, the critical steam

pressure of 3,206 lb/in² (225 kgf/cm²) is dependent upon temperature and takes place without a change in density. Thus, separation of steam and water is impossible and forced-flow once-through boilers must be used.

Forced-flow once-through boilers must be operated above a specified minimum flow—usually one-quarter to one-third of full-load flow—in order to maintain adequate water velocities in the furnace-wall tubes. However, the turbogenerator can be operated at any load by the use of a bypass system that diverts the excess flow to a flash tank for heat recovery. The bypass system also can be used as a pressure relieving system, as the source of low-pressure steam to the turbine during start-up, and as a means of controlling steam temperature to the turbine during hot restarts.

Combined circulation units utilize forced once-through flow with flow recirculation in the furnace walls to provide satisfactory water velocities during start-up and low-load operations. In this design, some of the water at the exit of the furnace circuits is mixed with the incoming feedwater, flows to and through a circulating pump, and then passes to the furnace-wall inlet headers. The use of combined circulation increases the water velocities in the furnace tubes at low loads, and since recirculation is not used at the higher loads, there is no increase in velocity or in the resistance to flow at the higher loads.

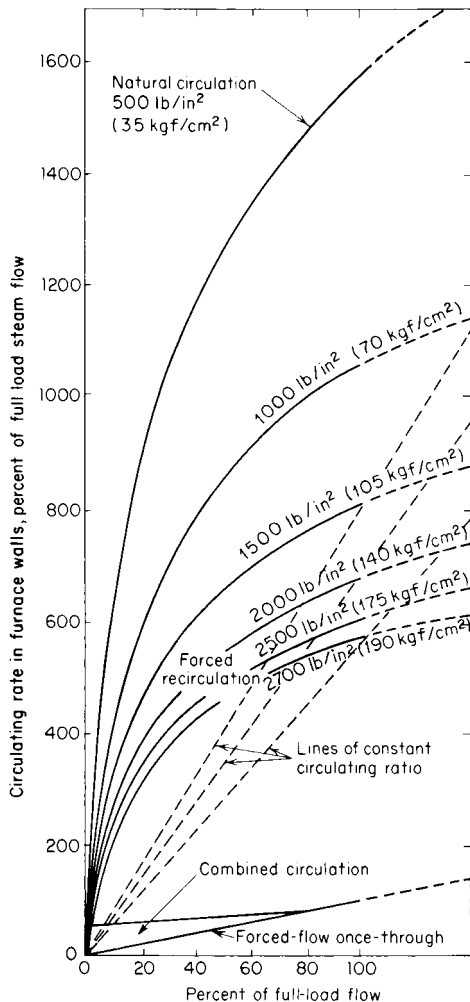

Fig. 9.2.36 Circulating flow for natural- and forced-circulation systems.

FLOW OF GAS THROUGH BOILER UNIT

During the combustion of fuel and the transfer of heat to the heat-absorbing surfaces, it is necessary to maintain sufficient pressure to overcome the resistance to flow imposed by the burning equipment, tube banks, directional turns, and the flues and dampers in the system. The resistance to air and gas flows depends upon the arrangement of the equipment and varies with the rates of flow and the temperatures of the air and gas.

The term draft denotes the difference between atmospheric pressure and some lower pressure existing in the furnace or gas passages of a steam-generating unit. Draft loss is defined as the difference in static pressure of a gas between two points in a system, both of which are below atmospheric pressure, and is the result of the resistance to flow. These terms originated with the use of the so-called natural-draft units in which the pressure differentials are obtained from a chimney or stack which produces static pressures throughout the boiler setting that are below that of the atmosphere. The terms are rather loosely applied to modern boilers using induced draft and/or forced draft, mechanically produced by fans, in which the pressures throughout the boiler unit may be well above atmospheric pressure.

Forced-draft fans, handling cold, clean air, provide the most economical source of energy to produce flow through high-capacity units (see Sec. 14.5). Induced-draft fans, handling hot flue gases, require more power and are subject to fly-ash erosion. However, they facilitate operation by providing a draft in the boiler setting and thus prevent the outward leakage of gas through joints or crevices in the boiler enclosure. As a result of advances in furnace and boiler-setting designs to eliminate gas leakage, modern units often are built for positive-pressure operation, thus eliminating the need for induced-draft fans. Such units are generally referred to as pressure-fired units, while those using induced-draft fans are classed as suction units. When both forced- and induced-draft fans are used, the boilers are designated as balanced-draft units.

The pressure drop throughout the unit is caused by the fluid friction in the gas stream and the shock losses at the turns or the contractions and enlargements of sections. It can be calculated as a function of the fluid mass flow and fluid properties in accordance with the principles of fluid flow (see Sec. 3). It is essential in the design of a boiler to determine the sum of all component resistances in the flow system at the maximum load in order to establish the fan requirements. It is customary to specify test-block static head, temperature, and capacity requirements of the fan in excess of those calculated so as to allow for departure from ideal flow conditions and to provide a satisfactory margin of reserve.

Stack effect is caused by the difference in densities resulting from the difference in the temperatures of two vertical columns of gas. In a chimney, or stack, the stack effect is due to the difference between the confined hot gas and the cooler surrounding air and the equal static pressure at the top or free outlet of the stack. The stack effect, which varies with the height and the mean temperature of the columns, can be calculated from the data in Table 9.2.4. The effect is the static draft produced by a stack, at sea level, with no gas flow. When flow occurs, a portion of the stack effect is used to establish gas velocity and the remainder is used to overcome the resistance of the connected system, including the dampers and the stack. The limit of natural-draft capacity is reached when these forces are in balance with the dampers in a wide-open position. Stack performance may be favorably or adversely affected by external factors such as the wind and the atmospheric conditions. The available draft varies directly with the barometric pressure for altitudes above sea level.

Stack effects also exist within the boiler setting and are most pronounced in tall units with vertical gas passes. The individual gas columns within the setting may aid the head produced by the fan or chimney if the flow is upward or may reduce it if the flow is downward. The net stack effect, and its overall influence on the performance of the fan, may be calculated from the data in Table 9.2.4, taking into account the positive or negative effects. The relationship between local static pressures and the atmospheric pressure is most important, since gas may

Table 9.2.4 Stack Effect of Pressure Difference, in of Water for 1 ft of Vertical Height (mm of Water for Each 1 m of Vertical Height)
 Barometer = 29.92 inHg (759.97 mmHg)

Avg temp in flue, °F (°C)	Air temp outside flue, °F (°C)			
	40°F (5°C)	60°F (15°C)	80°F (25°C)	100°F (35°C)
250 (125)	0.0041 inH ₂ O/ft (0.346 mmH ₂ O/m)	0.0035 (0.303)	0.0030 (0.262)	0.0025 (0.224)
500 (250)	0.0070 (0.563)	0.0064 (0.520)	0.0058 (0.480)	0.0053 (0.442)
1,000 (500)	0.0098 (0.788)	0.0092 (0.774)	0.0086 (0.708)	0.0081 (0.665)
1,500 (750)	0.0111 (0.902)	0.0106 (0.858)	0.0100 (0.818)	0.0095 (0.780)
2,000 (1,000)	0.0120 (0.972)	0.0114 (0.925)	0.0108 (0.887)	0.0103 (0.850)
2,500 (1,250)	0.0125 (1.018)	0.0119 (0.975)	0.0114 (0.934)	0.0109 (0.896)

blow into the room through an open inspection door at the top of a furnace, even though a strong draft, or negative pressure, exists at some lower elevation.

PERFORMANCE

Steam-generating units are designed for specific operating conditions and are generally sold with a guarantee of performance. The boiler rating is usually specified and guaranteed in terms of steam output (lb/h) at a given pressure and temperature at full load or maximum continuous operation. When the steam is reheated, the rating includes this requirement in terms of the quantity of reheat steam at stated inlet and outlet steam pressures and temperatures.

Generally, either the efficiency or the gas temperature leaving the unit is guaranteed at a specified rate of operation, and the draft loss and the quality or purity of the steam also may be guaranteed at this rate. When component equipment such as stokers, pulverizers, burners, and air heaters are supplied by different manufacturers, the performance of the individual components is usually guaranteed by the various manufacturers and then, in turn, guaranteed by the prime contractor.

Anticipated-performance data for several rates of operation may be given to the purchaser in addition to the guaranteed-performance data. Guarantees may be demonstrated by acceptance tests, conducted in accordance with established codes, as agreed upon by the parties to the contract. However, acceptance tests are more difficult to perform as unit size and capacity increase, and overall performance usually is determined from the operating data. Guarantees of materials and the quality of manufacture and erection are usually considered separately from those pertaining to operating performance.

Heat balances account for the thermal energy entering the system in terms of its ultimate useful heat absorption or thermal loss. Methods of measuring and calculating the quantities involved in heat balances are presented in the ASME Power Test Code for Stationary Steam Generating Units.

The heat input is predicated upon the hourly firing rate, the calorific heating value of the fuel, and any additional heat supplied from an outside source. Heat in the preheated combustion air obtained from an air heater integral with the boiler unit is not considered in the determination of heat input, since this heat is recycled within the system.

The heat absorption in a boiler is calculated from the rate of steam output and the increase in fluid enthalpy from feedwater conditions to that at the superheater outlet. The amount of heat absorbed by the steam passing through the reheater, if used, is added to the heat absorbed in the boiler, economizer, and superheater. The total heat absorption also must take into account any steam generated which bypasses the superheater. Usually, the heat absorption is determined on an hourly basis.

In its simplest form,

$$\text{Efficiency (percent)} = \frac{[\text{heat absorbed, Btu/h (cal/h)}]}{(\text{heat input, Btu/h (cal/h)})} \times 100$$

Both the heat input and the heat absorption may be very large quantities. Therefore, unless elaborate precautions are taken in the sampling and the measurement of fuel and steam quantities, it is difficult to obtain test data having the degree of accuracy required to determine the actual efficiency of the boiler unit. For this reason, boiler efficiency usually is established from the heat losses, since each of the thermal losses is a relatively small percentage of the heat entering the system and reasonable errors in measurement will not appreciably affect the final result.

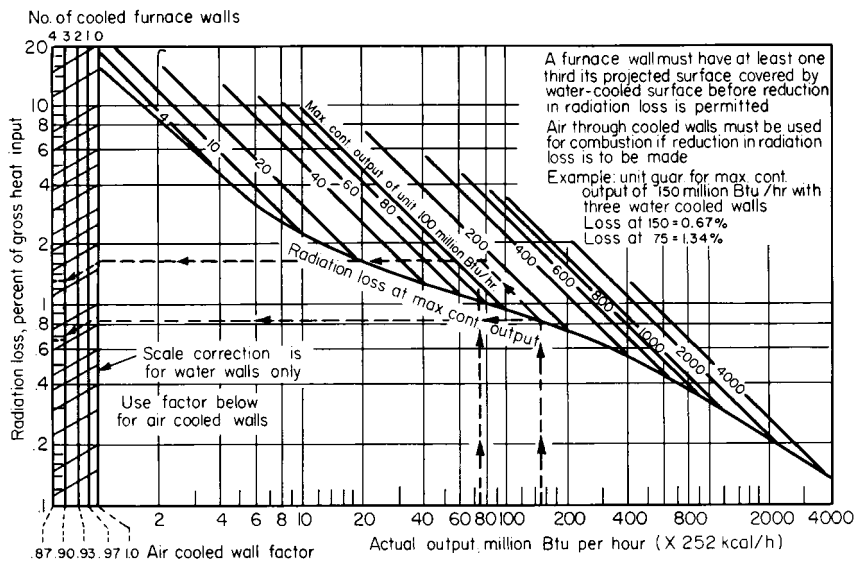

Fig. 9.2.37 External heat loss from boiler setting (ABMA).

The principal thermal losses are those due to the sensible heat in the gases leaving the unit, latent-heat losses associated with the evaporation of fuel moisture and formation of water vapor resulting from burning of hydrogen in the fuel, unburned-combustible loss, loss from the boiler setting or enclosure due to external convection and radiation, and ashpit loss. The first two losses can be derived from the fuel analysis, the exit-gas temperature, and the analysis of the flue gas (see Sec. 4). The unburned-combustible loss can be established by a qualitative and quantitative sampling of refuse and fly ash. The radiation from the boiler setting can be estimated in detail, but it also can be approximated from Fig. 9.2.37. The heat loss to the ashpit of large units can be determined by measuring the quantity of quenching water evaporated from the furnace ash hopper or the slag tank; and for small units the ashpit loss is included in the heat loss from the boiler setting. The sum of these heat losses, expressed as a percentage of the total heat input, is the total measurable loss. The anticipated or guaranteed performance data include a tolerance for the so-called manufacturer's margin (unaccountable losses) in the order of 0.5 to 0.75 percent, depending upon the type of fuel fired. The thermal efficiency of the unit is established by subtracting the sum of all these losses from 100 percent.

Tests of the individual components of the boiler unit, such as the furnace, superheater, economizer, or air heater, may be conducted for the determination of heat-transfer and gas-flow characteristics, for comparisons with other units, or to facilitate changes in operating procedures or equipment. Available ASME codes delineate such tests.

WATER TREATMENT AND STEAM PURIFICATION

(Also see Secs. 6.5 and 6.10.)

Purity of the water used in steam generation and of the steam leaving the unit is of paramount importance. The following discusses the general problem and then reviews the four areas of concern: raw water, feedwater, boiler water, and steam purification.

General

With few exceptions, the waters found in nature are not suitable for use as boiler feedwater; but they can be used after proper treatment. In essence, this entails the removal from the raw water of those constituents which are known to be harmful; supplementary treatment, within the boiler or connected system, of residual impurities to convert them into harmless forms; and systematic removal, by blowdown of boiler-water concentrates, to prevent excessive accumulation of solids within the boiler unit.

The ultimate purpose of water treatment is to prevent deposits of scale or sludge on and corrosion of the internal boiler surfaces. Hard-scale formations, formed by certain constituents in the zones of high-heat input, retard the flow of heat and raise the metal temperatures. This can lead to overheating and the failure of pressure parts. Sludge or solid particles normally carried in suspension may settle locally and restrict the flow of cooling water or, in some cases, deposit in the form of insulating layers with a resultant effect similar to that of hard scale. Oil and grease prevent adequate wetting of internal boiler surfaces and, in areas of high heat input, may cause overheating. Further, oil and grease may carbonize and form a tightly adherent insulating coating. Corrosion (see also Sec. 6.5), due to acidic conditions or to dissolved gases, can weaken a boiler because of the loss of metal. Corrosion usually occurs as cavities and pits in localized areas which, as they deepen, may penetrate the metal. Frequently, corrosion occurs under internal deposits because of elevated temperatures and solids concentrations. Therefore, corrosion and solids deposits are closely related. Certain chemical reactions produce an intergranular attack of the metal that may lead to embrittlement and ultimate fracture.

The treatment best suited, or economically justified, for any given plant depends upon the characteristics of the water supply, the amount of makeup water, and the design of the steam-generating and related equipment. Usually, the feedwater and boiler-water treatment is supervised by a chemist, and often it is desirable to engage a reputable feedwater specialist to prescribe specific procedures. However, the results

obtained depend upon the diligence and integrity of routine sampling and the control carried out by plant personnel.

Raw Water

All natural waters contain impurities, many of which may be harmful in boiler operation. These impurities originate from the earth and the atmosphere (or from municipal and industrial wastes) and are broadly classed as suspended or dissolved organic and inorganic matter and as dissolved gases.

The concentration of the impurities is customarily expressed in terms of the parts by weight of the constituent per million parts of water (ppm). This is equivalent to the percentage of concentration multiplied by 10^4 and has the advantage of using positive whole numbers for small concentrations. However, for exceedingly small concentrations, especially those involving gases, the quantities are sometimes expressed as parts per billion (ppb). Concentrations also may be expressed in terms of the number of grains per gallon, but in boiler practice this has generally been superseded by the gravimetric relation, ppm. One grain per gallon is equal to 17.1 ppm.

The treatment of raw water for makeup and boiler feedwater involves one or more of the following:

1. *The removal of suspended solids.* Large particles in the water are removed by settling and decantation or by filtering through screens, fabrics, or beds of granular material. Small particles which settle slowly or colloidal particles which do not settle can be removed by coagulation using floc-forming chemicals, such as alum or ferrous sulfate, to trap the particles in the floc. The floc is then removed by settling or filtration. The solids can be removed intermittently or on a continuous basis.

2. *Chemical treatment for removal of hardness.* Calcium, magnesium, and silica are the principal scale-forming impurities in water and, if present in the boiler water, may form compounds whose solubility decreases with an increase in temperature.

In the lime-soda process for softening water, lime (calcium hydroxide) reacts with the soluble calcium and magnesium bicarbonates to form precipitates of calcium carbonate and magnesium hydroxide which can be removed as sludge. The soda ash (sodium carbonate) reacts with the scale-forming calcium sulfate and magnesium sulfate, and precipitates the calcium and magnesium as insoluble carbonates. Both reactions produce sodium sulfate, a soluble and non-scale-forming compound. When the hot-lime-soda process is carried out at temperatures of 200 to 250°F (93 to 121°C), the reactions are accelerated and some of the silica may be removed.

The reactions, as in all chemical processes, tend to approach equilibrium but they are affected by time, completeness of mixing, and removal of the products. Therefore, in either the intermittent batch or the continuous process some residual hardness is left in the treated water.

3. *Cation exchange for removal of hardness.* Certain naturally occurring minerals, such as sodium aluminum silicate, or synthetic resins, such as the polystyrenes or phenolic materials, have the ability to exchange sodium ions for calcium and magnesium ions if present in a water solution. Thus softening can be accomplished by passing raw or filtered water through beds of granulated zeolite particles. The calcium and magnesium ions are retained by the zeolite material, while their equivalents of non-scale-forming sodium ions are released to the water solution. Before complete exhaustion of the sodium is reached, the softening equipment must be isolated from the system and regenerated by the passage of a strong brine of sodium chloride through the softener. Sodium ions are thus restored to the zeolite, and calcium, or magnesium, is removed as a soluble chloride and drained to waste. After the regenerating cycle, the equipment is purged of the brine by flushing with filtered water and then returned to softening service.

The most popular system today combines chemical treatment and cation exchange, and utilizes hot lime (with or without magnesium for silicate removal) followed by hot sodium-cation exchange.

4. *Demineralization for complete removal of dissolved solids.* Several types of synthetic organic resins are capable of selectively removing undesirable cations or anions from water solutions by their ex-

change for hydrogen or hydroxyl ions. When used in combination, as separate or mixed beds of small-sized beads or particles through which the water flows, they can produce an effluent that is virtually free of mineral solutes and satisfactory for boiler feedwater. The cation exchanger is regenerated by acid which restores hydrogen ions to the resin in exchange for the calcium, sodium, or other metallic cations removed from the water. The anion exchanger is regenerated by the use of caustic soda, or another appropriate base, which restores the hydroxyl ions in exchange for the chloride, sulfate, or other negative chemical radicals previously removed from the water. The hydrogen and hydroxyl ions released from the resins during the heating process combine to form pure water. The greatest effectiveness is attained by a mixed-bed arrangement of resins, since the interchange of cation and anion components proceeds in minute increments and with less probability of the escape of unexchanged ions. With individual regeneration, the mixed resins are separated hydraulically because of differences in specific gravity. The resins can then be sluiced to external regeneration facilities or regenerated in place. The resins must be remixed before the demineralizer is returned to service.

5. *Evaporation.* Essentially pure water can be obtained by the evaporation of raw water and the collection of the distillate. Evaporation leaves the soluble constituents as concentrates in the residual water which can be removed by blowdown, or as scale on the heat-absorbing surfaces which can be mechanically removed. There may be some contamination in the distillate because of the carryover of water particles with the vapor and the reabsorption of noncondensable gases.

Feedwater

Boiler feedwater may consist of condensate, treated water, or a mixture of both. Usually, there is only a small amount of dissolved and suspended solids as a result of the treatment and, generally, the removal of additional solids is not required. However, any dissolved gases present must be removed to prevent corrosion in the boiler and the preboiler system.

When condensate is used as the feedwater to a boiler, water treatment is minimized, since it is required only for the small amounts of raw water that may leak into the system and the makeup water needed (usually $\frac{1}{2}$ to 3 percent) to replace the loss of steam and condensate from the system. However, in industrial plants using a large portion of the steam generated for process work, the makeup-water requirements may be 90 to 100 percent of the total feedwater flow. Such plants require a considerable amount of water treatment.

Dissolved oxygen is, perhaps, the greatest factor in the corrosion of steel surfaces in contact with water. It may be present in the makeup water or the feedwater because of previous contacts with atmospheric air, or it may be added to the water by the leakage of air into the system through low-pressure-pump seals, storage tanks, etc.

Oxygen may be partially removed (to a residual of 0.2 to 0.3 ppm) by heating the water to boiling temperature in open type feedwater heaters. Tray or spray-type deaerating heaters are more effective in removing oxygen (to residuals of 0.02 to 0.04 ppm), and the amount of oxygen in the water can be reduced to 0.007 ppm or less by the use of multistage deaerators arranged for the countercurrent scavenging of noncondensable gases. (See Sec. 9.5.)

It is customary to supplement feedwater deaeration by adding a scavenging agent, such as sodium sulfite or hydrazine, to effect the complete removal of residual oxygen. Sodium sulfite combines with oxygen to form sodium sulfate, but it should not be used at operating pressures in excess of 1,800 lb/in² (127 kgf/cm²), since it decomposes to corrosive products at high temperatures. Thus hydrazine should be used at high pressures.

In boiler plants using high-purity feedwater, corrosion may be experienced in the condensate piping and the preboiler system because of dissolved gases such as carbon dioxide, sulfur dioxide, or hydrogen sulfide in the water. These gases may originate from the atmosphere or from constituents in the boiler water. They are released in the steam generators, intimately mixed with the outgoing steam, and with the exception of those partially removed by the vacuum pumps, returned to

solution in the condenser. These gases in the condenser produce an acidic reaction leading to corrosion, even in the absence of dissolved oxygen. The corrosion products in the preboiler cycle often are carried into the boiler and may deposit on the heat-absorbing surfaces, with resultant overheating of these surfaces.

A small amount of alkaline boiler water is sometimes recirculated to the feedwater heaters to raise the pH of the feedwater and thus prevent corrosion in the preboiler system. However, this procedure may precipitate sludge in the feedwater piping if appreciable hardness is present in the boiler water.

The pH of the feedwater can be increased by the addition of ammonia or volatile amines, such as morpholine or cyclohexylamine. Generally, these compounds are added as early as possible in the preboiler system. This procedure prevents corrosion in the early stages of moisture formation in the turbine and the condenser, as well as in the entire condensate-return system.

Filming amines also can be used and are generally introduced to the system through chemical pumps in the feedwater or steam lines. These materials do not change the pH of the fluid but protect against corrosion by forming a monomolecular coating on the metal surfaces. However, caution must be exercised since excessive use of filming amines has been known to agglomerate boiler sludge and produce strongly adherent internal deposits.

Boiler Water

In boilers, water is converted into steam and the steam leaves the boiler drum in a relatively pure state. Impurities, other than the gases which enter with the feedwater, are thus retained and concentrated in the boiler water. High concentrations of foam-producing solids in the boiler water contribute to particle and water carryover and contamination of the steam. Chemical and solubility changes also take place in the boiler, particularly as temperature is increased.

Boiler water is treated internally to prevent corrosion, the fouling of heat-absorbing surfaces, and the contamination of steam. Internal treatment also aids in maintaining water conditions within satisfactory limits. The internal treatment requires the introduction of chemicals in suitable amounts to react with the residual impurities in the feedwater.

Corrosion in boilers is prevented or minimized by maintaining alkaline boiler water. This condition may be expressed in terms of pH or as total alkalinity.

Acid or alkaline reactions of aqueous solutions are due to the presence of free or excess hydrogen (H⁺) or hydroxyl (OH⁻) ions, and the strength of the reaction varies with the concentration or activity of the excess ions. Some compounds enter into solution without dissociation while others dissociate partially or completely into ions carrying positive or negative electrical charges. If such ionizable compounds contribute hydrogen (H⁺) ions to the solution (e.g., HCl), they add to the strength of its acid reaction; if they contribute hydroxyl (OH⁻) ions (e.g., NaOH), they add to its alkaline or base reaction. When the ions of many different compounds are present, as is the usual case with boiler waters, their interaction or buffering affects the resulting concentration of the specific ions, and the solution tends to approach a balance or equilibrium in accordance with the principles of chemical mass action. It is therefore possible by the addition of some compounds which in themselves contain neither hydrogen nor hydroxyl components to suppress or release these ions from other constituent solutes and thereby change the acidity of alkalinity of the solution.

The pH value of a solution, which designates its acidity or alkalinity, refers to a logarithmic scale proposed by Sorenson in 1909. The symbol p is derived from the German word *Potenz*, meaning power or exponent; and the symbol H represents the hydrogen-ion concentrations. Thus, by definition, the pH value is equal to the logarithm of the reciprocal of the hydrogen-ion concentration measured in gram-moles per litre.

Pure water, which may be considered as composed primarily of molecular H₂O, exhibits a slight degree of dissociation to hydrogen (+) and hydroxyl (-) ions in the equilibrium amounts, at room temperature, of 0.0000001 gmol each per litre of water. It thus has the somewhat unusual capability of reacting, under proper conditions, as a weak acid

or as a weak base and is said to be amphoteric. The H^+ and OH^- ions are in exact balance, and the water is electrically neutral.

The equation which expresses the equilibrium dissociation of water and also applies to water solutions is

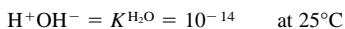

H^+ and OH^- represent the respective concentrations of the ionized hydrogen and hydroxyl groups, and the dissociation product K^{H_2O} is found by experimental methods to be $1/10^{14}$ at 25°C .

Since the product of the two concentrations is a constant, some OH^- ions are present even in a highly acidic solution and some H^+ ions are present in a basic solution, and the relationship of these factors can be determined from the measurement of either term. Thus, in the case of neutral water, the value of each is 10^{-7} , or 0.0000001, gmol/L.

In a solution having a hydrogen-ion concentration of 10^{-3} gmol/L, the corresponding hydroxyl-ion concentration is 10^{-11} , as a result of the dominating influence of the solvent, which is present in great excess and maintains the product equilibrium. Although either factor in the equation can be used, the conventional scale is based upon the measurement of the hydrogen ion.

Numerical values of this relationship extend over an extremely wide range and can best be expressed in terms of logarithms or exponents; thus:

$$\begin{aligned} \log H^+ + \log OH^- &= -14 \\ -\log H^+ - \log OH^- &= 14 \\ \log (1/H^+) \log &= 14 - (1/OH^-) = \text{pH} \end{aligned}$$

The term pH is used to represent $\log(1/H^+)$ and is therefore the logarithm of the reciprocal of the hydrogen-ion concentration (more properly, the hydrogen-ion activity which is equal to the concentration multiplied by an activity factor that approaches unity in dilute solutions).

For neutral water, the $\text{pH} = \log(1/H^+) = \log(1/0.0000001) = \log(1/10^{-7}) = 7.0$.

For an acid solution in which H^+ exceeds OH^- , say $H^+ = 10^{-3}$, the $\text{pH} = \log(1/10^{-3}) = 3.0$.

For an alkaline solution in which OH^- exceeds H^+ , say $OH^- = 10^{-3}$, the $\text{pH} = \log(1/10^{-11}) = 11.0$.

In practical terms, the pH scale extends from 0 to 14, as shown in Table 9.2.5. The value 7.0, corresponding to pure water, is considered the neutral point; values below 7.0 are increasingly acidic, and values above 7.0 are increasingly alkaline. Since the pH scale is logarithmic, a change from one number to the next in series is equivalent to a change of ten times the activity. Beyond the range of the scale, the strength of acid or alkaline solutions is expressed in terms of normality or percentage of concentration.

The pH of a water sample can be determined accurately by the measurement of its electrical potential. It also can be approximated by indi-

cators that change color in certain pH ranges as the result of their reaction with the solution. The pH of boiler water usually is maintained within the range of 10.2 to 11.5 for boilers operating at pressures compatible with an 1,800 lb/in² (127 kgf/cm²) turbine throttle pressure. Above these pressures, mixed-bed demineralizers are generally used to treat the makeup water, the boiler-water treatment is low in solids, and the pH ranges from 9.0 to 10.0.

In forced-flow once-through units the recommended pH range is 8.8 to 9.2 for preboiler systems using copper alloys. If the preboiler system does not incorporate the use of copper alloys, the recommended pH is 9.2 to 9.5.

Total alkalinity (expressed in ppm) is a measure of all reactives that have the ability to neutralize acids. It is determined by titrating a water sample with a standard acid, and it is frequently expressed as equivalent calcium carbonate, which has a molecular weight of 100. Total alkalinity, as determined in this manner, is not exactly the same as the pH measurement of alkalinity because of the buffering action which occurs in complex solutions. However, it is widely used as a reference and in the case of low-pressure boilers where higher concentrations of greater diversity of solids can be tolerated, it often is more satisfactory than the measurement of pH as an index of boiler-water conditions.

The elimination of hardness in boiler water is necessary to prevent scale. Hardness can be removed by introducing one of the forms of sodium or potassium phosphate and thoroughly mixing it with the boiler water. The residual calcium ions entering with the feedwater are precipitated as an insoluble phosphate sludge and the magnesium is precipitated as a nonadherent magnesium hydroxide, if the alkalinity is maintained at a pH of 10 or higher. A lower pH may result in the formation of magnesium phosphate, an adherent type of sludge. Routine control facilitates the adjustment of the pH by the addition of sodium hydroxide, or its equivalent, and the maintenance of a moderate excess of phosphate ions in the boiler water.

Early methods of internal treatment employed the use of soda ash for hardness removal. However, the hydrolysis of soda ash at the temperatures encountered with high operating pressures releases carbon dioxide into the steam, making it difficult to maintain an excess of carbonate and promoting corrosion in the condensate system. In some services, sodium carbonate in combination with the hydroxides and phosphates of sodium is used for hardness removal. A phosphate sludge is preferred since it is less adherent and more easily kept in suspension.

Silica may enter the system in the form of soluble compounds or as finely divided particles which are not removed by filtration. It dissolves in alkaline boiler waters and will, with unreacted calcium or magnesium hardness in the water, form an adherent scale. Under some conditions, it may produce complex scale-forming silicates with soluble or colloidal iron oxide (acmite) or alumina (analcite). The crystalline matrix of these deposits tends to trap sludge particles and contributes to the accumulation of scale on heated surfaces.

Silica also is soluble in steam, and its solubility increases rapidly at temperatures above 500°F (260°C). Thus it can be transported in a vapor phase into the turbine and deposited on the turbine blading. This characteristic necessitates the limiting of the silica concentration in the boiler water in order to avoid turbine deposits, and the limits, varying with operating pressure, range from about 10 ppm at 1,000 lb/in² (70 kgf/cm²) to 0.3 ppm at 2,500 lb/in² (176 kgf/cm²).

Silica is partially removed from raw water by the hot lime-soda softening process and can be completely removed by the evaporation of the makeup water. Soluble silica can be removed by demineralization, but in colloidal forms it may pass through the treating beds. The silica concentration in the boiler water can be controlled by blowdown.

Many operators of industrial boilers use the Chelant methods of water treatment. Chelants react with the residual divalent metal ions (calcium, magnesium, and iron) in the boiler water to form soluble complexes. The resultant soluble complexes are removed by use of continuous blowdown. One of the most popular methods uses the sodium salt of ethylenediaminetetraacetic acid (Na_4 EDTA). Chelant methods of treatment have been used in boilers operating at pressures as high as 1,500 lb/in² (105 kgf/cm²).

Table 9.2.5 Relationship of pH and Hydrogen-Ion Concentration

	pH	Hydrogen-ion concentration, gmol/L	
	0	1.0	10^0
	1	0.1	10^{-1}
	2	0.01	10^{-2}
Acid range	3	0.001	10^{-3}
	4	0.0001	10^{-4}
	5	0.00001	10^{-5}
	6	0.000001	10^{-6}
Neutral	7	0.000000,1	10^{-7}
	8	0.000000,01	10^{-8}
	9	0.000000,001	10^{-9}
	10	0.000000,000,1	10^{-10}
Alkaline range	11	0.000000,000,01	10^{-11}
	12	0.000000,000,001	10^{-12}
	13	0.000000,000,000,1	10^{-13}
	14	0.000000,000,000,01	10^{-14}

Table 9.2.6 Recommended Limits of Boiler-Water Concentration (ABMA)

Pressure at outlet of steam-generating unit, lb/in ² gage (× 0.07037 = kgf/cm ²)	Total solids, ppm	Total alkalinity, ppm	Suspended solids, ppm
0–300	3,500	700	300
301–450	3,000	600	250
451–600	2,500	500	150
601–750	2,000	400	100
751–900	1,500	300	60
901–1,000	1,250	250	40
1,001–1,500	1,000	200	20
1,501–2,000	750	150	10
2,001 and higher	500	100	5

The recommended limits of boiler-water concentration, as defined in the ABMA manual, are listed in Table 9.2.6. These data are not applicable to forced-flow once-through boilers. The total solids content can be determined by weighing the residue of a water sample which has been evaporated by dryness. The dissolved-solids content can be determined in a similar manner from a filtered sample, but for immediate determinations and control purposes, it can be quickly approximated by an electrical-conductivity measurement and the use of conversion factors previously established by comparisons with gravimetric determinations.

Solids concentration also can be controlled by intermittent or continuous blowdown. The amount of blowdown and the time interval between blows should be coordinated with operation and should consider or anticipate load changes, water conditioning, and chemical treatment.

In forced-flow once-through boilers, the impurities entering with the feedwater must leave with the steam or be deposited within the unit. Thus, such units require high-purity feedwater and the control of corrosion by volatile bases, such as ammonia, which will prevent or minimize deposits in the boiler unit or the turbine. Raw-water leakage into the system must be prevented, and the makeup must be evaporated or demineralized water.

When sampling water from high-pressure, high-temperature sources, cooling is required to prevent the flashing or selective loss of water vapor at atmospheric pressure. The approved methods for water sampling and analysis are discussed in the Annual Book of ASTM Standards, Part 23.

STEAM PURIFICATION

In drum-type boilers, using either natural or assisted circulation, a mixture of steam and water is delivered to the upper or steam drum where separation of the steam and water takes place and a water level is maintained. The water is recycled through downcomers to the heat-absorbing circuits, and the steam is discharged from the top of the drum for use as saturated steam or the supply to the superheater.

Separation of the steam and water by buoyant or gravitational force requires a relatively large cross-sectional area and, consequently, a low fluid velocity within the drum as well as an effective difference in the fluid densities, which decreases as pressure is increased. Steam entrainment in the recycled water impedes circulation; and water entrainment in the outlet steam transports dissolved or suspended particulate matter into the superheater, steam piping, and turbine, where particle deposition can cause overheating of the tubes or flow obstructions in the turbine blading with subsequent loss of capacity, efficiency, and dynamic balance.

Gravity separation of steam and water may be satisfactory in low-pressure, low-duty boilers. This type of separation can be augmented by the use of baffles which utilize a change in direction to throw out the water droplets, or by dry pipes which impose a pressure drop that promotes evaporation of the moisture and reduces the tendency of solids to deposit in the superheater.

In high-pressure boiler units, particularly those employing high evaporative ratings, a part of the circulating head can be utilized to

provide a separating force, many times greater than that of gravity, in centrifugal separating devices such as the cyclone steam separators shown in Fig. 9.2.38. These separators deliver steam-free water to the drum and downcomers, and discharge steam with a minimum of water entrainment. Secondary steam-and-water separation is accomplished by passing the steam at a low velocity through sinuously shaped passages between closely spaced corrugated plates, which provide a large surface area for intercepting entrained boiler-water particles. In modern high-capacity boilers, the steam leaving the steam drum contains less than 0.1 ppm of total solids.

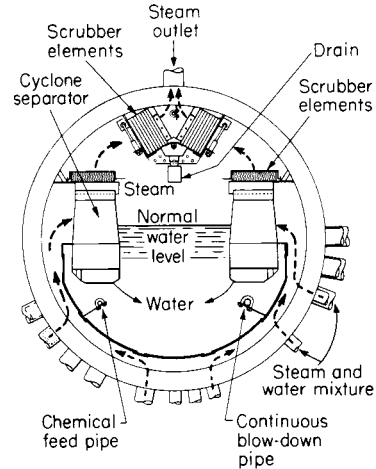

Fig. 9.2.38 Drum internal arrangement with cyclone steam separators and scrubber elements.

Mechanical steam separators do not prevent the transport of silica in a vapor solution. The amount of silica dissolved in the steam is dependent upon its concentration in the boiler water, and for a given concentration, the ratio of silica in the steam to the silica in the water increases rapidly with an increase in the operating pressure (see Fig. 9.2.39). Silica can be removed by steam washers which provide a large surface area for contact with the relatively pure feedwater and which reabsorb the silica and return it to the boiler-water system. Turbine deposits can be practically eliminated and the requirements of boiler blowdown materially reduced by the use of steam washers for steam purification. Steam washers are used to best advantage in medium-pressure boilers operating with large amounts of makeup water, particularly if the makeup water contains silica in an insoluble form.

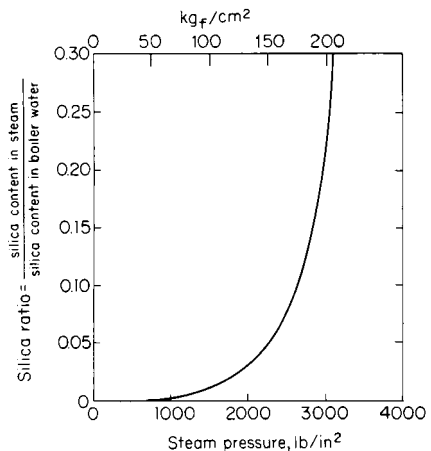

Fig. 9.2.39 Equilibrium relationship of silica ratio and operating pressure for a given concentration of silica in boiler water.

Impurities in the water entering a forced-flow once-through boiler leave with the steam unless they are deposited in the boiler unit. Therefore, the equivalent of steam purification must be accomplished by treatment of the feedwater before the water enters the boiler so as to prevent the accumulation of deposits in the boiler unit and the turbine. In the treatment, most of the feedwater, including the steam condensate, is passed through a mixed-bed demineralizer that removes suspended as well as dissolved impurities.

CARE OF BOILERS

The care of boilers is delineated in Section VII of the ASME Boiler and Pressure Vessel Code. Principal considerations include the initial preparation of new equipment for service; normal operation, including routine start-up and shutdown; emergency operations; inspection and maintenance; and idle storage. In all these phases, the handling of equipment is the responsibility of the operator, but recommendations and operating instructions supplied by the manufacturer should be thoroughly understood and followed.

The initial preparation of new boiler units for service, or of old equipment after completing major alterations or repairs, involves the removal of construction or foreign material from the setting and from the interior of pressure parts, hydrostatic testing and inspection for leaks, and the boiling out of the unit with a caustic solution for the removal of grease and other deposits in the steam-generating pressure parts. The boiler unit is fired at a low rate during boil-out. This procedure facilitates the desired slow drying of any refractories used in the setting. Boil-out pressure should be approximately 50 percent of normal operating pressure but should not exceed 600 lb/in² (42 kgf/cm²). During the boil-out period, ranging from 12 to 36 h, the unit is blown down periodically through all the blowdown connections so as to eject any sediment removed from the surfaces. The boil-out often is supplemented, particularly in high-pressure boilers, by inhibited-acid cleaning for the removal of mill scale.

It is general practice, following the boil-out, to reduce the concentration of boil-out chemicals to a satisfactory level for operation by blowing down and replenishing the amount of water blown down with fresh water. The pressure is then raised to test and set the safety valves to code requirements; the superheater and the steam piping are blown out to remove any foreign material; and the boiler is placed on the line for a period of low-load operation, during which the auxiliary equipment, controls, and interlocks are test-operated. After these operations, it is advisable to shut down, cool, and drain the boiler unit prior to a thorough internal and external inspection and any adjustments or modifications required to the equipment.

Normal operation involves the orderly start-up and shut-down of equipment and operation, under controlled conditions, to meet plant requirements. Statistics show that about 80 percent of the recorded furnace explosions occur during start-up and low-load operation, and particular care must be taken during such operations to prevent such explosions. The National Fire Protection Association's Committee on Boiler Furnace Explosions has prepared standards for the prevention of furnace explosions. These standards delineate the preferred sequence of starting fuel-burning equipment, the recommended minimum flame-monitoring equipment and safety interlocks, the recommended fuel-transport piping systems, the recommended purging procedures, and the procedures to be taken in the event of burner or furnace flame-out.

Normal operation also entails the maintenance of specified feedwater and boiler water conditioning, designed steam and metal temperatures, clean gas passages and heat-absorbing surfaces, and ash removal.

The rate of firing during start-up is limited by the allowable metal temperatures in the superheater and reheater until steam flow through the turbine is established. Then, after the steam flow is established, the temperatures and the temperature differentials in the various parts of the boiler and turbine control the permissible rate of firing.

Emergency operations are usually the direct result of abnormal conditions such as the failure of the feedwater supply, the rupture of a pressure part, the interruption of the fuel supply, the loss of air, or a

burner flame-out. Automatic safety interlocks usually are installed which trip the fuel supply and shut down the unit if these or other hazardous conditions are experienced. Abnormal operating conditions, which might become hazardous if allowed to persist, such as low (fuel-rich) or high (air-rich) air-fuel ratios or the failure of essential auxiliaries, require appropriate action to correct operating conditions. An operator who cannot correct an abnormal condition must determine whether operation can continue and, if not, must shut down the unit in the proper manner or activate the emergency trip through the automatic interlock system.

Inspection and maintenance should be performed during regularly scheduled outages. A list of the known items requiring repair or maintenance should be prepared before the outage and should be supplemented by any additional items noted in thorough inspection of the boiler and auxiliary equipment during the outage. A major item on the work list should be the maintenance of internal and external cleanliness. External cleaning is usually accomplished by water washing or air lancing. The internal surfaces of small boiler units are usually mechanically cleaned, but the large-capacity units are generally chemically cleaned. Under competent supervision, which can be obtained from several firms specializing in chemical cleaning, this method can be used with complete confidence for boilers of all sizes. The chemical-cleaning solution normally is composed of a 3 to 5 percent solution of hydrochloric acid, wetting and complexing agents for the removal of silica or other hard-to-remove deposits (such as iron and copper oxides), and a suitable inhibitor to prevent excessive chemical attack on the pressure parts of the boiler unit. Hydrochloric acid, however, should not be used for cleaning stainless-steel surfaces, since it can cause stress-corrosion cracking. Thus other organic or inorganic acids are used depending upon the type of material to be cleaned and the composition of the deposit to be removed.

The chemical cleaning of drum-type boilers involves filling the boiler [which has previously been uniformly heated to a temperature of about 175°F (79°C)] with the cleaning solution at 150 to 160°F (65 to 71°C) and allowing it to soak for 6 to 8 h or until samples of the solution show no appreciable further reduction in acid strength. The boiler should never be fired while it contains an acid solution, and open lights or other ignition sources must be prohibited in the area to avoid the ignition of the explosive gases, usually hydrogen, evolved during the cleaning operation. The unit is then drained and flushed several times, preferably under a nitrogen blanket, with neutral or slightly acidic water to remove the loosened deposits and to displace the acid solution and any corrosive gases. The flushing is followed by boil-out with an alkaline solution to neutralize any residual acid and to passivate the surfaces. The unit is then flushed with clean water to remove the remaining loose deposits, and it is inspected before being returned to service.

When chemically cleaning forced-flow once-through units, the solvent is continuously circulated through the unit for 4 to 6 h. Generally, the solvent is an inhibited solution of hydroxyacetic-formic acids at a temperature of 200°F (93°C).

Boiler units removed from service for long periods of time may be stored wet or dry. It is practically impossible to drain and dry modern high-pressure utility boilers completely with their complex furnace and superheater circuitry. Thus wet lay-up of the unit with water treated with 10 ppm ammonia and 200 ppm hydrazine is the best means of protection for both short- and long-term lay-up. If, however, dry storage is utilized, the system must be kept dry; and low humidity within the pressure parts and setting can be maintained by the use of trays of moisture-absorbing materials, such as silica gel or lime, which must be replenished at intervals to retain their effectiveness. When using either wet or dry storage, the system should be pressurized to a few pounds above atmospheric pressure with nitrogen gas.

CODES

The ASME Boiler and Pressure Vessel Code, initiated in 1914 and supplemented by continuing revisions, contains the basic rules for the safe design, the construction, and the materials for steam generating

units. Its legal status depends upon its adoption by state or municipal authority. The Code is administered by the National Board of Boiler and Pressure Vessel Inspectors. This organization also has established the "Recommended Rules for Repairs by Fusion Welding to Power Boilers and Unfired Pressure Vessels." The adoption of both codes has been widespread, and they form the basis for the pertinent legal requirements in all but a few localities throughout the country. The National Bureau of Casualty and Surety Underwriters' book titled "Synopsis of Boiler Rules and Regulations" lists the states and the communities having laws which govern the installation and the operation of steam boilers.

NUCLEAR BOILERS

(See also Sec. 9.8.)

Nuclear power boilers are usually identified by the primary fluid used as the reactor coolant. A number of coolants and system design concepts have been studied, but only three basic coolants have been used in U.S. power plants—liquid metals, gases, and water.

Most of the nuclear systems for commercial power production use water in some form as the primary coolant, principally the pressurized-water-reactor (PWR) and the boiling-water-reactor (BWR) systems. The preference for water as the reactor coolant is due to the fact that its physical, chemical, and thermodynamic characteristics are well known and materials and equipment are available for its handling and containment.

The steam-generating unit shown in Fig. 9.2.40 is typical of those used in PWR installations. In this design, hot primary fluid enters one side of the divided primary head, passes through the U-type tubes, and leaves through the primary outlet nozzle. Boiling takes place on the outside, or secondary side, of the tubes, and the steam-water mixture passes upward through the riser section and then the steam and water separators. The steam is discharged from the scrubbers into the outlet connection. The separated water flows downward, mixes with the incoming feedwater, and is then circulated downward through the annulus around the tube bundle to reenter the tube bundle at the bottom.

Generally, in units of this type, stainless-steel or Inconel tubes are used to minimize corrosion, the structural components are of carbon or

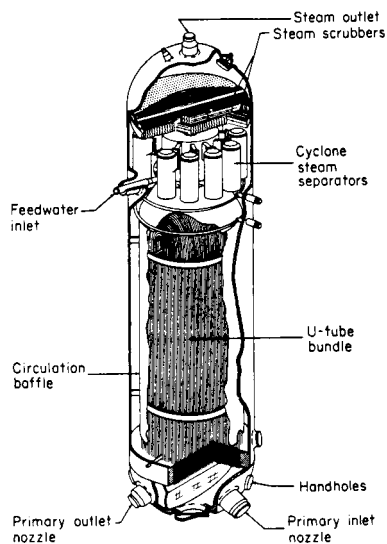

Fig. 9.2.40 Nuclear power boiler.

low-alloy steel, and the primary head and primary tube-sheet faces are completely clad with stainless steel or Inconel.

Design considerations are similar to those for fossil-fuel boiler units, but particular emphasis is placed upon possible hazards, codes and specifications, and system economics.

1. **Hazards.** In the design of nuclear systems, great consideration must be given to the damage and the loss of life that could result from an accident, and also the psychological effect of such an accident. Potential dangers that must be considered by the boiler designer include the following:

Radioactivity. The primary fluid and any materials transported in the primary passages may become radioactive from neutron bombardment. This radioactivity can hold at a high level for varying lengths of time, and since the radioactive products may be deposited anywhere in the primary system, the boiler designer must design the equipment for minimum exposure of personnel to radiation.

Chemical poisons. Some fission products are lethal, not only because they are radioactive but because they are chemically poisonous by both ingestion and inhalation. Personnel must be protected against exposure to these poisons.

Chemical reactions. In some nuclear systems, possible contact between the primary and secondary fluids could cause strong chemical reactions. Sodium and water, for example, react violently, yet sodium has been selected as the primary fluid in some systems because of its excellent nuclear properties and good heat-transfer and heat-transport characteristics. Therefore, steam generators in which sodium is used for the primary fluid must be designed so that direct contact between the sodium and the water is unlikely and so that the effects of such a contact, if one should occur, are minimized.

2. **Codes and specifications.** The requirements for safe design and fabrication are delineated in the ASME Boiler and Pressure Vessel Code, augmented by Special Code Cases. The special cases applying specifically to nuclear components establish design, inspection, and fabrication rules which are more stringent than those usually required for other types of equipment. The construction of commercial nuclear components is governed by the ASME Code, Section III, "Nuclear Power Plant Components" while that of equipment for military use is governed by special military specifications.

3. **Economics.** Basic design considerations of PWR and the BWR systems differ greatly from those of fossil-fuel systems. The temperature difference that produces the flow or transfer of heat between the primary and secondary water is dependent upon the difference in the pressures of the two fluids, and the hotter primary fluid is maintained at the higher pressure. Therefore, an optimized steam-generator design using a minimum amount of heat-absorbing surface should have the boiling secondary fluid on the outside of the tubes since a tube, or cylinder, can withstand greater internal pressures. This contrasts with fossil-fuel-fired water-tube boiler designs in which the boiling fluid is contained within the tubes.

Both internal and external heat-transfer coefficients are high in nuclear steam generators, and consequently, in most cases the tube metal and the fouling film coefficients control the overall rate of heat transfer. Thus tube diameters should be small and tube walls as thin as practical. Further, the water must be conditioned to minimize scale and sludge formations and, thus, fouling coefficients.

Primary-water systems are designed for relatively high pressures 1,200 to 2,500 lb/in² (84 to 176 kgf/cm²), and extremely compact systems are economically justified in the efforts to minimize the size and the weight of the steam generator, reactor, and other pressure vessels. Fluid-temperature differences are necessarily small when operating with the highest practical secondary-steam pressure; this tends to increase surface requirements and, consequently, the size of the steam generator.

9.3 STEAM ENGINES

Staff Contribution

REFERENCES: Ewing, "The Steam Engine and Other Engines," Cambridge. Ripper, "Steam Engine Theory and Practice," Longmans. Heck, "The Steam Engine and Turbine," Van Nostrand. Allen, "Uniflow, Back Pressure, and Steam Extraction Engines," Pitman. Peabody, "Valve Gears for Steam Engines," Wiley. Zeuner, "Treatise on Valve Gears," Spon. Spangler, "Valve Gears," Wiley. Dalby, "Valves and Valve Gear Mechanisms," Longmans.

EDITOR'S NOTE: Although largely relegated to history and nostalgia, small steam engines are still manufactured in the United States, primarily as replacement items. Steam locomotives in the United States cater only to the tourist trade; they are kept in repair and in service mainly with parts manufactured locally. The remaining steam locomotives in India are in the last stage of being phased out of service; all are scrapped and replaced by diesel, electric, or diesel-electric locomotives. China is still engaged in the manufacture of steam locomotives, and has based its railroad system on their continued use.

The reciprocating steam engine was the heart of the early industrial era. It dominated power generation for stationary and transportation service for more than a century until the development of the steam turbine and the internal-combustion engine. The mechanisms were numerous (see Patent Office listings), but practicality essentially standardized the positive-displacement, double-acting, piston and cylinder design in a vertical or horizontal configuration. These engines were heavy, cast-iron structures, e.g., 50 to 100 lb/hp; they had low piston speed (600 to 1,200 ft/min); long stroke (up to 6 ft); low turning speeds (50 to 500 r/min); steam conditions less than 300 lb/in² (dry saturated, or 100 to 200°F superheat); noncondensing or condensing (25 ± in Hg vacuum); sized from children's toys to 25,000 hp. Diversity of valve gear was an inventor's paradise with many suitable for reversible operation, as in locomotive, rolling-mill, and ship applications. Most of the machine elements known today, such as cylinders, piston rods, crossheads, connecting rods, crankshafts, flywheels, and governors, were developed in steam engines.

These engines utilize the expansive power of steam. Theoretically, the more the steam can be expanded in the engine cylinder, the better will be the economy. Practical losses, which occur in every steam engine, limit the expansion ratio and result in a minimum steam rate for a definite degree of expansion. Cylinder dimensions preclude the practical utilization of high-vacuum conditions because of the high specific volume (e.g., 339 ft³/lb dry and saturated at 2 inHg abs). The steam turbine can effectively utilize maximum vacuum.

WORK AND DIMENSIONS OF THE STEAM ENGINE

Thermodynamic principles define the limits of the conversion efficiency of heat into work (see Rankine and Carnot cycles, Sec. 4). In fact, the historical development of thermodynamic principles was primarily aimed in the nineteenth century at defining the thermal performance of steam engines and steam power plants. It can be said that the steam engine did more for thermodynamics than thermodynamics did for the steam engine. Steam tables and steam charts (e.g., temperature-entropy; enthalpy-entropy; and pressure-volume) are essential to evaluate theoretical and actual equipment performance.

The pressure-volume diagram, or indicator card, is of primary significance in both the design and operation of the reciprocating piston and cylinder mechanism—not only steam engines, but also internal-combustion engines, air compressors, and pumps. The utility of the p - v diagram is often lost in attempts to improve fluid-dynamic reciprocating mechanisms. The work and power are the consequence of the difference in pressure on the two sides of the piston, expressed as mean effective pressure (mep or p_m). This is applied to the cylinder dimensions and rotating speed in the "plan" equation

$$\text{hp} = \frac{p_m L a n}{33,000} \quad (9.3.1)$$

where p_m = mep, lb/in²; L = stroke, ft; a = effective piston area, in²; n = number of cycles completed per min; 33,000 = mechanical equivalent of horsepower, ft · lb/min, by definition.

A typical steam-engine indicator card is shown in Fig. 9.3.1, identifying the established nomenclature for the events of the cycle. Superimposed is a theoretical diagram, with expansion, but without clearance or compression. The terminal pressure controls the steam, or water, rate. The term "back pressure" is used for pressures above the atmosphere, while "condenser pressure" is used when engines operate with negative exhaust pressure. The volume ratio $v_f/v_h = R$ is called the **ratio of expansion**.

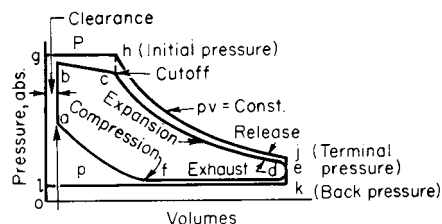

Fig. 9.3.1 Typical steam engine indicator diagram.

The average ordinate, or **mean effective pressure** p_m [applicable in Eq. (9.3.1)] for the ideal cycle diagram $ghjkl$ is

$$p_m = P(1 + \log_e R)/R - p \quad (9.3.2)$$

The expansion phase h to j of the cycle is **logarithmic** where $pv = \text{constant}$. It is not isothermal but reasonably approximates expansion (and compression) in actual engines where condensation and evaporation on cylinder walls, heads, pistons, and valves are cyclically recurrent.

The value of R is commonly around 4 in simple engines. It should increase as P increases and as p decreases, usually between 3 and 5. It should be higher in jacketed than in unjacketed engines. The efficiency of the engine depends largely on the value chosen for R . This is dictated by service requirements, e.g., load variation, load fluctuation, engine governing type (cutoff vs. throttle), overload capacity, steam cost, and economics. Efficiency, however, is not the sole requirement for all installations. The high starting torque of a steam locomotive dictates a valve gear that allows full-stroke admission of steam with zero expansion, a rectangular indicator card with consequent maximum p_m .

Figure 9.3.1 shows that the theoretical card has a larger area than the actual card. The value of p_m obtained from Eq. (9.3.2) must be multiplied by the **diagram factor** to obtain the actual p_m under the assumed conditions. This factor may have a value between 0.7 and 0.95. The actual p_m is obtained from the card drawn on the indicator drum under running conditions of the engine. The card area, graphically measured by a planimeter (see Sec. 16), is divided by the card length to get the average equivalent height of the card. The spring scale of the instrument, applied to this average height, gives the mean effective pressure actually obtaining within the engine cylinder. This value, when introduced in Eq. (9.3.1), gives the indicated horsepower (ihp) of the engine.

Losses in steam-engine cylinders are (1) incomplete expansion; (2) initial condensation; (3) throttling, affected by valve and port area; and (4) radiation, which can be considered constant. The point of best steam economy occurs with the p_m at which the total of all losses is a minimum.

Mechanical Efficiency and Shaft Output

$$\text{Brake horsepower (bhp)} = \text{ihp} \times \text{mechanical efficiency} \quad (9.3.3)$$

$$\text{Friction horsepower} = \text{ihp} - \text{bhp} \quad (9.3.4)$$

bhp	25	50	75	100
Friction hp	6	6	6	6
ihp	31	56	81	106
Mechanical efficiency, %	81	89.5	92.5	94

Figure 9.3.2 shows the effect of mechanical efficiency and generator efficiency on the steam rate of an engine-generator set, both as to relative magnitude and as to location of the minimum values.

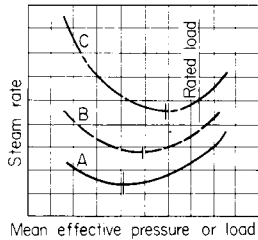

Fig. 9.3.2 Engine steam rate curves (a) at the steam cylinder, lb/(ihp·h); (b) at the engine shaft, lb/(bhp·h); (c) at the generator, lb/kWh.

Engine economy may be improved by a number of methods: (1) **separation of inlet and outlet ports**; (2) **steam jackets**, applied to cylinders and heads to keep surfaces hot and dry; (3) **multiple expansion**. Condensation losses are related to the temperature difference existing in the cylinder. Cylinders in series reduce this temperature difference and allow more complete overall expansion of the steam. Two, three, and four cylinders in series, as in **compound**-, **triple**-, and **quadruple-expansion** engines were common constructions, but the successive improvement is smaller for each additional stage. (4) **Superheating** gives the vapor the properties of a gas, reduces cylinder condensation, and necessitates decisive changes in engine design. The overall improvement in performance and water rate is so substantial that superheat is prevalent in practice. (5) The **uniflow** arrangement was the last great improvement in design (Figs. 9.3.3 and 9.3.4). Its high economy results from the high temperature of the residual steam at the end of compression. This temperature, aided by jackets, is higher than the live steam temperature, so that initial condensation is reduced to a negligible amount. For **condensing operation** the

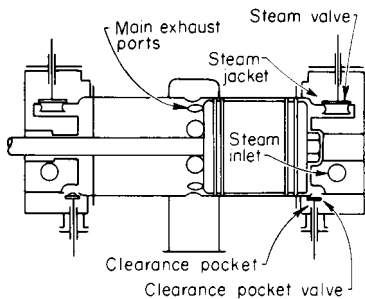

Fig. 9.3.3 Condensing uniflow engine cylinder, with clearance pockets.

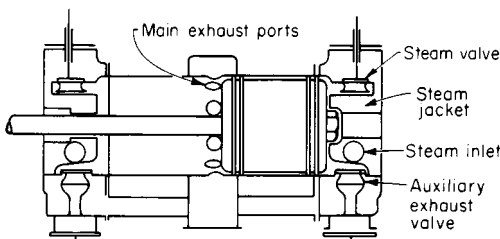

Fig. 9.3.4 Noncondensing uniflow engine cylinder, with auxiliary exhaust valves.

engines are built with steam valves only (two-valve type), Fig. 9.3.3. Clearance pockets are provided, with either hand-operated or automatic valves to permit operation with atmospheric exhaust or against back pressure. **Noncondensing uniflow** engines have, in addition, auxiliary exhaust valves to reduce the otherwise large clearance required (four-valve type). If back pressure is variable, exhaust-valve *gears* are designed to change the length of compression while the engine is in operation (Fig. 9.3.4).

Engine Steam (Water) Rates The efficiency of steam engines has generally been expressed in terms of pounds of steam per horsepower-hour. The term water rate was frequently used because of the convenient accuracy in weighing liquid water in the condensing plant. Figure 9.3.5 shows, on a percentage basis, two types of performance curves, one in

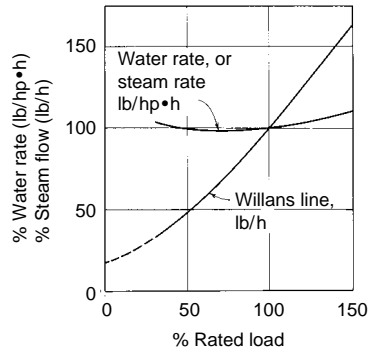

Fig. 9.3.5 Actual steam (water) rate, lb/(hp·h), and Willans line, lb/h, for a noncondensing uniflow engine, percentage basis.

lb/hph and the other in lb/h. The latter is identified as the "total steam" or **Willans line** and is straight for an engine with fixed cutoff and variable initial pressure. Figure 9.3.6 reflects the impact of steam pressure and superheat on the steam consumption of a condensing uniflow engine.

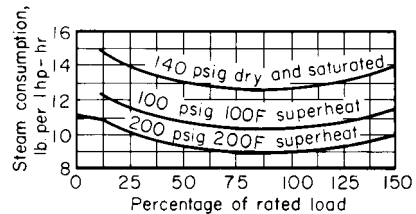

Fig. 9.3.6 Steam consumption of uniflow engine with 27.5-in vacuum.

The **Rankine cycle** (see Sec. 4) is the accepted thermodynamic standard for comparing the performance of steam prime movers (engines and turbines). It is predicated on complete isentropic (reversible adiabatic) expansion of the steam from initial to back pressure. It is shown on the *p-v* basis in Fig. 9.3.7. There is no compression or clearance. The water rate of this cycle is most conveniently calculated by use of the Mollier chart (Sec. 4) where

$$\text{Rankine steam rate} = 2,545 / (h_1 - h_2) \quad \text{lb/hph} \quad (9.3.5)$$

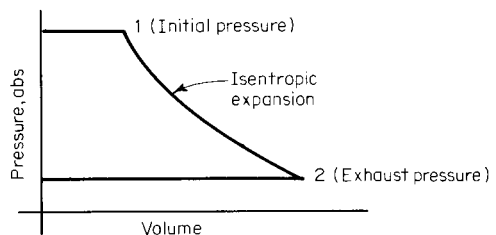

Fig. 9.3.7 Rankine cycle, *p-v* diagram.

and h_1 and h_2 are the initial and exhaust enthalpies, Btu/lb (constant entropy). The lowest point of the actual steam-rate curve (Fig. 9.3.6) is usually referred to as the Rankine rate, and the ratio of Rankine rate to actual rate is the **Rankine efficiency ratio (RER)**. This ratio may vary from 0.5 to 0.9, depending on the type of engine.

When clearance, compression, and incomplete expansion are introduced, the methods of Sec. 4 should be used to evaluate steam rate. This involves steam tables and charts to find the net work of the indicator card from the positive and negative areas of the several component phases. Figure 9.3.8 shows a theoretical steam-rate curve, computed by such methods, together with the actual test curve for the engine.

Engine Details Valves and valve-gear types range from the simplest D slide to gridiron, double-slide (Meyer or Rider), rocking, piston, releasing and nonreleasing Corliss, and poppet.

Volumetric clearance should be made as small as possible. Slide and piston valves bring clearance volumes to 12 to 15 percent, Corliss valves 6 to 10 percent, and poppet valves 4 to 8 percent.

Valve and Port Sizes Flow area of valves and cross section of ports are usually determined by port area = AS/C in², where A is net piston area, in², S is mean piston speed, ft/min, and C is a constant, ft/min. Values of C are approximately 9,000 to 15,000 ft/min for inlet and 6,000 to 7,000 ft/min for outlet. Small valves and ports represent lost work.

Superheated Steam With high-temperature steam, the cylinder and

parts design must allow for free expansion. Poppet and piston-valve cylinders can easily meet these requirements. The orthodox type of Corliss cylinder, however, is not suitable for highly superheated steam.

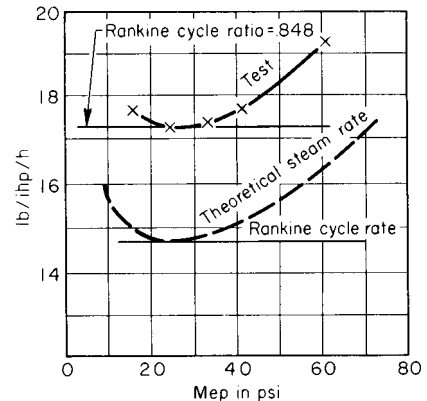

Fig. 9.3.8 Theoretical and test steam rate curves. Uniflow engine 20 × 24 at 200 r/min; throttle conditions 150 lb/in² saturated steam; exhaust to atmosphere.

9.4 STEAM TURBINES

by Frederick G. Bailly

REFERENCES: Stodola, "Steam and Gas Turbines," trans. by L. C. Loewenstein, McGraw-Hill. Bartlett, "Steam Turbine Performance and Economics," McGraw-Hill. Warren, Development of Steam Turbines for Main Propulsion of High-Powered Combatant Ships, *Trans. Soc. Naval Architects Marine Engrs.*, 1946. Newman, Modern Extraction Turbines, *Power Plant Eng.*, Jan.–Apr., 1945. Salisbury, "Steam Turbines and Their Cycles," Wiley. Campbell and Heckman, Tangential Vibration of Steam Turbine Buckets, *Trans. ASME*, 47, 1925, pp. 643–671. Campbell, Protection of Steam Turbine Disk Wheels from Axial Vibration, *Trans. ASME*, 46, 1924, pp. 31–139. Deak and Baird, A Procedure for Calculating the Packet Frequencies of Steam Turbine Exhaust Blades, *Trans. ASME*, 85, series A, Oct. 1963.

Steam turbines have established a wide usefulness as prime movers, and are manufactured in many different forms and arrangements. They are used to drive many different types of apparatus, e.g., electric generators, pumps, compressors, and for driving ship propellers, through suitable gears. When designed for variable-speed operation, a turbine may be operated over a considerable speed range, which may be of advantage in many applications. Steam turbines range in output capacity from a few horsepower to over 1,300 MW. The largest ones are used for generator drive in central power stations.

Turbines are classified descriptively in various ways.

1. **By steam supply and exhaust conditions**, e.g., condensing, noncondensing, automatic extraction, mixed pressure (in which steam is supplied from more than one source at more than one pressure), regenerative extractions, reheat.

2. **By casing or shaft arrangement**, e.g., single casing, tandem compound (two or more casings with the shaft coupled together in line), cross-compound (two or more shafts not in line, often at different speeds).

3. **By number of exhaust stages in parallel** as regards steam flow, e.g., two-flow, four-flow, six-flow.

4. **By details of stage design**, e.g., impulse or reaction.

5. **By direction of steam flow** in the turbine, e.g., axial flow, radial flow, tangential flow. In this country, radial-flow steam turbines have

not been used; there are quite a few such machines abroad. Axial-flow units predominate; some small turbines in this country operate on the tangential-flow principle.

6. **Whether single-stage or multistage**. Small turbines, or those designed for small energy drop, may have only one stage; larger units are always multistage.

7. **By type of driven apparatus**, e.g., generator, mechanical, or ship drive.

8. **By nature of steam supply**, e.g., fossil-fuel-fired boiler, or light-water nuclear reactor.

Any particular turbine unit may be described under one or more of these classifications, e.g., a single-casing, condensing, regenerative extraction fossil unit, or a tandem-compound, three-casing, four-flow steam-reheat nuclear unit.

Turbine-Stage Design A turbine stage consists of a **stationary set of blades**, often called **nozzles**, and a moving set adjacent thereto, called **buckets**, or **rotor blades**. These stationary and rotating blades act together to allow the steam flow to do work on the rotor, which can be transmitted to the **load** through the **shaft** on which the rotor assembly is carried. Classical turbine-stage design recognized two distinct designs of turbine stage, "impulse" and "reaction" (see classification 4 above). In the **impulse** stage, the total pressure drop for the stage is taken across the nozzles or stationary element, the flow through the buckets or rotor blades then being substantially at constant static pressure. This may be extended to include flow through an additional set of stationary "intermediate" blades and another row of buckets, or rotor blades (Curtis and two row stages). See velocity diagrams, Figs. 9.4.1 and 9.4.2.

In the **reaction** stage, the total pressure drop assigned to the stage is divided equally between the stationary blades and the rotor blades, giving rise to a velocity diagram, as shown in Fig. 9.4.3. As can be seen, there arises a marked difference in the shapes of the rotor blades in the two classical designs; the impulse buckets do much more turning of the stream; the reaction-bucket shape is more nearly the same as the nozzle-blade shape.

Fluid flow theory recognizes that only in rare cases can an axial-flow turbine stage be either pure impulse or pure reaction. The annulus following the nozzle exit is filled with steam flowing with a high tangential velocity, i.e., a vortex, confined between inner and outer boundaries,

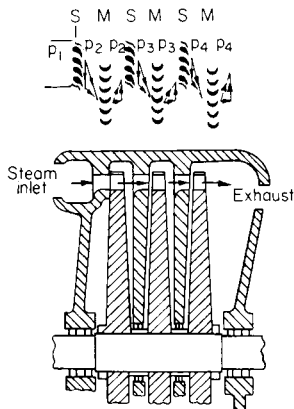

Fig. 9.4.1 Impulse turbine with single-velocity stages.

and for equilibrium to exist, there must be a gradient in static pressure from a lower-than-average value at the inner boundary to a higher-than-average value at the outer boundary. The amount of this depends upon the boundary radius ratio R_{outer}/R_{inner} . Thus only for a radius ratio near

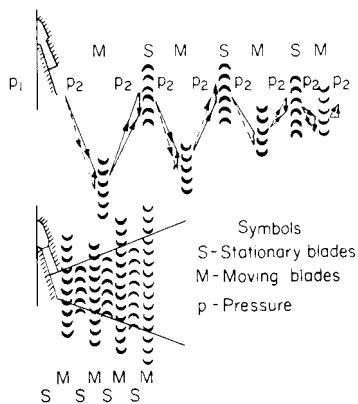

Fig. 9.4.2 Impulse turbine with multivelocity stages.

1.0 (small-height blades) can it be said that any one pressure condition exists for the stage. All axial-flow turbine stages of larger radius tend to be more nearly impulse at the inner diameter and more nearly reaction at the outer diameter.

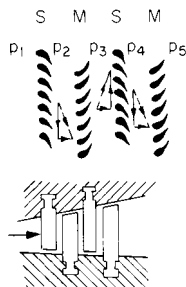

Fig. 9.4.3 Reaction turbine.

The designers of multistage steam turbines have continued to refine the efficiency of their steam paths over the years. For example, the 1950s saw the broad introduction of **twisted free-vortex staging**. Vane profiles have been improved since the 1950s by drawing on developments made in their aerodynamic laboratories and those of others. Complex computational fluid-dynamics computer codes based on true three-dimensional formulations of the inviscid Euler and viscous Navier-Stokes equations, and the supercomputers on which to run them, have recently become available. Manufacturing technology advancement permits the creation of steam-path components of almost any desired three-dimensional configuration. The result has been the introduction of **controlled-vortex staging** in the 1990s, in which the flow is biased toward the more efficient midsection of the blade, and secondary flow and profile losses are minimized by refinement in nozzle and bucket profiles.

Differences in basic mechanical construction of axial-flow turbine stages exist. Generally, the reaction type of turbine has continued as in the past with a “drum rotor” and stationary blades fixed in the casing, while the impulse type continues as a “diaphragm-and-wheel” construction. However, the mechanical construction bears no fixed relation to the degree of impulse or reaction adopted in the blading design. Designers employ the mechanical construction which they deem suitable for best reliability and efficiency.

An impulse stage, when employed for the first expansion, permits nozzle group control, i.e., steam admission to each group, opening and closing, successively, in response to load changes. This improves the efficiency at low loads through the reduction of the loss due to throttling.

A greater enthalpy drop can be employed per stage with the impulse element, particularly in the case of multivelocity elements, thus reducing the number of stages in a turbine. This is of special importance in the first expansion if the nozzle chamber is not integral with the turbine casing, so that the casing is not subjected to the initial steam conditions. If turbine elements of equal blade speed could have equal efficiency, one 2 row impulse element would equal four 1 row impulse elements or 16 rows (8 pairs) of reaction elements.

General Advantages of Steam Turbines Compared with reciprocating engines steam turbines require less floor space, lighter foundations, and less attendance; have a lower lubricating-oil consumption, with no internal lubrication, the exhaust steam being free from oil; have no reciprocating masses with their resulting vibrations; have uniform torque; have no rubbing parts excepting the bearings; have great overload capacity, great reliability, low maintenance cost, and excellent regulation; are capable of operating with higher steam temperature and of expanding to lower exhaust pressure than the reciprocating steam engine. Their efficiencies may be as good as steam engines for small powers, and much better at large capacities. Single units can be built of greater capacity than can any other type of prime mover. Small turbines cost about the same as reciprocating engines; larger turbines cost much less than corresponding sizes of reciprocating engines, and they can be built in capacities never reached by reciprocating engines. Combustion-gas turbines possess many of the advantages of steam turbines but are not available in ratings much exceeding 175 and 225 MW for 60- and 50-Hz service, respectively.

STEAM FLOW THROUGH NOZZLES AND BUCKETS IN IMPULSE TURBINES

Nozzles For the general treatment of the flow of steam and for maximum weight of flow of saturated steam, see Sec. 4.

The **theoretical work** obtainable from the expansion of 1 lb of steam is equal to the enthalpy drop in isentropic expansion $h_1 - h_{s2}$, in Btu/lb, and the spouting velocity in $223.8 \sqrt{h_1 - h_{s2}}$ ft/s ($m/s = 44.7 \sqrt{h_1' - h_{s2}'}$, where h' is in kJ/kg). The actual expansion is not isentropic but follows a path such as $h_1 h_2$ on the enthalpy-entropy diagram (Fig. 9.4.4), and the available work becomes $h_1 - h_2$.

The **nozzle efficiency** is $(h_1 - h_2)/(h_1 - h_{s2})$.

The required **throat area** of the nozzle is $A_t = Wv_t/V_t$, and the **mouth**

area is $A_m = Wv_m/V_m$, where v is specific volume, V is velocity, and the subscripts relate to throat and mouth, respectively.

In the case of a subcritical pressure ratio, throat and mouth conditions will coincide; with a supercritical pressure ratio, the mouth area will be

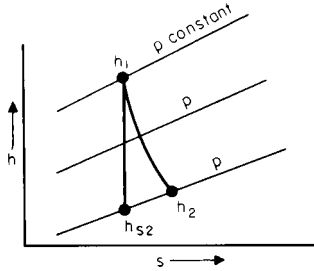

Fig. 9.4.4 Enthalpy-entropy diagram.

larger than the throat area. For **nozzle velocity coefficients** based on tests, see Keenan and Kraft, *Trans. ASME*, 71, 1949, pp. 773–787. The **bucket-velocity coefficient** is the ratio of the average exit velocity from the bucket divided by the velocity equivalent of the total energy available to the bucket, i.e., the sum of inlet-velocity energy and pressure-drop energy. Typical values of tests on impulse buckets are shown in Fig. 9.4.5, when the bucket inlet angle is 3 to 5° larger than the exit angle. These are for subsonic flow. Reaction buckets can have the same coefficients as nozzles. For intermediate cases between pure impulse and pure reaction, interpolate between the values for these limiting cases.

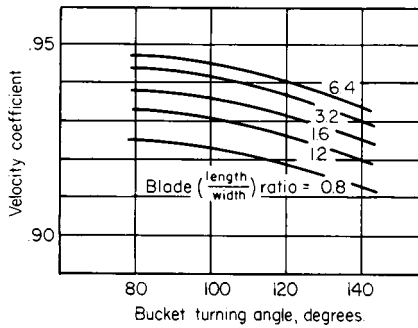

Fig. 9.4.5 Impulse-bucket velocity coefficients.

If, in the velocity diagram for a usual turbine stage, V_1 = actual nozzle exit velocity, V_2 = bucket relative entrance velocity, V_3 = bucket relative exit velocity, V_4 = absolute leaving velocity, V_0 = velocity corresponding to total stage available energy, then the **diagram efficiency** is $(V_1^2 - V_2^2 + V_3^2 - V_4^2)/V_0^2$.

Diagram efficiencies calculated with nozzle and bucket coefficients given above will be higher than the efficiencies derived by turbine tests, because of losses not existing in stationary tests of nozzles and buckets.

For supersonic bucket velocities, the impulse bucket-velocity coefficient is lower by the factors in Table 9.4.1.

Turbine Stage Efficiency Single-row stages of short blade length have relatively lower efficiency, owing to inner and outer sidewall losses; stages with longer blades are therefore higher in efficiency. Figure 9.4.6 shows typical values of stage efficiency for single-row stages, plotted against the wheel-speed steam-speed ratio, with pitch diam, inches/nozzle area, square inches, as a parameter. These curves reflect the net total of losses: (1) friction losses in nozzles (stationary

blades); (2) friction losses in buckets (rotor blades); (3) rotation loss of rotor; (4) leakage loss between inner circumference of stationary element and rotor; (5) leakage loss between tip of rotor blades and casing; (6) moisture and supersaturation losses, if steam is wet (not included in curves of Fig. 9.4.6).

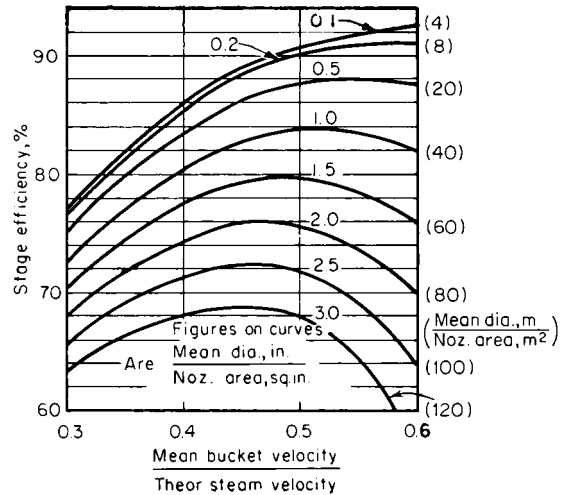

Fig. 9.4.6 Turbine single-row stage efficiency.

Nozzles and bucket friction losses are minimized by good aerodynamic design and by increasing **aspect ratio** (blade length/steam passage width). Rotation losses depend upon disk or rotor dimensions and surrounding stationary parts. Exact values for rotation loss depend on several factors; the following formulas may be relied upon for all usual purposes:

$$L_d = 0.042D^2w(U/100)^{2.9} = (1.4 \times 10^{-12})(D')^2w'(U')^{2.9}$$

$$L_b = 0.187Dwh^{1.25}(U/100)^{2.9}$$

$$= 3.34 \times 10^{-11}D'w'(h')^{1.25}(U')^{2.9}$$

where L_d = rotation loss of disk carrying buckets, kW; L_b = rotation loss of one row of buckets, kW; U = wheel speed at pitch diameter, ft/s; U' , m/s; D = pitch diameter (at center line of nozzle), ft; D' , mm; w = density of steam, lb/ft³; w' , kg/m³; h = mean bucket height, in; h' , mm. L_b must be figured for each row of buckets. L_d plus the sum of the values of L_b gives the total rotation loss in kilowatts for dry saturated steam. The formula for L_b is approximate.

Leakage loss of steam between inner circumference of stationary element and rotor is minimized by maintaining minimum practical clearance and by use of labyrinth packings (see Figs. 9.4.14 and 9.4.15 and accompanying text). Leakage loss of steam between tip of rotor blades and casing is similar to that through labyrinths between shaft and stationary parts; the magnitude depends upon the clearance area and the amount of reaction; other things being equal, the larger the percentage of reaction, the larger the leakage (see Fig. 9.4.9). Thus designers often employ considerable amounts of reaction in stages with long blades where such losses are small; this improves the net efficiency. In stages with short blades, the best net efficiency obtains with near impulse design. The curves in Fig. 9.4.6 reflect the effects of these practices.

The presence of moisture in the steam causes extra losses. These are probably mainly due to three factors:

1. Effect of supersaturation; i.e., the steam in expanding rapidly does not remain in equilibrium but tends to be more or less supercooled; thus less than theoretical equilibrium energy is available.

2. The presence of water drops increases friction losses in the steam itself.

3. Water drops tend to move more slowly than the vapor; they strike the rotor blades at unfavorable velocities and exert a braking effect.

Table 9.4.1 Impulse Bucket-Velocity Coefficient Factors

Mach no.	< 1.0	1.2	1.3	1.5	1.75	2.0
Factor	1.0	0.997	0.995	0.978	0.928	0.816

Figure 9.4.7 gives correction factors which may be applied to the values from Fig. 9.4.6 to arrive at stage efficiencies in the "wet" region. Curves are identified by initial superheat, °F, or by initial quality, percent.

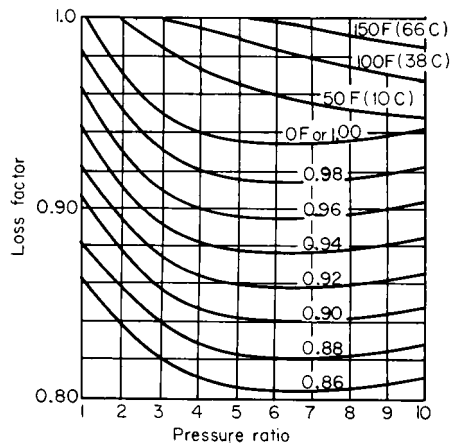

Fig. 9.4.7 Supersaturation and moisture loss.

Two-row stages, with one set of nozzles, have lower basic efficiency than single-row stages; they are useful for the first, or governing, stage in small to medium units. They are no longer employed in large central station designs. The approximate relative efficiency level of these stages is shown in Fig. 9.4.9.

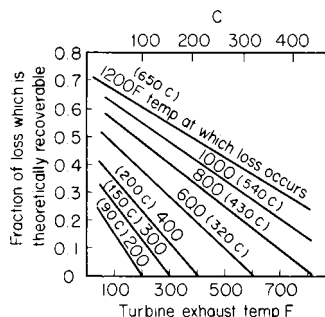

Fig. 9.4.8 Energy regain chart.

The losses occurring in a turbine stage are partially recoverable in succeeding stages in a multistage turbine because the energy available to succeeding stages is increased above that resulting from isentropic expansion. The amount of this factor depends upon the temperature at which the loss takes place, and the turbine exhaust temperature. Values for the reheat or energy-regain factor are shown in Fig. 9.4.8.

Turbine Steam-Flow Requirements The steam flow required by a turbine is related to its power output and steam conditions by the following expressions:

$$\text{Flow, lb/h} = (\text{TSR/efficiency}) \times \text{power output, hp or kW}$$

where TSR = theoretical steam rate, lb/(hp · h) = 2,545/available energy, Btu/lb, or TSR, lb/kWh = 3,412.14/available energy, Btu/lb.

Values of TSR are given in tables or may be calculated. In case of mixed-pressure or extraction turbines, the various sections of the turbine where flows are added or subtracted must be treated separately.

Turbine Steam-Path Design The basic quantities required for this are the steam conditions (i.e., inlet pressure and temperature and exhaust pressure), the required flow (see above), and the turbine speed. The latter is often fixed by the requirements of the driven machine; if not, the choice of speed by the designer is based upon experience, and

factors such as space or weight limitations, efficiency requirements, stress limits, or required exhaust area. Often several preliminary layouts are needed to arrive at the best design. If it appears that a single stage will suffice, the problem is simple, since the entire available energy is allotted to the one stage. If a multistage machine is required, the total available energy must be divided properly between the various stages.

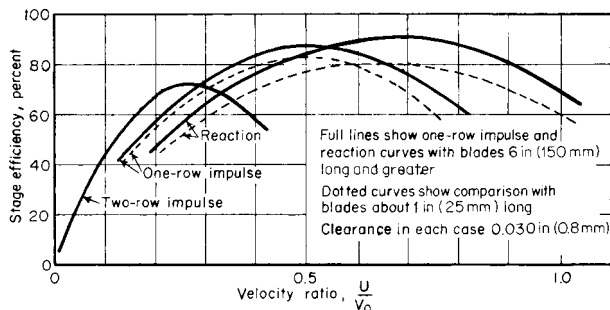

Fig. 9.4.9 Variation of the efficiency of turbine elements with velocity ratio.

For a given wheel-speed/steam-speed ratio, the energy to be allotted to the stage is directly proportional to the square of the product ($r/\text{min} \times D$), D being the rotor mean diameter. If available energy AE is in Btu/lb, D , in, and velocity ratio, 0.50, then

$$AE = (r/\text{min} \times D)^2 / (6.57 \times 10^8)$$

The sum of the AE values per stage for all the stages must equal the total energy on the turbine, which is greater than the isentropic available energy by the amount of the reheat factor.

Having determined the energy to be assigned to each stage, the steam pressure in each stage is fixed, and this, together with the enthalpy determined from the efficiency of the machine from inlet, determines the steam specific volume. The velocity ratio and the degree of reaction decided upon fix the velocity diagram, from which the velocities through the stationary and rotating blades are determined. With the flow Q , lb/h, the velocity V , ft/s, and the volume v , ft³/lb, determined, theoretical areas required are given by

$$A = Qv / (25V) \quad \text{in}^2$$

The actual area required will be larger than theoretical because of friction losses; a value of 0.98 for nozzle flow coefficient is reasonable.

There is no fixed criterion for the number of stages to be used in a steam-turbine design, and experienced designers differ in the number they will choose for any particular design. The stage velocity ratio, the mean diameter, and often the r/min are subject to judgment, bearing in mind the general relationships shown in Figs. 9.4.6, 9.4.7, and 9.4.8. Cross-compound arrangements are possible, allowing higher speed for the high-pressure section, where steam volume flow is smaller, and a lower speed for the low-pressure section, where the final exhaust area desired may require long blades on a large diameter.

A detailed calculation of the efficiencies and energy outputs of each stage can be summed up to the total "internal used energy" of the turbine, which, when divided by the isentropic available energy, results in an "internal efficiency." Then, account must be taken of other losses to arrive at the turbine overall efficiency. These losses are

1. Exhaust loss, i.e., the kinetic energy corresponding to the absolute velocity of the steam leaving the last stage, plus the pressure drop through the exhaust connection to the turbine outlet flange, where exhaust pressure is by custom measured as a static pressure.
2. Pressure drops through interconnecting piping if turbine has more than one casing
3. Shaft end-packing leakages
4. Valve-stem leakages, if any
5. Inlet-valve and intermediate-valve pressure-drop losses
6. Bearing, oil-pump, and coupling power losses

7. If the turbine drives a generator or gear, the losses of these elements

LOW-PRESSURE ELEMENTS OF TURBINES

In condensing turbines expanding to high vacuum, the steam increases in specific volume as it passes through the stages, exhausting at about 1,000 times the inlet volume. The increase in specific volume from stage to stage is greatest in the latter few stages, which are commonly designed for pressure ratios of about 2:1. Considerations of efficiency and economics dictate providing reasonably low interstage steam velocity in these stages, and reasonable leaving loss from the last-stage blades. These requirements are satisfied by providing a steam path whose cross-sectional area increases in proportion to the specific volume. The area increase may be achieved by increasing blading length, by increasing the mean diameter of the steam path, by arranging the last expansions in multiple flow, or by some combination of two or more. The relatively small single casing unit of Fig. 9.4.10 is provided with increasing area by the first two techniques.

The ratio of the last-stage blade height to the mean diameter of the steam path may be as high as 0.35 in the last stage of large central station units. With such a ratio, there is a variation in blade velocity between the inner and the outer radii of the steam path that cannot be properly satisfied by any one steam velocity. Losses incidental to this may be minimized or eliminated by providing blades with warped surfaces, the sections at the inner radius partaking of impulse form with relatively small inlet angles, and those at the outer radius of reaction form with large inlet angles. The longest last-stage blades in service today have tips whose speed exceeds sonic velocity. Many are of transonic design employing subsonic profiles toward the inner radius, blending into supersonic profiles at the tip.

Among the methods of obtaining increased low-pressure blade areas through multiple flowing are:

1. A single-casing turbine with the last elements arranged for double flow.
2. The steam expansion divided between two casings, coupled in tandem, and driving a single main generator, the low-pressure casing

being arranged for double flow. This arrangement is commonly extended to provide tandem-compound turbines with four and six exhaust ends. Figure 9.4.11 illustrates the application of a double-flow low-pressure casing to a unit of medium rating.

3. Cross-compound turbines, in which the steam expansion is divided between two or more separate casings driving separate generators, electrically synchronized. The low-pressure casings are usually double-flow and can be arranged so as to provide two, four, or six exhaust ends. This system permits the turbine elements to be operated at different speeds, selected as appropriate to the respective steam volumes. It lends itself to geared applications, such as marine propulsion machinery, when two or more pinions of different diameters and speeds drive a single-output gear wheel.

4. Divided-flow turbines in which steam expands in a series of elements in a single flow to a point where the flow is divided, with, perhaps, one-third continuing expansion within the same casing to condenser pressure, the remaining two-thirds expanding to condenser pressure in a separate double-flow casing. This construction has been used to provide triple-flow exhaust ends.

The **leaving loss** at the exit from the last row of blades is $V_{c2}^2/50,100$ Btu/lb of steam, where V_{c2} is the absolute terminal velocity in feet per second [or $(V'_{c2})^2/2,000$ kJ/kg, where V'_{c2} is in m/s]. The presence of moisture in the steam causes **moisture loss**. The acceleration of moisture particles is less as the density of the steam decreases; hence the difference between the velocities of the particles and the steam increases. As indicated in Fig. 9.4.12, with steam velocity, V_{s1} and moisture velocity V_m leaving the stationary blades and with bucket velocity V_b , the velocities relative to the moving blades of the steam are V_{c1} and of the moisture V_{m1} . The component V_{m2} of the moisture relative to the moving blades is opposite to the direction of their motion and is proportional to the force acting on the back of the blades, needed to accelerate the water to blade speed, and results in negative work. This negative work can be calculated when the weight of moisture per pound of steam and V_m are known. The results of many tests indicate that the *efficiency of a stage is reduced about 1 percent for each 1 percent moisture present in the steam.*

The presence of moisture particles will result in erosion of the blades

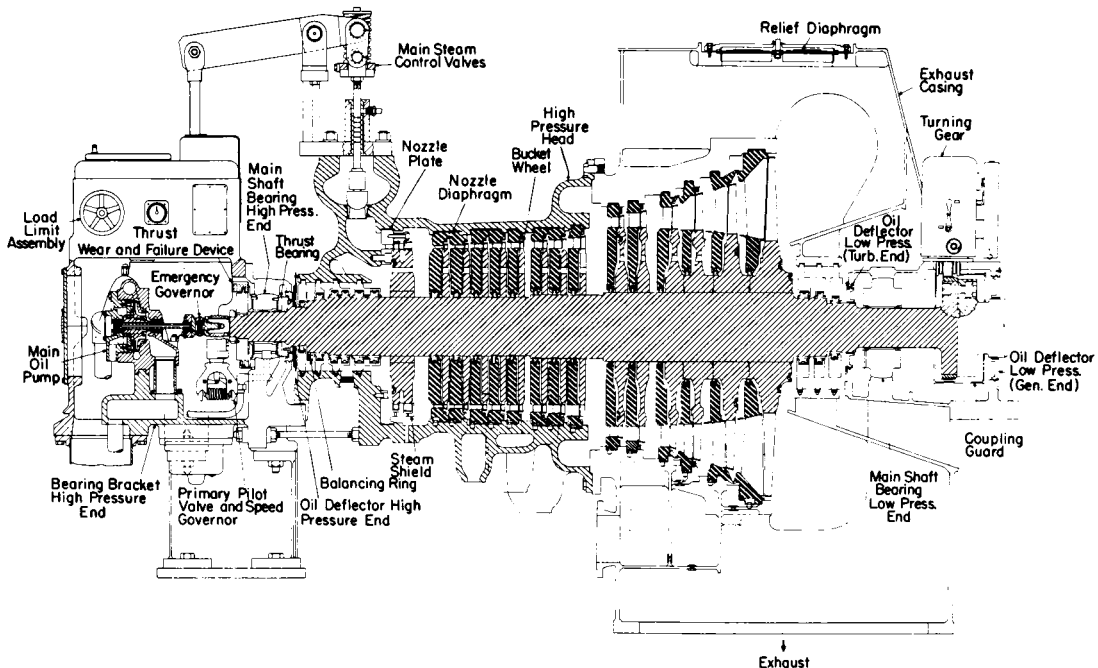

Fig. 9.4.10 Cross section of a multistage impulse condensing turbine rated at 30,000 kW. (General Electric Co.)

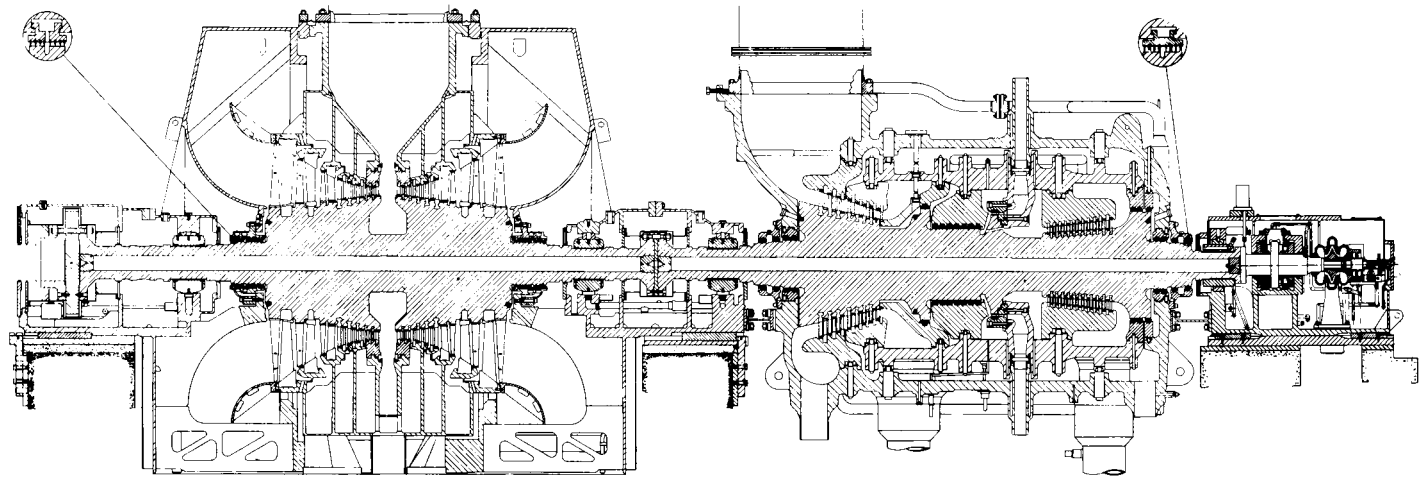

Fig. 9.4.11 Cross section of a 160,000-kW tandem-compound, double-flow reheat turbine. (Westinghouse Electric Corp.)

along their inlet edges if V_{m1} is too large—unless the moisture content is very small. The rate of erosion is reduced by using materials of inherently high erosion resistance, or protective shielding of hardened materials along the inlet edge. Attached Stellite shields and thermally hardened edges are commonly employed. Protective materials and processes are carefully chosen to minimize the possibility of corrosion.

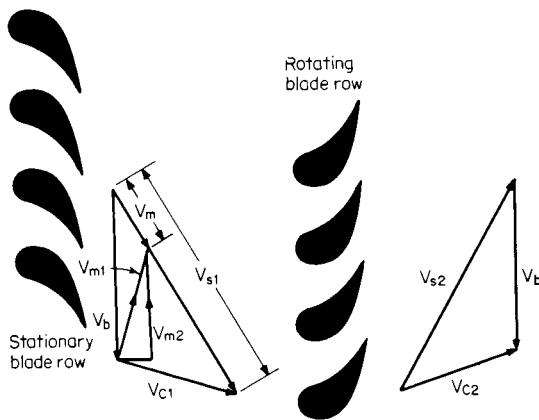

Fig. 9.4.12 Velocity of steam and of the moisture in steam.

Experience with the usual 12-chrome alloy bucket steels indicates that a threshold velocity exists at about $V_b = 900$ ft/s (270 m/s), below which impact erosion does not normally occur. With alloys specifically selected for their erosion resistance and with Stellite shields, satisfactory service has been obtained with values of V_b in excess of 1,900 ft/s (580 m/s). Centrifugal stress limits the application of steel blades to a tip velocity of about 2,000 ft/s (610 m/s). Titanium alloys provide high strength, low density (and hence low centrifugal stress), combined with excellent inherent moisture erosion resistance. Titanium bucket designs are available with a tip speed of 2,200 ft/s (670 m/s), without the need for separate erosion protection shielding. The severity of erosion penetration is dependent upon the thermodynamic properties of the stage and the effectiveness of reducing moisture content by means of interstage collection and drainage as well.

Rotative Speed The speed selected greatly influences weight and cost. With two geometrically similar turbines, one having twice the linear dimensions of the other, the steampath areas of the larger, and hence its capacity, would be 4 times and its weight 8 times as great as those of the smaller. The weight per unit of capacity with similar machines increases inversely as the speed with strict geometrical similarity. For this reason, the highest possible low-pressure blade speeds and r/min are selected. Machines of different speeds are not usually made strictly geometrically similar, and the reduction of specific weight is not so rapid as the above rule would indicate. With large-capacity turbines, blade speeds, at the outer radius, can reach 2,200 ft/s (670 m/s). With high speeds and small dimensions, the turbine can operate with higher steam temperature and greater temperature fluctuations because of lighter casing walls and less mass of rotor; the amount of distortion is less with more uniform heating; the turbine can be heated and put in service more quickly; space requirements are less; and dynamic loadings on foundations are less.

Balancing (see Secs. 3 and 5) With a rotor, or a component of a rotor, of relatively short axial length (such as a disk), static balancing may suffice. Single bodies of more than half the diameter in axial length are usually dynamically balanced by the use of balancing machines. The balancing may be done at less than the running speed, since a bladed turbine rotor cannot be rotated in air at a speed approaching the running speed, or at high speed in an evacuated spin facility, or with a combination of both. Balance at full speed may not be satisfactory unless the balance weights are applied at points diametrically opposite the errors in balance, so that balance corrections must frequently be provided along

the length of the rotor. Five balance planes are commonly used for the rotors of large central-station turbines, of which three are in the rotor body between bearings and two are in the overhung couplings.

Unsatisfactory operation of turbine rotors in service, resembling a simple unbalance, may be caused by nonuniform material or nonuniform heating of the rotor. The latter may be caused by permitting a rotor to remain stationary in a hot casing, or by packing rubbing which may apply frictional heating to the “high” side of the rotor, leading to further bowing into the rub. Care must be taken to see that nonuniformity of material which could cause rotor distortion with heat is avoided, and to avoid rubbing of the packings on the rotor. Turning gears are generally used to keep the rotor turning at low speed to maintain uniform temperature when the turbine is shut down and cooling, and for a prolonged period before starting.

TURBINE BUCKETS, BLADING, AND PARTS

Figure 9.4.13 shows various blade fastenings. Blades are subject to vibration and possible fatigue fracture if their natural frequency is reso-

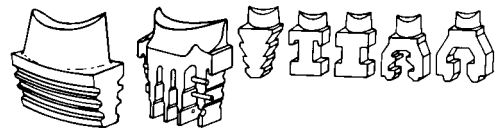

Fig. 9.4.13 Steam-turbine blade fastenings.

nant with some applied vibration force. Forced vibrations may arise from the following causes (see also Sec. 5):

1. Variations in steam forces. The blade frequencies should not be even multiples of the running speed, nor should they be resonant with the frequency of passing nozzle partitions or exhaust-hood struts.
2. Shock, the result of blades being subjected to discontinuous steam flow, such as may be caused by incomplete peripheral steam admission or extraction.

3. Torsional vibrations of the rotor.

High-speed, low-pressure blades of condensing turbines are usually of tapering section and have a warped surface in order to provide appropriate blade angles throughout their length. Long blades of this type frequently have their natural frequency between three and four times the running speed or even lower. Such blades should always be specially tuned to have a margin in frequency away from running-speed stimuli.

Margins from running speed to assure freedom from fatigue due to resonant vibration and transverse to the plane of the wheel are as follows:

Frequency, cycles per revolution	2	3	4	5
Margin between critical and running speeds, %:				
Within wheel plane (tangential)	15	10	5	5
Transverse to wheel plane (axial)	20	10	10	5

Higher-frequency buckets whose frequencies cannot assuredly be made nonresonant should be designed with adequate strength to resist such stimuli as may occur under service conditions.

Blade Materials The material in most general use is a low-carbon stainless steel of the following composition: Cr, 12 to 14 percent; C, 0.10 to 0.12; Mn, 0.08 max; P, 0.03 max; S, 0.05 max; Si, 0.25 max. Its physical characteristics in the heat-treated condition at room temperature may be tensile strength, 100,000 lb/in² (690 MPa); yield point, 80,000 lb/in² (550 MPa); elongation, 21 percent; reduction of area, 60 percent. For the higher-temperature blades, particularly on large machines, it is practice to use alloyed chrome steel to achieve the required strength and oxidation-erosion resistance (see also Sec. 6).

Rotor Materials Since steam turbines operate at high speeds, rotor materials must be of very high integrity and of basically high strength. In addition, the material should be “tough” at the temperatures at

which it is to be highly stressed. A measure of this toughness may be obtained by running Charpy notch impact tests at various temperatures (see Sec. 5). In large modern machines the rotor forgings are almost exclusively made of steel melted in basic electric furnaces and vacuum poured to achieve freedom from internal defects. Turbine rotor forgings are usually made with small amounts of alloying elements such as Ni, Cr, V, or Mo.

Casing and Bolting Materials High-temperature and -pressure casings are almost always made of castings in order to achieve the complicated shapes required by these components. The alloy compositions used are selected so as to provide good weldability and castability as well as good physical properties. Low-temperature and -pressure casings are usually fabricated from steel plate. Bolts are made of forged or rolled materials.

The practical use of higher steam pressures and temperatures is limited by the strength and cost of available materials.

Leakage Metallic labyrinth packings are employed to (1) reduce internal steam leakage from stage to stage, (2) prevent steam from escaping the turbine from elevated-pressure ends, and (3) prevent air from leaking into the turbine at subatmospheric-pressure shaft ends. Interstage packings usually employ single rings with multiple teeth. End packings are arranged in multiple rings. At the high-pressure end, the leakage of steam past the first few rings may be carried to a lower-pressure stage of the turbine so that the outer rings need only prevent the leakage of low-pressure steam to atmosphere. The annulus above the last ring, or group of rings, is connected to a packing exhauster which maintains a pressure slightly below atmospheric. In consequence, no steam leaks out along the shaft, while a small amount of air is drawn past the final packing to the exhauster. Vacuum packings are provided with an inner annulus which is supplied with steam above atmospheric pressure. Steam flows inward from that annulus to supply the leakage toward the vacuum end, and outward toward a packing-exhauster connection. Thus steam is prevented from escaping along the shaft, while air is prevented from being drawn into the turbine.

Some turbines use carbon end packings or water seals. Carbon packings consist of one or more rings of pure carbon made in sections of 90 or 120° and held toward the shaft with small clearances by means of springs. The springs should have an axial component of force to hold the rings against the side of the box.

Labyrinths dependent upon radial clearances are shown in Fig. 9.4.14. In the design with "high and low" teeth, heavy teeth are cut on the turbine shaft, and thin teeth are part of a renewable packing ring which is made in segments backed and held inward by flat springs. The key indicated in the figure prevents turning of the segments. These types require that the rotor remain sensibly concentric with the stator but do not require a close axial adjustment.

Labyrinths dependent upon axial clearances are shown in Fig. 9.4.15. These require the maintenance of a close axial adjustment of the rotor.

The flow through a labyrinth may be approximately determined by the formula

$$W = 25KA \sqrt{\frac{(P_1/V_1)[1 - (P_2/P_1)]}{N - \ln(P_2/P_1)}}$$

where W = mass flow of steam, lb/h; K = experimentally determined coefficient; A = area through packing clearance space, in²; P_1 = initial

pressure, lb/in² abs; V_1 = initial specific volume of steam, ft³/lb; P_2 = final pressure, lb/in² abs; N = number of throttlings.

The value of K for interlocking labyrinths where the flow velocity is effectively destroyed between throttlings is approximately 50 and is independent of clearance for usual clearance values.

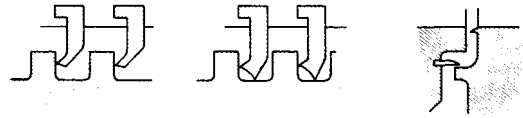

Fig. 9.4.15 Labyrinths with axial clearance.

For noninterlocking labyrinths, i.e., stationary teeth against a straight cylindrical shaft, the value of K varies with the ratio of tooth spacing to radial clearance, being about 120 for tooth spacing of five times the radial clearance, reducing to approximately 50 for a tooth spacing fifty times the clearance.

Turning Gears Large turbines are equipped with turning gears to rotate the rotors slowly during warming up, cooling off, and particularly during shutdown periods of several days when it may be necessary to start the turbine again on short notice. The object is to maintain the shaft or rotor at an approximately uniform temperature circumferentially, so as to maintain straightness and preserve the balance. Turning gears permit an appreciable reduction in starting time, particularly following a relatively short shutdown.

It is seldom necessary to use high-pressure oil to lift the journals off their bearings when using a turning gear. A low-pressure motor-driven oil pump is used which floods the bearings with about half their usual flow of oil. The turning gear is made powerful enough to start the rotor and rotate it at low speed.

High-Temperature Bolting The bolting of high-pressure, high-temperature joints, particularly turbine-shell or valve-bonnet joints, is very exacting. It is worthwhile to taper the threads of either the male or the female element so that the engagement of the threads throughout the length of the engaged thread portion will give approximately uniform bearing. The reliability of taper-threaded bolts is superior to that of parallel-threaded bolts.

Thrust bearings must usually be designed to carry axial rotor thrust in either direction, with sufficient margin to take care of unusual operating conditions. Thrust runners may be machined solid on the shaft or can be a separate piece shrunk on and secured from endwise motion. The stationary bearing surfaces may be of the pivoted-shoe type, or made in solid plates with babbit or other bearing-material facing, with grooves for oil supply and "lands" to carry the thrust load.

Axial thrust on the turbine rotor is caused by pressure and velocity differences across the rotor blades, pressure differences from one side to the other on wheels or rotor bodies, and pressure differences across shaft labyrinths which have steps in diameter. The net thrust is the sum of all these effects, some of which may be in one direction, and some in the opposite direction. Rotor-blade and wheel or body thrust are usually in the direction of steam flow. It is usual to balance this thrust either partially or completely by proper choice of shaft packing diameters and pressure differences so that the net thrust is not too large. The thrust

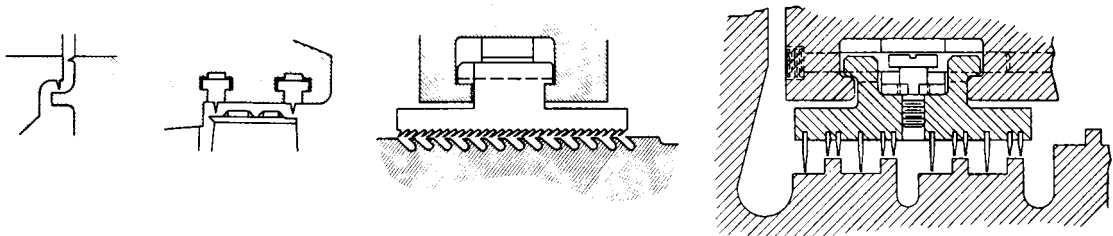

Fig. 9.4.14 Labyrinths with radial clearance.

bearing must be made large enough so that it is not overloaded by the net thrust. In this respect it is necessary to foresee all operating conditions which may influence the net thrust and allow for these; in addition some margin must be allowed for abnormal or unforeseen circumstances which may occur in service. (See also Sec. 8.)

Controls Steam turbines are nearly always equipped with speed-control governors, and with separate overspeed governors. The only exceptions are special cases where it is judged that the possibility of overspeed due to loss of load is exceedingly remote. The speed-control governor may be arranged for a wide range of speed setting in the case of a variable-speed turbine. The steam flow-control valve or valves are operated by this governor, usually through a hydraulic relay mechanism. The overspeed governor is usually of an overisochronous type, arranged to trip at 10 percent over normal full speed (on some small turbines, 15 percent), actuating quick-closing stop valves to shut off the steam supply to the turbine. Speed-control governing systems are usually designed so that the overspeed-governing system is not brought into action on sudden loss of full load.

On automatic extraction machines, the speed governor must be correlated with the extraction-pressure controlling-valve system.

On fossil-reheat turbines, because of the large stored steam volume in the reheater and piping, and on nuclear turbines, because of the moisture separator/steam reheater and piping volumes, it is necessary to protect the turbine from overspeed on sudden loss of load by shutting off this stored steam ahead of the lower-pressure stages. It is done by intermediate intercept valves, actuated by a governor set slightly higher than the speed-control governor. An intermediate stop valve actuated by the overspeed trip is usually added in series for additional protection.

Speed-governing systems can be supplied of various sensitivities and speed ranges, to suit the requirements of the driven apparatus. Both mechanical-hydraulic and electrohydraulic systems are employed. Analog electrohydraulic systems were introduced during the 1960s as electronic components of sufficient reliability for turbine service became available. Digital systems were introduced in the 1980s and have become the standard control technology. Modern systems control transient stress and the expenditure of low-cycle fatigue life of high-temperature components, in addition to controlling speed and load. (See "Steam Temperature—Starting and Loading.")

Steam turbines are usually provided with a supervisory instrumentation system. That for a large central station unit may process several hundred channels of information, providing alarms and/or trips for abnormal parameters. Data may be stored on paper charts, on magnetic media, or in computer memory depending upon the design of the system. Displays frequently employ color cathode-ray tubes.

INDUSTRIAL AND AUXILIARY TURBINES

Low-capacity turbines are employed for services such as engine-room auxiliaries and small generating sets. Usually they comprise a single turbine element. Their efficiency may be less than that of a corresponding reciprocating engine, but they are employed because of their compactness and because they require no internal lubrication. The exhaust steam is free from oil and grease and is available for heating purposes. They are frequently coupled to the driven machine by means of speed-reducing gears. Turbines of this type are usually of the axial-flow type, but the **tangential helical-flow** turbine, in which the steam is directed tangentially and radially inward by nozzles against buckets milled in the wheel rim and made to flow in a helical path reentering the buckets one or more times, is also used. Such machines have generally been limited to small single-stage designs, and are very simple and rugged.

In **back-pressure turbines**, the exhaust steam is employed for some heating process, and the turbine work may be a by-product. If all the exhaust steam is condensed in heat-absorbing apparatus and returned to the system, the thermal efficiency of the system may be over 90 percent. One application is the **superposition** of a high-pressure system on lower-pressure power units, with the exhaust from the high-pressure turbine power units, with the exhaust from the high-pressure turbine going to the low-pressure steam mains. By this device, an old power station can

be rehabilitated and its capacity increased. Two methods of operation are in use: (1) with constant intermediate pressure as when the lower-pressure power units operate also with steam from existing lower-pressure boilers and (2) with variable intermediate pressure as when the low-pressure units receive steam only from the back-pressure turbine.

Boiler-feed-pump-drive turbines have been used extensively as part of the power-plant system, especially for large, high-pressure plants where the required feed-pump power may amount to 4 percent of the gross plant output, and for large nuclear units. The turbine and pump can be matched as to rotative speed. These turbines are variously integrated into the main cycle. The most common present practice is to use condensing, nonextracting turbines supplied with steam in the range of 150 to 200 lb/in² abs (1,000 to 1,400 kPa) taken from the exhaust of the intermediate sections of fossil turbines, or from the inlet of the low-pressure sections of nuclear units. These turbines normally have a connection to the main steam supply for starting and low-load operation. Similar auxiliary turbines are frequently used to drive the forced- or induced-draft fans of large fossil-fuel-fired boilers.

With **extraction turbines**, partly expanded steam is extracted for external process use at one or more points. The turbines may be either condensing or noncondensing. Extraction turbines are usually designed to sustain full rated output, with or without extraction, and are provided with automatic regulating mechanisms to deliver steam from the extraction points at constant pressure, as long as there is sufficient power load to permit the necessary flow. The use of such extraction turbines, particularly with high initial pressures in connection with many industrial processes requiring moderate- or low-pressure steam, results frequently in a high efficiency of power production, i.e., the only heat required in such a plant over and above that to provide the required process steam is the heat equivalent of the power generated by the steam before extraction. This means that such power can be produced at nearly 100 percent thermal efficiency.

Figure 9.4.16 illustrates a typical double-automatic, condensing extraction turbine, providing two controlled extraction pressures. In this case, the unit is equipped with internal spool valves at both extraction points. Grid and poppet-type valves have been used for this purpose. The extraction-stage valves are under the control of an extraction-pressure-actuated governor; they determine the flow to the subsequent stages of the turbine and maintain the pressure in the extraction stage. The operation of the valves is by means of a pilot valve controlling the admission of high-pressure fluid to an actuating cylinder, which, in turn, opens or closes the valves to the nozzle ports to the succeeding stage. Extractions of this kind are called pressure-controlled extractions, and the pressure is maintained practically constant over a wide range if the load is sufficient to permit the required steam flow.

Mechanical-drive turbines are commonly applied where moderate to high power and/or precise speed control of the driven machine are needed. Typical applications include the powering of papermaking machines and the driving of fluid compressors in petrochemical plants. So many sizes and types are available from the manufacturers, and they have been adapted to so many applications, that it is impossible to give here more than a general description. These turbines are commonly built in sizes from a few to several thousand horsepower. If the speed of the driven machine is low, a reduction gear may be used in order to reduce the size and cost of the driving turbine and to improve its efficiency. Mechanical-drive turbines have a wide range of application, being adaptable for any steam conditions and a wide variety of speeds. They can be equipped with speed governors suited to the requirements, i.e., of very good stability and accuracy, if this is desirable, and arranged for various constant speed settings over a speed range as wide as 10: 1.

Main Propulsion Marine Turbines (see also Sec. 11.3) Steam turbines were commonly employed for the propulsion of naval and merchant ships into the 1970s. The availability of aero-derivative gas turbines of light weight, high capacity, and acceptable efficiency has led to their use for the propulsion of oil-fired naval vessels. The rapid rise in the price of fuel oil in the 1970s led merchant ship operators away from steam propulsion to the use of the more efficient diesel engine. Steam turbines continue to be used for the propulsion of all nuclear-powered

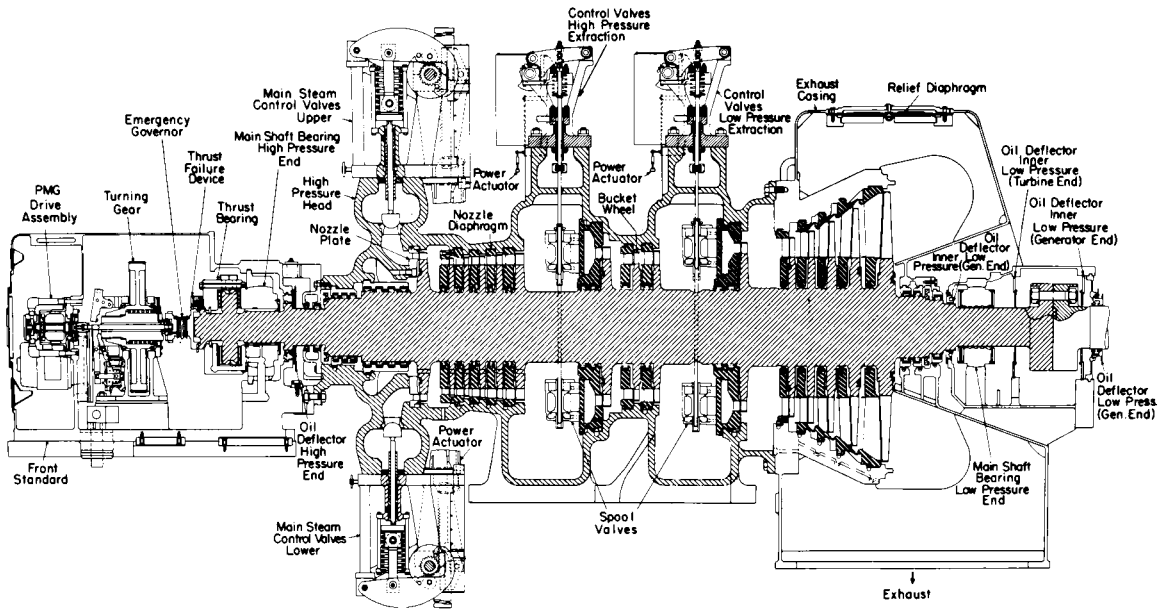

Fig. 9.4.16 Double automatic condensing extracting turbine, 25,000 kW. (General Electric Co.)

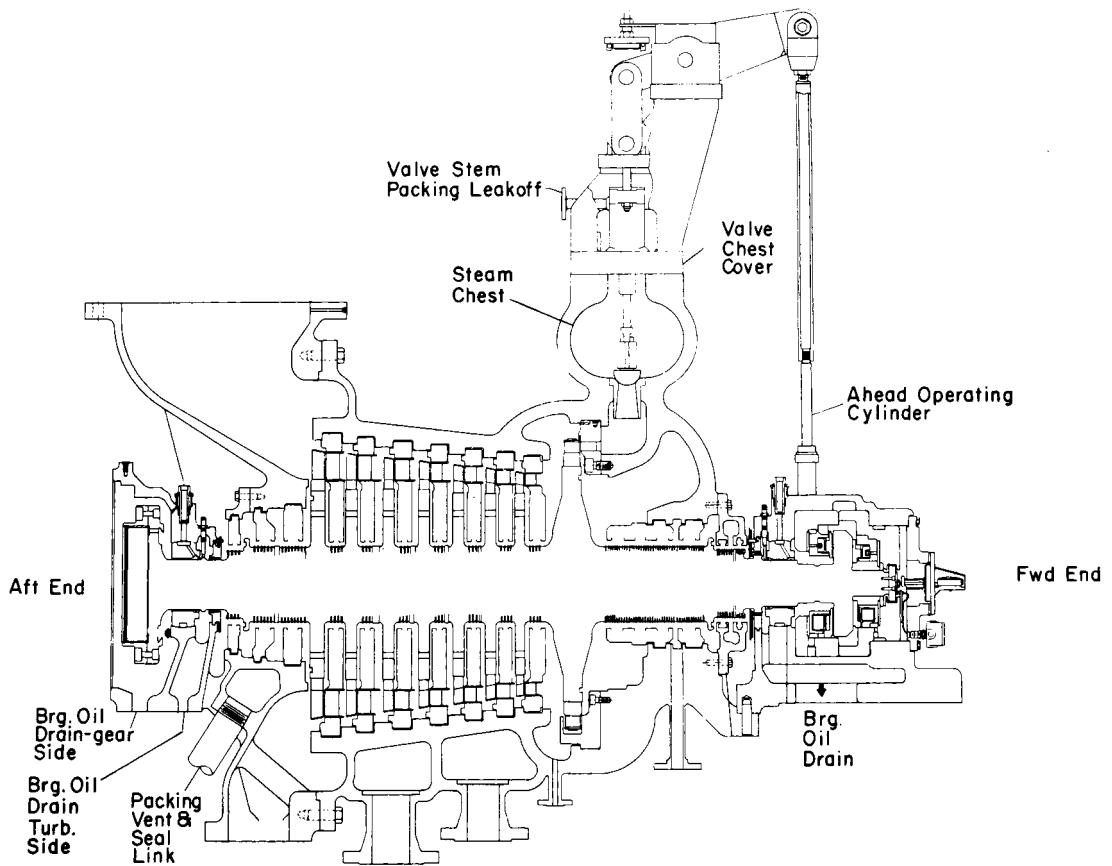

Fig. 9.4.17a A 16,000-hp cross-compound marine turbine designed for steam conditions of 600 lb/in² gage, 850°F, 1½ inHg abs. High-pressure section for 6,550-r/min normal speed. Low-pressure section in Fig. 9.4.17b. (General Electric Co.)

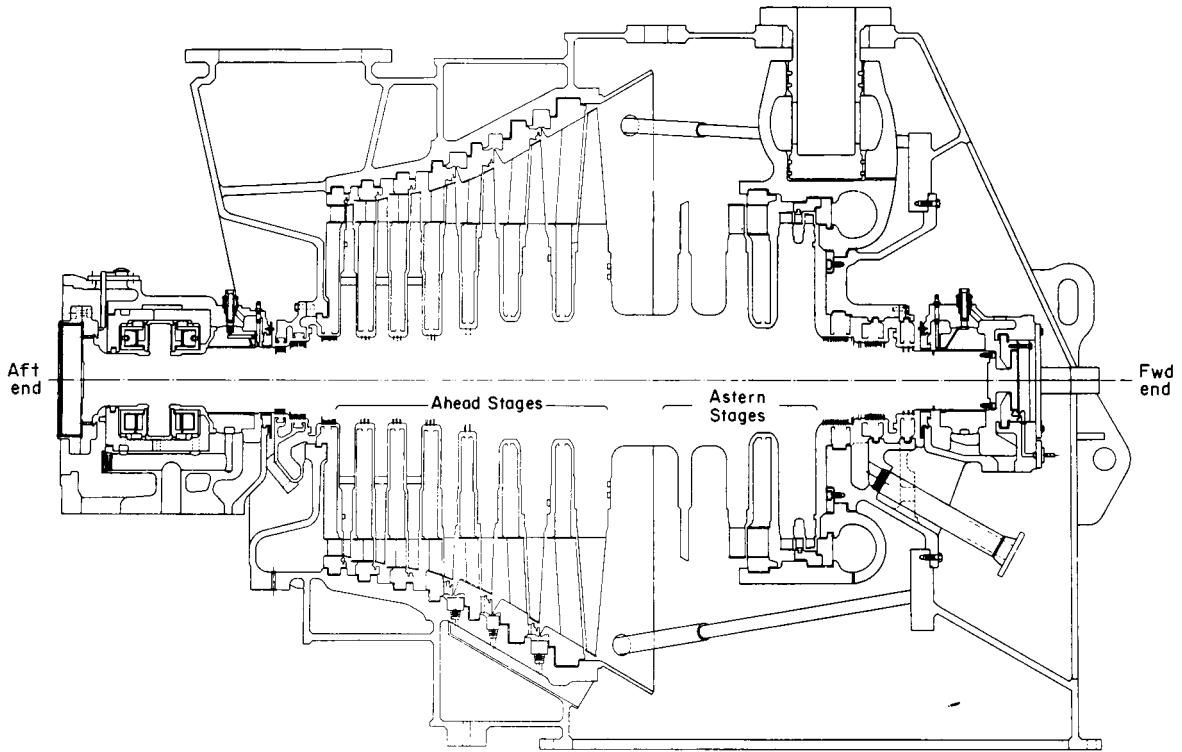

Fig. 9.4.17b Same marine turbine as in Fig. 9.4.17a, but showing low-pressure section for 3,750-r/min normal speed. Low-pressure section contains two-stage reversing element. (General Electric Co.)

vessels. Marine turbines are basically the same as central-station or industrial turbines except that usually the turbine is divided into a high-pressure and a low-pressure element, each geared through a common low-speed gear to the propeller shaft. The advantages of this compound arrangement are that two high-speed pinions divide the load on a common low-speed gear, thus reducing gear weight when compared with a single turbine. The high-pressure turbine can be made higher-speed than the low-pressure turbine and so be better adapted to the low volume flow. Each turbine can have a short rugged shaft, and either turbine can be used to propel the ship in an emergency.

Geared marine turbines require a reversing element for operating the vessel astern. This is typically a two-stage impulse turbine with two 2-row, or one 2-row and one 1-row, velocity stages arranged in the exhaust space of the low-pressure ahead turbine, so as to operate under

vacuum under normal ahead conditions. The rotation loss of such an astern turbine is about $\frac{1}{2}$ percent under normal ahead conditions.

Being directly geared to the propeller shaft, marine turbines must work at variable speeds. Overspeed governors are not required but are sometimes applied as a precautionary measure. Control is effected in most cases by sequentially operated nozzle valves. A typical marine turbine rated 16,000 hp is shown in Fig. 9.4.17. Ratings of 70,000 hp have been built, and larger sizes are realistic.

LARGE CENTRAL-STATION TURBINES

Figures 9.4.18 and 9.4.19 show examples of large central-station turbines as built by two manufacturers.

Figure 9.4.18 illustrates a 3,600-r/min tandem-compound four-flow

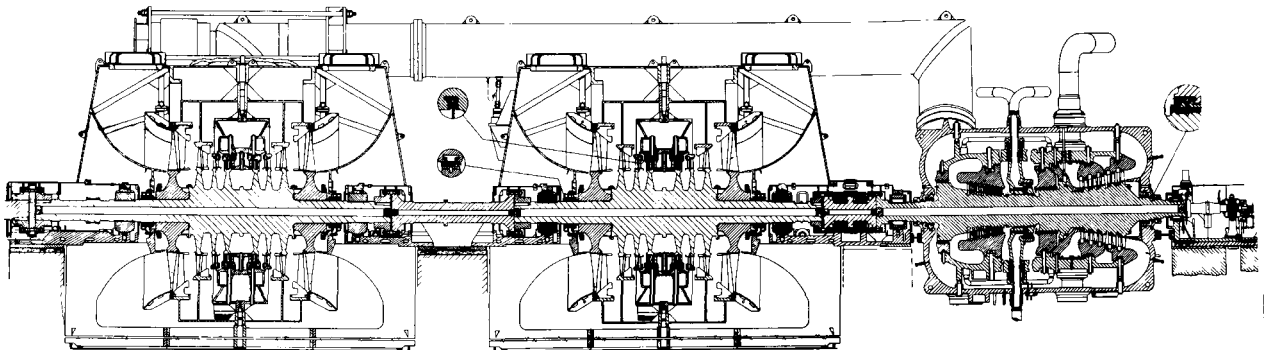

Fig. 9.4.18 Cross section of a 500-MW tandem-compound, quadruple-flow 3,600-r/min reheat turbine. (Westinghouse Electric Corp.)

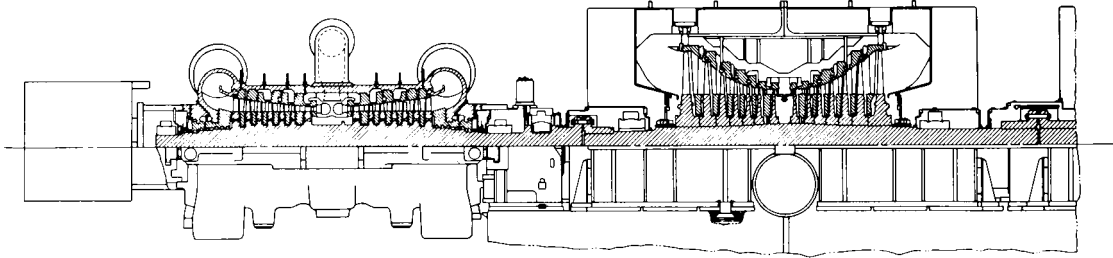

Fig. 9.4.19 Cross section of a 1,300-MW class tandem-compound, six-flow 1,800-r/min turbine for steam from light-water nuclear reactors, showing one of the three low-pressure sections. (General Electric Co.)

unit rated 500 MW. It is a single-reheat fossil unit for nominal inlet-steam conditions of 2,400 lb/in² gage (16,650 kPa) 1,000°F (538°C), reheat to 1,000°F (538°C). The right-hand casing is a combined high-pressure and reheat section. Steam flows from the left center to the right through the impulse-type governing stage, then reverses, flowing to the left through the nine reaction-type high-pressure stages, and exhausts from the casing to the reheat section of the boiler. Reheated steam reenters that casing at its right center, flowing to the right through five reheat stages, turning once more to flow to the left between the inner and outer casings, finally exhausting up and to the left to the two double-flow low-pressure casings on the left end of the unit. The inlet stop and control valves, the reheat stop and interceptor valves, and the generator are not shown.

Four-flow units of this general type employ last-stage rotor blades from 25 to 40 in. (600 to 900 mm) long and in ratings up to about 700 MW. Significantly higher ratings require dividing the functions of the combined casing into a separate single-flow high-pressure casing and a separate two-flow reheat casing, for a total of four casings. The use of the long titanium last-stage buckets makes this configuration suitable for ratings up to 1,200 MW. In cases requiring additional exhaust area, a third double-flow low-pressure element can be employed for a total of five casings. Tandem-compound 3,600- and 3,000-r/min units are commonly offered for ratings up to about 1,200 MW. Somewhat larger ratings can be accommodated by 3,600/3,600- or 3,600/1,800-r/min cross-compound units, but economic considerations makes their application infrequent.

Figure 9.4.19 illustrates an 1,800-r/min tandem-compound six-flow turbine designed for steam from light-water nuclear reactors. Reactors of both the boiling and pressurized-water types raise steam at 1,000 lb/in² abs (7,000 kPa) approximately with little or no initial superheat, so that the initial temperature is about 545°F (285°C), with a fraction of 1 percent of moisture frequently present. The poorer steam conditions result in higher steam rates than seen by fossil turbines. The lower initial pressure causes larger initial specific volume. In consequence, a typical nuclear turbine must accommodate 2.5 to 4 times the initial volume flow, and about 1½ times the exhaust volume flow of a fossil unit of the same rating. These considerations and the fact that the low temperature of the steam results in high moisture content in the expansion lead to the choice of 1,800 r/min. In halving the speed, diameters are less than doubled, balancing the advantages of larger steam-path area to accommodate large flow, while reducing velocities to minimize the occurrence of impact moisture erosion. The shortened energy range due to the lower initial conditions requires only two kinds of casings, high pressure and low pressure, compared with the three needed by fossil-reheat units.

Referring to Fig. 9.4.19, the steam enters the double-flow nozzle boxes of the high-pressure section, to the left, through stop and control valves which are not shown. It flows in both directions through the impulse-type stages, exhausting through four connections on each end of the shell. At the exhaust, the pressure is reduced to 200 lb/in² abs (1,400 kPa) approximately, and the moisture content is increased to 12 percent. That moisture poses an erosion risk and a performance loss to the low-pressure section following. It is current practice to dry the steam in an external moisture separator, frequently combined with one or two stages of steam-to-steam reheating, before admission to the low-

pressure casings. Figure 9.4.20 is a cross section through a combination moisture separator and two-stage steam reheater. The exhaust from the high-pressure turbine enters the shell at the bottom, flowing upward through the inclined corrugated-plate moisture-separating elements, which remove essentially all the entrained water. It continues upward, flowing over the tubes of the first-stage bundle, which are supplied with

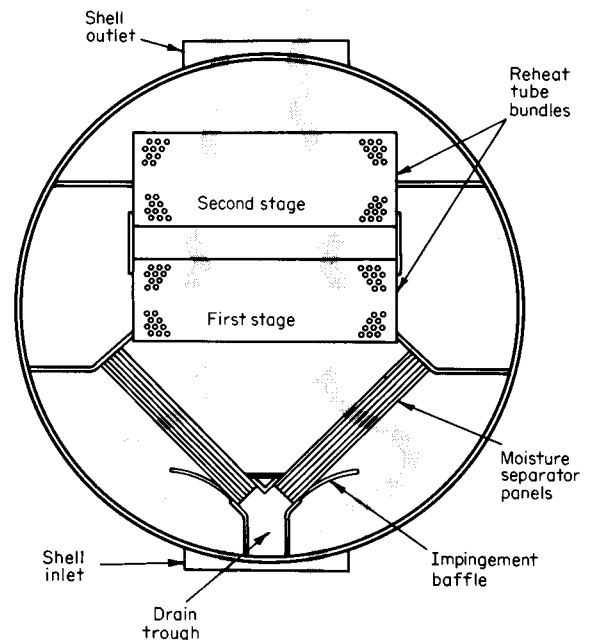

Fig. 9.4.20 Cross section of a combination moisture separator and two-stage steam reheater for use with nuclear reactor turbines.

steam extracted from the high-pressure turbine, approaching to within 20 to 50°F (11 to 28°C) of that temperature. Next, it flows over the tubes of the second stage bundle, which are supplied with initial steam, approaching to within 20 to 50°F (11 to 28°C) of that temperature, or to 495 to 525°F (257 to 274°C). The steam leaves the vessel at the top and is admitted to the low-pressure sections of Fig. 9.4.19, through stop and intercept valves, not shown. The last-stage blade length is in the range of 38 to 52 in (960 to 1,320 mm).

Units of the type described are built to ratings of approximately 1,300 MW with larger sizes available. Similar four-flow units are employed for ratings up to approximately 1,000 MW.

Other types of nuclear reactors, such as the high-temperature gas-cooled reactor and the liquid-metal-cooled fast-breeder reactor, produce steam conditions at temperature and pressure levels comparable with fossil-fuel-fired boilers, leading to the use of 3,600-r/min units similar to fossil practice.

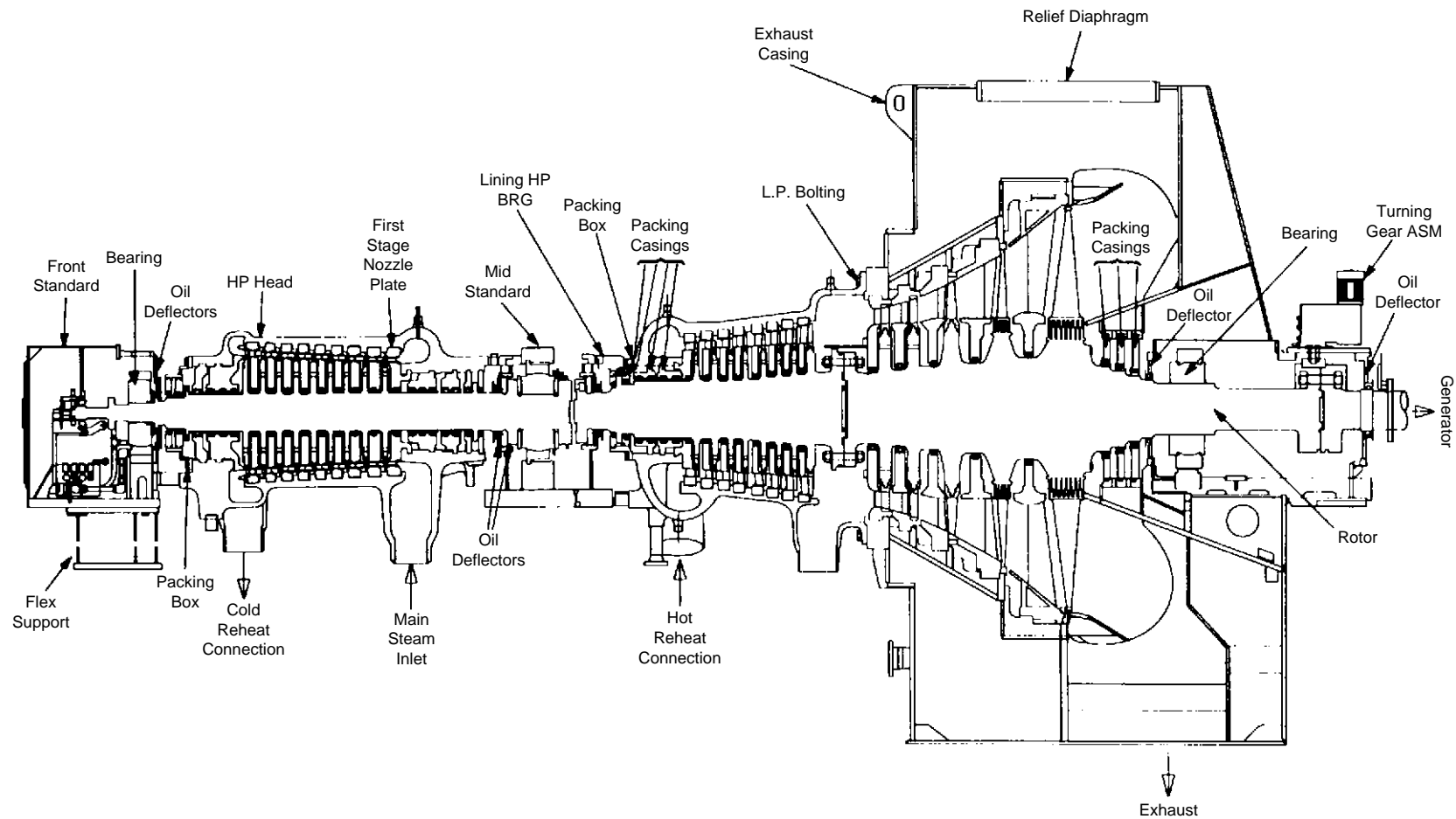

Fig. 9.4.21 Two-casing reheat combined-cycle turbine with single-flow down exhaust. (General Electric Co.)

STEAM TURBINES FOR COMBINED CYCLES

(See also Sec. 9.7)

Modern combustion gas turbines (GTs) have ratings approaching 250 MW. Considerable sensible heat is available in the gas-turbine exhaust-gas flow which ranges from 1,000 to 1,100°F (530 to 600°C) in temperature. In the combined cycle, the gas-turbine exhaust is directed to an unfired steam boiler called a heat-recovery steam generator (HRSG). The steam generated in the HRSG is admitted to a steam turbine, whose electrical output is approximately one-half that of the gas turbine. The resulting combined thermal efficiency can range from 50 to 55 percent, better than that of any other available power cycle. High efficiency combined with the clean exhaust of gas turbines burning natural gas has created a broad field of application for combined cycles and the associated steam turbines.

Combined cycles can be arranged in several ways. In the single-shaft configuration, the gas and steam turbines are coupled together, driving a single generator. Units rated 352 MW have been manufactured for 50-Hz power systems, in which the gas turbine contributes 223 MW while the steam turbine generates 129 MW. The multiple-shaft arrangement uses a separate generator for each steam turbine and gas turbine. Each gas turbine has its own HRSG. The steam output from two or more GT/HRSG pairs can be manifolded to a single steam turbine. For example, a typical application for 60-Hz power systems combines two 164-MW gas turbines with one 188-MW steam turbine for a combined output of 516 MW. The steam conditions are 1,400 lb/in² gage (9,760 kPa), 1,000°F (538°C) with reheat in the HRSGs back to 1,000°F (538°C).

Steam turbines in combined-cycle service operate following the gas turbine(s), with their admission valves wide open accepting the full instantaneous output of the HRSG(s). The valves are located away from the turbine casings and are used only for speed control upon starting and

for overspeed protection in the event of loss of load. The result is a very simple symmetric casing arrangement which reduces transient thermal stress and helps the steam turbine follow the potentially rapid changes in gas-turbine output. These features can be seen in Fig. 9.4.21. A two-casing reheat unit with single-flow exhaust is illustrated.

STEAM-TURBINE PERFORMANCE

The ideal steam rate (steam consumption, lb/kWh) of a simple turbine cycle is $3,412.14/(h_1 - h_{s2})$, where h is in Btu/lb [or kg/kWs = $1/(h'_1 - h'_{s2})$, h' in kJ/kg]. (See Fig. 9.4.4.)

The actual steam rate is $3,412.14/[\eta_s(h_1 - h_{s2})]$, where η_s is the engine efficiency of the turbine only, inclusive of mechanical losses {or kg/kWs = $1/[\eta_s(h'_1 - h'_{s2})]$ }.

The actual steam rate of turbine and generator is $3,412.14/\eta_e(h_1 - h_{s2})$, where η_e is the engine efficiency including all mechanical and electrical losses {or kg/kWs = $1/[\eta_e(h'_1 - h'_{s2})]$ }.

The enthalpy of the steam leaving the turbine elements h_2 is

$$h_2 = h_1 - \eta_s(h_1 - h_{s2}) = (Wh_1 - 3,412.14P_g)/W$$

where η_s is the engine efficiency of the steam path, inclusive of leakages and losses but exclusive of mechanical and electrical losses; W is the steam flow, lb/h; and the gross output P_g is the net output plus mechanical and electrical losses, kW [or $h'_2 = h'_1 - \eta_s(h'_1 - h'_{s2}) = (Wh'_1 - P_g)/W'$, where W' is flow in kg/s].

Table 9.4.2 gives steam rates for the ideal simple turbine cycle through a wide range of operating conditions. The performance of a turbine is usually expressed as a steam rate in the case of machines having no extraction or admission of steam between inlet and exhaust, which is generally true of small units and most noncondensing turbines.

Table 9.4.2 Theoretical Steam Rates for Typical Steam Conditions, lb/kWh*

	Initial pressure, lb/in ² gage																																																																																																																																																																																																																																																																																																																																																																																																																																																								
	150	250	400	600	600	850	850	900	900	1,200	1,250	1,250	1,450	1,450	1,800	2,400																																																																																																																																																																																																																																																																																																																																																																																																																																									
	Initial temp, °F																																																																																																																																																																																																																																																																																																																																																																																																																																																								
	365.9	500	650	750	825	825	900	825	900	825	900	950	825	950	1000	1000																																																																																																																																																																																																																																																																																																																																																																																																																																									
	Initial Superheat, °F																																																																																																																																																																																																																																																																																																																																																																																																																																																								
	0	94.0	201.9	261.2	336.2	297.8	372.8	291.1	366.1	256.3	326.1	376.1	232.0	357.0	377.9	337.0																																																																																																																																																																																																																																																																																																																																																																																																																																									
Exhaust pressure	Initial enthalpy, Btu/lb																																																																																																																																																																																																																																																																																																																																																																																																																																																								
	1,195.5	1,261.8	1,334.9	1,379.6	1,421.4	1,410.6	1,453.5	1,408.4	1,451.6	1,394.7	1,438.4	1,468.1	1,382.7	1,461.2	1,480.1	1,460.4																																																																																																																																																																																																																																																																																																																																																																																																																																									
inHg abs																	2.0	10.52	9.070	7.831	7.083	6.761	6.580	6.282	6.555	6.256	6.451	6.133	5.944	6.408	5.900	5.668	5.633	2.5	10.88	9.343	8.037	7.251	6.916	6.723	6.415	6.696	6.388	6.584	6.256	6.061	6.536	6.014	5.773	5.733	3.0	11.20	9.582	8.217	7.396	7.052	6.847	6.530	6.819	6.502	6.699	6.362	6.162	6.648	6.112	5.862	5.819	4.0	11.76	9.996	8.524	7.644	7.282	7.058	6.726	7.026	6.694	6.894	6.541	6.332	6.835	6.277	6.013	5.963	lb/in ² gage																	5	21.69	16.57	13.01	11.05	10.42	9.838	9.288	9.755	9.209	9.397	8.820	8.491	9.218	8.351	7.874	7.713	10	23.97	17.90	13.83	11.64	10.95	10.30	9.705	10.202	9.617	9.797	9.180	8.830	9.593	8.673	8.158	7.975	20	28.63	20.44	15.33	12.68	11.90	11.10	10.43	10.982	10.327	10.490	9.801	9.415	10.240	9.227	8.642	8.421	30	33.69	22.95	16.73	13.63	12.75	11.80	11.08	11.67	10.952	11.095	10.341	9.922	10.801	9.704	9.057	8.799	40	39.39	25.52	18.08	14.51	13.54	12.46	11.66	12.304	11.52	11.646	10.831	10.380	11.309	10.134	9.427	9.136	50	46.00	28.21	19.42	15.36	14.30	13.07	12.22	12.90	12.06	12.16	11.284	10.804	11.779	10.531	9.767	9.442	60	53.90	31.07	20.76	16.18	15.05	13.66	12.74	13.47	12.57	12.64	11.71	11.20	12.22	10.90	10.08	9.727	75	69.4	35.77	22.81	17.40	16.16	14.50	13.51	14.28	13.30	13.34	12.32	11.77	12.85	11.43	10.53	10.12	80	75.9	37.47	23.51	17.80	16.54	14.78	13.77	14.55	13.55	13.56	12.52	11.95	13.05	11.60	10.67	10.25	100	45.21	26.46	19.43	18.05	15.86	14.77	15.59	14.50	14.42	13.27	12.65	13.83	13.24	11.21	10.73		125	57.88	30.59	21.56	20.03	17.22	16.04	16.87	15.70	15.46	14.17	13.51	14.76	13.01	11.84	11.28		150	76.5	35.40	23.83	22.14	18.61	17.33	18.18	16.91	16.47	15.06	14.35	15.65	13.75	12.44	11.80		160	86.8	37.57	24.79	23.03	19.17	17.85	18.71	17.41	16.88	15.41	14.69	16.00	14.05	12.68	12.00		175	41.16	26.29	24.43	20.04	18.66	19.52	18.16	17.48	15.94	15.20	16.52	14.49	13.03	12.29			200	48.24	29.00	26.95	21.53	20.05	20.91	19.45	18.48	16.84	16.05	17.39	15.23	13.62	12.77			250	69.1	35.40	32.89	24.78	23.08	23.90	22.24	20.57	18.68	17.81	19.11	16.73	14.78	13.69			300	41.72	40.62	28.50	26.53	27.27	25.37	22.79	20.62	19.66	20.89	18.28	15.95	14.59				400	72.2	67.0	38.05	35.43	35.71	33.22	27.82	24.99	23.82	24.74	21.64	18.39	16.41				425	84.2	78.3	41.08	38.26	38.33	35.65	29.24	26.21	24.98	25.78	22.55	19.03	16.87				600	78.5	73.1	41.08	38.26	38.33	35.65	29.24	26.21	24.98	25.78	22.55	19.03	16.87			
2.0	10.52	9.070	7.831	7.083	6.761	6.580	6.282	6.555	6.256	6.451	6.133	5.944	6.408	5.900	5.668	5.633	2.5	10.88	9.343	8.037	7.251	6.916	6.723	6.415	6.696	6.388	6.584	6.256	6.061	6.536	6.014	5.773	5.733	3.0	11.20	9.582	8.217	7.396	7.052	6.847	6.530	6.819	6.502	6.699	6.362	6.162	6.648	6.112	5.862	5.819	4.0	11.76	9.996	8.524	7.644	7.282	7.058	6.726	7.026	6.694	6.894	6.541	6.332	6.835	6.277	6.013	5.963	lb/in ² gage																	5	21.69	16.57	13.01	11.05	10.42	9.838	9.288	9.755	9.209	9.397	8.820	8.491	9.218	8.351	7.874	7.713	10	23.97	17.90	13.83	11.64	10.95	10.30	9.705	10.202	9.617	9.797	9.180	8.830	9.593	8.673	8.158	7.975	20	28.63	20.44	15.33	12.68	11.90	11.10	10.43	10.982	10.327	10.490	9.801	9.415	10.240	9.227	8.642	8.421	30	33.69	22.95	16.73	13.63	12.75	11.80	11.08	11.67	10.952	11.095	10.341	9.922	10.801	9.704	9.057	8.799	40	39.39	25.52	18.08	14.51	13.54	12.46	11.66	12.304	11.52	11.646	10.831	10.380	11.309	10.134	9.427	9.136	50	46.00	28.21	19.42	15.36	14.30	13.07	12.22	12.90	12.06	12.16	11.284	10.804	11.779	10.531	9.767	9.442	60	53.90	31.07	20.76	16.18	15.05	13.66	12.74	13.47	12.57	12.64	11.71	11.20	12.22	10.90	10.08	9.727	75	69.4	35.77	22.81	17.40	16.16	14.50	13.51	14.28	13.30	13.34	12.32	11.77	12.85	11.43	10.53	10.12	80	75.9	37.47	23.51	17.80	16.54	14.78	13.77	14.55	13.55	13.56	12.52	11.95	13.05	11.60	10.67	10.25	100	45.21	26.46	19.43	18.05	15.86	14.77	15.59	14.50	14.42	13.27	12.65	13.83	13.24	11.21	10.73		125	57.88	30.59	21.56	20.03	17.22	16.04	16.87	15.70	15.46	14.17	13.51	14.76	13.01	11.84	11.28		150	76.5	35.40	23.83	22.14	18.61	17.33	18.18	16.91	16.47	15.06	14.35	15.65	13.75	12.44	11.80		160	86.8	37.57	24.79	23.03	19.17	17.85	18.71	17.41	16.88	15.41	14.69	16.00	14.05	12.68	12.00		175	41.16	26.29	24.43	20.04	18.66	19.52	18.16	17.48	15.94	15.20	16.52	14.49	13.03	12.29			200	48.24	29.00	26.95	21.53	20.05	20.91	19.45	18.48	16.84	16.05	17.39	15.23	13.62	12.77			250	69.1	35.40	32.89	24.78	23.08	23.90	22.24	20.57	18.68	17.81	19.11	16.73	14.78	13.69			300	41.72	40.62	28.50	26.53	27.27	25.37	22.79	20.62	19.66	20.89	18.28	15.95	14.59				400	72.2	67.0	38.05	35.43	35.71	33.22	27.82	24.99	23.82	24.74	21.64	18.39	16.41				425	84.2	78.3	41.08	38.26	38.33	35.65	29.24	26.21	24.98	25.78	22.55	19.03	16.87				600	78.5	73.1	41.08	38.26	38.33	35.65	29.24	26.21	24.98	25.78	22.55	19.03	16.87																				
2.5	10.88	9.343	8.037	7.251	6.916	6.723	6.415	6.696	6.388	6.584	6.256	6.061	6.536	6.014	5.773	5.733	3.0	11.20	9.582	8.217	7.396	7.052	6.847	6.530	6.819	6.502	6.699	6.362	6.162	6.648	6.112	5.862	5.819	4.0	11.76	9.996	8.524	7.644	7.282	7.058	6.726	7.026	6.694	6.894	6.541	6.332	6.835	6.277	6.013	5.963	lb/in ² gage																	5	21.69	16.57	13.01	11.05	10.42	9.838	9.288	9.755	9.209	9.397	8.820	8.491	9.218	8.351	7.874	7.713	10	23.97	17.90	13.83	11.64	10.95	10.30	9.705	10.202	9.617	9.797	9.180	8.830	9.593	8.673	8.158	7.975	20	28.63	20.44	15.33	12.68	11.90	11.10	10.43	10.982	10.327	10.490	9.801	9.415	10.240	9.227	8.642	8.421	30	33.69	22.95	16.73	13.63	12.75	11.80	11.08	11.67	10.952	11.095	10.341	9.922	10.801	9.704	9.057	8.799	40	39.39	25.52	18.08	14.51	13.54	12.46	11.66	12.304	11.52	11.646	10.831	10.380	11.309	10.134	9.427	9.136	50	46.00	28.21	19.42	15.36	14.30	13.07	12.22	12.90	12.06	12.16	11.284	10.804	11.779	10.531	9.767	9.442	60	53.90	31.07	20.76	16.18	15.05	13.66	12.74	13.47	12.57	12.64	11.71	11.20	12.22	10.90	10.08	9.727	75	69.4	35.77	22.81	17.40	16.16	14.50	13.51	14.28	13.30	13.34	12.32	11.77	12.85	11.43	10.53	10.12	80	75.9	37.47	23.51	17.80	16.54	14.78	13.77	14.55	13.55	13.56	12.52	11.95	13.05	11.60	10.67	10.25	100	45.21	26.46	19.43	18.05	15.86	14.77	15.59	14.50	14.42	13.27	12.65	13.83	13.24	11.21	10.73		125	57.88	30.59	21.56	20.03	17.22	16.04	16.87	15.70	15.46	14.17	13.51	14.76	13.01	11.84	11.28		150	76.5	35.40	23.83	22.14	18.61	17.33	18.18	16.91	16.47	15.06	14.35	15.65	13.75	12.44	11.80		160	86.8	37.57	24.79	23.03	19.17	17.85	18.71	17.41	16.88	15.41	14.69	16.00	14.05	12.68	12.00		175	41.16	26.29	24.43	20.04	18.66	19.52	18.16	17.48	15.94	15.20	16.52	14.49	13.03	12.29			200	48.24	29.00	26.95	21.53	20.05	20.91	19.45	18.48	16.84	16.05	17.39	15.23	13.62	12.77			250	69.1	35.40	32.89	24.78	23.08	23.90	22.24	20.57	18.68	17.81	19.11	16.73	14.78	13.69			300	41.72	40.62	28.50	26.53	27.27	25.37	22.79	20.62	19.66	20.89	18.28	15.95	14.59				400	72.2	67.0	38.05	35.43	35.71	33.22	27.82	24.99	23.82	24.74	21.64	18.39	16.41				425	84.2	78.3	41.08	38.26	38.33	35.65	29.24	26.21	24.98	25.78	22.55	19.03	16.87				600	78.5	73.1	41.08	38.26	38.33	35.65	29.24	26.21	24.98	25.78	22.55	19.03	16.87																																					
3.0	11.20	9.582	8.217	7.396	7.052	6.847	6.530	6.819	6.502	6.699	6.362	6.162	6.648	6.112	5.862	5.819	4.0	11.76	9.996	8.524	7.644	7.282	7.058	6.726	7.026	6.694	6.894	6.541	6.332	6.835	6.277	6.013	5.963	lb/in ² gage																	5	21.69	16.57	13.01	11.05	10.42	9.838	9.288	9.755	9.209	9.397	8.820	8.491	9.218	8.351	7.874	7.713	10	23.97	17.90	13.83	11.64	10.95	10.30	9.705	10.202	9.617	9.797	9.180	8.830	9.593	8.673	8.158	7.975	20	28.63	20.44	15.33	12.68	11.90	11.10	10.43	10.982	10.327	10.490	9.801	9.415	10.240	9.227	8.642	8.421	30	33.69	22.95	16.73	13.63	12.75	11.80	11.08	11.67	10.952	11.095	10.341	9.922	10.801	9.704	9.057	8.799	40	39.39	25.52	18.08	14.51	13.54	12.46	11.66	12.304	11.52	11.646	10.831	10.380	11.309	10.134	9.427	9.136	50	46.00	28.21	19.42	15.36	14.30	13.07	12.22	12.90	12.06	12.16	11.284	10.804	11.779	10.531	9.767	9.442	60	53.90	31.07	20.76	16.18	15.05	13.66	12.74	13.47	12.57	12.64	11.71	11.20	12.22	10.90	10.08	9.727	75	69.4	35.77	22.81	17.40	16.16	14.50	13.51	14.28	13.30	13.34	12.32	11.77	12.85	11.43	10.53	10.12	80	75.9	37.47	23.51	17.80	16.54	14.78	13.77	14.55	13.55	13.56	12.52	11.95	13.05	11.60	10.67	10.25	100	45.21	26.46	19.43	18.05	15.86	14.77	15.59	14.50	14.42	13.27	12.65	13.83	13.24	11.21	10.73		125	57.88	30.59	21.56	20.03	17.22	16.04	16.87	15.70	15.46	14.17	13.51	14.76	13.01	11.84	11.28		150	76.5	35.40	23.83	22.14	18.61	17.33	18.18	16.91	16.47	15.06	14.35	15.65	13.75	12.44	11.80		160	86.8	37.57	24.79	23.03	19.17	17.85	18.71	17.41	16.88	15.41	14.69	16.00	14.05	12.68	12.00		175	41.16	26.29	24.43	20.04	18.66	19.52	18.16	17.48	15.94	15.20	16.52	14.49	13.03	12.29			200	48.24	29.00	26.95	21.53	20.05	20.91	19.45	18.48	16.84	16.05	17.39	15.23	13.62	12.77			250	69.1	35.40	32.89	24.78	23.08	23.90	22.24	20.57	18.68	17.81	19.11	16.73	14.78	13.69			300	41.72	40.62	28.50	26.53	27.27	25.37	22.79	20.62	19.66	20.89	18.28	15.95	14.59				400	72.2	67.0	38.05	35.43	35.71	33.22	27.82	24.99	23.82	24.74	21.64	18.39	16.41				425	84.2	78.3	41.08	38.26	38.33	35.65	29.24	26.21	24.98	25.78	22.55	19.03	16.87				600	78.5	73.1	41.08	38.26	38.33	35.65	29.24	26.21	24.98	25.78	22.55	19.03	16.87																																																						
4.0	11.76	9.996	8.524	7.644	7.282	7.058	6.726	7.026	6.694	6.894	6.541	6.332	6.835	6.277	6.013	5.963	lb/in ² gage																	5	21.69	16.57	13.01	11.05	10.42	9.838	9.288	9.755	9.209	9.397	8.820	8.491	9.218	8.351	7.874	7.713	10	23.97	17.90	13.83	11.64	10.95	10.30	9.705	10.202	9.617	9.797	9.180	8.830	9.593	8.673	8.158	7.975	20	28.63	20.44	15.33	12.68	11.90	11.10	10.43	10.982	10.327	10.490	9.801	9.415	10.240	9.227	8.642	8.421	30	33.69	22.95	16.73	13.63	12.75	11.80	11.08	11.67	10.952	11.095	10.341	9.922	10.801	9.704	9.057	8.799	40	39.39	25.52	18.08	14.51	13.54	12.46	11.66	12.304	11.52	11.646	10.831	10.380	11.309	10.134	9.427	9.136	50	46.00	28.21	19.42	15.36	14.30	13.07	12.22	12.90	12.06	12.16	11.284	10.804	11.779	10.531	9.767	9.442	60	53.90	31.07	20.76	16.18	15.05	13.66	12.74	13.47	12.57	12.64	11.71	11.20	12.22	10.90	10.08	9.727	75	69.4	35.77	22.81	17.40	16.16	14.50	13.51	14.28	13.30	13.34	12.32	11.77	12.85	11.43	10.53	10.12	80	75.9	37.47	23.51	17.80	16.54	14.78	13.77	14.55	13.55	13.56	12.52	11.95	13.05	11.60	10.67	10.25	100	45.21	26.46	19.43	18.05	15.86	14.77	15.59	14.50	14.42	13.27	12.65	13.83	13.24	11.21	10.73		125	57.88	30.59	21.56	20.03	17.22	16.04	16.87	15.70	15.46	14.17	13.51	14.76	13.01	11.84	11.28		150	76.5	35.40	23.83	22.14	18.61	17.33	18.18	16.91	16.47	15.06	14.35	15.65	13.75	12.44	11.80		160	86.8	37.57	24.79	23.03	19.17	17.85	18.71	17.41	16.88	15.41	14.69	16.00	14.05	12.68	12.00		175	41.16	26.29	24.43	20.04	18.66	19.52	18.16	17.48	15.94	15.20	16.52	14.49	13.03	12.29			200	48.24	29.00	26.95	21.53	20.05	20.91	19.45	18.48	16.84	16.05	17.39	15.23	13.62	12.77			250	69.1	35.40	32.89	24.78	23.08	23.90	22.24	20.57	18.68	17.81	19.11	16.73	14.78	13.69			300	41.72	40.62	28.50	26.53	27.27	25.37	22.79	20.62	19.66	20.89	18.28	15.95	14.59				400	72.2	67.0	38.05	35.43	35.71	33.22	27.82	24.99	23.82	24.74	21.64	18.39	16.41				425	84.2	78.3	41.08	38.26	38.33	35.65	29.24	26.21	24.98	25.78	22.55	19.03	16.87				600	78.5	73.1	41.08	38.26	38.33	35.65	29.24	26.21	24.98	25.78	22.55	19.03	16.87																																																																							
lb/in ² gage																	5	21.69	16.57	13.01	11.05	10.42	9.838	9.288	9.755	9.209	9.397	8.820	8.491	9.218	8.351	7.874	7.713	10	23.97	17.90	13.83	11.64	10.95	10.30	9.705	10.202	9.617	9.797	9.180	8.830	9.593	8.673	8.158	7.975	20	28.63	20.44	15.33	12.68	11.90	11.10	10.43	10.982	10.327	10.490	9.801	9.415	10.240	9.227	8.642	8.421	30	33.69	22.95	16.73	13.63	12.75	11.80	11.08	11.67	10.952	11.095	10.341	9.922	10.801	9.704	9.057	8.799	40	39.39	25.52	18.08	14.51	13.54	12.46	11.66	12.304	11.52	11.646	10.831	10.380	11.309	10.134	9.427	9.136	50	46.00	28.21	19.42	15.36	14.30	13.07	12.22	12.90	12.06	12.16	11.284	10.804	11.779	10.531	9.767	9.442	60	53.90	31.07	20.76	16.18	15.05	13.66	12.74	13.47	12.57	12.64	11.71	11.20	12.22	10.90	10.08	9.727	75	69.4	35.77	22.81	17.40	16.16	14.50	13.51	14.28	13.30	13.34	12.32	11.77	12.85	11.43	10.53	10.12	80	75.9	37.47	23.51	17.80	16.54	14.78	13.77	14.55	13.55	13.56	12.52	11.95	13.05	11.60	10.67	10.25	100	45.21	26.46	19.43	18.05	15.86	14.77	15.59	14.50	14.42	13.27	12.65	13.83	13.24	11.21	10.73		125	57.88	30.59	21.56	20.03	17.22	16.04	16.87	15.70	15.46	14.17	13.51	14.76	13.01	11.84	11.28		150	76.5	35.40	23.83	22.14	18.61	17.33	18.18	16.91	16.47	15.06	14.35	15.65	13.75	12.44	11.80		160	86.8	37.57	24.79	23.03	19.17	17.85	18.71	17.41	16.88	15.41	14.69	16.00	14.05	12.68	12.00		175	41.16	26.29	24.43	20.04	18.66	19.52	18.16	17.48	15.94	15.20	16.52	14.49	13.03	12.29			200	48.24	29.00	26.95	21.53	20.05	20.91	19.45	18.48	16.84	16.05	17.39	15.23	13.62	12.77			250	69.1	35.40	32.89	24.78	23.08	23.90	22.24	20.57	18.68	17.81	19.11	16.73	14.78	13.69			300	41.72	40.62	28.50	26.53	27.27	25.37	22.79	20.62	19.66	20.89	18.28	15.95	14.59				400	72.2	67.0	38.05	35.43	35.71	33.22	27.82	24.99	23.82	24.74	21.64	18.39	16.41				425	84.2	78.3	41.08	38.26	38.33	35.65	29.24	26.21	24.98	25.78	22.55	19.03	16.87				600	78.5	73.1	41.08	38.26	38.33	35.65	29.24	26.21	24.98	25.78	22.55	19.03	16.87																																																																																								
5	21.69	16.57	13.01	11.05	10.42	9.838	9.288	9.755	9.209	9.397	8.820	8.491	9.218	8.351	7.874	7.713	10	23.97	17.90	13.83	11.64	10.95	10.30	9.705	10.202	9.617	9.797	9.180	8.830	9.593	8.673	8.158	7.975	20	28.63	20.44	15.33	12.68	11.90	11.10	10.43	10.982	10.327	10.490	9.801	9.415	10.240	9.227	8.642	8.421	30	33.69	22.95	16.73	13.63	12.75	11.80	11.08	11.67	10.952	11.095	10.341	9.922	10.801	9.704	9.057	8.799	40	39.39	25.52	18.08	14.51	13.54	12.46	11.66	12.304	11.52	11.646	10.831	10.380	11.309	10.134	9.427	9.136	50	46.00	28.21	19.42	15.36	14.30	13.07	12.22	12.90	12.06	12.16	11.284	10.804	11.779	10.531	9.767	9.442	60	53.90	31.07	20.76	16.18	15.05	13.66	12.74	13.47	12.57	12.64	11.71	11.20	12.22	10.90	10.08	9.727	75	69.4	35.77	22.81	17.40	16.16	14.50	13.51	14.28	13.30	13.34	12.32	11.77	12.85	11.43	10.53	10.12	80	75.9	37.47	23.51	17.80	16.54	14.78	13.77	14.55	13.55	13.56	12.52	11.95	13.05	11.60	10.67	10.25	100	45.21	26.46	19.43	18.05	15.86	14.77	15.59	14.50	14.42	13.27	12.65	13.83	13.24	11.21	10.73		125	57.88	30.59	21.56	20.03	17.22	16.04	16.87	15.70	15.46	14.17	13.51	14.76	13.01	11.84	11.28		150	76.5	35.40	23.83	22.14	18.61	17.33	18.18	16.91	16.47	15.06	14.35	15.65	13.75	12.44	11.80		160	86.8	37.57	24.79	23.03	19.17	17.85	18.71	17.41	16.88	15.41	14.69	16.00	14.05	12.68	12.00		175	41.16	26.29	24.43	20.04	18.66	19.52	18.16	17.48	15.94	15.20	16.52	14.49	13.03	12.29			200	48.24	29.00	26.95	21.53	20.05	20.91	19.45	18.48	16.84	16.05	17.39	15.23	13.62	12.77			250	69.1	35.40	32.89	24.78	23.08	23.90	22.24	20.57	18.68	17.81	19.11	16.73	14.78	13.69			300	41.72	40.62	28.50	26.53	27.27	25.37	22.79	20.62	19.66	20.89	18.28	15.95	14.59				400	72.2	67.0	38.05	35.43	35.71	33.22	27.82	24.99	23.82	24.74	21.64	18.39	16.41				425	84.2	78.3	41.08	38.26	38.33	35.65	29.24	26.21	24.98	25.78	22.55	19.03	16.87				600	78.5	73.1	41.08	38.26	38.33	35.65	29.24	26.21	24.98	25.78	22.55	19.03	16.87																																																																																																									
10	23.97	17.90	13.83	11.64	10.95	10.30	9.705	10.202	9.617	9.797	9.180	8.830	9.593	8.673	8.158	7.975	20	28.63	20.44	15.33	12.68	11.90	11.10	10.43	10.982	10.327	10.490	9.801	9.415	10.240	9.227	8.642	8.421	30	33.69	22.95	16.73	13.63	12.75	11.80	11.08	11.67	10.952	11.095	10.341	9.922	10.801	9.704	9.057	8.799	40	39.39	25.52	18.08	14.51	13.54	12.46	11.66	12.304	11.52	11.646	10.831	10.380	11.309	10.134	9.427	9.136	50	46.00	28.21	19.42	15.36	14.30	13.07	12.22	12.90	12.06	12.16	11.284	10.804	11.779	10.531	9.767	9.442	60	53.90	31.07	20.76	16.18	15.05	13.66	12.74	13.47	12.57	12.64	11.71	11.20	12.22	10.90	10.08	9.727	75	69.4	35.77	22.81	17.40	16.16	14.50	13.51	14.28	13.30	13.34	12.32	11.77	12.85	11.43	10.53	10.12	80	75.9	37.47	23.51	17.80	16.54	14.78	13.77	14.55	13.55	13.56	12.52	11.95	13.05	11.60	10.67	10.25	100	45.21	26.46	19.43	18.05	15.86	14.77	15.59	14.50	14.42	13.27	12.65	13.83	13.24	11.21	10.73		125	57.88	30.59	21.56	20.03	17.22	16.04	16.87	15.70	15.46	14.17	13.51	14.76	13.01	11.84	11.28		150	76.5	35.40	23.83	22.14	18.61	17.33	18.18	16.91	16.47	15.06	14.35	15.65	13.75	12.44	11.80		160	86.8	37.57	24.79	23.03	19.17	17.85	18.71	17.41	16.88	15.41	14.69	16.00	14.05	12.68	12.00		175	41.16	26.29	24.43	20.04	18.66	19.52	18.16	17.48	15.94	15.20	16.52	14.49	13.03	12.29			200	48.24	29.00	26.95	21.53	20.05	20.91	19.45	18.48	16.84	16.05	17.39	15.23	13.62	12.77			250	69.1	35.40	32.89	24.78	23.08	23.90	22.24	20.57	18.68	17.81	19.11	16.73	14.78	13.69			300	41.72	40.62	28.50	26.53	27.27	25.37	22.79	20.62	19.66	20.89	18.28	15.95	14.59				400	72.2	67.0	38.05	35.43	35.71	33.22	27.82	24.99	23.82	24.74	21.64	18.39	16.41				425	84.2	78.3	41.08	38.26	38.33	35.65	29.24	26.21	24.98	25.78	22.55	19.03	16.87				600	78.5	73.1	41.08	38.26	38.33	35.65	29.24	26.21	24.98	25.78	22.55	19.03	16.87																																																																																																																										
20	28.63	20.44	15.33	12.68	11.90	11.10	10.43	10.982	10.327	10.490	9.801	9.415	10.240	9.227	8.642	8.421	30	33.69	22.95	16.73	13.63	12.75	11.80	11.08	11.67	10.952	11.095	10.341	9.922	10.801	9.704	9.057	8.799	40	39.39	25.52	18.08	14.51	13.54	12.46	11.66	12.304	11.52	11.646	10.831	10.380	11.309	10.134	9.427	9.136	50	46.00	28.21	19.42	15.36	14.30	13.07	12.22	12.90	12.06	12.16	11.284	10.804	11.779	10.531	9.767	9.442	60	53.90	31.07	20.76	16.18	15.05	13.66	12.74	13.47	12.57	12.64	11.71	11.20	12.22	10.90	10.08	9.727	75	69.4	35.77	22.81	17.40	16.16	14.50	13.51	14.28	13.30	13.34	12.32	11.77	12.85	11.43	10.53	10.12	80	75.9	37.47	23.51	17.80	16.54	14.78	13.77	14.55	13.55	13.56	12.52	11.95	13.05	11.60	10.67	10.25	100	45.21	26.46	19.43	18.05	15.86	14.77	15.59	14.50	14.42	13.27	12.65	13.83	13.24	11.21	10.73		125	57.88	30.59	21.56	20.03	17.22	16.04	16.87	15.70	15.46	14.17	13.51	14.76	13.01	11.84	11.28		150	76.5	35.40	23.83	22.14	18.61	17.33	18.18	16.91	16.47	15.06	14.35	15.65	13.75	12.44	11.80		160	86.8	37.57	24.79	23.03	19.17	17.85	18.71	17.41	16.88	15.41	14.69	16.00	14.05	12.68	12.00		175	41.16	26.29	24.43	20.04	18.66	19.52	18.16	17.48	15.94	15.20	16.52	14.49	13.03	12.29			200	48.24	29.00	26.95	21.53	20.05	20.91	19.45	18.48	16.84	16.05	17.39	15.23	13.62	12.77			250	69.1	35.40	32.89	24.78	23.08	23.90	22.24	20.57	18.68	17.81	19.11	16.73	14.78	13.69			300	41.72	40.62	28.50	26.53	27.27	25.37	22.79	20.62	19.66	20.89	18.28	15.95	14.59				400	72.2	67.0	38.05	35.43	35.71	33.22	27.82	24.99	23.82	24.74	21.64	18.39	16.41				425	84.2	78.3	41.08	38.26	38.33	35.65	29.24	26.21	24.98	25.78	22.55	19.03	16.87				600	78.5	73.1	41.08	38.26	38.33	35.65	29.24	26.21	24.98	25.78	22.55	19.03	16.87																																																																																																																																											
30	33.69	22.95	16.73	13.63	12.75	11.80	11.08	11.67	10.952	11.095	10.341	9.922	10.801	9.704	9.057	8.799	40	39.39	25.52	18.08	14.51	13.54	12.46	11.66	12.304	11.52	11.646	10.831	10.380	11.309	10.134	9.427	9.136	50	46.00	28.21	19.42	15.36	14.30	13.07	12.22	12.90	12.06	12.16	11.284	10.804	11.779	10.531	9.767	9.442	60	53.90	31.07	20.76	16.18	15.05	13.66	12.74	13.47	12.57	12.64	11.71	11.20	12.22	10.90	10.08	9.727	75	69.4	35.77	22.81	17.40	16.16	14.50	13.51	14.28	13.30	13.34	12.32	11.77	12.85	11.43	10.53	10.12	80	75.9	37.47	23.51	17.80	16.54	14.78	13.77	14.55	13.55	13.56	12.52	11.95	13.05	11.60	10.67	10.25	100	45.21	26.46	19.43	18.05	15.86	14.77	15.59	14.50	14.42	13.27	12.65	13.83	13.24	11.21	10.73		125	57.88	30.59	21.56	20.03	17.22	16.04	16.87	15.70	15.46	14.17	13.51	14.76	13.01	11.84	11.28		150	76.5	35.40	23.83	22.14	18.61	17.33	18.18	16.91	16.47	15.06	14.35	15.65	13.75	12.44	11.80		160	86.8	37.57	24.79	23.03	19.17	17.85	18.71	17.41	16.88	15.41	14.69	16.00	14.05	12.68	12.00		175	41.16	26.29	24.43	20.04	18.66	19.52	18.16	17.48	15.94	15.20	16.52	14.49	13.03	12.29			200	48.24	29.00	26.95	21.53	20.05	20.91	19.45	18.48	16.84	16.05	17.39	15.23	13.62	12.77			250	69.1	35.40	32.89	24.78	23.08	23.90	22.24	20.57	18.68	17.81	19.11	16.73	14.78	13.69			300	41.72	40.62	28.50	26.53	27.27	25.37	22.79	20.62	19.66	20.89	18.28	15.95	14.59				400	72.2	67.0	38.05	35.43	35.71	33.22	27.82	24.99	23.82	24.74	21.64	18.39	16.41				425	84.2	78.3	41.08	38.26	38.33	35.65	29.24	26.21	24.98	25.78	22.55	19.03	16.87				600	78.5	73.1	41.08	38.26	38.33	35.65	29.24	26.21	24.98	25.78	22.55	19.03	16.87																																																																																																																																																												
40	39.39	25.52	18.08	14.51	13.54	12.46	11.66	12.304	11.52	11.646	10.831	10.380	11.309	10.134	9.427	9.136	50	46.00	28.21	19.42	15.36	14.30	13.07	12.22	12.90	12.06	12.16	11.284	10.804	11.779	10.531	9.767	9.442	60	53.90	31.07	20.76	16.18	15.05	13.66	12.74	13.47	12.57	12.64	11.71	11.20	12.22	10.90	10.08	9.727	75	69.4	35.77	22.81	17.40	16.16	14.50	13.51	14.28	13.30	13.34	12.32	11.77	12.85	11.43	10.53	10.12	80	75.9	37.47	23.51	17.80	16.54	14.78	13.77	14.55	13.55	13.56	12.52	11.95	13.05	11.60	10.67	10.25	100	45.21	26.46	19.43	18.05	15.86	14.77	15.59	14.50	14.42	13.27	12.65	13.83	13.24	11.21	10.73		125	57.88	30.59	21.56	20.03	17.22	16.04	16.87	15.70	15.46	14.17	13.51	14.76	13.01	11.84	11.28		150	76.5	35.40	23.83	22.14	18.61	17.33	18.18	16.91	16.47	15.06	14.35	15.65	13.75	12.44	11.80		160	86.8	37.57	24.79	23.03	19.17	17.85	18.71	17.41	16.88	15.41	14.69	16.00	14.05	12.68	12.00		175	41.16	26.29	24.43	20.04	18.66	19.52	18.16	17.48	15.94	15.20	16.52	14.49	13.03	12.29			200	48.24	29.00	26.95	21.53	20.05	20.91	19.45	18.48	16.84	16.05	17.39	15.23	13.62	12.77			250	69.1	35.40	32.89	24.78	23.08	23.90	22.24	20.57	18.68	17.81	19.11	16.73	14.78	13.69			300	41.72	40.62	28.50	26.53	27.27	25.37	22.79	20.62	19.66	20.89	18.28	15.95	14.59				400	72.2	67.0	38.05	35.43	35.71	33.22	27.82	24.99	23.82	24.74	21.64	18.39	16.41				425	84.2	78.3	41.08	38.26	38.33	35.65	29.24	26.21	24.98	25.78	22.55	19.03	16.87				600	78.5	73.1	41.08	38.26	38.33	35.65	29.24	26.21	24.98	25.78	22.55	19.03	16.87																																																																																																																																																																													
50	46.00	28.21	19.42	15.36	14.30	13.07	12.22	12.90	12.06	12.16	11.284	10.804	11.779	10.531	9.767	9.442	60	53.90	31.07	20.76	16.18	15.05	13.66	12.74	13.47	12.57	12.64	11.71	11.20	12.22	10.90	10.08	9.727	75	69.4	35.77	22.81	17.40	16.16	14.50	13.51	14.28	13.30	13.34	12.32	11.77	12.85	11.43	10.53	10.12	80	75.9	37.47	23.51	17.80	16.54	14.78	13.77	14.55	13.55	13.56	12.52	11.95	13.05	11.60	10.67	10.25	100	45.21	26.46	19.43	18.05	15.86	14.77	15.59	14.50	14.42	13.27	12.65	13.83	13.24	11.21	10.73		125	57.88	30.59	21.56	20.03	17.22	16.04	16.87	15.70	15.46	14.17	13.51	14.76	13.01	11.84	11.28		150	76.5	35.40	23.83	22.14	18.61	17.33	18.18	16.91	16.47	15.06	14.35	15.65	13.75	12.44	11.80		160	86.8	37.57	24.79	23.03	19.17	17.85	18.71	17.41	16.88	15.41	14.69	16.00	14.05	12.68	12.00		175	41.16	26.29	24.43	20.04	18.66	19.52	18.16	17.48	15.94	15.20	16.52	14.49	13.03	12.29			200	48.24	29.00	26.95	21.53	20.05	20.91	19.45	18.48	16.84	16.05	17.39	15.23	13.62	12.77			250	69.1	35.40	32.89	24.78	23.08	23.90	22.24	20.57	18.68	17.81	19.11	16.73	14.78	13.69			300	41.72	40.62	28.50	26.53	27.27	25.37	22.79	20.62	19.66	20.89	18.28	15.95	14.59				400	72.2	67.0	38.05	35.43	35.71	33.22	27.82	24.99	23.82	24.74	21.64	18.39	16.41				425	84.2	78.3	41.08	38.26	38.33	35.65	29.24	26.21	24.98	25.78	22.55	19.03	16.87				600	78.5	73.1	41.08	38.26	38.33	35.65	29.24	26.21	24.98	25.78	22.55	19.03	16.87																																																																																																																																																																																														
60	53.90	31.07	20.76	16.18	15.05	13.66	12.74	13.47	12.57	12.64	11.71	11.20	12.22	10.90	10.08	9.727	75	69.4	35.77	22.81	17.40	16.16	14.50	13.51	14.28	13.30	13.34	12.32	11.77	12.85	11.43	10.53	10.12	80	75.9	37.47	23.51	17.80	16.54	14.78	13.77	14.55	13.55	13.56	12.52	11.95	13.05	11.60	10.67	10.25	100	45.21	26.46	19.43	18.05	15.86	14.77	15.59	14.50	14.42	13.27	12.65	13.83	13.24	11.21	10.73		125	57.88	30.59	21.56	20.03	17.22	16.04	16.87	15.70	15.46	14.17	13.51	14.76	13.01	11.84	11.28		150	76.5	35.40	23.83	22.14	18.61	17.33	18.18	16.91	16.47	15.06	14.35	15.65	13.75	12.44	11.80		160	86.8	37.57	24.79	23.03	19.17	17.85	18.71	17.41	16.88	15.41	14.69	16.00	14.05	12.68	12.00		175	41.16	26.29	24.43	20.04	18.66	19.52	18.16	17.48	15.94	15.20	16.52	14.49	13.03	12.29			200	48.24	29.00	26.95	21.53	20.05	20.91	19.45	18.48	16.84	16.05	17.39	15.23	13.62	12.77			250	69.1	35.40	32.89	24.78	23.08	23.90	22.24	20.57	18.68	17.81	19.11	16.73	14.78	13.69			300	41.72	40.62	28.50	26.53	27.27	25.37	22.79	20.62	19.66	20.89	18.28	15.95	14.59				400	72.2	67.0	38.05	35.43	35.71	33.22	27.82	24.99	23.82	24.74	21.64	18.39	16.41				425	84.2	78.3	41.08	38.26	38.33	35.65	29.24	26.21	24.98	25.78	22.55	19.03	16.87				600	78.5	73.1	41.08	38.26	38.33	35.65	29.24	26.21	24.98	25.78	22.55	19.03	16.87																																																																																																																																																																																																															
75	69.4	35.77	22.81	17.40	16.16	14.50	13.51	14.28	13.30	13.34	12.32	11.77	12.85	11.43	10.53	10.12	80	75.9	37.47	23.51	17.80	16.54	14.78	13.77	14.55	13.55	13.56	12.52	11.95	13.05	11.60	10.67	10.25	100	45.21	26.46	19.43	18.05	15.86	14.77	15.59	14.50	14.42	13.27	12.65	13.83	13.24	11.21	10.73		125	57.88	30.59	21.56	20.03	17.22	16.04	16.87	15.70	15.46	14.17	13.51	14.76	13.01	11.84	11.28		150	76.5	35.40	23.83	22.14	18.61	17.33	18.18	16.91	16.47	15.06	14.35	15.65	13.75	12.44	11.80		160	86.8	37.57	24.79	23.03	19.17	17.85	18.71	17.41	16.88	15.41	14.69	16.00	14.05	12.68	12.00		175	41.16	26.29	24.43	20.04	18.66	19.52	18.16	17.48	15.94	15.20	16.52	14.49	13.03	12.29			200	48.24	29.00	26.95	21.53	20.05	20.91	19.45	18.48	16.84	16.05	17.39	15.23	13.62	12.77			250	69.1	35.40	32.89	24.78	23.08	23.90	22.24	20.57	18.68	17.81	19.11	16.73	14.78	13.69			300	41.72	40.62	28.50	26.53	27.27	25.37	22.79	20.62	19.66	20.89	18.28	15.95	14.59				400	72.2	67.0	38.05	35.43	35.71	33.22	27.82	24.99	23.82	24.74	21.64	18.39	16.41				425	84.2	78.3	41.08	38.26	38.33	35.65	29.24	26.21	24.98	25.78	22.55	19.03	16.87				600	78.5	73.1	41.08	38.26	38.33	35.65	29.24	26.21	24.98	25.78	22.55	19.03	16.87																																																																																																																																																																																																																																
80	75.9	37.47	23.51	17.80	16.54	14.78	13.77	14.55	13.55	13.56	12.52	11.95	13.05	11.60	10.67	10.25	100	45.21	26.46	19.43	18.05	15.86	14.77	15.59	14.50	14.42	13.27	12.65	13.83	13.24	11.21	10.73		125	57.88	30.59	21.56	20.03	17.22	16.04	16.87	15.70	15.46	14.17	13.51	14.76	13.01	11.84	11.28		150	76.5	35.40	23.83	22.14	18.61	17.33	18.18	16.91	16.47	15.06	14.35	15.65	13.75	12.44	11.80		160	86.8	37.57	24.79	23.03	19.17	17.85	18.71	17.41	16.88	15.41	14.69	16.00	14.05	12.68	12.00		175	41.16	26.29	24.43	20.04	18.66	19.52	18.16	17.48	15.94	15.20	16.52	14.49	13.03	12.29			200	48.24	29.00	26.95	21.53	20.05	20.91	19.45	18.48	16.84	16.05	17.39	15.23	13.62	12.77			250	69.1	35.40	32.89	24.78	23.08	23.90	22.24	20.57	18.68	17.81	19.11	16.73	14.78	13.69			300	41.72	40.62	28.50	26.53	27.27	25.37	22.79	20.62	19.66	20.89	18.28	15.95	14.59				400	72.2	67.0	38.05	35.43	35.71	33.22	27.82	24.99	23.82	24.74	21.64	18.39	16.41				425	84.2	78.3	41.08	38.26	38.33	35.65	29.24	26.21	24.98	25.78	22.55	19.03	16.87				600	78.5	73.1	41.08	38.26	38.33	35.65	29.24	26.21	24.98	25.78	22.55	19.03	16.87																																																																																																																																																																																																																																																	
100	45.21	26.46	19.43	18.05	15.86	14.77	15.59	14.50	14.42	13.27	12.65	13.83	13.24	11.21	10.73		125	57.88	30.59	21.56	20.03	17.22	16.04	16.87	15.70	15.46	14.17	13.51	14.76	13.01	11.84	11.28		150	76.5	35.40	23.83	22.14	18.61	17.33	18.18	16.91	16.47	15.06	14.35	15.65	13.75	12.44	11.80		160	86.8	37.57	24.79	23.03	19.17	17.85	18.71	17.41	16.88	15.41	14.69	16.00	14.05	12.68	12.00		175	41.16	26.29	24.43	20.04	18.66	19.52	18.16	17.48	15.94	15.20	16.52	14.49	13.03	12.29			200	48.24	29.00	26.95	21.53	20.05	20.91	19.45	18.48	16.84	16.05	17.39	15.23	13.62	12.77			250	69.1	35.40	32.89	24.78	23.08	23.90	22.24	20.57	18.68	17.81	19.11	16.73	14.78	13.69			300	41.72	40.62	28.50	26.53	27.27	25.37	22.79	20.62	19.66	20.89	18.28	15.95	14.59				400	72.2	67.0	38.05	35.43	35.71	33.22	27.82	24.99	23.82	24.74	21.64	18.39	16.41				425	84.2	78.3	41.08	38.26	38.33	35.65	29.24	26.21	24.98	25.78	22.55	19.03	16.87				600	78.5	73.1	41.08	38.26	38.33	35.65	29.24	26.21	24.98	25.78	22.55	19.03	16.87																																																																																																																																																																																																																																																																		
125	57.88	30.59	21.56	20.03	17.22	16.04	16.87	15.70	15.46	14.17	13.51	14.76	13.01	11.84	11.28		150	76.5	35.40	23.83	22.14	18.61	17.33	18.18	16.91	16.47	15.06	14.35	15.65	13.75	12.44	11.80		160	86.8	37.57	24.79	23.03	19.17	17.85	18.71	17.41	16.88	15.41	14.69	16.00	14.05	12.68	12.00		175	41.16	26.29	24.43	20.04	18.66	19.52	18.16	17.48	15.94	15.20	16.52	14.49	13.03	12.29			200	48.24	29.00	26.95	21.53	20.05	20.91	19.45	18.48	16.84	16.05	17.39	15.23	13.62	12.77			250	69.1	35.40	32.89	24.78	23.08	23.90	22.24	20.57	18.68	17.81	19.11	16.73	14.78	13.69			300	41.72	40.62	28.50	26.53	27.27	25.37	22.79	20.62	19.66	20.89	18.28	15.95	14.59				400	72.2	67.0	38.05	35.43	35.71	33.22	27.82	24.99	23.82	24.74	21.64	18.39	16.41				425	84.2	78.3	41.08	38.26	38.33	35.65	29.24	26.21	24.98	25.78	22.55	19.03	16.87				600	78.5	73.1	41.08	38.26	38.33	35.65	29.24	26.21	24.98	25.78	22.55	19.03	16.87																																																																																																																																																																																																																																																																																			
150	76.5	35.40	23.83	22.14	18.61	17.33	18.18	16.91	16.47	15.06	14.35	15.65	13.75	12.44	11.80		160	86.8	37.57	24.79	23.03	19.17	17.85	18.71	17.41	16.88	15.41	14.69	16.00	14.05	12.68	12.00		175	41.16	26.29	24.43	20.04	18.66	19.52	18.16	17.48	15.94	15.20	16.52	14.49	13.03	12.29			200	48.24	29.00	26.95	21.53	20.05	20.91	19.45	18.48	16.84	16.05	17.39	15.23	13.62	12.77			250	69.1	35.40	32.89	24.78	23.08	23.90	22.24	20.57	18.68	17.81	19.11	16.73	14.78	13.69			300	41.72	40.62	28.50	26.53	27.27	25.37	22.79	20.62	19.66	20.89	18.28	15.95	14.59				400	72.2	67.0	38.05	35.43	35.71	33.22	27.82	24.99	23.82	24.74	21.64	18.39	16.41				425	84.2	78.3	41.08	38.26	38.33	35.65	29.24	26.21	24.98	25.78	22.55	19.03	16.87				600	78.5	73.1	41.08	38.26	38.33	35.65	29.24	26.21	24.98	25.78	22.55	19.03	16.87																																																																																																																																																																																																																																																																																																				
160	86.8	37.57	24.79	23.03	19.17	17.85	18.71	17.41	16.88	15.41	14.69	16.00	14.05	12.68	12.00		175	41.16	26.29	24.43	20.04	18.66	19.52	18.16	17.48	15.94	15.20	16.52	14.49	13.03	12.29			200	48.24	29.00	26.95	21.53	20.05	20.91	19.45	18.48	16.84	16.05	17.39	15.23	13.62	12.77			250	69.1	35.40	32.89	24.78	23.08	23.90	22.24	20.57	18.68	17.81	19.11	16.73	14.78	13.69			300	41.72	40.62	28.50	26.53	27.27	25.37	22.79	20.62	19.66	20.89	18.28	15.95	14.59				400	72.2	67.0	38.05	35.43	35.71	33.22	27.82	24.99	23.82	24.74	21.64	18.39	16.41				425	84.2	78.3	41.08	38.26	38.33	35.65	29.24	26.21	24.98	25.78	22.55	19.03	16.87				600	78.5	73.1	41.08	38.26	38.33	35.65	29.24	26.21	24.98	25.78	22.55	19.03	16.87																																																																																																																																																																																																																																																																																																																					
175	41.16	26.29	24.43	20.04	18.66	19.52	18.16	17.48	15.94	15.20	16.52	14.49	13.03	12.29			200	48.24	29.00	26.95	21.53	20.05	20.91	19.45	18.48	16.84	16.05	17.39	15.23	13.62	12.77			250	69.1	35.40	32.89	24.78	23.08	23.90	22.24	20.57	18.68	17.81	19.11	16.73	14.78	13.69			300	41.72	40.62	28.50	26.53	27.27	25.37	22.79	20.62	19.66	20.89	18.28	15.95	14.59				400	72.2	67.0	38.05	35.43	35.71	33.22	27.82	24.99	23.82	24.74	21.64	18.39	16.41				425	84.2	78.3	41.08	38.26	38.33	35.65	29.24	26.21	24.98	25.78	22.55	19.03	16.87				600	78.5	73.1	41.08	38.26	38.33	35.65	29.24	26.21	24.98	25.78	22.55	19.03	16.87																																																																																																																																																																																																																																																																																																																																						
200	48.24	29.00	26.95	21.53	20.05	20.91	19.45	18.48	16.84	16.05	17.39	15.23	13.62	12.77			250	69.1	35.40	32.89	24.78	23.08	23.90	22.24	20.57	18.68	17.81	19.11	16.73	14.78	13.69			300	41.72	40.62	28.50	26.53	27.27	25.37	22.79	20.62	19.66	20.89	18.28	15.95	14.59				400	72.2	67.0	38.05	35.43	35.71	33.22	27.82	24.99	23.82	24.74	21.64	18.39	16.41				425	84.2	78.3	41.08	38.26	38.33	35.65	29.24	26.21	24.98	25.78	22.55	19.03	16.87				600	78.5	73.1	41.08	38.26	38.33	35.65	29.24	26.21	24.98	25.78	22.55	19.03	16.87																																																																																																																																																																																																																																																																																																																																																							
250	69.1	35.40	32.89	24.78	23.08	23.90	22.24	20.57	18.68	17.81	19.11	16.73	14.78	13.69			300	41.72	40.62	28.50	26.53	27.27	25.37	22.79	20.62	19.66	20.89	18.28	15.95	14.59				400	72.2	67.0	38.05	35.43	35.71	33.22	27.82	24.99	23.82	24.74	21.64	18.39	16.41				425	84.2	78.3	41.08	38.26	38.33	35.65	29.24	26.21	24.98	25.78	22.55	19.03	16.87				600	78.5	73.1	41.08	38.26	38.33	35.65	29.24	26.21	24.98	25.78	22.55	19.03	16.87																																																																																																																																																																																																																																																																																																																																																																								
300	41.72	40.62	28.50	26.53	27.27	25.37	22.79	20.62	19.66	20.89	18.28	15.95	14.59				400	72.2	67.0	38.05	35.43	35.71	33.22	27.82	24.99	23.82	24.74	21.64	18.39	16.41				425	84.2	78.3	41.08	38.26	38.33	35.65	29.24	26.21	24.98	25.78	22.55	19.03	16.87				600	78.5	73.1	41.08	38.26	38.33	35.65	29.24	26.21	24.98	25.78	22.55	19.03	16.87																																																																																																																																																																																																																																																																																																																																																																																									
400	72.2	67.0	38.05	35.43	35.71	33.22	27.82	24.99	23.82	24.74	21.64	18.39	16.41				425	84.2	78.3	41.08	38.26	38.33	35.65	29.24	26.21	24.98	25.78	22.55	19.03	16.87				600	78.5	73.1	41.08	38.26	38.33	35.65	29.24	26.21	24.98	25.78	22.55	19.03	16.87																																																																																																																																																																																																																																																																																																																																																																																																										
425	84.2	78.3	41.08	38.26	38.33	35.65	29.24	26.21	24.98	25.78	22.55	19.03	16.87				600	78.5	73.1	41.08	38.26	38.33	35.65	29.24	26.21	24.98	25.78	22.55	19.03	16.87																																																																																																																																																																																																																																																																																																																																																																																																																											
600	78.5	73.1	41.08	38.26	38.33	35.65	29.24	26.21	24.98	25.78	22.55	19.03	16.87																																																																																																																																																																																																																																																																																																																																																																																																																																												

* From Theoretical Steam Rate Tables—compatible with the 1967 ASME Steam Tables, ASME 1969.

Turbines having automatic pressure-controlled extractions or admissions of steam between inlet and exhaust usually have their performance expressed by a chart showing required throttle flow vs. load for varying amounts of steam extracted or admitted at specified conditions.

Turbines working on regenerative and/or reheat cycles, condensing, usually have performance expressed as a heat rate, based upon a carefully specified heat cycle arrangement. This is usually illustrated by a diagram that defines all the surrounding conditions. See, for example, Fig. 9.4.26, actual cycle.

The above methods for expressing turbine performance are more satisfactory for most application than the use of turbine "engine efficiencies." However, it is useful to know the general range of turbine efficiency realized in practice. The engine efficiency of a turbine depends mainly upon the flow areas and diameter of stages, the average velocity ratio, as can be deduced from Fig. 9.4.6, 9.4.7, and 9.4.8, the number of turbine stages, and the steam conditions. With so many variables, it is not possible to do more than show a general picture of efficiency as a function of rating, as in Fig. 9.4.22, for multistage condensing turbines. Noncondensing turbines will usually have similar efficiency levels; automatic extraction turbines will generally be slightly lower because of extra losses in the control-stage sections.

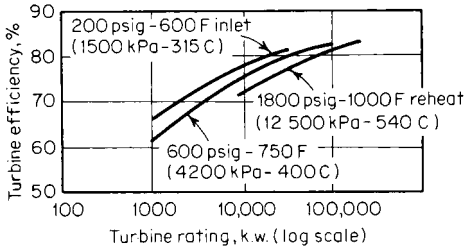

Fig. 9.4.22 Turbine efficiencies vs. capacity.

Approximate steam rates for turbines operating without auxiliary admissions or extractions of steam between inlet and exhaust may be estimated for any turbine rating by dividing theoretical steam rate, corresponding to inlet steam pressure and temperature and exhaust pressure, by the appropriate turbine efficiency from Fig. 9.4.22.

A short method for calculating extraction-turbine performance is illustrated by the following example:

Assume a 12,500-kW automatic-extraction-condensing unit operating at 10,000 kW, with 175,000 lb/h extraction for process at 150 psig with no extraction for feedwater heating, and throttle steam conditions of 850 lb/in², 825°F, exhaust at 2 inHg abs.

PROCEDURE. Find theoretical steam rates (TSR) from Table 9.4.2 or steam

charts; TSR₁ for 850 lb/in², 825°F, 2 inHg is 6.58 lb/kWh; TSR₂ for 850 lb/in², 825°F to 150 lb/in² is 18.61 lb/kWh.

Turbine-generator efficiency from Table 9.4.3, single autoextraction at 80 percent rating (10,000 kW on a 12,500-kW unit), is 78 percent. Efficiency correction for autoextraction (see Table 9.4.3) is 0.92. Then actual steam rate (ASR) is TSR/(efficiency × correction); ASR₁ = 6.58/78% × 0.92 = 9.17 lb/kWh; ASR₂ = 18.61/78% × 0.92 = 25.9 lb/kWh; kW generation from extraction flow = extraction flow/ASR₂ = 175,000/25.9 = 6,760 kW.

kW to be generated by condenser flow = 10,000 - 6,760 = 3,240.

Condenser steam flow required is 3,240 × 9.17 = 29,700 lb/h, or (say) 30,000 lb/h. Total steam flow to throttle then is 175,000 + 30,000 = 205,000 lb/h.

Figure 9.4.23 gives correction factors for speed which differ from 3,600 r/min and is representative of units designed for about 4 inHg abs exhaust pressure.

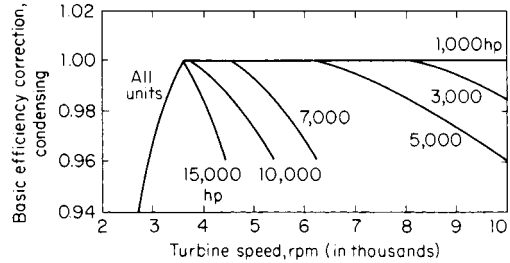

Fig. 9.4.23 Correction factor for condensing mechanical-drive turbines.

Mechanical-Drive Turbines Table 9.4.3 and Figs. 9.4.22 and 9.4.23 provide efficiency-estimating data for typical condensing turbines, primarily for 3600-r/min generator drive. Figure 9.4.24 shows approximate values for turbine efficiency to be expected for noncondensing mechanical-drive units designed for a broad range of horsepower rating, speed, and inlet steam conditions.

Large Central-Station Turbine-Generators

REFERENCES: Spencer, Cotton, and Cannon, A Method for Predicting the Performance of Steam Turbine-Generators . . . 16,500 kW and Larger, *Trans. ASME*, ser. A, Oct. 1963. Baily, Cotton, and Spencer, Predicting the Performance of Large Steam Turbine-Generators Operating with Saturated and Low Superheat Steam Conditions, *Proc. Amer. Power Conf.*, 1967; discussion of foregoing, *Combustion*, Sept. 1967. Spencer and Booth, Heat Rate Performance of Nuclear Steam Turbine-Generators, *Proc. Amer. Power Conf.*, 1968. Baily, Booth, Cotton, and Miller, "Predicting the Performance of 1800-rpm Large Steam Turbine-Generators Operating with Light Water-Cooled Reactors," General Electric publication GET-6020, 1973. "Heat Rates for Fossil Reheat Cycles Using General Electric Steam Turbine-Generators 150,000 kW and Larger," General Electric publication GET-2050C, 1974.

Table 9.4.3 Basic Efficiency for Steam Turbines, Straight Condensing at Rated Load*

kW capacity	Equivalent mechanical drive, hp	Initial steam conditions (gage pressure and temp.)				
		250 lb/in ² 500°F	400 lb/in ² 650°F	600 lb/in ² 750°F	800 lb/in ² 825°F	1,250 lb/in ² 900°F
875	1,200	63	63	62		
1,875	2,600	76	67	66		
2,500	3,500	69	69	68		
5,000	6,900		74	73	73	
7,500	10,300		76	75	75	
12,500	17,200		78	78	78	77
15,625	21,500		79	79	79	77
20,000	27,100		79	80	79	79

* Efficiency correction factors, mechanical drive and auto extraction-condensing turbines—multiply basic efficiencies by:

	At 80% rating	At 100% rating
Single autoextraction-condensing	0.92	0.96
Double autoextraction-condensing	0.88	0.92

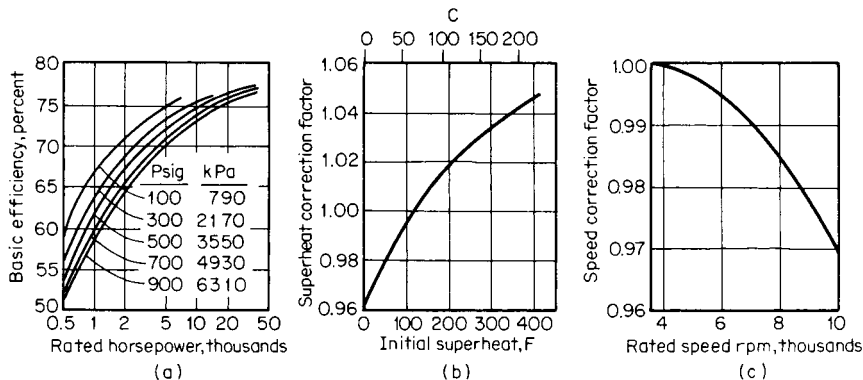

Fig. 9.4.24 Mechanical-drive turbine efficiencies. (a) Basic efficiency, 3,600 r/min. Figures on curve are inlet steam pressure in lb/in² gage. (b) Superheat correction factor. (c) Rated-load speed-correction factor.

The performance of central-station turbine-generators is generally expressed as **heat rate**, Btu/kWh, the ratio of the heat added to the cycle in Btu/h, to generation, in kW. Heat rate may be converted to **thermal efficiency** using the relationship, Efficiency = 3,412.14/heat rate (or 1/heat rate expressed in kJ/kWs). Heat rates are calculated by the preparation of a **heat balance**, which considers steam conditions, steam flow, turbine-expansion efficiency, packing leaking losses, exhaust loss at the end of the low-pressure expansion (perhaps other casings as well), mechanical losses, electrical losses associated with the generator, moisture separation and reheat if present, and extraction for feedwater heating. **Gross heat rate** is calculated without consideration of the power consumed by the boiler feed pump. **Net heat rate** does consider pump power and is higher (poorer) than gross by a factor related to the initial steam pressure. If the pump is driven by an auxiliary turbine, as is the present usual practice, net heat rate is the natural result of the heat-balance calculation, and gross heat rate has little meaning. **Net station heat rate** considers the auxiliary power required by the rest of the power-plant equipment, and the boiler efficiency of fossil plants. It is generally about 3 percent higher than net heat rate in nuclear plants (3 percent auxiliary power, 100 percent "boiler" efficiency), and about 16 percent higher than net heat in the case of a coal-fired plant (4 percent auxiliary power, 90 percent boiler efficiency).

A typical current value of net station heat rate for the fossil steam conditions is 9,000 Btu/kWh (2.64 kJ/kWs), equivalent to a thermal efficiency of 38 percent. A typical net station heat rate for a large light-water nuclear-reactor plant is about 10,100 Btu/kWh (2.96 kJ/kWs), or about 34 percent thermal efficiency.

Table 9.4.4 lists representative net heat rates for large fossil turbines

of today's types and steam conditions. Steam pressures in excess of 3,500 lb/in² gage (24,200 kPa) and initial and reheat temperatures in excess of 1,000°F (538°C) were frequently employed in the past. However, a number of operating and economic considerations have led to near standardization on the single reheat cycle with initial pressure of 2,400 or 3,500 lb/in² gage (16,650 or 24,240 kPa), with initial and reheat temperature of 1,000°F (538°C).

Table 9.4.5 lists some representative net heat rates for large nuclear turbines for service with steam from boiling-water reactors (BWR), at 950 lb/in² gage (6,650 kPa), ½ percent initial moisture. Values for other light-water reactors may be approximated by reducing heat rate by 1 percent for each 100 lb/in² (690 kPa) pressure increase, reducing heat rate by 0.15 percent for reducing initial moisture to 0 percent, reducing heat rate by 0.3 percent for each 10°F (6°C) of initial superheat provided.

Reheating with Regenerative Cycle

REFERENCES: Reynolds, Reheating in Steam Turbines, *Trans. ASME*, **71**, 1949, p. 701. Harris and White, Development in Resuperheating in Steam Power Plants, *Trans. ASME*, **71**, 1949, p. 685.

Reheating is currently used on all new large fossil central-station turbines. It is accomplished by taking the steam from the turbine after partial expansion, reheating it in a separate section of the boiler, and returning it to the next lower-pressure section of the turbine. Reheating results in lowering of the turbine heat rate by approximately 5 percent; the exact improvement is dependent on several factors. Roughly speaking, 40 percent of the improvement comes from having added heat to

Table 9.4.4 Representative Net Heat Rates for Large Fossil Central-Station Turbine-Generators

Nominal rating, MW, at 1.5 inHg abs	Steam conditions			Tandem compound, 3,600 r/min. last-stage buckets				Boiler feed-pump drive	Net heat rate, Btu/kWh, at rated load and steam conditions, and at exhaust pressure, inHg abs				
	Throttle pressure lb/in ² gage	Temp, °F	Reheat temp, °F	No. of rows	Length, in	Exhaust area, ft ²	Approx kW/ft ²		1.5	2	3	4	5
150	1,800	1,000	1,000	2	26	82	1,820	Motor	8,010	8,060	8,230	8,440	8,630
235	1,800	1,000	1,000	2	26	82	2,860	Motor	8,240	8,240	8,290	8,380	8,500
250	1,800	1,000	1,000	2	30	111	2,250	Motor	8,080	8,100	8,220	8,400	8,620
250	1,800	1,000	1,000	2	30	111	2,250	Turbine	8,030	8,060	8,200	8,390	8,610
250	2,400	1,000	1,000	2	30	111	2,250	Turbine	7,850	7,890	8,030	8,240	8,450
500	2,400	1,000	1,000	4	30	222	2,250	Turbine	7,790	7,830	7,970	8,170	8,370
700	2,400	1,000	1,000	4	33.5	264	2,650	Turbine	7,860	7,870	7,970	8,130	8,320
1,000	2,400	1,000	1,000	6	30	334	3,000	Turbine	7,920	7,930	8,000	8,100	8,250
500	3,500	1,000	1,000	4	30	222	2,250	Turbine	7,620	7,660	7,820	8,030	8,220
700	3,500	1,000	1,000	4	33.5	264	2,650	Turbine	7,670	7,690	7,810	7,980	8,170
1,000	3,500	1,000	1,000	6	30	334	3,000	Turbine	7,710	7,730	7,810	7,940	8,090
1,100	3,500	1,000	1,000	6	33.5	397	2,770	Turbine	7,680	7,700	7,810	7,960	8,140

Table 9.4.5 Representative Net Heat Rates for Large Nuclear Central-Station Turbine-Generators

Warranted reactor thermal power, MWT	Nominal turbine rating, MWe at 2 inHg abs	Tandem compound, 1,800 r/min, last-stage buckets				Net heat rate, Btu/kWh, at warranted reactor thermal power, at rated steam conditions, and at exhaust pressure, inHg abs				
		No. of rows	Length, in	Exhaust area, ft ²	Approx kW/ft ²	1.5	2	3	4	5
2,440	840	4	38	423	1,980	9,950	9,950	10,090	10,190	10,410
2,440	850	4	43	495	1,720	9,810	9,820	9,950	10,170	10,440
2,890	1,010	6	38	634	1,590	9,750	9,780	9,950	10,200	10,480
2,890	990	4	43	495	2,000	9,980	9,980	10,050	10,200	10,410
3,580	1,230	6	38	634	1,940	9,910	9,920	10,000	10,170	10,380
3,580	1,250	6	43	743	1,680	9,780	9,790	9,930	10,160	10,430
3,830	1,310	6	38	634	2,070	9,990	9,990	10,050	10,190	10,390
3,830	1,330	6	43	743	1,790	9,840	9,850	9,960	10,170	10,420

All units boiling-water reactor steam conditions of 965 lb/in² abs, 1,190.8 Btu/lb, and two stage steam reheat with 25°F approach to reheating steam temperature.

the cycle at a higher-than-average temperature (thermodynamic gain), and the remaining 60 percent comes from improvement in turbine efficiency due to reduced moisture loss and increased reheat factor.

Reheating can theoretically be done any number of times, but because of extra cost of apparatus and piping, and the steam pressure drops required in practice (8 to 10 percent of the reheat pressure), the economic gains diminish rapidly with more than one reheating (see Fig. 9.4.25). In a few cases, two reheatings are employed. (See also Sec. 4.)

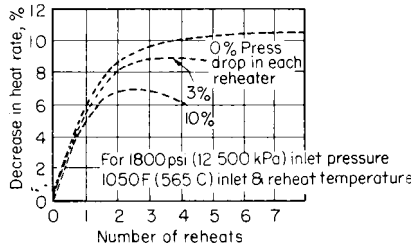

Fig. 9.4.25 Approximate gains due to reheating.

The throttle and condenser steam-flow rates for a given turbine output are reduced approximately 17 and 13 percent, respectively, by reheating once to the initial temperature, as compared with no reheat with the same initial steam conditions.

The maximum gain in heat rate from one reheating with a fixed-percentage pressure drop through the reheating system occurs when the reheat pressure is about 0.15 of the initial pressure. In practice, however, the reheat pressure is higher, 0.20 to 0.30 times initial pressure, because of the extra cost of larger piping, valves, etc., required for lower reheat pressures owing to the larger steam volume.

Regenerative Feedwater Heating

(See also Sec. 4.)

The heat consumption of a turbine may be reduced by heating the condensate (feedwater) in stages by the condensation of steam extracted at various points from the turbine. This is shown diagrammatically for an ideal cycle and a more practical cycle in Fig. 9.4.26. The difference between the two is in the use of mixing heaters in the ideal cycle with each discharge pumped back while the practical cycle has closed heaters with cascaded drains in the upper and pumped drains in the lowest heater, together with some pressure drop between turbine and heaters and a terminal temperature difference between saturated-steam temperature in the heater and feedwater temperature coming out. Usually the difference between such an ideal and a practical cycle is about 1½ percent. A deaerating type of contact heater with no terminal difference may be substituted for one of the closed heaters as is shown in

Fig. 9.4.26. Other variations are the use of (1) all open-contact heaters, or (2) drain coolers to reduce the loss due to cascading the drips, or (3) a desuperheating section on the top heater to get a higher final feed temperature, thereby approaching most closely to the ideal cycle.

Figures 9.4.27 and 9.4.28 and Table 9.4.6 supply data on the results of regenerative heating based on the ideal cycle of Fig. 9.4.26. Figure 9.4.27 shows the reduction in heat rate for various initial pressures and

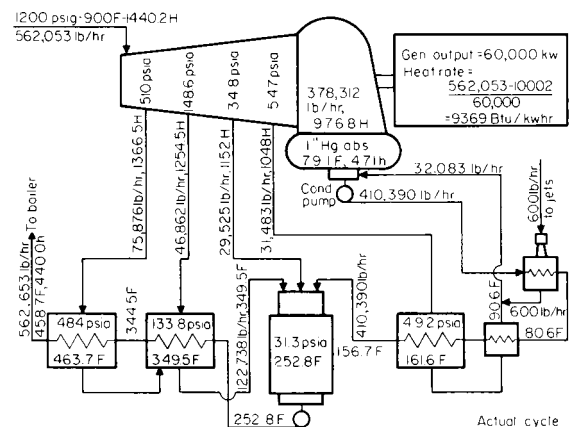
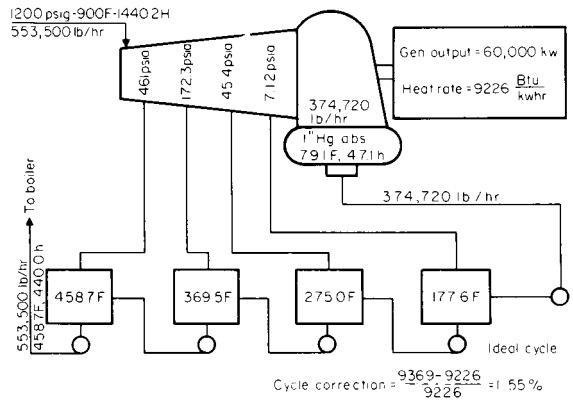

Fig. 9.4.26 Comparison of ideal and actual cycles for regenerative feedwater heating.

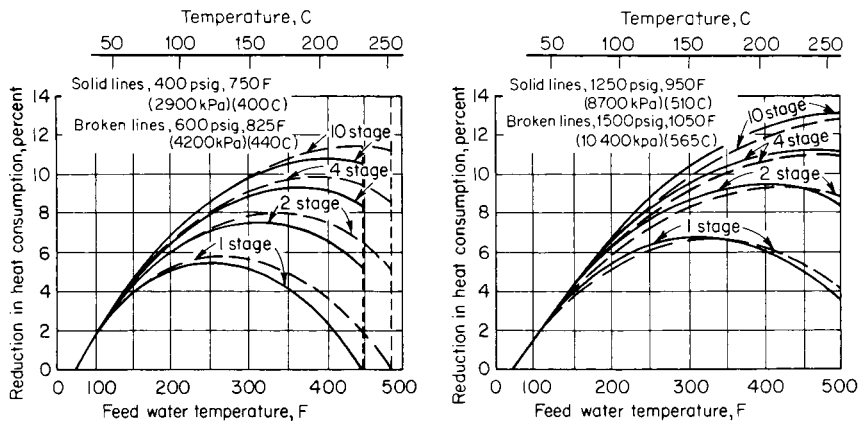

Fig. 9.4.27 Reduction in heat rate by use of ideal regenerative cycle, with 1-inHg back pressure.

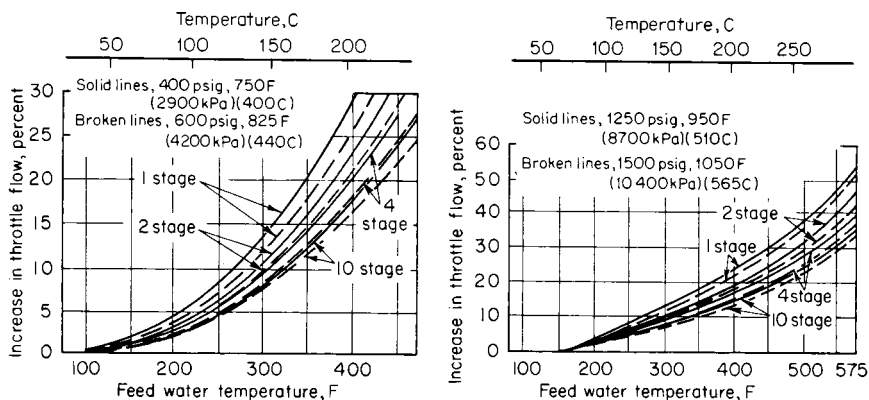

Fig. 9.4.28 Increase in steam flow necessary to maintain the same power output when using the ideal regenerative cycle, with 1-inHg back pressure.

temperatures at 1 inHg abs (3.4 kPa) exhaust pressure, for various feed-water temperatures and number of heaters. The increase in throttle flow necessary to maintain the same power output when extracting steam for feedwater heating is shown in Fig. 9.4.28.

INSTALLATION, OPERATION, AND MAINTENANCE CONSIDERATIONS

Steam turbines are capable of long life and high reliability with relatively little maintenance, if proper attention is paid to their installation,

operation, and preventive maintenance. This section considers four areas proved to be of particular importance by operating experience.

Steam Temperature—Starting and Loading

REFERENCES: Mora et al., "Design and Operation of Large Fossil-Fueled Steam Turbines Engaged in Cyclic Duty," ASME/IEEE Joint Power Generation Conference, Oct. 1979. Spencer and Timo, Starting and Loading of Large Steam Turbines, *Proc. Amer. Power Conf.*, 1974. Ipsen and Timo, The Design of Turbines for Frequent Starting, *Proc. Amer. Power Conf.*, 1969. Timo and Sarney, "The Operation of Large Steam Turbines to Limit Cyclic Shell Cracking," ASME Paper 67-WA/PWR-4, 1967.

Table 9.4.6 Total Steam Bled, Percent of Throttle Flow

Final feed temp		Stages of feedwater heating							
		2		10		2		10	
°F	°C								
150	65	7.0	7.1	6.9	7.0				
200	93	11.4	11.8	11.3	11.6	11.2	11.5	10.7	11.0
250	121	15.6	16.2	15.5	16.0	15.5	15.9	12.6	13.1
300	149	19.6	20.6	19.5	20.4	19.5	20.3	18.8	19.5
350	177	23.6	24.8	23.5	24.6	23.6	24.6	20.7	21.6
400	204	27.1	29.0	27.1	28.8	27.4	28.9	26.4	27.8
450	232			30.2	32.5	31.1	33.2	30.0	32.0
500	260					35.0	37.4	33.9	36.1

Changing steam temperature at constant load or changing load at constant temperature subjects rotors and shells to thermal transients. Whereas temperature and load may be changed in seconds, it may take heavy metal sections hours to reach equilibrium with the new temperatures imposed on their surfaces. Parts are subjected to transient thermal stresses which may deplete their low-cycle thermal fatigue life. Repeated thermal cycles may lead to full expenditure of the available fatigue life of the part, followed by surface cracking. Further cycles tend to drive the cracks deeper into the affected part, leading to steam leakage through shells or vibration problems with rotors. Cracks tend to be driven deeper by downward steam-temperature changes, since the surface chills faster than the underlying material and is stressed in tension.

Steam-turbine manufacturers publish specific starting and loading instructions for their units. Data are provided such that the operator may select loading rates that stay within an acceptable expenditure of total low-cycle fatigue life per starting or loading cycle. For example, if a unit is expected to be started and loaded daily for a 30-year life, total cycles will be about 10,000, and it would be desirable to avoid exceeding 0.01 percent life expenditure per daily cycle.

Water-Induction Damage

REFERENCES: Recommended Practices for the Prevention of Water Damage to Steam Turbines Used for Electric Power Generation, ANSI/ASME TDP-1-1985 Fossil Fueled Plants. ASME Standard No. TWPDS-1, Part 2—Nuclear Fueled Plants, Apr. 1973.

Any connection to a steam turbine is a potential source of water either by induction from external equipment or by accumulation of condensed steam. The sources include the following along with their piping and drains: main and reheat steam systems; reheat attemperating system (fossil units); bypass systems, crossaround piping, moisture separator/reheater system (nuclear units); extraction system and feedwater heaters; steam-seal system; turbine-drain system. Water induction may lead to steam-path damage such as broken buckets, thrust-bearing failure, rotor bowing, and shell distortion, which may be indicated by abnormal vibration or differential expansion, or inability to turn the rotor on turning gear.

Water induction may be prevented by proper system installation, provision of protective and indicating devices, and periodic testing, inspection, and maintenance. Detailed recommendations are given in the ANSI/ASME and ASME standards and in manufacturers' instructions.

Lubricating-Oil and Hydraulic-Fluid Purity

Most steam turbines are provided with a lubricating-oil system consisting of reservoir, pumps, coolers, and piping to provide the thrust and journal bearings with a generous supply of oil at the proper temperature and viscosity. Some units also use the lube-oil system as a source of fluid power for control devices and steam-valve actuation. It is most important to assure the cleanliness and purity of the lube oil at all times to avoid bearing and journal damage, or control-system malfunction. Bearings have failed because of oil starvation caused by clogged lines. At least one overspeed failure has resulted from the silting of control devices with rust caused by the entry of water into the oil system.

Units employing an electrohydraulic control system frequently use a synthetic fire-resistant fluid for the high-pressure control hydraulics, separate from the petroleum oil used in the bearing lubrication system. High-pressure hydraulic systems employing synthetic fluid offer advantages in size reduction, speed of response, and fire safety. However, because of the need for very close clearances between small parts at high pressures, and because of the poorer rust-preventing properties of the fluid, cleanliness is of even greater importance than with oil-based systems.

Turbine manufacturers provide equipment such as conditioners to maintain bulk lubricating oil purity and full-flow filters to remove contaminants before they enter bearings. Further, they provide instructions for cleaning oil systems by oil flushing between installation and first operation, and for maintaining the required oil and hydraulic-fluid purity. It is important that these be followed carefully.

Steam Purity

REFERENCES: Lindinger and Curren, "Corrosion Experience in Large Steam Turbines," ASME/IEEE Joint Power Generation Conference, Oct. 1981. Bussert et al., "The Effect of Water Chemistry on the Reliability of Modern Large Steam Turbines," ASME/IEEE Joint Power Generation Conference, Sept. 1978. McCord et al., "Stress Corrosion Cracking of Steam Turbine Materials," National Association of Corrosion Engineers, Apr. 1975.

Boiler feedwater treatments have traditionally been designed to remove solids that might clog steam passages in the boiler, remove salts that could cause scaling of tube surfaces and interfere with heat transfer, prevent corrosion of tube surfaces by reducing oxygen content and by maintaining pH at a high level, and provide "clean" steam to the turbine.

At one time the main concern with steam quality in the turbine was the level of silica present, since that chemical tends to deposit in the steam passages and causes reduction in capacity and efficiency. In general, the monitoring and control of silica has been well developed, and as steam turbines have increased in rating, the passages have increased in area, so that the net effect has been a reduction in the extent of losses in efficiency and capacity from deposits.

On the other hand, the growth in unit ratings has been accomplished without a proportional growth in physical size, and has resulted in greater power densities per casing, per stage, and per pound of material. Such increased duty has required the use of higher-strength alloys operating at higher stresses. As a result, modern turbine components are more susceptible to stress-corrosion cracking than those in older, smaller units, and therefore require better control of contaminants in the steam.

The feedwater treatment in most fossil fuel stations is designed to provide a sufficiently low level of contaminants so that stress-corrosion cracking of turbine components should not be a problem. Both the "zero solids" and the "coordinated phosphate" treatments can be controlled to provide steam of acceptable chemistry. Unfortunately, there are a number of situations in which undesirable chemicals can be introduced in the steam in spite of well-intentioned "normal" water-control practices. For example, the composition of coatings put on turbine components for corrosion protection during shipment, storage, and installation must be controlled. The chemistry of solutions used for the removal of coatings during installation, and the methods used, must be carefully regulated. The turbine must be protected during the chemical cleaning of related components such as the boiler, condenser, and feedwater heaters. Critical components have been damaged by fumes from cleaning. The feedwater system must be designed so that only water of high purity is used for boiler desuperheater sprays, and for the turbine exhaust-hood sprays used to limit temperature during light-load operation. Condensate demineralizers must be operated and regenerated so as to ensure that they do not introduce the harmful chemical they are intended to remove. In the event of a leak into the condenser of impure cooling water, it is important to avoid changing the feedwater treatment in such a way that the turbine is subjected to harmful contaminants introduced to protect other station components.

In each of these undesirable instances, the average concentration of chemicals in the steam can be quite low, but high local concentrations can be developed through several mechanisms. For example, dilute solutions can enter crevices not washed by flowing steam; as water evaporates on heating, the concentration of the solution wetting the surfaces tends to increase. In the case of expansion-joint bellows, chemicals contained in steam condensing on shutdown or cold start-up tend to be trapped and concentrated in the bottom of the bellows convolutions.

Succeeding cycles can lead to dry residue or to concentrated solutions during operating conditions which provide moisture. In the case of the steam path, as the expansion crosses into the moisture region, the first droplets of water condensed from the steam will tend to contain most of the contaminants. Concentration-enhancement factors of 100 to 1,000 can be achieved. In modern reheat turbines the early-moisture region occurs in one of the later few stages of the low-pressure sec-

tion, and at light loads can occur on the most highly stressed last-stage buckets.

Extreme care must be exercised in protecting turbines from chemical contamination during installation, operation, and maintenance. Any deviation from sound feedwater-treatment practice during condenser leaks should be done with the full realization that damage to the turbine may result.

9.5 POWER PLANT HEAT EXCHANGERS

by William J. Bow, assisted by Donald E. Bolt

NOTE: Standards for this industry retain USCS units except as indicated in the text.

SURFACE CONDENSERS

REFERENCE: Heat Exchange Institute Standards for Steam Surface Condensers.

The power plant surface condenser is attached to the low-pressure exhaust of a steam turbine (see Figs. 9.5.1 and 9.5.2). Its purposes are (1) to produce a vacuum or desired back pressure at the turbine exhaust for the improvement of plant heat rate, (2) to condense turbine exhaust steam for reuse in the closed cycle, (3) to deaerate the condensate, and (4) to accept heater drains, makeup water, steam drains, and start-up and emergency drains.

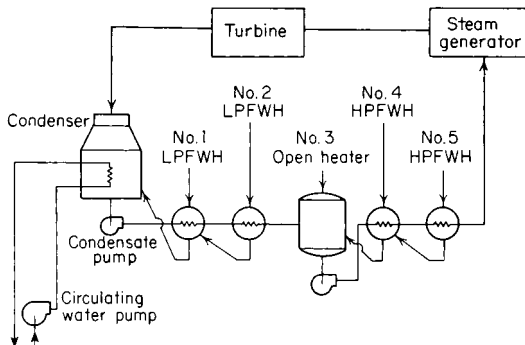

Fig. 9.5.1 Equipment arrangement, schematic.

An economical turbine back pressure is from 1.0 to 3.5 inHg abs. The factors involved in establishing this pressure are involved and will not be discussed here.

An equipment diagram of a closed power plant cycle is shown in Fig. 9.5.1.

For a condenser to deaerate the condensate, it must remove oxygen and other noncondensable gases to an acceptable level compatible with material selection and/or chemical treatment of the feedwater (condensate). Depending on materials and treatment, the dissolved O_2 level must normally be kept below $0.005 \text{ cm}^3/\text{L}$ for turbine units operating with high-pressure and -temperature steam.

Deaeration in a condenser is accomplished by applying Henry's law, which states that the concentration of the dissolved gas in a solution is directly proportional to the partial pressure of that gas in the free space above the condensate level in the hot well, with the exception of those gases (e.g., $CO_2 + NH_3$) which unite chemically with the solvent. In a condenser droplets of condensate are continually scrubbed with steam, liberating the O_2 and permitting it to flow to the low-pressure air-re-

moval section, where it is discharged to the atmosphere by the air-removal equipment.

To remove the last traces of O_2 from the condensate, an ammonia compound such as hydrazine is normally added. Free ammonia is liberated in the cycle and is either removed with the noncondensables as a gas or is condensed and retained in the condensate, depending on the detailed design of the condenser air-removal section. If the ammonia is concentrated as a liquid, it can be very corrosive to certain copper-base materials.

Most condenser manufacturers have **tube-bundle configurations** unique to their design philosophy. Basically, pressure losses from turbine exhaust to the air offtake are kept to a minimum and tubes are arranged to promote good heat-transfer rates. Small condensers are usually cylindrical, whereas large ones are rectangular for better utilization of space. Most turbines exhaust downward into the condenser, but condensers are also built to accommodate side as well as axial exhaust turbines.

Because of the inherent strength of cylindrical shapes as opposed to flat plates, condenser **water boxes** are generally made with curved surfaces. This has come about because of the increased pressure resulting from cooling towers, which in turn, are the result of environmental influences. With a cooling tower, pressures are in the 60 to 80 lb/in² range, whereas with water from lakes, rivers, etc., where a siphon system can be employed, water-box design pressures are in the 20 to 30 lb/in² range.

As a general rule, **tube selection** is based on economics; 18 BWG admiralty metal has been satisfactory for freshwater service and 90-10 copper-nickel material likewise for seawater. The current trend is to use 22 BWG titanium or one of the new specially formulated stainless-steel tube materials for this application. Material prices fluctuate greatly, and selection can be influenced by first cost. Lost revenue due to downtime caused by tube leaks or other causes, particularly in larger units, can usually justify the use of more exotic and expensive materials.

Low-pressure feedwater heaters are frequently located in the steam-inlet neck of a condenser. This is done to minimize pressure drop in the extraction steam piping and to utilize floor space surrounding the condenser better.

A sufficient number of **tube supports** must be provided within the condenser so that the tubes will not vibrate excessively, which will cause tubes to rub or crack circumferentially. During low-water-temperature operation, the steam entering the condenser will often reach sonic velocities, causing severe **flow-induced vibration** and ultimate tube failures if the tube support system is inadequate.

Where once-through boiler or nuclear steam generators are used, it is imperative to dispose of large quantities of steam during starting and stopping of a turbine unit. The condenser, because of its large volume, has been used as a convenient dumping place for this steam. Means must be provided within the condenser to accommodate the high-energy steam without damage to condenser tubing, structural members, or the low-pressure end of the turbine.