

MISCELLANEOUS EXAMPLES OF FORGED
WORK IN DIFFERENT STAGES. PLATE 86

LOCOMOTIVE BRAKE HANGERS

PLATE 86: FIG. 1 illustrates a brake hanger, made from a $2\frac{1}{2}$ -inch square bar. The total length required is $10\frac{1}{2}$ ins. The dimensions are :—

A $2\frac{1}{2}$ ins. diameter by $2\frac{1}{8}$ ins. thick.

B The greatest width is 3 ins. tapered down to $1\frac{3}{8}$ in. at each end, and 1 in. thick.

First operation, FIG. 2 : Use radius cutters to shape the end of the boss as shown, leaving enough material to make a tong end, as shown in FIG. 4. Next, draw down $5\frac{1}{2}$ ins. of the square bar after fullering, as shown in FIGS. 2 and 4.

FIG. 5 shows the method of tapering B, by using tapered sets illustrated in FIG. 7.

FIG. 6 illustrates a pair of stamping swages used to form the bosses A.

BRAKE HANGER. PLATE 86

FIG 1

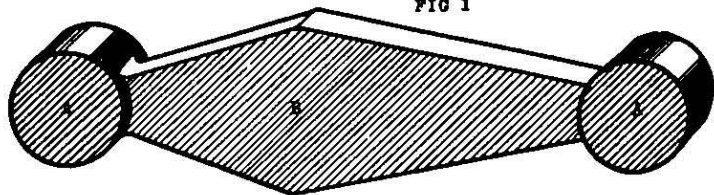

FIG 2

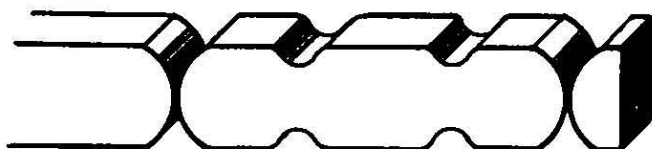

FIG 3

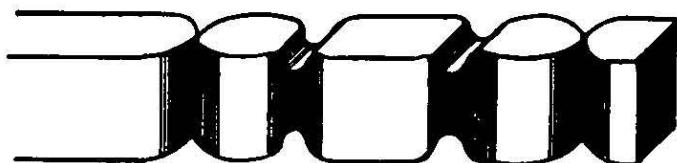

FIG 4

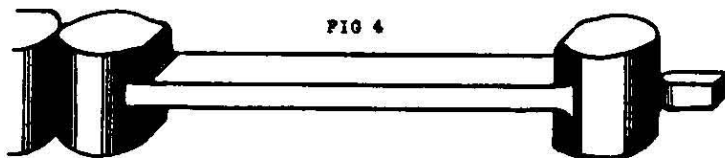

FIG 5

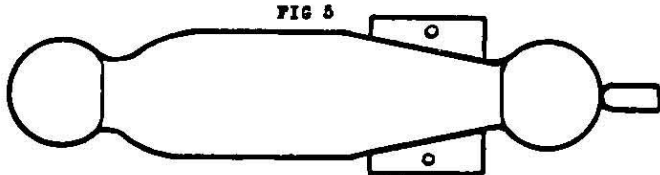

FIG 6

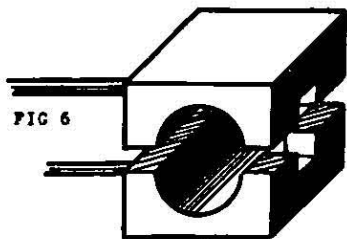
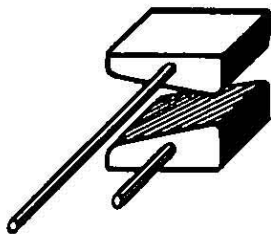

FIG 7



MISCELLANEOUS EXAMPLES OF FORGED
WORK IN DIFFERENT STAGES. PLATE 87

LOCOMOTIVE CONNECTING ROD STRAP

PLATE 87: FIG. 1 illustrates a connecting rod strap, made from $4\frac{1}{2}$ -inch square bar.

First operation, FIG. 2: Side set the $4\frac{1}{2}$ -inch square bar, as shown.

Second operation, FIG. 3: Partly draw down each side of the studs, as shown.

Third operation, FIG. 4: Draw down to the smallest size, as shown.

The reason for forming two studs when forging, is to help when bending, by placing a bridge piece, which is made to the required size, on the forging, as shown in FIG. 5; hammer down, as shown in FIG. 6, then cut off the stud which is not required.

CONNECTING ROD STRAP.

PLATE 87

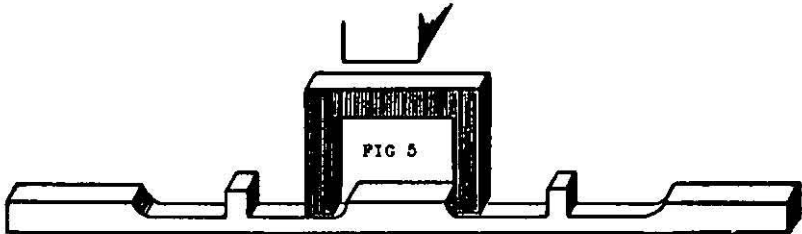
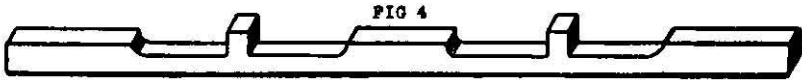
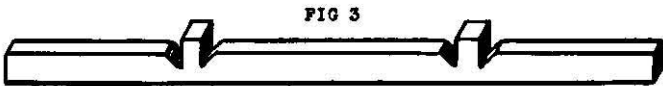
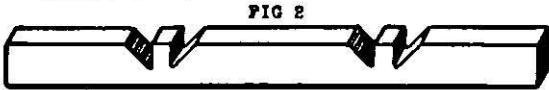
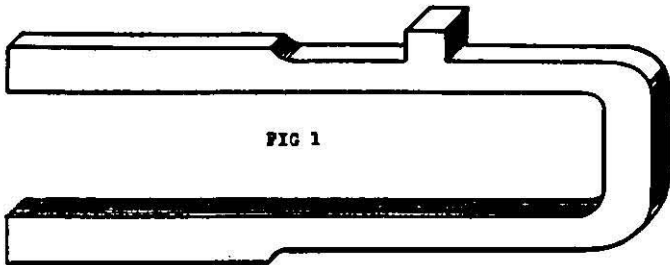
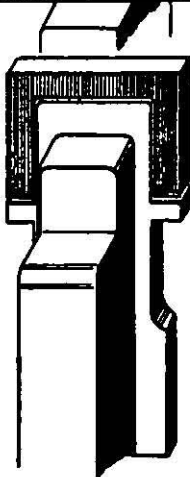

FIG 6



MISCELLANEOUS EXAMPLES OF FORGED
WORK IN DIFFERENT STAGES. PLATE 88

LOCOMOTIVE HORN STAY

PLATE 88: FIG. 1 illustrates a horn stay, made from 6-inch by 4-inch bar.

First operation, FIG. 2 : Side set the 6-inch by 4-inch bar, as shown.

Second operation, FIG. 3 : Draw down to size, side set the ends, and draw down, as shown. When drawing down in between the studs use a narrow block.

Third operation, FIG. 4 : Use a pair of stamps and hammer down, as shown.

Fourth operation, FIG. 5 : Shows the result after using the stamps.

HORN STAY.

PLATE 88

FIG 1

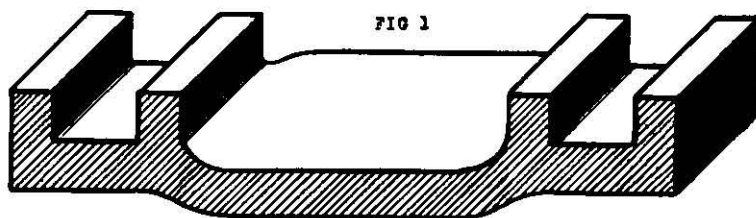

FIG 2

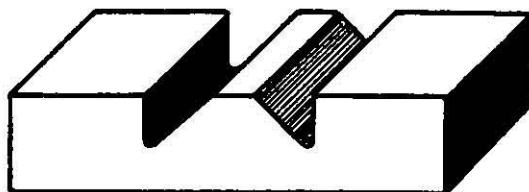

FIG 3

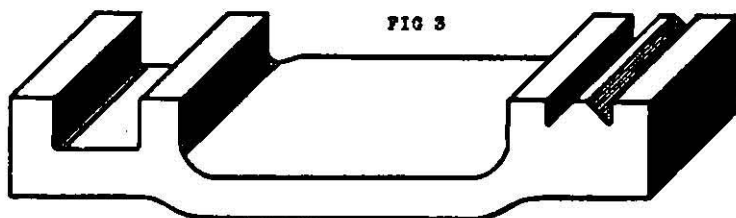

FIG 4

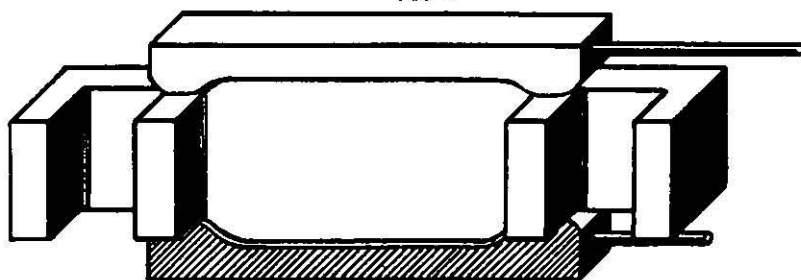
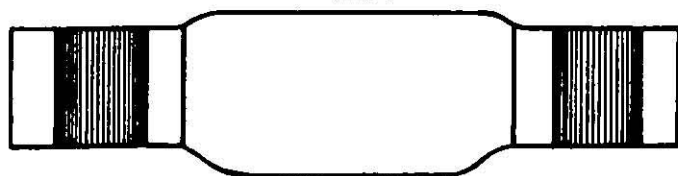

FIG 5



MISCELLANEOUS EXAMPLES OF FORGED
WORK IN DIFFERENT STAGES. PLATE 89

LOCOMOTIVE BRAKE SHAFT (A)

PLATE 89: FIG. 1 illustrates a brake shaft, 4 ft. 6 ins. long, made from 9-inch square bar.

First operation, FIG. 2: Side set the 9-inch square bar as shown, then draw down to 9 ins. by 4 ins., as shown in FIGS. 3 and 4.

Third operation, FIG. 5: Side set as shown, draw down to $3\frac{1}{2}$ ins. diameter, and cut half of the short arms off where marked. The result of these operations are shown in FIG. 6.

Fourth operation, FIG. 6: Drill holes as shown. The forging is then taken to a band saw to be cut along the dotted lines, leaving the result as shown in FIG. 7.

Fifth operation, FIG. 8: Open the arms out, and taper them to the required size. Swage the rest of the shaft to $3\frac{1}{2}$ ins. diameter, as shown.

BRAKE SHAFT. PLATE 89

FIG 1

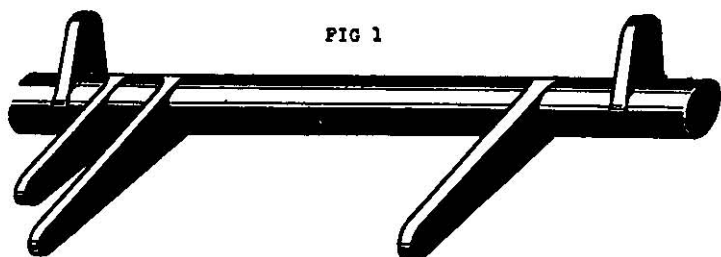

FIG 2

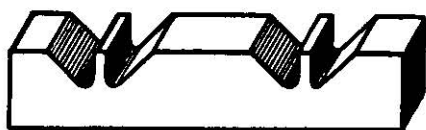

FIG 3

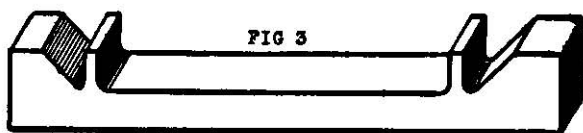

FIG 4

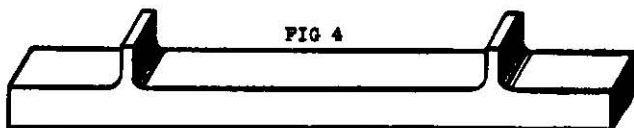

FIG 5

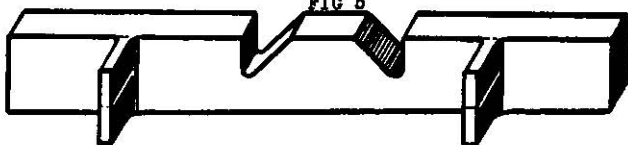

FIG 6

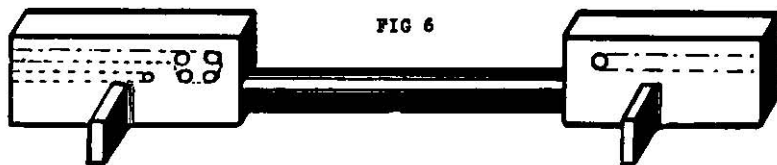

FIG 7

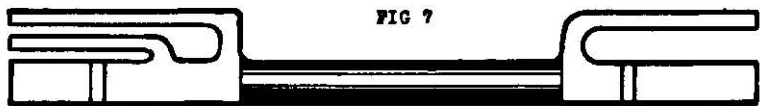
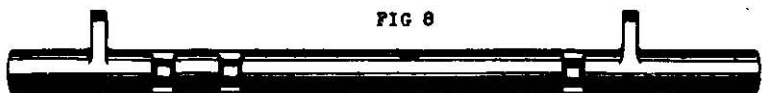

FIG 8



MISCELLANEOUS EXAMPLES OF FORGED
WORK IN DIFFERENT STAGES. PLATE 90

LOCOMOTIVE BRAKE SHAFT (B)

PLATE 90 illustrates the method of making a brake shaft having an arm with a double eye at one end, and a straight arm at the other end.

FIG. 1 shows the brake shaft. The dimensions are :—

A $3\frac{1}{4}$ ins. diameter, 2 ft. 4 ins. long.

B 4 ins. tapered to $3\frac{1}{4}$ ins., 12 ins. long and $1\frac{1}{2}$ in. thick.

C the largest diameter is 4 ins., 4 ins. thick. The arm is $1\frac{1}{2}$ in. thick, total length 12 ins. and the distance between the two arms is 1 ft. 4 ins. The size of bar required to make the brake shaft is 8 ins. by 4 ins.

First operation, FIG. 2 : Draw down 15 ins. of the 8-inch by 4-inch bar to 6 ins. by 4 ins., then side set, allowing $4\frac{1}{2}$ ins. to be drawn down as shown to $3\frac{1}{4}$ ins. diameter, 1 ft. 4 ins. long.

Second operation, FIG. 3 . Draw down to $3\frac{1}{4}$ ins. diameter, then cut from the bar, making each end 12 ins. long, one end being 8 ins. by 4 ins. for 6 ins. of its length.

Third operation, FIG. 4 : Mark off for drilling as shown, then cut along the dotted lines.

Fourth operation, FIG. 5 : Open out the arms, and shape them as required. Next, finish off the ends of the shaft and cut to length. To complete the forging, twist the bar in the centre (at the double line). This gives the required result, as shown in FIG. 1.

BRAKE SHAFT. PLATE 90

FIG 1

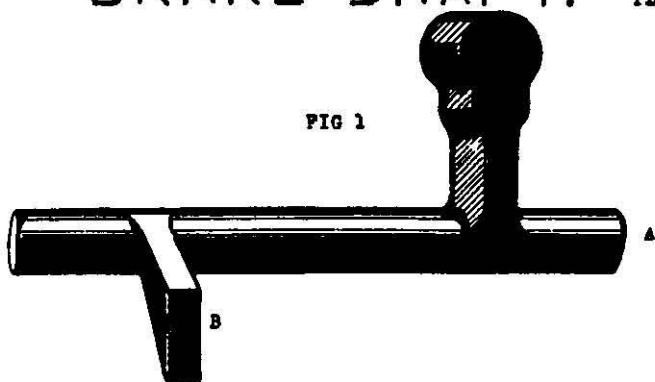

FIG 2

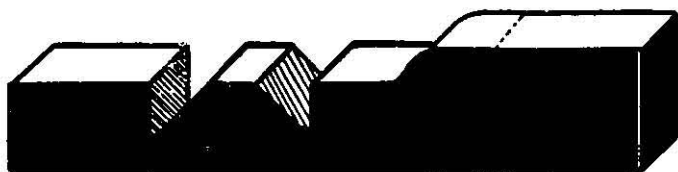

FIG 3

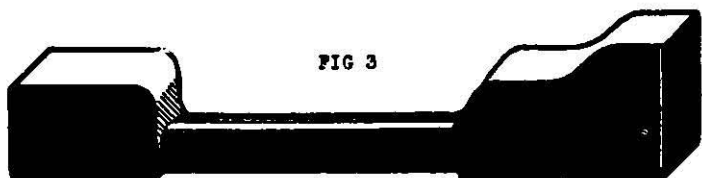

FIG 4

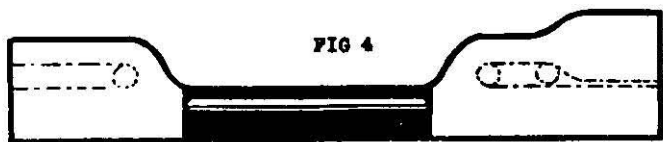
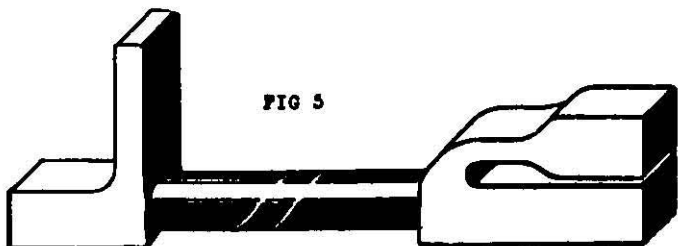

FIG 5



MISCELLANEOUS EXAMPLES OF FORGED
WORK IN DIFFERENT STAGES. PLATE 91

LOCOMOTIVE BRAKE SHAFT (C)

PLATE 91 illustrates the method of making a brake shaft, having a long arm in the centre, with a double eye at the end. Two short arms project from each end of the shaft, as shown.

FIG. 1 shows the brake shaft, made from an 8-inch square bar.

First operation, FIG. 2 : Side set the 8-inch square bar, as shown.

Second operation, FIG. 3 : Draw down to 8 ins. by 4 ins., as shown.

Third operation, FIG. 4 : Mark off the forging for drilling and cutting, as shown.

FIG. 5 shows the result after the forging has been cut with a band saw along the dotted lines.

Open out the centre arm, and then cut the piece off at the dotted line. Complete, by swaging the bar to the required diameter, and shape the double eye, as shown in FIG. 1.

BRAKE SHAFT. PLATE 91

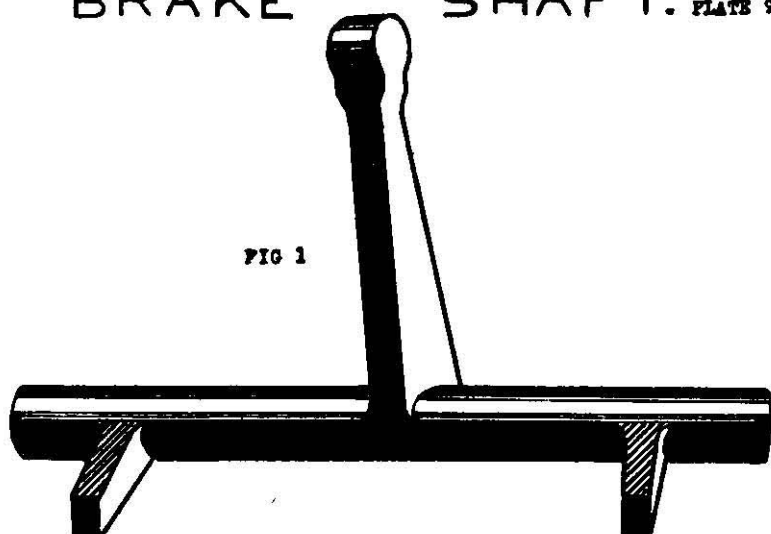

FIG 1

FIG 2

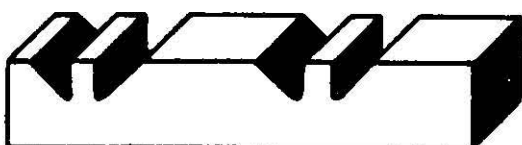

FIG 3



FIG 4

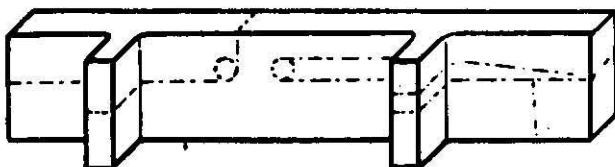

FIG 5



MISCELLANEOUS EXAMPLES OF FORGED
WORK IN DIFFERENT STAGES. PLATE 92

LOCOMOTIVE SHAFT

PLATE 92 illustrates the method of making a shaft having a short arm at each end.

FIG. 1 shows the shaft, made from a 12-inch by 6-inch bar.

First operation, FIG. 2: Side set the 12-inch by 6-inch bar, as shown.

Second operation, FIG. 3: Draw down one end and swage it to the required diameter, as shown.

Third operation, FIG. 4: Repeat the above operations at the other end.

Fourth operation, FIG. 5: Draw down and swage the centre, as shown. Next, shape the arms by cutting along the dotted lines, as shown.

FIG. 6 shows the method of side setting, by using a pair of side sets.

SHAFT.

PLATE 92

FIG 1



FIG 2

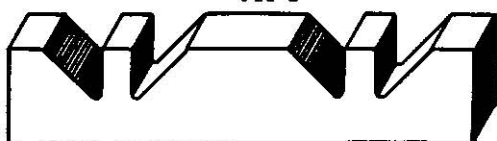

FIG 3

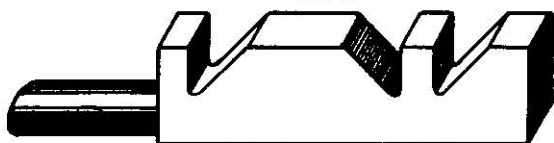

FIG 4

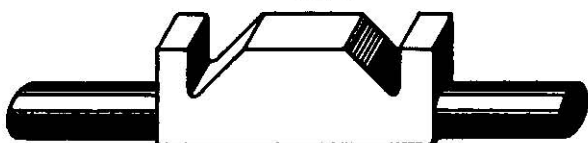

FIG 5

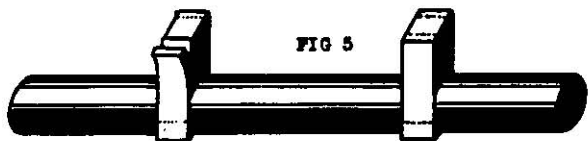
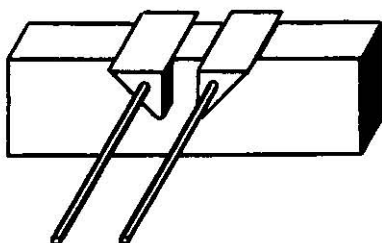

FIG 6



MISCELLANEOUS EXAMPLES OF FORGED
WORK IN DIFFERENT STAGES. PLATE 93

LOCOMOTIVE REVERSING SHAFT (A)

PLATE 93 illustrates the method of making part of a reversing shaft which is 17 ins. long and the diameter of which is $3\frac{1}{2}$ ins. The arm with the double eye forged on the end is 9 ins. long, and the T-piece at the opposite end is 8 ins. by 4 ins. tapered to 2 ins. at the ends.

FIG. 1 illustrates the reversing shaft made from a 7-inch square bar.

First operation, FIG. 2: Draw down 7 ins. of the 7-inch square bar to $4\frac{1}{2}$ in. square. Reduce enough of the $4\frac{1}{2}$ -inch square to form the arm, as shown in the following illustrations.

Second operation, FIG. 3: Joggle as shown.

Third operation, FIG. 4: Swage to the required diameter and cut off the bar at the dotted line. Prepare the double eye for stamping, as shown in FIG. 5.

FIG. 6 shows the result after stamping complete by setting the arm and tapering the opposite end, as shown in FIG. 1.

REVERSING SHAFT.

PLATE 93

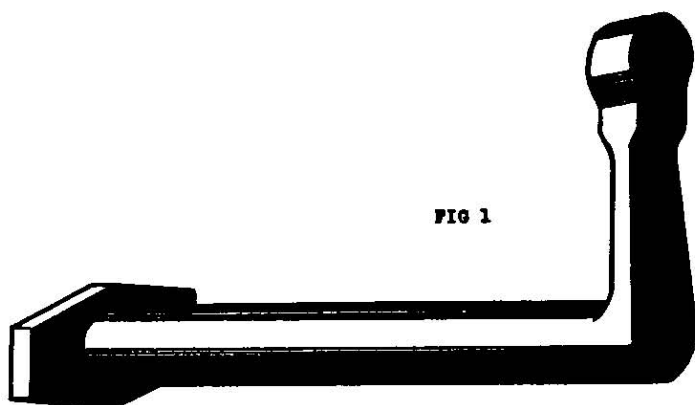

FIG 1

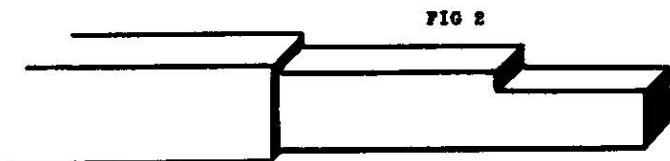

FIG 2

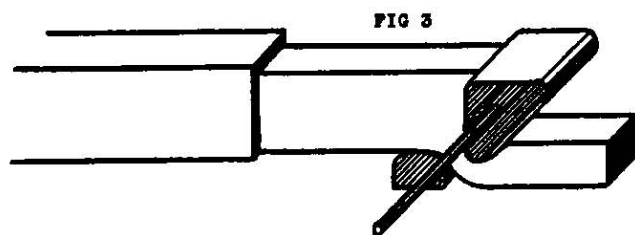

FIG 3



FIG 4

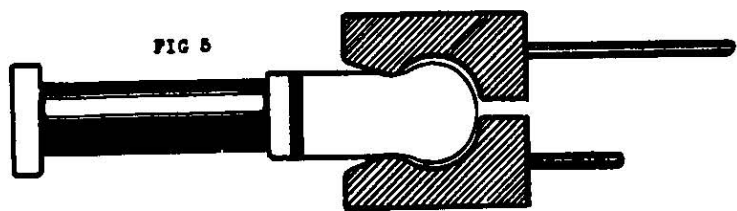

FIG 5

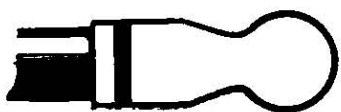

FIG 6

MISCELLANEOUS EXAMPLES OF FORGED
WORK IN DIFFERENT STAGES. PLATE 94

LOCOMOTIVE REVERSING SHAFT (B)

PLATE 94 illustrates the making of another part of a reversing shaft, having an extra arm in the centre.

FIG. 1 illustrates the reversing shaft, made from a 7-inch square bar.

First operation, FIG. 2: Draw down the 7-inch square bar to 7 ins. by 4 ins., as shown.

Second operation, FIG. 3: Side set the 7 ins. by 4 ins., as shown.

Third operation, FIG. 4: Draw down and swage, then fuller, as shown.

Fourth operation, FIG. 5: Reduce as shown, to shape partly the centre arm, then drill two holes and cut the bar as shown.

Fifth operation, FIG. 6: Open out and set the centre arm.

Sixth operation, FIG. 7: Turn over the bar and draw down, as shown. Next, joggle as shown in FIG. 8.

Seventh operation, FIG. 9: Draw down and swage the rest of the shaft, fuller as shown, then draw down as shown in FIG. 10. Complete the double eyes by stamping, as shown on PLATE 93, and set the end arm, as shown in FIG. 1.

REVERSING SHAFT.

PLATE 94

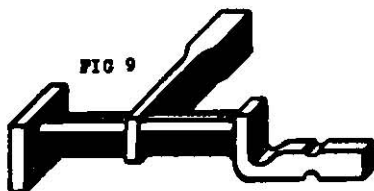
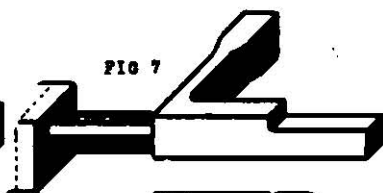
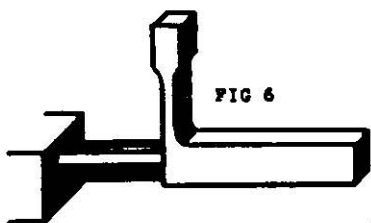
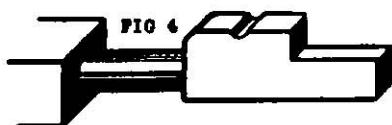
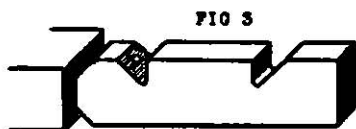
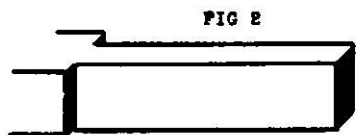
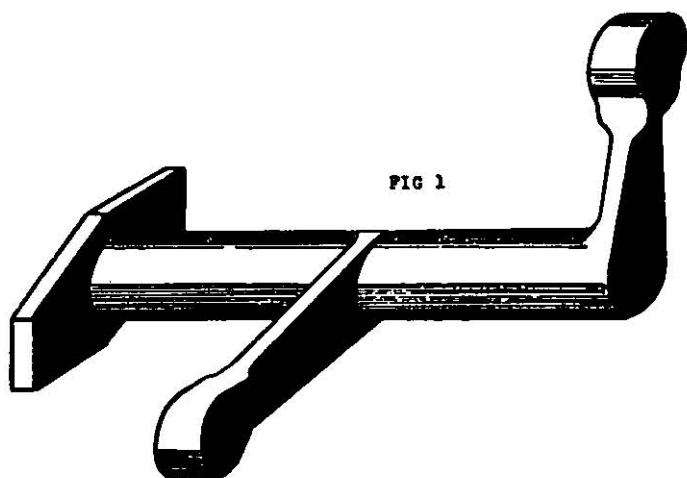

MISCELLANEOUS EXAMPLES OF FORGED
WORK IN DIFFERENT STAGES. PLATE 95

LOCOMOTIVE REVERSING SHAFT (C)

PLATE 95: FIG. 1 illustrates a reversing shaft, made from 9-inch by 4-inch bar.

First operation, FIG. 2: Side set the 9-inch by 4-inch bar, as shown.

Second operation, FIG. 3: Draw down to $6\frac{1}{2}$ ins. by 4 ins. and side set, as shown.

Third operation, FIG. 4: Swage to the required diameter, then side set the opposite end, and draw down, as shown in FIG. 5.

Fourth operation, FIG. 6: Mark off the forging for drilling and cutting, as shown.

Fifth operation, FIG. 7: Shows the result after the forging has been cut with a band saw along the dotted lines.

Sixth operation, FIG. 8: Open out the arms, and draw down, as shown.

Seventh operation, FIG. 9: Joggle as shown.

Eighth operation: Swage the remainder of the shaft to the required diameter, before setting the end arm, as shown in FIG. 1.

REVERSING SHAFT.

PLATE 95

FIG 1

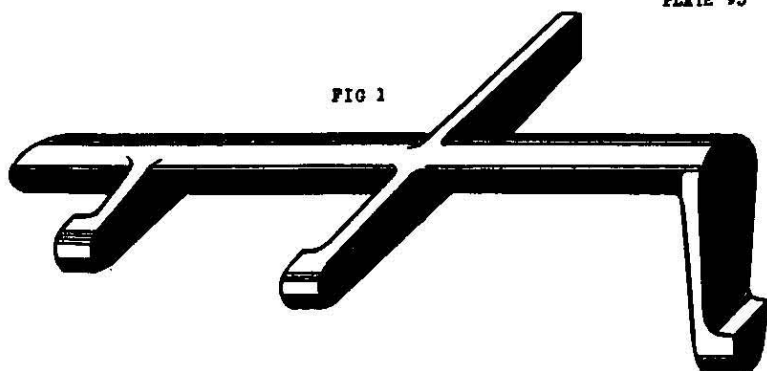

FIG 2



FIG 3

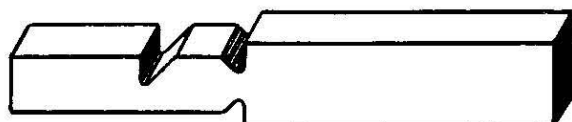

FIG 4



FIG 5

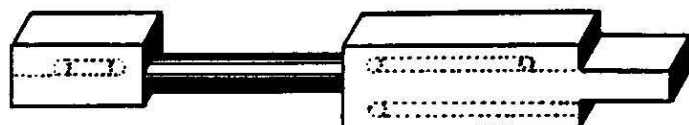

FIG 6



FIG 7



FIG 8



FIG 9

