

700 SCIENCE EXPERIMENTS FOR EVERYONE

COMPILED BY UNESCO

Would you like to create a cloud in a bottle? Prove that the earth spins? Run a telephone next door? Keep a thriving ant colony? Weigh the atmosphere? Make your own soap? Identify fossils?

These are only a few of the more than 700 simple, safe, and exciting experiments that will help you to discover and understand many fascinating, scientific facts about the wonderful world in which we live. Some of these projects will take you no more than a single morning; others will keep you and your friends busy for months, at home or at school.

Compiled by a team of American, British, and French science instructors under the auspices of UNESCO in Paris, this latest edition features new sections on Optical Projection, Electricity, and Chemistry, in addition to enlarged chapters on Astronomy, Magnetism, Geology, Physiology, and many more! (continued on back flap) The United Nations Educational, Scientific, and Cultural Organization

Each chapter offers approximately 50 related experiments, with brief, easy-to-follow instructions and clear “how-to” diagrams. This edition also tells you exactly what materials you will need for each experiment and where to get them. The materials are inexpensive and easy to find. Many are probably in your home or garage, and the others you can get at your neighborhood market, drugstore, or hardware store.

If you are curious about how things work, why they grow, how they live, and what they are made of—in other words, if you have the same everyday curiosity that motivated such scientific pioneers as Archimedes, Galileo, Newton, and Darwin—**700 SCIENCE EXPERIMENTS FOR EVERYONE** is the book for you. For these experiments will not only answer practically every question you might have on the natural and life sciences, they will teach you the scientific approach to problems you may want to solve on your own and show you the methods for solving them. Above all, you will learn that the study of science can be exciting, useful—and lots of fun!

IMPORTANT NOTE TO PARENTS, TEACHERS, BOYS AND GIRLS

This book was originally prepared for use as an instruction manual by teachers, where a certain level of experience, precaution, and discretion are presumed.

A number of experiments in this book, although totally safe if properly prepared and wisely handled, could prove dangerous to the inexperienced or careless experimenter. Any experiment involving fire or explosive reactions should be approached with the greatest of caution and protection.

Be careful where you find or purchase materials so that you don't end up using defective, and therefore dangerous, materials.

Good scientists are methodical and excruciatingly careful. Please be one. In the interest of safety several experiments published in the original edition of this book have been deleted.

Introduction

Science is perhaps unique as a subject in the curriculum of schools all over the world. This uniqueness results from the variety of materials and experiments necessary for its effective teaching. Most other subjects can be learned if ordinary tools are available, such as pencil, paper, blackboard, textbooks and a few supplementary aids. These are also essential for the teaching of science but, if they are the only tools, science becomes a dull and uninteresting subject.

If it is to be learned effectively science must be experienced. It must be learned and not learned about. Science is so close to the life of every boy and girl that there is no need to confine its study to the reading of textbooks or listening to lectures. Wherever you may go in the world, science is an intimate part of the environment—living things, the earth, the sky, air and water, heat and light and forces such as gravity. No teacher need ever be without first-hand materials for the study of science.

Good science teaching must be based on observation and experiment. There can be no substitute for these. But performing experiments and learning to make close observations require special facilities, and these are lacking in many parts of the world, especially at the elementary and early secondary levels. As a result, science teaching suffers a severe handicap in these regions. It is often believed—though erroneously—that to introduce laboratory teaching, even at the elementary level, requires elaborate equipment made by commercial manufacturers. Such materials are prohibitively expensive for most elementary and early secondary teaching, and in many parts of the world are quite unobtainable because they are not manufactured locally and cannot be imported because of the cost.

At the close of the second world war, many schools in many countries had been destroyed. As these schools began to revive, there was a great need for science equipment; for these countries had a tradition of basing science teaching on observation and experiment. To meet this need, Unesco sponsored the production of a small volume entitled *Suggestions for Science Teachers in Devastated Countries*. This book was written by Mr. J. P. Stephenson (science master at the City of London School; member of the Royal Society Committee for Co-operation with Unesco, United Kingdom). While it proved very useful for the devastated areas, it has had a phenomenal success in regions where previously there had been little or no equipment. Emphasizing the making and use of equipment from simple materials, the book has filled a great need in those countries where teachers are just becoming aware of the necessity for first-hand science experiments even at the lowest levels of instruction. It has gone through several editions and has been translated into French, Spanish, Chinese, Thai and Arabic.

Over the past few years, Unesco has sent many science teaching experts on field missions into areas where the need for the production and use of simple equipment is acute. These experts have had opportunities to make and try out the materials and experiments suggested in the Stephenson book. They have also had opportunities to go further in discovering other materials and devising new experiments, more suitable for tropical regions for which the Stephenson book was not originally intended. The work of these field experts, together with the Stephenson book, has produced an array of simple equipment and science experiments which needed to be assembled and described in one volume. This need has provided the impetus for the production of the present **700 Science Experiments for Everyone**.

Believing that science and the scientific method of problem solving should play a significant role in any modern educational scheme, Unesco offers this book in the hope that it will assist science teachers everywhere in their important work. The point of view taken is that science is most effectively taught and learned when both teacher and pupils practise the skills of problem-solving by engaging in group and individual study. The devising of experiments and the improvising of simple equipment for carrying them out should form no small part of such study. Thus, the present includes instructions for the making of many pieces of simple apparatus from materials usually found in almost any region. It also proposes a wide array of science experiments from which a teacher may select those most suitable for providing the observations upon which effective learning may be based.

These improvisations should not in any manner be regarded as makeshifts. The experiments and the exercise of constructing the apparatus are in the best traditions of science teaching. Many of the great masters of science have used such improvised apparatus and many of the great discoveries have been made with improvised equipment.

No claim for completeness is made for this book. The array of available materials has made it difficult to decide exactly what should be included. But it is hoped that these pages will serve as a guide, and as a stimulus to teachers and pupils to define their own science problems and then to improvise (from things that may be locally available) the necessary equipment for experimenting. Acknowledgments

Science is universal and knows no boundaries. This great store of human knowledge has been gleaned from a reluctant nature by workers of many lands. It is altogether fitting and proper that this 700 Science Experiments for Everyone should be a compilation of the work of experienced science teachers from many countries. It is through the sharing of experience that science teaching can be improved and enabled to move forward.

To give credit to all who have contributed to the making of this volume would be quite impossible. Much of the material included has its origin buried deeply in the past and has come to be a part of a common heritage of science teachers everywhere. Among those whose direct contributions have made this volume possible mention should first be made of Mr. J. P. Stephenson of the City of London School. To him and his collaborators we are indebted for the use of a large part of the material from the earlier Unesco publication Suggestions for Science Teachers in Devastated Countries. The impact of this little volume on science teaching has been world-wide and it is already considered a classic in the literature of science education.

Credit and appreciation are also due to: Dr. Glenn Plough of the University of Maryland and Dr. Paul Blackwood of the United States Office of Education, Washington, D.C., for permission to use parts of two bulletins on teaching elementary science, of which they were co-authors; the National Science Teachers' Association of the United States, Mr. Robert Carleton, secretary, and through them, to Mr. Guy Pruce of the Newark Teachers' College, for generous permission to use material from the series entitled Science Teaching Today; and the New York State Department of Education which granted permission to use material from the two volumes of their publication, The General Science Handbook, Volumes I and II.

Since the first appearance of the **700 Science Experiments for Everyone** in December 1956, many valuable comments and suggestions have been received, and reviews have appeared in journals in all parts of the world. This has led to minor revisions being made in each of the reprints. The first edition in English was reprinted eleven times, and the French edition is in its fourth impression. Translations have been published in seven other languages, while fourteen additional translations are in preparation.

The following were among the contributors of useful suggestions: Dr. F. J. Olsen of the Department of Education, University of Queensland, Australia, and a former President of the Australian Science Teachers' Association; Dr. W. Llowarch of the University of London Institute of Education and Dr. Vida Risberg, a former Unesco specialist in science teaching to the Philippines.

To begin with

A Few Words to Boys and Girls about This Book

It is probably only a legend that the idea of gravitation hit Sir Isaac Newton's mind when a falling apple hit his head. But the truth is that the simplest experiment, or even such an accident, can be an eye-opener when you are interested in the world around you. When the great Greek scientist, Archimedes, was puzzling about why some objects float on water and others sink, it is quite possible that the underwater lightness of his own body in the bathtub gave him the first hint of the answer. Certainly Charles Darwin's thinking out of the theory of evolution was the result of very careful observation of the plants and animals that he collected, including shells and fossils. These pioneers were all amateurs who had no elaborate apparatus to work with, and no textbooks either. That is the way science began.

You can begin your understanding of science that way too, and have a wonderful time exploring. The world we live in is as interesting as ever. In fact, with modern inventions now added, it is much more so. You do not need to wait for someone to explain the science behind the automobile engine, television, rocket flights in space, the development of new fruits and vegetables, or the causes of disease. You can investigate these ideas yourself.

Of course, you must begin at the beginning if you want to understand. But all the complex products of modern science are only combinations and developments of a few basic principles that govern the world. You can convince yourself and your family and friends that they are true by many easy experiments that you can do at home with common materials from the kitchen, the garage, or a nearby store. This book is intended to help you to do it.

You will be teaching yourself science, getting ready to join a science club or to take part in a school or county science fair. Then you will find the science textbooks easy to understand when you get to them. Best of all, you will be in the habit of having ideas and of trying them out, which is the common trait of all inventors and research men from Edison to Einstein. That trait is the source of almost all human progress, from the invention of the wheel and the sailboat to placing a man-made moon in an orbit around the earth.

This book is not a chemistry kit or a physics kit and does not need one. It is an idea kit. It describes hundreds of experiments that you can do for yourself, lists the simple things and materials that you need for them, and suggests what to do. The directions are brief and simple.

During each experiment you will draw your own conclusions about what it means or proves—and it's a good idea to write down your measurements and your conclusions in a special notebook. If your mind is as healthy and active as your muscles are, you will probably have many questions after each experiment—and you should write them down too. Some of them will be answered by the experiments that follow. For others you will want to look up the answers in an elementary science textbook in your school or library.

Often when you think about an experiment you may discover that you have different things around the house that will serve the same purpose.

Or you may think of other ways to prove the same thing. All the better. Certainly you will think of other experiments to do that are not in the book. Very good, because the experiments in this book are designed to start you thinking. One thing they will do: they will convince you that experimenting in science is fun and that thinking about science is exciting.

In the front pages of the book you will find a few suggestions for teachers, because this book was originally written for teachers in some countries where the schools do not have modern laboratories or perhaps have no laboratory at all. But these sections are not for you—not at the start at least; you can come back to them later. You will also find a list of tools, materials, and supplies that will be needed if you do all the experiments. But neither is this the place to start; you can find or get the materials as you need them.

The experiments begin with Chapter III, and the first chapters deal with botany, zoology, mineralogy, and astronomy. Start with them, if you like, or start with the experiments on air in Chapter VII. This is the first of ten chapters on common materials—like air, water, and solids—and on energy—including heat, light, and electricity—which introduce the science of physics. When you have done these experiments you will understand many things in nature and about modern machines that have seemed mysterious and you will be able to explain them to your friends.

One more thing about this book: Science is international, the same all over the world. It is studied in every country and in every language. This book was prepared by an agency of the United Nations (the United Nations Educational, Scientific, and Cultural Organization, usually called UNESCO from its initials) for use in all of them. As the UNESCO Source Book for Science Teaching it has been translated not only into the languages of Europe, such as French and Spanish, but also into many Asian languages, such as Arabic, Tamil, Hebrew, and even Chinese. So the experiments you do are being done at the same time by the students in South America, Europe, Asia, and Africa. Their languages and customs are different, but their experiments and their science are the very same as yours.

This English-language edition was prepared not only for the United States, but for all the countries that speak English, including England and Canada as well as Australia, New Zealand, India, South Africa, and many smaller ones. So it must be mentioned here that there are a few slight differences in spelling and in the use of some words between the United States and the other English-speaking countries. The United Nations

have formally adopted the British, rather than the American forms. So you will find, for instance, that “color” is spelled “colour” in this book, and “aluminum” is “aluminium.” These are not errors; they are just British English. What we call a “can” is called a “tin” in England, and a “flashlight” is a “torch.” But these differences are very rare and they will not confuse you.

Now the book is yours, get going and have fun learning science.

GERALD WENDT

Former Head, Division of Science Education, UNESCO

The purposes of this book

There are many places in the world where both facilities and equipment for science teaching are at present inadequate. Such places are to be found in areas that are more advanced in the applications of science, as well as in other regions. This volume has been produced to help the trend of upgrading science instruction in schools and training colleges everywhere by basing it more and more on observation and experiment. The basic purposes may be summarized as follows:

- 1 To provide a basis for better instruction in methods of teaching science in teacher-training institutions.
 - 2 To provide a useful source of learning experiences and materials for science teachers in the elementary and secondary schools.
 - 3 To provide a manual which may be used as a partial basis of instruction in science teaching methods for workshops and courses for the in-service training of teachers.
 - 4 To provide a basis for the assembling of a loan collection of teaching kits containing simple equipment for science.
- To provide some suggestive materials for science clubs and for other amateur science activities.
- To provide a model or pattern so planned and developed that it can easily be adapted to science teaching conditions in many countries and translated into the national language.

SUGGESTED USES FOR THIS BOOK

In teacher-training institutions

Young teachers in training do not learn the methods of effective science teaching merely by listening to lecturers in colleges; they must have some contact in their training period with the many problems to be met later in the classroom. The teaching of science must have special consideration above and beyond what is usually given in a general methods course—this because science is unique as a subject in the school curriculum as using specialized materials, equipment and methods of approach. If the standards of science instruction are to be raised, such a special course in the techniques of teaching it must be in the curriculum of every teacher- training college.

A large part of a course in the methods of teaching science should be devoted to the practical or laboratory phase in which young teachers are given instruction in the devising, designing and construction of simple laboratory equipment from materials available in the community where they will teach. Only through such training will they be stimulated to base their teaching on observation and experiment.

In this practical course, the young teacher should find the opportunity to construct many pieces of equipment to carry out to his first teaching assignment. He might even be encouraged to begin the assembly of a nucleus of teaching kits.

A source book for science teachers

Many teachers who have not had an opportunity to study science appear to be afraid to teach it. In many cases this fear of the subject arises because they do not know how to assemble apparatus or to marshal the specialized learning experiences required. This book can be used by such teachers as a source of instruction for making the simple equipment needed and as a source of a variety of learning experiences for teaching almost any topic in the curriculum. In this way the teaching can be improved and enriched.

This book should also help to create and maintain a higher level of interest in science on the part of the pupil. Every child is by nature an experimenter. He is curious about why things happen and likes to try out his ideas. Even outside the school, children are constantly experimenting. Many young people will like helping to construct apparatus and to test the ideas proposed in their classroom experiences.

Pupil committees may be used in the building of many of the pieces of apparatus suggested as well as in assembling them into useful kits to be used in later experiments. If there is a work-shop in the school, the teacher may co-operate by letting pupils make science equipment as special projects.

As a basis for workshop study conferences in science teaching

The workshop study conference is now a well-established and widely used device for the training of teachers in service. Such conferences have been held for science teachers in many parts of the world. It is only through them that teachers now teaching can be influenced to improve their practices and change their present conditions.

This book can serve as a useful basis both for instruction in methods of teaching science and for a laboratory practice where teachers are given instruction in the simple techniques of making improvised apparatus. They might then be encouraged to begin the training of other teachers in the area.

To provide the basis for assembling a loan library of simple science teaching kits

While the ideal situation would be for every school to assemble the simple equipment needed for teaching the various science units, this may not always be feasible because of lack of funds or time. Another scheme is to assemble kits of simple equipment for doing experiments. Each kit is assembled in a durable box with a hinged cover that latches securely. The kits are then stored in a central school and loaned out to teachers in the schools of the neighbourhood in much the same way as library books are loaned. Each kit also contains a list of the materials in the box as well as directions for doing the experiments.

The plan operates in this way. Assume that kits have been assembled and stored in a centrally located school. Perhaps the teachers in that school would take responsibility for keeping the kits in good order and making the necessary records. A card should be made out for each kit. Now let us suppose that a teacher in school X is planning to teach a unit on magnetism during the next week. She goes to the school where the kits are kept and fills out a card stating when she will need the kit on magnetism and when she will return it. The teacher in charge takes her card and then notes on the kit card, her name, the school and the dates. The kit is then issued to the teacher, and she takes it to her classroom for use. At the end of the unit the materials are carefully checked against the list and any breakage noted. The kit is then returned to the depository.

A project for assembling a library of simple equipment kits might be undertaken in several ways. One way would be to have the boxes made according to the pattern suggested above, by boys in a vocational school. The kits might be assembled at a central place or the project could be made co-operative by having each teacher, with her class, assume responsibility for assembling and making the necessary materials for one teaching kit. Another plan might be worked out in which students in training at a teacher-training college could be assigned projects of assembling the kits for schools in a given locality.

As a source book for science club activities

Science club sponsors often find it a problem to provide worth-while projects and activities for club members. The many projects and experiments suggested in this book are appropriate for use by young people of all ages as science club projects.

To provide a model pattern of science materials and activities for many countries

The format of this book has been so planned, and the materials so selected as to make it adaptable to almost any local situation. The text materials and the simple line drawings can easily be reproduced.

TOOLS NEEDED FOR MAKING SIMPLE EQUIPMENT

Every school where elementary or general science is taught should be provided with some sort of work bench where simple equipment can be made. An old table can be used for this purpose. If no space is available for a work bench, a few rough boards cut to the right length may be placed on a school desk to prevent injury to the desk top. Such boards may be padded on the under side with cloth. A work bench will provide a place to hammer and saw. A good supply of old newspapers is always useful to put on the floor, especially if any painting is to be done.

MATERIALS AND SUPPLIES

The materials needed for making simple equipment will vary from place to place and class to class. It is possible however to suggest a few basic materials and where they can be obtained.

Hammers Screwdrivers Pliers Small wood saw Hack or metal saw Small block plane Wood chisel Brace and bits Gimlet Old pans of various sizes Tablespoons and teaspoons Cups and saucers

From the home

Dinner plates Soup plates Bottles, various shapes and sizes Tin cans, various sizes with and without covers Glass jars, various shapes and sizes

CHAPTER I

SOME SUGGESTIONS ABOUT THE TEACHING OF GENERAL SCIENCE

A. GENERAL SCIENCE

What is it?

Where is it? In the primary school, children are seeking simple answers to their questions, which usually begin with: ‘What is it?’ First of all, science is not a lot of things it was once thought to be; not a series of object lessons about a piece of granite, an old wasp’s nest, an acorn, or a tulip. It is not hit and miss like that, not learning the names of the parts of a grass-hopper or a flower; not learning to identify 20 trees, 20 insects, 20 flowers or 20 anything else.

What is science, then? It is a study of the problems that are found wherever children live. More formally stated, it is a study of the natural environment—not merely pieces of chemistry and physics and biology and astronomy and geology. Its content is connected with those subjects but it is a study of problems that pop into curious children’s minds as they live and grow from one day to the next, such as: What makes the wind blow? What’s in a cloud? What’s a stone made of? What does a bell do when it rings? How can a seed grow into a tree? What makes a rainbow? Anyone who has ever worked with primary school girls and boys knows that most of them are full of questions like this and like to know the answers to them. Well, finding the answers to such questions—that is science.

And it need not be too technical. The full explanation is not what the 10-year-old needs. He could not understand that. It is a foundation in simple terms of the how, the when, the where, and the what of the things that happen around him every day. That is his science. He doesn’t need the technical terms, the formulas and the detailed explanations. Those will come later, but when he is 10 he chiefly needs to get satisfaction out of his tendency to be curious. He needs to have his curiosity broadened, his interests nurtured and his enthusiasms encouraged. That is the kind of science which fits him and with which he is able to deal.

Where is it?

Science in the primary school—where is it? It is everywhere that schoolchildren are: in the air they breathe, in the water they drink, in the food they eat. ‘What’s oxygen?’, ‘How do minerals get into water?’, ‘What’s a vitamin?’

Science is in the things they see on their way to school: ‘How does electricity make a street car move?’, ‘Why does my dog stick out his tongue when he pants in hot weather?’, ‘What makes the sky blue?’

Science is in their homes: ‘What makes our doorbell work?’, ‘What makes lemons taste sour?’ ‘How does our furnace heat our house?’

Science is in the schoolhouse: ‘How can the fire extinguisher put out a fire?’, ‘What made the rust in the drinking fountain?’, ‘Why did we all have to be vaccinated?’

Science, then, is all around the girls and boys we teach. They cannot help but see it. They will see more of it with a little help. They will get more interested in it with a little encouragement. They’ll learn more about it with a teacher who sees the possibility of its use, and uses his teaching skill to help children learn about their environment.

What can it do?

It is generally true that a well-informed person is an interesting one, and some information regarding the environment is one of the pieces of equipment that go to make up an informed individual. That does not mean that you expect to pump your pupils full of facts that they can merely use to fill up blank spaces in conversation. It means that you want to help them to come to learn generalizations or meanings which they can use in interpreting problems in their environment.

To illustrate: The members of the lily family have three sepals, three petals usually coloured alike, six stamens, one pistil, etc. A boy aged 10 can certainly live a full and well-rounded life without committing this to memory. But suppose he learns through an examination of many plants and many animals that 'Plants and animals are put into groups according to certain characteristics, and that knowing these characteristics helps you know the large group to which the living thing belongs'. This generalization can then be helpful in identifying animals and plants he sees, and make it possible for him to study their habits, to determine their helpfulness or harmfulness, and so on. He has become aware of this generalization through careful study and through observation, and by pressing together many small ideas into one large one. One aim in science, then, is to teach generalizations that can be used by pupils in interpreting the problems they come across in their daily living. The more nearly we can come to studying the problems that really make a difference in the lives of girls and boys the closer we are to having a science programme.

You don't want your girls and boys to grow up to be sloppy thinkers. The method by which science generalizations were originally discovered is the kind of thinking we hope they can be trained to achieve. We may call it a scientific way of getting the right answer. There is nothing brand-new about this idea. Probably you have been doing it for years in arithmetic and other subjects: defining the problem, suggesting several hypotheses, gathering evidence, drawing conclusions, checking conclusions. That does not mean that every time a problem comes up you get out these steps and make pupils climb them.

Actually, this scientific way of solving problems need not include these formal steps. For example: children want to know what makes a compass needle point north and south. You make sure that they state the problem as carefully as it needs to be stated, so that it asks exactly what children want to know. Then pupils say what they think makes the needle behave that way. Some explanations seem to make sense; some don't.

'How can we find out whose idea is right?' you ask. The pupils answer: 'Read our science books. 'Ask Mr. Jackson, the physics teacher. 'Do an experiment.' Then the pupils carry out their suggestions, discover an explanation, check it as carefully as they can by known authority, and they have solved the problem and can now make use of their knowledge. Simple, of course, and it is only the beginning of their introduction to a way of solving problems that, if properly used, is likely to produce good results. If they have intelligent guidance, pupils can make great strides in ability to solve problems in this manner. Contact with this way of problem solving cannot come too early in a child's school experience. It takes a long time to become an accurate solver of problems.

You want girls and boys to develop certain scientific ways of thinking as they work. For example: Things don't just happen; they happen because of natural causes, so don't be superstitious. Be open-minded toward the opinions of others. Regard your conclusions as tentative until you are sure. Look for reliable sources for evidence. Be willing to change your mind if you discover that you were wrong. Don't jump to conclusions. Be curious about things and don't be satisfied with a vague explanation. These are a few of the safeguards of scientific thinking that a carefully directed study of science can help pupils to attain. Again, the earlier the contact with this kind of thinking, the better.

Then, too, you want to broaden the interests of the girls and boys. They seem to be naturally curious about many of the things around them, but there's half a world of things they know nothing about, so they can't be curious about the things in it. A study of the stars may open up a new field of interest in the sixth form and for a few it may turn out to be a lasting interest. A study of how plants grow may stir up an interest in plant culture that would otherwise have remained buried. Studies of children's interests seem to show that children are interested in all aspects of their environment, not just in animal and plant life as was once supposed. Some pupils, however, appear to have more or less narrow interests and need help in seeing other possibilities. Many life-long interests were born early in a child's school experience; scientists often say that their interest in science began when they were still very young. With better science teaching in the primary school more such results might be obtained.

You also want to have your pupils grow in appreciation of the things around them. How do young children come to appreciate things? Little sermons about the beauties of nature won't help much. Vague talk about the beautiful butterflies, bees, and flowers won't be of much help either. While we are learning new ways of helping pupils to grow in their appreciation, let's try to teach them to see, to look closely, to examine carefully, and to discover by themselves what wonders there are in the world about them. In the common green leaf a manufacturing process goes on that man himself has not duplicated. He has learned that the raw materials used in the process are water and carbon dioxide, that the green colouring matter in the leaf is indispensable to the process, and that it cannot happen without the help of light. He can analyse the resulting process to the last molecule, but he himself cannot duplicate the process nor is he able to understand it completely. Furthermore, without this process life itself could not exist. As a child learns these truths, as he is helped to realize their significance, his appreciation grows, especially if working with an enthusiastic, intelligent, appreciative teacher.

These, then, are a few of the things that the study of science can do for the children in our schools if teachers of science are fully aware that these are the purposes, and are intent on seeing that science is taught in such a way that they are accomplished. Aims that remain planted in teachers' manuals without being used do not help children. But aims that are in the teacher's mind and in the minds of children as well, will help them. Such aims colour the selection of the subject, the method of teaching it, the activities selected, the method of evaluation, and everything else that is done in the classroom. Here, then, is a point for all science teachers to remember decide what it is you hope to accomplish by teaching science, keep it in mind, keep checking to see that you are staying on the track, and keep evaluating to find out how closely you are coming to your goal. And, above all, let these purposes be as nearly as possible those of the pupils, and let pupils help with the plans for accomplishing these objectives.

Elementary science and nature study

There has been and still is controversy over whether a programme in science in the primary school should be called elementary science or whether the term nature study should still be used. Some schools have so-called nature study programmes that are excellent. They are teaching science in the broadest sense and have the most modern objectives in mind although continuing to use nature study as the name for their programme. In some other schools, the programme is called elementary science, but the philosophy under which it operates is antiquated and holds to the original, narrower, view of nature study. From this it appears that the name is not so important as is the content and the procedure actually used in the programme. The science programmes that take the best from the nature study idea and build upon it the best that we have learned in recent years are those that are most useful today. While the difference does not lie entirely in the name, programmes in elementary science are likely to be broader in scope and conform more nearly to modern needs than those called nature study.

To illustrate this point: the nature study idea stresses the study of an object such as a rock or tree rather than a broad problem concerning rock formation or forestry. It is likely to lay stress on identification of rocks and trees rather than use this as a means to an end. It is not likely to be concerned with the study of the problems of real concern in the lives of children or the whole field of science, but to deal' rather with the study of plants and animals. Experience with children shows that they are interested in all phases of their environment. From this brief sketch of nature study ideas it appears that the original idea of nature study is being supplanted by a programme more suited to the needs of modern children. The world in which these boys and girls live today has changed greatly during recent years; so, too, must their programme of studies change.

From the nature study idea, however, we realize the importance of first-hand experience in observing life around us, not just reading and hearing about it. A nature trail that points out kinds of plants and animals, homes of animals, spots that show interrelationships among living things, relationships between living things and their environments, and special adaptations of these living things, is useful learning equipment. A nature trail, then, although it has its origin in the nature study idea has, if properly used, much to contribute to a more up-to-date science programme. Schools that are near a wood, near a park, or in the country are fortunate if they avail themselves of the opportunity to establish such a nature trail, or in some other organized way make use of this resource.

Camping experience is another source of first-hand information and appreciation which a modern elementary science programme might well include. The experience of building a camp fire, preparing sleeping quarters, getting pure drinking water, procuring and preparing food, and many other necessary activities are packed full of science. Again, how much science and what kind of science is learned depends on the point of view of the individual in charge.

In deciding whether or not your point of view is in line with pupils' needs, measure it in relation to the objectives discussed earlier in this section. These, along with the purposes of the total elementary programme, are the guides that point the way. Don't think that you have a modern science programme if you spend half the time covering walnuts with tinfoil and hanging them on a Christmas tree, pressing leaves, colouring robin 'pictures, or cutting paper snowflakes. Such activities do not achieve the objectives of even the most elementary science programme.

Science and the primary school programme

An elementary science programme that tries to exist without consideration of its relationship to the general primary school programme is bound to be ineffective. A science programme's right to exist as a separate subject must be challenged on the basis of its contributions in accomplishing the general objectives of primary education.

The general purposes of the primary school have been variously stated. Perhaps the most important is to help children to achieve the ideals, understanding, and skills essential for becoming good citizens. This involves giving them the basic skills of reading, writing and arithmetic, as fundamental tools for gaining information. In addition, it means giving them an opportunity to identify and understand social procedures and problems, to participate both in suggesting solutions and carrying out their suggestions, to develop their social sensitivity to the needs of individuals and groups. The elementary school should help children to recognize and practise a number of human relationship skills—co-operation, selection of leaders, group planning—provide conditions conducive to physical and mental health, and give the children information and skills for developing these traits. It should help them to develop wholesome interests for their leisure time. These are the general aims of a good primary school programme and no science programme can be effective without keeping them in mind.

The objectives for teaching elementary science must be adapted to these broader concepts of the primary school's purpose. How we teach science, what activities are most useful to children, how we help them plan and evaluate, all must be shaped in accordance with these objectives.

For example, how shall we teach science so that it will help children to be better citizens? If the teacher himself selects all the content, organizes it, decides how it is to be learned, and makes all other decisions, how are children to grow in ability to organize, to plan and work together? If we agree that being able to plan and work together is one of the attributes of a good citizen, we must make plenty of provision for children to plan and work together. There is a distinct difference between exercising leadership as a teacher and dictating from behind the desk. The teacher, as a leader, may take initial steps to create interest, open possible avenues of procedure, and then be a helper. Because of his experience he is able to exercise some guidance—but praise be to the teacher who has learned to be silent at the proper time! Children learn to be responsible citizens through being just that—silent—in science as in other school activities. The subject matter exists in large part for the purpose of developing this potentiality. So, in teaching science let us give opportunities for children to plan together, make decisions, make mistakes, decide how to rectify them, recognize their successes, set up new procedures and evaluate the results.

Do not tell children the answers to every question they may ask, or tell them always to read the answer. How do we gain information on science? By experimenting, by observing, by asking people who know, by reading, by looking at films, and in other ways. Again, how do pupils learn when to use these ways and when to depend on their results? They learn through practice in deciding, then through trying out their proposed plans and evaluating the effectiveness of their efforts. With practice, pupils grow in their ability to use the tools available for gaining knowledge—but this is true only if we help them. Every subject has here a definite contribution to make—if we give it a chance.

B. THE SCIENCE TEACHER

If we wait until all elementary teachers feel fully equipped to handle science we shall never get started. The most successful teachers of science in the primary school have said to themselves: 'I believe in the importance of including some science in my work. I don't believe my programme is complete without it. I don't know much science, but I know how children learn. I don't mind being asked questions that I can't answer because I know how to help children find answers.'

These teachers have many problems. They need to build background in science, to learn how to teach it, to find the necessary apparatus and other materials. But they have two essential pieces of equipment: they realize the importance of including science, and they know how children learn.

The following suggestions have been found useful by many such teachers:

1. Approach the teaching of science with confidence, not with the awe usually reserved for the first sight of a man from the planet Mars. It is not as unusual as you think. It is not so much different from teaching social studies, language, arts or arithmetic, in which most teachers feel at ease. It is not harder to teach; in fact, in some ways it is easier because it deals with concrete things and reaches the real interests of many children.

2. Don't expect to know the answers to all the questions children ask you. If you wait until you do, you'll never begin teaching science. Teachers tell children too much any- way. If you know children, and know how to help them learn, half your teaching battle is won. Don't be afraid to learn with children. Let them set up plans for finding the answers to their problems and then you act as a guide and learn with them. Of course you need to know some subject matter, but you don't need to be a science specialist. The next few items of advice will help you build up some science background.

3. After a unit or area of science study has been decided on, read some basic science textbooks on the learning level of the pupils you teach. Then get some good general science or biology textbooks (the kind used in secondary schools) and read them. Here you will find most of the science subject matter background essential for teaching young children.

4. Do some of the experiments suggested in these books so that you get the feel of the material. These elementary science experiments are not half as complex as you may think.

5. Do some of the 'things to do' that the books suggest—trips, observations, experiments, collections. To see is both to believe and to feel and it is much easier to get your pupils interested in and excited about the town's filtration plant if you have yourself seen how wonderful it is.

6. Talk with a secondary school science teacher near your school and enlist his help. Secondary science teachers can often give you teaching ideas, suggest experiments, and help provide materials and books. Science is their special field, and they are usually full of helpful ideas.

Remember that it is the unfamiliar that is likely to make you timid, so give yourself as much first-hand experience as you can with the science material. Following the preceding suggestions is almost sure to make you confident enough to tackle a new science topic.

7. Don't feel too handicapped because you lack materials. Children can bring from home almost everything you actually need. What they cannot produce, you can get at the market or hardware store (ironmongery), borrow from the secondary school science department, find in the schoolyard, get from the school janitor, or let the children themselves make. Expensive, complicated apparatus is worse than useless in the elementary science class. It is likely to be confusing and to draw attention to itself rather than to the problem at hand.

8. Let pupils experiment. Children like to learn in this way. Use some of the abler pupils in your class to gather materials and prepare the instruments.

9. Start your science by teaching the topic with which you feel most at home. This may be contrary to the belief of some persons that pupils should initiate all problems for study. That theory is open to question anyway. If some of your college science training, a personal hobby, or an interest of your own has given you background in some special field, using that knowledge or interest to determine your choice of topic may be your springboard for science teaching. Later it will be easier for you to follow children's leads. They can always enter into the planning even if the original idea comes from you as the teacher.

10. Make good use of the teachers' manuals that accompany your textbook in science. They are full of teaching ideas that have been tested and found good. They are often helpful even if you are not following the text which they have been prepared to accompany.

11. Keep track of your science material, your notes on teaching, your plans, etc. so that you can use them at a future time and so that other teachers may borrow them. A topic is easier the second time, especially if you have access to the material you used before.

12. Talk to other teachers about what things they have found successful, and be ready to share your experience with them. Such an exchange is often a great help.

C. HOW CHILDREN LEARN SCIENCE

Children learn science in a variety of ways, just as they learn anything else. They learn it more readily when they are interested in it, when they can see that it makes some difference to them, when it is graphic, involves some manipulation on their part, is not too hard but hard enough to make them think, and when it gives them the satisfaction of having found out something they wanted to know. This is not peculiar to science. It is true for arithmetic, languages, the arts, or any other subject. The activities selected by and for children should take these things into account. Keeping them in mind, let us then examine some of the ways in which children learn science.

Experimenting

Experimenting is one of the chief ways of learning science principles and generalizations. Experiments should be kept simple; the commonest material is often sufficient and almost always desirable; pupils are capable of originating their own experiments—often bringing the necessary material from home—and are usually enthusiastic about performing them.

Certain points should be borne in mind:

1. Experiments should be conducted so that they will cause pupils to think. An experiment in which the teacher tells the pupils everything obviously gives no food to growing minds.
2. Children should be conscious of the purpose of an experiment. It is often desirable to write the purpose on the board in a simple, direct form. This is easy when the experiment is done to solve a problem which the pupils themselves have raised. For example: the children arrive at school on a slippery winter morning. The janitor has scattered salt on the school steps to clear the ice. The children want to know what happens to the ice and why that happens. They decide to set up an experiment to discover the reason. They get the point of why they are experimenting and are therefore more likely to press the performance to an ultimately satisfying conclusion. Other experiments may arise from the text- book, but the plan of action should as far as possible be worked out by the pupils.
3. Careful planning is essential to successful experimenting. Appropriate materials must be assembled—by the children, if possible. A plan of procedure must be drawn up. The plan must then be accurately followed, to ensure that the results can be depended upon.
4. As far as possible, children themselves should perform the experiments. They may work as individuals or as groups, depending on the type of experiments and the amount of material available. Experiments involving use of fire or other possible dangers, or experiments of a complicated nature, if used at all, should be performed by the teacher.
5. Children themselves can often originate experiments to answer their questions. These are the most satisfactory from every point of view. Contrary to the belief of some teachers, experiments need not always be complicated, nor need they have been previously described in a science book—sometimes they are; some- times they are not.
6. Experiments should be performed carefully, and according to the directions, either those from books or those originated by the class.

7. Pupils should critically watch what is really happening when they perform an experiment, so that their results will be more dependable. For example: suppose they are attempting to discover whether or not leaves of plants give off water. They set up the usual experiment of covering a plant with a glass jar and shutting off the soil from contact with the air in the jar. The next morning droplets of water are found on the inside surface of the jar. The children immediately decide that they have discovered the answer to the problem. But how can they be sure that the water did not come out of the air in the jar? They can't. But suppose they assemble another set of apparatus exactly like the first—a plant pot, a glass jar, soil, etc., but without a plant. The jars are placed side by side and observed. This time if water appears on the inside surface of the jar with the plant in it and does not appear on the other jar's surface, the water must have come from the plant leaves. Such a procedure of controlled experimentation is essential if experiments are to assume their full meaning as activities for children. In this connexion it is essential that the experiment be tried more than once before conclusions are drawn. (See also item 9.)

8. Simple apparatus is more appropriate than complicated material for use in experiments in the primary school. As has been previously pointed out, intricate pieces of apparatus borrowed from high school laboratories often detract from the real point of the experiment.

9. Pupils should exercise caution in drawing conclusions from an experiment. c. How children learn science They cannot prove anything from having performed an experiment once. They must regard their finding as tentative until more evidence—either from additional experiments or from authentic books—has been found. Results should be accurately and completely stated.

10. As many applications as possible to everyday-life situations and problems should be made from an experiment. This is a difficult step, but it is one of the most important lessons for studying science. When an experiment has been performed, only the first step in its usefulness has been taken. For example, after pupils have experimented with rusting iron they may want to see how things may be kept from rusting. An experiment is performed involving a wet, unpainted nail and a similar nail covered with a layer of paint. The experimenters note that the unpainted nail rusts and that the other one does not. Now in a real life situation how is this principle applied? In school? At home? On the way to school and elsewhere? The experiment was done to make the idea real. The applications must be made to see how important this idea is and how useful.

Helping children to learn through doing their own experiments is not a difficult job. Pupils should realize that they are experimenting, not to discover information for the first time, as is the case with scientists, but for the purpose of understanding scientific ideas.

Reading

Reading ranks high in the list of ways in which children learn science. Unfortunately, some courses in science deteriorate into reading periods to the exclusion of all other activities. However, reading is one of the ways to learn science and as such deserves thoughtful planning if it is to be an effective tool. Accurate material on the reading level of the various class members must be available, and there must be guidance to help pupils read it. The following considerations are important:

1. The science class is the best place for children to learn to differentiate between fact and fancy in their reading. That is, they should come to know that some books are written for pure enjoyment; others as sources of knowledge. They should learn to challenge the authenticity of what they read. They should learn to exercise care in drawing such conclusions about material; i.e. to check one fact in a reference with an authentic source does not necessarily indicate that the book is accurate. Finding an error on a printed page may be an enlightening experience. The pupil may learn the valuable lesson that just because something appears in print does not necessarily mean that it is accurate.

2. Reading should be done with a definite purpose in mind, i.e. to check a pupil's own conclusion, to find information, to find out how to perform an experiment, to answer a question or to solve a problem.

3. A variety of sources of reading material on a given topic is desirable. More information is obtained and different points of view are seen.

4. It is often necessary for science pupils to do individual reading as a type of simple 'research'. Under such circumstances careful note-taking is essential so that an accurate report may be given to the class.

5. The reading material should be appropriate. This is largely the responsibility of the teacher, but the help of the children is also desirable. Material which is too difficult, or too easy, or which is inappropriate because it does not answer the children's questions, is discouraging. Slow-learning pupils or pupils with reading difficulties need special attention in the selection of their reading materials. Developing skill in reading and learning in science can go hand in hand. But reading is only one of the ways to learn science. To overemphasize it is to ignore some of the fundamental purposes of teaching science.

Before science can be learned, enjoyed, and made to function in the lives of girls and boys, it must leave the pages of a book and get into their daily experience in a graphic way. The textbook will serve as an excellent guide. Problems will be raised by the pupils and teacher together. Ways to solve the problem will be decided on by the group. Then, reading may be, and almost always is, an extremely useful method. The textbook will supply much of the needed information, although that does not mean: 'We shall open our book to page 18 and read to 24 and then talk about what we have read.'

Observing

Observing is another essential activity in all science teaching. Through the use of their senses children can come to experience many things. Feeling the texture of material or the heat from an electric wire attached to a dry cell, seeing cloud formations, seeing the changes in lengths of shadows, listening to birds, and many other similar activities are an important part of their science work. They make learning more vivid.

Children observe to determine the characteristics of things, to see the changes in growing things, to learn the habits of animals, and to see the results of experiments, but they must learn to do so with ever-growing accuracy and to report their observations carefully.

This ability to observe accurately and to report observations correctly is essential. Experimenting is a total loss without it; field trips and visual aids cannot be effective without it. Much may be learned from our daily surroundings if we can train ourselves to be more careful in our observations. Pupils who have experience with this method of learning early in their school experience have a running start on those who do not.

Taking field trips

Making excursions to solve problems and to give information and appreciation are important activities in elementary science. Trips to the park, the zoo, the telephone exchange, the sawmill, the airport, the water purification plant, the rice field and similar places within reach of the school are commonly made by teachers and pupils. These can result in a headache for the teacher, a mere holiday for the children and bad public relations for the school unless the trip is well planned and motivated.

Children should make excursions with definite purposes in mind—to answer questions that are best settled by first-hand observation of the kind trips furnish. They should be aware of the purpose of the trip and the person who is to act as guide should know in advance what the children want to see and learn; the teacher should make a preliminary trip to see the place for himself and talk with the guide. He should assist the guide in keeping the group together, making sure that there is plenty of opportunity to see and to ask questions.

Excursions should be an integral part of a subject being studied and not just something to do. Field trips can be of inestimable value to a science programme, or they can be a waste of time. It is probably safe to say that more time should be spent getting ready for an excursion, and gathering deductions from it, than on the actual excursion itself.

Using visual aids

Another way in which pupils learn science is to see it pictured either in motion or otherwise. Much has been said about the desirability of using visual aids in connexion with primary school science teaching.

Without the use of some of the aids now available a science course is incomplete, but much depends on how the aids are used. Motion pictures and filmstrips are but one of the many useful helps. There are others equally important.

If motion pictures or filmstrips are used, here are a few essentials to be considered.

1. The selection of a film is as important as the selection of a book. Films designed for use at higher levels are generally useless for elementary pupils. Films should be selected which deal directly with the problem under consideration and which are prepared specifically for the levels at which they are being used.

2. Films should be previewed by the teacher and a committee of pupils to determine fitness for showing and to make proper preparation for use. Previewing a film helps to determine the purpose for which the film may be wisely used and when it is to be shown—at the beginning, middle or end of a unit of study, or at more than one of these places as the case may be.

3. The class should be prepared before seeing the film. Pupils should know what to look for in the film and know why they are seeing it.

4. The follow-up discussion of a film is essential. During such discussions, questions are asked, ideas clarified, and further explanations are made.

5. Efforts should be made to help pupils realize that the films are not shown as entertainment but for the purpose of learning. Motion pictures and filmstrips are but one of the types of visual aids useful in primary school science. The use of pictures from magazines and similar sources is often overlooked. In many schools, teachers, pupils and parents have, in co-operation, assembled an excellent teaching collection of pictures. Pictures that show how animals grow, how they are adapted to their environment, where they live, and what they eat, are examples of such picture collections. Pictures that show how we use electricity, machines, lenses, various kinds of power, are other examples. The important thing to remember is that these collections should be made to illustrate certain important ideas and not be just a collection of pictures.

Models are often useful in making ideas clear, and they should be used chiefly for that purpose. There are many instances of model-making in elementary science classes which are almost entirely a waste of time. For example, at the primary school level, making a wax model of the parts of a flower is not very useful, since a detailed knowledge of flower structure is not essential at this level. On the other hand, quite difficult concepts about the solar system can be more easily understood by use of a model of the solar system. It will give an idea of the relative sizes, and of distances between its members, and help pupils to gain better conceptions of other ideas of size and space concepts with which children can begin to deal. The purpose of model making, like the construction of any other instructional aid, should be carefully considered. Building model weather instruments and making balancing toys are other construction activities that contribute to understanding by children.

Thus there are many types of activities through which pupils learn science. The selection of an activity depends on what is to be accomplished. Let it be activity for promoting understanding, interest, and appreciation and not just activity for its own sake. An activity should make a science principle or idea more graphic, more interesting, and give pupils a chance to participate with their minds as well as with their hands.

D. RESOURCES FOR TEACHING SCIENCE

We are continually being urged to use resources at hand to make our curriculum more vital and meaningful to girls and boys. Very often subject matter and methods of instruction make things near at hand seem foreign and far away, because we try to teach without relating them to the children's experiences. A list of all the possible resources in a rural area would be endless and no two regions would contain the same possibilities.

Resources of the type suggested here are useful in at least three ways: they inspire observing pupils to ask more questions; they serve as sources for finding the answers to the questions; and they serve to make the science concepts more real.

The resources

The following pages include some typical examples of local resources as well as suggestions for their use.

1. A gravel pit or stone quarry may be instructive for: learning how the surface of the earth has changed over a period of years; seeing an example of how man uses materials from the earth; learning how observations of geological materials help scientists learn about the age of the earth and changes in climate; seeing how machines are designed and used to serve man; finding fossils to use in a study of animals of the past.

Possible use: take a field trip to observe and gather materials; hear a talk by the owner telling about the place, how the materials are marketed, what safety precautions are used, etc.

2. A wood near the school may be instructive for: discovering changes that animals and plants make as the seasons change; studying habits of plants and animals; finding out where animals live; seeing how animal and plant life depend on each other; seeing how physical surroundings, such as moisture, temperature and amount of sunlight affect living things; finding examples of useful and harmful animals and plants; appreciating the wonders of nature; studying various phases of conservation.

Possible use: take a field trip to observe and collect materials; bring selected materials into the classroom.

3. A burned-over area (roadside, field, wood-lot) may be instructive for: discovering the effect of burning on plants and animals; studying the causes of the fires; arousing interest in ways of preventing such fires if they are harmful; learning ways of stopping such fires; observing how life starts again in such areas; noting over a period of time how long it takes to rehabilitate such an area; seeing the effects burning has on erosion of such an area.

Possible use: visit the area to examine results of fire; collect and examine materials damaged by fire.

4. A nearby field may be instructive for: finding evidences of erosion to see how it starts and how it may be prevented; noting various adaptations which plants make to their environment, such as leaf arrangements, root length and arrangement, and leaf texture; observing various kinds of insects to see how they are adapted to the environment, how they are useful or harmful, and how the harmful ones are being destroyed; observing (if the field is being cultivated) how plants are cared for to provide moisture; noting different amounts of moisture in high and low parts of the field; seeing how the vegetation differs where there is mole moisture.

Possible use: visit field to observe plants; dig some up and bring them back for further study; collect insects for closer observation and study; ask qualified adult to discuss problems of weed and insect control with class.

5. A new building being constructed may be instructive for: Seeing how electrical wiring is installed; seeing how building is insulated; seeing what different materials are being used; examining samples of soil dug from the basement and comparing it with garden soil; learning how sewage is disposed of.

Possible use: collect examples of building materials for study—electrical wires showing different kinds of insulation, rock wool and other kinds of insulating materials, samples of soil, etc.; talk with workmen who are wiring the house, installing plumbing, or doing similar types of work; observe the procedure for locating and drilling well if there is to be one; examine plumbing, cess- pool and location and installation if indoor plumbing is to be used; if outdoor toilet is used, find out where it is located in relation to the water supply and why this location was selected.

6. A saw mill may be instructive for: Learning how trees are selected for cutting; finding out how young timber is protected; learning which kinds of trees are considered most valuable and why; observing the use of machines; learning how lumber is made and cured; observing changes in animal and plant life when an area has been cut over.

Possible use: visit the saw mill to observe the procedures; bring back samples of wood to see growth rings; walk through woods to observe how trees are being cut; examine various machines being used to observe how they help workmen.

7. A farm may be instructive for: Observing various ways of preserving and storing food; caring for animals; growing garden vegetables and flowers; observing the use of machines in house, field, barn, garden,

orchard; observing how buildings and grounds are made free from fires and how accidents are prevented.

Possible use: visit farm to observe science applications; let pupils report examples of scientific facts and applications they have observed at home.

8. A vegetable and flower garden may be instructive for: Studying how plants get enough light, moisture and other essentials for growth; learning how ground is prepared for planting, how plants are transplanted, and how seeds are dispersed; studying how flowers are self- and cross-pollinated and how seeds sprout and grow; learning what kinds of soil are suitable for the growth of different kinds of plants and how the soil is tested; observing how plants store food and how plants change with the seasons.

Possible use: visit the garden to observe plants and methods of growth; make collections of seeds and fruits that show methods of dispersal; sprout seeds in the schoolroom to learn more about how plants grow; perform experiments with plants to see the effects of light, temperature and moisture in growth; plant a school garden (if practical) to learn more about how plants grow.

9. An apiary may be instructive for: Observing how bees are cared for; learning how hives are constructed and how prepared for cold weather; learning what happens when bees swarm and how they are handled safely, and how bees are helpful to man; observing bees at work and learning how life inside a hive goes on; seeing an example of social insects and of insects that are useful to man.

Possible use: visit apiary to observe various activities; talk with beekeeper to learn about bees and how they live; observe dead bees under a reading glass or microscope.

10. A tree on the school ground may be instructive for: Observing seasonal changes, leaf arrangements, bud formation and growth; seeing bird life and nests and learning of the usefulness of birds.

Possible use: observe tree at intervals and discuss observations; cut small branches and study them more closely.

11. An orchard may be instructive for: Learning how plants are transplanted, sprayed and pruned; seeing relationship of plants to useful (bees), harmful (scales, aphids) and other insects; seeing an example of man's use of plants to supply food; observing the effect of sudden changes of temperature or other weather phenomena on plant growth.

Possible use: visit orchard to observe trees at different times of year; mark certain flowers and observe what happens as season progresses; collect and study insects and fruit damaged by insects.

12. A creek or pond may be instructive for: Observing kinds of plant life and the adaptations of stems, roots, leaves, flowers and fruit to moist environment; learning how animals are adapted for life in or near water and contrasting this with land animals; observing how these animals and plants change as seasons change; observing the food-getting and homebuilding habits of the animal life.

Possible use: visit area to observe science applications indicated above; collect specimens of plants and animals for further study.

13. The roadside may be instructive for: Observing animal homes and animal methods of food-getting and of caring for young; observing various forms of plant life to see adaptations to environment, such as methods of seed dispersal and changes under conditions of drought or excess moisture; studying relationships between plants and animals (plants and insects, for example); studying examples of erosion and methods of preventing it. If the road cuts through a hill, pupils can observe the difference between top-soil and subsoil, see the depth of the topsoil and understand more clearly the importance of saving it from being washed away. Possible use: visit area to observe examples given above; collect samples of topsoil and subsoil, try to grow plants in each and note results; collect seed-dispersal specimens.

14. People in the community. There are other people in the community who can be of help. For example, many parents have travelled extensively; some are experts in animal husbandry; some are expert home makers; some can contribute experiences about hunting, trapping and fishing. There is an electrician and a mechanic in nearly every community. People are usually pleased to be asked to help schoolchildren with their problems, and the practice of using adults in the community to help in school may be a beneficial practice to all concerned.

Using these resources

The value of any of these resources depends on how skilfully it is used. Each should be used for a definite purpose or purposes: to help solve a problem, to make a scientific principle more graphic, to increase appreciation of the usefulness and wonder of science. In preparing for a trip, the teacher and children should have clearly in mind a definitely stated problem or problems. The teacher and perhaps a small committee of pupils should first go to the place to be visited by the class, to determine its suitability and accessibility.

Whenever the pupils plan to seek information from someone in the community, make sure that he or she understands the purpose of the visit, and keeps explanations easy enough for them to understand.

Follow-up discussions to make use of the material should be carefully planned. Appropriate data should be used in solving the problem, and written records made of the findings whenever it seems likely that the children will have a use for the records.

Most schools are not yet making full use of the community resources available. We are likely to overlook many common things about us even though we say 'science is a study of the environment'. The science in our rural school is not necessarily being best taught where there is costly equipment. It is being best taught where children and teachers are aware that they are living in a world of science and that the materials for its study are near at hand.

E. FACILITIES FOR TEACHING SCIENCE

Few schools either in towns or rural areas are fortunate enough to afford a separate room for science teaching. Where elementary general science is a part of the curriculum, it is usually taught in an ordinary classroom where other subjects must also be taught. Science, however, is somewhat different from most other subjects in that it is not effectively learned by children unless they experience it. It is not sufficient to hear about science or to read about it. Children must observe and experiment if their science learning is to be permanent.

Thus, if children are to experiment and observe science in their regular classroom, there are some problems which must be solved. In this section a few suggestions will be given to help the busy teacher provide some facilities in his classroom which will make the teaching of science more interesting.

Making a science corner in the classroom

Set aside a corner in the classroom and call it the Science Corner. If possible, secure one or two tables which may be used for experimenting and display. Perhaps the school custodian will help you build shelves underneath the table for storage of materials, supplies and equipment, as described in later chapters of this book. Encourage the pupils to bring in materials to display in the science corner. Some teachers have a little competition each week to see which pupil can bring in the item which is voted the 'Science Item of the Week'.

The Science Corner should be a place of activity and change. The materials brought in by the children should never be allowed to remain on the table so long that their interest value is lost.

Providing aquaria

Aquaria are a source of constant interest and provide a place where many important science phenomena may be observed. Directions for making and caring for aquaria will be found later.

Cages for animals

Several types of animals can be kept in the classroom for observation. Some animals adjust to being caged better than others. Children may be encouraged to bring their pets to school for short periods of observation and study. Suggestions for building cages for animals will be found later.

Setting up a weather station

In Chapter VIII, simple weather instruments are described. These can be made from materials available almost anywhere. Observing the weather changes from day to day is a source of interest and can form the basis for useful science lessons.

A science bulletin board

If children are encouraged they will constantly bring to school interesting things they have clipped from newspapers or magazines. The science bulletin board provides a place to display such materials, as well as drawings and other things prepared in science classes. A good place for the science bulletin board is just above the tables in the science corner. The bulletin board can be made from soft wood or plaster board.

Growing things

Small flower pots placed along a window-sill where there is plenty of light will provide ample space for growing seeds and small plants. If more space is desired for some experiences, shallow wood boxes may be obtained or made from old orange crates.

A museum shelf

Once children become interested, they are insatiable collectors. Some of the things they collect are bound to find their way to school. Such activities should be encouraged. One way to do this is to provide a museum shelf where collections or individual science items may be displayed.

**“BE A GOOD SCIENTIST. FOLLOW INSTRUCTIONS EXTREMELY CAREFULLY.
WEAR PROTECTIVE CLOTHING WHEN WORKING ON ANY EXPERIMENTS
THAT INVOLVE FIRE OR EXPLOSIONS.”**

CHAPTER II

How to make some general pieces of equipment

Wherever science teaching is based upon experiment and observation, there are certain pieces of apparatus that are used over and over again; such things as burners, tripods, flasks, aquaria, dip nets, etc. are almost indispensable in a science course. This chapter will be devoted to instructions for making pieces of equipment that are frequently used.

A. WEIGHING DEVICES

1 Simple 'spring' balance

Punch four holes in an old tin lid with a nail, spacing them equally round the circumference. Pass pieces of string through these holes and tie them together. Now attach this scale

If weights are not available, it is possible to graduate the balance using known volumes of water poured from a measuring jar and by making marks on the supporting stick opposite the edge of the pan. Stones can then be found which will give the same extension and these should be marked for future use as weights. The use of coins for this purpose should also be investigated.

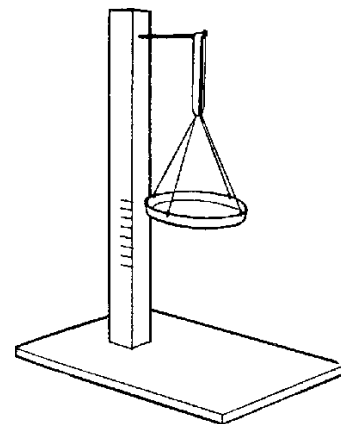

2 A serviceable spring balance

The quality of rubber deteriorates rather rapidly in unfavourable climatic conditions; a coiled steel spring is preferable. The pattern described has been found satisfactory. The coil is protected from damage by enclosing it in a tube. The reading is made at the bottom of the tube on a graduated wooden plunger.

First wind the spring (see Chapter XVIII, item 35), attach it by a screw eye to a piece of dowelling which will fit into the tube selected (bamboo or plastic). Fasten the other end of the spring by a wire staple to a wooden stick which will slide in the tube. Fix the dowelling to the top of the tube and insert into it a hook for suspending the balance. Screw another hook into the wooden plunger which can now be graduated.



3 Spring balance for heavier loads

Fasten a chair or automobile cushion spring to a flat piece of wood that will serve as base to the instrument. As scale pan, use a large tin lid or plate. Fix this to the top of the spring. If it is not possible to use solder for this purpose, the scale pan can be secured by fine wire passed through double holes punched through it in convenient positions.

Attach two vertical laths to the base. These act as guides to the scale pan. Make graduations on these guides when loads of 0.5, 1, 2, etc., kilograms are placed on the scale pan. Wine bottles filled with water make suitable measures of litres, etc., and contain, of course, the equivalent weights in kilograms.

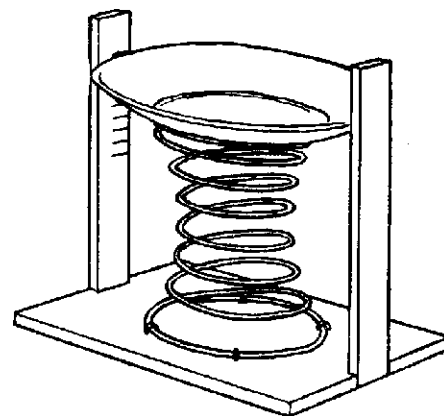

4 Steelyards

Either Roman or Danish steelyards can be improvised using short lengths of lead or iron water pipe as counter-weights and loops of wire as pivots.

The rod can be of either wood or metal; in the latter case notches can be filed on the underneath of the bar to indicate the balance points for various weights.

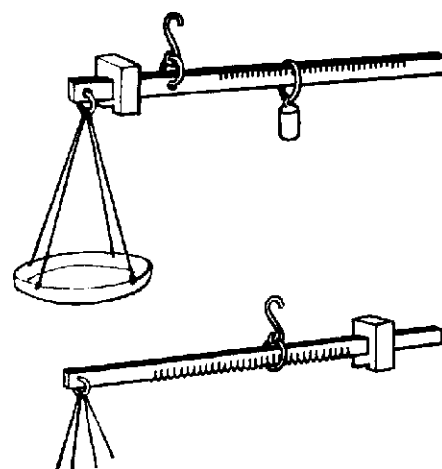

5 Laboratory steelyard

To make a steelyard weighing to 500 g use a wooden lath one metre long balanced on a strong sewing needle stuck through it 3 mm from its upper edge and 12 cm from one end. A disk of lead or anything suitably heavy can be used as counter-weight: if lead is used, a disk of it can be 'cast' in a tin lid.

A wire stirrup carrying a boot polish tin lid serves as scale pan and can be suspended 6 cm from the pivot.

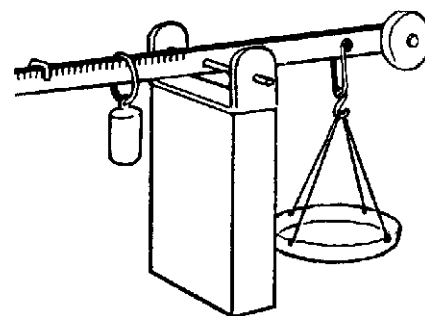

A piece of U-shaped metal or two brass mirror plates separated by a wooden block will provide a suitable support.

Two sliders are needed, one weighing 50 g could be a piece of lead suspended by a copper wire: the other of 1 g weight could be in the form of a U resting on the top edge of the lath. The top edge can be calibrated in 6 cm divisions.

To use this apparatus, the nearest balance point is found by using the 50 g weight, and the final adjustment is made with the 1 g rider. No divisions are provided for this but the distance from the nearest mark can be quickly obtained by using a pair of dividers.

This balance is very quick in action and is satisfactory in use.

6 Clock spring balance

A sensitive balance for use between 0-1 g or 1-10 g is readily made using a piece of clock spring and a block of wood or cotton reel.

Fasten the wooden block or cotton reel down to a convenient base. Fix a piece of watch spring about 10 cm long to it and make a cardboard or paper conical pan. Fix the pan to the spring near the free end using sealing wax or cements suggested in Chapter XVIII. Use the free end as a pointer, and a postcard as a scale, and calibrate it by putting weights in the pan. The sensitivity depends on the spring used, but the scale is a reasonably open one.

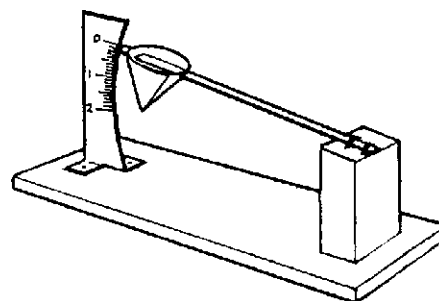

7 Simple steelyard (reading to 100 g)

The pan is made from cardboard, and is shaped like a funnel. It is fixed to a beam made of a triangular-shaped lamina in plywood or 'Perspex'.

The beam tapers from 2 cm at the extreme end to 5 cm near the pan. The pivot, which can be a strong darning needle, is driven through the beam at a point about 5 cm from the pan and 2 cm from the top edge. Some part of the beam or pan can be cut away to make it balance.

The pivot is supported in holes through a metal stirrup, and an outer stirrup serves to prevent the beam from slipping sideways. The top of the beam carries a U-shaped rider; notches are made in the beam using standard weights to calibrate it. Powdered solids can be weighed using a filter paper or a piece of paper folded into a similar cone.

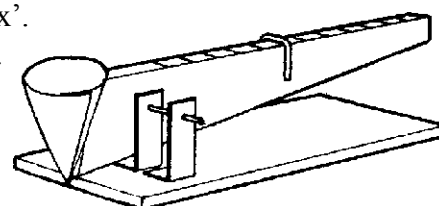

8 Soda straw balance

Obtain a small bolt (3 BA) which just fits inside the tube of a drinking straw, and screw it a few turns into one end. Determine roughly where this arrangement balances and punch a sewing needle through the straw to serve as a pivot. To ensure stability the hole should be made a little above the diameter of the straw.

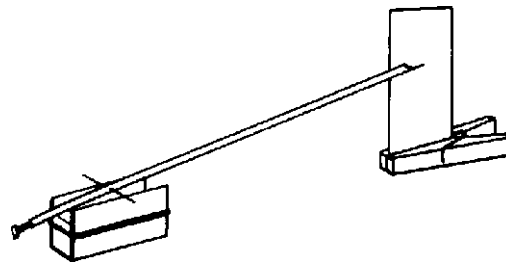

Cut away the other end of the straw to form a small scoop.

When the needle is in place set it across the edges of two micro- scope cover slips (or two razor blades) held parallel by a block of wood and a rubber band. Adjust the bolt until the straw balances at about 30 degrees to the horizontal. Support a piece of card vertically behind the scoop using a clothes peg or another piece of wood and a thumb tack; this will serve as a scale.

Hang a hair or a small piece of tissue paper from the scoop and notice the deflection. To obtain quantitative readings the scale must be calibrated. Aluminium foil from cigarette packets is suitable for making small weights. A common gauge of foil weighs 5 mg for 2 sq. cm of area. Cut the foil into areas weighing 1 mg, 2 mg, etc., and place them in the scoop using a piece of copper wire bent to form tweezers. Record the positions of rest of the beam by making marks on the card. The sensitivity of the balance can be varied by adjusting the position of the bolt.

9 Zehnder's balance

This ingenious balance, which is very useful for demonstration experiments, can be constructed in a few minutes using pins, razor blade, cork and knitting needle.

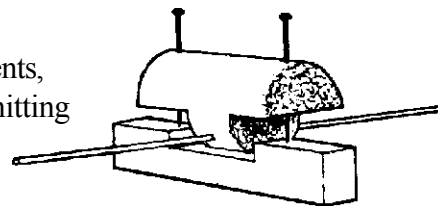

The knitting needle is first pushed through the cork as eccentrically as possible along a line parallel to a diameter of the end of the cork.

Half cylinders are cut away from each end of the cork to produce the balance beams as shown. The supporting pins are now pushed through the cork, and can rest on slips of glass glued to a strip of wood.

The sensitivity of the balance can be varied by adjusting the supporting pins.

Experiments with the balance

1. A small rider of sewing thread or of the thinnest tissue paper, weighing about 2 mg and placed half-way along one arm, produces a turn of about 2 cm.
 2. A slight formation of gas can be demonstrated by allowing the gas issuing from a small jet to impinge on the end of the beam.
 3. Convection currents in air are shown by bringing a lighted match below the beam.
 4. Since the balance-beam is an insulated conductor, it will show electrification. It can be charged by touching it with an electrified rod.
 5. If the knitting needle is magnetized, it becomes a dip needle.
 6. If the beam is magnetized and a wire spool is brought near to one of its poles, the balance becomes a galvanometer. For example, a thermocouple of iron-constantan can be connected to a coil of 22 turns of copper wire (1.5 mm thick). This, when warmed by a candle flame, produces a potential difference of only about 0.01 volt; nevertheless, the balance-beam detects the current flowing.
 7. Projection. Small movements of the balance can be shown by using a beam of light reflected from a small strip of mirror attached to the beam. With this simple projection apparatus, thermo-electric currents can be demonstrated if the thermocouple mentioned above is merely warmed by the fingers.
-

10 A general utility equal-arm balance

Construct a base about 22 cm square from wood about 2 cm thick. Next make two uprights from wood 15 cm long by 6 cm wide by 2 cm thick and attach these near the centre of the base about 2.5 cm apart. They may be attached either with screws or by slotting the base and screwing the uprights to it. The top of each upright should be cut deeply enough with a thin saw to allow a razor blade to extend about 4 mm above the wood. The razor blades are wedged tightly in the slots.

The beam of the balance is made from a metre stick or similar length of wood with a thin finishing nail through its exact centre of balance. The nail rides on the razor blades.

To give stability to the beam, the supporting nail should be positioned a little above the geometrical centre.

11 A sensitive beam balance

The materials needed for this balance include a clothes peg, a knitting needle about 12 in. long, two pins or needles and a support such as a milk bottle or preserving jar.

The beam of the balance is made by passing the knitting needle through the hole in the spring of the clothes peg. The pivots for the beam are the two needles or pins placed one on either side of the clothes peg, slightly below the hole through which the knitting needle passes. The latter must project equally on either side of the clothes peg, and can be wedged in this position inside the spring by a small splinter of wood. The lower end of the clothes

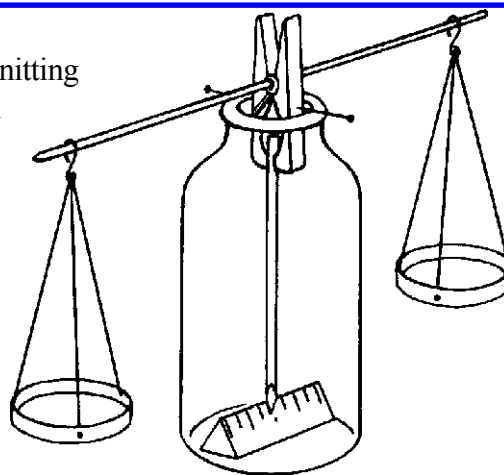

peg grips a pencil which serves as the pointer of the balance. The pans of the balance are made from two tin lids pierced at the circumference by the equally spaced holes through which threads are passed and tied together to form a loop from which they can be suspended from the beam. Once the scales are balanced it is advisable to make a nick with a file to prevent the loops slipping off the knitting needle. Finally a graduated scale is placed inside the bottle in such a way that the pointer swings in front of it.

The weights may be coins, crown corks, matches, etc., correlated to standard weights. If none of the latter are available two similar small bottles may be used, one in each pan, and known amounts of water poured into one of them from some graduated vessel. Failing all else an old novocaine tube used by dentists for local anaesthetic is graduated in cubic centimetres and may serve as a very small measuring cylinder. Fractional weights may be improvised by hanging a loop of wire from the beam.

B. SOURCES OF HEAT

1 A tin can charcoal burner

A large tin can at least 10 cm in diameter should be used. About 4 cm from the bottom mark off triangular windows around the can, as shown in the diagram. With a pair of shears cut along the sloping sides of each triangle to make the windows. Do not cut along the base line. Bend the triangular parts inward to form a shelf for the charcoal.

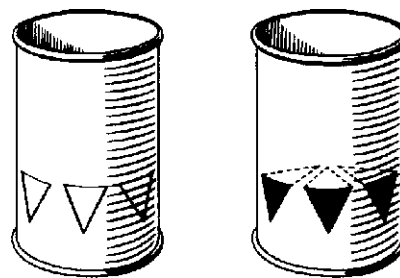

2 Methylated spirits burner

A simple burner can be made from an old boot polish tin. Though it is not essential, a metal tube can be soldered to the top and a twisted piece of wire makes a convenient handle. A piece of rag or cotton waste can be used for a wick.

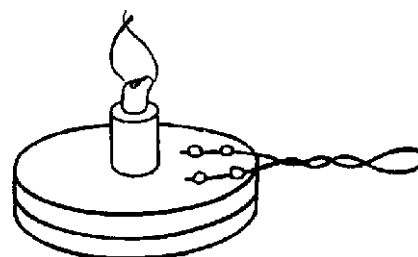

3 An alcohol lamp from an ink bottle

Secure an ink bottle with a metal top which screws on. Punch a hole in the centre of the metal top with a nail. Enlarge the hole until it is about 8 to 10 mm in diameter by using a circular motion on a triangular file inserted in the hole. Smooth the opening by using some hard, round device. Cut a piece of metal about 2.5 cm wide and 4 cm long from a soft metal can or piece of sheet metal. Roll this into a tube on a piece of dowel rod or other round wood stick of suitable diameter to fit the opening in the top of the ink bottle. Insert the tube in the top and let it go about 1 cm into the bottle. The tube may be soldered around the joint with the top and along the seam. A wick may be made from cotton waste, a bit of cotton bath towel or from a bundle of strands of cotton string. Be sure to have enough wick to extend to the bottom of the bottle and cover it. Use denatured or wood alcohol. In hot countries a cap should be made to cover the wick when the lamp is not in use. An old fountain pen cap may serve the purpose. If a brass rifle cartridge is available it can be used to make both the tube and the cap by cutting it

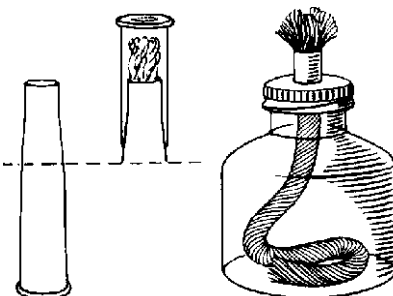

C. OTHER USEFUL THINGS

1 Demonstration vernier

Two pieces of tongued and grooved floor board about 1 m long can be used to make this apparatus. Saw 7 cm off the tongued board and glue it into the groove to provide an end stop. With Indian ink or saw cuts, mark off graduations 5 cm apart along the whole length of the longer board. Use about 50 cm of the tongued board to provide the vernier slide. Graduate it by measuring 45 cm from one end and dividing this into ten equal parts, i.e. 4.5 cm each. The remaining piece of board can be used to provide brackets so that the apparatus will stand vertically on the bench.

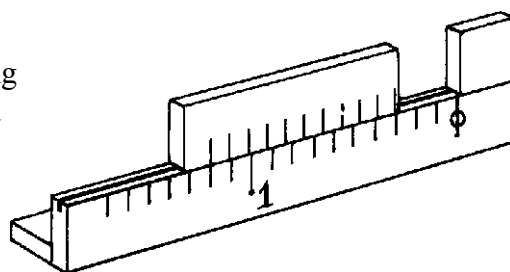

2 A simple tripod

A useful tripod can be made by cutting away the sides of a tin can. It is convenient to make two or three of these to suit different burners and for use as stands. Holes should be punched along the upper edge to let the products of combustion escape.

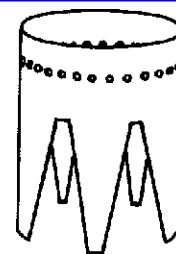

3 A steam bath

An evaporating dish and steam bath can be contrived from a saucer and a tin. Scallops are cut out of the top of the tin to allow the steam to escape.

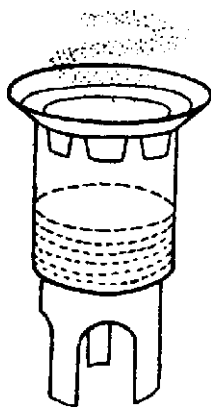

4 Heater

Another form of heater can be made from an old oil tin. Iron wire is wrapped round a test tube and twisted to form a handle.

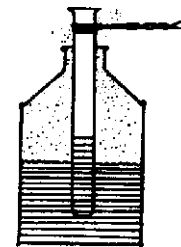

5 Steam supply for experiments in heat

A tin with a press-on lid may be used to make a steam can. Punch two holes in the lid and solder through them one long and one short pipe as shown in the diagram. The long pipe serves as a safety valve and the short one supplies steam to the experiment (through a rubber tube attached). When the tin leaks or becomes rusty the same lid may be transferred to a similar tin.



6 A simple calorimeter

Small soup tins can be found which fit loosely into a 1 lb. jam jar. If the top of the tin is cut off cleanly with a rotary type opener it serves as an excellent calorimeter.

The tin can be prevented from slipping into the jar either by a stout rubber band round the edge, or by cutting nicks in the rim and bending it slightly outwards. This form of suspension, and the low conductivity of glass and air contribute to its efficiency.

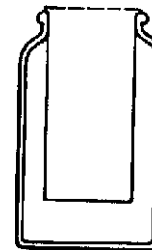

7 Distilled water

A kettle can be used to provide boiling water, which is then condensed in a jam jar fitted with a large cork and immersed in a pan of cold water. Rubber tubing, adhesive tape or clay can be used to make the joint.

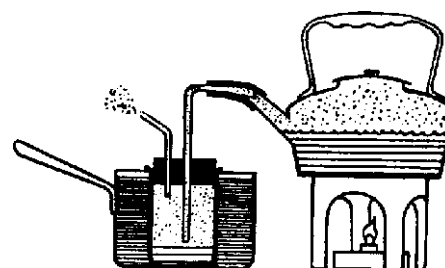

8 An air oven

A large tin can be used as an air oven. A hole through the lid fitted with a cork holds a thermometer, and the saucer or dish rests on a wire gauze bridge placed inside the tin.

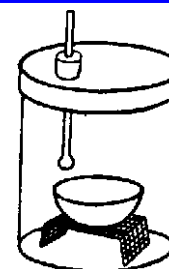

9 Liebig condenser (iron)

A piece of iron pipe such as is used for water or electric conduit can be used to make a metal condenser which is much more robust than a glass one. Inlet and outlet tubes are screwed or soldered to the sides. A one-hole cork fits each end and passes ordinary glass tubing.

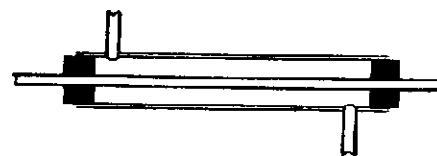

10 Filter

A plant pot with a plug of cotton wool in the bottom and a layer of sand a few inches deep makes a satisfactory filter for many purposes.

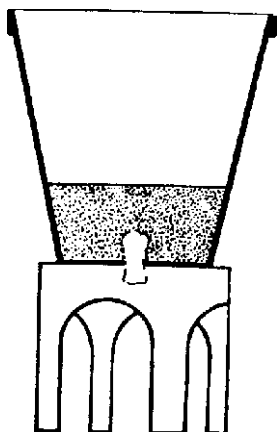

11 Filter pump Some skill is required to construct the ordinary glass filter pump, but it is possible to contrive one from glass tubing and good corks. The action of the pump depends on the principle that a jet of water directed down a narrow tube carries air with it and reduces the pressure of the air in the vicinity (Y). The best sizes for the jets will be found by trial and error, but 1 mm diameter for the first jet and 2 mm for the second jet gives good results.

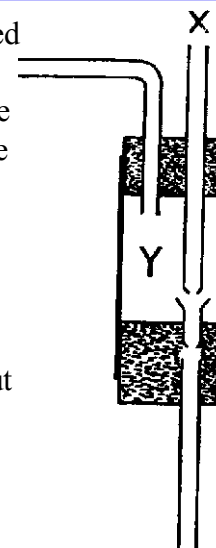

12 Apparatus for individual work in chemistry

Most of the experiments in elementary chemistry require some basic equipment such as beakers, test tubes, etc. The outfit described below will be found to include all that is usually required. The 150 cc Pyrex flask with a round neck can be used either as beaker, flask, or steam generator. An ordinary glass tube with a roll of wire gauze round it can be used as a combustion tube and does not break more often than the usual hard glass tube.

A specimen tube can be converted into a satisfactory small gas jar. Though not essential, a small test tube rack is convenient, and the small test tubes suggested have the advantage that they can be closed by the small fingers of children. A large tube with a wooden base is useful as a stock bottle for many other experiments. If running water is not available, a condenser is provided in the form of a large tin (500 cc) of water. The only difficult task is to make a water-tight joint for the outfall tube. This apparatus has been found very useful for junior class practical chemistry.

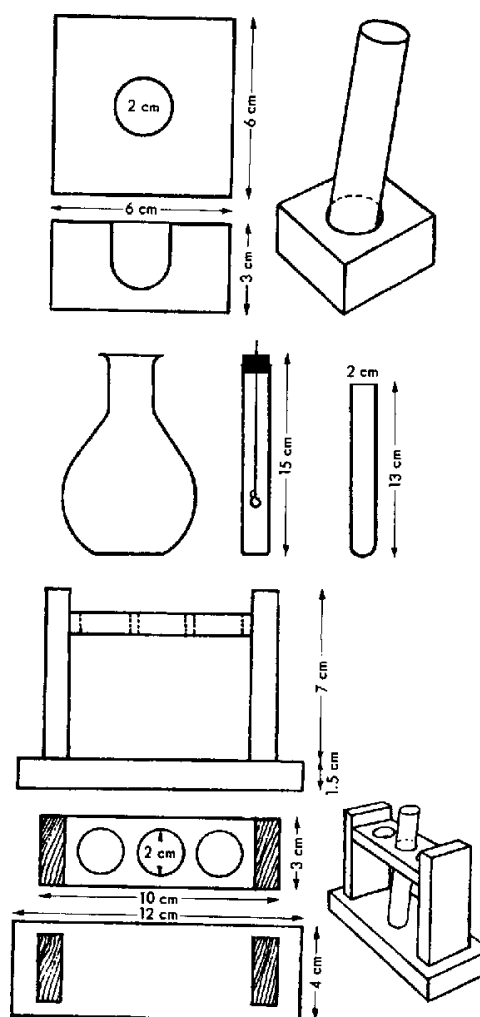

13 Containers from used electric bulbs

Used electric light bulbs can be made into containers that will substitute for flasks, beakers, test tubes and similar devices. With reasonable precautions these will stand considerable heat and handling. Any size electric bulb may be used. A variety of sizes will prove useful.

It is a wise precaution to wrap the bulb in an old towel or other piece of cloth while working with it. Begin by lifting the small metal button in the centre of the bulb top with a knife. Bend this up until it can be grasped with a pair of pliers. Raise this metal button by pulling upward on it with the pliers. This should expose the wire to which it is connected. Break the button away from the wire with a twisting motion. The hole in the centre of the black insulation should now be exposed. Carefully loosen and remove this insulation. It may be necessary to crack it into several pieces with the pliers. Be as careful as possible not to bend the brass shell. The next operation needs considerable care and you may break a few bulbs before developing enough skill. Hold the wrapped bulb firmly and use the top end of a file. With a quick motion puncture the bulb through the opening at the top. The glass rod which supports the bulb filament should drop into the bulb. Next use a round or rat-tail file to cut the jagged glass back at the neck. This can be done without cracking the bulb. The support rod and other material can be removed from inside the bulb which is now ready to use. If the brass shell which forms the top of the flask has been bent it can be re-shaped by inserting and rotating a piece of round wood of the proper diameter. The brass shell enables tight fits to be made with corks and rubber stoppers when needed in constructing a piece of apparatus.

14 Cutting a glass dish from a used electric bulb

The hemispherical bottom of an electric light bulb provides a useful glass dish; a soldering iron can be used to cut it off. Place the bulb on its side and make a scratch with a file somewhere along its line of greatest circumference. Support the soldering iron at an angle of 45° in a laboratory clamp so that the tip is the same height above the bench as the point of incision. Hold the bulb in both hands and, keeping it horizontal, bring the scratch into contact with the point of the soldering iron.

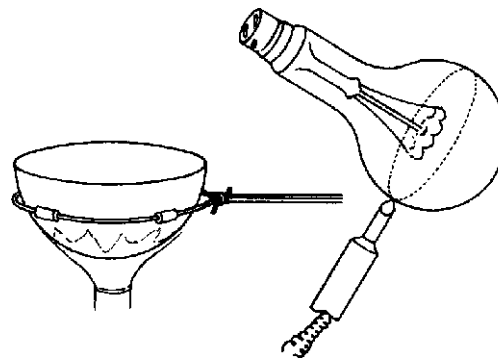

There will be a slight crack indicating the beginning of cleavage; the bulb, still held against the iron, should now be rotated on its axis to complete the cut. The sharp edge left by the cut can be removed by heating the rim in a gas flame.

In use these dishes are best supported on a wire ring with bearing points of asbestos fibre to prevent possible cracking along the wire. The remaining part of the bulb can be used to make a Voltmeter.

15 A measuring jar or graduate

Select several straight-sided glass jars of assorted sizes. Olive bottles are very useful for the making of graduated cylinders. Paste a strip of paper about 1 cm wide along the bottle to within about a centimetre of the top. Next secure a commercial graduated cylinder of about the same capacity as the bottle and measure out sufficient water to fill the bottle nearly to the top of the paper scale. Draw a line across the paper scale and mark under it the number of cubic centimetres of water poured in, say 50 cc or 100 cc. Next, if the bottle is of uniform diameter, divide the distance between the bottom of the bottle and the line into some convenient number of parts. Draw lines across the paper and label each division. For example, suppose that 50 cc of water were used: you might then divide the length of the bottle into five equal parts; the first line from the bottom would be marked 10 cc, then next 20 cc and so on. Each large scale division may next be sub-divided into smaller parts and lines placed across the paper scale. The graduated cylinder so constructed should be tested at several capacities by filling it to a certain level and then pouring the water into a commercial or standard vessel. Some of the lines may have to be moved slightly. When you have completed the test, you can make the scale permanent by covering it with a thin coat of melted paraffin, shellac label varnish or plastic cement.

16 A test tube holder

A suitable test tube holder can be made by bending strong spring wire made of iron or brass into the shape shown in the diagram. Wire from a coat hanger works very well.

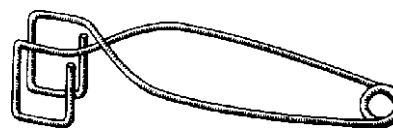

17 Laboratory tweezers

Very serviceable tweezers can be made from lengths of flexible strap iron used to put around boxes and crates for shipment.

The tweezers shown are about 12 cm in length. The pair shown in diagram a can be made by brazing or riveting two pieces of strap iron together and then bending and cutting to the proper shape. Those in diagram b were fashioned from a single 26 cm length of strap iron. The round head was made by pinning the centre of the strip around an iron rod of suitable diameter. The sides were then cut and shaped to size.

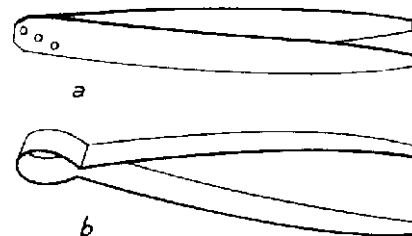

18 A metal ring stand and rings

A useful ring stand and rings can be made from a flat curtain rod and the fixtures which clamp over electric bulbs to hold lamp shades. These are usually obtainable in hardware stores. The curtain rod is shaped as shown in the diagram.

The curtain rod consists of two pieces fitted to slide together so that they are adjustable for curtains of different width.

Attach each part of such a curtain rod to a suitable wooden base either with nails or screws. A triangular brace secured against the rod and attached to the base will make the ring stand stronger. This is shown in the diagram. The lamp shade fixtures are squeezed together and the prongs fitted into the slot on the inside of the curtain rod. The spring pressure is sufficient to hold the fixture at any height, making a very useful ring for the ring stand. Another type of ring may be made by bending wire from a coat hanger into the proper shape and size.

19 A wooden ring stand

The base for this ringstand is made from a piece of wood 40 cm long, 15 cm wide and 1 cm thick. A hole 1 cm in diameter is bored through the centre of the base. The upright is made from a piece of dowel rod 1 cm in diameter and 45 cm long. The dowel rod upright must fit very tightly in the hole made in the base. If dowel rod of this size is not available, another size may be used, but the hole in the base should be made accordingly.

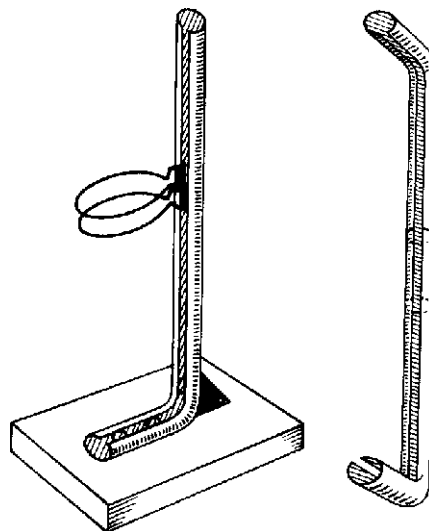

20 Equipment support bar for ringstand

A useful equipment support bar for the above ringstand can be made from a piece of wood 18 cm long, 4 cm wide and 1 cm thick, together with four clothes pegs of the spring pincer type. The clothes pegs are attached to the bar as shown in the diagram. The clothes pegs at either end support equipment such as test tubes, and the two placed parallel nearer the centre clamp to the upright of the ring-stand. Observe that the clothes peg on the right-hand end of the bar is set at an angle, after a suitable place has been levelled, as shown in the diagram. This makes it possible to support the test tube at an angle so that it may be heated without setting the wooden clamp on fire.

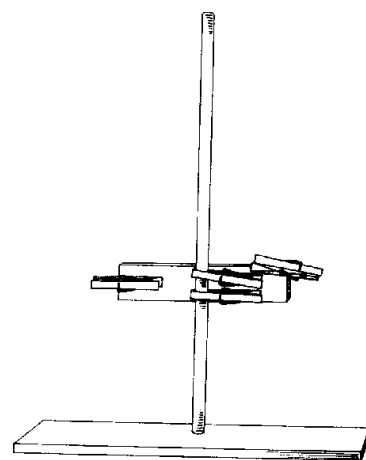

21 Iron pan

This is useful for many experiments in chemistry. The lid of a preserving jar is looped with galvanized wire. The free end of the wire is embedded in a piece of wooden dowelling rod, so that it can be supported in the left-hand clamp of the wooden stand.

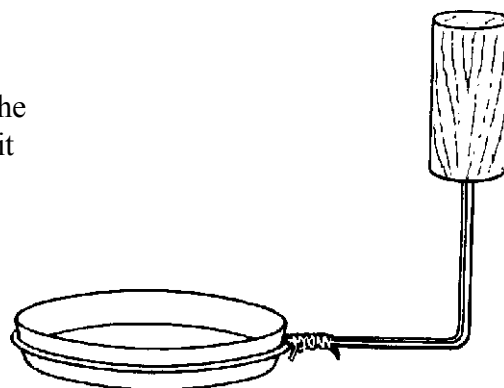

22 Automatic gas generator

This is a semi-micro Kipp's apparatus. The solid reagent (zinc, marble, iron sulphide, etc.) is placed in a large test tube with holes in it, and the acid is contained in a jar or other receptacle. A series of holes is made in the bottom of the test tube using a blowpipe and playing a fine jet, one shot at a time, until the glass is pierced. Glass beads, or short lengths of glass tube placed vertically, are put on the bottom of the test tube to serve as a platform for the solid reagent. A rubber stopper with a glass tube through it is then inserted in the test tube and connected by rubber tubing to a glass nozzle. The outlet is closed by a clip or by pinching the tube with the fingers.

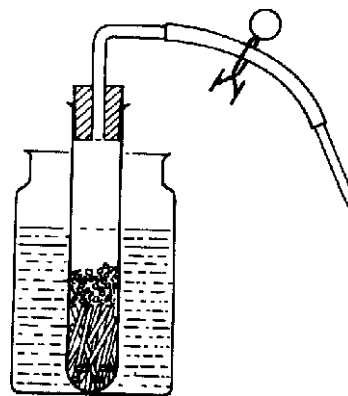

23 An electric device for cutting glass jars and bottles

A considerable number of pieces of useful equipment can be made from bottles, jugs, flasks, used electric bulbs and other things made of glass. It is often necessary to cut the top or bottom from such objects to adapt them to specific purposes. This piece of equipment will prove most useful for cutting such devices cleanly. After the cutting operation it is necessary to smooth sharp edges either with a file or by means of fire polishing.

Two wood uprights 20 x 7 x 4.5 cm are attached to a base of suitable size at a distance 15 cm apart.

Holes of suitable size to hold brass rods of 5 mm diameter are bored through the shorter dimension of each upright about 2 cm from the top. Through one upright a brass or iron bolt is put. Through the other a longer piece carrying a handle is placed. Notice that the drawing shows a set screw for the regulator.

A length of nichrome, or other wire of high electrical resistance suitable for the source of electricity (12 v, from a step-down transformer, 220-12 v, or 110-12 v) is attached to the ends of the rods by means of suitable nuts. The electrical circuit is shown in the drawing.

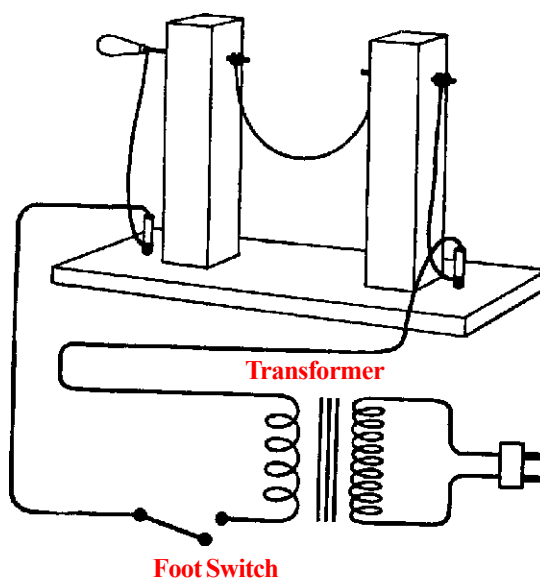

CHAPTER III

Experiments and materials for plant study

A. ROOTS

1 How to grow root hairs

Hairs can easily be seen on the roots of mustard seed grown on a damp flannel. Seeds placed on an earthenware dish standing in a soup plate containing water will produce very good specimens if covered by another plate to keep the air moist.

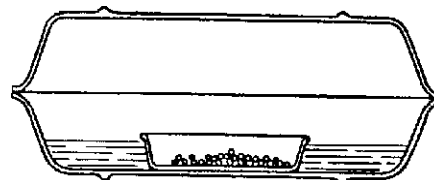

2 Observing root hairs

Study the root hairs with a hand lens and observe how they are constructed.

3 Testing whether roots absorb water and suspended solids

Three similar plants are inserted into test tubes containing 1, water; 2, red ink; 3, a suspension of congo red. After a few days 2 will be found to be coloured; 1 and 3 un-coloured, having absorbed only water.

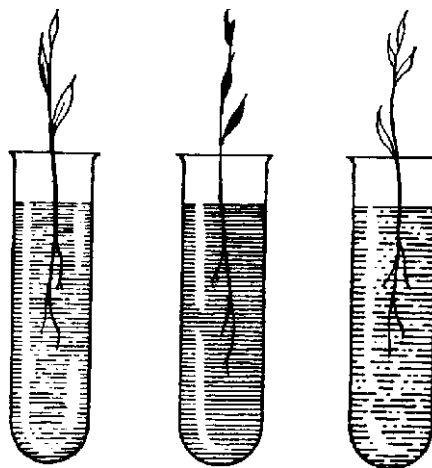

4 A simple osmometer

Remove the bottom from a small glass bottle about 2.5 cm in diameter. Fit a one-hole stopper tightly into the bottom and put a 50 cm length of glass tubing or a length of two soda straws through the hole.

Place a piece of cellophane or parchment paper over the other end of the bottle and fasten it securely by winding with several turns of string or strong thread. Fill the bottle with a very concentrated sugar solution and replace the one-hole stopper being sure that no air bubbles remain inside the bottle. Clamp the osmometer in a glass of water and allow to stand a few hours.

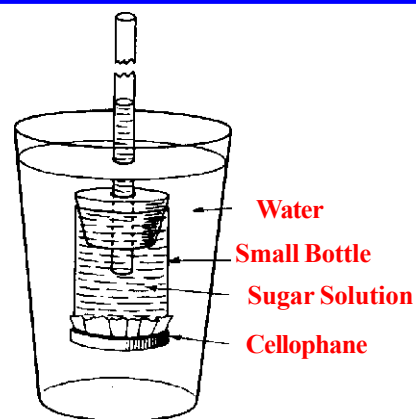

5 A carrot osmometer

Select a carrot which has a large top and which is free of breaks in its surface. With a sharp knife or an apple corer cut a hole in the top of the carrot about 2 or 2.5 cm in depth. Be careful not to split the top. Fill the cavity with a concentrated solution of sugar. Insert a tightly fitting one-hole cork or rubber stopper which carries two soda straws pushed together or a length of glass tubing. Place in a jar of water for a few hours. If your cut in the top of the carrot has not been even it may be necessary to seal the cork in with some wax dripped from a burning candle.

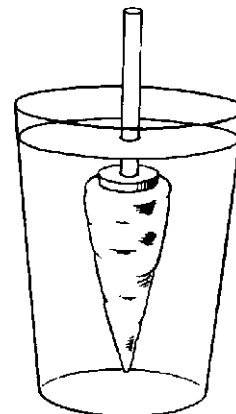

6 An egg osmometer

Place some dilute hydrochloric acid or strong vinegar in a shallow dish, such as a saucer, to a depth of about one centimetre. Hold the large end of an egg in the acid until the shell has been eaten away on the end leaving the thin membrane exposed. Rinse the acid from the egg. With a sharp instrument work a small hole through the shell at the other end. Insert a soda straw or a length of glass tubing through the hole into the interior of the egg. Seal the opening around the tube with house hold cement or sealing wax. This must be absolutely tight. Place the osmometer in a glass of water and let it stand for a few hours.

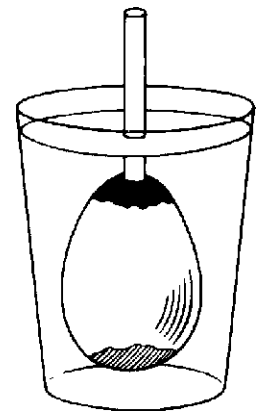

7 The effect of gravity on roots

Cut several pieces of blotting paper about 8 cm square. Place these between two squares of glass. Place several radish or mustard seeds between the blotting paper and glass on each side and secure with rubber bands. Wet the blotting paper and then stand the apparatus upright in a shallow saucer of water. When the seeds have sprouted and the rootlets are about 1.5 cm long, turn the squares through 90-degrees and allow them to remain undisturbed. Repeat the turning and observe the effect on the roots.

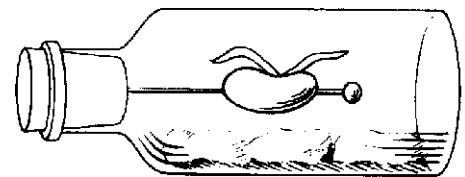

Another way to study the effect of gravity on roots is to sprout some seeds and select one that is straight. Pierce the seed with a long pin or needle and stick this into a cork. Place some damp cotton or blotting paper in a bottle. Put the cork and seedling in the bottle. Place the bottle in a dark cupboard and look at it every hour or so.

8 How are roots affected by water?

Grow some seedlings in one end of a glass dish or pan. When they are about 5 cm tall begin watering them on one side only and a little distance away from the nearest plants. Continue the watering daily for about a week and then dig away the soil and see if the watering has had any influence on the direction of growth of the roots.

9 Growing roots from different parts of plants

Secure a box of sand and place it away from direct sunlight. Wet the sand thoroughly and keep it moist. Plant the following things in the sand:

- (a) Various bulbs.
 - (b) Cuttings of begonia and geranium stems.
 - (c) A section of sugar cane stem with a joint buried in the sand.
 - (d) A section of bamboo stem with a joint buried in the sand.
 - (e) Carrot, radish and beet tops each with a small piece of root attached.
 - (f) An onion.
 - (g) An iris stem.
 - (h) Pieces of potato containing eyes.
 - (i) A branch of willow.
-

STEMS

1 The effect of light on the growth of stems

(a) Plant some seeds that grow rapidly such as oats, radish, bean or mustard seeds in two flower pots. When the seedlings are about 2.5 cm high, cover one pot with a box that has a hole cut near the top. From time to time lift the box and observe the direction of growth. Turn the box so that light comes from a different direction and observe again after a few days.

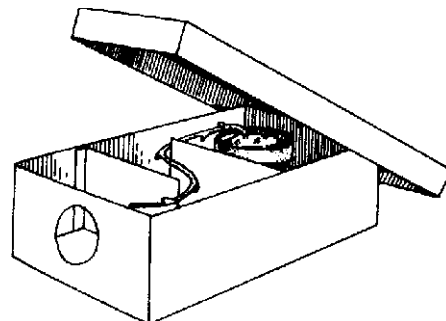

(b) Put two light baffles in a long, narrow box as shown in the diagram, and cut a hole in the end. Plant a sprouting potato in a small pot that will fit in the box. Place the pot behind the farthest baffle from the hole. Cover the box and place in a window. Observe the direction of growth from time to time.

(c) Plant four flower pots with some fast-growing seeds as in (a) above. Keep the pots in a darkened room until the seedlings are about 2.5 cm high. Place one pot in a sunny window and observe the effect. Turn the plants away from the light and observe. Leave the pot in a place away from direct light for a few days and observe the results. (d) Place each of the three remaining pots of seedlings in a different box. Cut a window in each box and cover each window with a different colour of cellophane such as red, yellow and blue. Place the three boxes containing the pots of seedlings in good light with the window facing the light. Observe any difference in the effect produced by different coloured light on the growth of stems.

2 Stems transport liquids

(a) Cut about 2 cm from the end of stems of celery and place them in cold water for about an hour to freshen. Next place the stems in dishes containing red ink and let them stand for several hours. Observe the stalks carefully. Cut them up into several short lengths and observe where the ink has moved upward in the stem. Try to pull some of the tubes out of the celery stems.

(b) Cut about 2 cm from the end of the flower stalks of white carnations. The cutting should be done with a sharp knife and under water. Place the stems with flowers in glasses containing different shades of food colouring or coloured ink. Observe after several hours.

(c) Split the stalk of a white carnation into three parts with a razor blade. Extend the split 8 or 10 cm up the stem and then wrap with tape to prevent further splitting. Spread the three sections out and place each in a vessel containing a different colour of ink or food dye. Observe the flower after a few hours.

(d) Put the cut ends of twigs or shoots of several kinds of trees in coloured ink and later cut them into short sections with a sharp knife. Observe the places where the colour has gone up in the stem.

(e) Plant seeds of common garden plants in flower pots. When the seedlings are 8 to 10 cm high and growing vigorously, cut the upper part of the stem off with a sharp knife. Soon drops of water will be seen where the cut was made.

3 Different types of stems

(a) Monocots. Secure stems of several plants such as bamboo, sugar cane and corn. Cut each of the stems crosswise with a very sharp knife or razor blade. Observe the similarities in the cut cross sections. Especially notice that the tubes or fibro-vascular bundles are scattered throughout the pith on the inside of the stem.

(b) Dicots. Secure the stems of several plants or small trees such as willow, geranium, tomato, etc. Cut across each of these stems with a sharp knife or razor blade. Observe that just under the outside layer of the stem there is a bright green layer. This is the cambium layer. Also observe that the tubes or fibro-vascular bundles are arranged in a ring about the central, or woody portion of the stem.

C. LEAVES

1 Types of leaves

Collect leaves from such plants as lilies, bamboo, sugar cane, corn, willow and geraniums. Observe that the monocots (lily, bamboo, corn, sugar cane) have the veins running parallel. Observe that leaves from dicotyledrous plants (willow, geranium, etc.) have branching venation.

2 Making leaf collections

Collect young leaves of as many varieties of plants as possible. Place several layers of news- paper or blotting paper on a firm, smooth board. Next arrange the leaves so they do not touch. Cover the leaves with other layers of newspaper or blotting paper. Place another board on top and then place several heavy stones or weights on the board. Keep the leaves in the press until they are thoroughly dried. When the leaves are removed from the press they may be neatly arranged on note book pages and secured either with Scotch tape or small sections of gummed labels. The name of the leaf and any other interesting material can be recorded on the note book page.

3 Making smoke prints of leaves

Smoke prints of leaves may be easily made by following the four steps shown in the diagrams.

Cover the side of a smooth, round bottle with a thin layer of grease or vaseline. Fill the bottle with cold water and cork it tightly. Hold the bottle over a candle flame until it is covered evenly with soot. Place a leaf, vein side up, on a layer of newspaper and roll the sooty bottle over the leaf. Remove the leaf and lay it vein side up on clean newspaper. Cover the leaf with a sheet of white paper. Next, roll over the white paper and leaf with a clean round bottle or other roller.

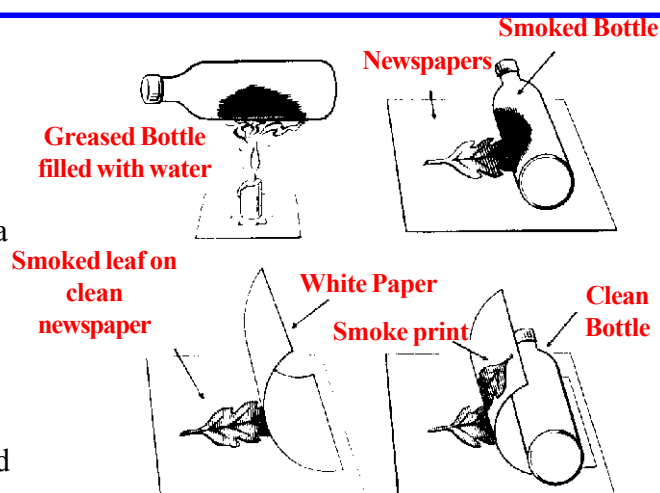

4 Making spatter prints of leaves

Place the leaf on a sheet of white paper and flatten it with pins, thumb tacks, or a few small pebbles. Dip an old tooth brush in poster colour or Indian ink. Hold the brush over the paper and spatter the material from the tooth brush evenly around the leaf by carefully drawing the blade of a knife over the bristles. Do not use too much colour or ink. When the colour has dried remove the leaf.

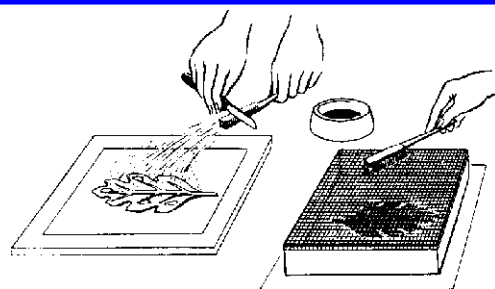

A leaf print spatter box can be made as shown above (right). A piece of window screening is placed over a shallow box or frame. The spatter is made by dipping a tooth- brush in the colour and rubbing it over the leaf and paper which are secured to the bottom of the box. Try using white colour on various coloured papers.

5 Ink prints of leaves

Place a small quantity of printer's ink on a sheet of glass or a tile. Roll the ink into a thin even layer with a rubber roller. Place a leaf, vein side up, on several layers of news- paper and run the inked roller over it once.

Carefully lift the leaf and place it, inked side down, on a sheet of white paper. After covering with a sheet of newspaper roll with a smooth, round bottle. Again remove the leaf carefully and the print is finished.

6 Leaf silhouettes

Place a leaf on a sheet of white paper and hold it securely with thumb or finger. Press a piece of natural or artificial sponge against an ink pad. With short, firm strokes, rub outward around the entire edge of the leaf as shown in the diagram.

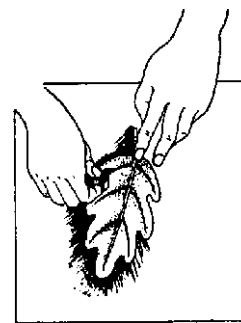

7 Carbon paper leaf prints Cover the vein side of a leaf with a very thin layer of lard or vaseline. Place the greased leaf vein side up on several layers of newspaper and cover with a sheet of carbon paper. Cover the carbon paper with another sheet of paper and rub across it several times with the side of a smooth pencil, to coat the leaf with material from the carbon paper. To make the final print place the leaf between two sheets of white paper and again rub with the pencil.

8 Studying leaf arrangements

Observe as many growing plants as possible by looking down on them from above. Draw sketches of the different patterns of leaf arrangement.

9 Growing leaves in the classroom

A sweet potato will produce dense foliage in the classroom if it is placed in water. Set the potato, root end down, in a glass or jar and keep the lower third covered with water. The potato may be kept in position by pressing three toothpicks or matches into its side and resting them on the rim of the jar.

The roots of carrots, beets and turnips contain much stored food. They will produce foliage if grown in water but will not develop into new plants. Remove the old leaves from the top and then cut off all the root except 5 to 8 cm. Place this portion in a shallow dish of water. A few pebbles placed in the dish will hold it upright.

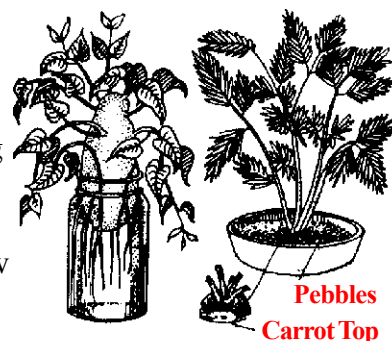

Cut off a pineapple 3 to 5 cm below the base of the leaves, and set this portion in a shallow dish of water. The leaves will continue to grow for several weeks.

10 Leaves give off water vapour

Use two similar pots of soil, one with a small plant and the other without. Cover the soil in each pot with cardboard as shown in the diagram after watering. Invert glass jars over each pot as shown. Place the pots side by side in the sun and examine from time to time during the day.

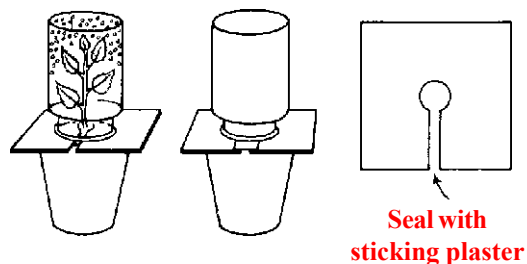

11 The structure of leaves

Borrow a microscope from another school, a doctor, or a hospital. Examine the under- side of leaves and locate the breathing pores or stomata with the two little guard cells on either side.

Cut a very thin cross section of a leaf with a razor blade and look at the edge through the microscope. Locate the palisade layer, the epidermis and the spongy layer. You may be able to see a vein and a stomata opening into the spongy layer.

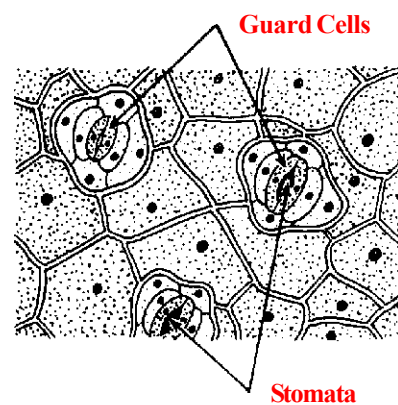

12 Green leaves make food for plants

Heat some alcohol in a jar over boiling water until it boils. Break several green leaves from a geranium or other plant which has been in the sun for several hours, and place them in the boiling alcohol until the chlorophyll has been removed. Quickly remove the leaves from the alcohol and put them in a basin of hot water. Remove a leaf from the water and spread it out on a piece of glass or tile. Cover the leaf with tincture of iodine and leave for several minutes. The deep blue colour is the test for starch which has been made by the leaf in the sunlight.

13 Green leaves give off oxygen in sunlight

Place some water weed under a funnel in a beaker of water. Invert a test tube full of water over the tube of the funnel.

Leave the apparatus in strong sunlight. Bubbles of gas will be liberated from the weed and rise to the top of the test tube. In a short time the tube can be removed and the gas tested with a glowing splint.

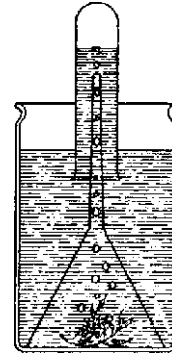

14 Air can enter a plant through the leaf

Procure a leaf with a long stalk to it and seal it into a hole through a cork. Fit this with a side tube, and seal the cork into a flask containing water. Suck air from the side tube. Air bubbles will be seen to issue from the end of the stalk.

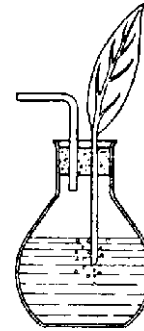

15 To show the respiration of a plant

Place the plant in a test tube held in a weighted wooden block. Put this in a bowl containing lime water and cover the plant with a jar. Keep the plant in a dark place for several hours, or examine next day.

The lime water will be milky showing that CO_2 was given off, and the rise in the level shows that a considerable amount of oxygen was taken in.

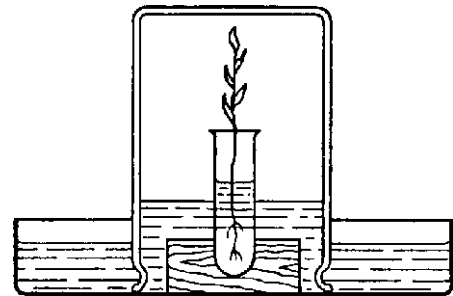

D. FLOWERS

1 Collecting and preserving flowers

Use the same method as described for leaves later..

2 Studying the main parts of a flower

Examine specimens of large simple flowers such as tulips or lilies. Count the stamens and observe how they are arranged about the central pistil. Make large diagrams of the essential organs. Label the parts of the pistil (stigma, style and ovary). Label the parts of the stamen (filament and anther).

The end of the stalk on which the flower grows is called the receptacle. At the base of the receptacle there are usually leaf-like structures that enclose the bud. These are called sepals. Above the sepals there is usually a ring of brightly coloured petals called the corolla.

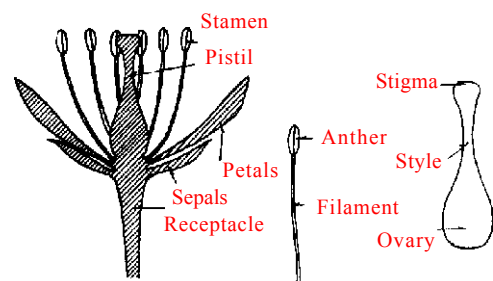

3 Dissecting simple flowers

Label each of five cards or pieces of paper with one of the following words: stamens, pistil, petals, sepals, receptacle. Dissect a flower carefully and place the parts neatly on the appropriate cards.

Some flowers can be pulled apart quite easily but a knife or scissors may be needed for others. If a sufficient number of flowers are available this exercise is most valuable as an individual pupil activity. Simple flowers with a single row of petals should be selected.

Pick up one of the stamens and rub the anther lightly across a piece of black paper. Traces of pollen will usually be seen.

Cut the ovary crosswise with a sharp knife and count the ovules or 'seed pockets'. Look for traces of seeds in the ovules.

4 Observing pollen grains from different flowers

Secure several flowers in which the pollen has formed on the stamens. Shake pollen from each flower on different pieces of black or dark paper. Observe each type of pollen with a magnifying glass and note any differences.

5 Germinating pollen grains

Make a strong sugar solution and place it in a shallow dish like a saucer. Shake pollen from several kinds of flowers onto the surface of the sugar solution. Cover with a sheet of glass and let it stand in a warm place for several hours. If the experiment is successful you will be able to see little tubes growing from the pollen grains. Use a hand lens.

6 Making a model of a simple flower

Using modelling clay, coloured paper and toothpicks make three-dimensional models representing the parts of a typical flower. This exercise is most valuable as an individual pupil activity and should fix firmly in mind the parts of a flower.

To make the flower-stalk roll a piece of modelling clay into the form of a cylinder 2 cm in diameter and about 5 cm long. Press one end firmly against a desk or table and push half a toothpick into the centre of the opposite end as shown in the diagram at n.

To make the sepals, cut a six-pointed star from green paper. Cut a hole in the centre at least 1 cm in diameter. Place the sepals in position on the stalk as shown at b.

From brightly-coloured paper, cut a corolla of petals. Cut a hole in the centre and set the corolla directly over the sepals as shown at c.

From modelling clay shape a pistil in the form of a small urn. Press this over the projecting toothpick to hold it in place, as shown at c.

Next, make stamens by putting bits of modelling clay on the ends of toothpicks. Push the toothpicks into the exposed circle of clay at the base of the pistil as shown at e.

When the flower model is finished, it can be made to look more realistic by stretching out the stalk with the fingers and bending over the flower head slightly.

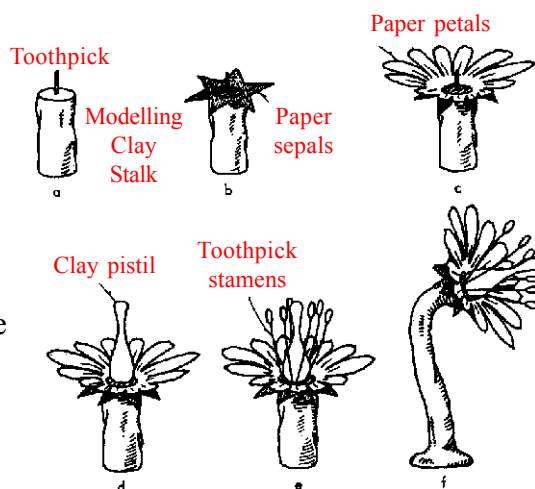

7 A field trip to observe flowers Plan a field trip to observe flowers in bloom. If no interesting wildflowers can be found growing near the school, the trip can be planned to a private garden or park. Collect some flowers.

8 Observing the development of flowers into fruit

Collect specimens of flowers in different stages of maturity from newly opened buds to specimens in which the petals have fallen. Cut each ovary open and note the changes that take place during seed development.

Look over a quart of freshly picked peas or string beans and pick out the pods that are not completely filled. Open these and compare them with fully filled specimens. The abortive seeds are the remains of ovules that were not fertilized by pollen.

E. SEEDS

1 A useful way to grow seeds

Tie a piece of cloth over the mouth of an old potted meat jar. Allow extra cloth to hang down the sides and dip in about 2 cm of water contained in a jam jar. A sheet of glass placed over the top of the jar will keep the air moist. The seeds are placed on the cloth.

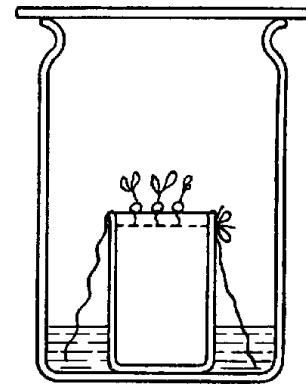

2 A 'rag doll' seed tester

Fold a square metre of muslin twice in the same direction. Near one end mark out eight or ten squares about 5 cm by 5 cm with a pencil. Number the squares and place ten seeds from each packet on each square. Fold the opposite end of the muslin over the seeds. Roll up the tester and tie it loosely with string. Saturate the tester with water. Keep it moist and in a warm place for several days. Then unroll it and see how many

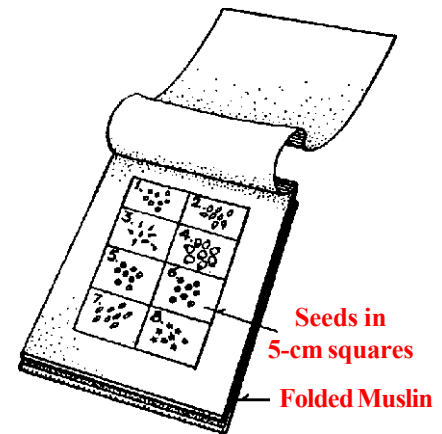

3 A tumbler garden

Grow various kinds of seeds in 'tumbler gardens'. Each pupil might grow a tumbler garden of his own and keep a day by day pictorial record of the development of the seedlings.

To make a tumbler garden cut a rectangular piece of blotter and slip it inside a drinking glass. Fill the centre of the glass with peat moss, cotton, excelsior, sawdust or some similar material. Push a few seeds between the outside of the glass and the blotter. Keep a little water in the bottom of the glass.

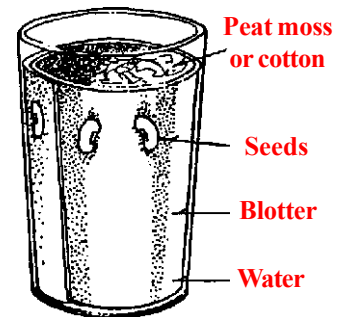

4 To study the conditions essential for the germination of seeds

In the diagram below a contains seeds on cotton wool with air, warmth, but no water; b has water, warmth, but no air, because a layer of boiled oil has been poured on top of the water; c has moistened cotton wool and air but is kept cool by having the test tube immersed in a freezing mixture. Folded muslin

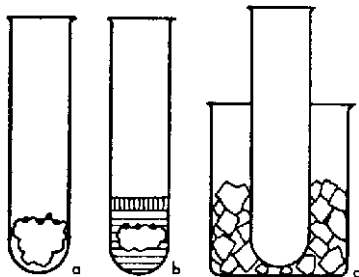

5 To show that growing seeds take in oxygen

Cork up one end of a tube, having first placed inside some damp cotton wool and some mustard seeds. Immerse the open end in dilute caustic soda solution and leave for a few days. The solution will rise up the limb. Removing the cork, and testing with a glowing splint that shows little or no oxygen remains.

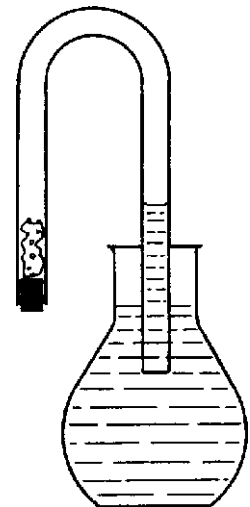

6 To study the structure of a seed

Soak seeds of bean, pea, pumpkin, sunflower, corn and other large forms. Remove the seed-coats and carefully cut the seeds open. Discover the parts that make up the seed. There is little point in teaching the botanical names of these parts though pupils may enjoy learning them. It is of more importance that pupils learn to recognize the part of a seed that is the young plant and the part that is stored food.

7 To test the gas given off when seeds germinate

Place some mustard seeds in a flask with some damp cotton wool, in the apparatus shown in the diagram, and allow them to germinate for a few days. Remove the cork carefully and pour water down the thistle funnel. Open the clip, and allow the displaced air to bubble through lime water. This becomes cloudy, showing the presence of carbon dioxide.

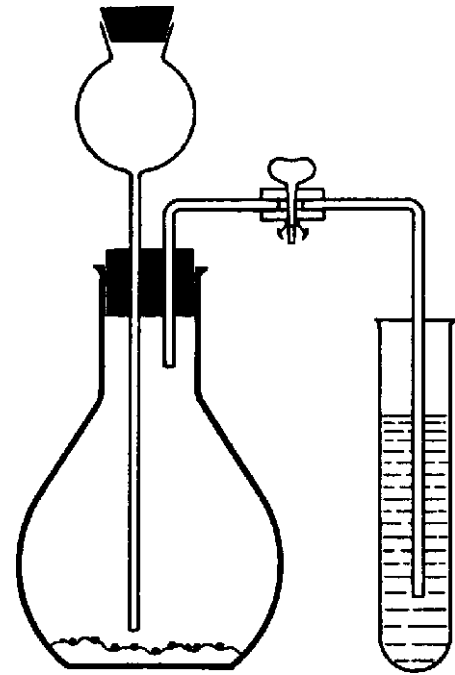

8 To show the direction of sprout growth in seeds

Soak pumpkin or other large seeds overnight and fasten three of them on needles as shown in the diagram. Fasten one with the tip pointing upward, one with the tip toward the side and the third with the tip pointing downward. Keep them in moist air and note the directions in which the sprouts grow.

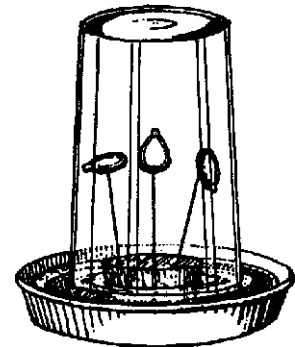

F. BACTERIA

1 Getting ready to grow bacteria

Secure two or three dozen shallow glass dishes. The glass coasters used to keep bed castors from marring floors will do. Cut 5 cm squares of window glass to make covers for the coaster dishes. These will serve very well for bacteria gardens. For beginning experiments slices of potato, carrot, or sweet potato will serve as soil upon which to grow the bacteria. Cut slices of these foods about 6 or 8 mm thick and large enough to fit easily into the dish.

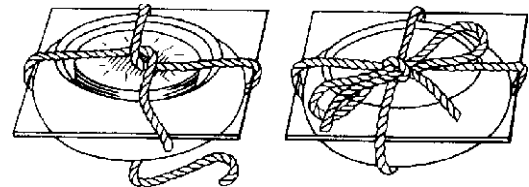

In preparing gardens for bacteria care must be taken to keep everything clean. Wash the food slices thoroughly, wash and dry the dishes and their covers. Place dishes and covers on clean white paper. Be sure your hands are very clean. When all is ready lift the food slices into the dishes with toothpicks or wood splints. Tie the covers on as shown in the diagram. Place the dishes in a large pan and then bake them in an oven at about 110° to 120° C. for an hour. This should kill the bacteria inside the gardens.

2 Planting bacteria gardens

When the bacteria gardens have cooled place them out on the table but do not raise the glass covers until you are ready to plant them. Toothpicks or small wood splints make good garden tools for planting bacteria gardens. Place 30 or 40 toothpicks in a covered can and bake them in an oven for an hour. This will kill most of the bacteria. When you remove one from the can use tweezers and only touch one toothpick.

Secure bacteria from as many sources as possible. The following will be suggested: (a) a piece of decaying or rotten fruit; (b) a decayed tooth; (c) dirty money; (d) dirt from under finger nails.

Touch the toothpick to the source of bacteria and then quickly raise the cover of a sterile garden. Rub the end of the toothpick over the potato slice and then replace the cover. Be sure to raise the cover as little as possible when planting the garden to keep out bacteria and moulds that are in the air. Tie the covers on tightly again and set the dishes away in a dark, warm place for a few days. When they are examined the bacteria will show as spots on the potato slice. Each spot is a colony of thousands of bacteria.

3 Another type of soil for bacteria gardens

Boil some rice or potatoes in a dish until well cooked. Drain and save the water. Use the bouillon cube to the gelatin. Use the same type of dish and cover as was used above. Pour sufficient of the hot gelatin mixture into each dish to cover the bottom to a depth of 3 or 4 mm. Quickly replace the covers and let the dishes stand until the gelatin has hardened. Tie the covers on and sterilize in an oven. Allow the dishes to cool and the gelatin to reharden before removing from the oven. These bacteria gardens are planted and grown in the same way as the ones described above.

4 Making a transfer needle A transfer needle which can be sterilized by heating in a flame is useful in working with bacteria. Secure a piece of soft wood about the size of a pencil for a handle. Push the sharp end of the needle well into the wood and use the eye end for contact with bacteria sources.

5 To study whether bacteria grow best where it is moist or dry

Use two sterile dishes. Inoculate each one by touching a sterile transfer needle to a bacteria colony growing in another dish. Smear the material on the needle across the gelatin in each of the two dishes. Quickly replace the covers. Label one dish dry and the other moist. Dry the first dish by placing it on a radiator but covered with a box. Place the one marked 'moist' in a dark warm place but where it will not dry out. Examine the two dishes for several days.

6 To study if bacteria grow better where it is warm or cold

Again inoculate two sterile dishes. Label one 'warm' and the other 'cold'. Place the first dish in a dark warm place and the second in a dark cool place. Examine the dishes each day for several days.

7 To study if bacteria grow better where it is dark or light

Inoculate two sterile dishes as before. Label one 'dark' and the other 'light'. Place the first dish in a dark warm place and the second in bright sunlight or where an electric bulb can shine on it all the time. Examine the dishes daily for a period of several days.

8 Where may bacteria be found?

Expose sterile bacteria dishes to as many of the following conditions as you can. Label the dishes and set them away in a warm, dark place for a few days after which they should be examined.

1 Clean hands and dirty hands.

2 A dish cloth.

3 A garbage can.

4 Coughing.

5 Sneezing.

6 The bottom of your shoes.

7 A clean dinner plate.

8 A fly.

9 A cockroach.

10 Fur from a dog.

11 The air of the school room.

12 Souring milk.

13 A pencil point.

14 The air in a dirty street.

15 Stagnant water.

16 A rug or carpet.

9 Does sunlight kill bacteria?

Inoculate two sterile bacteria dishes from a dish where bacteria are growing. Place one dish in the open sunlight and the other in a warm dark place. After one dish has been in the sunlight for several hours place it in the dark warm place with the other dish. Examine the dishes each day for several days.

10 Do disinfectants kill bacteria?

Secure several types of commercial and household disinfectants. Inoculate as many culture dishes as you have samples of disinfectant and one dish in addition for a control. Rinse the soil in each inoculated dish with a different disinfectant. Pour off the excess. Label each dish. Replace the covers and set all the dishes including the control dish in a warm dark place and examine after a few days.

11 Observing where soil bacteria live

Dig up a clover, alfalfa or soy-bean plant. Carefully rinse all the soil from the roots and see if you can find the little white nodules on the roots. These are where the nitrogen fixing bacteria so important to soil fertility are found.

G. MOULDS

1 To secure different types of mould

- (a) Secure an orange which has green mould on it and keep in a jar in a dark warm place.
 - (b) Place a piece of moist bread in a jar and expose it to the air. Leave for a few days in a dark warm place.
 - (c) Secure a piece of blue or Roquefort cheese in which there is mould. Place in a jar and keep in a dark warm place.
 - (d) Place a few dead flies in some stagnant water. In a few days they will become surrounded with a whitish growth of mould.
-

2 How to culture mould plants

Use either sterile dishes with potato slices or gelatin as those prepared for the experiments on bacteria. Transfer mould from each of the sources in Experiment 1 above to a sterile culture dish. Set the four dishes aside in a dark warm place. In a few days you should have pure cultures of each of the four types of moulds you have grown.

3 The structure of moulds

When the four pure cultures of mould have reached a vigorous state of growth examine each one with a hand lens. See if you can see stalks with tiny black knobs on them. These are the spore cases. Thousands of spores are produced in each spore case which bursts when ripe. A new mould plant can develop from every spore if the conditions are right.

4 Do moulds need water for growth?

Place a spoonful of dry cereal such as rice or oatmeal in a sterile culture dish. Place a like amount of the same cereal cooked in another culture dish. Using a sterile transfer needle inoculate each sample with mould from a growing culture. Cover the dishes and label them. Set the dishes aside in a dark, warm place and observe each one after a few days.

5 Do moulds grow better where it is warm or cold?

Repeat Experiment 4. This time put one culture dish in a warm dark place and the other in a cold dark place. Examine the dishes after a few days.

6 Do moulds grow better where it is dark or light?

Repeat Experiment 4 above. This time leave one culture dish in a warm place where it receives light all the time. Place the other dish in a warm dark place. Examine the dishes after a few days.

H. YEAST

1 To show the effects of yeast on dough

Mix together some sugar, water and flour in the proportions to make a good bread dough. Divide the dough into two equal parts. Stir a half yeast cake in some water and mix this with one of the samples of dough. Put each sample of dough in a dish which has a label and set aside in a warm place. Observe after a few hours.

2 To test the effects of temperature on the activity of yeast

Make up a quantity of bread dough as in Experiment 1 above. Stir a yeast cake in water and thoroughly mix the yeast with the dough. Separate the dough into three equal parts and put in pans or jars. Label samples 1, 2, and 3. Place sample 1 in a refrigerator, sample 2 in a warm place, and, sample 3 in a hot place. After a few hours examine each sample.

3 To show that yeast acts on sugar

Make a sugar solution in a jar either with brown or white sugar, molasses or honey. Thoroughly crumble a quarter of a yeast cake into a test tube of the sugar solution. Crumble another quarter yeast cake into a test tube containing the same amount of ordinary tap water. Keep both tubes warm. Observe the tubes from time to time and note any differences in them.

4 To study the gas produced when yeast acts on sugar

Place some clear lime water in a test tube and have a pupil exhale through a soda straw placed in the lime-water. Soon the lime-water will become milky which is a test for carbon dioxide gas. Next place some yeast in a solution of sugar water in a test tube. Fit a one-hole stopper to the tube and put a glass tube through the hole. Connect a rubber tube and another glass tube about 15 cm long to the stopper. Place the long glass tube in a solution of clear lime water. Let the tubes stand in a warm place for a while. Observe the lime water.

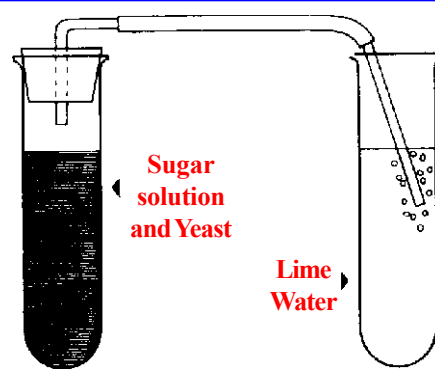

5 To observe yeast plants

Borrow a microscope from a college, a high school, a doctor or a hospital. Place a few drops of the sugar solution which contains yeast on a glass slide and observe it under the microscope. You will see many little oval-shaped cells each of which is a yeast plant. Perhaps you can see some that are carrying buds on them. This is the way that yeast plants reproduce.



I. GROWING PLANTS WITHOUT SOIL

Some children may be interested in growing plants indoors without soil. This can be done but requires special materials and chemicals.

J. SIMPLE GARDENING

Many children are interested in making home or school gardens. Each child should be encouraged to select and clear a small garden plot. After the ground has been spaded and prepared it should be marked off in rows. Such small vegetables as lettuce and radishes may be planted in alternate rows. Each pupil should draw a plan of his garden and mark on it where he has planted various things.

Plants may be started either at home or at school for later transplanting. For this wooden boxes about 10 cm deep will be needed. The boxes are filled to a depth of about 8 cm with good soil. Such seeds as tomato, cabbage, cauliflower and sweet peppers may be started indoors. By the time the lettuce and radish plants have matured, the plants grown indoors will be ready for transplanting into the outdoor garden.

Gardening activities will lead to many worth-while lessons on the growth and care of plants. Later in the year an exhibit of vegetables grown may be planned.

**“BE A GOOD SCIENTIST. FOLLOW INSTRUCTIONS EXTREMELY CAREFULLY.
WEAR PROTECTIVE CLOTHING WHEN WORKING ON ANY EXPERIMENTS
THAT INVOLVE FIRE OR EXPLOSIONS.”**

CHAPTER IV

Methods and materials for animal study

1 An insect collecting net

A useful insect net can be made from a round stick such as a broom or mop handle, some heavy wire and mosquito netting or cheese cloth. Bend a heavy piece of wire into a circle about 38 to 45 cm in diameter and twist the ends together to form a straight section at least 15 cm in length. Fasten this to the end of a broom or mop handle by lashing with a wire wrap or by means of staples. Cut a piece of mosquito netting or cheese cloth to form a net about 75 cm deep. Fasten this to the circular wire frame by stitching.

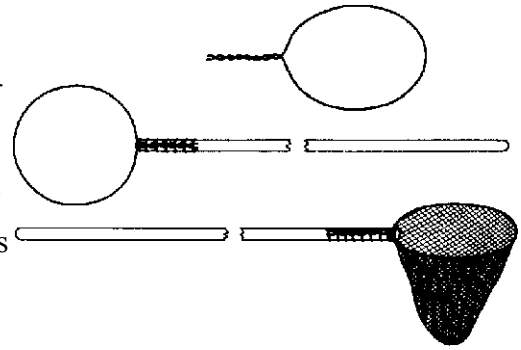

2 Insect killing jar

Secure a wide-mouth glass jar with a screw top or one which closes very tightly. Place a wad of cotton in the bottom and cover it with a round piece of cardboard or blotting paper which has several holes punched through it. When the jar is used saturate the cotton with carbon tetra-chloride (Carbena) or some available insecticide containing DDT. Place the piece of cardboard over the cotton and then put the insect in the jar. Close the jar tightly and leave until the insect has been killed. If moths or butterflies are being prepared be certain that the jar opening is large enough to prevent the tearing of the wings.

3 A stretching board for insects

A stretching board is essential when insects are being prepared for mounting. One can readily be made from a cigar box. Remove the cover from the cigar box and split it

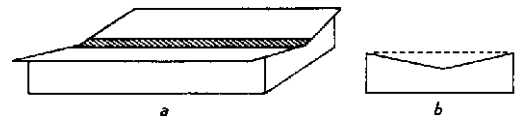

lengthwise into two equal parts. Attach these to the box again leaving a space about 1 cm wide between them. The body of the insect is placed in the slot and the wings are secured on the top by means of strips of paper held by pins into the soft wood but not through the wings. Sometimes a slight angle is desirable to the top pieces. This can be achieved by cutting the ends of the cigar box to a slight V form before attaching the sections cut from the cover. This is shown in diagram **b** above.

4 Mounting boxes for insect collections Wood or cardboard cigar boxes make very useful and convenient housings for insect collections. After the insect has been removed from the stretching board a pin is placed through the body and is then stuck into the bottom of the box to hold the insect. The pins are arranged in an orderly fashion and may carry, near the top end of the pin, a small card upon which data about the insect are entered.

Cigar boxes may also be used to mount insects on cotton background. The cover is removed and the inside of the box filled with layers of cotton fluff. Next the insects are arranged on the fluff and then covered with glass or cellophane which is taped to the box making a permanent mounting. This type of mounting box is especially suitable for butterflies and moths or for displays in a school museum.

5 Cages for keeping animals in the science room

It is frequently desirable in elementary and general science to keep animals caged in the science room for short periods of observation. To carry out such activities effectively, suitable cages must be provided. These can be made from a variety of materials found in almost every locality.

One such cage is made from a wood box provided with a hinged cover and having a window covered by wire screening. Windows are also cut in three sides of the box. The side and back windows are covered with wire screen and a glass plate is fitted in the front window. This type of cage can be improved by a drawer which is fitted under the front glass window and which covers the entire bottom of the cage. This enables the cleaning of the cage without disturbing the animals to any great extent.

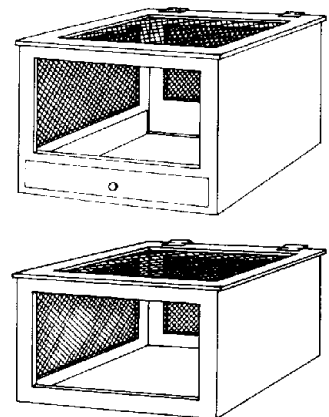

In tropical areas very useful cages can be made using bamboo splints or other wood in place of wire screening.

Providing food and water for caged animals is often a problem. Generally food and water containers should be kept up away from the floor of the cage. A convenient feeding trough for small animals may be made by cutting a section from an ordinary tin can and then attaching this to the side of the cage by means of wires as shown in the diagram. A watering device for such animals as mice, guinea pigs and hamsters can be made from a preserving jar inverted in a heavy dish or soup plate.

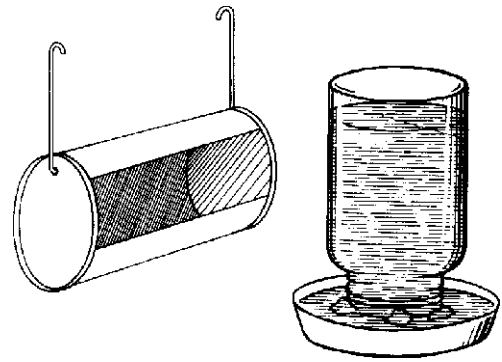

Regular feeding and watering of animals and regular cleaning of the cages are important, not only for the health and comfort of the animals but also for disciplined habits and a sense of responsibility in the pupils. Food and water must be changed daily and cages must be cleaned once a week.

6 A home-made wormery

A wooden box 30 cm by 30 cm by 15 cm fitted with a glass front is useful for studying the habits of earth-worms.

Fill the box nearly to the top with layers of (a) sand; (b) leaf mould; and (c) loam, padding down each layer before adding the next.

Place lettuce leaves, dead leaves, carrot, etc. on the surface soil, together with some worms.

Keep the contents damp and study the behaviour of the worms.

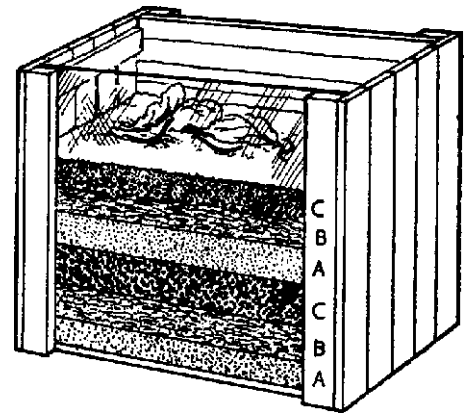

7 Studying life histories of insects

Cut large rectangular holes in the sides of a large cardboard container and cover them with muslin folded over at the edges and gummed or pasted into place. Make a large door by cutting along three sides of a rectangle and bending along the fourth side. Stick a tab of folded paper or cardboard to the front edge of the door to act as a handle. Leave the original bottom of the box intact, to give rigidity. (If cellophane is available a window can be made in the door or in one side of the box.) Put a loose piece of paper on the floor and stems and leaves of food plants. This is better than pots of water in which the insects may drown.

This cage is suitable for all stages of the life-histories of butterflies, and for moths if larger pots of soil are added, for pupation. The insects can be handled by means of a brush or small stick.

8 Providing for grasshoppers and stick insects

You can keep such insects in an inverted jam jar. They should be provided with a little foliage, which can be stood in a potted meat jar. To give the insect more room, and save it from drowning, the jar can rest on an inverted shoe box with the leaves projecting through what is now the top. Holes should be pierced in the shoe box to ensure a sufficient supply of fresh air.

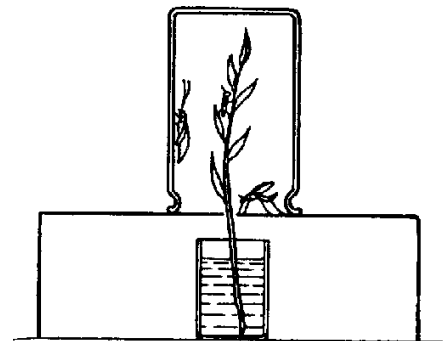

9 A jam jar vivarium for flies

A jam jar can be used to hold a blow fly for studying its life and habits. After the eggs have been laid on a piece of refuse, transfer the fly to another jar and place the eggs in a warm place in the sun or on a radiator. After a week has passed they will hatch out into gentles. In another week's time they will have become chrysalides. A little damp earth or moss introduced now will prevent them from drying up and the complete life cycle can be followed in a few weeks. Later, problems can be investigated. Do they sleep? How do they eat? What are the differences between male and female?

10 Observing spiders

Make use of the fact that many spiders cannot travel over water or a polished surface. Stand of cardboard together, tie them into some sort of polygonal shape and lean this structure against the plant. Put an orb spinner on the plant and it will make a web.

If a few shelves can be removed from a cupboard a large spider such as *Epeira diademata* (female) can be persuaded to spin a web in it. Put some plants in pots in the cupboards with the spider, and close the door. After a few hours open the door. This will probably break the web, but if the door is now left open the spider will show no desire to escape but will spin another web. If enough insects are not caught, give her daddy-long-legs, caterpillars, moths or flies.

The process of web spinning may be watched, and dated and timed observations made on feeding and other habits.

A 'cobweb spider' can be kept in a large jam jar. A gauze over the top serves to keep in a fly which can be introduced occasionally. Eggs which are laid can be easily observed, as well as the interesting feeding habits.

11 Caring for frogs and toads

Frogs and toads may be kept in an old bird cage. hit in plants and soil, and an empty dish or two for water. Then put a bottle of water through the small door of the cage and fill the dish from it. Feed the frogs and toads on small earth-worms and flies.

Accurate observations can be made on respiratory mechanisms and rates, and on feeding habits. By shading the cage, changes in skin pigmentation can be observed.

Both frogs and toads need continuous shade and must not be kept in bright sunlight. Frogs must have sufficient water in the cage to enable them to swim, but when desired they can be transferred temporarily to a large tank to enable their swimming habits to be observed.

Tadpoles can be kept in glass jars but when nearing metamorphosis should be transferred to a shallow dish with a pile of stones in the middle. The small frogs are not easy to keep and it is better to let them go and keep older frogs as above.

(Galvanized vessels are nor suitable for amphibia.)

12 Caring for rats

Black and white rats may be kept in old galvanized baths with strong wire-netting covers. The young rats will climb through the wire netting and use the top of it as a play- several inches and there is no other support. Put clean sand in the bath to a depth of at least 3 cm. This must be changed daily. It can be washed thoroughly in running water, air- dried and used again. Give the rats clean rags for nesting purposes. These should be boiled or discarded. Alternatively torn up newspaper may be used and renewed when the cage is cleaned every week.

Although rats will eat almost anything, they need a balanced diet. In addition to wheat (or bread) and or crushed oats they need seeds such as lentils and linseed (or mixed parrot seed), milk or milk powder (except for nursing mothers and young rats which do better on liquid milk). They must also have greenstuff and fruit or fresh vegetables daily, a little salt, and vitamin supplement which may be in the form of seedlings of sunflower, peas, beans or wheat. A little meat twice a week is desirable.

One pair of rats will be enough to begin with, as they breed rapidly.

If well fed and sympathetically handled, they will become quite tame, and will not bite unless they are frightened. They should always be handled by the same people.

Do not attempt to lift a rat by the tail: to pick him up with one hand, lay the palm of the hand across his back and put the thumb and forefinger under his chin, supporting with the other three fingers. Alternatively and preferably cup the two hands round his body.

Observations can be made on habits and breeding. Records of growth can also be kept. Keep a special box in which to weigh the rats. A cardboard box with a deep lid is suitable. Make a number of small holes in the top for aeration. Put a few *Helianthus* seeds into the box, and when a rat enters put the lid on. Then weigh rat and box together and subtract the weight of the box. Simple experiments on diet can be done where weight can be used as a criterion. They should be weighed regularly; say, once a week.

Simple Mendelian experiments could be carried out with rats. When a rat has to be killed for dissection this should preferably be done by enclosing it in a box or lethal chamber and passing cause pain by touching the animal, and there should be sufficient air to prevent suffocation.



Alternatively wrap the rat in a duster including both front legs, hold the head down and strike very hard behind the ears with a hammer or stout stick.

Drowning takes a long time and should not be used if it can be avoided. If it must be used, completely submerge a cage containing the rat and weigh it down.

No animal should be reckoned to be dead until stiffness (rigor mortis) has clearly supervened. Otherwise an animal which seems to be dead may later recover consciousness.

13 Making an observation nest for ants

An observation nest for the study of the life story of ants can easily be made as follows.

Make a wooden U from three 30 cm lengths of wood 1.5 cm square. Mount this vertically in a convenient wooden base. Now cut rectangles of glass 30 cm x 33 cm and clamp them on each side of the U with rubber bands or some sort of metal clip.

Make a well-fitting wooden lid to fit the top as shown in the diagram. Drill a 0.5 cm hole about 5 cm from the top of one of the sides and plug it with cotton wool.

The first thing to do in setting up the nest is to fill the space between the glass with soil. This should be taken from the field from which you get the ants themselves.

Pour sandy soil in the top and pat it down occasionally with a ruler until it is about level with the plugged hole.

Now for the ants; small black or red ants are the best for this purpose. They prepare their colonies under flat stones nearly everywhere.

Raise the flat stone and you will see the ants scurrying away. You will need two narrow necked medicine bottles with cotton wool stoppers, a gardening trowel, and a white sheet or large piece of paper.

Lay one of the bottles on the ground and guide the ants to the mouth until you have collected about a hundred: then close the neck with the plug of cotton wool.

Next you must find a queen. To do this dig rather deeply with the trowel and put the earth on the white sheet laid flat on the ground. As you break up the earth with the fingers you will notice one ant much larger than the rest. This is the queen which must be guided to the second bottle: some patience is required here.

To get the ants into an observation nest, an island from which the ants cannot escape. Place the observation nest on the plate and release the ants either on the plate or straight into the top of the formicarium: once the queen is inside the others will follow through the doorway.

As ants don't like daylight, plug up the hole, fit a brown paper envelope over the case and remove the nest to its permanent home.

A little honey smeared on the glass just inside the door will provide plenty of food, and an occasional sprinkle of water with a fountain pen filler will keep the soil moist.

The exciting happenings inside the nest, the laying of the eggs, the grubs and the way the ants have of talking to each other by tapping each other on the head with their antennae, can all be studied in artificial light which does not disturb them, and as the tunnels must run parallel to the glass these things are all quite easily seen.

Experiments such as the removal and sub-sequent return of a few ants; the introduction of foreign ants, green flies, spiders, etc., are all most fruitful.

Once the nest is settled and the queen begins laying eggs the cotton wool plug from the doorway can be removed. Place the observation nest near a slightly open window and the ants will come and go freely for a whole year.

14 Making a jam jar aquarium

If a large glass tank is not available, practically any glass vessel can be used as a simple aquarium if it is well stocked with submerged water plants such as Elodea or Myriophyllum, to aerate the water. A 1 kg jam jar is quite suitable for keeping caddis larvae, pond snails, small crustacea and plants such as Elodea and Lemna minor, and will keep in properly balanced condition for months if carefully stocked. It is as bad to understock as it is to overstock. The aquarium should require no attention, but if a Dytiscus or other predaceous larva is kept it should be fed regularly on tadpoles. Three centimetres of clean sand will provide hibernating quarters for the caddises at the bottom of the jar, and a muslin cover will ensure that the caddis flies do not escape unobserved.

A diary should be kept, to record egg laying and other changes, as well as habits.

Such an aquarium can be made the basis for a simple study of the interrelationship between plants and animals in pond life.

For collecting pond and stream specimens a strong net can be made from a soup strainer if one is available. Its handle should be firmly bound to a stick, the tape being threaded through the handle repeatedly. The tape must be liberally smeared with rubber solution if available, and then tied tightly and the knot smeared too.

15 An aquarium for larger water animals

A glass aquarium 50 cm by 25 cm is of useful size. Old accumulator cells are suitable, but the glass is not very clear.

To prepare such an aquarium procure some fine silt from the bottom of a clear stream or pond and wash it carefully in running water. Cover the floor of the aquarium with it to a depth of about 2 cm. Plant a few reeds in this, weighting the roots with a stone or lead ring. Then put in a layer of coarse sand or gravel and some large stones to serve as hiding places for the water insects. Fill with a slow stream of water and allow to stand for a day or two until clear. Clean water plants should be introduced. There is no need for elaborate aerating arrangements if plenty of water weeds are present. If tap water is used some live food such as daphnia should preferably be added.

The animals can now be introduced with a few snails to keep the grass clean. Very little feeding will be necessary. Fish will eat the snails' eggs and enough small water organisms can be found in the average pond to supply other needs. If worms are used as food they should only be given once a week cut in pieces small enough to be eaten. Any unconsumed food should be removed immediately or fungi will grow and will infect the fish.

The aquarium must be covered with a glass plate or perforated zinc lid to keep out dust. If frogs or newts are kept, a floating piece of cork must be provided for them to sit on; the glass or zinc cover will then prevent their escape.

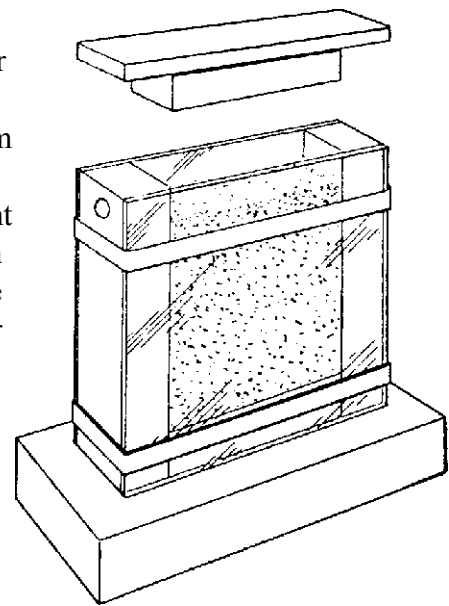

16 Observing the life cycle of fruit flies

Small glass jars make excellent habitats for fruit flies. Place a bit of ripe fruit in the bottom of the jar and make a paper funnel with a hole in the end to fit the mouth of the bottle. Place the bottle in the open; and when six or eight fruit flies have entered, remove the funnel and plug loosely with cotton wool. With this number of flies there should be both males and females. The females are larger with a broader abdomen. The males are smaller and have a black-tipped abdomen.



Soon eggs will be deposited, and in two or three days the larvae will hatch. A piece of paper may be placed in the jar for the larvae to crawl on when they are ready to pupate. The adult insects will come from the pupae. By adding newly hatched flies to another jar a new generation can be started.

17 The incubation of chicken eggs

If electricity is available in your classroom a simple incubator can be made at a very low cost. Secure two cardboard boxes, one large and one small. Cut one end from the small box, and cut a 15 cm square window in a side of a large box. Next cut a slit in the top of the smaller box and suspend an electric lamp in it. There should be a long electric cord attached to the lamp.

Place the small box inside the larger one and pack crumpled newspaper between them on all sides. Be sure the open end of the small box fits against the side of the large box in which the window was cut. Place a thermometer in the box so that you can read it through the window. A glass plate is fitted over the window.

Now you are ready to begin to experiment. It is necessary to have a constant temperature of 103° E (40° C) night and day for 21 days. By using different bulbs and by changing the amount of newspaper you will be able after a few days to regulate your incubator to this temperature. A small dish of water should be placed in the incubator.

Now secure a dozen fertile eggs. Place the eggs in the incubator and leave them. At the end of three days remove one of the eggs and carefully crack it. Dump the contents into a shallow saucer. A three-day embryo will usually show the heart already beating. It may continue to beat for half an hour. Remove an egg every three days and observe the development of the embryo. Some of the eggs can be left for the full 21 days to see if any of them will hatch.

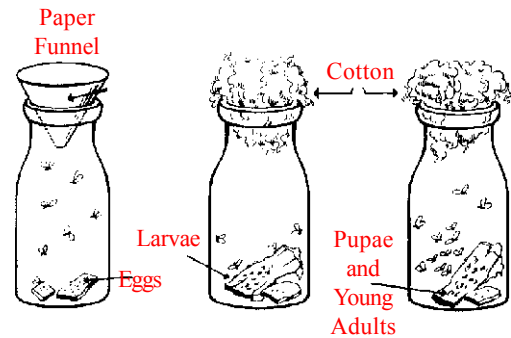

18 Snakes

Non-poisonous snakes can be brought into the classroom for observation. The diagram shows how a safe cage can be made for keeping a snake. The bottom should be covered with sand and gravel. A shallow pan of water should be placed in the cage. Some stones and a forked branch are also desirable. If snakes are kept in a glass tank, this must be protected from strong sunlight

When a snake is observed outside it should be approached very quietly. If a snake is to be handled hold it securely just behind the head with one hand. Do not hold it too tightly. Support the rest of the body with the other hand. Snakes may be fed on earthworms, many kinds of insects, eggs or small bits of meat. A snake usually will not feed every day. Some will not eat at all in captivity. Often snakes do not eat for several weeks. If a snake does not eat it is best to let it go.

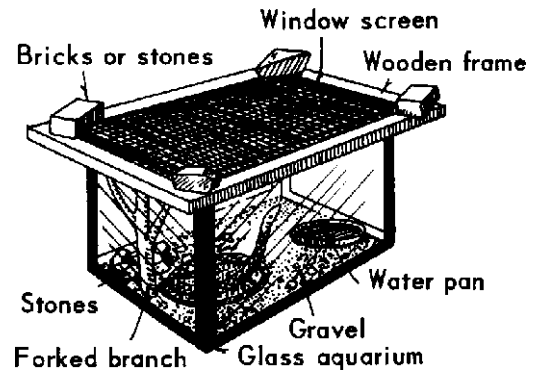

“BE A GOOD SCIENTIST. FOLLOW INSTRUCTIONS EXTREMELY CAREFULLY. WEAR PROTECTIVE CLOTHING WHEN WORKING ON ANY EXPERIMENTS THAT INVOLVE FIRE OR EXPLOSIONS.”

CHAPTER V

Experiments and materials for the study of rocks, soils, minerals and fossils

Rocks, soils, minerals and fossils are always of interest to children. Since samples are to be found in almost every environment, they can make a very important contribution to the teaching of science. The teacher should not feel it necessary to be able to name every specimen brought in by pupils; such classification and naming is the job of a trained geologist. Much can be learned about rocks and minerals without becoming involved with technical names. For additional information on rocks and minerals see Appendix C.

Some rocks are rough and gritty and appear to be composed of sand grains cemented together. Sandstone is a good name for such rocks. Another group of rocks appear to be made up of tiny flecks and crystals something like granite. These rocks may be called granite-like rocks. Other common rocks are slate, limestone and the soft, layered shale that often appears along the banks of streams. This simple vocabulary, while not technically complete, will serve very well for identifying and classifying most of the common rocks.

Rocks are generally classified into three great groups in accordance with the way in which they were formed.

1 Sedimentary rocks were formed under water from mud and silt deposited by rivers. These rocks often appear in layers. Examples are shale and limestone.

2 Igneous rocks were formed by the cooling of molten materials. Lava, quartz and mica are good examples of igneous rocks.

3 Metamorphic rocks were formed under great heat and pressure from both sedimentary and igneous rocks. Examples of this type are marble formed from limestone and slate formed from shale.

A. ROCKS AND MINERALS

1 Making a rock collection

A collection of the common rocks found in the community can be made by asking each pupil to bring in one piece of rock. Explain to the pupils that it will not be necessary to know the names of all the rocks. Similar specimens may be placed together on a table. Divide the collected rocks into groups based on differences of shape, colour and other characteristics. Try to find as many ways as possible of grouping the rocks.

2 Studying a single rock

Select a single rock and try to learn as much as possible about it from careful observation. If it is flat, it is probably a piece or layer from Sedimentary formation. Such rocks were formed by the hardening of sediments laid down millions of years ago. If the rock appears to be made of fine sand grains cemented together it is probably sandstone. If it is made up of larger pebbles cemented together, it is probably another sedimentary rock called conglomerate. If the rock appears to be rounded, it is probably the result of the stream action of water. Examine the rock with a magnifying glass. If it contains little flecks and crystals, it is a granite-like rock and was probably pushed up from deep in the earth long ago. Careful observation of several rocks in this manner will interest pupils in their further collection and study.

3. Making individual rock collections

Pupils should be encouraged to make their own collection of rocks. Small pasteboard or cigar boxes will serve to keep the collections. The specimens may be kept separate by putting partitions in the boxes. As a pupil identifies the rocks in his collection, he should cut small pieces of paper or adhesive tape and fasten one to each rock. Place a number on each and then paste a list on the cover of the box. It is a good idea to have the collections kept small. Pupils may be encouraged to fill out their collections by trading samples with other pupils.

4 A study of broken rock

Break open several rock specimens. Compare the appearance of freshly broken surfaces with the Heather-worn outside of the rock. The rocks may be safely broken by wrapping in a cloth, placing on a large rock, and striking hard with a hammer. The cloth wrapping will prevent small chips from flying off.

5 The test for limestone

You can test the rock samples to see if any are limestone by dropping lemon juice, vinegar or some other dilute acid on them. If any are limestone they will effervesce or bubble where the acid is placed on them. The bubbling is caused by carbon dioxide gas which is given off by limestone when in contact with acid. Marble, a metamorphic rock made from limestone, will also respond to this test.

6 Studying broken rocks with a magnifying glass

Study freshly broken rocks with a magnifying glass and try to find crystals of different minerals. The crystals of different minerals will differ in size, shape and colour.

7 Examining sand with a magnifying glass Examine a small amount of sand with a magnifying glass or under the low power of a microscope if there is one available. The nearly colourless crystals are those of a mineral called quartz which is the commonest mineral on earth. Crystals of other minerals can often be found in sand. See if you can find any others.

8 The meaning of 'rock' and 'mineral'

Develop the meaning of these two terms through a study of the specimens collected. A rock is usually regarded as mineral matter found in the earth in large quantities. Most rocks are mixtures of minerals although some kinds consist of a single mineral. A mineral is a substance found naturally in the earth which has a definite chemical composition and a set of specific and characteristic properties.

9 A field trip to a rock quarry

The quarry should be visited by the teacher in advance. Observe how the rock is removed. If the rock is sedimentary, observe the layers. Collect rock samples to take back to the classroom for study. Look for fossils of any plants or animals. A field trip may also be planned to an exposed rock cut or ledge and to a coal mine if there is one nearby.

10 Mounting rock and mineral samples

Samples of rocks and minerals can be mounted neatly for a collection by making a base from plaster of Paris. The white powder is mixed with water to form a thick paste. This paste is put in a tin can cover about 1 cm deep which has been lined with wax paper or greased. Before the plaster hardens the small rock or mineral sample is pressed far enough into the surface so that it is held firmly but so that it can be seen well. The name of the material can be printed on the white base and then the base can be coated with clear shellac or varnish.

B. ARTIFICIAL ROCKS

1 Cement and concrete

Secure a small bag of Portland cement. Have the pupils mix it with water and put it in tin can covers, paper cups, or small pasteboard boxes until it hardens. Study its appearance and its properties. Break a piece of cement and study it. Mix the dry cement with about twice as much sand or gravel. This will form concrete. After adding water and mixing thoroughly place it in moulds. Allow these to harden several days. Again study the appearance and the characteristics of these samples.

2 Plaster of Paris

Secure some plaster of Paris and mix a small amount with water. It must be worked rapidly or it will harden while being mixed. Place the mixture in moulds and let it set until very hard. Study the appearance and properties of the samples.

3 Collections of building materials Collect samples of all the different types of rock or mineral building materials available in your locality such as marble, granite, slate, limestone, brick, cement, plaster, etc. These may be added to your collection after proper labels have been attached to the samples.

C. ELEMENTS AND COMPOUNDS

1 A collection of elements

Obtain a table of the elements and make a collection of samples of as many as you can. You should be able to obtain samples of the following: iron, aluminium, zinc, tin, copper, lead, gold, silver, mercury, sulphur. See Appendix C.

2 A collection of common chemical compounds

Collect samples of as many common chemical compounds as you can. The following are suggestions: salt, sugar, starch, soda, copper sulphate, bleaching powder, plaster of Paris, rubber, wool, cotton, etc.

D. SOIL

1 Types of soils

Secure samples of soil from as many places as possible and place in glass jars. Try to get examples of a sandy soil, a loam soil, a clay soil, a soil rich in decayed matter or humus. Have the pupils study the samples and examine bits from each sample with a magnifying glass.

2 To show the differences in soil particles

Secure some glass jars that hold about half Gallon or two litres of water. Place several handfuls of soil in a jar. Fill the jar with water and then thoroughly shake up the soil in the water. Let the jar stand for several hours. The heaviest particles will settle out first and the lightest ones last. The layers in the jar after settling will be in the order of the weight of the soil particles. Siphon the water from the jar with a tube. Next examine a small sample from each of the layers with a magnifying glass.

3 To show that soil contains air

Place some soil in a glass jar or bottle and slowly pour water over it. Observe the air bubbles that rise through the water from the soil.

4 To show how soil is formed from rocks

Carefully heat a piece of glass in a flame and then plunge it into cold water. The sudden cooling of the glass causes it to contract unevenly, and it cracks. Heat some rocks very hot in a fire and then pour cold water on them. The rocks will often break up both when heated and when cooled. One of the stages in the formation of soil is the breaking up of rocks under differences of temperature.

5 What makes streams look muddy?

After a heavy rainfall have pupils take samples of running muddy water in glass jars. Let the water stand for several hours until the sediment has settled and may be observed by the pupils.

6 Making soil from rocks

Find some soft rocks in your locality such as shale or weathered limestone. Bring them into the classroom and have the pupils crush and grind them up into small-sized particles.

7 The effect of soil on growing things

Get samples of a fertile soil from a flower or vegetable garden, from a wood, from a place where a cellar is being dug, from a sandy place, from a clay bank, etc. Place the samples in separate flower pots or glass jars. Plant seeds in each type of soil and give each the same amount of water. Observe in which type of soil the seeds sprout first. After the plants have started to grow, observe the soil sample in which they grow best.

8 To show that soil may contain water

Place some soil in a thin glass dish and heat it cautiously over a small flame. Cover the jar and water will be observed to condense on the cool sides.

9 To study the difference in fertility between topsoil and subsoil

Secure a sample of good topsoil from a flower or truck garden. Secure another sample of soil from a depth of about 50 cm. Place the samples in separate flower pots and plant seed in each. Keep the amount of water, the temperature and the light equal on each sample. See which soil produces healthier plants.

10 To show the presence of nodules of nitrogen-fixing bacteria on the roots of legumes

Carefully spade up some leguminous plant such as clover, alfalfa, soy-beans, cow peas, etc. Remove the soil from the roots by washing with water. Observe the little white bumps or nodules on the roots. Nitrogen-fixing bacteria are inside these nodules. These bacteria remove nitrogen from the air and fix it in a form that enables plants to get it from the soil.

11 To show how water rises by capillarity

Colour some water in a shallow dish with ink and touch a blotter to the water surface. Observe how the water rises in the blotter.

Touch a lump of sugar to the water surface and observe how the water rises.

Place a lamp wick in the water and observe.

12 To show how water rises in fine tubes

Make some fine hair, or capillary tubes by heating glass tubing in a flame and drawing it out. Cut the tubes and glue them to a piece of cardboard with about 5 cm extending below the edge. Place the ends of these tubes in coloured water and observe how the force of capillary attraction causes the water to rise.

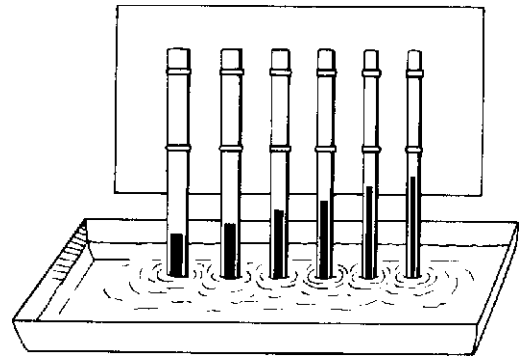

13 To show how water rises in different types of soil

Place about 15 cm of different types of soil in a series of lamp chimneys after tying a piece of cloth over the end of each chimney. Such soil samples as sand, loam, gravel (fine), clay, etc. may be used. Next stand the lamp chimneys in a pan which contains about 3 cm of water. Observe the type of soil in which water rises highest due to capillarity. Clear plastic drinking straws can also be used for this experiment.

14 To show which types of soil hold water best

Tie cloth over the end of several lamp chimneys and then fill each one to within 8 cm of the top with different types of soil. Use sand, clay, loam and soil from the woods. Place dishes under each chimney to catch water which runs through. Next pour measured amounts of water into each chimney until the water begins to run through. Observe the soil type into which the most water can be poured without running through.

15 The effect of rain on loose soil

Make a sprinkling can by punching holes in the bottom of a tin can with a hammer and small nail. Fill several flower pots or cans with loose soil and press it down until it is even with the edges. Place some coins or bottle tops on the surface of the soil. Set each pan in a basin and sprinkle with water from your can to represent rain. First sprinkle lightly and note the effects of a light rain. Continue sprinkling to illustrate a heavy rain. Notice how the unprotected soil is splashed away leaving columns of soil under the bottle caps and coins.

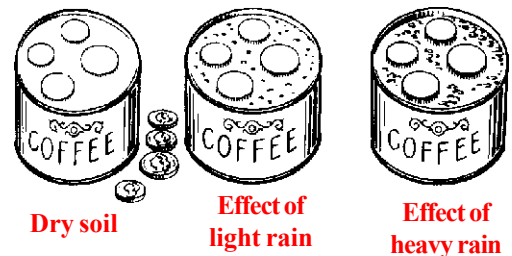

16 The effect of rain on sloping soil

Fill a shallow pan or box with firmly packed soil. Set the pan outside in the rain with one end raised slightly. Observe how the raindrops splash the soil down toward the lowered end. This experiment can be done inside by using the sprinkling can for rain.

17 To show the impact of a raindrop on soil

Place a saucer or jar lid filled with soil on a piece of white paper. Fill a medicine dropper with water and hold it about a metre above the soil. Release water a drop at a time and observe how much soil is splashed out on the paper. Place a clean sheet of paper under the saucer. Again release drops but hold an obstacle such as a pencil in the path of the drop to break the force of the raindrop. Do plants prevent the wearing away of the soil in this way?

18 How the effect of raindrops on soil varies

Fasten a sheet of white paper to a piece of stiff cardboard with paper clips. Lay it flat on the floor. Drop coloured water on it with a medicine dropper. Note the size and shape of the splashes. Repeat but this time prop up one end of the cardboard. Study the effect on the splashes of varying the height from which the water is dropped, of varying the slope and the size of the drops. Try different combinations of the variables. A record of the results may be kept if a clean sheet of paper and different coloured water is used for each situation.

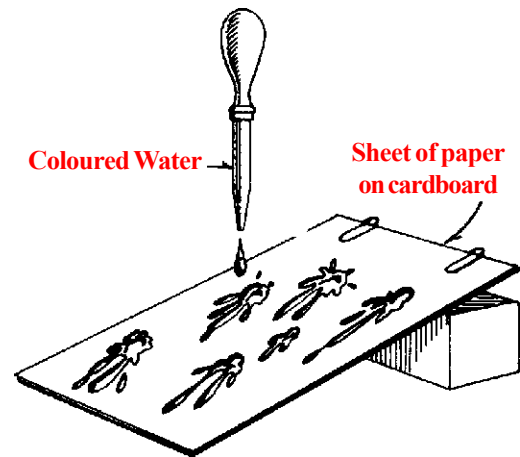

19 The effect of falling water on topsoil

Fill a flower pot with sandy soil or loam. Set the pot under a dripping tap for an hour or more. Observe how the clay and inorganic matter are removed from the surface by falling drops.

20 The effect of rain on unprotected surfaces

Build up a pile of sand and clay in a box or pan. Sprinkle gently near the top with water from the sprinkling can. Note the way the running water transports the rock particles and deposits them near the bottom of the pile.

21 How running water wears away the soil

Construct the two trays as shown in the drawing below. Putty in the cracks will make them water-tight. Pails or glass jugs with funnels may be used to collect the run-off water.

(a) Fill one tray with loose soil and the other with firmly packed soil. With both trays slightly tilted, water each the same amount with a sprinkling can. Observe which soil is moved away faster and the nature of the run-off water.

(b) Fill both trays with soil but cover one with sod. Water equally as before and observe both the erosion and the run-off water.

(c) Fill both trays with soil but give one more slope than the other. Water and observe as before.

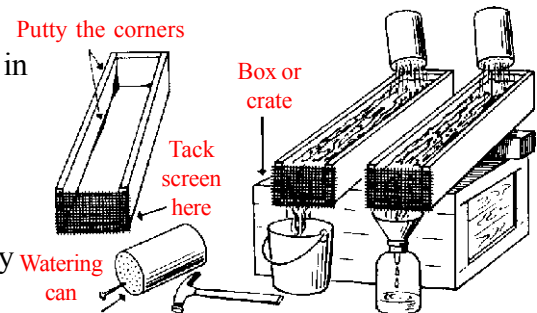

22 How to prevent the erosion of topsoil

Use the trays constructed for the experience above.

(a) Fill the trays with loose soil and tilt each one the same amount. Make furrows with a stick running up and down the hill in one box and across the hill in the other box. Sprinkle each the same amount. Observe the erosion in each case and the run-off water.

(b) Again fill the trays with loose soil. Water them until there are well-defined gulleys formed from the running water. Now block the gulleys at intervals with small stones and twigs. Again water and observe the effect of blocking the gulleys.

23 A field trip to study erosion

Find some place in the locality where running water has done damage by cutting gulleys. Take the class to study the erosion. Why was it caused? How could it have been prevented? What can still be done?

24 Conservation on the school grounds

Almost every school yard will have some place where running water has done damage. Enlist the class in a project to decide upon means for preventing the erosion and then let them carry out their project.

E. FOSSILS

1 Where to find fossils

In some localities fossils may be found in stone quarries or where there are rock out-crops. Try to find someone in the community who knows about fossils and then plan a field trip with the class to collect some of them.

Fossils can often be found by breaking lumps of soft or bituminous coal apart. Break the lumps carefully and examine the broken surfaces for imprints of leaves and ferns.

If there are no fossils in your community, you may have to depend on state or national museums to send you a few. A letter to the state or national museum may prove helpful.

2 How fossils were formed

Cover a leaf with vaseline and place it on a pane of glass or other smooth surface. Place a circular strip of paper or cardboard around the leaf. Press modelling clay against the strip to hold it firmly. Now mix up some plaster of Paris and pour it over the leaf. When the plaster has hardened, you can remove the leaf, and you will have an excellent leaf print. Some fossils were made this way—by having silt deposited over them, which later hardened into sedimentary rock. Repeat this experience using a greased clam or oyster shell to make the imprint.

3 How to mount fossils

If you happen to live in a locality where fossils are plentiful, it will be interesting to have the pupils make a fossil collection for the school museum.

Fossils can be neatly mounted in plaster of Paris by following the instructions given for mounting rocks and minerals in section A 10 of this chapter.

CHAPTER VI

Experiments and materials for astronomy

Astronomy is always an interesting topic for children in the elementary school as well as for young people studying general science. In many places the basic concepts of astronomy are taught descriptively—that is, the children merely read about them. In this chapter many experiments are suggested to enable the teacher to develop some of the concepts from observation and experiment.

No attempt has been made to grade the experiments. It is suggested rather that teachers select those experiments that seem most appropriate for the topics being taught.

A. OBSERVING THE STARS

1 Making a simple refracting telescope

To make a simple telescope, two cardboard tubes will be required, one fitting inside the other.

It is not possible to make a satisfactory telescope unless good lenses are available, a fact which was soon discovered by early experimenters.

A linen tester (sometimes a stamp magnifier also) has lenses which are achromatic, that is corrected for colour distortion. Such a lens of focal length 2 or 3 cm will provide a suitable eye-piece when mounted in a cork with a hole in it.

It is equally important that the object glass should be achromatic for best results. If such a lens is available with a focal length of 25 to 30 cm it should be fixed in the wider cardboard tube by plasticine. A little adjustment is required to get both lenses on the same geometrical axis. When this has been achieved and the focusing done by sliding the tube, it is a superior instrument to the one with which Galileo made all his discoveries.



Jupiter's moons are readily observed with this apparatus, but not Saturn's rings.

2 Making a simple reflecting telescope

A simple reflecting telescope can be made from a concave mirror obtained from a shaving mirror. The mirror is arranged in a wooden box of suitable size in such a way that it can be tilted at different angles. An upright made of wood is attached to the box so that its angle may also be varied. Two short focus lenses are fixed in corks which are then placed in a short length of mailing tube as an eye-piece. Then attach this eye-piece attached to the wood upright exactly at the focal

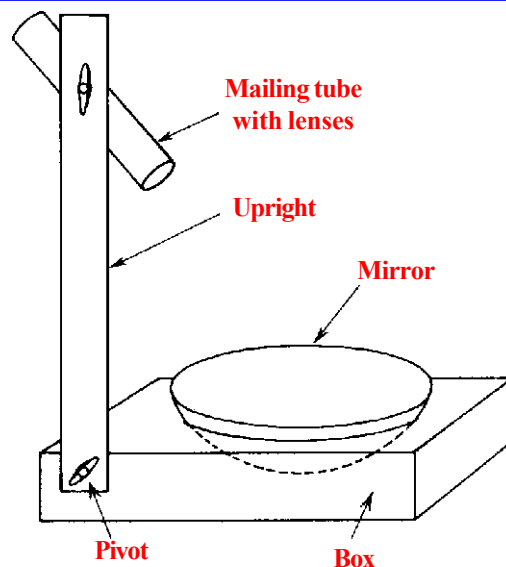

3 Making a precision reflecting telescope

It is quite beyond the scope of this book to include the intricate details for mirror grinding and testing. However, some teachers may wish to have able pupils engage in making a better telescope. Attention is therefore directed to the excellent book called *Amateur Telescope Making* published by the Scientific American Publishing Co., New York City, N.Y.

4 Learning to recognize the main constellations and making a star map

This is a convenient home task, and is best done about the time of a new moon. The moonlight does not then interfere with a good view of the stars. The Pole Star should be identified first, and it is helpful to take outside a piece of brown paper with pinholes pricked through it in the form of a few of the constellations. When the paper is held up to any light the pinholes become visible, and the paper can be rotated until a similar star pattern is recognized. A star map, with the Pole Star as centre, can soon be built up.

After a few constellations have been learnt in this way, it is instructive to make one map in the early evening, and one just before going to bed. Another interesting way of recognizing constellations is to take outside a blackboard and stick into it luminous (phosphorescent) buttons to represent the stars.

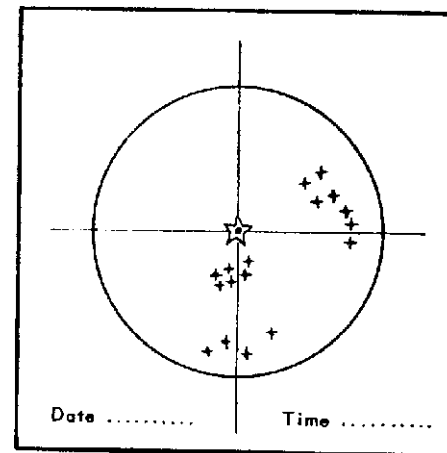

5 Photographing star 'trails'

A very interesting activity for pupils who have cameras is the photographing of star trails as the earth revolves. Select a clear moonless night for this and find a place where there is an unobstructed view of the horizon. The place selected should be away from extraneous light such as automobile headlights, etc. Face the camera as directly at the Pole Star as possible and secure it either with a tripod or with blocks of wood. If the camera is the focusing type, set the lens at infinity and open the diaphragm full. The shutter should be set for a time exposure. When all is ready open the shutter and leave it open any length of time from one to six hours. The longer it is open the longer will be the star trails. Try photographing stars in the Milky Way.

6 How to make a constellarium

A constellarium is a simple device used in teaching the shapes of various constellations. Get a cardboard or wood box and remove one end. Draw the shapes of various constellations on pieces of dark coloured card- board large enough to cover the end of the box. Punch holes on the diagrams where the stars are located in the constellations. Place an electric lamp inside the box. When the lamp is turned on and various cards are placed over the end of the box, the constellations may be seen clearly.

Another way is to secure several tin cans into which an electric lamp will fit. Holes are punched in the bottoms of the cans to represent the stars in various constellations. When the lamp is placed inside a can and turned on, the light shows through the openings and the shape of the constellations may be observed. 'The cans may be painted to prevent rusting and kept from year to year.

7 How to make an umbrella planetarium

Since an umbrella has the shape of the inside of a sphere it can be used to illustrate portions of the heavens. Secure an old umbrella that is large. With chalk mark the North Star, or Polaris next to the centre on the inside of the umbrella. Use a star map and mark the star positions for various constellations with crosses. When you have filled in all the polar constellations you can paste white stars made from gummed labels where the crosses are; or you may paint the stars in with white paint. Later you can make dotted lines with white paint or chalk to join the stars in a given constellation.

B. THE SUN AND THE STARS

1 A chart of the constellations of the zodiac

The constellations of the zodiac are found along the ecliptic, in a belt 16 degrees wide. This belt can be subdivided into 12 sections each subtending 30 degrees, and including a constellation. called a sign of the zodiac.

The sun has one of these behind it when it rises in each month of the year, e.g. about 21 March Aries is behind the sun at sunrise; a month later, the sun rises in Taurus, etc.

Spring signs :	March April May	1. Aries 2. Taurus 3. Gemini
Summer signs :	June July Aug	4. Cancer 5. Leo 6. Virgo
Autumn signs :	Sept. Oct. Nov.	7. Libra 8. Scorpio 9. Saggiarius
Winter signs:	Dec. Jan. Feb.	10. Capricorn 11. Aqurius 12. Pisces



ARIES
(ram)



TAURUS
(bull)



GEMINI
(twins)



CANCER (crab)

The charts display the whole of the constellations. The dates round its edge show when that part of the heavens is due north at midnight. The actual stars visible would be contained in a circle having a diameter slightly less than three-quarters of the whole chart, and so placed on the chart that it is on the opposite edge to the date required. The diameter of the chart being 11 cm, it is a good practice to cut an 8 cm circle of transparent paper, draw a diameter on it as a north to south guide, and lay it on the chart to show what area is visible at midnight on a given date. The diameter should cross the Pole Star, and point to the date. There will be a gap between the edge of the paper and the edge of the chart, and it will be found that the Pole Star is always half-way between the centre of the transparent disc and its momentarily northern edge.

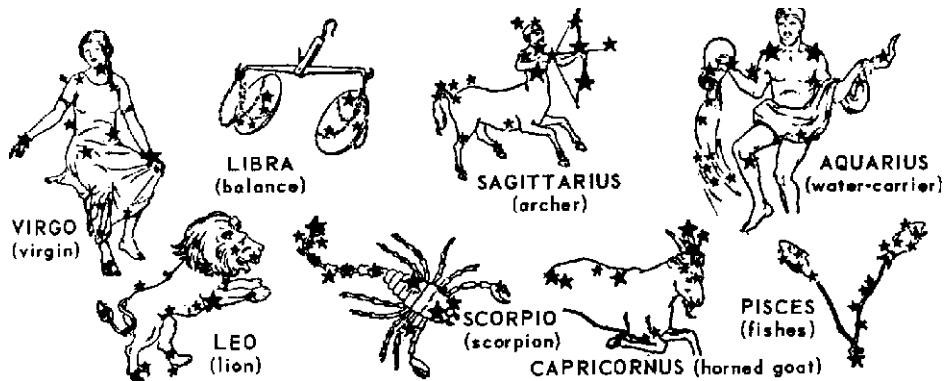

2 A model to show the apparent path of the sun among the stars

The signs of the zodiac are drawn in the correct order on a strip of paper about 60 cm long and 8 cm wide. The ends of the paper are then gummed together making a continuous loop with the zodiacal constellations inside. The loop is then stood edgewise and gummed in a circle about 18 cm diameter to a cardboard base. A short candle placed at the centre represents the sun. The seasons corresponding with the signs of the zodiac are marked on the baseboard outside. A chestnut or other object hung from a piece of cotton will rotate as the cotton unwinds and serve to represent the rotating earth.

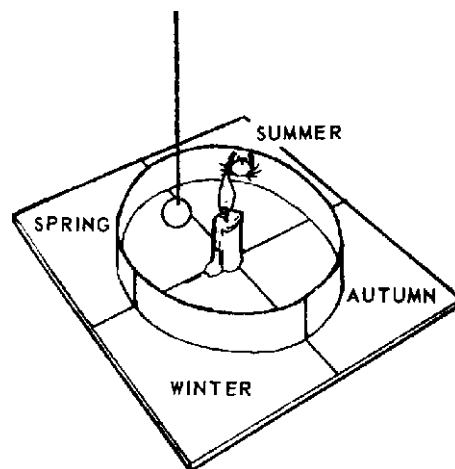

3 A model illustrating how an eclipse appears

The sun is represented by an opal electric bulb shining through a circular hole 5 cm in diameter in a piece of blackened cardboard. The corona is drawn in red crayon around this hole. The moon is a wooden ball 2.5 cm diameter mounted on a knitting needle. The observer views the eclipse through any of several large pin holes in a screen on the front of the apparatus. The corona only becomes visible at the position of total eclipse. The moon's position is adjusted by a stout wire bicycle spoke attached to the front

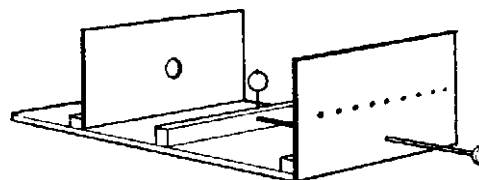

4 Illustrating an eclipse of the sun

Hold a small coin a few inches from one eye and close the other eye while looking at the lighted electric bulb on the ceiling of a room. The large bulb is far away and represents the sun. The small coin is close to your eye and represents the moon coming between the sun and the earth. You will observe that the small coin completely hides the light bulb on the ceiling and casts a shadow on your eye.

5 Observing sun spots

Use the telescope that you made in a previous experiment. Set it up so that it points directly at the sun and focus it so that a clear and bright image of the sun is formed on a piece of white cardboard placed a short distance from the eyepiece lens. If sun spots are present on the surface of the sun you may be able to observe them as small dark spaces of irregular outline on the image. Caution. Do not look at the sun through the telescope, unless your eyes are protected by a dark glass filter.

6 Observing changes of position of the earth with respect to the sun

Mark a line on the floor or the wall where the sun shines in your room. Note the exact month, day and hour. At the end of each week make another line at exactly the same hour. Repeat this throughout the year and you will have some interesting observations. The variation in position of the line from week to week and from month to month is caused by the movement of the earth around the sun.

C. EXPERIMENTS RELATED TO THE SOLAR SYSTEM

1 Making a model of the solar system

The concepts of the relative size and distance of the planets from the sun can be illustrated by having pupils make a model of the solar system. This can be done using various sized balls, for the sun and planets, by making clay models or simply by cutting circles of the proper size from cardboard. These can be arranged either on the wall, on the floor or on the blackboard where the orbits of the planets can be marked off with chalk. The table below gives the data necessary for making a model to scale.

Data on planets	Mercury	Venus	Earth	Mars	Jupiter	Saturn	Uranus	Neptune	Pluto
Average distance from the sun in millions of miles	36	67	93	141	489	886	1782	2793	3670
Diameter in miles	3000	7600	7900	4200	87000	72000	31000	33000	?

2 Observing visible planets By using a good star map the planets visible at different times of the year can be easily identified by the teacher. Pupils should be taught to identify the planets and to be able to tell them from the brighter stars. Children always enjoy an evening of observation. Make use of the telescope or a pair of field glasses.

3 Watching for 'shooting stars'

A good time to watch for meteors or 'shooting stars' is in August or November. Have the children keep watch of the evening sky and report any observation they make.

D. EXPERIMENTS RELATED TO THE EARTH

1 A Foucault pendulum to show the rotation of the earth

A G-clamp with a ball bearing soldered to the inside of the jaw makes a good support for a Foucault Pendulum. It is best hung indoors with the ball bearing resting on a stout razor blade or some other hard surface. When such a pendulum is set in motion, the plane of swing is altered after a few hours, as will be noticed if a mark is made on the ground at the time of release. It is, of course, the earth rotating underneath the 'bob' which gives this effect.

Unspun nylon fishing line should be used for suspending the bob, which can be a cricket ball. The length of the pendulum is not important; anything from 3 m to 30 m will do.

Care must be taken that the pointer, a short knitting needle driven into the ball, is continuous with the suspending thread. A reference line drawn on a piece of white card can be fastened to the floor with drawing pins. This must be positioned accurately under the pointer when the ball is at rest.

To set the pendulum in motion, attach a long cotton thread to a tincture driven into the bob, and align it so that it lies along the direction of the reference line; then burn the thread near the tack. It is not easy to get good quantitative results without many refinements, but it is not difficult to observe the effect.

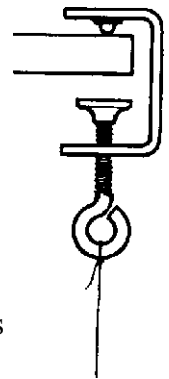

2 A simple theodolite or astrolabe A simple theodolite or astrolabe is made by fixing a drinking straw to the base line of a protractor with sealing wax or glue.

A plumb line hung from the head of a fixing screw will ensure that the supporting pole is upright and will serve also to measure the angle of the star or any other object.

An improved model for finding latitude, and the bearing of a star from the N.S. meridian can be made by fixing the rod to a baseboard with a screw. Two coins with holes in the centre can be used as washers and a piece of tin fixed to the rod will indicate the angle on a horizontal scale. It is with such rough apparatus as this that many early discoveries were made.

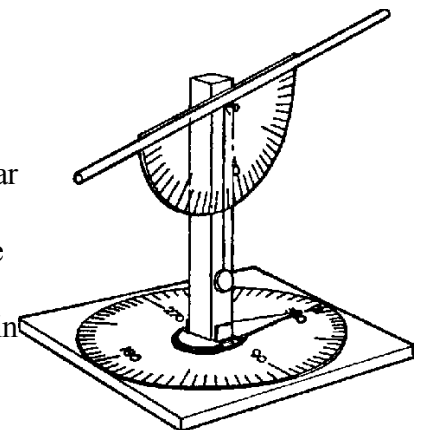

3 A model sextant

A simple sextant can be devised using cork, glue, pins, glass tube, sealing wax, etc.

The cork is slightly cut away at one end so that the base line of the protractor is parallel to a diameter when in position. A stout pin stuck through the centre of the protractor serves as an axis on which the moving mirror can turn. A piece of glass tubing drawn out to fit the pin serves as a hinge when stuck to the mirror slip (7 cm by 1 cm). The silvering is removed from all except the first centimetre of the mirror slip, and the remaining clear glass acts as an arm to the instrument and indicates the angle on the protractor scale.

The fixed mirror is fastened by wax in a slot made in the protractor with a heated piece of wire or knitting needle. It is convenient to make this slot 45 degrees to the vertical. Half the silvering is scraped off this mirror so that the horizon can be observed through the straw or glass sighting tube which is fixed with wax parallel to the base line of the protractor.

In use the instrument is held by the cork in the right hand, and the arm is adjusted until the two images of the horizon, seen in the clear and silvered half of the fixed mirror, are continuous. The angle indicated by the clear glass arm is then recorded.

The arm is now moved until the image of the sun or other object seen in the silvered half of the mirror rests on the horizon viewed directly through the clear half.

The angle moved through by the arm is half the altitude of the sun. A smoked eyeglass or a piece of gelatine filter may be needed if the sun is too bright.

Similar slips of glass mirror can be supported perpendicular to a drawing board by large pins stuck through the glass tubing. They are then useful for studying the paths of rays of light through the mirror system of a sextant, using beams of light or pins to track down the paths of particular rays.

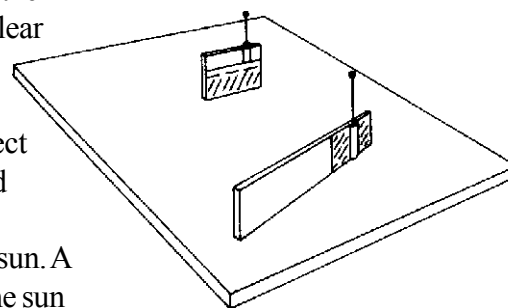
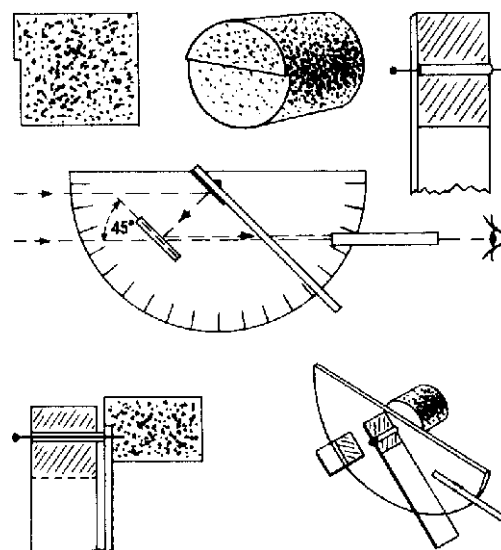

4 Making a sun-dial

To withstand all weather, a sun-dial should be made of metal or painted wood. A cardboard model can be made for simple experiments.

The gnomon which casts the shadow is a right-angled triangle with base angle equal to the latitude of the place at which it is going to be used.

This is glued in position so that the hypotenuse points to the North Star. The hours can then be marked off on the baseboard.

Another pattern can be made if glass tubing about 4 cm in diameter is available.

In this case the gnomon is a stout knitting needle fixed to the base at an appropriate angle. The scale, which is divided into 24 equal parts, is stuck round the circumference of the glass tubing and the shadow of the knitting needle indicates the hour. The glass tubing is held in position by corks.

This type of sundial is not satisfactory in areas lying between latitudes 15° N. and 15° S. of the equator.

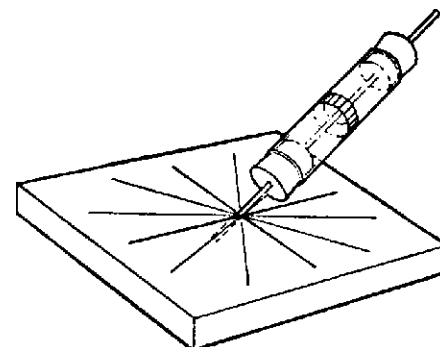
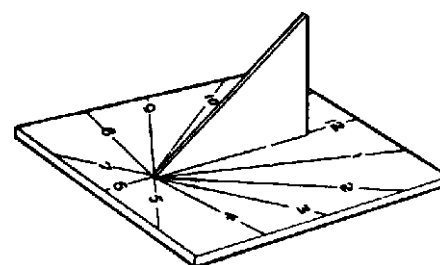

5 A simple model of the earth and moon

The earth can be represented by an orange or other round object stuck on a piece of bamboo or a meat skewer. A piece of bent wire or knitting needle stuck through the shaft will support a round chestnut or small nut to represent the moon. The phases of the moon, and the rotation of the earth round the sun, and also the formation of eclipses can be illustrated by holding it in the hand while walking in a circle round a lamp of some sort.

6 Demonstrating the cause of seasons

Use a hollow rubber ball such as a tennis ball to represent the earth. Push a 15-cm length of wire or a knitting needle through the ball to represent the earth's axis. Draw a circle about 40 cm in diameter on a piece of cardboard to represent the earth's orbit.

Mark the four quarter points north, south, east and west. Hang an electric lamp about 15 cm above the centre of the cardboard to represent the sun. A lighted candle may also be used. Place the ball representing the earth successively at the four positions with the axis slanted about 23.5 degrees. Observe the amount of the ball that is always illuminated. Observe where the direct rays of the sun strike. In each of the four positions observe which hemisphere receives the slanting rays of the sun. Repeat the experiment with the needle perpendicular to the table top in each of the four positions and observe what would happen if the axis of the earth were not inclined.

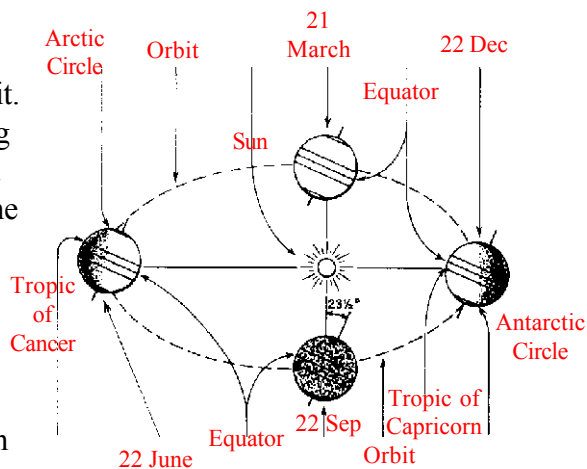

7 Demonstrating the cause of difference in length of day and night in some places

Use the same apparatus as in 6 above. Mark a circle on the ball around its centre to represent the equator. Place dots on the ball to represent cities on the equator, in the northern hemisphere and in the southern hemisphere. Place the ball at each of the four positions again but this time rotate the earth on its axis in each position and observe how long the various city positions you have marked are in the light and how long in shadow. Can you observe when each pole has six months of day and six months of night?

8 Demonstrating the effects of the angle of the sun's rays on the amount of heat and light received by the earth

Bend a piece of cardboard and make a square tube 4 cm² in cross section and 32 cm in length. Secure a piece of very stiff cardboard and cut a strip 23 cm long and 2 cm wide. Paste this to one side of the tube with 15 cm extending. Rest the end of the stiff cardboard on the table and incline the tube at an angle of about 25 degrees. Hold a flashlight or lighted candle at the upper end of the tube and mark off the area on the table that is covered by the light through the tube. Repeat the experiment with the tube at an angle of about 15 degrees. Repeat again with the tube vertical. Compare the size of the three spots and determine the area of each. Is the amount of heat and light received from the sun greater when the rays are slanting or direct?

9 Making a shadow stick

In an open space on the school ground drive a 130 cm stick into the ground and let the children keep a record of the length of the shadow, measured two or three times a day at different seasons of the year.

10 Demonstrating how the angle of the sun's rays changes from day to day at the same hour

Cut a 1-cm round hole in a piece of paper or cardboard. Place this in a south window of your classroom where the sun's rays will shine through the hole and strike a piece of white paper on the floor, the table or window sill. Draw the outline of the spot where the beam of light strikes the paper. Write the date and hour inside the outline. Repeat this on succeeding days at exactly the same hour.

E. EXPERIMENTS RELATED TO THE MOON

1 Observing the surface of the moon Use the small telescope or a pair of field glasses. Study the surface of the moon and see if you can see any of its craters and mountains.

2 Observing the phases of the moon

Over the period of a lunar month have the children make nightly observations and sketch drawings of the moon. Begin at new moon and continue through the four phases.

3 Demonstrating the cause of the phases of the moon

Place a lighted candle or electric lamp on a table in a darkened room. Paint an 8 cm rubber ball white. Hold the ball in your hand at arm's length with your back to the light. Raise the ball enough above your head to allow the light to strike the ball. Note the part of the ball illuminated by the candle. This represents the full moon. Now turn around slowly from right to left keeping the ball in front of you and above your head. Observe the change in shape of the illuminated part of the ball as you make one complete turn. Do you see the various phases of the moon? Now repeat the turning but stop at each one eighth turn and have someone else draw the shape of the moon (ball) that is illuminated.

4 Demonstrating an eclipse of the moon

Use a flash light or a lighted candle in a darkened room to represent the sun. Hold an 8 cm rubber ball in one hand to represent the earth. Hold a 2-cm ball in the other hand to represent the moon. Hold the ball representing the earth in the beam of light from the flash light and observe the shadow cast by the earth. Next pass the smaller ball or moon behind the earth into the shadow. The moon will be in eclipse while it passes through the earth's shadow.

**“BE A GOOD SCIENTIST. FOLLOW INSTRUCTIONS EXTREMELY CAREFULLY.
WEAR PROTECTIVE CLOTHING WHEN WORKING ON ANY EXPERIMENTS
THAT INVOLVE FIRE OR EXPLOSIONS.”**

CHAPTER VII

Experiments and materials for the study of air and air pressure

We live at the bottom of an ocean of air which is one of the essentials for life. Man also makes use of air pressure in many of his daily tasks. Air and air pressure should be a subject of study for every boy and girl.

A. TO SHOW WHERE AIR MAY BE FOUND

1 Plunge a narrow-necked bottle, mouth down into a jar of water. Slowly tip the mouth of the bottle toward the surface of the water. What do you observe? Was the bottle empty?

2 Place a lump of soil in a container of water and observe. Did you see anything that might indicate the presence of air in the soil?

3 Secure a brick and place it in a container of water. Is there any evidence that air was inside the brick?

4 Fill a glass with water and observe it closely. Let the glass stand in a warm place for several hours. Observe again. What difference do you see? Is there any evidence that water contains air?

B. TO SHOW THAT AIR TAKES UP SPACE

1 Secure a bottle and a funnel. Place the funnel in the neck of the bottle. Fill the space around the funnel with modelling clay. Be sure to pack the moist clay tightly in the neck of the bottle. Pour water slowly into the funnel. What do you observe? What does this show about air?

2 Repeat experiment 1 above and pour water into the funnel until it comes nearly to the top. Carefully punch a hole through the modelling clay into the inside of the bottle with a nail. What did you observe? Why did it happen?

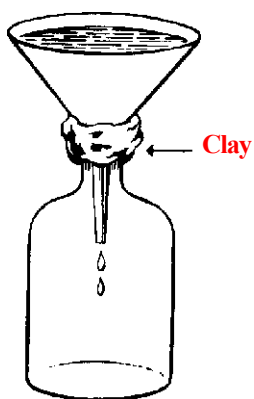

3 Float a cork on a large glass jar half full of water. Lower a drinking glass, mouth downward over the cork. What do you observe? Wedge a piece of paper tightly into the bottom of the glass and repeat. Does the paper get wet?

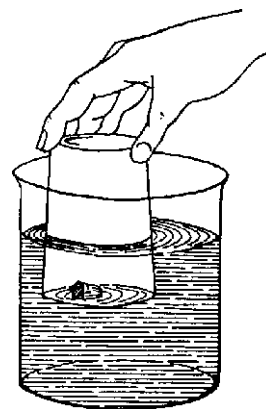

4 Secure an aquarium or a big water bowl and fill it nearly full of water. Lower a drinking glass, mouth downward into the aquarium. With your other hand lower another glass into the aquarium. Let this glass fill with water by tilting its mouth upward. Now hold the second glass above the first one mouth downward. Slowly tilt the first glass to let the air escape slowly. Fill the second glass with air from the first glass. What does this show about air?

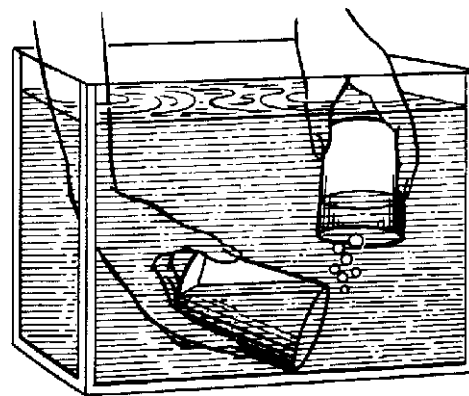

5 Place a tall glass jar in the aquarium. Let it fill with water and stand, mouth down, on the bottom. Place a rubber tube or a soda straw under the edge of the bottle and gently blow into the tube. What does this show about air?

6 Invert a tall glass jar filled with water in a shallow pan of water. This may be done by first filling the jar, placing a piece of glass or cardboard over the mouth and then inverting it in the pan of water. Remove the cover under the water in the pan. Raise the edge of the jar a little and place the end of a medicine dropper under it. Squeeze the bulb of the medicine dropper and observe what happens. This may be repeated several times. What does this show about air?

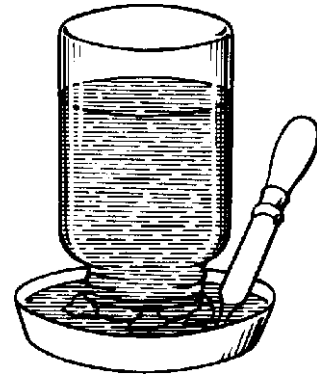

7 Secure a bottle with a tightly fitting cork or rubber stopper. Fill the bottle with water except for a small bubble of air. Turn the bottle on its side and try to make the bubble of air disappear by pressing on the cork. What do you observe? What does this show about air?

C. TO SHOW THAT AIR HAS WEIGHT

1 Drive a thin nail through the exact centre of a long rod such as a metre stick or a yard stick. Balance the stick by resting the nail on the rims of two drinking glasses. Make a rider out of a short length of wire and place it on the end of the stick which needs weight to balance. Move the rider until the stick balances perfectly. Hang a rubber balloon and a rubber band on one end of the stick. Now counterbalance the balloon exactly with some weight on the other end of the stick. Mark the place on the stick where the balloon and counter-weight were placed. Remove the balloon and inflate it, using a bicycle pump. Close with the rubber band. Next hang the balloon and counterweight exactly where they were before. What do you observe? What does this show about air? It must be remembered however, that the balloon increases in volume and so displaces more air. The resulting increased buoyancy complicates the experiment, but an increase in weight can be observed if the balloon is blown up hard. This difficulty can be avoided if a metal hot-water-bottle fitted with a cycle valve is used instead of the balloon.

D. TO SHOW THAT AIR EXERTS PRESSURE

1. Fill a drinking glass to the brim with water. Place a piece of cardboard over it. Hold the cardboard against the glass and turn the glass upside down. Take away the hand holding the cardboard.

Place the inverted glass on a smooth table top and carefully slide it off the cardboard on to the table top. Move the glass slowly over the table top. Can you suggest a way to empty the glass without spilling the water on the table top? What does this experiment show about air?

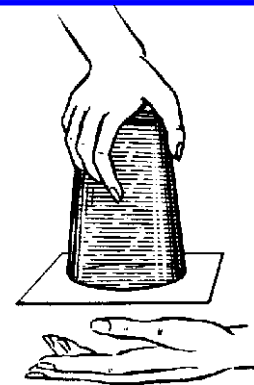

2 Select a tall glass jar and place a few lumps of clay on its rim. Fill the jar with water. Place a saucer on the clay and then invert the tall jar and saucer. This device can be used as a drinking fountain for chickens. Why does the water stay in the jar? Remove a little of the water from the saucer. What happens? Why?

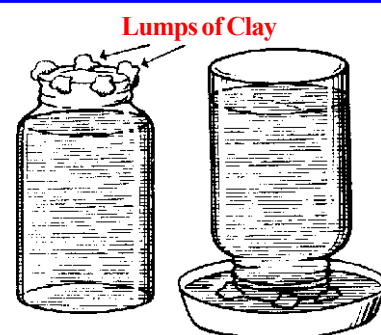

3 Secure a piece of thin board about 5 cm wide and 60 cm long. Place the board on a table with about 25 cm sticking over the edge. Now take a sheet of newspaper and spread it out so that the part of the board on the table is completely covered. Next carefully press all the air from under the paper by stroking with your hands from the centre of the paper toward the edges. The success of this experiment depends on how well you remove the air from under the paper. When this has been done have someone strike a sharp blow with a stick near the extended end of the board. What happens? What does this show about air?

4. Hold a finger over the end of a piece of straight glass tube or soda straw and lower it into a jar of coloured water. Remove the finger and observe what happens. Replace the finger on the top of the tube and then lift the tube from the jar. What happens? Why? What does this show about air?

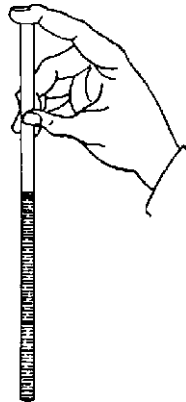

5 Make a hole with a nail near the bottom of a tin can. Fill the can with water. Hold the palm of the hand tightly over the top and water will stop running from the hole. Remove the hand and water runs from the hole. What does this show?

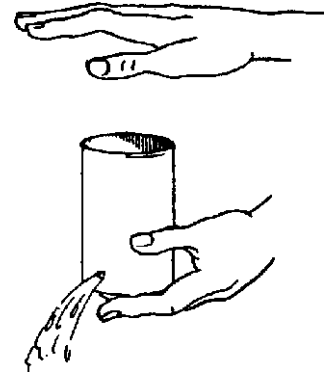

6 Select a tall glass jar or bottle. Screw up some paper, set fire to it and drop it in the container. Quickly stretch a rubber balloon over the mouth of the container or hold a piece of rubber tightly to the top. What do you observe? Can you explain why this happened?

7 Boil an egg for ten minutes or until it is very hard. Remove the shell. Select a bottle with a neck through which the egg can be forced without breaking the hard white of the egg. A quart or litre milk bottle will work very well. Screw up a piece of paper, set fire to it and drop it in the bottle. Quickly place the egg, pointed end down, in the mouth of the bottle. What happens? How do you explain this? To get the egg out, turn the bottle upside down. Let the egg rest, pointed end down, in the neck of the bottle. Now blow hard into the bottle and observe the results.

8 Submerge a drinking glass in a large container of water. Be sure the glass is filled with water. Lift the glass up with the mouth down, until the glass is nearly out of the water. Why does the Water not run out of the glass?

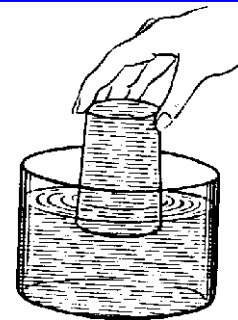

9 Wet the bottom of a plumber's force cup and press it against some flat surface such as the top of a stool. Try to lift the stool with the stopper. Why is this possible?

10 Wet the rims of two plumber's force cups. Press the rubber cups tightly together and then try to separate them. Why is it so difficult to pull them apart? This experiment is similar to the classic Magdeburg Hemi-spheres experiment.

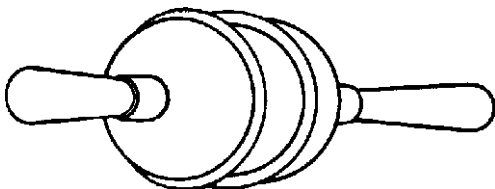

11 Blow a small amount of air into a balloon held in your mouth. Bring the balloon close to a table top and press two tea cups against the sides of the balloon. Blow a little more air into the balloon and then close the mouth of the balloon by pinching it. If the experiment has been carefully done you can lift the two cups with the balloon. What holds the cups to the balloon?

12 Select two thick drinking glasses and fit one of them with a collar of moist blotting paper. Screw up a piece of paper, light it and drop it into one glass standing on the table. Quickly press the other inverted glass tightly to the blotting paper. Can you pick up the bottom glass by lifting the top one? Why?

13 Select two thick drinking glasses. Fill each with water. Place a piece of paper over one and invert it over the other so that the rims fit closely together. Remove the paper. What happens? Why?

14 Place about 3 cm of water in a tin can which has a screw top. Place the can open on a stove and heat until the water boils and Steam issues from the open stop. Quickly remove from the fire and screw the cap on very tightly. Allow the can to stand and Observe the results. The effect can be hastened by running cold water Over the can or by immersing it in a dish pan of cold water. Unless the tin has been perforated, it can be blown out for use again by heating it gently.

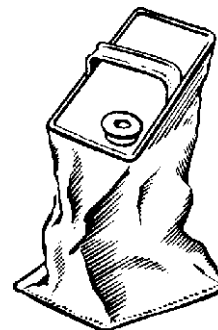

Plastic bottles or drums used in the home as containers for detergents can be used for a similar experiment. Remove the cap and place the bottle in hot water up to the neck for a few minutes. Replace the cap and plunge the bottle into cold water. Explain what happens.

15 Remove the brass shell from a used electric bulb by gently heating it in a gas or alcohol flame. When the sealing wax begins to smoke, grasp the shell with a pair of pliers and twist it away from the glass bulb. Observe the end of the sealed tube, extending from the bulb, through which the air was removed. Place the bulb tube end down in a jar of coloured water. With a pair of pliers, snip the end of the tube (while under water). What happens? How do you explain this?

E. TO MEASURE AIR PRESSURE

1 A simple mercury barometer

Seal one end of a glass tube about 80 cm in length by rotating it in a gas flame. The tube should be held as nearly vertical as possible. Attach a small funnel or thistle tube to the open end of your barometer tube with a short length of rubber tube. Pour mercury into the tube slowly. If air bubbles are trapped they may be removed by gently shaking the mercury in the tube up and down. Fill the tube to within 1 cm of the top. The last part is best filled by using a medicine dropper so that mercury will not be wasted. Fill the tube until a little mercury extends above the tube level. Pour about two centimetres of mercury into a bottle or dish. Place your finger over the end of the tube and place the tube open end down in the jar of mercury. Remove the finger from the tube when it is under the surface of the mercury. When this tube is properly supported it will serve as a mercury barometer. The height of the mercury between the levels in the jar and the tube measures the air pressure in centimetres or inches of mercury.

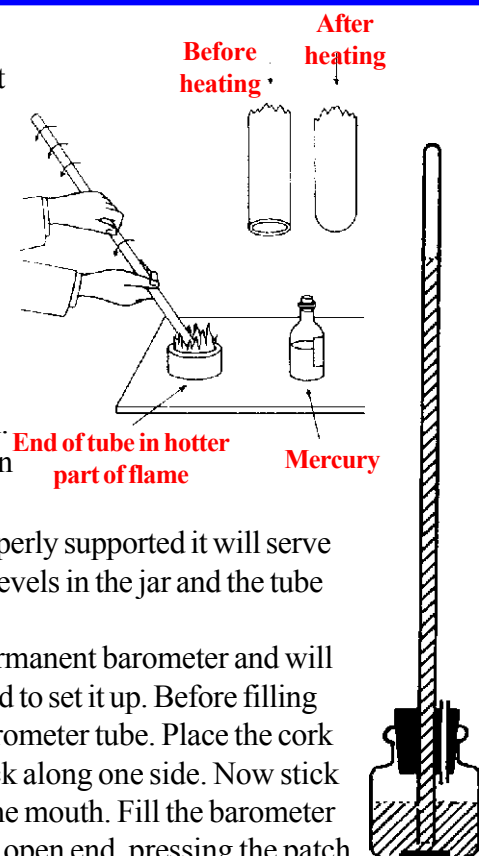

An ink bottle can be used as a container for the mercury in a permanent barometer and will help keep the surface clean. The following procedure may be used to set it up. Before filling the tube with mercury as described, find a cork which fits the barometer tube. Place the cork on the tube at about 15 cm from the open end and cut a small nick along one side. Now stick a rubber cycle patch onto the bottom of the bottle just opposite the mouth. Fill the barometer tube as described and place the bottle neck downwards over the open end, pressing the patch hard onto the top of the tube. Keeping the tube in contact with the patch, turn both over and stand the bottle on the bench. Still pressing on the tube, pour some mercury into the bottle. Now raise the tube a little to allow mercury to run from the tube, and push the cork into the neck of the bottle.

If desired, the barometer may now be supported in a bracket with a metre scale attached to it and hung on a wall. The top of the barometer tube should then be supported, and the ink bottle can be made to fit tightly in a tin fastened to the bracket. The effect of changing the pressure on the surface can be demonstrated by blowing or sucking through the nick in the cork of the mercury reservoir.

2 Fortin type barometer

A simple Fortin type barometer can be improvised for the junior laboratory. The glass tube is held vertically with one end in the reservoir by two curtain-rod holders on wooden blocks, fixed to the back board, which is a piece of 18 cm by 2.5 cm white-wood. The reservoir is a potted meat jar or small beaker, which can be moved bodily up or down by the screw jaw of a G-clamp. This alters the level of the mercury and keeps it in contact with the bottom of the scale. The reservoir is prevented from slipping sideways by a brass collar, fitting loosely and attached to the back board. The scale is cut down so that the first 10 cm can reach the surface of the mercury in the reservoir, or an ivory knitting needle can be substituted. The scale is screwed to the wooden blocks holding the glass tube supports. For setting up, the reservoir should be filled to the top, otherwise it is difficult to get the open end of the tube under the surface. Any excess can then be siphoned off. A cardboard disc may be fitted to keep the mercury clean; it also serves to keep out little boys' fingers.

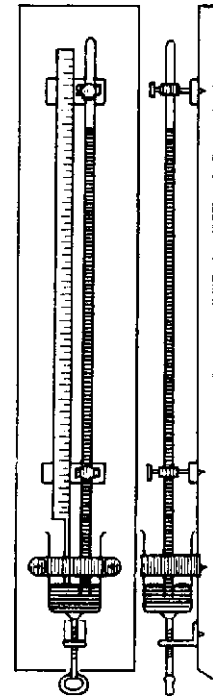

3 A bottle barometer

A bottle, partly filled with water, is inverted with its neck under the surface of more water in a saucer. This is the device used as a chicken feeder, but variations in atmospheric pressure can be recorded approximately on a strip of paper stuck on the outside.

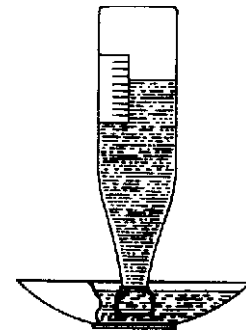

4 An aneroid barometer

The corrugated rubber tube from a gas mask, or a cycle handle grip, can be used to make a model aneroid barometer. No great accuracy is to be expected because of the many possible errors.

Two good corks or pieces of non-porous wood are needed to close the ends of the tube, which serves as a vacuum box. They are fitted when the rubber is compressed and they should be made airtight with wax and by tying string round the outside of the rubber.

A weight hung from the lower cork will partially counteract the result of atmospheric pressure and extend the bellows.

Variations in atmospheric pressure can be indicated by a magnifying pointer.

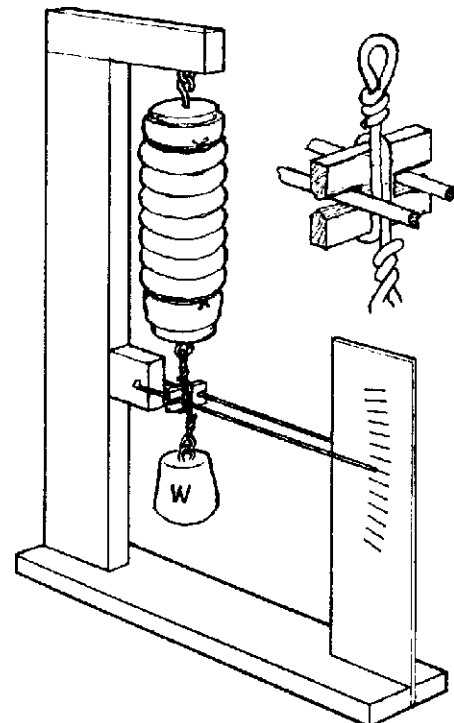

5 A balance barometer

This device depends on the fact that dry air is heavier than moist air at the same temperature.

Two equal cylinders (tin cans would do) are mounted, one at each end of the beam of a sensitive balance. Zehnder's arrangement is quite satisfactory for this purpose.

One of the cylinders is sealed as a standard specimen of air; the other has a hole in it so that air from the atmosphere can enter. The device would, of course, work on simple buoyancy with one cylinder only, but it is easier to balance it using two cylinders.

It must be mounted in a box to shield it from draughts, and an indicator projecting through the top indicates the position of the beam.

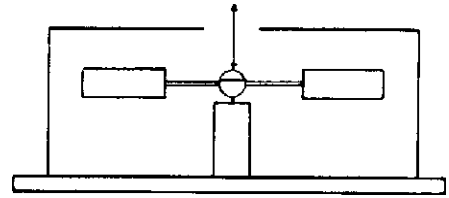

6 Another aneroid barometer

Stretch a piece of thin rubber over the mouth of a small glass jar. Wind thread or string over the rubber to secure it and then put a ring of household cement under the edges of the rubber sheet which have been trimmed off. Cut a thin circle from the end of a cork and glue this to the centre of the rubber. Next glue a long broom splint or soda straw to the cork. Cut a little wooden triangle from a match stem and glue to the edge of the bottle so that the splint or soda straw rests on it. A scale can be made and placed behind the end of the splint.

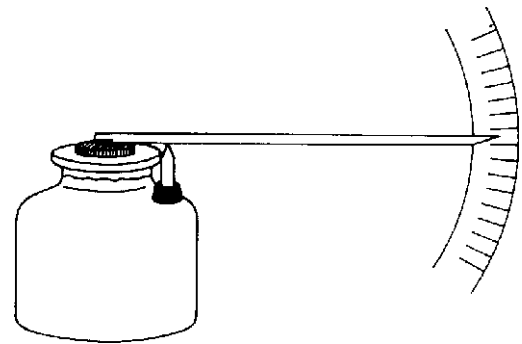

7. Measuring atmospheric pressure with a bicycle pump

A bicycle pump with the washer reversed as shown can be used to measure atmospheric pressure. The piston can be made airtight by adding a little thick oil to the barrel. The area of cross section of the pump barrel can be calculated or measured with squared paper. The pressure of the air can then be calculated in kg/cm^2 . The weight supported by the up thrust of atmospheric pressure is found by hanging various loads from a hook, screwed into a wooden plug fitted into the pump handle.

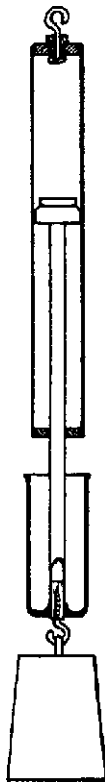

8 Measuring atmospheric pressure with a rubber sucker

The force required to pull the sucker away from a smooth surface can be found by using a spring balance. The area on which the atmospheric pressure is acting can be measured by pressing the sucker on a piece of squared paper.

Use a sucker which has a hook attached. If one is not available, tie some copper wire round the neck and form a loop.

If the laboratory bench is not smooth enough use a piece of plate glass, holding this down with one hand whilst pulling on the spring balance with the other. Make several trials and, if possible, use suckers of different sizes.

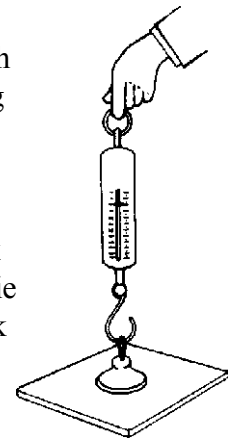

F. TO SHOW HOW PUMPS USE AIR PRESSURE

1 How different pressures of air force water from a container

Fit a test tube with a two-hole stopper. Through one hole place a length of glass tube which extends into the test tube nearly to the bottom. Put water in the test tube and suck on the upper end of the glass tube. Observe what happens. Next tightly close the open hole in the rubber stopper and again suck on the glass tube. Observe what happens. How do you account for the difference?

2 A simple syringe pump

Assemble a simple syringe using glass or metal tubing (iron pipe or conduit tubing is suitable), two corks and a piece of metal rod. The cork which serves as the piston is made to fit tight by wrapping a string round it. The other cork, with a piece of glass, bamboo or

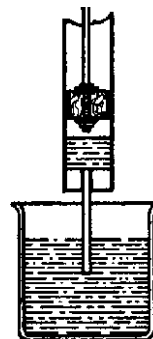

3 A lift pump

To modify the syringe and make a simple lift pump, burn two holes through the piston with a hot wire and fit a thin piece of leather or rubber above them to act as a valve which closes on the upstroke and yet allows liquid to pass through on the down stroke.

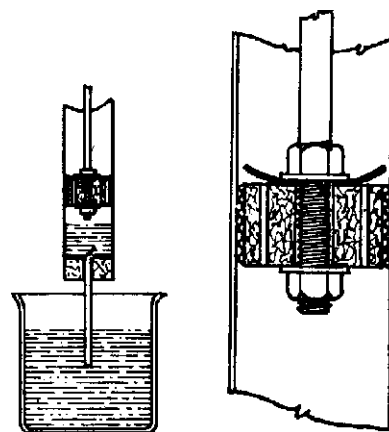

4 A lamp chimney lift pump

Use a straight-sided lamp chimney as a pump cylinder. Fit a two-hole stopper into the chimney for a piston. If the stopper is a little small wrap some string around it to make a tight fit. If it is a little large you can make it smaller with sand paper. Through one hole put an iron or brass rod for a piston rod. Cover the other hole on top of the stopper with a little flap of rubber or soft leather cut from an old shoe. This will be the piston valve. It can be held in place with a tack pushed into the stopper.

Fit a one-hole stopper carrying a 50-cm length of glass tube into the lower end of the lamp chimney. Over the hole in the stopper place another valve of rubber or soft leather. This is the foot valve. Put water in a pan. Prime the pump by pouring a little water on top of the piston. Observe the valves on the upstroke and on the down stroke of the piston. How does air pressure help the lift pump to work?

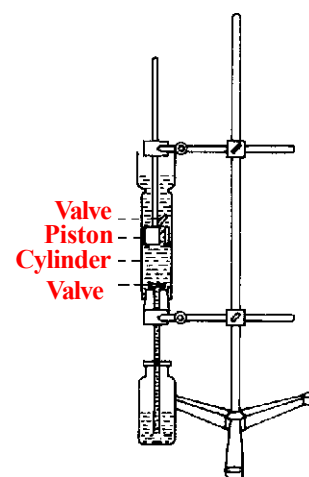

5 A lamp chimney force pump

Replace the piston in the lift pump described above with a one-hole stopper. Fit the piston rod through the hole. Fit the bottom of the chimney with a two-hole stopper. Through one hole place a 50-cm length of glass tube and put a valve over it. Through the other hole put a short length of glass tube. Next fit a glass bottle with a two-hole stopper. Put short lengths of glass tube through each hole flush with the underside of

the stopper. Place a valve over one of the holes. Clamp the pump firmly in a ring stand. Also clamp the bottle to the ring stand upside down. Place a clamp under the stopper and another on top of the bottle to hold it firmly in place. Now connect the outlet tube of the pump (the one without the valve) to the inlet tube of the bottle (the one with the valve). To the outlet tube of the bottle (pressure chamber) connect a length of rubber tube with a nozzle or jet tube (like a medicine dropper) in it. Prime your pump and see how far you can force the water. Observe the valves. How does air play a part in the operation of this pump? How does it differ from the lift pump? For what purpose could this pump be used?

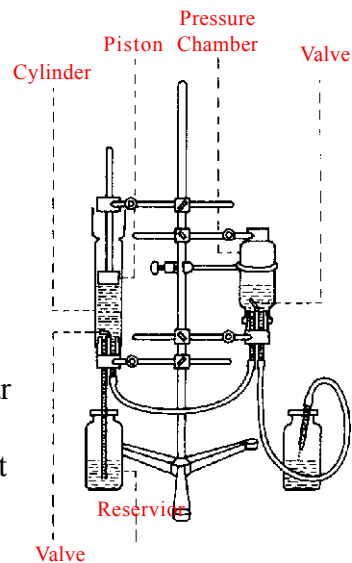

6 A test tube force pump

To make this apparatus, heat the bottom of a test tube with a small flame and blow a hole. Now blow a hole in a larger test tube and fit both with ball bearings or small marbles to act as valves.

If the inner one is made to slide tightly in the outer one by wrapping string round it, and has a cork and tube as shown in the diagram, it will serve as the piston of a force pump.

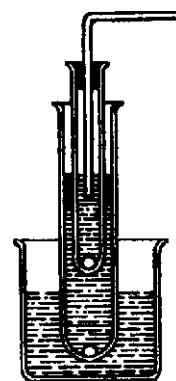

H. TO SHOW HOW SIPHONS USE AIR PRESSURE

1 A simple siphon

Secure two tall glass bottles and fill each about half full of water. Connect two 30cm lengths of glass tube with a 3~cm length of rubber or plastic tubing. Fill the tube with water and pinch it. Put a glass tube in each bottle of water. Siphon the water back and forth by varying the height of the bottles. The experiment is more interesting if the water is coloured with a little ink. Place the two bottles on a table. Does the siphon flow? Can you explain how air pressure helps the siphon work?

2 A siphon fountain

Fit a glass jar (a flask from a used electric bulb) with hole rubber stopper. Through one hole place a jet tube which will extend about half way to the top of the flask and let about 2 cm extend beyond the stopper. Through the other hole push a short length of glass tube so that it is just flush with the bottom of the stopper. Let about 2 cm of tube extend outside the stopper. Connect a 20-cm length of rubber tube to the jet tube. Connect a 1-m length to the other glass tube. Place some water in the flask, insert the stopper and then invert the siphon. Put the short rubber tube in a container of water on the table and let the longer rubber tube go to a pail on the floor. The fountain can be seen better if the water in the jar on the table is coloured with a little ink. You can make a double siphon fountain by making another flask unit similar to the first one and connecting them together.

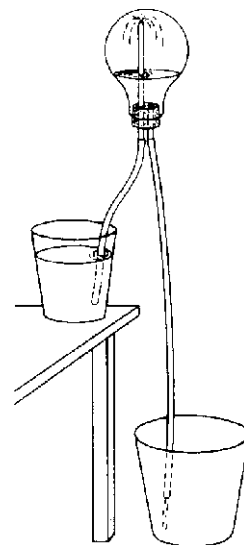

3 A self-starting siphon

Secure a piece of glass or plastic tube about 2.5 cm in diameter and 8 to 10 cm in length. Fit one end with a one-hole stopper, carrying a short length of glass tube that extends about a centimetre below the stopper on the inner side. Fit the other end of the big tube with a two-hole stopper. Through one of the holes in the two-hole stopper place a jet tube which extends up through the larger tube and into the opening of the glass tube in the one-hole stopper. Connect a long rubber tube to the glass tube in the one-hole stopper. Plunge the assembled unit into a pail of water that is standing on a table and direct the longer end of the siphon tube to a container on the floor. The siphon may require some adjustment before it starts to flow.

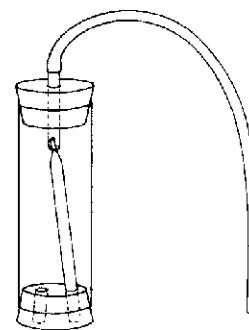

H. TO SHOW SOME EFFECTS OF COMPRESSED AIR

1 To feel the 'spring' of air

Secure a bicycle pump and place your thumb over the end of the outlet tube. Next push the piston in forcibly and quickly let go of it. What happens? How do you account for this?

2 Making a 'gusher' with compressed air

Secure a large narrow-necked bottle such as is used for soda water. Place a one-hole stopper in the bottle. Through the stopper put a 10-cm length of glass tube which has been drawn to a jet on the outside end. With a short length of rubber tube attach a length of glass tube that will extend nearly to the bottom of the bottle. Fill the bottle about half full of water. Insert the stopper firmly and hold it in with your fingers. Next blow hard into the bottle; and when you release the pressure, point the bottle away from you. What happens?

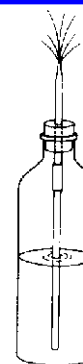

3 A compressed air pop-gun

Use a straight piece of glass or plastic tubing of 1 or 2 cm in diameter and 15 or 20 cm in length. Make a piston by winding some string on a pencil till it fits tightly in the tube. Put a small cork in the end of the tube and push the piston in quickly.



4 Lifting things with compressed air

Remove the bladder from a soccer ball or basket ball and place it on a table. Pile some books on the bladder and then blow into it.

5 Making a 'burp' bottle

Fit a bottle or flask with a one-hole stopper which carries a funnel. Put the stopper firmly in the bottle and then pour water into the funnel. The bottle will-'burp' at regular intervals.

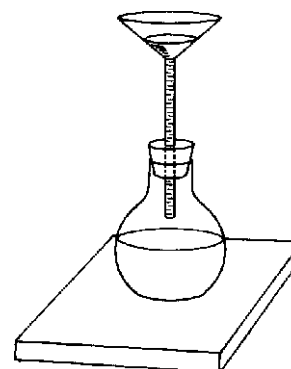

I. TO SHOW SOME RESULTS OF REDUCING AIR PRESSURE

1 Lifting water with air pressure

Fit a test tube with a one-hole cork and glass tube. Drive out the air by boiling a little water in it. Invert it with the open end under the surface of a jar of water. Atmospheric pressure will drive water upwards until it almost completely fills the test tube.

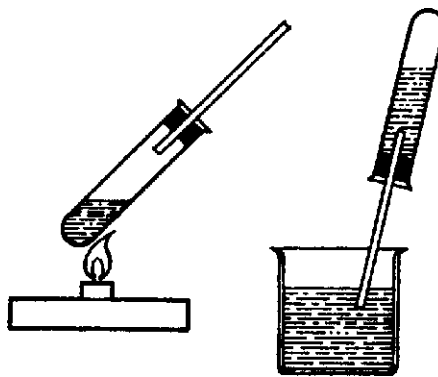

2 How to make a simple vacuum pump

Secure a bicycle or automobile hand pump. Open the pump and remove the piston. Unscrew the bolt that holds the leather washers. Reverse the washers by turning them over. Replace the washers on the piston and insert in the pump cylinder. A pump of this sort will serve to do many simple vacuum experiments.

3 How to make a receiver for vacuum experiments

Secure a large jar with an air-tight screw cap, such as a fruit jar. Drill a hole through the top and have a short metal tube soldered in the hole so that it is air-tight. Solder a tyre valve upside down in the lower end of the tube.

The tyre valve mentioned in this experiment can be fitted into a good cork in the neck of a Winchester bottle with the bottom cut off (page 218). If the edges are ground smooth with carborundum stone or hard rock a sheet of rubber cut from a large tractor tube can be used as a base plate to make an air-tight seal. The baroscope described below can be introduced into this bell jar.

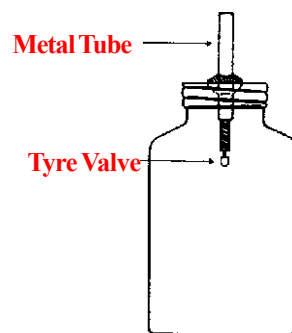

4 Model baroscope

Glue one end of a drinking straw (or better, a strip of balsa wood) so that it forms a beam perpendicular to the surface of a ping-pong ball. Find the point of balance and stick a fine needle through the beam to act as pivot. Rest this on a piece of metal bent into a U shape and supported on a base. Shave away the beam with a razor blade until the balance is perfect. Place this under the bell jar and pump out some of the air. Explain what happens.

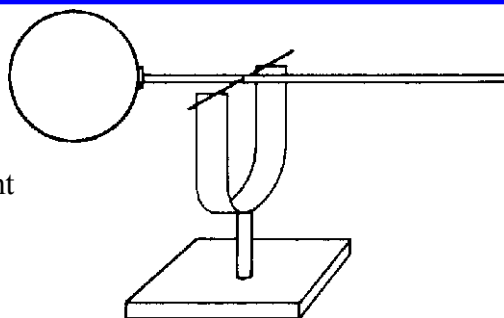

5 An experiment with a balloon

Partially inflate a small rubber balloon and close it with a rubber band. Place the balloon in the receiver and remove some of the air with your pump.

6 An experiment with a bottle and cork

Tightly close a small bottle with a cork or rubber stopper. Place the bottle inside the receiver and remove some of the air with the pump. What happens? How do you account for this?

7 Moving water by reducing air pressure

Secure two small bottles. Fill one about half full of water and close it with a one-hole stopper carrying a length of glass tube that reaches nearly to the bottom of the bottle. Attach a short length of rubber tube which empties into the other bottle. Place these in the receiver jar and remove some of the air with the pump. What happens? How do you account for this? If you wish, you may colour the water with ink.

8 Another balloon experiment

Stretch a rubber balloon over the neck of a small bottle. Place it in the receiver jar and remove some of the air with the pump. What happens? How do you account for this?

9 To study the relation between volume and pressure of air

Obtain a rubber bung or 'door stop' which just fits inside a narrow glass jar or measuring cylinder. Attach it to the lower end of a wooden rod. Fit a tin lid to the upper end of the rod to act as a scale pan. Lubricate the piston so formed with a little vaseline or heavy engine oil. Use the piston to trap air in the jar; put different weights on the pan and measure the volume of air inside the glass cylinder for each weight. Note that the volume is in inverse proportion to the pressure.

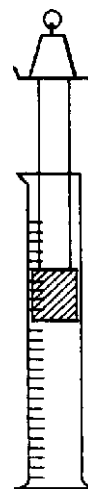

J. AIR IN THE HUMAN BODY

1 How the lungs work

Cut the bottom off a large bottle. Fit a cork to the neck with a Y tube in it. On each of the lower limbs of the Y tie a rubber balloon or some small bladder.

Tie a sheet of brown paper or sheet rubber round the bottom of the jar, with a piece of String knotted through a hole and sealed with wax. Pulling this string lowers the diaphragm and air enters the neck of the Y piece causing the balloons to dilate.

Pressing the diaphragm upwards has the opposite effect.

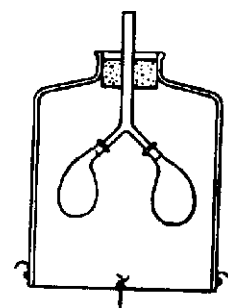

2 To measure the volume of air in the lungs

Invert a bottle full of water so that its neck is under the surface of water in a jar. Introduce a glass or rubber tube into the neck and blow one full breath of your lungs into the bottle.

Adjust the level of the water in the bowl so that the pressure of the air in the bottle is the same as that of the atmosphere, and stick a piece of gummed paper on the side of the bottle. Remove the bottle and measure the volume of water required to fill it to this mark.

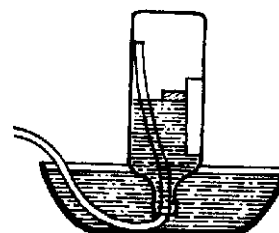

3 To show that expired air contains carbon dioxide

The two flasks are connected so that when you breathe through the T piece, all the air bubbles through the lime water in the flasks. One tube is closed with the finger while the air is drawn in; the other tube is closed when it is expelled.

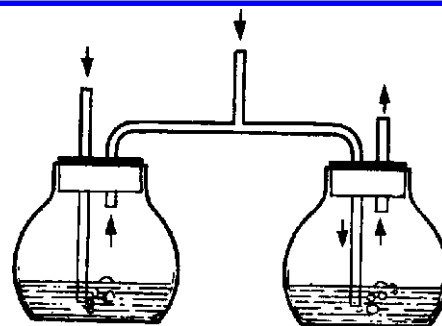

B. TO STUDY SOME CHEMICAL EFFECTS OF AIR

1 Wash a small wad of steel wool in gasoline, benzine or carbon tetrachloride (car- bona) to remove any grease. Squeeze it out and then fluff it. As soon as it is dry, place the steel wool in a flask fitted with a one-hole stopper carrying a 40 cm length of glass tube. Stand the flask and tube in a jar of water with the end of the tube under water. Observe for a few hours. What happens? How do you account for it?

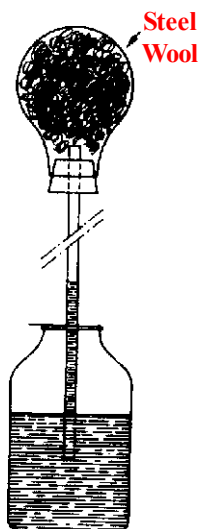

2 Repeat experiment 1, but this time place the steel wool in a small jar or test tube and place in water. Allow to stand for 24 hours. What do you observe? How much of the air in the jar has been replaced? How did the steel wool appear after the experiment? How do you account for what happened?



3 Hang a muslin bag of iron nails, or tin- tacks, from a cork in the top of a lamp chimney. Stand the chimney in a saucer of water. After a time the water will rise up the tube.

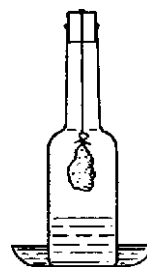

4 Counterpoise a steel rule or a piece of iron on a knife edge using a brass weight or a stone. Leave in moist air or on a window sill for a few days and notice the effect of the rust on the longer arm of the lever.



5 Without elaborate equipment it is almost impossible to prove that oxygen is necessary for burning. Yet there are many experiments which show the need for a continuous supply of fresh air to maintain combustion. These experiments will encourage the scientific attitude and help develop habits of critical thinking if carefully drawn conclusions and limited generalizations are made from them. After a suitable background has thus been established, the role of oxygen in burning can be explained.

Attach cardboard bases to several candles so that they stand upright. To do this cut new or used candles into pieces two or three inches long and chip off one end of each so that the wick projects about a quarter of an inch. Ignite a candle and hold it sideways so that melted wax drops off. Drip three or four drops on the centre of several pieces of cardboard. Hold the short candles against these until the wax hardens.

Invert a glass jar over a burning candle held upright by the cardboard candle holder. When the flame disappears, ask pupils for conclusions. Accept no conclusions that are not justified by the evidence. Now ask the class to propose conclusions which they can really justify. After several have been suggested, accept the conclusion that a candle will not continue to burn in a small closed space.

6 Direct four pupils to invert, at a given signal, four glass jars over four burning candles. Half-pint, pint, quart and gallon jars or some similar gradation of sizes may be used. Caution should be observed by the teacher as well as by the pupils in drawing conclusions from this experiment.

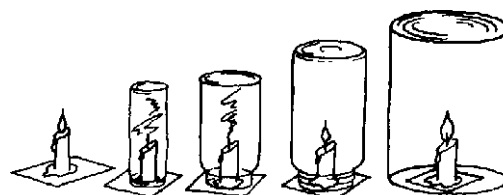

7 Fix a piece of candle to the bottom of a shallow pan with melted wax. Put water in the pan to a depth of 2.5 cm or 3 cm. Light the candle and invert a small, straight-sided jar over the candle. When the experiment is over, use a ruler and note the distance the water moved up the jar. Repeat the experiment using jars of different sizes. What do you observe? How do you account for this?

8 A small ignition tube (or a piece of ordinary tubing sealed off to make a 5-cm test tube) should be half filled with potassium permanganate. After connecting a delivery tube it should be heated strongly. The oxygen gas given off can be collected over water in a soup plate.



9 Oxygen may also be prepared by heating a mixture of five parts potassium chlorate to one part manganese dioxide in the same apparatus as is used in experiment 8.

10 Into a 100-ml bottle pour about 25 ml of hydrogen peroxide (ordinary drugstore or chain-store peroxide works very well but the kind used for bleaching hair gives off much more oxygen). Add a teaspoonful of manganese dioxide, cork the bottle loosely and leave it for a few minutes. The tiny bubbles that escape from the peroxide are bubbles of oxygen. To test the gas in the bottle for oxygen, light a long wooden splinter and blow out the flame. Remove the cork from the bottle and insert the glowing splinter into the gas inside the bottle. The splinter should burst into flame.

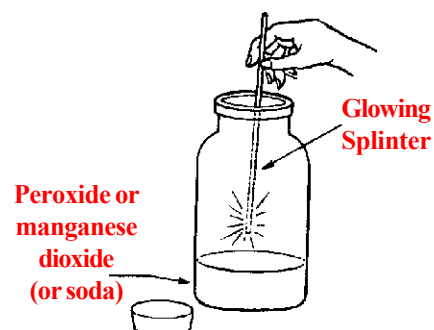

Instead of manganese dioxide, ordinary baking soda may be used to drive off the oxygen from the hydrogen peroxide, but this reaction takes a little longer.

11 Hold the end of a piece of twisted picture wire in a hot flame until it begins to glow. Then quickly lower it into a bottle containing oxygen and watch the iron wire burn. A bit of powdered sulphur on the end of the wire will help.

12 Place a piece of fine steel wool in a metal tray. Ignite the steel wool with a match. The steel burns because it is in very thin strips; the oxygen of the air is in contact with much of the surface.

13 Fasten a strand of steel wool to the end of a wire. Ignite it by holding it in a flame and quickly lower it into a bottle containing oxygen. Notice that it burns more rapidly in oxygen than it does in air.

14 Carbon dioxide may be prepared either from baking soda or marble chips together with a diluted acid. It should be collected by allowing the gas to run into dry bottles or containers which should be covered with glass or cardboard plates.

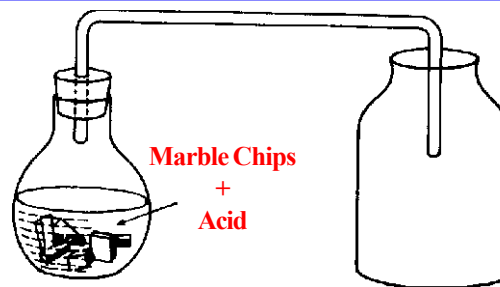

15 Plunge a burning wood splint into a bottle of carbon dioxide. Does carbon dioxide support burning?

16 Fix a candle in the bottom of a wide glass jar with melted wax. Light the candle and pour carbon dioxide from another jar into the jar with the lighted candle. What does this show about the density of carbon dioxide?

17 Prepare clear lime water by stirring some slaked lime in water (see Chapter XVIII). Let the mixture stand for a day and then siphon the clear liquid into a bottle. This is lime water. Let some carbon dioxide from the generator used in experiment 14 bubble through clear lime water. What do you observe? This is a chemical test for the presence of carbon dioxide.

18 Burn a candle in a glass jar until it goes out. Remove the candle and pour in some clear lime water. Shake well and observe. What did you see? What is one of the products of burning from a candle? Repeat using burning wood and paper.

19 Let a burning candle, a piece of burning wood and some burning paper come into contact with a cool, shiny can. What do you observe? What do you believe this to be? Place a basin of cold water over a gas or kerosene flame. After a moment remove and look at the bottom. What other substance is a product of burning wax, wood and paper? Is the substance produced the same as before?

20 A model fire extinguisher can be made from an old ink bottle fitted with a cork and tube. Half fill it with sodium bicarbonate solution and float in it carefully a small pill bottle of sulphuric acid.

To operate the extinguisher shake the bottle so that the acid mixes with the bicarbonate, releasing CO_2 .

Aluminium sulphate used instead of the acid provides a foam, especially if a little soap solution is added.

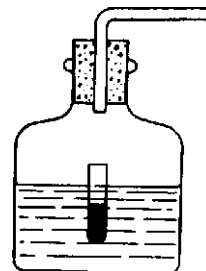

L. EXPERIMENTS WITH AIR STREAMS

When air is moving, air pressure is less where the velocity of the stream is high and greater where the velocity is low. The following experiments apply this principle.

1 Suspend two apples, oranges or ping pong balls on threads at least one metre in length. The suspended objects should be on the same level and should hang about 10 or 15 cm apart. Blow a steady stream of air between the objects and observe what happens. Where was the air stream moving fastest? Where was the pressure reduced? How do you account for what happened?

2 Place a ping pong ball inside a funnel. Blow hard through the stem of the funnel and see if you can blow the ball out of the funnel. Invert the funnel and hold the ping pong ball in the end. Blow hard through the stem and see what happens as you remove your hand holding the ball. Place the ball on a table. Cover it with the funnel. Blow through the stem and see if you can pick the ball up from the table. How do you explain your observations?

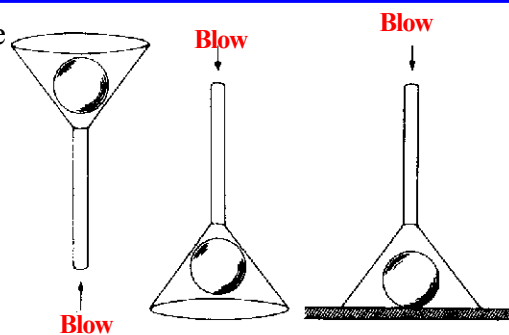

3 Make a bridge from a piece of thin cardboard, 20 cm x 10 cm. Bend down about 2 cm on each end. Place the bridge on the table and try to blow through the arch. The harder you blow the greater the force holding it to the table top.

4 Cut a piece of thin cardboard about 7 cm square. Draw diagonals from each corner and put a common pin through the card where the lines cross at the centre. Secure the head of the pin by covering it with a bit of Scotch tape. Place the pin in the hole of an empty thread spool and try to blow the card from spool by blowing through the hole. Turn the spool and card upside down. Hold the card against the spool lightly with a finger. Blow through the spool, then remove the finger. How do you account for this?

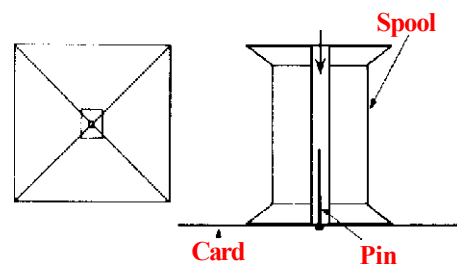

5 Light a candle and hold it behind a card about 5 cm wide. Blow hard toward the card and observe the movement of the flame. How do you account for your observations?

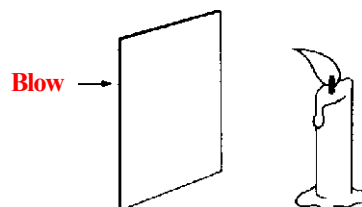

6 Place a lighted candle on a table. Place a bottle in front of the candle. Blow hard against the bottle and observe the flame.

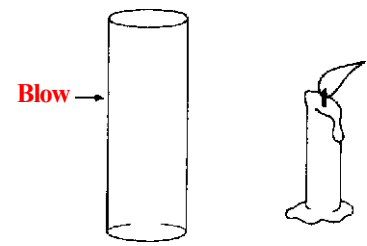

7 Attach a funnel to a source of compressed air such as a vacuum sweeper. Blow up a balloon and place a piece of copper wire around the neck for a weight. Turn on the compressed air and balance the balloon in the air stream. Try also to balance a ping pong ball between the balloon and the funnel.

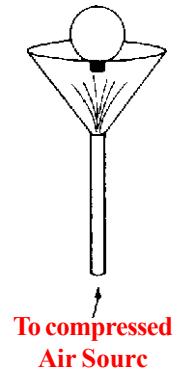

8 Obtain two glass tubes or two transparent soda straws. Place one tube in a half glass of coloured water. Place the second tube at a right angle with the first one so that the ends of the two tubes are close together. Blow through the horizontal tube and observe the water level in the second tube. How do you account for the result? Note that the same principle is applied for an atomizer, a DDT or paint sprayer.

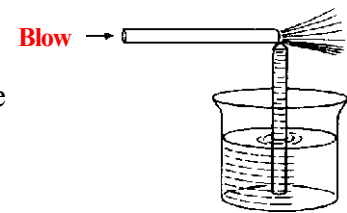

9 Take a strip of paper about 30 cm long and 4 cm wide. Fold the paper about 4 cm from one end. Crease the fold well. Now hold the short end of the fold against your chin with the crease about level with your lips. Blow hard across the top surface of the paper and observe what happens. How do you account for this?

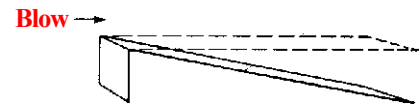

10 Hold your hand flat outside the window of a moving automobile. Then slightly raise the front edge of your hand and notice the lifting effect of the air stream.

11 Make an airfoil section (section of an airplane wing) by folding and gluing a piece of paper as shown in the diagram. Suspend the airfoil section on a pencil or smooth, round rod. Blow a stream of air so that it strikes the leading edge. What do you observe? Can you explain the lift?

A similar airfoil section can be made from sheet metal. It can be attached to one end of a large knitting needle with a cork or piece of dowelling. A notch cut with a file in the middle of the needle can be used as a balancing point, with a bent pin or nail as its pivot. If the beam is balanced with a counterweight, the lift is very easily shown by blowing on the leading edge of the airfoil through a paper tube.

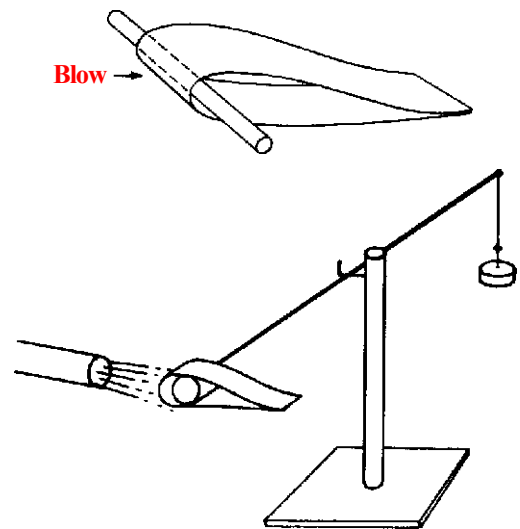

**“BE A GOOD SCIENTIST. FOLLOW INSTRUCTIONS EXTREMELY CAREFULLY.
WEAR PROTECTIVE CLOTHING WHEN WORKING ON ANY EXPERIMENTS
THAT INVOLVE FIRE OR EXPLOSIONS.”**

CHAPTER VIII

Experiments and materials for the study of weather

A. MAKING WEATHER INSTRUMENTS AND A WEATHER STATION

Weather is a topic that is close to the life of every child. Even at the lowest levels of primary instruction, observations of the weather may be made from day to day. At the intermediate levels a simple weather station may be set up in the classroom. At the level of general science and later, a more detailed study of the causes of weather phenomena may be made. At all stages of the work it is an advantage to represent readings and observations in graphical form whenever this is possible.

1 An aneroid barometer

A small wooden box such as a cigar box serves well to contain a simple aneroid barometer. Bore a 1-cm hole in the middle of the side to which the cover is hinged. For the pressure mechanism you may use a glass jar with a piece of thin rubber stretched over it and secured as instructed in experiment E 6. . A somewhat better mechanism can be made from a plastic or tin oilcan of the type shown below.

Squeeze the oil-can to force out a little of the air and then seal the end, with plastic cement if a plastic oilcan is used, or solder if it is metal. This pressure mechanism must be absolutely air-tight; so, after the cement or solder has set, try it under water to see if there are any air leaks. If you find some, squeeze out some air and then seal the leaks. Cement the pressure mechanism to the inside of the box so that the centre of the round part falls exactly under the hole you have made in the other side.

Tie a 30cm length of thread to a short length of match stem and cement to the centre of the pressure mechanism. Cut a piece of metal from a tin can about 1 cm wide and 9 or 10cm long. Bend at right angles about 1.5-cm from each end of the piece.

With a nail, punch a small hole in the ends of the piece a little way from the top and in the centre. Enlarge the holes so that they will let a small nail or knitting needle turn easily in them. Glue a broom bristle to one end of the needle to serve as a pointer. Securely fasten the metal piece on top of the box so that the needle-axle is across the centre of the hole. Have the broom splint move over the back of the cigar box but not touch it.

Next put the end of the thread from the pressure mechanism up through the hole. Wind it about the needle axle several times and then tie it to a rubber band. Be sure that the thread from the axle to the pressure mechanism is tight. Stretch the rubber band just enough to place a slight tension on the thread and fasten it to the end of the cigar box with a thumb tack. You may have to change the tension.

Mark off a scale like the one shown and fasten it under the pointer to the back of the cigar box. Arrange the pointer so that it is at the centre of the scale. Set your barometer where you can observe it. As the pointer changes, you can adjust the tension in the rubber band so that it moves properly over the scale. Place the words 'rising' and 'falling' on the proper side of the scale. This is a very sensitive barometer and will clearly indicate changes in air pressure.

Note reference to other types of barometer in Chapter VII.

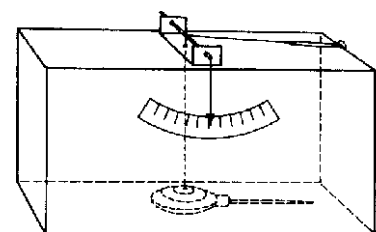
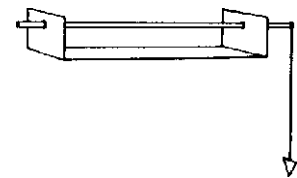
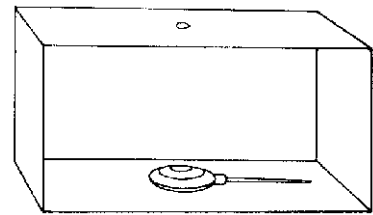

2 A wind vane

A wind vane is used to tell the direction of the wind. Secure a piece of wood about 25 cm in length and 1 cm square. With a saw, cut a slot in the centre of each end of the stick, 6 cm deep.

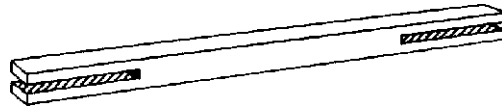

Next select a thin piece of wood about 10 cm wide which will fit tightly in the slots. From this cut two sections, one the head of an arrow and the other the tail, as shown below.

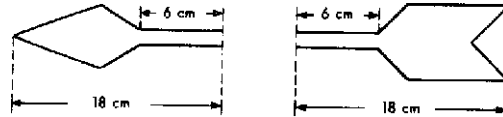

Push the head and tail of the wind vane into the slots and fasten them either with glue or with small nails.

Next balance the wind vane on the blade of a knife and mark the place on the stick where it balances. Secure the glass part of a medicine dropper and close the small end by rotating it in a gas or alcohol flame. At the place where the vane balanced, drill a hole, just slightly larger than the medicine-dropper tube about three-quarters of the way through the stick. Put the small end of the tube up in the hole and fasten it securely with glue or putty.

To make a supporting rod for your wind vane select a piece of soft wood about a metre in length and drive a small nail in the top. With a file, sharpen the end of the nail to a point. Place the medicine dropper over the nail and mount your wind vane on top of a building or on a pole where it is exposed to the wind from all directions.

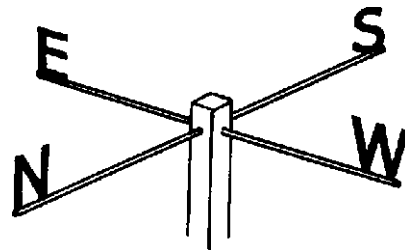
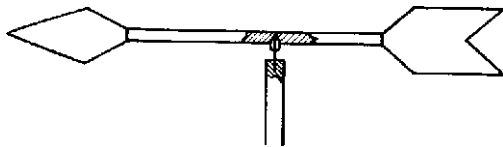

Fix stout wire arms to the pole and bend the symbols N, E, S, W at the ends, or solder to each free end large letters cut from sheet metal.

3 A wind speed indicator

Select two pieces of light wood about 50 cm long and 1 cm square. Cut a notch 1 cm wide and about 0.5 cm deep at the exact centre of each piece.

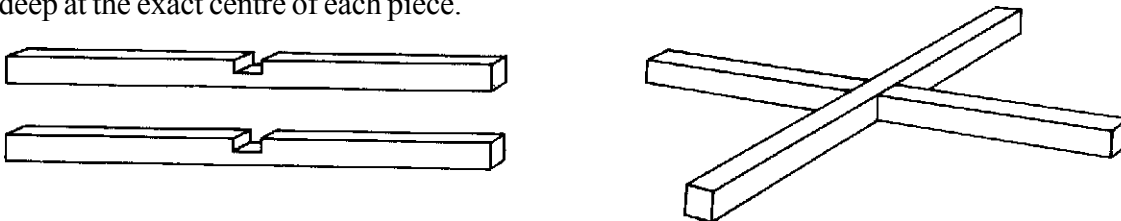

Next fit the sticks together at the notches to form cross arms.

Obtain the glass tube from a medicine dropper and close the small end by rotating in a gas or alcohol flame. At the exact centre of the cross arms drill a hole about three quarters through the wood and set the medicine-dropper tube securely in the hole with cement or putty. Secure four cigarette tin or small plastic dishes and fasten them to the ends of the cross arms with small nails or screws. Be sure the cups are all facing in the same direction. Prepare a mounting stick for the wind indicator in exactly the same way as you did for the wind vane. Drive a nail in the end of the stick and sharpen it to a point with a file.

Your wind speed indicator will spin in the wind. You can get a rough idea of the speed of the wind in miles per hour by counting the number of turns made in 30 seconds and dividing by 5. If you wish the result in kilometres per hour you divide again by 0.62.

Another way to determine the wind velocity is to have some one drive you in a car on a calm day. Hold your speed indicator out of the front window and have the driver go steadily at five miles per hour. Count the number of turns in 30 seconds for this speed. Repeat with the driver going at 10, 15, 20, 25, 30, 40, etc, miles per hour.

4 A rain gauge

Mount your wind speed indicator in a place that is exposed to the wind from all directions. 4 A rain gauge It is easy to make a simple rain gauge using a funnel and bottle, with a measuring cylinder to measure the volume of water.

The funnel should have either a very sharp vertical edge, or a horizontal lip to prevent raindrops bouncing out again. The whole apparatus should be buried so that the funnel is a few centimetres above ground level.

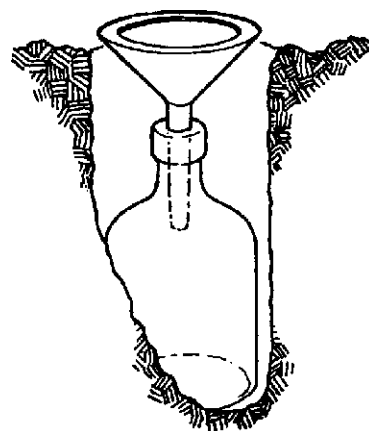

5 Another rain gauge

Procure a large tin can about 10 cm in diameter and 14 cm in height. Almost any can will do. Next secure a straight-sided bottle, such as an olive oil bottle about 3 cm in diameter and at least 25 cm high, that will stand inside the larger can. Place the larger can on a level table and pour water into it until the water is exactly 1 cm deep on a ruler. Paste a strip of paper about 1 cm wide the length of the tall straight-sided jar. Next pour the water from the larger can into the tall jar and make a mark on the paper strip at the level where the 1 cm of water from the larger can comes. Measure the distance from the inside bottom of the tall jar to this mark and mark off equal spaces to the top. Divide the distances between the marks into 10 equal parts to measure millimetres. The small jar will measure small amounts of rainfall.

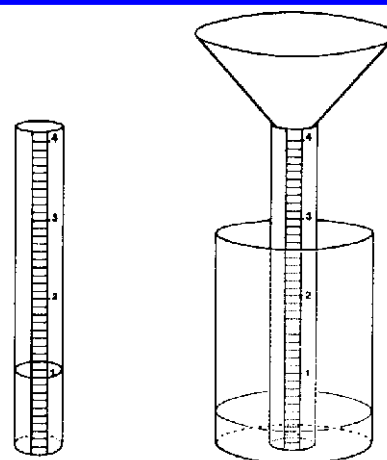

To assemble the rain gauge place a funnel in the tall jar and then place these in the larger can. Set the rain gauge in an open spot where it will not be easily upset. If the rainfall is light it can be measured by the small jar alone. If it is heavy, excess water will overflow into the larger can and may then be measured by pouring it into the bottle. If the rainfall is to be measured in inches, pour 1 in. of water in the large can and then pour this into the tall jar. Mark the depth to which the 1 in. of water reaches and then divide the scale accordingly.

A better way to determine the rainfall in centimetres or inches is to graduate the smaller measuring bottle in terms of its radius and the radius of the collecting funnel by use of the formula:

$$\text{Height in bottle for cm or inch of rainfall} = (\text{Radius of funnel})^2 / (\text{Radius of bottle})^2$$

6 A wet and dry bulb hygrometer

Obtain two inexpensive thermometers, and check them in warm water at different temperatures to see that they agree. Attach the two thermometers to a piece of board, about 10 cm apart, with their bulbs projecting and exposed to the air.

Place a small bottle just under the thermometer on the right-hand side. Fasten a wick made from linen cloth or muslin around the exposed bulb and let it dip into the bottle. The bottle should be filled with rain water. This device will help you measure the relative amount of water in the air at any given time. Hang the instrument where it has free access to the air. Fan the wet bulb until the temperature will go no lower. Make a reading of both the wet bulb and the dry bulb. Subtract the wet bulb reading from the dry bulb reading and then look up Table VI to find the relative humidity. If your reading from the table is 40 it means that the air at that time holds only 40 per cent of the water vapour it could hold at the dry bulb temperature.

7 A hair hygrometer

This device will enable you to read the relative humidity directly without the use of tables.

Procure a few human hairs about 30 cm long. Free them from grease with dilute caustic soda solution. Fix one to the upper end of a stand and stretch it with a 50 gm weight. The hair should pass two or three times round a spool fixed to an axle which is free to rotate in bearings made from a piece of tin and fastened two-thirds of the way down the stand. Fix a light pointer of balsa wood to the axle, and arrange a postcard to act as a scale. For greatest sensitivity the diameter of the spool should be small.

Changes in atmospheric humidity will affect the length of the hair and the position of the pointer.

To mark off the scale it is best to compare your hygrometer with a standard one. If one of these is not available place the instrument above some warm water in a pail and cover with a wet towel. When the pointer has moved as far as it will, mark this point 100 on your scale for the air in the pail will be 100 per cent saturated. Other points can be marked by taking readings on your wet and dry bulb hygrometer. Find the relative humidity from Table VI (page 245) and mark the position of the pointer on your scale accordingly. When you have established about three points on your scale you can then divide the rest into equal divisions and mark them off at 5 interval markings from 5 to 100.

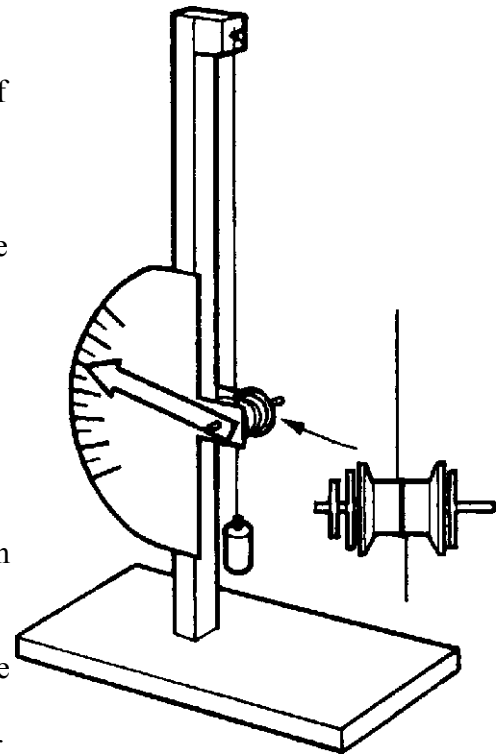

8 A weather house

Changes in the amount of water vapour present in the atmosphere can be indicated by variation in tension in a few strands of human hair or by using the hygroscopic properties of a piece of catgut.

The familiar weather house can be constructed from cardboard. One end of the gut is glued to a piece of cork on the roof angle, the other end carries a horizontal platform on which figures can be mounted. The direction of twist of the gut can be found by trial. Two sides of the house should be open to prevent heat accumulation, and the outside should be painted white.

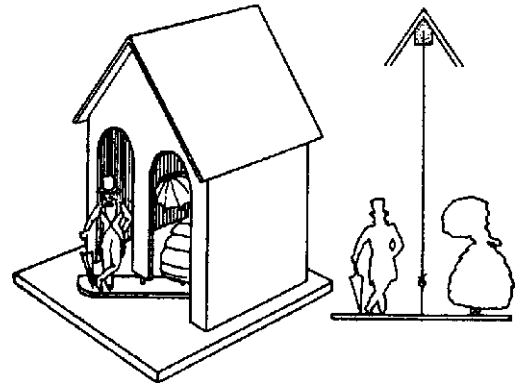

9 A weather picture

A piece of white blotting paper is immersed in a solution containing two parts cobalt chloride to one part common salt. While wet the paper will remain pink, but when dried in the sun or near a Bunsen burner it turns blue.

This is the basis of the weather pictures sold in the shops. A home made one works just as well. A picture containing sky or water can be cut from a book and an inset of this prepared blotting paper made to replace say, the sky. The picture should then be mounted on a card and hung near a window where it will quickly respond to changes in the hygrometric state of the atmosphere.

10 Keeping a weather record

Some kind of scale of intensity is necessary when keeping a record of the weather.

The date, hour, temperature, sky, and wind can all be recorded in a table.

It is better to take the readings at the same time each day.

If no thermometer is available, a suitable temperature scale is: hot, warm, moderate, cool, cold, very cold.

There are international weather symbols, but abbreviated scales can be used unless the records are for some official purpose.

The velocity of the wind can also be recorded.

Light—moves smoke, but not wind vanes.
 Moderate—raises dust and just moves twigs.
 Strong—large branches move.
 High—blows dust, papers and moves whole trees.
 Gale—breaks off twigs from trees.

Date	Time	Temperature	Sky	Wind	Rain

The direction of the wind can be indicated by an arrow in the column, but it is interesting to construct a paper star as shown in the diagram and to draw a line each day along the arm which most nearly coincides with the direction of the wind.

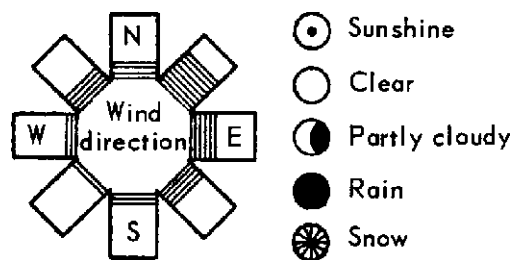

11 Making a housing box for weather instruments

Some of your weather instruments must be exposed to the weather. Among these are the wind vane, the wind speed indicator and the rain gauge. It is wise to protect metal parts of these instruments with either grease or paint. Aluminium paint works very well for this purpose.

Other instruments such as the barometer, the thermometer, and the hygrometer, need to be shielded from rain and wind. These may be placed in a wooden box which has no top. Place the instruments in the box so that one of the closed sides forms a roof and another a floor for your house. The open side should be fitted with louvers, such as are found in a window blind, for best results. This will provide a free access of air but will protect the instruments from wind and precipitation.

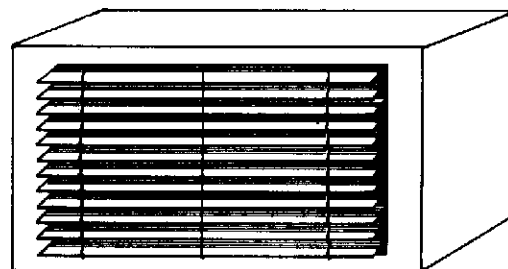

B. WINDS AND WEATHER

1 Air expands when heated

To show that air expands when heated, fit an electric light bulb flask or a bottle with a one-hole stopper or cork which has a 30-cm length of glass tubing or a soda straw through it. Place the end of the tube in a small bottle of water. Heat the flask and observe what happens. Heat the flask until a considerable amount of air has been removed and then cool the flask by pouring cold water over it or by rubbing with a piece of ice. What do you observe? How do you account for this?

2. Another way to show that air expands when heated

Snap a toy balloon over the neck of a small bottle and place the bottle in a pan of warm water. What do you observe? How do you account for this?

3 Expansion of air

Connect a one-hole rubber stopper carrying a short length of glass tube into a 2 or 3 litre can with a narrow opening. Attach a rubber tube to the glass tube. Invert a bottle of water in a basin of water and put the end of the rubber tube under the edge of the bottle. Heat the can. What do you observe? How do you

4 Cold air is heavier than warm air

(a) Make a simple balance as you did in experiment C 1, for showing the weight of air. Secure two paper bags that are the same size. Open the bags and attach a 20 cm thread to the bottom of each one with a piece of Scotch tape or by making a hole in the bottom of the bag, inserting the thread and then tying a knot in the end. Make a loop on the other end of each thread that will go over the ends of the balance rod. Place a bag near each end of the rod. Move the bags in or out until they are in exact balance. With a candle heat the air well below one of the bags. What do you observe? Let the balance stand for several minutes. What happens? Now heat the air under the other bag. Observe what happens. How do you account for this?

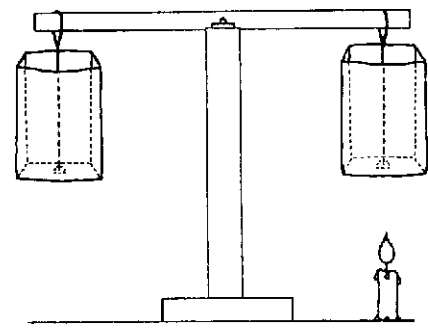

(b) Another way to study the difference in weight between warm and cool air is to use flasks on the balance rather than paper bags. Attach the flasks with loops of string. Move them until they are in perfect balance and then heat one flask gently. Observe the effect. Allow to cool to room temperature. Observe and then heat the other flask. Flasks made from old light bulbs work very well for this experiment.

5 A convection box

A box to show why winds blow may be made easily. Use a wood or pasteboard box for which you can secure a pane of glass, the correct size to make a tight window. A wood chalk box which has grooves for a cover works very well. Cut the glass so that it will slide in the grooves. Next bore two holes in one of the long sides of the box, one near each end. The holes should be from 2.5 to 3 cm in diameter. The box must lie with this side up. Secure two lamp chimneys to place over the holes. If lamp chimneys are not available you can use pieces of mailing tube about 15 cm in length. Place a short piece of candle on the floor of the box just under one of the chimneys. Light the candle. This represents a land area that has been heated by the sun. Close the window and, with a piece of smoking paper, trace the air current in each chimney. Observe the movement of air inside the box. Move the candle under the other chimney and repeat. What do you observe? How do you account for this? This is called a convection current. Another way to study the difference in

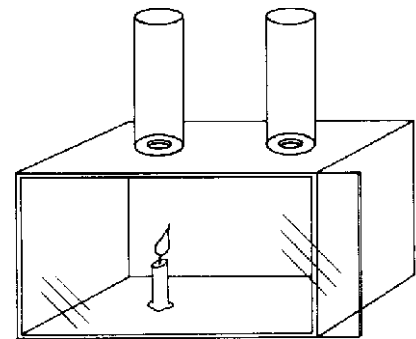

6 Tracing convection currents

(a) Shield a burning candle to protect it from stray air currents. Trace the air currents about it with smoking paper.

(b) Open a door a little way between a warm and a cool room. With a piece of smoking paper explore the air currents about the opening at various levels above the door.

(c) If you can, explore the air currents in a room that is heated with a radiator or a stove.

(d) Explore the air currents in a room that is ventilated with windows open at the top and at the bottom.

(e) Lower a lighted candle into a milk bottle by means of a wire. Observe what happens. Ventilate the bottle with fresh air. Again place the lighted candle in the bottle but this time separate the warm and cold air currents by a piece of cardboard cut in the shape of the letter T as shown in the diagram. Explore the air currents on each side of the cardboard with smoking paper.

(f) Cut out a metal can top with a rotary opener so as to have a metal disk. Punch a depression in the exact centre. Cut along radial lines almost to the centre and give each of the blades thus formed a twist in the same direction. Mount the wheel on a pointed wire and hold it over a candle or other source of heat. A carefully made wheel of this kind will also turn over a radiator or a lighted electric lamp.

Place a metal foil top from a milk bottle on a piece of blotting paper with the flat side down. Press the point of a ball pen into the middle to make a dent. Cut 'petals' in the turned-up edge to form the vanes of a turbine. Pivot it on a pointed wire or on a needle stuck eye downwards into a cork. This is more sensitive to convection currents than the apparatus described above.

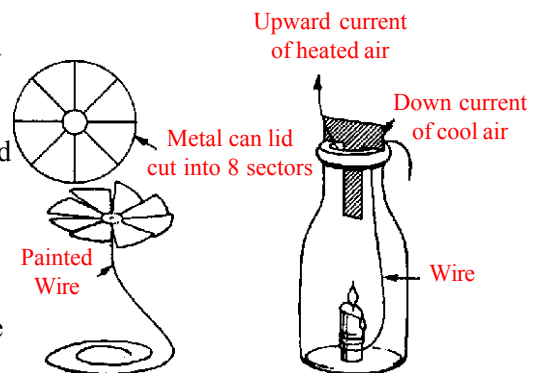

C. HOW MOISTURE GETS INTO THE AIR

1 You cannot see atmospheric moisture

Place some water over a fire in a vessel that has a spout such as a tea kettle or copper pot. If these are not available, fit a flask with a one-hole stopper and place a right-angle bend of glass tubing in it. Place some water in the flask and put it over a flame. When the water is boiling and steam issues from the spout, observe the cloud that is formed. This is not steam, but condensed water. Observe the space next to the spout when the steam comes out. Can you see it? Now hold a candle or a burner in the cloud of condensed steam. What do you observe? Where does the moisture go?

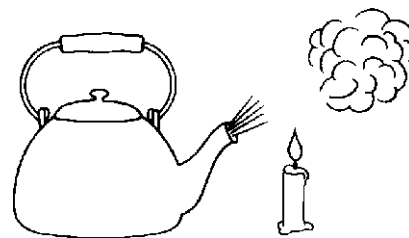

2 The mop weighs less

Put a floor mop in water. Wring it out and then balance it on a triangular file placed on the corner of a table. Be sure you have it carefully balanced. Look at the mop an hour later. What has happened? How do you account for this? Where has the water gone?

3 Weighing moisture again

The same experiment can be done with a bath towel. Wet the towel and wring it out. Hang it on a coat hanger. Hang the coat hanger on one end of a long stick balanced over the corner of a table on a triangular file.

4 Moisture evaporates from soil

Fill a flower pot with moist soil and place it on a pair of scales. Either balance the pot of soil with weights or observe its weight. Observe its weight again after 24 hours.

5 Moisture comes from home plants

Place a cellophane bag over a leaf of some house plant or garden plant and close the end about the stem with a rubber band. Make an observation after one hour. What do you observe? Where did it come from?

6 Moisture comes from other plants

Secure a flower pot which has some bean or pea seedlings that are 10 or 15 cm in height. Cover the top of the pot with cellophane or sheet rubber, pinning it closely around the stems of the plants so no soil is uncovered. Invert a clean, dry glass jar over the plants and observe after an hour. What do you see? Where did it come from?

7 Moisture from breathing

Moisture coming from breathing may be shown by blowing on a cool mirror or into a cool glass or bottle.

8 Moisture from a gas flame

Moisture coming from a flame may be shown by placing a pan of cold water over a gas stove for a few moments. Remove the from the fire and observe the bottom.

9 Moisture from other flames

Bring the flame of a candle near a cool black-board. Repeat using the flame of a gas burner, the flame from an alcohol lamp, the flame from a piece of burning paper, and the flame from a piece of burning wood. What do you observe? Where did it come from?

10 Area affects the rate of evaporation

Measure 50 ml of water and pour it out into a container of much larger diameter than the graduate. Again measure 50 ml in the graduate. Place them side by side where the temperature and air movements will be the same. On the following day measure the amount of water in each container. What causes the difference in evaporation?

11 Temperature effects the rate of evaporation

Warm a spot on a blackboard or slate by using a candle or by placing in the sun. Place water spots of equal size on this warm area and on a cool area. Observe the spots and see what happens.

12 Moving air affects the rate of evaporation

With a moist sponge or cloth, make spots of equal size on a cool blackboard surface at some distance apart. Fan one spot with a piece of cardboard and leave the other to evaporate without fanning.

What causes the difference in rate of evaporation ?

13 Moisture in the air affect the rate of evaporation

Fasten some cloth over a wooden hoop or frame that is about 30 cm square and about 3 cm thick. Wet the cloth. Next make two wet spots on a cool blackboard surface with a sponge or cloth. Cover one with the frame carrying the wet cloth and leave the other one open. After a few moments observe both spots. Which has evaporated the faster? How does moist air (under the frame) affect the rate of evaporation?

D. HOW MOISTURE COMES OUT OF THE AIR

1 Moisture condenses on cool surfaces

Place some ice in a shiny tin can. After a little while observe the outside of the can. What do you observe? Where did it come from?

2 The Water Cycle

Heat some water until it is near the boiling point. Place it in a drinking glass and rotate the glass so as to moisten the sides right to the top. Place some very cold water in a round flask, such as one made from an electric bulb or a Florence flask. Place the flask on the glass at an angle as shown. Water will evaporate from the hot water condense on the cool surface of the flask and fall back in droplets into the glass. Here you have evaporation, condensation and precipitation. You have seen the water cycle as it goes on in nature.

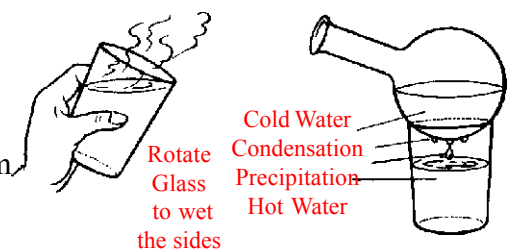

3 Dew-point temperature

You can measure the dew-point temperature with a shiny can containing some water, a thermometer and some ice. The dew-point temperature is an important weather observation. It is the temperature at which the moisture in the air begins to condense. The dew-point temperature changes from day to day.

Be sure that the outside of the can is dry and shiny. Place some water inside the can and then stand the can on a page of printing so that the printing is clearly reflected from the can. Place the thermometer in the can. Now add ice, a little at a time, to the water and carefully stir with the thermometer. Keep close watch of the temperature and read the thermometer at the temperature where dew begins to form on the outside of the can. This will be near the dew-point temperature.

4 A cloud in a bottle

You can make a cloud form in a bottle. Obtain a large glass bottle and fit with a rubber stopper carrying a 10-cm length of glass tubing. Place about 2.5 cm of warm water in the bottle and dust a little chalk dust into the air inside. Connect the glass tube to a bicycle pump with a piece of rubber tubing. Hold the stopper in the bottle and have a pupil pump air in. When the air has been compressed inside the bottle let the stopper blow out and observe what happens. If you do not get a good cloud, introduce a little smoke from a smouldering match or cigarette. When the air expands it cools, thus reducing the temperature in the bottle below the dew point. The moisture condenses as a cloud. When warm air rises above the earth the air pressure is reduced. The air expands, cools and clouds form when the cooling goes below the dew point. covered with a beautiful white frost.

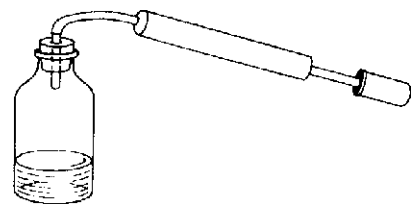

5 The rain cycle

You can reproduce the rain cycle in miniature in your classroom. Place a box of plant seedlings on the table. Place a metal tray about 35 to 40 cm above the box of seedlings and support it. Strew the top of the tray with pieces of cracked ice. Place a tea kettle or flask containing water over a source of heat so that steam will issue between the seedlings and the tray. You are now ready to study the rain cycle. The tea kettle or flask serves as the earth source of water. This evaporates and rises up to the cool tray which represents the upper layers of air above the earth which have been cooled by expansion. Here the moisture condenses on the tray and drips back on to the seedlings as rain.

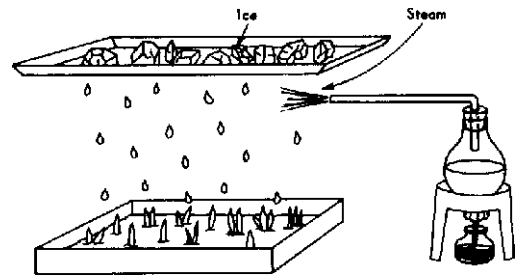

6 Frost in the classroom

Frost can be made in the classroom by using a tall metal container such as a tin can. Pack the can with alternate layers of ice and salt, using about twice as much ice as salt. Tamp the mixture with a stick as you pack it. When it is full, watch the outside of the can. Some dew will form and may freeze, but you should also be able to observe the delicate white frost which forms. When the can has stood for a while it will be

7 To study a hailstone

When it hails, collect some of the hailstones. Cut them in half and observe how the ice of the hailstone has been built up in layers. If you live in a region where snow falls, collect some snow-flakes on a piece of dark wool cloth and look at them with a magnifying glass. You will find them of many, many shapes, but always six-sided. Snow-flakes are among the most beautiful sights in nature.

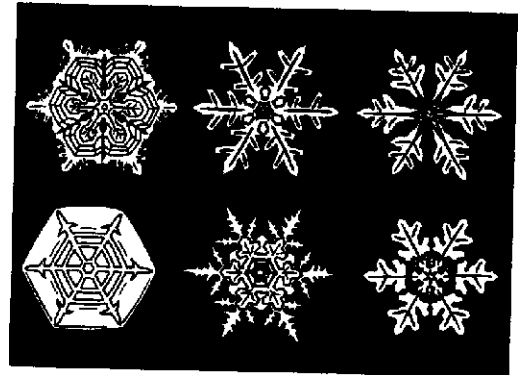

**“BE A GOOD SCIENTIST. FOLLOW INSTRUCTIONS EXTREMELY CAREFULLY.
WEAR PROTECTIVE CLOTHING WHEN WORKING ON ANY EXPERIMENTS
THAT INVOLVE FIRE OR EXPLOSIONS.”**

CHAPTER IX

Experiments and materials for the study of water

THE COMPOSITION OF WATER

1 How water can be decomposed

You will need a six-volt storage battery or accumulator or a battery of six dry cells for this interesting experiment. Remove the insulation from about 6 cm at each end of two lengths of copper wire each at least 30 cm long. Next secure the gold points from two old fountain pens and wrap the uninsulated end of one of the copper wires securely around each one. Cover the joint with sealing wax so that no copper is exposed. Connect one wire to each terminal of the battery. Fill a shallow glass cooking dish about half full of water. Fill two small bottles with water, place a piece of cardboard over the mouth and invert them in the dish of water. Stand each bottle on two thin strips of wood so that the mouth is raised from the bottom of the dish. Now carefully place one of the pen points up in each bottle.

Place about two tablespoonfuls of sulphuric acid in the water and give it a few moments to mix thoroughly. Be very careful in handling the sulphuric acid, as it will burn if it touches your skin, and it will make holes in your clothing if you spill it. You can obtain sulphuric acid at a drug store, a battery service station or from a chemical laboratory.

When all is ready turn on the current. This experiment may take some time to complete. Observe what happens in each bottle. If the bottles are the same size you can measure the results with a ruler. How do these compare?

When the bottles are filled with gas place a glass plate over the mouth of each one. Leave the one which filled more quickly mouth downward on the glass plate. Set the one which filled less quickly mouth upward with the glass plate still covering. Place a glowing splint in the bottle which you placed mouth upward. What happens? This gas is oxygen.

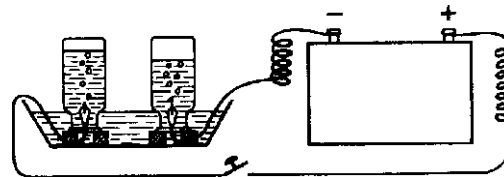

2 How oxygen can be prepared

Directions for preparing oxygen are given in Chapter VII.

3 Some experiments with oxygen

Directions for experiments with oxygen are given in Chapter VII.

4 How to prepare hydrogen

Hydrogen can be prepared from a dilute acid, such as hydrochloric or sulphuric, when it is chemically reacted with a metal such as zinc. The acid may be secured from a drug store. It should be handled carefully to avoid spilling acid on hands or clothing. Zinc can be secured from the outside container of an old dry cell. Clean the zinc thoroughly and cut into pieces about 2.5 cm square.

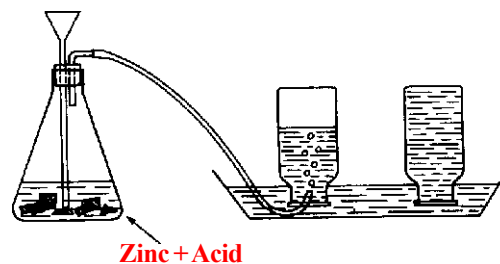

To make the hydrogen place the zinc in a flask or bottle fitted with a two-hole rubber stopper. Through one hole place a funnel tube that reaches nearly to the bottom. In the other hole place a tube with a right-angle bend and attach to it a 30 or 40 cm length of rubber tubing. Fill a pan about half full of water and invert bottles of water in the pan. Place the end of the delivery tube in a bottle to collect the hydrogen. Pour the dilute acid on the zinc through the funnel tube. Be sure to keep flames away from the generator; hydrogen mixed with air is very explosive. When the bottles are filled with hydrogen, put a glass plate over the mouth and stand them on the table, mouth down.

5 Does hydrogen burn?

6 What is produced when hydrogen burns?

7 Blowing soap bubbles with hydrogen

Mix up a strong soap solution that will make good soap bubbles. Place a small funnel tube or a clay pipe on the delivery tube. When you have a good action of acid and zinc in the flask, blow bubbles with the hydrogen. When each bubble has been formed a slight jerk will detach it from the funnel and it will rise to the ceiling. You can have a lot of fun trying to light the bubbles by placing a lighted candle on the end of a stick to reach them near the ceiling.

B. HOW WATER CAN BE PURIFIED

1 How to make a filter

A plant pot with a plug of cotton wool in the bottom and a layer of sand a few inches deep makes a satisfactory filter for many purposes as shown in Chapter II, experiment C 10.

Make some muddy water by stirring earth in a dish of water. Pour the water into the filter and catch it in a clear glass as it drips out. See if you can improve the filter by building it up with alternate layers of sand and powdered charcoal. Such a filter will work very well for clarifying water before it is boiled for drinking purposes.

2 How to make an experimental filter

Fit a one-hole stopper carrying a short length of glass tube into the small end of a lamp chimney. Put a little cotton wool in the bottom and then a layer of small clean pebbles. Wash some coarse sand well and place a layer above the pebbles. Next wash some fine sand and make a thicker layer in the filter. Grind up some wood charcoal and make into a paste with water. Pour the charcoal paste evenly over the surface of the sand. Secure some very muddy water and pour in the top of the filter. Collect the filtrate in a clean glass placed below the filter.

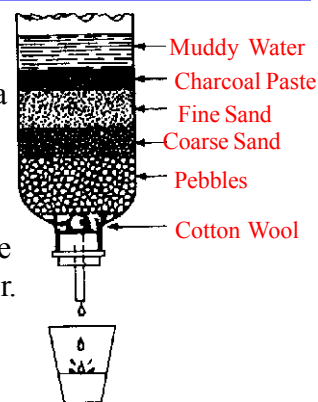

3 Sterilizing water by boiling

The presence of tiny living plants and animals makes water unsuitable for drinking. Such forms of life can only be seen through a microscope. We can study how boiling affects living things in a simple way. 'White of egg is known to be chemically very similar to the substance that makes up the bodies of living bacteria.

Fill a test tube or flask about half full of water and heat it to boiling. With a medicine dropper put a few drops of egg white in the boiling water. Observe that the egg white is changed completely. It becomes like egg white in a boiled or fried egg. We say it has coagulated. This is probably what happens to the living tissue of harmful bacteria when water containing them is boiled.

4 How to make a simple apparatus for distilling water

You can make a simple water-distilling apparatus from a flask, and a length of glass or rubber tubing. Fit the flask with a one hole stopper or cork which has a short length of glass tube through it. Either bend a 60 cm length of glass tube as shown in the diagram or use a piece of rubber tube. Attach this tube to the tube in the flask. Use a flask, or drinking glass or jam jar to collect the distilled water. Fill the boiling flask about half full with muddy water containing some ink or other colouring material. Boil the water over a suitable flame.

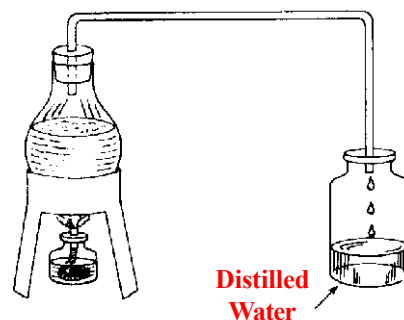

5 How to make a larger distiller

See Chapter II, item C 7.

6 How to make a Liebig condenser

See Chapter II, item C 9.

C. HARD WATER AND SOFT WATER

Hard water contains minerals which are dissolved from the rocks as the water runs over and through the earth. Soft water is water that contains little or no dissolved minerals, such as rain water or distilled water.

1 The difference between hard and soft water

Collect some hard water from a stream (or make some as described in the next experiment). Also secure some soft water such as rain water or distilled water. Make some soap solution by dissolving soap shavings or powdered soap in a little warm water. Place equal amounts of hard and soft water in each of two bottles. Add soap solution to the soft water with a dropper, a few drops at a time. Shake the bottle well after each addition. Count the number of drops of soap solution needed to produce suds about 1 cm thick on the top.

Next add the same amount of soap solution to the hard water and shake well for about the same length of time. Observe any differences. Continue to add soap solution to the hard water until you get good suds. How do the amounts of soap used compare?

2 How to make hard water

There are two kinds of hard water, one called temporary and the other called permanent. Temporary hard water can be made as follows: Start with some clear lime water (see Chapter XVIII, item 12, for directions). Bubble carbon dioxide (see K 14) through the lime water until the cloudiness first formed disappears and you will have some temporary hard water. Permanent hard water can be prepared by stirring some calcium sulphate or plaster of Paris with water and letting it stand for several hours. After this has been filtered the clear filtrate will be permanently hard. You can also prepare this type of hard water by dissolving magnesium sulphate (Epsom salts) in water.

3 Softening hard water by boiling

Temporary hardness can be removed from water by boiling. Shake a little temporary hard water with a few drops of soap solution and see if you can make suds. Next boil a similar amount of the water that contains temporary hardness. Try making suds with this sample after adding the same amount of soap solution.

4 Softening water with chemicals

Try making suds with a half test tube of hard water and a few drops of soap solution. Next boil a similar sample and again try to make suds by using the same amount of soap solution.

Add some washing soda (sodium carbonate) to a sample of permanent hard water. Try making suds with soap solution. Has the water been softened? Add some borax (sodium pyroborate) to a sample of permanent hard water and test to see if it has been softened.

5 How soap helps water in cleaning

Prepare two greasy cloths by smearing kitchen fat or vaseline on cloths. Wash one sample in warm water without soap. Wash the other sample in warm water with heavy soap suds. Hang the samples to dry and observe which one was made cleaner by washing.

observe that the globules all finally come together and collect on the surface. Set this aside to compare with the next experiment.

6 How water acts towards fat

Half-fill a tall glass jar with warm water. Add some olive oil or other oil to a depth of about 1 cm. Shake this mixture hard. Observe how the fat is broken up into tiny droplets or globules. Allow this to stand and

7 How soap acts towards fat

Prepare another jar with warm water and oil just as you did in the experiment above. This time add about half a cup of either liquid soap or strong soap solution made by dissolving soap chips in water. Shake this mixture vigorously, allow to stand and compare with the sample from the previous experiment. You should observe that the soap has broken up the globules of fat and they are now distributed so that the mixture looks like milk.

8 Hard and soft water in cleaning

Prepare two samples of dirty cloth. Wash one in soft water with soap until it is clean. Wash the other cloth in hard water for the same length of time and with the same amount of soap. Hang the samples to dry and observe the difference.

9 How to make soap

Soap can be made from waste fat. Secure some waste fats and melt in a dish. Strain the fat through several layers of cloth. Weigh the fat and then weigh out about one third as much commercial lye (sodium hydroxide). Dissolve the lye in water. Heat the fat in an iron kettle or dish. When it is melted, pour the lye solution in slowly and stir continuously. Keep the flame low to avoid boiling over. Let the fat and lye boil for 30 minutes with frequent stirring. After boiling add common salt—about twice the weight of lye used. Stir well. When this mixture has cooled the soap will appear as a layer at the top. Take only the soap, melt and pour it into match boxes to make little cakes of soap. Is it a good soap?

D. WATER AT REST AND IN MOTION

1 The meaning of pressure

Stand with muddy feet or boots on a piece of paper and draw an outline of the footprints. Measure the area using squared paper, and calculate the force per square centimetre. Standing on one foot will distribute your weight over about half the area, with a corresponding increase in pressure which can also be calculated.

2 The difference between weight and pressure

Make two square blocks of wood, one much smaller than the other, and join them together as shown in the diagram. Press each of these faces consecutively into a slab of clay or plasticine using the same force in each case.



The difference in pressure is seen by the different depths of the indentations.

3 To show that liquids exert pressure

Connect two 15 cm lengths of glass tubing or two transparent plastic soda straws with a short length of rubber tubing and attach them to an upright as shown in the diagram.

Put some coloured water in the tubes to a depth of about 6 or 8 cm. This is your pressure gauge or manometer. Cover a small funnel with thin rubber stretched tightly and tie it securely with thread or string. Attach the funnel to the manometer with a 30 cm length of rubber tubing. Push the funnel into a pail of water and watch the manometer.

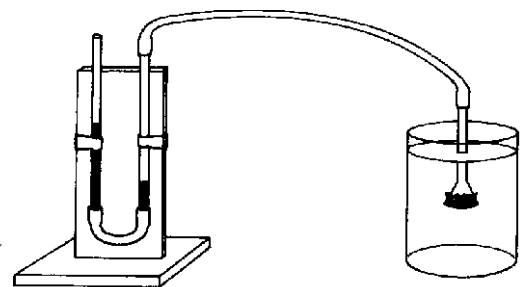

4 Water pressure changes with depth

Use the funnel and manometer which you made in the previous experiment. Fill a tall glass jar or pail with water. Measure the pressure just below the surface with your manometer. Measure the pressure at the bottom. How does pressure change with depth?

5 Pressure depends upon the liquid

Obtain two glass jars into which the funnel will fit. Fill one with water and the other, to the same depth, with a less dense liquid such as alcohol. Measure the pressure at the bottom of the jar of water. Measure the pressure at the bottom of the jar of alcohol. How do they compare for the same depth?

6 Water pressure in a large vessel is the same as in a small one, at the same depth

Use the funnel and manometer from the above experiments. Secure a tall glass jar of small diameter and a glass jar of larger diameter. Fill both jars to the same depth with water. Measure the pressure at the bottom of each jar. How do they compare?

7 Another way to show that water pressure increases with depth

Find a tall tin can. Punch holes up the side of the can about 3 cm apart. Put a strip of adhesive or plastic tape over the row of holes and fill the can with water above the top hole. Hold the can over a sink and strip the tape from the holes beginning at the bottom. Observe the streams and note the distances travelled outwards from the can.

8 Water pressure is the same in all directions

Punch holes around the base of a tall tin can with a nail. Cover the holes as above with a strip of tape. Fill the can with water and strip off the tape while holding it over a sink. Observe and compare the distance the streams shoot out from the holes all around the can.

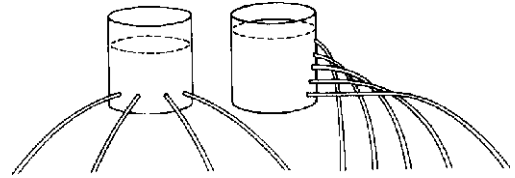

9 Upward and downward pressure are the same at any given depth

Obtain a glass cylinder at least 15 cm long and 4 cm in diameter. Such a length of tube can be made from a straight-sided bottle like an olive oil bottle by removing the bottom (see page 218). A clear plastic tube will do or even a cardboard mailing tube that has been coated with paraffin wax or shellac.

Cut a square of cardboard about 5 cm on one side. Coat it with paraffin or shellac. Attach a length of thread or string to the centre with tape. Put the thread through the tube and hold the cardboard to the bottom with the thread. Plunge the tube, card-end down into a jar of water. Let go of the thread. Now pour coloured water into the tube. Note the depth of water inside the tube when the card falls away.

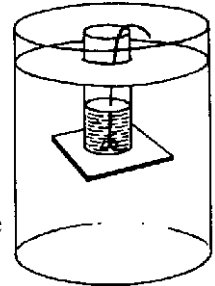

10 Balancing water columns

Remove the bottoms from several glass bottles of different shapes but of about the same height (see page 218 for directions). Fit the bottles with stoppers or corks carrying glass tubes as shown in the diagram. Connect the bottles together as shown. Pour coloured water into the bottles until they are nearly full. This experience again shows that in a given liquid, pressure is independent of the size or shape of the vessel and depends only on the depth.

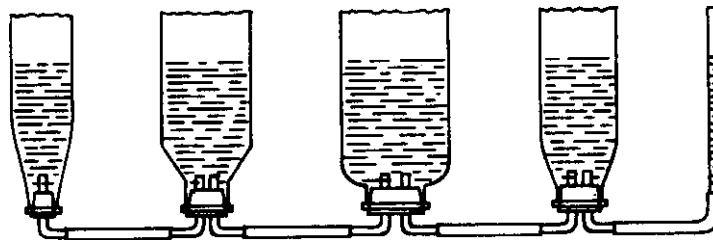

11 Raising heavy weights by water pressure

Obtain a rubber hot-water bottle. Put a one-hole stopper carrying a short glass tube tightly in the neck. Punch a hole in the bottom of a tin can and make it large enough to take a one-hole stopper. Put a short length of glass tube through the stopper. Connect the water bottle and the can with a length of rubber tube at least 1.25 metres in length—it will be wise to wind wire around the connexion at the bottle. Fill the bottle, tube and can with water. Place the bottle on the floor and put a length of board on it. Place books or other heavy objects on the board. Now raise the can above the level of the floor and observe the weights. See how heavy a weight you can lift by raising the can as high above the floor as possible.

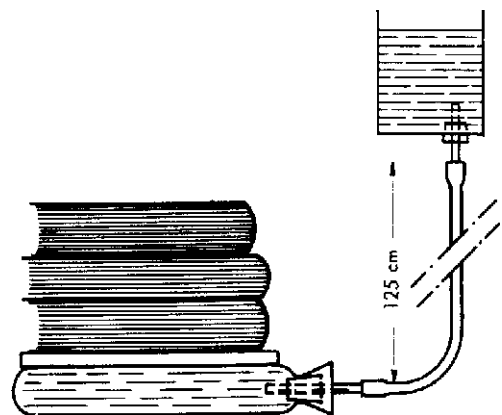

12 Water will not compress

Fit a soda water bottle with a one-hole stopper. Through the stopper place the glass tube from a medicine dropper, narrow end up. Fill the bottle to the top with water. Insert the stopper tightly until the water rises a little way in the medicine dropper. Now grasp the bottle in your hands and squeeze as hard as you can. The water will rise in the tube because you cannot compress it. Can you make the water run over the top of the tube?

Fill a medicine bottle with water. Force in a good cork. Strike the cork sharply with a hammer; the bottle will burst.

13 Making a model hydraulic elevator

Some freight and passenger elevators are raised by water pressure. You can make a model of one of these with an automobile hand pump. Connect the tube from the pump to a length of rubber tube. Bind the connexions with wire so they will not blow out. Now connect the tube to a water tap with a one-hole rubber stopper. Again bind the connexion of the tube and stopper. Steady one of your pupils as he sits on the handle. Turn the water on slowly and see if the water pressure will lift him. You may have to hold the stopper in the tap.

14 Simple hydraulic press

The principle of the hydraulic press is illustrated by the following model.

Half fill a cylindrical jar with water. Pour melted paraffin wax on the surface to form a piston, holding a piece of glass tubing in the wax as it cools. When the wax is solidified it forms a watertight piston. Gently blow down the tube, and the plug will be raised. Considerable weights placed on the piston can be lifted in this way.

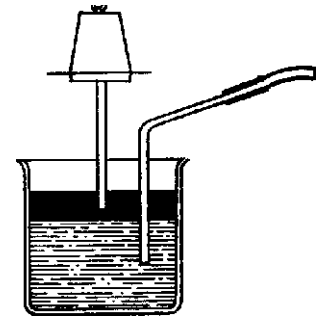

15 A model hydraulic ram

Hydraulic rams are sometimes used to raise water from a low level to a higher level. They are operated by a flowing stream of water.

You can make a model hydraulic ram. Secure a soda water bottle from which the bottom has been removed (see page 218 for directions). Fit the bottle with a one-hole rubber stopper carrying a short length of glass tubing. Connect this to a glass or metal T-tube which has a piece of rubber tubing on one end and a jet tube connected to it with a rubber tube as shown in the diagram. Fill the bottle with water and pinch the tube at the end. Let the water run from the end of the tube. Stop the flow suddenly by quickly pinching the tube, and note the height to which the water squirts from the jet tube. Let the water flow and stop alternately, and you have a working model of the hydraulic ram.

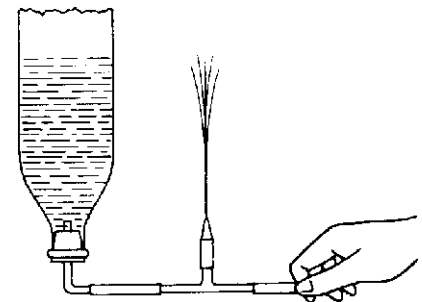

16 A model reaction water turbine

Use a soda water bottle from which the bottom has been removed. Wind string around it near the bottom end and suspend it as shown in the diagram. Fit a two-hole stopper to the neck of the bottle. Through the holes place glass tubes that have been bent as shown and have their ends drawn out to jet tubes. Fill the bottle with water and watch the turbine rotate as the water runs from the jets.

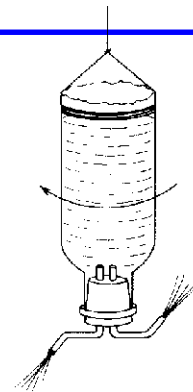

17 Model water wheels

A meat skewer or a knitting needle can be used as an axle. An old typewriter ribbon- spool or a sticking plaster reel is useful as a basis for these improvisations. A stream of water from a tap, or guided from a tank along a piece of rainwater spouting is a suitable source of water power.

A cotton reel or cork can also be used as the 'nave' of the wheel. Cut slots down the sides, perpendicular to the ends. Slide pieces of wood or tin into these slots to act as paddles.

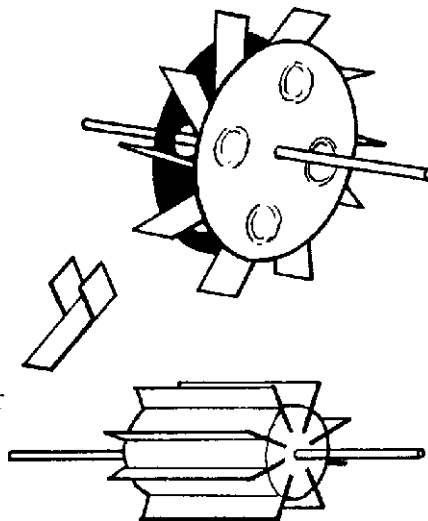

E. SINKING AND FLOATING

1 What determines sinking and floating?

Shape a piece of lead, tin or aluminium foil into the form of a little boat and float it on the water in a pan; now wad the metal foil from the boat into a small ball and try to float it on the water. What do you observe? What is your best explanation for this?

2 The buoyancy of water

Find a metal can like a coffee can or a cigarette tin which has a tightly fitting cover. With the cover on, push the can into a pail of water, cover end down, and quickly let go of it. Repeat this having the can in different positions. What do you observe? Can you observe the up thrust on the can? Put a little water in the can and repeat the experiment. Keep adding water a little at a time and repeating until the can no longer floats.

3 You can observe the buoyancy of water

Make an equal arm balance. Secure two soda water-bottles and suspend them with loops of string from either side of the arm. until they balance exactly. Bring a pail of water up under one of the bottles until the bottle sinks in the water a little way. Observe what happens.

4 Another way to observe the buoyancy of water

Push a large cork to the bottom of a pail of water. Notice the amount of force you have to apply to hold the cork at the bottom. Repeat the experiment using a fairly large empty bottle stopped with a cork. Is there any difference in the force required?

Blow up a toy balloon and push it to the bottom of the pail. How does the force to hold it down compare with the force required for the cork and bottle?

5 Still another way to observe the buoyancy of water

Obtain a can with a tightly fitting cover such as a cigarette tin or a coffee can. Fill the can with water and put the cover on. Put a double loop of string around the side of the can and then attach a large rubber band to the other end of the cord. Lift the can by holding the rubber band and observe how much the band stretches. Now lower the can in a pail of water and observe the stretch in the rubber band. How do you account for the difference?

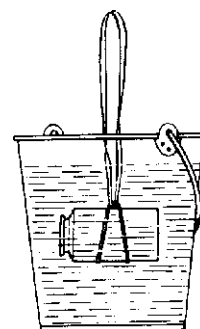

6 A stone seems to weigh less in water

Weigh a large stone on a pair of kitchen scales. Put a loop of heavy string around the stone and weigh it again suspended in a pail of water. How do you explain the difference ?

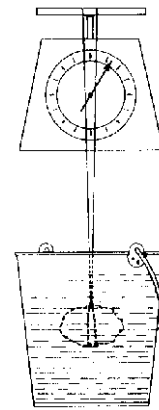

7 How to make a devil diver (Cartesian diver)

Find a tall glass jar with a fairly wide mouth. Wrap a few turns of copper wire about the narrow part of the rubber bulb from a medicine dropper. Fill the jar brim full of water. Put a little water in the bulb and float it in the jar of water. The bulb should contain enough water to bring it nearly to the point of sinking. At this point almost all the rubber will be under water. Considerable adjustment will be required. Remove air from the bulb a bubble at a time by pinching the bulb. When you have adjusted the diver, put a solid stopper in the bottle or tie a piece of rubber cut from an old inner tube over it. By pressing on the stopper or rubber, the diver will sink. When the pressure is released it will rise to the surface. If you make the floater from a small glass test tube or a medicine vial you can explain the action of the devil by observing the level of water inside the float when it sinks and when it floats.

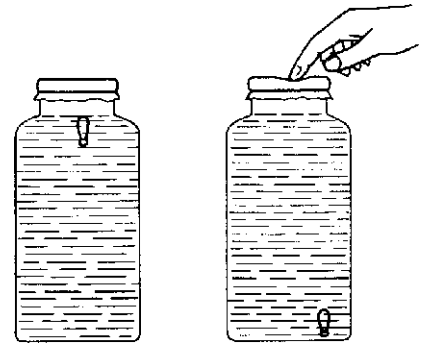

8 How to make an overflow can and catch bucket

These are useful for the study of Archimedes' principle, which controls floating and sinking. To make an overflow can secure a tin can 10 or 12 cm high and 7 or 8 cm in diameter. Make two vertical cuts 2 cm apart and 4 cm down from the top edge. Bend out the tongue so formed into a V-shaped spout.

The catch bucket can be made from a smaller tin can. Punch two holes near the top of the can and on opposite sides. Make a wire bale for the catch bucket.

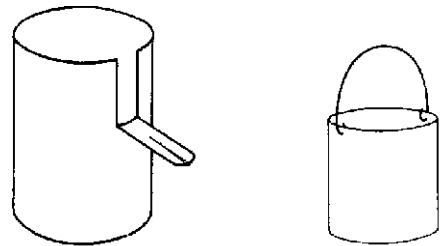

9 Sinking bodies

Fill the overflow can with water to the level of the spout. Select a stone that will go inside the overflow can. Attach a string to the stone and weigh it with a spring balance. Weigh the catch bucket. Place the catch bucket underneath the spout. Immerse the stone in the water and record its weight. Does it weigh the same as in air? Collect the displaced water and determine its weight by subtracting the weight of the bucket from the weight of the catch bucket and water.

How does the apparent loss of weight of the stone from air to water compare with the weight of the displaced water? Try this experiment with other sinking bodies.

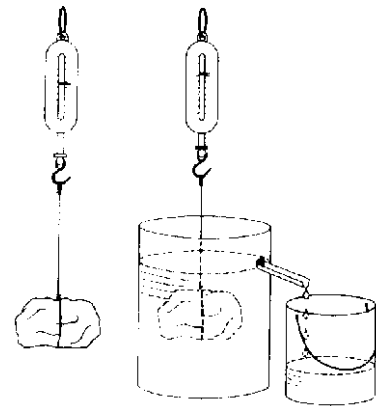

10 Floating bodies

Fill the overflow can with water and let it run out until the surface is level with the spout. Select a piece of wood that floats half or more submerged in the overflow can. Weigh the piece of wood on a spring balance. Weigh the catch bucket. Place the catch bucket under the spout. Put the wood block in the overflow can and note the balance reading. Find the weight of the displaced water by subtracting the weight of the catch bucket from the total weight of catch bucket and water. How does the weight of the floating piece of wood compare with that of the water it displaces? Repeat the experiment with other floating bodies.

11 An experiment with a floating candle

Put a nail in the lower end of a candle. The nail should be just the right weight to make the candle float with its top a little above the surface of the water. Float the candle and nail in a tall glass of water. Light the candle and watch it until it is nearly burned up. The candle constantly loses weight as it burns. Why does it continue to float?

12 A floating experiment with different kinds of wood

Secure a cork, and pieces of wood such as maple, mahogany and ebony. Place them in a pan of water and notice how each one behaves. Can you explain this?

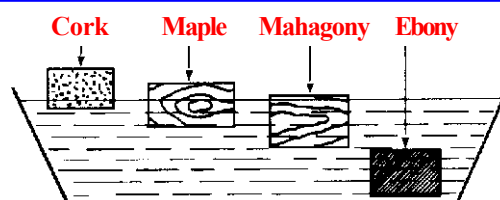

13 An experiment with a floating egg

Place an egg in a glass of fresh water and observe it. Next add salt to the water and see if you can float the egg. Can you explain this? How does this relate to the fact that ships ride higher in ocean water than they do in fresh water?

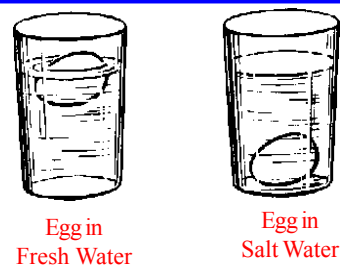

14 Experiment on Archimedes' principle

Solder a cycle valve to one half of a copper ball tap float. Load inside the other half with lead or lead shot until the whole just floats in water. A small quantity of plasticine can be used to make a temporary joint.

After these adjustments solder the two halves of the ball together and make any final changes by winding copper wire round the neck of the valve holder.

In a discussion on 'why things float', the inevitable answer offered by a class is 'because they have air in them'. Granted this argument, things should float 'better' the more air they have 'in' them. Twenty pumpfuls of air forced into this apparatus causes it to sink.

Try the same experiment with a football or metal water bottle.

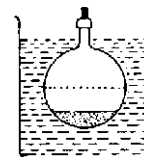

15 Drinking straw hydrometer

Procure a drinking straw or a stout natural straw about 20 cm long. If it is not 'water-proof' dip it in melted candle wax and allow it to dry. Seal one end with wax, and introduce some lead shot or fine sand until it floats in a vertical position. Then drop in melted wax to keep the shots or sand in place. Have a thin rubber band or a piece of black cotton tied round the stem so that it can be slid up and down as a marker.

Put a mark on the straw at the water level. Then take the straw out of the water, and measure the length of the straw from the bottom to the water level mark. Let it be x cm. Now let us assume that water has a specific gravity of unity and that the straw has a uniform area of cross-section. Thus we may put a set of markings on the straw for measuring specific gravities of different liquids with ranges, say, from 0.6 to 1.2 by using the formula: length of straw from the bottom to the mark

$= (x) / \text{specific gravity of liquid}$



16 Specific gravity of a liquid not mixing with water

Pour oil into an open glass tube partially immersed in water until it forces water as far as the lower end. The relative lengths of the total oil column, and of the immersed tube is a measure of the specific gravity of the oil.

For a liquid heavier than water, reverse the procedure, i.e., pour the water into the tube.

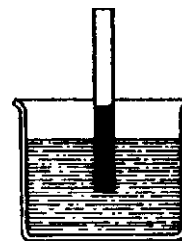

17 Floating in different liquids

Obtain a tall, slender glass jar, test tube or bottle, and the following liquids: mercury, carbon tetrachloride, water and kerosene. You will also need a small iron or steel ball such as a ball bearing, or iron nut or bolt; a small piece of ebony or some other wood that sinks in water; a piece of paraffin wax; and a piece of cork. First pour some mercury into the glass jar, then some carbon tetra- chloride, some water and some kerosene. Drop the four solid substances in and you will observe that the iron sinks in the three top liquids but floats on the mercury. The ebony sinks in the two top liquids but floats on the carbon tetrachloride. The paraffin sinks in the kerosene but floats on the water and the cork floats on the kerosene.

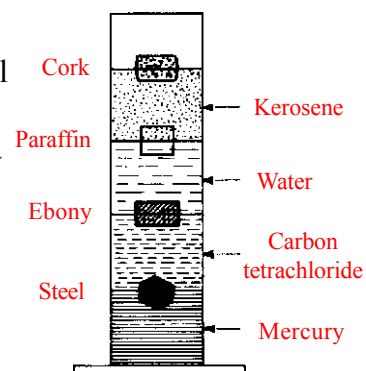

18 How a submarine is raised and lowered

Place pieces of iron or rocks in the bottom of a small wide-mouth bottle and pour a little melted paraffin on them to fasten them down so that the bottle will float in an upright position. Insert a two-hole stopper. In one hole place a U-shaped length of glass tubing which extends to the bottom of the bottle. In the other hole put a short length of glass tube and a rubber tube. Set the bottle in a large vessel of water.

Withdraw some air by sucking on the rubber tube and water will siphon into the bottle until the bottle sinks. The bottle may be made to rise by blowing out part of the water.

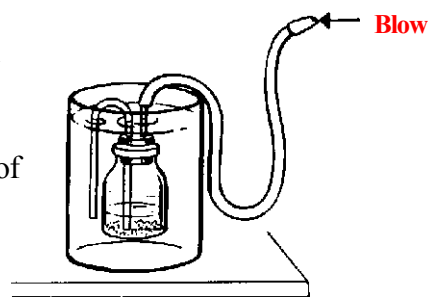

Actually, submarine engineers adjust the buoyancy of the submarine to that of the water and then use the elevators to dive or climb. To remain at the surface they will 'blow' the tanks with surface air after rising. The use of compressed air to empty the tanks is not practical while the submarine is submerged.

The device also illustrates the principle of the tanks or pontoons used to lift sunken ships. Fasten a weight to the bottle, sink both in water and lift the weight by blowing air into the bottle.

F. LIQUID SURFACES

Water and other liquids have a thin film which covers their surfaces. The surface film is pulled tightly over the liquid and this is often spoken of as surface tension. Many interesting experiments can be done with liquid surfaces.

1 Floating a needle on water

Thoroughly dry a steel needle. Place it on the tines of a dinner fork and gently break the surface of the water in a dish with the fork. If you are careful the needle will float as you take the fork away. Look at the water surface closely. Can you see how the surface film seems to bend under the weight of the needle?

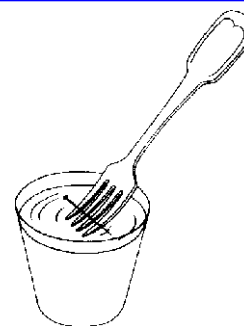

2 Floating a razor blade

Secure a used razor blade of the double edge type. Try floating it on the surface of water. Again observe the surface and see if the surface film dips under the razor blade.

3 Lifting the water surface

Bend the pointed end of a pin or use a piece of fine wire to make a hook. File the point of the hook until it is very sharp. Put your eye on a level with the surface of the water in a drinking glass. Put the hook under the surface of the water and gently raise the point to the surface. If you are careful the point will not penetrate the surface film but will lift it slightly upwards.

4 Holding water in a sieve

Pour some oil over the wire mesh of a kitchen sieve and shake out the excess so that the holes are open. Carefully pour water into the sieve from a pitcher, letting the water run down the side of the sieve. When the sieve is about half full, hold it over a sink or pail and observe the bottom. You will see the water pushing through the openings but the surface tension keeps it from running through. Touch the bottom of the sieve with your finger and the water should run through.

5 An experiment with a can lid

Punch many holes in a tin can lid with a hammer and very fine nail. Float the lid on the water in a pan. Does water come through the holes? Fill the lid with water from a pitcher. Does water run out of it?

6 Heaping water up in a glass

Place a drinking glass in a shallow pan or on a saucer. Rub the top edge of the glass with a dry cloth. Pour water into the glass until it is full to the brim. You will observe that you can fill the glass several millimetres above the top. Now drop coins or thin metal washers into the water edgewise. See how far you can heap the water up by dropping these in before it runs over.

7 Putting a point on a brush

Secure a paint brush of some sort and observe the bristles. Now dip the brush in water and you will observe that surface tension has drawn the bristles together. An artist's paint brush or a shaving brush will work very well for this experiment.

8 A trick with surface tension

Obtain a used tin can and make five holes in it with a nail. The holes should be very near the bottom of the can and about five millimetres apart. Now fill the can with water and observe that the water comes from the can in five streams. Pinch the jets of water together with your thumb and forefinger and you can make one stream from five. If you brush your hand across the holes in the can the water will again flow in five separate streams.

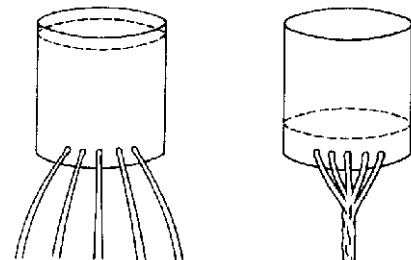

9 The water will not run through the cloth

Select a glass jar and a piece of cloth from an old sheet or handkerchief. Fill the jar with water. Wet the cloth well, stretch it over the mouth of the jar and fasten with a piece of string or thread. Invert the jar over a pail of water and observe that the surface tension keeps the water from coming through the cloth.

10 The effect of soap on surface tension

Select a large plate and rinse it until you are sure that it is very clean. Fill the plate with cold water and let it stand for a time on a table until the water is still. Sprinkle some talcum powder lightly over the surface of the water. Wet a piece of soap in water and touch it to the water near the edge of the plate. The talcum powder will be drawn to the opposite side of the plate at once. The soap reduced the surface tension at one point and the increased surface tension on the other side contracts the surface and pulls the talcum with it.

11 The effect of petrol on surface tension

Repeat the above experiment, being sure that the plate is very clean. It is wise to rinse the plate in cold water for a time before filling it. Instead of soap, place one drop of petrol on the water near the edge of the plate. How does petrol affect the surface tension of water?

12 An experiment with a loop of thread

Rinse a dinner plate thoroughly and then fill it with water. Make a loop with thread, open it a little and float it on the water. Touch the surface inside the loop with a bit of soap and observe the results.

13 Driving a boat by surface tension

Secure some gum camphor at the drug store. Cut two or three boats from stiff paper, each about 2.5 cm in length. Cut a notch in the stern large enough to hold a small lump of gum camphor in contact with the water without letting it fall out. Float your boats in a large pan of water.

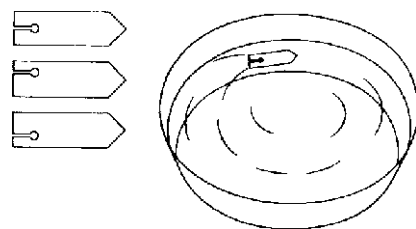

You can make an interesting variation by placing the notch in the stern on the right or on the left.

14 A floater to show surface tension Bend a piece of small copper wire into a ring about 8 cm in diameter. Attach two other pieces of wire rigidly to opposite sides of the ring and join these pieces by twisting them together about 8 cm below. Make the twist about 5 cm long. Attach a flat cork as shown in the diagram and then a wad of tinfoil to keep the floater upright in water. Now set the floater in a pan of water and press it beneath the surface. When it floats upwards, it does not break through the surface film. Observe how it stretches the surface film.

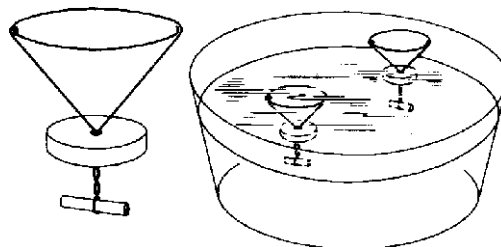

15 Making spheres with surface tension

Find a glass jar and fill it about two-thirds full of commercial alcohol. With a medicine dropper place some drops of oil in the alcohol and then fill the jar with water. If you get the correct mixture, the oil spheres will float down to about the middle of the jar. The oil droplets are pulled into perfect spheres by surface tension.

16 Blowing soap bubbles

Soap films and bubbles serve very well for observations on surface tension. You can make a good soap bubble solution by placing three level tablespoonfuls of soap powder or soap flakes into four cups of hot water. Let the solution stand for three days before using. Try blowing bubbles with a bubble blower, a soda straw, a clay pipe and an old tin horn about 4 cm in diameter.

Another good bubble blower can be made by slitting the end of a soda straw into four parts extending about 1 cm from the end. Bend these pieces outward. A razor blade works well for slitting the end.

17 Making a soap bubble support

Put a round dowel rod about 15 cm long into a wooden spool or a piece of wood suitable for a base. Wind copper or iron wire about the dowel rod and make a loop about 10 cm in diameter. Dip the loop in soap solution.

Blow a large soap bubble and detach it in the loop. Now wet a soda straw in the soap solution and carefully put it through the large bubble. Try to blow a smaller bubble inside the large one. This will take a little practice.

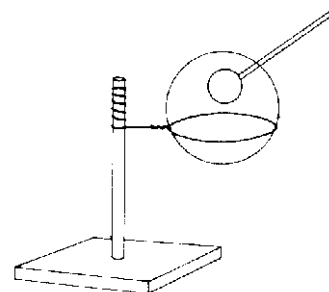

18 Some experiments with soap films

Make the following forms from wire. Dip the various forms in the thick soap solution and observe the films.

Dip the wire form with the slider in the soap solution. Pull out the slide slightly and watch the film stretch. Release the slider, and it will be pulled back by the contraction of the film. water are nearly the same.

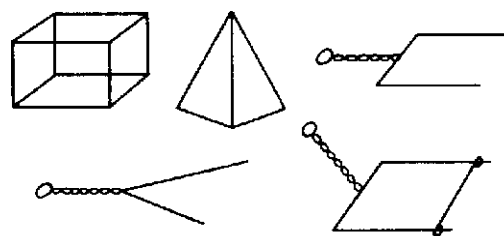

19 To study the formation of a drop of liquid

Gently pour aniline into a large beaker of cold water until a layer about half an inch deep accumulates at the bottom. Place the beaker on a gauze and tripod and warm it using a small Bunsen flame. Aniline expands more than water and after a while it will float to the top. Remove the Bunsen and wait for results. As the aniline cools it will sink again to the bottom, but in so doing exhibits the form taken by all drops of liquid when falling. The effects of surface tension are seen in slow motion because the densities of the aniline and

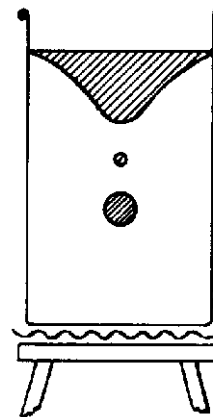

CHAPTER X

Experiments and materials for the study of machines

A. LEVER, WHEEL AND AXLE, PULLEY

1 A simple equal-arm lever

Make a wooden base 15 cm square and 2 cm thick. In the centre of the base fasten another block of wood 4 cm square and 3 cm thick. Fasten to two sides of this block two uprights 15 cm long, 3.5 cm wide and 1 cm thick. These may be fastened to the small block by means of screws. In the top end of each upright cut a narrow slot with a thin blade saw. The slot should be a little less than 2 cm deep or just deep enough to hold a used razor blade with 2 or 3 mm extending above the top of the upright.

For the lever arm use a uniform bar about 1 m in length, 4 cm in width and about 5 mm thick. Balance the bar on a knife edge and locate its exact centre of balance. Put a slender nail through the centre of balance of the bar. The nail should be long enough to rest on the two razor blades at the ends of the uprights and permit the bar to swing freely between them.

Balance the bar on the razor blades, and if it does not balance perfectly cut off a little of the heavy end with a knife or saw.

Mark the bar off in centimetres beginning at the nail (fulcrum) and numbering from 1 in each direction to the end of the bar.

Suspend weights by loops of thread from the balance bar.

1 Hang a 10 g weight 20 cm from the fulcrum and then balance with another 10 g weight on the other side. Observe the distance of this weight when the lever is in balance. Repeat placing the weight nearer the fulcrum; farther from the fulcrum.

2 Repeat 1 above with 100 g weights.

3 Place two weights on one side and balance with one weight on the other side. Can you find the condition for balance here? Suggestion: multiply each weight on one side of the fulcrum by its distance from the fulcrum and add the products. Compare this with the product of weight and distance on the other side.

2 A simple balance

Suspend a ruler by loops of cord a short distance above a table top, as shown in the diagram. When the ruler is in balance, place identical coins in different positions on each side of the fulcrum so that the ruler balances again. Using the simpler combinations of numbers of coins and distances from the fulcrum, develop an elementary understanding of the principle of moments. For instance, two coins placed at one end of the ruler will balance four coins placed halfway between the fulcrum and the opposite end.

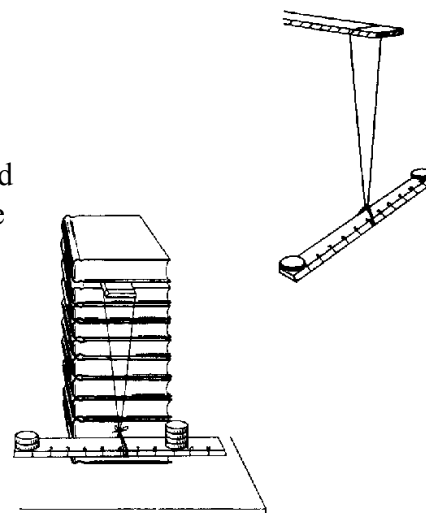

3 A simple beam balance

The beam of a platform balance on which pupils are weighed is really a level with the fulcrum very close to one end. To show the principle of this type of balance place a stack of eight or ten coins near the fulcrum of the suspended ruler used in 2. Slide a single coin along the opposite end of the ruler until it balances.

4 A lever of the first class

Saw off a stick or board so that it is the same height as a heavy desk or table in the classroom. Place another stick about the same length on this. Place the end of this stick under the edge and use it as a lever to lift the desk or table.

Note that in lifting a heavy object with a lever the longer end travels farther than the shorter end. No energy is really gained but the force exerted by the shorter end of the lever is much greater than the force used to move the longer end.

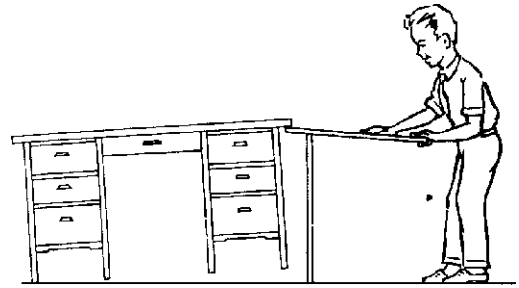

5 A lever of the second class

Use a uniform wooden bar about 1 m long, 4 cm wide and 5 mm thick. Drill a hole near one end, in the centre of the width dimension. Also drill a hole through both uprights used in experiment 1 above, about 12 cm from the base. Put a nail through the holes in the uprights and the hole in the end of the lever bar so that the lever bar is between the uprights. Place weights along the bar and use a spring balance to lift the end of the bar.

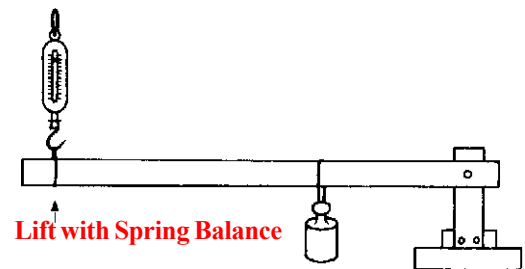

6 A lever of the third class

To make a lever of the third class for simple experiments use the materials which were used in experiment 5 above, but interchange the weight and balance.

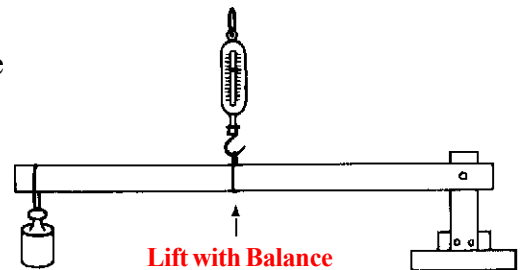

7 A see-saw lever

Obtain a thick plank about 3 m long and bring it into the class room. Balance it over a box or some other convenient device and let the pupils experiment with the seesaw; place different numbers of children on either side of the balance point.

8 A simple wheel and axle

Remove the cover from a pencil sharpener and tie a string tightly around the end of the shaft. Tie a weight of several kilograms to the end of the string and turn the handle. Note that the force needed to turn the handle is much less than the force of gravity on the weight. Point out that the pencil sharpener is used as a wheel and axle in this demonstration.

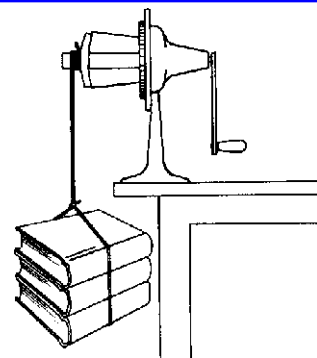

9 Another wheel and axle

Secure some double corrugated cardboard and draw circles of 15, 10 and 5 cm in diameter on it with a compass. Punch through the cardboard with the compass and draw each wheel or circle on the other side. Cut out each of the wheels, cutting cleanly from either side of the cardboard. Punch a nail through the centre of each wheel and then glue or staple the wheels together—with the largest and smallest wheels on the outside—so that they will turn easily on a common axis. Mount them as shown in the diagram. Press gently into the rim of each wheel with a blunt instrument to make a groove. Wind a thread or string over each pulley and attach one end to the groove with a pin. Put a loop in the other end of the thread so that weights may be suspended from it. Use some light weights such as clothes pegs, and you will discover that you can lift weights many times greater, just as you can with a lever. The wheel and axle is a type of lever.

Double Corrugated cardboard

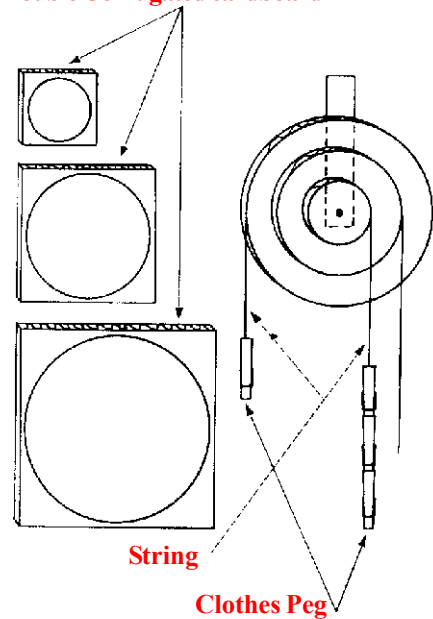

10 How to make a simple pulley

A reasonably satisfactory pulley can be made from a wire clothes hanger and a cotton reel. Cut off both wires of the hanger at a distance of about 20 cm from the hook. Bend the ends at right angles and slip both through a spool. Adjust the wires so that the spool turns easily and then bend the ends down to keep the wires from spreading.

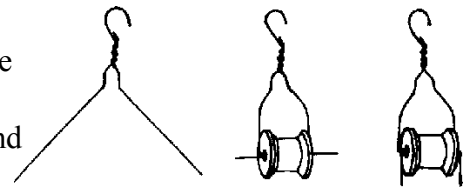

11 A single fixed pulley

Set up a single fixed pulley as shown in the diagram below. By means of weights see how much force is required to lift weights of 25, 50, 75, 100 and 200 g. Measure the distance moved by the effort force when the resistance force (the weight) is moved through 20 cm.

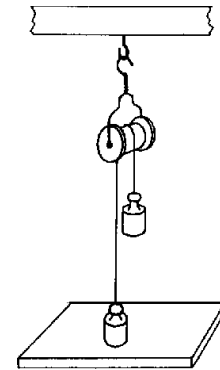

12 A single movable pulley

Suspend two pulleys on a cord from a horizontal support, and load them as shown. If there is no adjustable support on the demonstration desk, a window stick laid across the back of two chairs will serve. Attach a spring balance to the end of the cord and compare the weight of the object with the force required to lift it with the pulley system. Compare also the distances through which the force and the weight are moved.

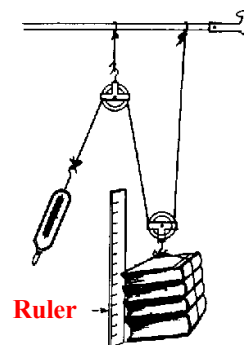

13 The block and tackle

Let two pupils each grasp a round stick, such as a broomstick, and stand several feet apart. Tie a length of clothes line cord to one of the sticks and wrap it several times around both sticks so as to form a combination of pulleys. Ask a third pupil, smaller than the other two to pull on the rope. He can easily pull the two sticks together despite the efforts of the pupils holding the sticks.

Make a list of devices in which pulley combinations are used to increase forces. Tow cars and power shovels are examples. List other devices and machines used to increase forces.

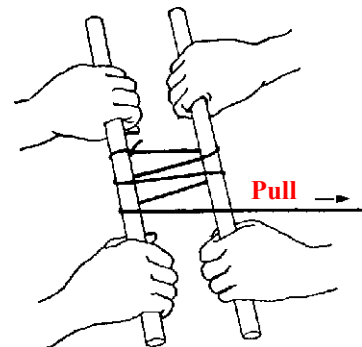

B. INCLINED PLANE, SCREW AND WEDGE

1 A simple inclined plane

Attach a spring balance to a toy car or roller skate and pull it up a slanting board (inclined plane). Note the force required to move the car and compare it with the force needed to lift it vertically. Note also that in moving up the inclined plane, the force is exerted over a greater distance than when the car is lifted vertically to the same height above the table. Neglecting friction, the work required is the same in both cases. Point out that this is also true for other simple machines.

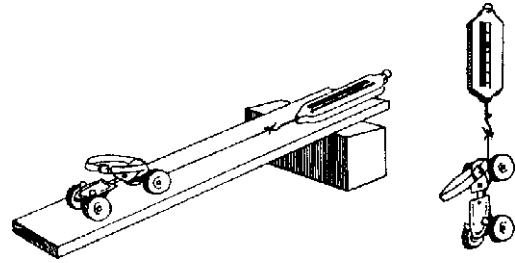

2 The screw is an inclined plane

Mark off and cut out a right angle triangle on a piece of white paper or a piece of wrapping paper. The triangle should be about 30 cm long on its base and about 15 cm long on its shortest side. Secure a round rod about 20 cm long and roll the triangular piece of paper on the rod beginning at the short side and rolling toward the point of the triangle. Keep the base line of the triangle even as it rolls. Observe that the inclined plane (the hypotenuse) spirals up the rod as a thread.

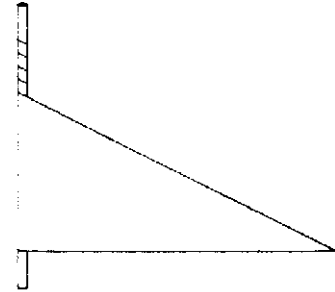

3 A simple jack screw

Bore a hole through a block of wood to fit a carriage bolt. Select a bolt that is threaded nearly its entire length. Sink the head of the bolt in the wood, so that it is flush with the surface and nail a piece of board over it. Over the projecting threads place a nut, then a washer and short piece of metal pipe. The inside diameter of the pipe must be slightly larger than the bolt. By turning the nut with a wrench the device will act as a powerful lifting jack.

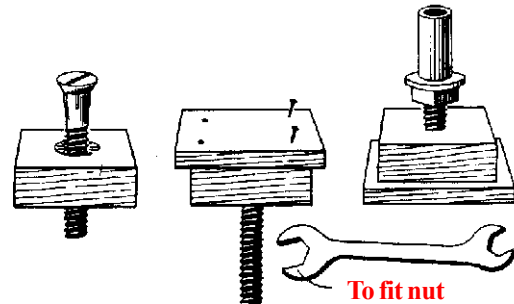

4 The wedge

Make a wedge from a piece of wood and drive it under a table leg or some other heavy object. Observe that the wedge is a double inclined plane.

D. HOW SPEED IS INCREASED BY THE USE OF MACHINES

1 A small spool and a large spool

Using nails for axles fasten a large spool and a smaller spool to a block of wood. Slip a rubber band over both spools. Turn the larger spool one turn and note whether the smaller spool makes more or less than one full turn. Make a list of devices that driven by belts.

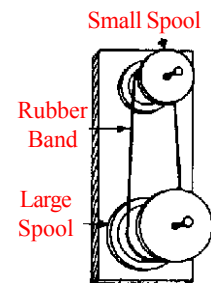

2 Using a bicycle

Turn a bicycle upside down so that it rests on the seat and handlebars. Turn the pedal wheel exactly one turn and note the number of turns made by the rear wheel.

3 An egg beater

Examine an egg beater, hand drill or some other device in which an increase of speed is obtained by means of gears.

4 Using a lever

Show that the longer end of a lever travels farther and faster than the shorter end when the fulcrum is not in the centre. A baseball or cricket bat makes use of this advantage. List other examples of the use of levers and other simple machines to increase speed.

5 Using a pulley

Use the pulley set-up shown in experiment A 12. Apply the force on the movable pulley and observe how rapidly the weight on the other end of the string rises.

6 Using a wheel and axle

Use the pencil sharpener that you used in experiment A 8. Pull on the end of the string that held the books and observe how rapidly the crank turns.

D. HOW MACHINES ARE USED TO CHANGE THE DIRECTION OF FORCES

1 A model elevator

A working model of an elevator can easily be made from simple materials. For the rotating drums or sheaves, metal coffee tin will do. With a hammer and a large nail punch holes in the exact centre of the bottoms and lids. Replace the lids and mount the tins on opposite ends of a board, taking care that they both turn easily.

For the elevator car use a small cardboard or wooden box. Attach pieces of string to both ends of the box and wind them round the sheaves as shown. A piece of modelling clay can be used for a counterweight and should just balance the weight of the car.

Operate the elevator by turning the sheave that has the double turn of cord. A model of this kind is very similar to real elevators, but the sheave of a real elevator is turned by an

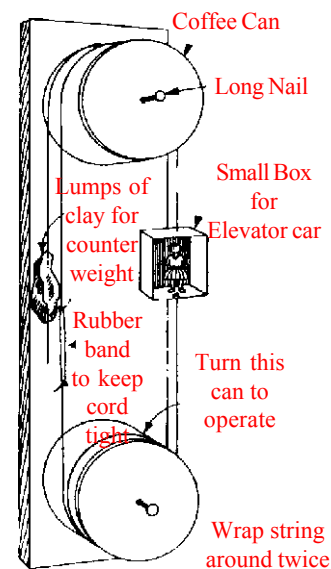

2 Simple gears

With a hammer and a medium-sized nail, make holes in the exact centres of several used bottle caps. Straighten the edges of the caps to make them as round as possible.

Lay two of the caps on a block of wood so that the tooth like projections mesh together. Fasten them down with carpet tacks, but make sure that they still turn easily. Turn one of the caps and note the direction that the other turns. Add a third cap and note the direction that each turns.

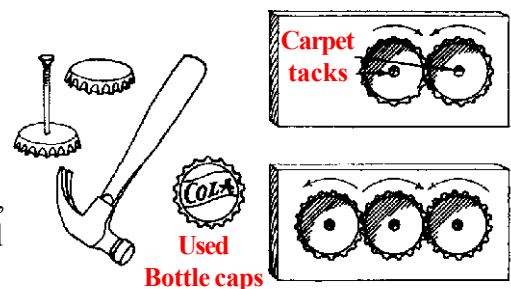

3 Using cross belts

Cross the belt on the spool pulleys used in C 1 above and turn one of the pulleys. Note that they now turn in opposite directions.

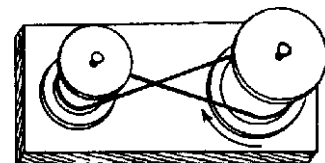

E. USING AND OVERCOMING FRICTION

1 Reducing friction with pencils

Place round pencils under a heavy box. Attach a string to the box and find the force needed to move it across a table. Find the force needed to move the box without the rollers. Summarize the data obtained and suggest explanations for the results.

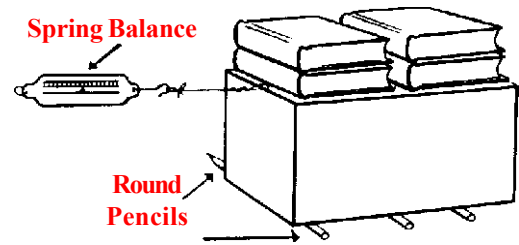

2 Using wheels

Repeat the previous experiment but use a wheeled device such as a roller skate (or several roller skates) instead of rollers. State some advantages that wheels have over rollers for moving things.

3 Sliding friction

Lock the rollers of a roller skate by criss-crossing rubber bands over them on both sides. Place the roller skate on a sloping board and note how the friction of the rubber keeps it from sliding.

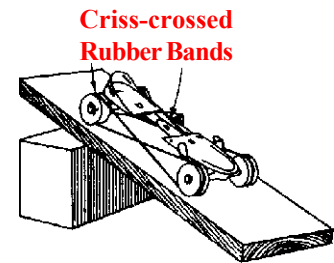

4 Places where friction occurs

Locate the places on various mechanical devices where parts rub together. Roller skates, pulleys and the wheels of toys often need oil. Try to find two similar bearings that need oil, such as those on a roller skate. Oil one and compare the ease with which it turns with the bearing that has not been oiled.

5 Reducing friction with oil

Lay two panes of glass side by side and place a few drops of oil on one. Ask pupils first to rub a finger back and forth on the unoiled pane and then on the oiled pane. Feel the difference.

6 Friction of rough surfaces

Place two pieces of sandpaper together. Notice the friction that is created when one is rubbed against the other. Now put some grease between the pieces of sandpaper. The friction is much reduced because the grease fills up the irregularities on the surface of the sandpaper. Applying grease to the moving parts of a machine acts in a similar way.

7 Reducing friction with ball bearings

Find two tin cans that have a deep groove around the top, such as paint cans. Lay marbles in one groove and invert the other can over the marbles to form a ball bearing. Place a book on top and note how easily the demonstration bearing turns. Oil the marbles and it will turn still more easily.

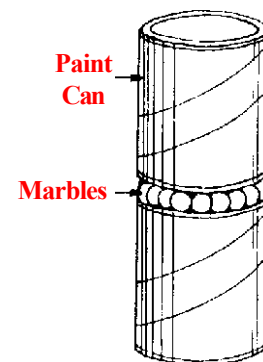

8 Real ball bearings

Examine real ball bearings and roller bearings. Make a list of devices that contain ball bearings or roller bearings.

9 Ball bearings again

Place some marbles in the lid of a tin on the floor. Put one foot on the marbles and notice how easily you can spin round.

10 Reducing friction by an air stream

Cut out a disc of cardboard about 10 cm in diameter. With a red-hot pin, burn a hole through the centre. Saw a small cotton reel in half and glue the original end of one half over the middle of the disc. Find a piece of bamboo or some other tube which just fits the hole in the reel. Push this into the neck of a small balloon, using cotton or a rubber band to secure the joint. Blow up the balloon, pinch the neck, and insert the tube into the hole in the cotton reel. Place the disc on the table and release the air. The expanding air, escaping through the hole in the disc, will lift the card so that, given a flick, it will shoot across the table with practically no friction. This experiment illustrates the principle of the Hovercraft.

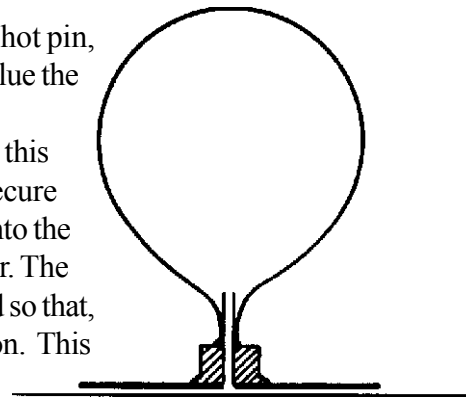

“BE A GOOD SCIENTIST. FOLLOW INSTRUCTIONS EXTREMELY CAREFULLY. WEAR PROTECTIVE CLOTHING WHEN WORKING ON ANY EXPERIMENTS THAT INVOLVE FIRE OR EXPLOSIONS.”

CHAPTER XI

Experiments and materials for the study of forces and inertia

A. BALANCE

1 Making a device for the study of balanced forces

See Chapter X, experiment A 1.

2 Balance with a see-saw

Secure a strong board about 3 m long and a saw horse or box over which the board may be balanced to make a see-saw or teeter-totter. If possible set this up in the classroom. The playground of your school may have a see-saw for the children (see also Chapter X, experiment A 7).

Select two children of equal weight and place them at either end of the board so that they balance. Measure the distance from the balance point to each child.

Next have a heavier child balance himself with a lighter child and observe the changes that have to be made. Next have one child balance two others on the opposite side. Observe the changes. If you measure the distance each time from the balance point to the child and multiply the distance by the child's weight you will discover an interesting thing about balance.

Note: When two children are on the same side, measure the distance of each from the balance point, multiply by the weight of each child and add the products.

3 A balance trick

Obtain a smooth metre stick and let it rest lightly on your two forefingers. Place your fingers near the ends of the stick and then move them toward the centre. Where do your fingers meet on the metre stick? Place the finger of your right hand near the end of the metre stick and the other about half way to the centre on the other side and repeat. Where do your fingers meet this time? Reverse and put the finger of your left hand at the end while the finger of the right hand is about half way to the end on the other side. Where do your fingers meet now? Try other distances. Can you explain this interesting trick?

4 Some simple balance experiments

(a) With a sharp knife cut a slice of some raw vegetable or modelling clay about 2.5 cm thick. Punch the point of a lead pencil through the slice until it protrudes about 2.5 cm on the other side. Insert a dinner fork in the slice of vegetable as shown in the diagram. Now place the pencil point on the edge of a table and adjust the parts until balance is obtained; then give the long end of the pencil a little tap.

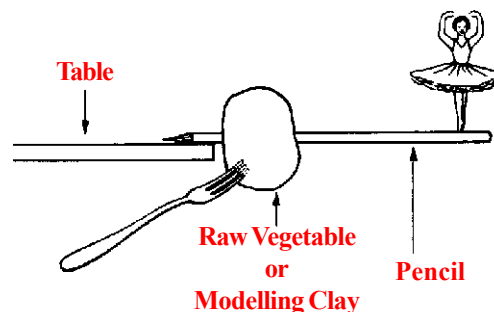

(b) Assemble a slice of raw vegetable or modelling clay, two dinner forks and a pencil as shown in the diagram and balance them on the top of a soda water bottle.

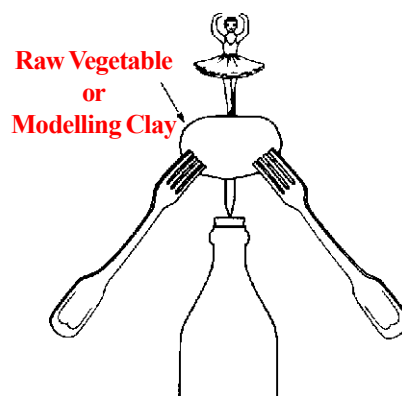

(c) Assemble a slice of raw vegetable or modelling clay, a pencil and two forks as shown in the diagram. This time suspend them with a thread or string. A little experimenting will be required to find the exact point where the string must be placed for balance.

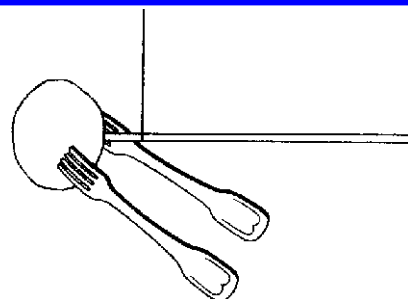

(d) Assemble a coin and two dinner forks as shown in the diagram. Balance on the edge of a bottle or glass.



(e) Try to devise some other simple experiments with balance using common things found about the house or school.

5 Can you straighten the cord?

Obtain a strong cord or small rope about one and a half metres in length. Wrap another cord around a heavy book or other suitable weight. Tie the cord with the weight securely to the centre of the other cord so that it hangs about 15 cm below. Grasp the long end and try to straighten it by pulling your arms apart. Have a pupil pull on one end while you pull on the other. Can you straighten the cord?

6 Finding the centre of gravity of objects

Secure a triangular file and place it on a table as a balancing point. Any sharp-edged device with a flat side may be used. Balance various sticks, rods and devices such as brooms, bats, brushes, etc., on the knife edge and mark the place where they balance with a piece of chalk. Is the centre of gravity of every device you tested at the exact centre of the body? Which objects seem to have the centre of gravity at the centre? Where is the centre of gravity of the others usually found?

B. EXPERIMENTS WITH GRAVITY

1 Falling bodies

If you can find a building that is about 20 m high in your locality you can study how gravity makes bodies fall faster the longer it acts on them. Get a piece of string long enough to reach from a point at least 20 m high to the ground. Fasten the cord so that it forms a straight vertical line. Opposite a window 20 m from the ground tie a piece of coloured cloth or yarn to the string. At about 5 m below this point tie another piece of coloured yarn. Have someone stand on the ground with a watch and call out the seconds. A good way is to beat seconds with the arm and call out 'A thousand and one—a thousand and two—a thousand and three'. This will beat seconds approximately.

Now station someone at the 5 m mark below the starting point and someone on the ground. Drop heavy stones and light stones. Drop small objects and large objects and see how far they have fallen at the end of one second and how far at the end of two seconds.

2 The coins fall together

Place a ruler obliquely on the edge of a table so that one end just projects over the edge and the other end is about 3 cm from the edge. Now place one coin on the projecting end and another on the table, between the other end of the ruler and the edge of the table. With another ruler strike a sharp blow, hitting the projecting end horizontally. One coin falls straight to the floor while the other travels a longer path. Carefully observe when each coin reaches the floor. You will have to repeat this experiment several times. What conclusions do you reach?

3 A simple pendulum

Tie a cord at least 2 m long to some object like a stone or a small metal ball. Suspend this in a doorway or from a hook in the ceiling and start it swinging through a large arc. Count the number of swings it makes in 10 seconds and then multiply by 6 to see how many swings it makes per minute.

Next swing the pendulum through a short arc and determine the number of swings per minute. Repeat each of the above manipulations several times and take the average in each case. Does the length of the arc affect the time of vibration of a pendulum?

Keep the length of the pendulum the same but change the material used for a weight. Repeat the manipulations suggested above.

Does the material in the bob affect the time of vibration of a pendulum?

Repeat each of the above experiments, but use a pendulum that is only half as long. Does the length of the pendulum affect its rate of vibration? How does it affect it?

4 Timing a falling body

The motion of a freely falling body can be examined by attaching it to a strip of paper tape on which marks are made at equal time intervals. This may be done by passing the tape between the armature of an electric bell and a pad of carbon paper. To modify an electric bell mechanism for this purpose, remove the clapper, and extend the armature by soldering to it a strip of metal about 5 cm long. Near the end of this extension, drill a hole to fit a small round-headed screw, and fix it in with the head downwards to act as a marking hammer.

Fasten the mechanism to a piece of wood measuring approximately 5 x 2.5 x 18 cm which will serve as a base. Fix another piece of wood, 5 x 5 x 2.5 cm under the striker to support the disc of carbon paper, and staples to guide the path of the ticker tape. The carbon paper disc should be about 3 cm diameter, held loosely at the centre by a drawing pin so that it can rotate to expose a new surface as the tape passes over it. The staples are easily made from wire paper fasteners pressed into the wood.

The extension to the armature may have to be bent a little so that it does not strike the paper too hard and cause bouncing, which may result in uneven timing. The paper strip is now passed through the staples with the carbon paper underneath and the armature is set in motion. As the strip is released and the body falls, it drags the paper after it. Marks are thus made on the paper at equal time intervals and measurements can be made of the distances travelled from the start. This timing device can be used for other experiments, e.g., the acceleration of a cyclist can be measured by attaching the tape to the saddle of the machine. For absolute measurements an A.C. bell can be modified, when the time interval is that of the frequency of the mains.

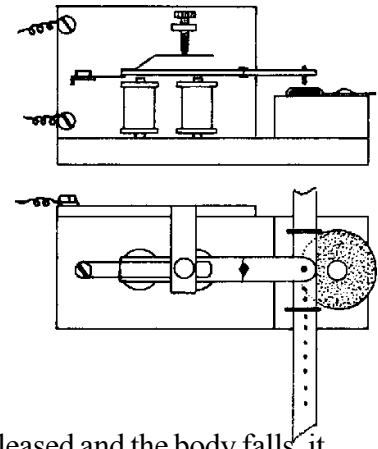

5 Study of a rolling ball

A large ball bearing or 'bagatelle ball' rolling down a smooth track can be timed by a pendulum. To make the track, fasten together two 120 cm lengths of glass tubing (or other smooth rods) with rubber bands. Place them on a length of wood resting on a table, with a matchbox under one end. Set up a simple pendulum to give about quarter second time intervals. A metal nut supported by cotton is suitable. Start the ball rolling down the track and observe its position after successive swings of the pendulum. Make marks along the wood opposite the position of the ball at equal time intervals. Taking the average of several trials, measure the distance travelled from the start. The curve obtained by representing these on a distance-time graph will reveal that the relationship is parabolic, i.e.,

$$s = g.a.t^2$$

where s is the distance travelled, a the acceleration, and t the time taken.

6 Uniform motion

When a body falls through a fluid, the pull of gravity is soon balanced by the frictional forces set up, and it continues to move at a constant velocity. If this is the case the distances then travelled are proportional to the time taken. The effect can be investigated by the following experiment in which a wax pellet falls in water.

Make a small pear-shaped float out of softened wax and weight it at the tip with lead shot so that it maintains its balance without sinking to the bottom or floating on the surface of water contained in a measuring cylinder or large graduated test tube. Take a length of thread measuring exactly 98 cm and attach a small weight to one end, thus making a pendulum which takes exactly one second to swing from side to side. Support this so that it swings near to, and behind, the measuring cylinder. Carefully place the lump of wax on the surface of the water (where it will remain motionless, owing to the resistance of the water at the surface). Push the wax gently with your finger so that it begins to sink through the water and at the same time set the pendulum swinging. Observe the divisions which the wax is opposite each time the pendulum passes the vertical.

Repeat the experiment once or twice, and from the observations find how many divisions the wax falls through per second.

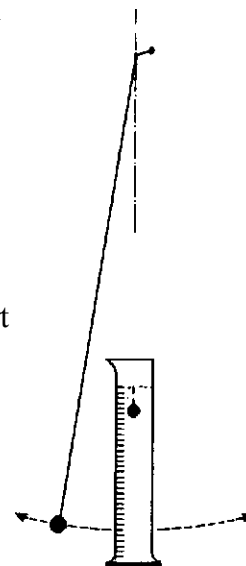

7 The acceleration of a falling ball

The change in speed per second of a moving body is called the acceleration. When it is constant as in the case of a ball falling under the action of the earth's gravity, it can easily be measured. In this particular case it is generally represented by the symbol g . In the following experiment, the fall of a metal ball is intercepted by a lath about 120 cm long swinging from a nail fitting loosely onto a hole near one end.

The period of swing of the pendulum is first found, using a clock to time, say, 100 swings. The ball, which has a small hook attached, is then blackened and hung from a thread which passes over smooth nails and also pulls aside the lath from the vertical position, as shown in the diagram. On burning the thread, the ball and lath are released simultaneously and the ball will hit the lath. From the position of impact, the distance fallen vertically by the ball in one quarter of the period of the lath can be found.

Using the relationship

$$\text{distance fallen} = 0.5g (\text{time of fall})^2$$

g can be calculated.

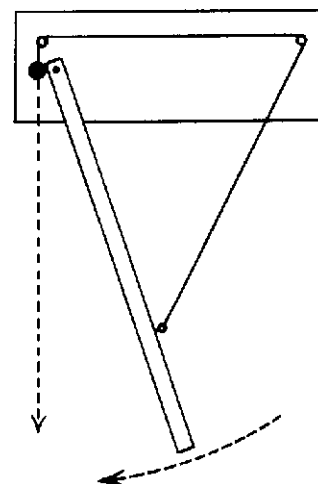

8 Path of a projectile

The apparatus below can be used to show the independence of the horizontal and vertical velocities of a projectile. The projectile is a metal ball, and the target is a small tin can hanging from an electromagnet. The circuit of the electromagnet includes two bared wires which are fixed parallel to and each side of the axis of a cardboard tube, projecting about 2.5 cm beyond the end. An old thermometer case is suitable for this part of the apparatus. A large ball bearing is placed inside the tube, being prevented from falling through by the narrow end. The electrical circuit is completed by a short length of copper wire resting on the projecting wires. Fix the tube in a stand so that it points at the target. Blow up the tube; as the ball passes the muzzle it will displace the copper wire and release the tin can. The ball and target will meet in mid-air. The experiment can be repeated using different angles and distances.

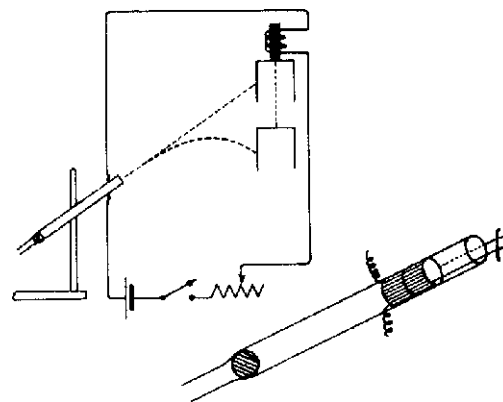

9 Fun with a pendulum

Suspend a hard ball about 8 cm in diameter on a cord over a table. The cord should be at least 1.5 m in length and should be just high enough off the table to hit the top of a pencil which has been placed in a cotton reel and rests on the table. Pull the pendulum and release it in such a way that it misses the pencil on the outward swing and knocks it over on the backward swing. You will find that it requires a great deal of practice to become skilful at this.

10 Shifting pendulums

Obtain two soda water bottles that are exactly the same size. Fill them with water and cork tightly. Place a rod across the back of two chairs. Suspend bottles as pendulums from the rod. Be sure that they are the same length.

Hold one pendulum and start the other swinging; then release the first one to hang at its zero point. Soon the swinging pendulum will slow down, and the one that was quiet will take up the swing.

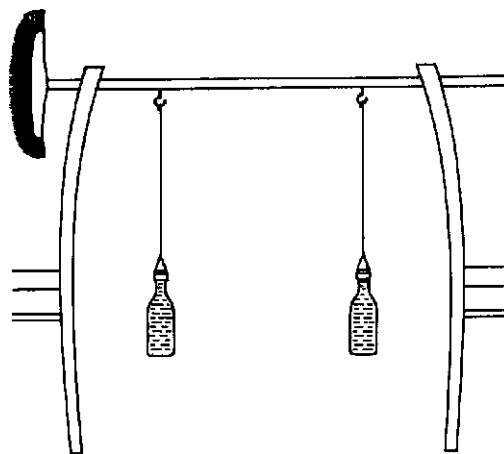

C. CENTRIFUGAL FORCE

1 Feeling centrifugal force

Tie a weight to a string about a metre in length and then whirl the weight around at arm's length. Observe the outward pull on the string. This is centrifugal force.

Replace the string with a strong rubber band. Cautiously whirl the weight on the rubber band. Observe the stretch in the rubber. This is caused by centrifugal force.

2 A simple rotation machine

Secure a breast-drill or hand-drill such as the one shown in the diagram. Clamp a small screw eye or cup hook in the chuck of the drill. Attach a 30 cm length of light string near the point end of a spike. Make a loop in the other end of the string and attach it to the screw eye in the chuck of the drill.

Now rotate the drill steadily by crank. Observe how the centrifugal force affects the suspended spike.

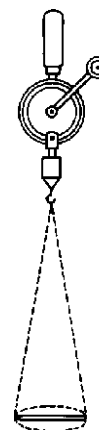

3 An experiment with two spikes

Use the drill for a rotation machine as in the above experiment. Join two spikes by attaching the point end of each to the end of a 15 cm length of cord. Grasp the cord joining the spikes at its centre and attach it to the cord from the drill chuck at this point. Rotate the drill crank steadily and observe the effect of the centrifugal force on the two spikes.

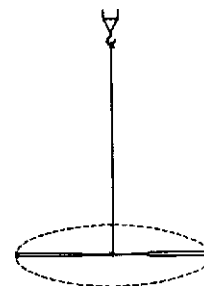

4 Centrifugal force with a ring

Secure an iron ring about 6 cm in diameter and attach it to the cord on the drill. Observe the effects.

5 Centrifugal force with a tin can lid

Punch a hole near the edge of a tin can lid. Attach it to the cord from the drill and observe the effects of rotation.

6 Centrifugal force with a beaded chain

Secure a length of beaded chain like that frequently used for pull cord on electric light switches or for key chains. Fasten the ends together to make a ring. Attach this to the string from the drill and observe the effects of centrifugal force.

7 Centrifugal force with a liquid

Obtain a small goldfish bowl or glass jar. Fasten a wire securely about the neck. To this wire attach a bale. Attach the cord from the drill chuck to the exact centre of the bale. Place about 3 cm of water coloured with ink in the bowl. Turn the drill handle to spin the bowl and water. Observe the effects of centrifugal force on the water.

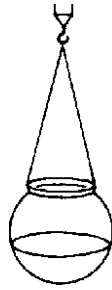

8 Another experiment with water

Suspend a tin can about 8 cm deep and 12 cm in diameter as shown in the diagram. Pour about 3 cm of water into the can and spin the drill. Observe what happens to the water.

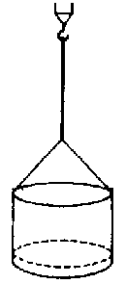

9 How a centrifugal clothes dryer works

Use a can similar to the one used in the last experiment. Punch the sides full of holes with a nail. Punch three holes equidistant from each other around the top of the can. Suspend with three cords and attach these to the screw eye in the drill chuck. Make a cylinder out of cardboard or find a pail a little deeper than the can and considerably wider. Place a bit of wet cloth in the can attached to the drill. Lower the can into the cylinder or pail and spin it rapidly with the drill. The water is thrown out of the cloth and can by the centrifugal force.

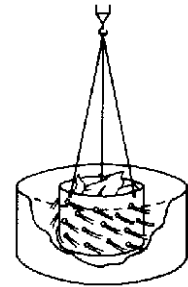

10 The water will not spill

Obtain a small pail and fill it nearly full with water. Swing it around rapidly at arms' length and the water will not spill because of centrifugal force.

11 Fun with centrifugal force

Find a wire coat hanger and place the hook over the first finger of your hand with the base resting on the table. Carefully balance a small coin on the straight wire at the bottom and directly under the hook. This requires some skill. If you need to, you can flatten a small space on the bar with a file or hammer.

Gently start to swing the hanger and coin on your finger. When it has gained a little motion, and with practice, you can swing the hanger around in a circle, the coin will be held to the wire by centrifugal force.

12 Centripetal force

Sir Isaac Newton first looked at the above effects in another way. He suggested that motion in a straight line is most natural, and that deviations from this type of motion are caused by a force pulling the body out of line. When the force acts on the body from a fixed point, such a body moves in a circle, and the force towards the centre is called a centripetal force.

Circular motion can be studied by the apparatus shown in the diagram. The force producing circular motion with different radii and frequency can be measured. Cut a piece of glass tubing 15 cm long and about 1 cm external diameter. Heat one end in a Bunsen flame until the walls of the tube are smoothly rounded. Wrap two layers of adhesive tape round the outside of the tube to provide a grip. Tie a two-holed rubber stopper to the end of about 1.5 m of nylon braided fishing line. Pass the other end of the line down the axis of the tube, and hang half a dozen 1 cm iron washers from it. A wire paper fastener can be used as weight carrier. Pull up the line so that the distance from the top of the tube to the cork is 1 m. Grip the glass tube and swing it in a small circle above your head so that the rubber stopper moves in a horizontal circle; the force of gravity on the washers provides the horizontal force needed to keep the stopper moving in a circle. Use a small alligator clip on the vertical fishing line to check that the motion is steady, and record the frequency of revolution required to keep the body moving in a path radius 1 m when different numbers of washers are hung from the carrier.

The relation $F = m 4(\pi)^2 f^2 R$ can also be examined, keeping the frequency f constant. This presents a little more experimental difficulty, but a suitable simple pendulum is helpful as a reference in both experiments.

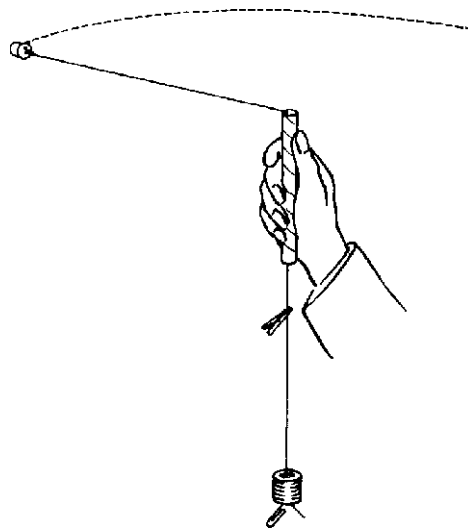

D. EXPERIMENTS ON INERTIA

1 A bottle and marble

Pour some sand into a wide mouthed bottle. Place a piece of cardboard about 5 cm square over the mouth of the bottle. Set the marble on the cardboard and then tap the edge of the cardboard. If the experiment is successful, and it may require practice, the cardboard will be set in motion and will go flying off while the inertia of the marble causes it to drop into the bottle.

2 Driving nails with the help of inertia

Extend a thin board over the edge of a table and support it well by having someone stand on the part over the table. Try to drive a nail into the board near the end which is not supported by the table. Next have someone hold a heavy hammer or stone under the board. Observe that it is now easy to drive the nail because of the inertia of the weight.

3 Cut an apple in two parts with inertia

Secure a long sharp knife such as a carving knife. Cut into the apple with the knife until you can pick them up together. Be sure to have enough of the end of the knife sticking out to enable you to strike it. Now hold knife and apple securely in one hand and strike the end of the knife a sharp blow with a stick. The knife will move through the apple because of the inertia of the apple.

4 Inertia with a handkerchief and tumbler

Spread a handkerchief out on a smooth table top. Place a tumbler filled with water near one corner of the handkerchief. Raise the opposite corner and give the handkerchief a sharp jerk. The tumbler will stand still, and no water will spill.

5 Inertia in a pile of books

Stack up a pile of books. Grasp hold of the one at the bottom of the pile and give it a quick jerk. Can you remove it without upsetting the whole pile on top?

6 Break a stick with inertia

Secure a small stick 18 to 20 cm in length. If no other stick is available a lead pencil will do. Fold a newspaper and place it near the edge of a table. Place the stick under the newspaper on the table and let about half the stick extend over the edge. Strike the stick a sharp blow with another. Inertia should cause the one on the table to break in two parts.

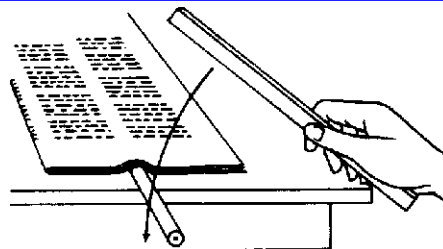

7 Inertia with a spade

Scoop up a spadeful of dry earth. Now pitch the earth away from you. Observe that when the spade stops the earth flies on because of inertia.

8 Inertia on a bicycle

Get your bicycle going and then apply the brakes quickly. Observe the tendency of your body to stay in motion and pitch you over the handlebars. This is the result of the inertia of your body.

9 Inertia in an automobile

You can observe the same effect as in experiment 8 when you are riding in a car that is suddenly stopped. You have to brace yourself to keep from sliding off the seat. Your body is in motion with the car and tends to stay in motion after the car is stopped.

When you are sitting in a car that is at rest and the car is suddenly started, observe that you are thrown backward because of inertia. Your body is at rest and it tends to stay at rest when the car is started.

10 Inertia with a stone

You will need a stone weighing about 1 kg for this experiment. Wrap a length of heavy string about the stone. Now, on opposite sides of the stone, attach half-metre lengths of lighter cord to the heavier cord. The lighter cord should be barely strong enough to support the stone when it is suspended. Next carefully suspend the stone above a table top. Place a length of board on the table under the stone so that the table top will not be dented when the rock strikes it. Grasp the lower end of the string firmly and give it a quick jerk. If you are successful, the lower string will break and leave the stone suspended. The inertia of the stone caused this. Now take hold of the remaining length of the lower string and pull steadily on it. This time the upper string breaks and the stone falls to the table because the steady application of force (rather than the quick jerk) set the stone in motion.

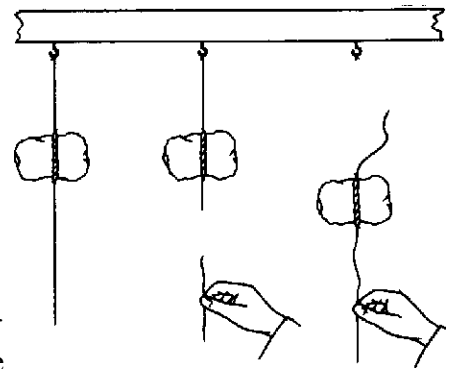

11 How to identify a hard-boiled egg

Secure a fresh egg and a hard-boiled egg. Give each of them a spinning motion in a soup dish or a plate. Observe that the hard-boiled one spins longer. The inertia of the fluid contents of the fresh one brings it to rest sooner.

E. FORCE AND MOTION

1 A light object moves faster

Mark off a half-metre on a table top with chalk. Divide this equally into centimetres. Secure a long rubber band and two spring clothes pegs. Attach a clothes peg to each end of the rubber band. Now grasp the clothes pegs while they rest on the table top. Place them along the marked-off place on the table top. Stretch the rubber band to a distance of about 15 cm and release each clothes peg at the same instant. Observe that they meet half way.

Next, clamp two clothes pegs on one side of the band and one on the other side. Stretch the band to a distance of about 24 cm and release. Where do they meet this time?

Repeat, attaching two clothes pegs on each end of the band. Where do they meet?

Again repeat with two on one side and three on the other. Where do they meet this time?

Can you draw a conclusion from this experiment?

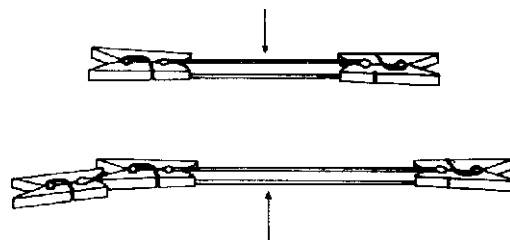

2 An experiment with force and motion

Tie a spring clothes peg open by placing one winding of thread about the long ends. Place the clothes peg in the centre of a long table and put two pencils of about equal size and weight one on either side of, and against the tied end of the clothes peg. Carefully burn the thread and observe the pencils. They are given speeds in opposite directions.

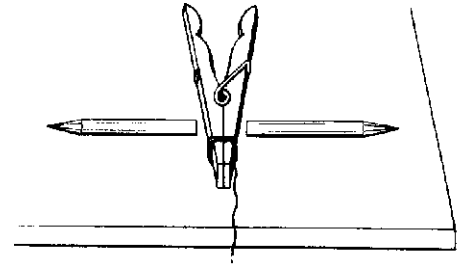

Repeat the experiment, using two larger pencils of about equal weight and size. What do you observe? Compare with the first results.

Repeat, using a large and heavier pencil on one side and a small, lighter pencil on the other side. What do you observe?

If you can secure some metal balls and marbles, repeat, using different combinations of metal balls and marbles.

Can you draw a conclusion from this experiment?

3 Action and reaction in pushing forces

Forces work in pairs. If you push against a wall, the wall pushes with equal force back against you. Secure two kitchen spring balances with square platform tops. Put the tops together with the dial faces up. Have a pupil push on one while you push on the other. Observe that when you push together each balance reads the same.

4 Action and reaction in polling forces

Secure two spring balances. Make a loop in each end of a short piece of strong cord. Attach a spring balance to each end and have two pupils pull in opposite directions. Make a reading on each balance and compare them.

5 Action and reaction with a roller skate

Place a roller skate on a smooth floor. Step on the roller skate with one foot and take a step forward with the other. Observe that the skate moves backward in the opposite direction.

6 Action and reaction in a boat

Step from a free row boat to land and observe that the boat moves in the opposite direction.

7 Jet propulsion is made possible by action and reaction

Fit a small cardboard stabilizer to the neck of a balloon by means of adhesive tape. Inflate the balloon, and close the mouth with your fingers. When the air contained under pressure in the balloon is allowed to escape, the balloon will be propelled forward by the force of the escaping air. This is the principle used in rockets and jet engines.

