

ASME A17.1-2013/CSA B44-13
(Revision of ASME A17.1-2010/CSA B44-10)

Safety Code for Elevators and Escalators

**Includes Requirements for Elevators,
Escalators, Dumbwaiters, Moving Walks,
Material Lifts, and Dumbwaiters With
Automatic Transfer Devices**

AN AMERICAN NATIONAL STANDARD



**The American Society of
Mechanical Engineers**



**CSA
Group**

INTENTIONALLY LEFT BLANK

ASME A17.1-2013/CSA B44-13
(Revision of ASME A17.1-2010/CSA B44-10)

Safety Code for Elevators and Escalators

**Includes Requirements for Elevators,
Escalators, Dumbwaiters, Moving Walks,
Material Lifts, and Dumbwaiters With
Automatic Transfer Devices**

AN AMERICAN NATIONAL STANDARD



Date of Issuance: October 21, 2013

The next edition of this Code is scheduled for publication in 2016. This Code will become effective 6 months after the Date of Issuance.

ASME issues written replies to inquiries concerning interpretations of technical aspects of this Code. Interpretations are published on the ASME Web site under the Committee Pages at <http://cstools.asme.org/> as they are issued. Interpretations will also be included with each edition.

Errata to codes and standards may be posted on the ASME Web site under the Committee Pages to provide corrections to incorrectly published items, or to correct typographical or grammatical errors in codes and standards. Such errata shall be used on the date posted.

The Committee Pages can be found at <http://cstools.asme.org/>. There is an option available to automatically receive an e-mail notification when errata are posted to a particular code or standard. This option can be found on the appropriate Committee Page after selecting “Errata” in the “Publication Information” section.

ASME is the registered trademark of The American Society of Mechanical Engineers.

This code or standard was developed under procedures accredited as meeting the criteria for American National Standards. The Standards Committee that approved the code or standard was balanced to assure that individuals from competent and concerned interests have had an opportunity to participate. The proposed code or standard was made available for public review and comment that provides an opportunity for additional public input from industry, academia, regulatory agencies, and the public-at-large.

ASME does not “approve,” “rate,” or “endorse” any item, construction, proprietary device, or activity.

ASME does not take any position with respect to the validity of any patent rights asserted in connection with any items mentioned in this document, and does not undertake to insure anyone utilizing a standard against liability for infringement of any applicable letters patent, nor assumes any such liability. Users of a code or standard are expressly advised that determination of the validity of any such patent rights, and the risk of infringement of such rights, is entirely their own responsibility.

Participation by federal agency representative(s) or person(s) affiliated with industry is not to be interpreted as government or industry endorsement of this code or standard.

ASME accepts responsibility for only those interpretations of this document issued in accordance with the established ASME procedures and policies, which precludes the issuance of interpretations by individuals.

No part of this document may be reproduced in any form,
in an electronic retrieval system or otherwise,
without the prior written permission of the publisher.

The American Society of Mechanical Engineers
Two Park Avenue, New York, NY 10016-5990

Copyright © 2013 by
THE AMERICAN SOCIETY OF MECHANICAL ENGINEERS
All rights reserved
Printed in U.S.A.

CONTENTS

| | |
|---|------|
| ASME Foreword | viii |
| ASME Committee Roster | xiii |
| CSA Committees | xix |
| ASME Preface | xxi |
| CSA Preface | xxiv |
| Summary of Changes | xxv |
| Part 1 | |
| General | 1 |
| 1.1 Scope | 1 |
| 1.2 Purpose and Exceptions | 2 |
| 1.3 Definitions | 2 |
| Part 2 | |
| Electric Elevators | 19 |
| 2.1 Construction of Hoistways and Hoistway Enclosures | 19 |
| 2.2 Pits | 21 |
| 2.3 Location and Guarding of Counterweights | 23 |
| 2.4 Vertical Clearances and Runbys for Cars and Counterweights | 24 |
| 2.5 Horizontal Car and Counterweight Clearances | 26 |
| 2.6 Protection of Space Below Hoistways | 27 |
| 2.7 Machinery Spaces, Machine Rooms, Control Spaces, and Control Rooms | 27 |
| 2.8 Equipment in Hoistways, Machinery Spaces, Machine Rooms, Control Spaces, and Control Rooms | 35 |
| 2.9 Machinery and Sheave Beams, Supports, and Foundations | 37 |
| 2.10 Guarding of Equipment and Standard Railing | 39 |
| 2.11 Protection of Hoistway Openings | 39 |
| 2.12 Hoistway Door Locking Devices and Electric Contacts, and Hoistway Access Switches | 47 |
| 2.13 Power Operation of Hoistway Doors and Car Doors | 52 |
| 2.14 Car Enclosures, Car Doors and Gates, and Car Illumination | 57 |
| 2.15 Car Frames and Platforms | 66 |
| 2.16 Capacity and Loading | 70 |
| 2.17 Car and Counterweight Safeties | 74 |
| 2.18 Speed Governors | 78 |
| 2.19 Ascending Car Overspeed and Unintended Car Movement Protection | 81 |
| 2.20 Suspension Means and Their Connections | 83 |
| 2.21 Counterweights | 91 |
| 2.22 Buffers and Bumpers | 93 |
| 2.23 Car and Counterweight Guide Rails, Guide-Rail Supports, and Fastenings | 95 |
| 2.24 Driving Machines and Sheaves | 104 |
| 2.25 Terminal Stopping Devices | 107 |
| 2.26 Operating Devices and Control Equipment | 111 |
| 2.27 Emergency Operation and Signaling Devices | 122 |
| 2.28 Layout Drawings | 139 |
| 2.29 Identification | 139 |
| 2.30 Sway Control Guides | 140 |
| Part 3 | |
| Hydraulic Elevators | 141 |
| 3.1 Construction of Hoistways and Hoistway Enclosures | 141 |

| | | |
|---------------|--|-----|
| 3.2 | Pits | 141 |
| 3.3 | Location and Guarding of Counterweights | 141 |
| 3.4 | Bottom and Top Clearances and Runbys for Cars and Counterweights | 141 |
| 3.5 | Horizontal Car and Counterweight Clearances | 142 |
| 3.6 | Protection of Spaces Below Hoistway | 142 |
| 3.7 | Machinery Spaces, Machine Rooms, Control Spaces, and Control Rooms | 143 |
| 3.8 | Electrical Equipment, Wiring, Pipes, and Ducts in Hoistway, Machinery Spaces, Machine Rooms, Control Spaces, and Control Rooms | 143 |
| 3.9 | Machinery and Sheave Beams, Supports, and Foundations | 143 |
| 3.10 | Guarding of Exposed Auxiliary Equipment | 143 |
| 3.11 | Protection of Hoistway Landing Openings | 144 |
| 3.12 | Hoistway Door Locking Devices, Electric Contacts, and Hoistway Access Switches | 144 |
| 3.13 | Power Operation, Power Opening, and Power Closing of Hoistway Doors and Car Doors or Gates | 144 |
| 3.14 | Car Enclosures, Car Doors and Gates, and Car Illumination | 144 |
| 3.15 | Car Frames and Platforms | 144 |
| 3.16 | Capacity and Loading | 145 |
| 3.17 | Car Safeties, Counterweight Safeties, Plunger Gripper, and Governors | 145 |
| 3.18 | Hydraulic Jacks | 147 |
| 3.19 | Valves, Pressure Piping, and Fittings | 149 |
| 3.20 | Ropes and Rope Connections | 152 |
| 3.21 | Counterweights | 152 |
| 3.22 | Buffers and Bumpers | 152 |
| 3.23 | Guide Rails, Guide-Rail Supports, and Fastenings | 153 |
| 3.24 | Hydraulic Machines and Tanks | 153 |
| 3.25 | Terminal Stopping Devices | 153 |
| 3.26 | Operating Devices and Control Equipment | 155 |
| 3.27 | Emergency Operation and Signaling Devices | 157 |
| 3.28 | Layout Data | 158 |
| 3.29 | Identification | 158 |
| Part 4 | Elevators With Other Types of Driving Machines | 159 |
| 4.1 | Rack-and-Pinion Elevators | 159 |
| 4.2 | Screw-Column Elevators | 161 |
| 4.3 | Hand Elevators | 165 |
| Part 5 | Special Application Elevators | 169 |
| 5.1 | Inclined Elevators | 169 |
| 5.2 | Limited-Use/Limited-Application Elevators | 175 |
| 5.3 | Private Residence Elevators | 180 |
| 5.4 | Private Residence Inclined Elevators | 188 |
| 5.5 | Power Sidewalk Elevators | 191 |
| 5.6 | Rooftop Elevators | 195 |
| 5.7 | Special Purpose Personnel Elevators | 199 |
| 5.8 | Marine Elevators | 204 |
| 5.9 | Mine Elevators | 205 |
| 5.10 | Elevators Used for Construction | 208 |
| 5.11 | Wind Turbine Tower Elevators | 213 |
| 5.12 | Outside Emergency Elevators | 229 |
| Part 6 | Escalators and Moving Walks | 230 |
| 6.1 | Escalators | 230 |
| 6.2 | Moving Walks | 243 |

| | | |
|----------------|---|-----|
| Part 7 | Dumbwaiters and Material Lifts | 254 |
| 7.1 | Power and Hand Dumbwaiters Without Automatic Transfer Devices | 254 |
| 7.2 | Electric and Hand Dumbwaiters Without Automatic Transfer Devices | 258 |
| 7.3 | Hydraulic Dumbwaiters Without Automatic Transfer Devices | 264 |
| 7.4 | Material Lifts Without Automatic Transfer Devices | 266 |
| 7.5 | Electric Material Lifts Without Automatic Transfer Devices | 270 |
| 7.6 | Hydraulic Material Lifts Without Automatic Transfer Devices | 275 |
| 7.7 | Automatic Transfer Devices | 277 |
| 7.8 | Power Dumbwaiters With Automatic Transfer Devices | 277 |
| 7.9 | Electric Material Lifts With Automatic Transfer Devices | 278 |
| 7.10 | Hydraulic Material Lifts With Automatic Transfer Devices | 279 |
| 7.11 | Material Lifts With Obscured Transfer Devices | 279 |
| Part 8 | General Requirements | 280 |
| 8.1 | Security | 280 |
| 8.2 | Design Data and Formulas | 281 |
| 8.3 | Engineering Tests, Type Tests, and Certification | 300 |
| 8.4 | Elevator Seismic Requirements | 308 |
| 8.5 | Escalator and Moving Walk Safety Requirement for Seismic Risk Zone 2 or Greater | 333 |
| 8.6 | Maintenance, Repair, Replacement, and Testing | 334 |
| 8.7 | Alterations | 357 |
| 8.8 | Welding | 375 |
| 8.9 | Code Data Plate | 375 |
| 8.10 | Acceptance Inspections and Tests | 376 |
| 8.11 | Periodic Inspections and Witnessing of Tests | 393 |
| 8.12 | Flood Resistances | 399 |
| Part 9 | Reference Codes, Standards, and Specifications | 400 |
| 9.1 | Reference Documents | 401 |
| 9.2 | Procurement Information | 408 |
| Figures | | |
| 2.16.1.1 | Inside Net Platform Areas for Passenger Elevators | 71 |
| 2.20.9.4 | Tapered Rope Sockets | 87 |
| 2.20.9.5 | Wedge Rope Sockets | 88 |
| 2.23.3 | Elevator Guide Rails | 96 |
| 2.23.4.1-1 | Maximum Weight of a Car With Rated Load or of Counterweight With Safety Device for a Pair of Guide Rails as Specified in 2.23.4.1 | 98 |
| 2.23.4.1-2 | Minimum Moment of Inertia About x - x Axis for a Single Guide Rail With Its Reinforcement | 99 |
| 2.27.3.1.6(h) | Visual Signal | 128 |
| 2.27.3.3.7 | Panel Layout | 131 |
| 2.27.7.1 | Phase I Emergency Recall Operation Instructions | 134 |
| 2.27.7.2 | Phase II Emergency In-Car Operation | 134 |
| 2.27.8 | FEO-K1 Key | 135 |
| 2.27.9 | Elevator Corridor Call Station Pictograph | 136 |
| 5.1.17.3 | Vertical and Horizontal Components of Velocity | 174 |
| 6.1.3.3.10 | Dimensions | 232 |
| 6.1.6.9.1 | Caution Sign | 241 |
| 8.2.1.2 | Minimum Rated Load for Passenger Elevators | 282 |
| 8.2.2.5.1 | Turning Moment Based on Class of Loading | 285 |
| 8.2.4 | Gravity Stopping Distances | 287 |
| 8.2.5 | Maximum Governor Tripping Speeds | 288 |
| 8.2.6 | Stopping Distances for Type B Car and Counterweight Safeties | 290 |

| | | |
|----------------|---|-----|
| 8.2.7 | Minimum Factors of Safety of Suspension Members of Power Passenger and Freight Elevators | 293 |
| 8.2.8.1.1 | Allowable Gross Loads | 295 |
| 8.2.9.1.3 | Load Distribution | 298 |
| 8.4.3.1.3 | Arc of Contact | 310 |
| 8.4.8.2-1 | 12 kg/m (8 lb/ft) Guide-Rail Bracket Spacing | 312 |
| 8.4.8.2-2 | 16.5 kg/m (11 lb/ft) Guide-Rail Bracket Spacing | 313 |
| 8.4.8.2-3 | 18 kg/m (12 lb/ft) Guide-Rail Bracket Spacing | 314 |
| 8.4.8.2-4 | 22.5 kg/m (15 lb/ft) Guide-Rail Bracket Spacing | 315 |
| 8.4.8.2-5 | 27.5 kg/m (18.5 lb/ft) Guide-Rail Bracket Spacing | 316 |
| 8.4.8.2-6 | 33.5 kg/m (22.5 lb/ft) Guide-Rail Bracket Spacing | 317 |
| 8.4.8.2-7 | 44.5 kg/m (30 lb/ft) Guide-Rail Bracket Spacing | 318 |
| 8.4.8.2-8 | Car and Counterweight Load Factor | 319 |
| 8.4.8.9 | Guide-Rail Axes | 324 |
| 8.4.10.1.1 | Earthquake Elevator Equipment Requirements Diagrammatic Representation | 325 |
| 8.4.10.1.3 | Earthquake Emergency Operation Diagrammatic Representation | 326 |
| 8.6.8.15.19(e) | | 353 |
| Tables | | |
| 2.4.2.2 | Minimum Bottom Runby for Counterweight Elevators With Spring Buffers or Solid Bumpers and Rheostatic Control or Single-Speed AC Control | 25 |
| 2.15.10.1 | Maximum Allowable Stresses in Car Frame and Platform Members and Connections, for Steels Specified in 2.15.6.2.1 and 2.15.6.2.2 | 69 |
| 2.16.1.1 | Maximum Inside Net Platform Areas for the Various Rated Loads | 71 |
| 2.17.3 | Maximum and Minimum Stopping Distances for Type B Car Safeties With Rated Load and Type B Counterweight Safeties | 75 |
| 2.18.2.1 | Maximum Car Speeds at Which Speed Governor Trips and Governor Overspeed Switch Operates | 79 |
| 2.18.7.4 | Multiplier for Determining Governor Sheave Pitch Diameter | 81 |
| 2.20.3 | Minimum Factors of Safety for Suspension Members | 84 |
| 2.20.9.4.5 | Relation of Rope Diameter to Diameter of the Small Socket Hole | 88 |
| 2.22.3.1 | Minimum Spring Buffer Stroke | 93 |
| 2.22.4.1 | Minimum Oil Buffer Strokes | 94 |
| 2.23.3 | T-Section Guide-Rail Dimensions | 96 |
| 2.23.4.2 | Load Multiplying Factor for Duplex Safeties | 102 |
| 2.23.4.3.1 | Guide Rails for Counterweight Without Safeties | 103 |
| 2.23.4.3.3 | Intermediate Tie Brackets | 103 |
| 2.23.7.2.1 | Minimum Thickness of Fishplates and Minimum Diameter of Fastening Bolts | 104 |
| 2.23.10.2 | Minimum Size of Rail-Fastening Bolts | 104 |
| 2.26.4.3.2 | SIL for Electrical Protective Devices and Other Electrical Safety Functions | 118 |
| 2.26.12.1 | Symbol Identification | 123 |
| 4.1.9.1 | Maximum and Minimum Stopping Distances for Rack-and-Pinion Safeties With Rated Load | 161 |
| 5.1.14.2 | Minimum and Maximum Stopping Distances at Given Angles From Horizontal | 173 |
| 5.1.17.2 | Spring Buffer Stroke | 173 |
| 5.1.17.4.4 | Minimum Oil Buffer Strokes at Given Angle From Horizontal | 174 |
| 6.2.3.7 | Treadway Width | 245 |
| 6.2.4 | Treadway Speed | 247 |
| 7.2.6.4 | Factors of Safety for Wire Rope and Chains | 261 |
| 7.2.8.1 | Minimum Spring Buffer Strokes | 262 |
| 7.2.8.2 | Minimum Oil Buffer Strokes | 262 |
| 7.4.3 | Type B Material Lifts | 267 |

| | | |
|--------------------------------|---|-----|
| 7.9.2.13 | Minimum Spring Buffer Strokes | 279 |
| 7.9.2.14 | Minimum Oil Buffer Strokes | 279 |
| 8.4.8.7 | Stresses and Deflections of Guide-Rail Brackets and Supports | 322 |
| 8.4.11.13 | Pipe Support Spacing | 328 |
| 8.4.12.2.2 | Maximum Allowable Deflection | 331 |
| 8.6.4.20.4 | Brake Test Loads | 345 |
| Nonmandatory Appendices | | |
| A | Control System | 411 |
| B | Unlocking Zone | 413 |
| C | Location of Top Emergency Exit | 414 |
| D | Rated Load and Capacity Plates for Passenger Elevators | 415 |
| E | Elevator Requirements for Persons With Physical Disabilities in Jurisdictions Enforcing NBCC | 416 |
| F | Ascending Car Overspeed and Unintended Car Movement Protection | 424 |
| G | Top of Car Clearance | 428 |
| H | Private Residence Elevator Guarding (5.3.1.6.2) | 433 |
| I | Escalator and Moving Walk Diagrams | 434 |
| J | Relationship of Pit Ladder to Hoistway Door Unlocking Means | 441 |
| K | Beveling and Clearance Requirements (7.4.7.4) | 442 |
| L | Index of Alteration Requirements for Electric Elevators, Hydraulic Elevators, Escalators, and Moving Walks | 443 |
| M | Inertia Application for Type A Safety Device Location of Test Weight [8.10.2.2.2(ii)(2)] | 448 |
| N | Recommended Inspection and Test Intervals in “Months” | 449 |
| P | Plunger Gripper Stopping Distances | 457 |
| Q | Explanatory Figures for the Definitions of Elevator Machinery Space, Machine Room, Control Space, Control Room, Remote Machine Room, or Remote Control Room | 458 |
| R | Inspection Operation and Hoistway Access Switch Operation Hierarchy | 461 |
| S | Vertically Sliding Doors — Illustrations of Detection Zones (2.13.3.4) | 463 |
| T | Inspection and Replacement of Steel Wire Ropes | 476 |
| U | Design Requirements — Traction Elevator Suspension System | 478 |
| V | Building Features for Occupant Evacuation Operation | 479 |
| W | Wind Turbine Tower Elevator Clearances | 481 |
| X | Acceptance Tests | 482 |
| Y | Maintenance Control Program Records | 486 |
| Index | | 490 |

ASME FOREWORD

The first edition of this Code was published in January 1921. It was prepared by an American Society of Mechanical Engineers (ASME) Committee on Protection of Industrial Workers with the assistance of representatives of a number of interests including manufacturers, insurance carriers, regulatory bodies, and technical societies.

Subsequently, ASME requested the American Engineering Standards Committee (AESC) to authorize the organization of a Sectional Committee to undertake this revision. They acted favorably on this request, and in January 1922, assigned sponsorship for the project jointly to the American Institute of Architects, the National Bureau of Standards, and ASME, all three of whom had taken an active part in the preparation of the first edition of the Code.

The organization meeting of the Sectional Committee A17 was held in November 1922. A number of meetings of the Committee were held during the next two years and in July 1925, a revision of the 1921 Code was completed, approved by the AESC, and published as an American Standard.

Subsequent to the publication of the 1925 revision of the Code, the necessity for development research on the design and construction of car safeties and oil buffers and for the development of test specifications for various parts of elevator equipment was realized.

As a result, a Subcommittee on Research, Recommendations, and Interpretations was appointed in 1926. This subcommittee held regular meetings thereafter until interrupted by the war in 1940, and carried on an extensive test program at the National Bureau of Standards in connection with oil buffers and car safeties. Subsequent to the war, the name of this subcommittee was changed to "Executive Committee for the Elevator Safety Code."

The information gained as a result of these tests, together with the developments that had occurred in the design of the equipment as a result of installations made in very tall buildings, prompted the Sectional Committee to prepare and issue the third edition of the Code in 1931. The third edition was approved by the Sectional Committee in February 1931, and subsequently by the sponsors and by the American Standards Association (formerly the AESC) in July 1931.

Further experience and developments in the design of elevator equipment, led the Sectional Committee, in line with its policy of revising the Code periodically, to prepare the fourth edition in 1937, which was approved

by the sponsors and by the American Standards Association (ASA) in July 1937.

A fifth edition of the Code was well under way in 1940 when it was necessary to suspend the work due to the Second World War. However, a number of the revisions already agreed upon by the Sectional Committee and approved by the sponsors and by the ASA in April 1942, were issued as a supplement to the 1937 edition. They were subsequently incorporated in a reprint of the 1937 edition in 1945. In response to public demand, requirements for private residence elevators were also issued in a separate supplement, ASA A17.1.5-1953, and incorporated into the Code as Part V in the 1955 edition.

The Sectional Committee reinitiated consideration of the fifth edition of the Code in 1946. Due to the considerable period which had elapsed since the fourth revision in 1937, and to the very extensive developments in the elevator art, the committee decided that the Code should be completely rewritten and brought up to date.

Special subcommittees were appointed to prepare the revisions of the various requirements. The membership of each subcommittee consisted of persons especially familiar with the requirements to be covered by that subcommittee. Fifteen subcommittees were set up with a total membership of over 150 persons. The membership of these subcommittees was not confined to members of the Sectional Committee. It also included other persons having expert knowledge of the subjects under consideration by the subcommittees. These subcommittees and their personnel were listed in the 1955 edition of the Code.

The drafts prepared by these subcommittees were widely circulated to interested groups for comment. After review of the comments and correlation of the drafts, the fifth edition of the Code was approved by the Sectional Committee, subsequently by the sponsors, and by the ASA in June 1955.

In December 1957, a Supplement to the Code listing a number of revisions was approved by the ASA and published by ASME.

A sixth edition was published in 1960 which incorporated the revisions contained in the 1957 Supplement as well as approximately 96 revisions which were approved by the Sectional Committee in March 1960.

In 1958 the scope of the A17 Code was enlarged to include moving walks. The membership of the Sectional Committee was expanded to include manufacturers whose primary interest in the Committee was the development of rules and regulations on moving walks. A

subcommittee prepared a Safety Code for Moving Walks which was approved by the Sectional Committee, the sponsors, and by the ASA on March 20, 1962. This Code was published as Part XIII of the A17.1 Code, and was designated ASA A17.1.13-1962.

During 1962 and 1963, 38 additional changes to Parts I through XII of A17.1 were approved by the Sectional Committee, the sponsors, and the ASA, and were published as the 1963 Supplement to the 1960 edition of the Code.

A seventh edition was published in 1965 which incorporated the rules of the Safety Code for Moving Walks, ASA A17.1.13-1962, as Part XIII, the revisions covered by the 1963 Supplement as well as approximately 90 other revisions approved by the Sectional Committee, the sponsors, and the ASA. The title of the Code was also changed to the American Standard Safety Code for Elevators, Dumbwaiters, Escalators, and Moving Walks.

On August 24, 1966, the American Standards Association was reconstituted as the United States of America Standards Institute. The designation of standards approved as American Standards was changed to USA Standards. There was no change in the index identification or the technical content of the standards. At the same time, the ASA Sectional Committee, A17 on A Safety Code for Elevators, was changed to the USA Standards Committee, A17 on A Safety Code for Elevators. Four supplements to this edition were published from 1967 through 1970.

The United States of America Standards Institute later changed its name to American National Standards Institute, Incorporated (ANSI) on October 6, 1969. At the time that the new name became effective, the designation USA Standard was changed to American National Standard and the name of committees changed from USA Standards Committees to American National Standards Committees. The alphabetical designation of standard documents was changed from USA to ANSI.

The eighth edition of the Code (1971) incorporated the revisions covered by the four supplements and an additional 94 revisions. Seven supplements were issued from 1972 through 1976. Part XIV covering Material Lifts and Dumbwaiters with Automatic Transfer Devices was added in supplement ANSI A17.1d-1975.

The ninth edition of the Code (1978) incorporated 75 revisions in addition to those covered by the previous supplements. Part XV covering Special Purpose Personnel Elevators was added and the Reference Codes, Standards, and Specifications were moved from the Preface to a new Part XVI. Two supplements to this edition were issued in 1979 and 1980.

The tenth edition of the Code (1981) incorporated the revisions covered by Supplements ANSI A17.1a-1979 and ANSI A17.1b-1980, as well as the following new material: Part XVII, Inclined Elevators; Appendix F, Seismic Regulations; and Appendix G, Recommended

Practice for Accelerating Moving Walks. Rule 211.3 and Part V were also completely revised, with the Private Residence Inclined Lifts moved to Part XVIII. Numerous other revisions and additions were also included which were approved since the time of the 1980 supplement.

The tenth edition of the Code was approved by the A17 Standards Committee. Since that time, the committee was reorganized in accordance with the ANSI Accredited Organization Method under the sponsorship of ASME. With this reorganization, the National Bureau of Standards and the American Institute of Architects relinquished their roles as cosecretariats. The Standards, Conference, and Executive Committees were also restructured as the Main Committee and the National Interest Review Committee, with the Working Committees (subcommittees) continuing to operate as before.

This reorganization also prompted a change in the title of the Code to the ANSI/ASME A17.1 Safety Code for Elevators and Escalators. The title was also shortened for convenience, and it should not be construed that the Code no longer covers dumbwaiters, moving walks, or the other equipment included within the Scope of the Code.

Two supplements to the 1981 edition were issued: ANSI/ASME A17.1a-1982 and ANSI/ASME A17.1b-1983. The 1982 supplement included a new Part XIX covering Elevators Used for Construction. In the 1983 supplement, the requirements for Private Residence Inclined Lifts in Part XVIII were expanded and incorporated into a new Part XXI covering Private Residence Inclined Stairway Chairlifts and Inclined and Vertical Wheelchair Lifts. Part XX was added to cover these same devices installed in buildings other than private residences. Requirements for Screw Column Elevators were also added and designated as Part XVIII.

The eleventh edition of the Code (1984) incorporated the changes made in the 1982 and 1983 supplements, as well as additional revisions.

The eleventh edition was updated with five supplements which were issued approximately every 6 months in 1985 through the spring of 1987. Appendix I (since redesignated as Appendix E) was added in ANSI/ASME A17.1a-1985. Requirements for rack and pinion elevators were added in ANSI/ASME A17.1c-1986, designated as Part XVI. The previous Part XVI (Reference Codes, Standards, and Specifications) was moved to Section 4 of the Introduction. In ANSI/ASME A17.1d-1986, the requirements for sidewalk elevators in Part IV, and alterations in Part XII, were completely revised.

The twelfth edition of the Code incorporated the changes made in supplements A17.1a-1985 through A17.1e-1987, as well as additional revisions. Among these changes was a complete revision of the requirements for dumbwaiters in Part VII. The format of the

Code was also changed editorially to incorporate Exceptions into the body of the Rules.

The thirteenth edition of the Code incorporated the changes made in A17.1a-1988 and A17.1b-1989 as well as additional revisions. Part XXII, Shipboard Elevators, was added in A17.1b-1989. Part XXIII, Rooftop Elevators, appeared for the first time in this edition.

The fourteenth edition of the Code incorporates the changes made in A17.1a-1991 and A17.1b-1992 as well as the revisions shown in the Summary of Changes. Safety requirements for seismic risk zone 3 and greater were moved from Appendix F into new Part XXIV, Elevator Safety Requirements for Seismic Risk Zone 2 or Greater. Requirements for seismic risk zone 2 were added to Part XXIV.

The fifteenth edition of the Code incorporates the changes made in A17.1a-1994 and A17.1b-1995 as well as the revisions shown in the Summary of Changes. Part XXV, Limited Use/Limited Application Elevators, was added in A17.1b-1995. The rules in Part III have been harmonized with the CAN/CSA B44, Elevator Safety Standard, Sections 4 and 11, and Appendix G4.

The sixteenth edition of the Code incorporates changes made in A17.1a-1997 through A17.1d-2000. Requirements for Mine Elevators have also been added in Section 5.9 of this edition. In addition, the entire Code was reformatted to incorporate a decimal numbering system. For this edition of the Code cross-reference tables have been provided in order to facilitate the correlation between requirements from the fifteenth edition of the Code to the renumbered requirements of the sixteenth edition and vice versa. It is also noted, that this edition of A17.1 was the result of a joint effort between the ASME A17 Elevator and Escalator Committee and the CSA B44 Technical Committee to harmonize requirements between the ASME A17.1, Safety Code for Elevators and Escalators, and the CSA B44, Safety Code for Elevators.

The seventeenth edition of the Code incorporates changes made in A17.1a-2002 and A17.1b-2003. Additionally, in Sections 8.10 and 8.11, cross-references have been updated to reflect ASME A17.2-2001, Guide for Inspection of Elevators, Escalators, and Moving Walks.

The eighteenth edition of the Code is a fully bi-national standard. All former deviations between the ASME A17.1 Code and the CSA B44 Code have been fully addressed within this one Code. Additionally, this edition incorporates revisions to address the advancement of technologies used in the design and construction of elevator equipment which has enabled the installation of the equipment in other than traditional locations such as machine rooms. New requirements have also been

added to address programmable electronic systems in safety-related applications of elevators.

The nineteenth edition of the Code incorporates changes made in A17.1a-2008 and A17.1b-2009. Major changes include former periodic inspections now being covered under maintenance requirements. New requirements have been added to address the means and members of suspension, compensation, and governor systems for elevators. These new requirements are covered in detail through reference to ASME A17.6, which includes the material properties, design, testing, inspection, and replacement criteria for these means. It includes the requirements for steel wire rope, aramid fiber rope, and noncircular elastomeric-coated steel suspension members and provides direction for future constructions as new technology develops.

This twentieth edition of the Code contains well over one hundred revisions made to existing requirements, as well as some new requirements being added, since the publication of the nineteenth edition.

New requirements have been added to address new types of elevator equipment being used in the industry, specifically wind turbine elevators and outside emergency elevators. In addition, requirements have been added to address a new feature called Elevator Evacuation Operation (EEO) which allows for the use of elevators for occupant evacuation.

Besides the above, several major changes include the following:

(a) An extensive update to the seismic requirements of the Code that have been revised to include seismic force levels as specified in the latest building codes in the US (IBC) and Canada (NBCC). In order to facilitate incorporation of these requirements, a *Guide for Elevator Seismic Design* has been separately published.

(b) Requirements have been updated related to the maintenance control program in order to improve clarity and organization for records, content, availability, and format.

(c) Regarding qualifications for elevator inspectors (QEI), effective January 1, 2014, accreditation of organizations that certify elevator inspectors and inspection supervisors is being discontinued by The American Society of Mechanical Engineers. Requirements have been revised in this area to allow for accreditation to be done by other organizations.

The following is a complete list of past editions and supplements to the Code that have been published and the dates when they received final approval. The dates of issuance are also included for the documents published since 1974, and the dates on which they became effective are included for those published since 1978.

| Editions and Supplements | | Approved | Issued | Effective |
|--------------------------|-----------------------|-------------------|--------------------|--------------------|
| First Edition | 1921 | January 1921 | ... | ... |
| Second Edition | A17-1925 | April 1925 | ... | ... |
| Third Edition | ASA A17-1931 | July 1931 | ... | ... |
| Fourth Edition | ASA A17.1-1937 | July 1937 | ... | ... |
| Supplements | ASA A17.3-1942 | April 1942 | ... | ... |
| | ASA A17.1.5-1953 | June 9, 1953 | ... | ... |
| Fifth Edition | ASA A17.1-1955 | June 15, 1955 | ... | ... |
| Supplements | ASA A17.1a-1957 | December 10, 1957 | ... | ... |
| Sixth Edition | ASA A17.1-1960 | August 29, 1960 | ... | ... |
| Supplements | ASA A17.1.13-1962 | March 20, 1962 | ... | ... |
| | ASA A17.1a-1963 | August 16, 1963 | ... | ... |
| Seventh Edition | ASA A17.1-1965 | July 29, 1965 | ... | ... |
| Supplements | USAS A17.1a-1967 | July 7, 1967 | ... | ... |
| | USAS A17.1b-1968 | December 11, 1968 | ... | ... |
| | USAS A17.1c-1969 | May 6, 1969 | ... | ... |
| | ANSI A17.1d-1970 | March 2, 1970 | ... | ... |
| Eighth Edition | ANSI A17.1-1971 | July 27, 1971 | ... | ... |
| Supplements | ANSI A17.1a-1972 | February 16, 1972 | ... | ... |
| | ANSI A17.1b-1973 | October 11, 1973 | ... | ... |
| | ANSI A17.1c-1974 | April 26, 1974 | September 15, 1974 | ... |
| | ANSI A17.1d-1975 | February 26, 1975 | October 31, 1975 | ... |
| | ANSI A17.1e-1975 | March 26, 1975 | October 31, 1975 | ... |
| | ANSI A17.1f-1975 | April 2, 1975 | October 31, 1975 | ... |
| | ANSI A17.1g-1976 | August 12, 1976 | November 30, 1976 | ... |
| Ninth Edition | ANSI A17.1-1978 | May 4, 1978 | June 15, 1978 | September 15, 1978 |
| Supplements | ANSI A17.1a-1979 | February 5, 1979 | March 30, 1979 | June 30, 1979 |
| | ANSI A17.1b-1980 | March 20, 1980 | May 15, 1980 | August 15, 1980 |
| Tenth Edition | ANSI/ASME A17.1-1981 | September 8, 1981 | October 22, 1981 | April 22, 1982 |
| Supplements | ANSI/ASME A17.1a-1982 | October 5, 1982 | November 30, 1982 | May 30, 1983 |
| | ANSI/ASME A17.1b-1983 | October 24, 1983 | December 23, 1983 | June 23, 1984 |
| Eleventh Edition | ANSI/ASME A17.1-1984 | August 16, 1984 | September 16, 1984 | March 16, 1985 |
| Supplements | ANSI/ASME A17.1a-1985 | February 27, 1985 | April 15, 1985 | October 15, 1985 |
| | ANSI/ASME A17.1b-1985 | August 6, 1985 | October 15, 1985 | April 15, 1986 |
| | ANSI/ASME A17.1c-1986 | March 5, 1986 | April 30, 1986 | October 31, 1986 |
| | ANSI/ASME A17.1d-1986 | September 8, 1986 | November 30, 1986 | May 31, 1987 |
| | ANSI/ASME A17.1e-1987 | February 18, 1987 | April 30, 1987 | October 30, 1987 |
| Twelfth Edition | ASME/ANSI A17.1-1987 | October 20, 1987 | January 15, 1988 | July 16, 1988 |
| Supplements | ASME/ANSI A17.1a-1988 | October 6, 1988 | November 15, 1988 | May 16, 1989 |
| | ASME/ANSI A17.1b-1989 | November 10, 1989 | November 30, 1989 | May 31, 1990 |
| Thirteenth Edition | ASME A17.1-1990 | October 8, 1990 | February 8, 1991 | August 9, 1991 |
| Supplements | ASME A17.1a-1991 | October 21, 1991 | February 28, 1992 | August 29, 1992 |
| | ASME A17.1b-1992 | October 28, 1992 | December 29, 1992 | June 30, 1993 |
| Fourteenth Edition | ASME A17.1-1993 | October 18, 1993 | December 31, 1993 | July 1, 1994 |
| Supplements | ASME A17.1a-1994 | August 17, 1994 | December 31, 1994 | July 1, 1995 |
| | ASME A17.1b-1995 | October 5, 1995 | January 31, 1996 | August 1, 1996 |

| Editions and Supplements | | Approved | Issued | Effective |
|------------------------------------|------------------------------|--------------------|-------------------|-------------------|
| Fifteenth Edition Supplements | ASME A17.1–1996 | October 3, 1996 | December 31, 1996 | July 1, 1997 |
| | ASME A17.1a–1997 | January 8, 1998 | February 27, 1998 | August 28, 1998 |
| | ASME A17.1b–1998 | November 13, 1998 | February 19, 1999 | August 20, 1999 |
| | ASME A17.1c–1999 | May 13, 1999 | June 30, 1999 | December 31, 1999 |
| Sixteenth Edition Supplements | ASME A17.1d–2000 | October 12, 2000 | November 30, 2000 | January 31, 2001 |
| | ASME A17.1–2000 | October 16, 2000 | March 23, 2001 | March 23, 2002 |
| | ASME A17.1a–2002 | February 26, 2002 | April 4, 2002 | October 4, 2002 |
| Seventeenth Edition Supplements | ASME A17.1b–2003 | April 10, 2003 | May 30, 2003 | November 30, 2003 |
| | ASME A17.1–2004 | January 14, 2004 | April 30, 2004 | October 31, 2004 |
| | ASME A17.1a–2005 | March 18, 2005 | April 29, 2005 | October 29, 2005 |
| Eighteenth Edition Supplements | ASME A17.1S–2005 | March 23, 2005 | August 12, 2005 | February 12, 2006 |
| | ASME A17.1-2007/CSA B44-07 | February 20, 2007 | April 6, 2007 | October 6, 2007 |
| | ASME A17.1a-2008/CSA B44a-08 | September 19, 2008 | December 5, 2008 | June 5, 2009 |
| Nineteenth Edition | ASME A17.1b-2009/CSA B44b-09 | November 17, 2009 | December 30, 2009 | June 30, 2010 |
| | ASME A17.1-2010/CSA B44-10 | October 19, 2010 | December 30, 2010 | June 30, 2011 |
| Twentieth Edition | ASME A17.1-2013/CSA B44-13 | May 31, 2013 | October 21, 2013 | April 21, 2014 |

ASME A17 ELEVATOR AND ESCALATOR COMMITTEE

(October 2012)

STANDARDS COMMITTEE

H. E. Peelle III, *Chair*
J. W. Coaker, *Vice Chair*
R. A. Gregory, *Vice Chair*
G. A. Burdeshaw, *Secretary*
E. V. Baker, IUEC
M. D. Morand, *Alternate*, IUEC
T. D. Barkand, U.S. Department of Labor
R. E. Baxter, Baxter Residential Elevators, LLC
K. S. Lloyd, Jr., *Alternate*, Abell Elevator International
L. Bialy, Otis Elevator Co.
B. D. Black, BD Black & Associates
J. R. Brooks, Wagner Consulting Group, Inc.
J. W. Coaker, Coaker & Co., PC
J. A. Filippone, Port Authority of New York and New Jersey
J. H. Humphrey, *Alternate*, Port Authority of New York and New Jersey
C. C. Fox, Rainbow Security Control Ltd.
B. D. Fox, *Alternate*, Fox & Sons Quality Elevator Inspection
G. W. Gibson, George W. Gibson and Associates, Inc.
R. S. Seymour, *Alternate*, Robert L. Seymour and Associates, Inc.
R. A. Gregory, Vertex Corp.
R. F. Hadaller, Technical Standards and Safety Authority
M. Tevyaw, *Alternate*, Technical Standards and Safety Authority
P. Hampton, ThyssenKrupp Elevator Co.
R. J. Walker, *Alternate*, ThyssenKrupp Elevator Co.
J. T. Herrity, VTE
A. P. Juhasz, KONE, Inc.
D. A. Kalgren, KONE, Inc.
D. S. Boucher, *Alternate*, KONE, Inc.
J. W. Koshak, Elevator Safety Solutions, Inc.
H. Simpkins, *Alternate*, ThyssenKrupp Elevator Co.
N. B. Martin, State of Ohio
Z. R. McCain, Jr., McCain Engineering Associates, Inc.
M. V. Farinola, *Alternate*, MV Farinola, Inc.
D. McColl, Otis Canada, Inc.
J. L. Meyer, Bureau Veritas
H. E. Peelle III, The Peelle Co., Ltd.
S. P. Reynolds, *Alternate*, The Peelle Co., Ltd.
A. Rehman, Schindler Elevator Corp.
V. P. Robibero, Schindler Elevator Corp.
C. W. Rogler, State of Michigan
J. H. Shull, J. H. Shull Engineering, LLC
D. M. Stanlaske, NAESA International
D. L. Turner, Davis L. Turner & Associates
R. S. Caporale, *Alternate*, Elevator World, Inc.
A. H. Verschell, Dwan Elevator
G. W. Kosinski, *Alternate*, EIWPF
D. A. Witham, GAL Manufacturing
J. Varon, *Alternate*, GAL Manufacturing

Honorary Members

L. J. Blaiotta
E. A. Donoghue
H. E. Godwin, Jr.
C. E. Hempel
C. L. Kort
A. A. Mascone
E. M. Philpot
R. L. Rogers
C. E. Vlahovic
L. E. White

Regulatory Advisory Council

N. B. Martin, *Chair*
J. L. Borwey, *Vice Chair*
G. A. Burdeshaw, *Staff Secretary*
D. McLellan, *Secretary*
G. Antona
G. Barnes
J. H. Burpee
J. R. Calpini
P. Caploon
J. Day
N. C. Dimitruck
M. Dorosk
C. Gardiner
L. A. Giovannetti
J. M. Gould
A. N. Griffin
R. F. Hadaller
W. J. Hartung
S. J. Hickory
D. Holmes
C. C. Mann
M. J. Mellon, Jr.
I. D. Mercer
S. Mercier
K. P. Morse
M. E. Pedersen
M. R. Poulin
W. Reinke
J. P. Roche
C. W. Rogler
A. Smith
J. Stewart
M. K. Stewart
S. F. Stout
L. M. Taylor
D. Tudor
L. E. Watson
W. C. Watson
W. J. Witt
R. Kaspersma, *Contributing Member*
D. M. Stanlaske, *Contributing Member*
D. L. Barker, *Alternate*
D. Melvin, *Alternate*

NATIONAL INTEREST REVIEW GROUP

G. A. Burdeshaw, *Secretary*
J. P. Andrew
D. M. Begue
R. J. Blatz
J. E. Brannon
M. T. Brierley
B. B. Calhoun
J. A. Caluori
C. S. Carr
M. A. Chavez
R. F. Dieter
B. Faerber
H. S. Frank
J. G. Gerck
L. A. Giovannetti
J. M. Gould
S. H. Grainer
N. R. Herchell
J. E. Herwig
R. Howkins
J. M. Imgarten
J. Inglis
T. Isaacs
Q. JianXiong
F. A. Kilian

M. Krstanoski
M. L. Lane
W. R. Larsen
M. A. Malek
J. J. Mancuso
C. C. Mann
N. E. Marchitto
D. Mason
J. L. Meyer
T. S. Mowrey
F. G. Newman
J. W. O'Boyle
J. J. O'Donoghue
B. Peyton
M. J. Pfeiffer
M. R. Poulin
P. M. Puno
L. Rigby
J. R. Runyan
R. D. Schloss
S. Shanes
J. L. Stabler
D. M. Stanlaske
D. A. Swerrie

B44.1/A17.5 ELEVATOR AND ESCALATOR ELECTRICAL EQUIPMENT COMMITTEE

M. L. Hite, *Chair*
J. H. Shull, *Chair*
G. A. Burdeshaw, *Staff Secretary*
M. Dodd, *Secretary*
P. D. Barnhart
J. W. Blain
J. D. Busse
J. Caldwell
J. L. Della Porta
D. A. Donner

B. T. Irmacher
J. Lee
R. A. Mackenzie
P. F. McDermott
B. Mierzejewski
M. Mihai
A. Zemanek
M. L. Jaremko, *Alternate*
O. Simonetta, *Alternate*
R. S. Williams, *Alternate*

CODE COORDINATION COMMITTEE

B. D. Black, *Chair*
G. A. Burdeshaw, *Secretary*
L. Bialy
R. Cote
J. W. Koshak
V. Robibero
B. Tubbs

R. Bukowski, *Contributing Member*
P. Caploon, *Contributing Member*
G. W. Gibson, *Contributing Member*
K. Paarlberg, *Alternate*

DUMBWAITER AND ATD COMMITTEE

D. Witt, *Chair*
J. B. Peskuski, *Vice Chair*
R. Mohamed, *Secretary*

R. A. Gregory
R. Helps
B. P. McCune

EARTHQUAKE SAFETY COMMITTEE

B. Blackaby, *Chair*
W. E. Schadrack III, *Vice Chair*
M. Gerson, *Secretary*
L. C. Barulich
G. A. Gibson
A. Jahn
R. Lorenzo

J. L. Meyer
W. C. Ribeiro
A. J. Schiff
A. J. Shelton
M. J. Smith
D. A. Kalgren, *Alternate*
R. D. Shepherd, *Alternate*

EDITORIAL COMMITTEE

G. A. Burdeshaw, *Secretary*
B. D. Black

J. Filippone
D. McColl

ELECTRICAL COMMITTEE

B. Blackaby, *Chair*
J. Caldwell, *Vice Chair*
D. Henderson, *Vice Chair*
C. R. Ramcharran, *Secretary*
T. D. Barkand
P. D. Barnhart
J. W. Blain
J. D. Busse
S. J. Carlton
B. C. Castillo
J. L. Della Porta
J. P. Donnelly
W. J. Hartung
G. N. Henry
A. P. Juhasz
P. F. McDermott
B. Ortiz
A. L. Peck
D. K. Prince
V. P. Robibero

S. P. Wood
S. H. Benjamin, *Contributing Member*
R. Elias, *Contributing Member*
S. E. Fisher, *Contributing Member*
Y. C. Ho, *Contributing Member*
T. G. Moskal, *Contributing Member*
P. M. Puno, *Contributing Member*
M. Stergulg, *Contributing Member*
J. C. Carlson, *Alternate*
M. Mihai, *Alternate*
J. C. Ramos, *Alternate*
J. H. Shull, *Alternate*

ELEVATORS USED FOR CONSTRUCTION COMMITTEE

N. B. Martin, *Chair*
G. A. Burdeshaw, *Secretary*
R. E. Baxter
C. C. Fox

R. A. Gregory
J. A. Lowery, Jr.
C. W. Rogler

EMERGENCY OPERATIONS COMMITTEE

C. Koenig, *Chair*
M. Tevyaw, *Vice Chair*
C. R. Ramcharran, *Secretary*
D. R. Beste
B. D. Black
J. C. Carlson
R. B. Fraser
D. Henderson
S. R. James
J. Latham
J. A. Marinelli
D. McColl
S. A. Morse
C. H. Murphy
T. F. Norton
J. J. O'Donoghue
D. K. Prince
P. D. Rampf
A. Rehman
L. F. Richardson
D. Warne
D. J. Winslow
D. A. Witham
M. Abbott, *Contributing Member*
T. Bitz, *Contributing Member*

EMERGENCY PERSONNEL COMMITTEE

C. C. Fox, *Chair*
D. L. Turner, *Vice Chair*
G. A. Burdeshaw, *Secretary*
J. R. Brooks
R. S. Caporale
D. L. Flint
J. L. Meyer

ESCALATOR AND MOVING WALK COMMITTEE

D. L. Turner, *Chair*
T. R. Nurnberg, *Vice Chair*
R. Mohamed, *Secretary*
P. R. Bothwell
P. E. A. Burge
D. R. Evans
J. G. Gerck
R. A. Glanzmann
K. M. Harris
H. A. Hausmann
R. Herndobler
J. A. Kinahan
D. McLellan
R. D. Shepherd
K. J. Smith
J. L. Stabler

M. T. Brierley, *Contributing Member*
M. W. Bunker, Jr.,
Contributing Member
P. Caploon, *Contributing Member*
G. B. Cassini, *Contributing Member*
D. P. Cook, *Contributing Member*
D. Holmes, *Contributing Member*
M. Martin, *Contributing Member*
B. F. O'Neill, *Contributing Member*
R. C. Burch, *Contributing Member*
R. F. Hadaller, *Alternate*
J. K. O'Donnell, *Alternate*
G. G. Rees, *Alternate*
R. Reiswig, *Alternate*
R. J. Roux, *Alternate*
A. J. Shelton, *Alternate*

C. W. Rogler
R. S. Seymour
D. P. Cook, *Contributing Member*
J. J. O'Donoghue,
Contributing Member

P. Velasquez, Jr.
P. J. Welch
D. Winkelhake
P. L. Edwards, *Contributing Member*
J. Filippone, *Contributing Member*
C. Anayiotos, *Alternate*
C. Banks, *Alternate*
C. S. Carr, *Alternate*
K. G. Hamby, *Alternate*
T. P. Kenny, *Alternate*
A. Rehman, *Alternate*
D. E. Rush, *Alternate*
R. C. Shumate, *Alternate*

EXISTING INSTALLATIONS COMMITTEE

J. S. Rearick, *Chair*
D. B. Labrecque, *Vice Chair*
M. Gerson, *Secretary*
R. E. Baxter
J. Bera
C. A. Buckley
J. D. Carlisle
C. J. Duke
A. T. Gazzaniga
R. A. Gregory
J. A. Jaudes
R. Kremer
K. S. Lloyd, Jr.
G. M. Losey
P. McPartland
N. R. Mistry
R. C. Morrical
G. L. Nyborg III
S. A. Quinn
P. Reid
R. D. Shepherd
J. L. Stabler

G. Stiffler
H. M. Vyas
T. Waardenburg
J. H. Butler, *Contributing Member*
G. B. Cassini, *Contributing Member*
J. G. Gerck, *Contributing Member*
J. T. Herrity, *Contributing Member*
Z. R. McCain, Jr.,
Contributing Member
A. J. Saxer, *Contributing Member*
P. J. Welch, *Contributing Member*
E. A. Heath III, *Alternate*
D. Keller, *Alternate*
V. P. Robibero, *Alternate*
D. J. Winslow, *Alternate*

HAND AND SIDEWALK ELEVATOR COMMITTEE

N. J. Montesano, *Chair*
R. S. Caporale, *Vice Chair*
G. A. Burdeshaw, *Secretary*
V. G. Bahna
R. Carter
J. Doyle

J. Duffy
G. Greenberg
E. L. Krull, Jr.
C. P. Robinson
G. West

HOISTWAY COMMITTEE

D. McColl, *Chair*
S. P. Reynolds, *Vice Chair*
C. R. Ramcharran, *Secretary*
B. D. Black
D. S. Boucher
L. M. Capuano
A. S. Conkling
H. J. Gruszynski
R. F. Hadaller
E. A. Heath III
J. A. Marinelli
S. A. Morse
G. L. Nuschler
H. E. Peelle III
F. Regalado
A. Rehman
H. Simpkins
D. S. Warne
D. A. Witham

W. Ziegert
L. J. Blaiotta, *Contributing Member*
G. W. Gibson, *Contributing Member*
J. L. Harding, *Contributing Member*
D. Holmes, *Contributing Member*
L. C. Woods, *Contributing Member*
L. Bialy, *Alternate*
R. C. Burch, *Alternate*
F. R. Cooper, *Alternate*
D. P. Kraft, *Alternate*
R. K. Leckman, *Alternate*
W. M. Miller, *Alternate*
M. Tevyaw, *Alternate*

HYDRAULIC COMMITTEE

H. Simpkins, *Chair*
C. B. Jackson, *Vice Chair*
G. A. Burdeshaw, *Secretary*
D. M. Begue
L. Bialy
S. A. Bruno
M. G. Miller
T. S. Mowrey
M. J. Paschke
L. Rigby
J. L. Shrum
P. E. A. Burge, *Contributing Member*

C. C. Fox, *Contributing Member*
H. A. Hammerstrom, *Contributing Member*
A. Jahn, *Contributing Member*
C. W. Rogler, *Contributing Member*
B. Giddens, *Alternate*
K. A. Grunden, *Alternate*
J. W. Koshak, *Alternate*
A. M. McClement, *Alternate*
W. M. Shrum, Jr., *Alternate*

LIMITED-USE/LIMITED-APPLICATION ELEVATOR COMMITTEE

R. E. Baxter, *Chair*
P. Chance, *Vice Chair*
M. Gerson, *Secretary*
K. L. Brinkman
P. W. Lackler
S. J. Mehalko
R. J. Murphy
J. E. Newstrom
W. Richardson

J. P. Schumacher
F. C. Slater
A. H. Verschell
R. B. Weber
D. M. Winkle, Jr.
C. C. Fox, *Contributing Member*
M. L. McDonald, *Alternate*

INCLINED ELEVATOR COMMITTEE

J. R. Carrick, *Chair*
A. H. Verschell, *Vice Chair*
G. A. Burdeshaw, *Secretary*

J. T. Herrity
J. S. Rearick, *Contributing Member*

INSPECTIONS COMMITTEE

J. Filippone, *Chair*
M. Tevyaw, *Vice Chair*
R. Mohamed, *Secretary*
G. Antona
C. Archer
R. E. Baxter
J. R. Brooks
C. A. Buckley
J. Coaker
C. J. Duke
M. V. Farinola
K. Garst
P. Hampton
J. T. Herrity
J. J. Knolmayer
G. W. Kosinski
Z. R. McCain, Jr.
J. S. Rearick
A. Rehman
C. P. Robinson
C. W. Rogler
J. D. Rosenberger

J. R. Runyan
R. D. Schloss
R. S. Seymour
R. D. Shepherd
W. M. Snyder
D. M. Stanlaske
D. S. Warne
J. L. Borwey, *Contributing Member*
H. S. Frank, *Contributing Member*
R. F. Hadaller, *Contributing Member*
J. Strzelec, *Contributing Member*
P. G. Bender, *Alternate*
M. Boutin, *Alternate*
C. S. Carr, *Alternate*
D. McLellan, *Alternate*
M. D. Morand, *Alternate*
J. L. Stabler, *Alternate*
S. Swett, *Alternate*

MAINTENANCE, REPAIR, AND REPLACEMENT COMMITTEE

R. A. Gregory, *Chair*
D. B. Labrecque, *Vice Chair*
M. Gerson, *Secretary*
R. E. Baxter
C. J. Duke
M. V. Farinola
J. Filippone
S. Greene
J. A. Jaudes
R. Kremer
P. W. Lackler
K. S. Lloyd, Jr.
G. M. Losey
Z. R. McCain, Jr.
P. McPartland
J. L. Meyer
N. R. Mistry
M. D. Morand
R. C. Morrical
J. S. Rearick
P. Reid
V. P. Robibero
P. Rosenberg
R. D. Schloss
H. M. Vyas
T. Waardenburg
G. B. Cassini, *Contributing Member*
J. J. DeLorenzi, *Contributing Member*

J. G. Gerk, *Contributing Member*
R. F. Hadaller, *Contributing Member*
R. E. Haukeness, *Contributing Member*
J. T. Herrity, *Contributing Member*
A. S. Hopkirk, *Contributing Member*
J. J. Knolmayer, *Contributing Member*
D. McColl, *Contributing Member*
J. Murphy, *Contributing Member*
W. B. Pletch, *Contributing Member*
A. Rehman, *Contributing Member*
A. J. Saxer, *Contributing Member*
J. Strzelec, *Contributing Member*
C. Buckley, *Alternate*
C. S. Carr, *Alternate*
E. A. Heath III, *Alternate*
D. Keller, *Alternate*
J. L. Stabler, *Alternate*
D. J. Winslow, *Alternate*

INTERNATIONAL STANDARDS COMMITTEE

L. Bialy, *Chair*
V. P. Robibero, *Vice Chair*
G. A. Burdeshaw, *Secretary*
B. D. Black
B. Blackaby
R. S. Caporale
J. Coaker
G. W. Gibson
J. T. Herrity
A. P. Juhasz
G. A. Kopenhagen

J. W. Koshak
J. Popp
D. L. Turner
D. McColl, *Contributing Member*
J. Strzelec, *Contributing Member*
V. Q. Bates, Jr., *Alternate*
D. R. Evans, *Alternate*
D. A. Kalgren, *Alternate*
D. McKee, *Alternate*

MARINE ELEVATOR COMMITTEE

W. D. George, *Chair*
M. R. Tilyou, *Vice Chair*
G. A. Burdeshaw, *Secretary*
E. J. Crawford

T. J. Ingram
H. Moran
R. Wagner

MECHANICAL DESIGN COMMITTEE

L. Bialy, *Chair*
D. L. Turner, *Vice Chair*
R. J. Walker, *Vice Chair*
A. B. Byk, *Secretary*
E. V. Baker
F. Belio
C. C. Fox
G. W. Gibson
B. W. Horne
D. A. Kalgren
V. King
J. W. Koshak
R. Kremer
M. P. Lamb
A. Rehman
H. Simpkins
R. E. Creak, *Contributing Member*

H. S. Frank, *Contributing Member*
R. F. Hadaller, *Contributing Member*
K. Konyar, *Contributing Member*
M. Rhiner, *Contributing Member*
C. E. Vlahovic, *Contributing Member*
S. P. Wurth, *Contributing Member*
D. P. Kraft, *Alternate*
R. K. Leckman, *Alternate*
W. C. Ribeiro, *Alternate*

QUALIFICATION OF ELEVATOR INSPECTORS (QEI) COMMITTEE

J. R. Brooks, *Chair*
M. Tevyaw, *Vice Chair*
G. A. Burdeshaw, *Secretary*
E. V. Baker
R. E. Baxter
L. Bialy
B. D. Black
J. Coaker
J. Cosbey
D. L. Flint
G. W. Gibson
P. Hampton
J. T. Herrity
G. W. Kosinski
E. L. Krull, Jr.

J. A. Marchack
Z. R. McCain, Jr.
V. P. Robibero
C. P. Robinson
C. W. Rogler
J. R. Runyan
R. S. Seymour
D. M. Stanlaske
J. Strzelec
D. S. Warne
C. J. Duke, *Alternate*
D. McLellan, *Alternate*
J. L. Meyer, *Alternate*
M. D. Morand, *Alternate*
D. L. Turner, *Alternate*

MINE ELEVATOR COMMITTEE

N. B. Martin, *Chair*
M. Gerson, *Secretary*
C. C. Adkins, Sr.
C. D. Barchet
T. D. Barkand
W. M. Dietz
W. M. Heimbuch
M. G. Kalich
J. B. Ketchum

A. L. Martin
H. E. Newcomb
M. P. Snyder
J. K. Taylor
P. E. Fernatt, *Contributing Member*
A. J. Saxer, *Contributing Member*

RACK AND PINION AND SPECIAL PURPOSE PERSONNEL ELEVATOR COMMITTEE

G. A. Burdeshaw, *Staff Secretary*
S. Harris, *Secretary*
J. L. Borwey
T. A. Gross
K. M. Harrison
R. Kaspersma
J. W. Koshak

S. D. Larson
A. J. Marchant
R. C. Meiresonne
R. E. Haukeness, *Contributing Member*
B. L. O'Neill, *Contributing Member*
J. A. Harrison, *Alternate*

NEW TECHNOLOGY COMMITTEE

L. Bialy, *Chair*
D. McColl, *Vice Chair*
A. L. Guzman, *Secretary*
B. D. Black
R. S. Caporale
L. M. Capuano
T. M. Chambers
J. Coaker
M. Dodd
G. W. Gibson
A. N. Griffin
J. T. Herrity
A. P. Juhasz
D. A. Kalgren
R. Kaspersma

J. W. Koshak
G. W. Kosinski
J. L. Meyer
M. Mihai
M. Pedram
V. P. Robibero
D. Schroeter
D. W. Soos
D. M. Stanlaske
D. L. Turner
R. E. Baxter, *Alternate*
M. Chan, *Alternate*
M. D. Morand, *Alternate*
O. Simonetta, *Alternate*

RESIDENCE ELEVATOR COMMITTEE

K. L. Brinkman, *Chair*
A. H. Verschell, *Vice Chair*
M. Gerson, *Secretary*
T. M. Chambers
P. Chance
F. M. Hoch
S. D. Holat
C. S. Jones
T. C. Kingsley
P. W. Lackler
K. H. Lewis
M. Lewis
J. C. Lund
S. J. Mehalko
R. J. Murphy
J. E. Newstrom
T. L. Pope
W. Richardson

J. P. Schumacher
F. C. Slater
R. B. Weber
D. M. Winkle, Jr.
R. E. Baxter, *Contributing Member*
D. J. DeGere, *Contributing Member*
P. Edwards, *Contributing Member*
M. L. McDonald, *Contributing Member*
W. M. McKinley, *Contributing Member*
J. B. Peskuski, *Alternate*
J. Tometich, *Alternate*
G. Ziebell, *Alternate*

OUTSIDE EMERGENCY ELEVATOR COMMITTEE

G. L. Nuschler, *Chair*
W. C. Christensen
R. F. Fahy
J. K. O'Donnell

J. J. O'Donoghue
H. E. Peelle III
J. Shimshoni
D. M. Stanlaske

WIND TURBINE ELEVATOR COMMITTEE

| | |
|---|---------------------------|
| J. W. Koshak , <i>Chair</i> | M. J. Logan |
| R. J. Gromek , <i>Vice Chair</i> | D. Lohbeck |
| J. Asensio | A. J. Marchant |
| J. Ayerbe | K. Matharu |
| J. L. Borwey | J. S. Rearick |
| G. Brickell | G. A. Rogers |
| D. R. Brown | S. Rowles |
| J. R. Dunlop | G. Santos |
| S. H. Franklin | J. H. Shull |
| P. Grewal | C. Smith |
| T. A. Gross | D. W. Soos |
| J. J. Haigh | S. Swett |
| S. Harris | C. Vanhoutte |
| C. A. Heins | S. W. Weaver |
| J. T. Herrity | R. Weinmuller |
| R. Kaspersma | R. S. Yeatman, Jr. |
| G. J. Kolodziej | |

CSA B44 COMMITTEE ON THE ELEVATOR SAFETY CODE

TECHNICAL COMMITTEE

- R. Hadaller**, *Chair*, Technical Standards & Safety Authority, Toronto, Ontario, Canada
- D. McColl**, *Vice Chair*, Otis Canada, Inc., Mississauga, Ontario, Canada
- O. Simonetta**, *Project Manager*, CSA Group, Mississauga, Ontario, Canada
- C. Ayling**, Ayling Consulting Services, Inc., Mississauga, Ontario, Canada
- S. Bornstein**, KONE Inc., Toronto, Ontario, Canada
- D. Eastman**, Service NL, Newfoundland and Labrador, St. John's, Newfoundland, Canada
- M. Fournier**, STM (Montreal Transport Society), Montréal, Québec, Canada
- A. Griffin**, Alberta Municipal Affairs and Housing, Edmonton, Alberta, Canada
- R. Haukeness**, Technical Safety Authority of Saskatchewan, Regina, Saskatchewan, Canada
- A. Hopkirk**, Trident Elevator Co., Ltd., Scarborough, Ontario, Canada
- U. Huskic**, Toronto, Ontario, Canada
- K. Jenkins**, KJA Consultants Inc., Montréal, Québec, Canada
- G. Kappenhagen**, Stroudsburg, Pennsylvania, USA
- F. Kassem**, Ascenseurs ThyssenKrupp (Canada) Limitée, Montréal, Québec, Canada
- R. Kennedy**, Department of Labour and Advanced Education, Halifax, Nova Scotia, Canada
- J. Lee**, British Columbia Safety Authority (BCSA), New Westminster, British Columbia, Canada
- E. MacArthur**, Department of Environment, Energy and Forestry, Charlottetown, Prince Edward Island, Canada
- A. Marchant**, Alimak Hek, Inc., Shelton, Connecticut, USA
- R. Marsiglio**, H. H. Angus & Associates Ltd., Toronto, Ontario, Canada
- B. McIntyre**, IUEC Local No. 50, Scarborough, Ontario, Canada
- S. Mercier**, Régie du bâtiment du Québec, Montréal, Québec, Canada
- M. Pedram**, ThyssenKrupp Northern Elevator Corp., Scarborough, Ontario, Canada
- H. Peelle**, The Peelle Company Limited, Brampton, Ontario, Canada
- A. Procktor**, ARP Engineers, division of 1001845 Ontario Inc., Burlington, Ontario, Canada
- A. Rehman**, Schindler Elevator Corporation, Morristown, New Jersey, USA
- J. Rooney**, Priestman, Neilson & Associates Ltd., Kanata, Ontario, Canada
- R. Scharfe**, Public Works and Government Services Canada, Ottawa, Ontario, Canada
- B. Virk**, Unitech Elevator Company, Pickering, Ontario, Canada
- P. Yau**, Public Works and Government Services Canada, Toronto, Ontario, Canada

Associate Members

- T. Baik**, Toronto Transit Commission, Toronto, Ontario, Canada
- L. Bialy**, Otis Elevator Company, Farmington, Connecticut, USA
- M. Brierley**, Toronto Fire Service, Coldwater, Ontario, Canada
- D. Bruce**, Alberta Municipal Affairs, Edmonton, Alberta, Canada
- G. Burdeshaw**, The American Society of Mechanical Engineers, New York, New York, USA
- K. Cheong**, Applied Engineering Solutions Ltd., Vancouver, British Columbia, Canada
- E. Donoghue**, Edward A. Donoghue Associates, Inc., Salem, New York, USA
- K. Dunbar**, Government of the Northwest Territories, Yellowknife, Northwest Territories, Canada
- G. Gibson**, George W. Gibson & Associates, Inc., Sedona, Arizona, USA
- P. Girouard**, Plafolift Inc., Warwick, Québec, Canada
- A. Gower**, Manitoba Office of the Fire Commissioner, Winnipeg, Manitoba, Canada
- F. Kassem**, Ascenseurs ThyssenKrupp (Canada) Limitée, Montréal, Québec, Canada
- J. Koshak**, Elevator Safety Solutions Inc., Collierville, Tennessee, USA
- R. MacKenzie**, CSA Group, Toronto, Ontario, Canada
- A. McGregor**, Rooney, Irving & Associates, Ottawa, Ontario, Canada
- D. McLellan**, Technical Standards & Safety Authority, Toronto, Ontario, Canada
- I. Mercer**, Service NL, Newfoundland and Labrador, St. John's, Newfoundland, Canada
- M. Mihai**, Technical Standards & Safety Authority, Toronto, Ontario, Canada
- A. Reistetter**, National Elevator & Escalator Association, Mississauga, Ontario, Canada
- S. Reynolds**, The Pelle Company Limited, Brampton, Ontario, Canada
- J. Shull**, J. H. Shull Engineering, LLC, Southington, Connecticut, USA
- E. Sopeju**, Underwriters Laboratories of Canada, Scarborough, Ontario, Canada
- M. Tevyaw**, Technical Standards & Safety Authority, Toronto, Ontario, Canada
- J. Virk**, Unitech Elevator Company, Pickering, Ontario, Canada
- D. Walton**, Eastern Elevator Inc., Oshawa, Ontario, Canada
- D. Warne**, Alberta Elevating Devices & Amusement Rides Safety Association, Calgary, Alberta, Canada
- A. Zemanek**, CSA Group, Toronto, Ontario, Canada
- M. Zingarelli**, MAD Elevator Fixtures Inc., Etobicoke, Ontario, Canada

**CSA B44.1/ASME A17.5 JOINT COMMITTEE ON
ELEVATOR AND ESCALATOR ELECTRICAL
EQUIPMENT**

M. Hite, *Chair*, KONE Inc., Allen, Texas, USA

J. Della Porta, *Vice Chair*, Otis Elevator Co., Farmington, Connecticut, USA

O. Simonetta *Project Manager*, CSA Group, Mississauga, Ontario, Canada

P. Barnhart, Underwriters Laboratories, Inc., Research Triangle Park, North Carolina, USA

J. Blain, Schindler Elevator Corporation, New York, New York, USA

G. Burdeshaw, The American Society of Mechanical Engineers, New York, New York, USA

J. Busse, Fujitec America, Inc., Mason, Ohio, USA

J. Caldwell, ThyssenKrupp Elevator, Memphis, Tennessee, USA

S. Carlton, Underwriters Laboratories, Inc., Northbrook, Illinois, USA

D. Donner, KONE Inc., McKinney, Texas, USA

T. Evans, CSA Group, Toronto, Ontario, Canada

T. Irmscher, British Columbia Safety Authority, New Westminster, British Columbia, Canada

R. MacKenzie, CSA Group, Toronto, Ontario, Canada

P. McDermott, Technical Standards & Safety Authority, Toronto, Ontario, Canada

B. Mierzejewski, Otis Elevator Co., Farmington, Connecticut, USA

M. Mihai, Technical Standards & Safety Authority, Toronto, Ontario, Canada

B. Shah, Schindler Elevator Corp., Randolph, New Jersey, USA

J. Shull, J. H. Shull Engineering, LLC, Southington, Connecticut, USA

D. Stefancic, CSA Group, Mississauga, Ontario, Canada

R. Williams, Computerized Elevator Corp., Elmont, New York, USA

A. Zemanek, CSA Group, Toronto, Ontario, Canada

ASME PREFACE

(13)

GENERAL

This Code is one of the numerous codes and standards developed and published by The American Society of Mechanical Engineers (ASME) under the general auspices of the American National Standards Institute, Inc. (ANSI).

The Code is intended to serve as the basis for the design construction, installation, operation, testing, inspection, maintenance, alteration, and repair of elevators, dumbwaiters, escalators, moving walks, and material lifts.

Safety codes and standards are intended to enhance public health and safety. Revisions result from committee consideration of factors such as technological advances, new data, and changing environmental and industry needs. Revisions do not imply that previous editions were inadequate.

This Code applies to new installations only, except Part 1, and 5.10, 8.1, 8.6, 8.7, 8.8, 8.9, 8.10, and 8.11, which apply to both new and existing installations. Also, see ASME A17.3, Safety Code for Existing Elevators and Escalators, for further requirements.

The following conditions are not addressed in this Code:

- (a) assignment of the responsibility for compliance to any particular party.
- (b) establishment of a frequency for periodic inspections and tests. See Nonmandatory Appendix N for recommended inspections and test intervals.
- (c) assignment of responsibility for persons authorized to make and witness inspections and tests.

APPLICATION OF REQUIREMENTS TO NEW TECHNOLOGY

With the advent of new technologies, materials, and processes in the mechanical, structural, electronic, and optic fields, and the analytical capabilities now available, the need for flexibility to introduce products into the marketplace using these technical developments is desirable. Previous editions of ASME A17.1 had long-standing provisions, in Section 1.2, that suggested that Authorities Having Jurisdiction should recognize safety equivalent to that required by the Codes. This edition of ASME A17.1/CSA B44 recognizes ASME A17.7/CSA B44.7 provides a structured method for establishing the safety of designs and products and that compliance with ASME A17.7/CSA B44.7 is equivalent to compliance with the requirements in ASME A17.1/CSA B44.

FORM AND ARRANGEMENT

This Code consists of parts and sections, each covering a specific subject so as to facilitate reference to the requirements.

The Foreword, Preface, Notes, and Appendices that are included in this document, and the Interpretations that are provided as a separate booklet are not part of this American National Standard. They are advisory in nature and are intended for clarification only.

In this edition, the revisions that are appearing for the first time are identified by (13). Where editorial changes have been made, they are identified by (ED). See also Summary of Changes.

METRIC (SI) UNITS

This edition of the Code uses hard metric (SI) units wherever practical. The acceptable equivalent imperial units are shown in parentheses. Information on the usage of SI units and conversion to imperial units is contained in IEEE/ASTM SI 10-1997 Standard for the Use of the International System of Units (SI): The Modern Metric System, ASME Guide SI-1, Orientation and Guide for Use of SI (Metric) Units, or CAN/CSA-Z234.1, Canadian Metric Practice Guide.

Tables related to speed and load use the hard metric and hard imperial units in common practice, even though they are not exactly equivalent (e.g., see Table 2.22.4.1, Minimum Buffer Strokes). The tabular values have been derived using 8.2.1 formulas and the metric and imperial values for buffer strokes, safety stopping distances, etc., are therefore not equivalent.

ASME ELEVATOR PUBLICATIONS

The following ASME publications are of special interest to users of this Code. For prices and availability, contact:

ASME Order Department
22 Law Drive
Box 2300
Fairfield, NJ 07007-2300
Tel: 800-843-2763
Fax: 973-882-1717
E-Mail: infocentral@asme.org
ASME Website: www.asme.org/catalog

ASME A17.2, Guide for Inspection of Elevators, Escalators, and Moving Walks. This Guide gives detailed

procedures for the inspection and testing of elevators, escalators, and moving walks required to conform to the Safety Code for Elevators and Escalators, A17.1–1955 and later editions and the Safety Code for Existing Elevators and Escalators, A17.3. Subsections are arranged to focus on routine and periodic inspection requirements, as well as acceptance criteria.

ASME A17.3 Safety Code for Existing Elevators and Escalators. This Code covers retroactive requirements for existing elevators and escalators. The purpose of this Code is to establish minimum requirements that will provide a reasonable degree of safety for the general public. While many of these requirements will also increase the degree of safety for the elevator mechanic and inspector, this area has not been specifically addressed at this time.

ASME A17.4 Guide for Emergency Personnel. This guide for emergency personnel (fire, police, etc.), building owners, lessees, and building operating managers explains the proper procedures to be used for the safe removal of passengers from stalled cars.

CSA B44.1/ASME A17.5 Elevator and Escalator Electrical Equipment. This Code contains requirements for obtaining, labeling, and listing electrical equipment for elevators, escalators, moving walks, dumbwaiters, material lifts, platform lifts, and stairway lifts.

ASME A17.6 Standard for Elevator Suspension, Compensation, and Governor Systems. This Standard covers the means and members of suspension, compensation, and governor systems for elevators within the Scope of ASME A17.1/CSA B44. This Standard includes the material properties, design, testing, inspection, and replacement criteria for these means. It includes the requirements for steel wire rope, aramid fiber rope, and noncircular elastomeric-coated steel suspension members, and provides direction for future constructions as new technology develops.

ASME A17.7/CSA B44.7 Performance-Based Safety Code for Elevators and Escalators. This American National Standard performance-based safety code covers the design, construction, installation, operation, testing, maintenance, alteration, and repair of elevators, dumbwaiters, escalators, moving walks, and material lifts.

Published Interpretations. Interpretations of the various A17 standards are published periodically.

Interpretations of A17.1 and A17.2 approved by the A17 Committee from June 14, 1972 through June 1979, were published in a separate book in 1980.

Starting with the 1981 edition of the Code, interpretations are published with each new edition and supplement of the applicable standard. A compilation of Interpretations Nos. 2-13 (June 1979–May 1989) has also been published by ASME. A compilation of all interpretations can also be obtained through the A17 CD-ROM.

Handbook on A17.1/B44 Safety Code. This handbook augments the A17.1/B44 Code with commentary, diagrams, and illustrations that are intended to explain the requirements of the A17.1/B44 Code.

The commentary contained in the Handbook is the opinion of the author and has not been approved by the A17 Committee or the B44 Technical Committee.

QEI-1 Standard for the Qualification of Elevator Inspectors. This Standard covers requirements for the qualification and duties of inspectors and inspection supervisors engaged in the inspection and testing of equipment within the scope of the A17.1/B44 Code.

ASME A18.1 Safety Standard for Platform Lifts and Stairway Chairlifts. This safety Standard covers the design, construction, installation, operation, inspection, testing, maintenance, and repair of inclined stairway chairlifts and inclined and vertical platform lifts intended for transportation of a mobility impaired person only.

CORRESPONDENCE WITH A17 COMMITTEE

ASME codes and standards are developed and maintained with the intent to represent the consensus of concerned interests. As such, users of this and other ASME A17 codes and standards may interact with the committee by requesting interpretations, proposing revisions, and attending committee meetings. Correspondence should be addressed to:

Secretary, A17 Standards Committee
The American Society of Mechanical Engineers
Two Park Avenue
New York, NY 10016
E-mail: infocentral@asme.org

All correspondence to the Committee must include the individual's name and post office address in case the Committee needs to request further information.

Proposing Revisions. Revisions are made periodically to the Code to incorporate changes that appear necessary or desirable, as demonstrated by the experience gained from the application of the procedures, and in order to conform to developments in the elevator art. Approved revisions will be published periodically.

The Committee welcomes proposals for revisions to this Code. Such proposals should be as specific as possible: citing the Section number(s), the proposed wording, and a detailed description of the reasons for the proposal including any pertinent documentation.

Requesting Interpretations. On request, the A17 Committee will render an interpretation of any requirement of the Code. Interpretations can only be rendered in response to a written request sent to the Secretary of the Standards Committee.

The request for interpretation should be clear and unambiguous. It is further recommended that the

Abbreviations Used in This Code

| Abbreviation | Unit | Abbreviation | Unit |
|-------------------|----------------------------|------------------|-----------------------------|
| A | Ampere | lb | pound (mass) |
| °C | degree Celsius | lbf | pound (force) |
| deg | degree (angle) | lx | lux |
| °F | degree Fahrenheit | m | meter |
| ft/min | foot per minute | m ² | square meter |
| ft/s | foot per second | m ³ | cubic meter |
| ft | foot | mA | milliampere |
| fc | footcandle | m/s | meter per second |
| ft ² | square foot | m/s ² | meter per second per second |
| ft ³ | cubic foot | mm | millimeter |
| ft/s ² | foot per second per second | mm ² | square millimeter |
| h | hour | mm ³ | cubic millimeter |
| Hz | hertz | MPa | megapascal |
| in. | inch | N | Newton |
| in. ² | square inch | psi | pound per square inch |
| in. ³ | cubic inch | s | second |
| kg | kilogram | SIL | Safety Integrity Level |
| kPa | kilopascal | V | volt |

inquirer submit his request utilizing the following format:

- Subject:** Cite the applicable Section number(s) and a concise description.
- Edition:** Cite the applicable edition and supplement of the Code for which the interpretation is being requested.
- Question:** Phrase the question as a request for an interpretation of a specific requirement suitable for general understanding and use, not as a request for an approval of a proprietary design or situation. The question shall be phrased, where possible, to permit a specific “yes” or “no” answer. The inquirer may also include any plans or drawings that are necessary to explain the question; however,

they should not contain proprietary names or information.

Requests that are not in this format will be rewritten in this format by the Committee prior to being answered, which may inadvertently change the intent of the original request.

ASME procedures provide for reconsideration of any interpretation when or if additional information that might affect an interpretation is available. Further, persons aggrieved by an interpretation may appeal to the cognizant ASME committee or subcommittee. ASME does not “approve,” “certify,” “rate,” or “endorse” any item, construction, proprietary device, or activity.

Attending Committee Meetings. The A17 Standards Committee and the various Working Committees regularly hold meetings, all of which are open to the public. Persons wishing to attend any meeting should contact the Secretary of the Standards Committee.

CSA PREFACE

This is the third edition of ASME A17.1/CSA B44, *Safety Code for Elevators and Escalators*. It replaces the previous edition of ASME A17.1/CSA B44, published in 2010, and the previous editions of CSA B44, published in 2007, 2004, 2000, 1994, 1990, 1985, 1975, 1971, 1966, 1960, and 1938.

This Code is the result of a joint effort by the CSA B44 Technical Committee on the Elevator Safety Code and the ASME A17 Committee on Elevators and Escalators to harmonize the provisions of CSA B44 and ASME A17.1. This edition of ASME A17.1/CSA B44 consists of the complete ASME A17.1 Code, with additional requirements applicable only in Canadian jurisdictions. These Canadian requirements are prefaced in the body of the Code by the following: “In jurisdictions enforcing the NBCC. . .”

CSA B44 was originally developed to facilitate the implementation of uniform legislation across Canada and to replace the existing legislation, which had proved inadequate for prevailing elevator practices. The primary purpose of the Code is to establish minimum requirements, suitable for adoption by regulatory authorities throughout Canada, for the design, installation, and maintenance of elevators, escalators, dumbwaiters, moving walks, and material lifts. It is also intended as a standard reference for architects, consulting engineers, elevator manufacturers, and building owners.

This Code was prepared for use in Canada by the CSA Technical Committee on the Elevator Safety Code under the jurisdiction of the CSA Strategic Steering Committee on Mechanical Industrial Equipment Safety. It has been formally approved by the CSA Technical Committee.

2013

NOTES:

- (1) Use of the singular does not exclude the plural (and vice versa) when the sense allows.
- (2) Although the intended primary application of this Standard is stated in its Scope, it is important to note that it remains the responsibility of the users of the Standard to judge its suitability for their particular purpose.
- (3) This Standard was developed by consensus, which is defined by *CSA Policy governing standardization — Code of good practice for standardization* as “substantial agreement. Consensus implies much more than a simple majority, but not necessarily unanimity.” It is consistent with this definition that a member may be included in the Technical Committee list and yet not be in full agreement with all clauses of this Standard.
- (4) To submit a request for interpretation of this Standard, please send the following information to inquiries@csagroup.org and include “Request for Interpretation” in the subject line:
 - (a) define the problem, making reference to the specific clause, and, where appropriate, include an illustrative sketch
 - (b) provide an explanation of circumstances surrounding the actual field condition; and
 - (c) where possible, phrase the request in such a way that a specific “yes” or “no” answer will address the issue.
 Committee interpretations are processed in accordance with the CSA Directives and guidelines governing standardization and are available on the Current Standards Activities page at standardsactivities.csa.ca.
- (5) This Standard is subject to periodic review, and suggestions for its improvement will be referred to the appropriate committee. To submit a proposal for change, please send the following information to inquiries@csagroup.org and include “Proposal for Change” in the subject line:
 - (a) Standard designation (number)
 - (b) relevant clause, table, and/or figure number
 - (c) wording of the proposed change
 - (d) rationale for the change.

ASME A17.1-2013/CSA B44-13

SUMMARY OF CHANGES

Following approval by the ASME A17 Elevator and Escalator Committee, and after public review, ASME A17.1-2013/CSA B44-13 was approved by the American National Standards Institute on May 31, 2013. It was issued on October 21, 2013, and is effective as of April 21, 2014, with the exception of Requirements 8.10.1.1.3 and 8.11.1.1, which shall be effective immediately.

ASME A17.1-2013/CSA B44-13 incorporates the revisions and editorial changes made since the previously published edition. Revisions are identified by a margin note, **(13)**. Changes made to correct errors, as well as other new editorial changes, are identified by **(ED)**. Revision designators will remain on the pages up to the publication of the next edition of the Code. The **(ED)** designators will appear only when the editorial changes are introduced. The following is a summary of the latest revisions and changes:

| <i>Page</i> | <i>Location</i> | <i>Change</i> |
|----------------------|-----------------|---|
| viii–xii | ASME Foreword | Revised |
| xxi–xxiii | ASME Preface | Revised |
| xxiv | CSA Preface | Revised |
| 1 | 1.1.1 | In subpara. (c), last sentence revised |
| 2 | 1.1.4 | Revised |
| | 1.2.2 | Title editorially revised |
| 2, 5, 6–8, 10, 13–18 | Section 1.3 | (1) Definition of <i>accredited certifying organization; accrediting body; base, building; control, mechanical-hydraulic; conveyor, vertical reciprocating (VRC); driving machine, traction climbing; elevator, outside emergency; elevator discharge level; elevator, wind turbine tower; guide rope fixes; guiding means, ladder; hard, copy; maintenance control program (MCP); maintenance interval; maintenance procedure; maintenance task; Occupant Evacuation Operation; operation, automatic call; operation, automatic send; pallet band; platform, landing; records, electronic; seal, adjustment; SIL rated; step band; sway control guide; sway control guide suspension means; tail line; and travel path</i> added |

| <i>Page</i> | <i>Location</i> | <i>Change</i> |
|-------------|-----------------|---|
| | | (2) Definition of control, electrohydraulic; electrical/electronic/programmable electric system (E/E/PES); manual reset, escalator and moving walk; material lift; operation, group automatic; safety integral level (SIL); terminal stopping device, final; terminal stopping device, normal; and unlocking zone revised |
| 23 | 2.2.6.2 | Sentence added to end of paragraph |
| | 2.2.6.3 | Moved to 2.2.6.2 |
| | 2.3.2.1 | Subparagraph (a) revised |
| 24 | 2.4.1.6 | Revised in its entirety |
| 26 | 2.4.7.2 | Revised in its entirety |
| 28 | 2.7.3.1.3 | Added |
| | 2.7.3.2.2 | Revised |
| 32 | 2.7.5.3.2 | Editorially revised |
| | 2.7.5.3.5 | Revised |
| 39 | 2.10.2.1 | Revised |
| | 2.11.1.2 | Subparagraph (e) revised |
| 40 | 2.11.5 | Subparagraph (a) revised |
| | 2.11.6.3 | Revised in its entirety |
| 42 | 2.11.10.1.4 | Added |
| | 2.11.11.1 | Subparagraph (d) added |
| 47 | 2.11.19.3 | Revised |
| 49 | 2.12.4.1 | Subparagraph (b) editorially revised |
| 50 | 2.12.4.3 | Subparagraph (c) editorially revised |
| | 2.12.5 | Deleted; material revised and moved to 2.14.5.7 |
| | 2.12.7.2.1 | Revised in its entirety |
| | 2.12.7.2.3 | Revised in its entirety |
| | 2.12.7.3 | Revised in its entirety |
| 52 | 2.13.2.1.1 | Revised |
| | 2.13.2.2.1 | Revised |
| 55 | 2.13.3.4.9 | Revised |
| 60 | 2.14.2.1.2 | (1) Subparagraphs (a) and (b) revised (2) Subparagraph (c) deleted |
| 64 | 2.14.5.7 | Revised in its entirety |
| | 2.14.5.8 | (1) New para. 2.14.5.8 added (2) Original 2.14.5.8 through 2.14.5.9.4 redesignated as 2.14.5.9 through 2.14.5.10.4, respectively |

| <i>Page</i> | <i>Location</i> | <i>Change</i> |
|-------------|-----------------|---|
| 66 | 2.15.2 | Title and paragraph revised in its entirety |
| 68 | 2.15.9.2 | First paragraph and subpara. (b) revised |
| | 2.15.9.5 | Added |
| 70 | 2.15.16.1 | Revised in its entirety |
| | 2.16.1.1 | Editorially revised |
| 72 | 2.16.3.3 | Revised in its entirety |
| | 2.16.4 | Editorially revised |
| | 2.16.4.7 | Deleted, and original 2.16.4.8 and 2.16.4.9 redesignated as 2.16.4.7 and 2.16.4.8, respectively |
| 73 | 2.16.5.2 | Revised |
| 78 | 2.18.4.1.2 | Revised |
| | 2.18.4.1.3 | Added |
| 79 | 2.18.4.2.5 | Subparagraph (a) revised |
| 80 | 2.18.4.4 | Deleted |
| 82 | 2.19.2.2 | Subparagraph (b) editorially revised |
| | 2.19.3.1.3 | Added |
| | 2.19.3.1.4 | Redesignated from former 2.19.3.1.3 and revised |
| | 2.19.3.2 | Subparagraphs (b), (c), and (d) revised |
| 84 | 2.20.3 | Nomenclature for <i>N</i> editorially revised |
| 85, 86 | 2.20.8.1 | (1) First paragraph editorially revised (2) Subparagraphs (d)(2) and (f) editorially revised |
| | 2.20.8.2 | Subparagraph (c) editorially revised |
| | 2.20.8.3 | Subparagraph (c) editorially revised |
| 88 | 2.20.9.6.2 | Subparagraph (c)(1)(m) editorially revised |
| 92 | 2.21.1.3 | Title and paragraph revised in its entirety |
| 94, 95 | Table 2.22.4.1 | Under Imperial Units, 115% of Rated Speed, ft/min; second, fifth, seventh, and penultimate values revised |
| | 2.22.4.6 | Revised |
| | 2.22.4.7.3 | Editorially revised |
| 106 | 2.24.4 | Title revised |
| | 2.24.4.1 | Revised in its entirety |
| 107, 108 | 2.25.2.1.1 | Revised |
| | 2.25.2.1.2 | Revised in its entirety |
| 109–111 | 2.25.4.1.1 | Revised in its entirety |
| | 2.25.4.1.2 | Revised in its entirety |

| <i>Page</i> | <i>Location</i> | <i>Change</i> |
|-------------|------------------|---|
| | 2.25.4.1.3 | Added |
| | 2.25.4.1.4 | Redesignated from former 2.25.4.1.3 and revised; original 2.25.4.1.4 deleted |
| | 2.25.4.1.8 | Subparagraph (a) revised in its entirety |
| | 2.25.4.2 | Revised in its entirety |
| | 2.26.1.4.1 | (1) Subparagraph (b)(4)(b) revised (2) Subparagraph (d)(1) revised |
| 113 | 2.26.1.4.3 | Subparagraph (d) revised |
| | 2.26.1.5.1 | Revised in its entirety |
| 114 | 2.26.1.6.6 | Revised in its entirety |
| | 2.26.2 | First paragraph editorially revised |
| 115 | 2.26.2.4 | Revised in its entirety |
| | 2.26.2.6 | Editorially revised |
| | 2.26.2.10 | Editorially revised |
| 116 | 2.26.2.25 | Revised |
| | 2.26.2.39 | Added |
| 117 | 2.26.4.3.1 | Second sentence revised |
| | 2.26.4.3.2 | Revised |
| | 2.26.4.4 | Revised |
| | 2.26.4.4.1 | Editorially revised |
| 118, 119 | Table 2.26.4.3.2 | (1) Requirement 2.12.7.2.3 revised (2) Requirement 2.26.1.4.1(b) revised (3) Requirement 2.26.2.25 revised (4) Requirement 2.26.2.39 added (5) General Note (c) editorially revised |
| 120 | 2.26.8.2 | Revised |
| | 2.26.9.3.1 | Subparagraph (c) editorially revised |
| | 2.26.9.3.2 | Subparagraph (b) revised |
| 121 | 2.26.9.5.1 | Subparagraph (b) revised |
| | 2.26.9.6.1 | Subparagraph (b) revised |
| 122, 124 | 2.27.1.1.3 | (1) Subparagraph (a) editorially revised (2) Subparagraph (f) revised |
| | 2.27.1.1.4 | Subparagraph (b) revised |
| | 2.27.1.1.6 | (1) Subparagraph (a) revised in its entirety (2) Subparagraph (b)(3) revised (3) Subparagraph (d)(4) added |
| 125 | 2.27.2.3 | Revised |
| | 2.27.2.4.4 | Subparagraph (a) revised |
| 126 | 2.27.3.1.1 | Subparagraph (b) revised |

| <i>Page</i> | <i>Location</i> | <i>Change</i> |
|-------------|-----------------|--|
| | 2.27.3.1.2 | (1) Revised (2) Note added |
| | 2.27.3.1.6 | (1) Subparagraph (a) revised (2) Subparagraph (d)(2) editorially revised (3) Subparagraph (f)(2) revised |
| 127–129 | 2.27.3.2.1 | (1) First paragraph revised (2) Subparagraphs (a) and (b) editorially revised |
| | 2.27.3.2.2 | (1) Subparagraphs (a) and (b) revised (2) Subparagraph (c) added |
| | 2.27.3.2.3 | Subparagraph (b) editorially revised |
| | 2.27.3.2.6 | Revised in its entirety |
| | 2.27.3.2.7 | Added |
| | 2.27.3.3 | First paragraph revised |
| | 2.27.3.3.1 | Subparagraphs (b)(2), (d), (e), and (n) revised |
| 130, 131 | 2.27.3.3.2 | Last paragraph added |
| | 2.27.3.3.4 | Revised in its entirety |
| 132 | 2.27.4.1 | Second paragraph editorially revised |
| 133 | 2.27.4.2 | Revised in its entirety |
| | 2.27.5.1 | Revised |
| | 2.27.5.2 | Subparagraphs (a) and (b) revised |
| | 2.27.5.3 | Editorially revised |
| | 2.27.6 | Editorially revised |
| 135 | Fig. 2.27.8 | Added |
| | 2.27.8 | Revised |
| | 2.27.10 | Reserved for future use |
| | 2.27.11 | Added |
| 139 | 2.29.1 | Revised in its entirety |
| 140 | Section 2.30 | Added |
| 142 | 3.4.1.6 | Revised |
| 144 | Section 3.12 | Title revised |
| | 3.12.1 | Title and paragraph revised |
| 145 | 3.17.1.1 | Second sentence editorially revised |
| 146 | 3.17.3.2 | Revised |
| | 3.17.3.2.1 | (1) Deleted, and original 3.17.3.2.2 revised and redesignated 3.17.3.2.1 (2) New 3.17.3.2.2 added |
| | 3.17.3.4 | Redesignated 3.17.3.4.1, and new 3.17.3.4 added |

| <i>Page</i> | <i>Location</i> | <i>Change</i> |
|-------------|-----------------|--|
| | 3.17.3.4.2 | Added |
| 147 | 3.17.3.8 | First paragraph revised |
| | 3.18.1.2 | (1) 3.18.1.2.1 revised (2) Original 3.18.1.2.2 and 3.18.1.2.3 deleted, and original 3.18.1.2.4 through 3.18.1.2.8 redesignated as 3.18.1.2.2 through 3.18.1.2.6, respectively |
| 149 | 3.18.3.8.3 | Revised |
| | 3.18.6 | First paragraph revised |
| 150 | 3.19.2.5 | (1) Redesignated 3.19.2.6, and original 3.19.4.5 redesignated 3.18.2.5 (2) Original 3.19.2.6 redesignated 3.19.2.7 (3) New 3.19.2.8 added |
| 151 | 3.19.4.5 | (1) Redesignated 3.19.2.5 (2) 3.19.4.5 to be reserved for future use |
| | 3.19.4.6.2 | (1) Subparagraph (c) editorially revised (2) Subparagraph (f) deleted |
| | 3.19.4.6.3 | Added |
| 153, 154 | 3.24.1.1 | Revised |
| | 3.25.1.1 | Revised in its entirety |
| | 3.25.2.2.1 | Revised in its entirety |
| 169 | Part 5 Scope | Subparagraphs (k) and (l) added |
| 170 | 5.1.9 | (1) Revised and redesignated 5.1.11.4 (2) 5.1.9 to be reserved for future use |
| | 5.1.10.3.1 | Editorially revised |
| | 5.1.10.3.2 | Editorially revised |
| | 5.1.10.3.3 | Editorially revised |
| 171 | 5.1.11.4 | Redesignated 5.1.11.5, and new 5.1.11.4 added |
| 176, 177 | 5.2.1.2 | Revised |
| | 5.2.1.2.1 | Added |
| | 5.2.1.4.4 | Subparagraphs (b) and (b)(1) revised |
| | 5.2.1.4.5 | Added |
| | 5.2.1.12 | (1) Subparagraph (d) editorially revised (2) Subparagraph (e) deleted |
| | 5.2.1.14 | Subparagraph (m) revised |
| 180 | 5.2.2.1 | Subparagraph (c) revised |
| | 5.2.2.1.1 | Added |
| | 5.2.2.6 | Revised |
| | Section 5.3 | Revised |

| <i>Page</i> | <i>Location</i> | <i>Change</i> |
|-------------|-----------------|--|
| 181 | 5.3.1.1 | Last sentence added |
| | 5.3.1.2.3 | Added |
| 183 | 5.3.1.11.1 | Revised |
| | 5.3.1.11.2 | First sentence editorially revised |
| 184 | 5.3.1.11.7 | Redesignated 5.3.1.11.8, and new 5.3.1.11.7 added |
| 185 | 5.3.1.14.1 | Revised in its entirety |
| 187 | 5.3.1.18.2.1 | (1) Subparagraph (a) editorially revised (2) Subparagraph (c) deleted (3) Subparagraph (d) revised and redesignated subpara. (c) (4) Subparagraph (e) redesignated subpara. (d) |
| 188 | 5.3.2.4.6 | Subparagraph (b) editorially revised |
| | Section 5.4 | Last sentence in first paragraph added |
| 189 | 5.4.2.4 | Revised |
| | 5.4.3.1 | Revised |
| | 5.4.3.2 | Revised and redesignated from former 5.4.3.3; original 5.4.3.2 deleted |
| | 5.4.3.3 | Revised and redesignated from former 5.4.3.4 |
| | 5.4.3.4 | Deleted |
| | 5.4.4.1.2 | Revised |
| | 5.4.4.2.1 | Revised |
| | 5.4.4.3 | Title revised |
| | 5.4.4.3.1 | (1) First paragraph revised (2) Subparagraph (b) revised |
| | 5.4.4.3.2 | Revised |
| | 5.4.4.3.3 | Title and paragraph revised |
| 190 | 5.4.6.2 | Last sentence added |
| | 5.4.7.6 | Revised |
| | 5.4.7.7 | Revised in its entirety |
| | 5.4.7.9 | Title and paragraph revised |
| | 5.4.8 | (1) Paragraph added (2) 5.4.8.1 revised in its entirety (3) 5.4.8.2 title and paragraph revised (4) 5.4.8.3 title and paragraph revised (5) 5.4.8.4 through 5.4.8.9 deleted |
| | 5.4.9 | (1) Paragraph added (2) 5.4.9.1 and 5.4.9.2 deleted |
| 191 | 5.4.11 | (1) Paragraph added (2) 5.4.11.1 revised in its entirety (3) 5.4.11.2 and 5.4.11.3 deleted |

| <i>Page</i> | <i>Location</i> | <i>Change</i> |
|-------------|-----------------|--|
| | 5.4.12 | Deleted, and former 5.4.13 redesignated as 5.4.12 |
| | 5.4.12.1 | Added |
| | 5.4.12.2 | Redesignated from former 5.4.13.8 |
| | 5.4.12.3 | Redesignated from former 5.4.13.10 |
| | 5.4.13 | (1) Redesignated as 5.4.12 (2) Original 5.4.13.1 through 5.4.13.7, and 5.4.13.9 deleted (3) New 5.4.13.1 redesignated and revised from original 5.4.14.1 (4) Original 5.4.14.2 and 5.4.14.3 deleted |
| | 5.4.14 | (1) Redesignated as 5.4.13 (2) Original 5.4.15 through 5.4.15.5.3 redesignated as 5.4.14 through 5.4.14.5.3 (3) Newly redesignated 5.4.14.2 revised from former 5.4.15.2 |
| | 5.4.15 | Redesignated from former 5.4.16 |
| 203 | 5.7.17.2 | First sentence editorially revised |
| 213 | Section 5.11 | Added |
| 229 | Section 5.12 | Added |
| 230 | 6.1.1.1 | Revised |
| 231 | 6.1.3.3.9 | In subpara. (a), second sentence editorially revised |
| 233 | 6.1.3.4.5 | Second sentence editorially revised |
| 235 | 6.1.3.15 | Title and paragraph revised |
| 238 | 6.1.6.3.6 | Revised |
| | 6.1.6.3.9 | Revised |
| 239 | 6.1.6.3.12 | (1) In first paragraph, second sentence revised (2) Last paragraph revised |
| | 6.1.6.4 | Revised |
| 240 | 6.1.6.9.2 | Title and paragraph revised |
| | 6.1.6.9.3 | Added |
| 243 | 6.1.8.2.2 | Revised |
| 250 | 6.2.6.3.10 | (1) In first paragraph, third sentence revised (2) Last paragraph revised |
| 251 | 6.2.6.4 | Revised |
| | 6.2.6.8.2 | Title and paragraph revised |
| | 6.2.6.8.3 | Added |

| <i>Page</i> | <i>Location</i> | <i>Change</i> |
|-------------|-------------------------|--|
| 253 | 6.2.8.2.2 | Revised |
| 256 | 7.1.11.4 | Revised |
| | 7.1.11.4.1 | Added |
| | 7.1.11.4.2 | Added |
| 258 | 7.1.12.4 | Subparagraph (b) revised |
| 263 | 7.2.12 | Second sentence editorially revised |
| 264 | 7.2.12.16–7.2.12.39 | Original 7.2.12.16 deleted, and 7.2.12.17 through 7.2.12.39 redesignated as 7.2.12.16 through 7.2.12.38, respectively |
| 265 | 7.3.11.4.1 | Subparagraph (c) editorially revised |
| 269, 270 | 7.4.14.2 | In fourth sentence, reference in parentheses editorially revised |
| | 7.4.14.4 | Deleted, and original 7.4.14.5 through 7.4.14.7 redesignated as 7.4.14.4 through 7.4.14.6, respectively |
| | 7.4.15.7 | Added |
| 273 | 7.5.12.1 | Editorially revised |
| 274 | 7.5.12.1.12–7.5.12.1.24 | (1) Original 7.5.12.1.12 deleted, and 7.5.12.1.13 through 7.5.12.1.24 redesignated as 7.5.12.1.12 through 7.5.12.1.23, respectively (2) In newly redesignated 7.5.12.1.15, subpara. (g) editorially revised |
| | 7.5.12.2 | Editorially revised |
| 275 | 7.5.12.2.15–7.5.12.2.34 | Original 7.5.12.2.15 deleted, and 7.5.12.2.16 through 7.5.12.2.34 redesignated as 7.5.12.2.15 through 7.5.12.2.33, respectively |
| 276 | 7.6.8.1 | Subparagraphs (a) and (b) editorially revised |
| | 7.6.8.3 | Subparagraph (e) editorially revised |
| 280 | 8.1.2 | Subparagraph (n) editorially revised |
| 284 | 8.2.2.5.1 | In subparas. (a) through (c), all equations containing variable <i>E</i> editorially revised to variable <i>B</i> |
| 285 | Fig. 8.2.2.5.1 | In all instances, variable <i>E</i> editorially revised to variable <i>B</i> |
| 300 | 8.3.1.3.1 | Subparagraph (h) editorially revised |
| | 8.3.1.3.2 | Editorially revised |
| 308, 309 | Section 8.4 | (1) Title revised (2) Paragraph revised in its entirety |
| | 8.4.2.1 | Title and paragraph revised |
| | 8.4.2.2 | Title and paragraph revised |

| <i>Page</i> | <i>Location</i> | <i>Change</i> |
|-------------|-----------------|--|
| | 8.4.2.3 | Title revised |
| | 8.4.2.3.1 | Revised |
| | 8.4.2.3.2 | Revised |
| | 8.4.2.3.3 | Revised |
| | 8.4.2.3.4 | Added |
| 310 | 8.4.5.2.1 | Revised |
| 311 | 8.4.6 | Revised in its entirety |
| | 8.4.7.1.1 | Revised |
| | 8.4.7.1.3 | Deleted, and original 8.4.7.1.4 redesignated as 8.4.7.1.3 |
| | 8.4.7.2.2 | Revised |
| | 8.4.8.1.1 | Added |
| | 8.4.8.2.1 | Revised in its entirety |
| | 8.4.8.2.2 | Definitions of nomenclatures W and W_a editorially revised |
| 312 | Fig. 8.4.8.2-1 | Revised |
| 313 | Fig. 8.4.8.2-2 | Revised |
| 314 | Fig. 8.4.8.2-3 | Revised |
| 315 | Fig. 8.4.8.2-4 | Revised |
| 316 | Fig. 8.4.8.2-5 | Revised |
| 317 | Fig. 8.4.8.2-6 | Revised |
| 318 | Fig. 8.4.8.2-7 | Revised |
| 320 | 8.4.8.2.6 | Added |
| | 8.4.8.3 | Revised in its entirety |
| | 8.4.8.4 | Revised in its entirety |
| 321–324 | 8.4.8.7 | Revised in its entirety |
| | 8.4.8.8 | Second paragraph editorially revised |
| | 8.4.8.9 | First sentence editorially revised |
| | 8.4.8.9.1 | Subparagraphs (a) and (b) revised in their entirety |
| | 8.4.8.9.2 | Subparagraphs (a) and (b) revised in their entirety |
| | 8.4.9.1 | Revised |
| | 8.4.10.1 | Revised |
| | 8.4.10.1.1 | Subparagraphs (a)(1) and (a)(2) revised |
| | Table 8.4.8.7 | Revised in its entirety |
| 325 | Fig. 8.4.10.1.1 | Revised |
| 327 | 8.4.11.2.1 | Title and paragraph revised |

| <i>Page</i> | <i>Location</i> | <i>Change</i> |
|-------------|-----------------|--|
| | 8.4.11.3.1 | Editorially revised |
| | 8.4.11.5.2 | Revised |
| | 8.4.11.9 | Revised |
| | 8.4.11.12 | Revised |
| 328 | 8.4.11.15 | Second sentence editorially revised |
| | 8.4.11.15.1 | (1) First paragraph revised (2) Subparagraphs (a) and (b) revised in their entirety |
| | 8.4.11.15.2 | (1) First paragraph revised (2) Subparagraphs (a) and (b) revised in their entirety |
| 329–331 | 8.4.12.1.1 | Revised in its entirety |
| | 8.4.12.1.2 | Revised in its entirety |
| | 8.4.12.2.1 | Subparagraphs (a) and (b) revised in their entirety |
| | 8.4.12.2.2 | Subparagraphs (a) and (b) revised in their entirety |
| | 8.4.13 | (1) Title revised (2) Paragraph added |
| | 8.4.13.1 | Revised in its entirety |
| 332, 333 | 8.4.13.2 | Revised in its entirety |
| | 8.4.14 | Added |
| | 8.4.15 | Added |
| 334 | Section 8.6 | Paragraph revised |
| 335–337 | 8.6.1.1.3 | Revised |
| | 8.6.1.2.1 | Revised in its entirety |
| | 8.6.1.2.2 | Revised in its entirety |
| | 8.6.1.4 | Revised in its entirety |
| | 8.6.1.6.3 | Revised in its entirety |
| | 8.6.1.7.2 | Title and paragraph revised |
| 338 | 8.6.2.6 | Added |
| | 8.6.3.4.6 | Editorially revised |
| | 8.6.3.5 | Second paragraph editorially revised |
| 340 | 8.6.3.13 | Added |
| | 8.6.3.14 | Added |
| | 8.6.4.1.3 | Revised |
| | 8.6.4.3.2 | Subparagraph (b) editorially revised |
| | 8.6.4.3.3 | Editorially revised |
| | 8.6.4.3.5 | Second sentence editorially revised |

| <i>Page</i> | <i>Location</i> | <i>Change</i> |
|-------------|-----------------|--|
| 341 | 8.6.4.6.2 | Last sentence added |
| | 8.6.4.10.2 | Revised in its entirety |
| 342 | 8.6.4.13.1 | Subparagraph (l) revised |
| | 8.6.4.19.2 | Subparagraph (b)(2) editorially revised |
| 343–346 | 8.6.4.19.4 | Title and paragraph revised |
| | 8.6.4.19.5 | Editorially revised |
| | 8.6.4.19.6 | Revised |
| | 8.6.4.19.10 | Revised in its entirety |
| | 8.6.4.19.11 | (1) Title revised (2) Revised in its entirety |
| | 8.6.4.19.12 | Subparagraph (b) editorially revised |
| | 8.6.4.19.14 | Added |
| | 8.6.4.19.15 | Added |
| | 8.6.4.19.16 | Added |
| | 8.6.4.20.1 | Revised in its entirety |
| | 8.6.4.20.3 | (1) Subparagraph (a) revised in its entirety (2) Second sentence of subpara. (d) editorially revised (3) Subparagraphs (e), (f), and (g) added |
| | 8.6.4.20.4 | (1) Title revised (2) Revised in its entirety |
| | 8.6.4.20.5 | Text deleted; reserved for future use |
| | 8.6.4.20.7 | Revised |
| | 8.6.4.20.10 | Revised in its entirety |
| | 8.6.4.22 | Added |
| | 8.6.5.9 | Editorially revised |
| 347 | 8.6.5.13 | First sentence added |
| | 8.6.5.14.1 | Title and paragraph revised |
| | 8.6.5.14.7 | Editorially revised |
| 348 | 8.6.5.17 | Added |
| | 8.6.6.1.1 | First sentence revised |
| 349 | 8.6.7.9 | Editorially revised |
| 350 | 8.6.7.11 | Added |
| | 8.6.7.12 | Added |
| 351 | 8.6.8.5 | Subparagraph (a) revised |
| 353 | 8.6.8.15.24 | Added |
| 355–357 | 8.6.11.5.4 | Revised |
| | 8.6.11.6 | Title revised |

| <i>Page</i> | <i>Location</i> | <i>Change</i> |
|-------------|---------------------|--|
| | 8.6.11.6.1 | Revised in its entirety |
| | 8.6.11.10–8.6.11.12 | (1) Original 8.6.11.10 redesignated as 8.6.11.11, and new 8.6.11.10 added (2) Original 8.6.11.11 redesignated as 8.6.11.12 (3) Original 8.6.11.12 redesignated as 8.6.11.14, and new 8.6.11.13 added |
| | 8.7.1.7 | Second sentence deleted |
| 358 | 8.7.1.9 | Added |
| | 8.7.2.7.2 | Revised |
| 360, 361 | 8.7.2.11.5 | Editorially revised |
| | 8.7.2.12 | Revised |
| | 8.7.2.13 | First paragraph revised |
| | 8.7.2.14.3 | Subparagraphs (b) and (c) editorially revised |
| | 8.7.2.14.4 | Revised |
| | 8.7.2.16.2 | Second sentence added |
| 362 | 8.7.2.17.1 | (1) First paragraph revised (2) Subparagraph (c)(3) editorially revised (3) Subparagraph (d) added |
| 364–366 | 8.7.2.25.2 | Revised in its entirety |
| | 8.7.2.27.1 | Title and paragraph revised in their entirety |
| | 8.7.2.27.4 | Revised in its entirety |
| | 8.7.2.27.5 | Revised in its entirety |
| | 8.7.2.27.6 | Revised in its entirety |
| | 8.7.2.27.7 | Revised in its entirety |
| | 8.7.2.27.9 | Added |
| | 8.7.2.28 | (1) Subparagraph (c) revised (2) Subparagraph (e) added |
| 367 | 8.7.3.7 | Title and paragraph revised |
| | 8.7.3.12 | Revised |
| | 8.7.3.13 | (1) Title revised (2) Revised in its entirety |
| 368 | 8.7.3.18 | Last sentence added |
| 369–371 | 8.7.3.31.5 | Revised in its entirety |
| | 8.7.3.31.6 | Revised in its entirety |
| | 8.7.3.31.7 | Revised in its entirety |
| | 8.7.3.31.8 | (1) Subparagraph (c) revised (2) Subparagraphs (d) and (e) added |
| | 8.7.3.31.10 | Revised in its entirety |

| <i>Page</i> | <i>Location</i> | <i>Change</i> |
|-------------|-------------------|--|
| | 8.7.3.31.12 | Added |
| 373 | 8.7.5.10 | Added |
| 374 | 8.7.6.1.17 | Added |
| 375 | 8.7.6.2.16 | Added |
| | 8.9.1 | Revised |
| 376 | Section 8.10 | Note revised |
| | 8.10.1.1.3 | Revised |
| | 8.10.1.1.4 | Added |
| | 8.10.1.1.5 | Added |
| 377–380 | 8.10.1.2–8.10.1.4 | (1) Original 8.10.1.2 redesignated as 8.10.1.3, and new 8.10.1.2 added (2) Original 8.10.1.3 redesignated as 8.10.1.4 (3) Original 8.10.1.4 redesignated as 8.10.1.5 and revised (4) New 8.10.1.6 added |
| | 8.10.2.2.1 | (1) Subparagraph (k)(2) editorially revised (2) Subparagraph (r) revised |
| | 8.10.2.2.2 | (1) Subparagraph (v) revised (2) Subparagraph (cc)(3)(c)(2) editorially revised (3) Subparagraph (ii)(1)(b) revised (4) Subparagraph (nn) editorially revised |
| 382 | 8.10.2.2.8 | Title and paragraph revised |
| | 8.10.2.2.9 | Added |
| 384–386 | 8.10.3.2.2 | (1) Subparagraph (cc) editorially revised (2) Subparagraph (gg) editorially revised |
| | 8.10.3.2.3 | (1) Subparagraph (z) editorially revised (2) Subparagraph (aa) editorially revised |
| 387 | 8.10.3.3.2 | Subparagraph (i) editorially revised |
| 388 | 8.10.4.1.1 | Subparagraph (e) editorially revised in its entirety |
| 389 | 8.10.4.1.2 | Subparagraph (c)(2) revised in its entirety |
| 392 | 8.10.5.14 | Added |
| | 8.10.5.15 | Added |
| 393, 394 | 8.11.1.1 | Revised |
| | 8.11.1.1.2 | Subparagraph (a) revised |
| | 8.11.1.7 | Revised |
| | 8.11.1.8 | Added |
| | 8.11.2.1.1 | Subparagraph (r) revised |
| | 8.11.2.1.2 | Subparagraph (ll) editorially revised |

| <i>Page</i> | <i>Location</i> | <i>Change</i> |
|-------------|-------------------------|---|
| 396 | 8.11.2.1.8 | Added |
| | 8.11.3.1.2 | Subparagraph (cc) editorially revised |
| 399 | 8.11.5.14 | Added |
| | 8.11.5.15 | Added |
| 401–407 | Section 9.1 | Updated to reflect new and revised references |
| 408, 409 | Section 9.2 | Updated to reflect new and revised references |
| 413 | Nonmandatory Appendix B | Title revised |
| | Fig. B-1 | Subtitle and figure revised |
| 416–423 | Nonmandatory Appendix E | Revised in its entirety |
| 425 | Table F-1 | Revised |
| 451 | Table N-2 | First column heading editorially revised |
| 462 | Table R-1 | Fourth column heading revised |
| 479 | Nonmandatory Appendix V | Added |
| 481 | Nonmandatory Appendix W | Added |
| 482 | Nonmandatory Appendix X | Added |
| 486 | Nonmandatory Appendix Y | Added |

SPECIAL NOTE:

The interpretations to ASME A17.1 issued between July 2009 through June 2012 follow the last page of this edition as a separate supplement, Interpretations No. 32.

INTENTIONALLY LEFT BLANK

SAFETY CODE FOR ELEVATORS AND ESCALATORS

Part 1 General

SECTION 1.1 SCOPE

(13) 1.1.1 Equipment Covered by This Code

This Code covers the design, construction, operation, inspection, testing, maintenance, alteration, and repair of the following equipment and its associated parts, rooms, spaces, and hoistways, where located in or adjacent to a building or structure (see 1.2):

(a) hoisting and lowering mechanisms, equipped with a car, that move between two or more landings. This equipment includes, but is not limited to elevators (see 1.3).

(b) power-driven stairways and walkways for carrying persons between landings. This equipment includes, but is not limited to escalators and moving walks (see 1.3).

(c) hoisting and lowering mechanisms equipped with a car that serves two or more landings and is restricted to the carrying of material by its limited size or limited access to the car. This equipment includes, but is not limited to dumbwaiters and material lifts; it does not include vertical reciprocating conveyors (see 1.3).

1.1.2 Equipment Not Covered by This Code

Equipment not covered by this Code includes, but is not limited to, the following:

(a) personnel hoists within the scope of ANSI A10.4 and CSA-Z185

(b) material hoists within the scope of ANSI A10.5 and CSA-Z256

(c) platform lifts and stairway chairlifts within the scope of ASME A18.1, CSA B355, and CSA B613

(d) manlifts within the scope of ASME A90.1 and CSA B311, and in jurisdictions enforcing NBCC Special Purpose Personnel Elevators (ASME A17.1, Section 5.7)

(e) mobile scaffolds and towers; platforms within the scope of ANSI/SIA A92 and CSA-B354

(f) powered platform and equipment for exterior and interior building maintenance within the scope of ASME A120.1 and CSA-Z271

(g) conveyors and related equipment within the scope of ASME B20.1

(h) cranes, derricks, hoists, hooks, jacks, and slings within the scope of ASME B30, CSA Z150, CSA B167, CSA Z202, and CSA Z248

(i) industrial trucks within the scope of ASME B56 and CSA B335

(j) portable equipment, except for portable escalators, that are covered by 6.1

(k) tiering or piling machines used to move material to and from storage located and operating entirely within one story

(l) equipment for feeding or positioning material at machine tools, printing presses, etc.

(m) skip or furnace hoists

(n) wharf ramps

(o) amusement devices

(p) stage and orchestra lifts

(q) lift bridges

(r) railroad car lifts and dumpers

(s) mechanized parking garage equipment

(t) line jacks, false cars, shafters, moving platforms, and similar equipment used for installing an elevator

(u) platform-type elevators installed on board a marine vessel

NOTES:

(1) A maritime, industrial-use device with no car enclosure. Controls are located outside of the hoistway. Typically utilizes elevator-type rail systems and elevator-type interlock systems.

(2) Not a platform lift within the scope of A18.1.

(v) dock levelers (freight platform lifts) having a rise of 500 mm (20 in.) or less

(w) in Canadian jurisdictions, devices having a rise of 2 000 mm (79 in.) or less and used only for the transfer of materials or equipment

(x) in jurisdictions enforcing NBCC, mine elevators within the scope of 5.9

1.1.3 Application of Parts

This Code applies to new installations only, except Part 1, and 5.10, 8.1, 8.6, 8.7, 8.8, 8.9, 8.10, and 8.11, that apply to both new and existing installations.

(13) 1.1.4 Effective Date

The requirements of this edition to the Code are effective as of the date noted on the Summary of Changes page of this document with the exception of 8.10.1.1.3 and 8.11.1.1 that shall be effective immediately. The authority having jurisdiction will establish the effective date for their local regulations.

SECTION 1.2 PURPOSE AND EXCEPTIONS

1.2.1 Purpose

The purpose of this Code is to provide for the safety of life and limb, and to promote the public welfare. Compliance with this Code shall be achieved by

(a) conformance with the requirements in ASME A17.1/CSA B44; or

(b) conformance with some of the requirements in ASME A17.1/CSA B44 and for systems, subsystems, components, or functions that do not conform with certain requirements in ASME A17.1/CSA B44, conform with the applicable requirements in ASME A17.7/CSA B44.7; or

(c) conformance with the requirements in ASME A17.7/CSA B44.7

(ED) 1.2.2 Exceptions to ASME A17.1/CSA B44

The provisions of this Code are not intended to prevent the use of systems, methods, or devices of equivalent or superior quality, strength, fire resistance, effectiveness, durability, and safety to those prescribed by this Code, provided that there is technical documentation to demonstrate the equivalency of the system, method, or device.

1.2.2.1 The specific requirements of this Code shall be permitted to be modified by the authority having jurisdiction based upon technical documentation or physical performance verification to allow alternative arrangements that will assure safety equivalent to that which would be provided by conformance to the corresponding requirements of this Code.

1.2.2.2 This Code contains requirements that are also covered in the National Building Code of Canada (NBCC). Reference to the NBCC is recognition that said requirements are not within the scope of this Code in Canada.

In jurisdictions not enforcing the NBCC, the use of the NBCC is not intended.

1.2.2.3 Exceptions shall be based on the requirements of 1.2.2.1.

(13) SECTION 1.3 DEFINITIONS

Section 1.3 defines various terms used in this Code. In addition, some nomenclature and terminology used

in the elevator industry and other ASME publications are defined.

access switch: see *hoistway access switch*.

accredited certifying organization: a certifying organization that holds valid Documentation of Accreditation issued by an independent internationally or nationally recognized accrediting organization that accredits personnel certification bodies.

NOTE: A Certificate of Accreditation is an example of such documentation.

accrediting body: an independent internationally or nationally recognized organization that accredits organizations concerned with personnel certification.

alteration: any change to equipment, including its parts, components, and/or subsystems, other than maintenance, repair, or replacement.

alteration, as part of an: a repair or replacement that is included with other work that is classified as an alteration.

alternate level: a floor level identified by the building code or fire authority, other than the designated level.

annunciator, car: an electrical device in the car that indicates visually the landings at which an elevator landing signal registering device has been actuated.

applied frame entrance: a wraparound or partial addition to an existing entrance frame used to improve the appearance or to provide the required clearances.

approved: acceptable to the authority having jurisdiction.

authority having jurisdiction: the organization, office, or individual responsible for enforcement of this Code. Where compliance with this Code has been mandated by legislation or regulation, the "authority having jurisdiction" is the regulatory authority (see *regulatory authority*).

authorized personnel: persons who have been instructed in the operation of the equipment and designated by the owner to use the equipment.

automatic transfer device: a power-operated mechanism that automatically moves a load consisting of a cart, tote box, pallet, wheeled vehicle, box, or other similar object from and/or to the car.

auxiliary power lowering device: an alternatively powered auxiliary control system that will, upon failure of the main power supply, allow a hydraulic elevator to descend to a lower landing.

base, building: the level at which the horizontal seismic ground motions are considered to be imparted to the structure.

brake, driving machine, elevator, dumbwaiter, or material lift: an electromechanically or electrohydraulically released spring, or gravity applied device, that is part

of the electric driving machine of the elevator, dumb-waiter, or material lift used to apply a controlled force at a braking surface to hold or retard the elevator, dumb-waiter, or material lift. See Nonmandatory Appendix F.

electrohydraulically released: a means of release in which an electric current applied to a solenoid valve or the motor of a hydraulic pump directs pressurized hydraulic fluid to an actuator (such as a hydraulic jack) that overcomes a resisting force (such as a spring) as long as the electric current flows.

electromechanically released: a means of release in which an electric current applied to an actuator (such as a solenoid) causes an electromagnetic force that overcomes a resisting force (such as a spring) as long as the electric current flows.

brake, driving machine, escalator, or moving walk: an electromechanical device that is part of the electric driving machine of the escalator or moving walk, used to apply a controlled force to a braking surface to stop and hold the escalator/moving walk system.

brake, emergency: a mechanical device independent of the braking system used to retard or stop an elevator should the car overspeed or move in an unintended manner. Such devices include, but are not limited to, those that apply braking force on one or more of the following:

- (a) car rails
- (b) counterweight rails
- (c) suspension or compensation ropes
- (d) drive sheaves
- (e) brake drums

For further information, see Nonmandatory Appendix F.

brake, main drive shaft, escalator and moving walk: a device located on the main drive shaft of the escalator or moving walk used to apply a controlled force to the braking surface to stop and hold the escalator or moving walk system.

braking, electrically assisted: retardation of the elevator, assisted by energy generated by the driving-machine motor. See Nonmandatory Appendix F.

braking system: driving-machine brake alone, or in combination with electrically assisted braking, that operates to slow down and stop the elevator. See Nonmandatory Appendix F.

buffer: a device designed to stop a descending car or counterweight beyond its normal limit of travel by storing or by absorbing and dissipating the kinetic energy of the car or counterweight.

oil buffer: a buffer using oil as a medium, that absorbs and dissipates the kinetic energy of the descending car or counterweight.

gas spring-return oil buffer: an oil buffer utilizing the pressure of a compressed gas to return the buffer plunger or piston to its fully extended position.

mechanical spring-return oil buffer: an oil buffer utilizing the force of the compressed mechanical spring or springs to return the buffer plunger or piston to its fully extended position.

oil buffer stroke: the oil-displacing movement of the buffer plunger or piston, excluding the travel of the buffer plunger accelerating device.

spring buffer: a buffer utilizing one or more springs to cushion the impact force of the descending car or counterweight.

spring buffer load rating: the load required to compress the spring buffer an amount equal to its stroke.

spring buffer stroke: the distance the contact end of the spring can move under a compressive load until all coils are essentially in contact or until a fixed stop is reached.

building code: an ordinance that sets forth requirements for building design and construction, or where such an ordinance has not been enacted, one of the following model codes:

- (a) International Building Code (IBC)
- (b) Building Construction and Safety Code (NFPA 5000)
- (c) National Building Code of Canada (NBCC)

NOTE: Local regulations or laws take precedence. In the absence of local regulation a model building code is applicable.

bumper: a device, other than an oil or spring buffer, designed to stop a descending car or counterweight beyond its normal limit of travel by absorbing the impact.

cable, traveling: see *traveling cable*.

capacity: see *rated load*.

car-direction indicator: a visual signaling device that displays the current direction of travel.

car door interlock: a device having two related and interdependent functions, which are

- (a) to prevent the operation of the driving machine by the normal operating device unless the car door is locked in the closed position
- (b) to prevent the opening of the car door from inside the car unless the car is within the landing zone and is either stopped or being stopped

car door or gate electric contact: an electrical device, the function of which is to prevent operation of the driving machine by the normal operating device unless the car door or gate is in the closed position.

car door or gate, power-closed: a door or gate that is closed by a door or gate power operator.

car door or gate power closer: a device or assembly of devices that closes a manually opened car door or gate by power other than hand, gravity, springs, or the movement of the car.

car, dumbwaiter, material lift: the load-carrying unit that includes a platform or transfer device and may include an enclosure and/or car frame.

car, elevator: the load-carrying unit including its platform, car frame, enclosure, and car door or gate.

car enclosure: the top and the walls of the car resting on and attached to the car platform.

car frame: the supporting frame to which the car platform, upper and lower sets of guide shoes, car safety, and the hoisting ropes or hoisting-rope sheaves, or the plunger or cylinder of a direct-acting elevator, are attached.

car frame, overslung: a car frame to which the hoisting rope fastenings or hoisting-rope sheaves are attached to the crosshead or top member of the car frame.

car frame, sub-post: a car frame all of whose members are located below the car platform.

car frame, underslung: a car frame to which the hoisting-rope fastenings or hoisting-rope sheaves are attached at or below the car platform.

car lantern: an audible and visual signaling device located in a car to indicate the car is answering the call and the car's intended direction of travel.

car platform: the structure that forms the floor of the car and that directly supports the load.

car platform frame: a structural frame, composed of interconnecting members, that supports the car platform floor.

car platform, laminated: a self-supporting platform constructed of plywood, with a bonded steel sheet facing on both top and bottom surfaces.

car top access panel: a car top access panel is similar in design to a car top emergency exit panel. Used on mine elevators to permit frequent inspection of mine elevator hoistways for damage caused by environmental conditions. Such panels are openable without the use of tools or keys.

NOTE: Subject to the modifications specified in 5.9.14.1(c).

ceramic permanent magnet: a magnet of the type that has a force that does not deteriorate with time.

certified: see *listed/certified*.

certifying organization: an approved or accredited, independent organization concerned with product evaluation that maintains periodic inspection of production of listed/certified equipment or material and whose listing/certification states whether that equipment meets appropriate standards or has been tested and found suitable for use in a specified manner.

NOTE: For the purpose of this definition, *accredited* means that an organization has been evaluated and approved by an Authorized Agency to operate a Certification/Listing program, and is designated as such in a publication of the Authorized Agency.

chain, suspension (hoisting): chain used to raise and lower a dumbwaiter or material lift car or its counterweight.

chassis: that portion of an inclined elevator that serves as a car frame with weight-bearing guide rollers.

clearance, bottom car: the clear vertical distance from the pit floor to the lowest structural or mechanical part, equipment, or device installed beneath the car platform, except guide shoes or rollers, safety jaw assemblies, and platform or guards, when the car rests on its fully compressed buffers.

clearance, top car, inclined elevators: the shortest distance in the direction of travel between the upwardmost portion of the chassis (car frame) and the nearest obstruction when the car is level with the top terminal landing.

clearance, top counterweight: the shortest vertical distance between any part of the counterweight structure and the nearest part of the overhead structure or any other obstruction when the car floor is level with the bottom terminal landing.

comb, escalator and moving walk: the toothed portion of a combplate designed to mesh with a grooved step, pallet, or treadway surface.

combplate, escalator and moving walk: that portion of the landing adjacent to the step, pallet, or treadway consisting of one or more plates to which the combs are fastened.

compensating rope sheave switch: a device that automatically causes the electric power to be removed from the elevator, dumbwaiter, or material lift driving-machine motor and brake when the compensating sheave approaches its upper or lower limit of travel.

compensation means: wire rope, chain, or other mechanical means used to counterbalance, or partially counterbalance, the weight of the suspension ropes.

component rated pressure: the pressure to which a hydraulic component can be subjected.

control, motion: that portion of a control system that governs the acceleration, speed, retardation, and stopping of the moving member.

control, AC motor: a motion control that uses an alternating current motor to drive the machine.

control, AC motor, DC injection: a motion control for an AC motor that produces retardation torque by injecting a DC current into either a stator winding of the motor or a separate eddy-current brake.

control, single speed AC: a motion control for an AC motor that has a single synchronous speed.

control, two speed AC: a motion control for an AC motor that has two different synchronous speeds by connecting the motor windings so as to obtain a different number of poles.

control, variable voltage, variable frequency (VVVF): a motion control that changes the magnitude and frequency of the voltage applied to the motor.

control, variable voltage AC (VVAC): a motion control for an AC motor that varies the amount and direction of output torque by controlling the magnitude and phase sequence of the voltage to the motor.

control, DC motor: a motion control that uses a DC motor to drive the machine.

control, dual bridge thyristor converter: a motion control for a DC motor that supplies the armature with variable voltage of either polarity, and is capable of current flow in both directions.

control, generator field: a motion control that is accomplished by the use of an individual generator for each driving-machine motor wherein the voltage applied to the motor armature is adjusted by varying the strength and direction of the generator field current.

control, multivoltage: a motion control that is accomplished by impressing successively on the armature of the driving-machine motor a number of substantially fixed voltages such as may be obtained from multi-commutator generators common to a group of elevators.

control, rheostatic: a motion control that is accomplished by varying resistance and/or reactance in the armature and/or field circuit of the driving-machine motor.

control, single bridge thyristor converter: a motion control for a DC motor that supplies the armature with variable voltage of fixed polarity. The field is reversed to control direction and to cause regeneration.

control, electrohydraulic: a motion control in which the acceleration, speed, retardation, and stopping are governed by varying fluid flow to/from the hydraulic jack by electrically operated valves.

control, mechanical-hydraulic: a motion control in which acceleration, speed, retardation, and stopping are governed by varying the fluid flow to/from the hydraulic jack by direct mechanical operation of the valves by shipper rope or operating lever device.

control, static: a motion control in which control functions are performed by solid-state devices.

control, operation: that portion of a control system that initiates the starting, stopping, and direction of motion, in response to a signal from an operating device.

operation, automatic: operation control wherein the starting of the elevator, dumbwaiter, or material lift car is effected in response to the momentary actuation of operating devices at the landing, and/or of operating devices in the car identified with the landings, and/or in response to an automatic starting mechanism, and wherein the car is stopped automatically at the landings.

operation, automatic call: operation control wherein the starting of a wind turbine tower elevator car is effected in response to the momentary actuation of operating devices not mounted on the car and wherein

the car is stopped automatically at the terminal landing or at the next landing in the direction of travel.

operation, automatic send: operation control wherein the starting of a wind turbine tower elevator car is effected in response to the momentary actuation of operating devices mounted on the car and only accessible from outside the car, wherein the car is stopped automatically at the terminal landing or at the next landing in the direction of travel.

operation, group automatic: automatic operation of two or more nonattendant elevators equipped with power-operated car and hoistway doors. The operation of the cars is coordinated by a supervisory control system including automatic dispatching means whereby selected cars at designated dispatching points automatically close their doors and proceed on their trips in a regulated manner. It may include but is not limited to: operating device(s) in the car and/or at each landing that provide a means to select destinations identified with landings; keypads or touch screens at each landing and/or in the car; buttons in each car for each floor served and "UP" and "DOWN" buttons at each landing (single buttons at terminal landings). The stops set up by the momentary actuation of these devices are made automatically in succession as a car reaches the corresponding landing, irrespective of its direction of travel or the sequence in which the devices are actuated. The stops set up by the momentary actuation of the device(s) at the landing may be accomplished by any elevator in the group, and are made automatically.

operation, nonselective collective automatic: automatic operation by means of one button in the car for each landing served and one button at each landing, wherein all stops registered by the momentary actuation of landing or car buttons are made irrespective of the number of buttons actuated or of the sequence in which the buttons are actuated. With this type of operation, the car stops at all landings for which buttons have been actuated, making the stops in the order in which the landings are reached after the buttons have been actuated, but irrespective of its direction of travel.

operation, selective collective automatic: automatic operation by means of one button in the car for each landing served and by "UP" and "DOWN" buttons at the landings, wherein all stops registered by the momentary actuation of the car buttons are made as defined under nonselective collective automatic operation, but wherein the stops registered by the momentary actuation of the landing buttons are made in the order in which the landings are reached in each direction of travel after the buttons have been actuated. With this type of operation, all "UP" landing calls are answered when the car is traveling in the up direction and all "DOWN" landing calls are answered when the car is traveling in the down direction, except in the case of the uppermost or lowermost calls, that are answered as soon as they

are reached, irrespective of the direction of travel of the car.

operation, single automatic: automatic operation by means of one button in the car for each landing served and one button at each landing, so arranged that if any car or landing button has been actuated the actuation of any other car or landing operating button will have no effect on the operation of the car until the response to the first button has been completed.

operation, car switch: operation control wherein the movement and direction of travel of the car are directly and solely under the control of the attendant by means of a manually operated car switch or of continuous-pressure buttons in the car.

operation, car switch automatic floor-stop: operation in which the stop is initiated by the attendant from within the car with a definite reference to the landing at which it is desired to stop, after which the slowing down and stopping of the elevator is effected automatically.

operation, continuous-pressure: operation control by means of buttons or switches in the car and at the landings, any one of which may be used to control the movement of the car as long as the button or switch is manually maintained in the actuating position.

operation, preregister: operation control in which signals to stop are registered in advance by buttons in the car and at the landings. At the proper point in the car travel, the attendant in the car is notified by a signal, visual, audible, or otherwise, to initiate the stop, after which the landing stop is automatic.

operation, signal: operation control by means of single buttons or switches (or both) in the car, and "UP" or "DOWN" direction buttons (or both) at the landings, by which predetermined landing stops may be set up or registered for an elevator or for a group of elevators. The stops set up by the momentary actuation of the car buttons are made automatically in succession as the car reaches those landings, irrespective of its direction of travel or the sequence in which the buttons are actuated. The stops set up by the momentary actuation of the "UP" and "DOWN" buttons at the landing are made automatically by the first available car in the group approaching the landings in the corresponding direction, irrespective of the sequence in which the buttons are actuated. With this type of operation, the car can be started only by means of a starting switch or button in the car.

control room, elevator, dumbwaiter, material lift: an enclosed control space outside the hoistway, intended for full bodily entry, that contains the motor controller. The room could also contain electrical and/or mechanical equipment used directly in connection with the elevator, dumbwaiter, or material lift but not the electric driving machine or the hydraulic machine. (See Nonmandatory Appendix Q.)

control space, elevator, dumbwaiter, material lift: a space inside or outside the hoistway, intended to be accessed with or without full bodily entry, that contains the motor controller. This space could also contain electrical and/or mechanical equipment used directly in connection with the elevator, dumbwaiter, or material lift but not the electric driving machine or the hydraulic machine. (See Nonmandatory Appendix Q.)

NOTE: See 2.7.6.3.2 for an exception regarding the location of a motor controller.

control system: the overall system governing the starting, stopping, direction of motion, acceleration, speed, and retardation of the moving member. See Nonmandatory Appendix A.

controller: a device or group of devices that serves to control in a predetermined manner the apparatus to which it is connected.

controller, motion: an operative unit comprising a device or group of devices for actuating the moving member.

controller, motor: the operative units of a motion control system comprising the starter devices and power conversion equipment required to drive an electric motor.

controller, operation: an operative unit comprising a device or group of devices for actuating the motion control.

conveyor, vertical reciprocating (VRC): see ASME B20.1 for definition and safety requirements.

creep: slight incremental, natural movement of the suspension means over their arc of contact with the driving sheave due to tractive force. The tractive force is a result of unequal tensile loads in the suspension means at points of entry and exit from the driving sheave, the tensile elasticity of the suspension member, and the frictional work occurring in the direction of the greater tension. Creep is independent of the motion status or direction of rotation of the driving sheave.

NOTE: Creep exists in all traction systems and is not loss of traction, and can occur while the drive sheave is stationary or rotating.

deck, escalator: see *escalator deck*.

designated attendant: where elevator operation is controlled solely by authorized personnel (attendant service, independent, hospital service, and other similar operations).

designated level: the main floor or other floor level that best serves the needs of emergency personnel for firefighting or rescue purposes identified by the building code or fire authority.

dispatching device, elevator automatic: a device, the principal function of which is to either

(a) operate a signal in the car to indicate when the car should leave a designated landing, or

(b) actuate its starting mechanism when the car is at a designated landing

displacement switch: a device actuated by the displacement of the counterweight, at any point in the hoistway, to provide a signal that the counterweight has moved from its normal lane of travel or has left its guide rails.

door: the movable portion(s) of an entrance that closes the openings. It consists of one or more solid face panels that are permitted to be equipped with a vision panel.

door, folding: a hinged door consisting of two or more panels that fold and move horizontally.

door, horizontally sliding: a door that moves horizontally.

center-opening: a horizontally sliding door consisting of two panels, so arranged to open away from each other.

center-opening, multiple-speed: a horizontally sliding door consisting of more than two panels, so arranged that the panels or groups of panels open away from each other.

multiple-speed: a horizontally sliding door with two or more panels, so arranged to open away from one side.

single-speed: a one-panel horizontally sliding door.

door or gate, manually operated: a door or gate that is opened and closed by hand.

door or gate, power-operated: a door or gate that is opened and closed by a door or gate power-operator.

door or gate, self-closing: a manually opened door or gate that closes when released.

door, swinging: a door that pivots around a vertical axis.

door, vertically sliding: a counterweighted or counter-balanced door consisting of one or more panels that move vertically to open or close.

door, biparting: a vertically sliding door consisting of two or more sections, so arranged that the sections or groups of sections open away from each other.

door, vertically sliding sequence operation: where the opening and closing relationship of the car and hoistway doors do not occur simultaneously.

door, wraparound: a horizontally sliding door that bends around a car enclosure.

door locked out of service: a hoistway entrance in which the door is mechanically locked by means other than the interlock to prevent the door being opened from the car side without keys or special equipment.

door or gate closer: a device that closes a door or gate by means of a spring or gravity.

door or gate electric contact: an electrical device, the function of which is to prevent operation of the driving machine by the normal operating device unless the door or gate is in the closed position.

door or gate power operator: a device or assembly of devices that opens a hoistway door(s) and/or a car door or car gate by power other than hand, gravity, springs,

or the movement of the car; and that closes them by power other than hand, gravity, or the movement of the car.

driving machine: see *machine, driving*.

driving machine, traction climbing: an uncounter-weighted driving machine where traction results from the weight of the car and its load.

dumbwaiter: a hoisting and lowering mechanism equipped with a car of limited size that moves in guide rails and serves two or more landings that is used exclusively for carrying materials, and is classified by the following types.

dumbwaiter, hand: a dumbwaiter utilizing manual energy to move the car.

dumbwaiter, power: a dumbwaiter utilizing energy other than gravitational or manual to move the car.

dumbwaiter, electric: a power dumbwaiter where the energy is applied by means of an electric driving machine.

dumbwaiter, hydraulic: a power dumbwaiter where the energy is applied, by means of a liquid under pressure, in a cylinder equipped with a plunger or piston.

dumbwaiter, direct-plunger hydraulic: a hydraulic dumbwaiter having a plunger or cylinder directly attached to the car frame or platform.

dumbwaiter, electrohydraulic: a direct-plunger dumbwaiter where liquid is pumped under pressure directly into the cylinder by a pump driven by an electric motor.

dumbwaiter, maintained-pressure hydraulic: a direct-plunger dumbwaiter where liquid under pressure is available at all times for transfer into the cylinder.

dumbwaiter, roped-hydraulic: a hydraulic dumbwaiter having its piston connected to the car with wire rope.

dumbwaiter, undercounter: a dumbwaiter that has its top terminal landing located underneath a counter.

earthquake protective devices: a device or group of devices that serve to regulate the operation of an elevator or group of elevators in a predetermined manner during or after an earthquake.

electrical/electronic/programmable electronic (E/E/PE): based on electrical (E), and/or electronic (E), and/or programmable electronic (PE) technology.

NOTE: The term is intended to cover any and all devices or systems operating on electrical principles.

EXAMPLE: Electrical/electronic/programmable electronic devices include

(a) electromechanical devices (electrical)

(b) solid-state nonprogrammable electronic devices (electronic)

(c) electronic devices based on computer technology (programmable electronic)

electrical/electronic/programmable electronic system (E/E/PES): a system for control, protection, or monitoring based on one or more electrical/electronic/

programmable electronic (E/E/PE) devices, including all elements of the system such as power supplies, sensors and other input devices, data highways and other communication paths, and actuators and other output devices.

elevator: a hoisting and lowering mechanism, equipped with a car, that moves within guides and serves two or more landings and is classified by the following types

NOTE: See 1.1.2, Equipment Not Covered by this Code.

elevator, freight: an elevator used primarily for carrying freight and on which only the operator and the persons necessary for unloading and loading the freight are permitted to ride.

NOTE (elevator, freight): Its use is subject to the modifications specified in 2.16.

elevator, hand: an elevator utilizing manual energy to move the car.

elevator, inclined: an elevator that travels at an angle of inclination of 70 deg or less from the horizontal.

elevator, limited-use/limited-application: a power passenger elevator in which the use and application is limited by size, capacity, speed, and rise.

elevator, marine: an elevator installed on board a marine vessel.

NOTES:

- (1) Marine vessels are defined by the authority having jurisdiction for the design and safety of marine vessels. Such authorities include, but are not limited to, the U.S. Coast Guard, Transport Canada, and the American Bureau of Shipping or other members of the International Association of Classification Societies.
- (2) Marine elevators are designed to operate under marine design conditions that reflect the motions, forces, and environmental conditions imposed on the vessel and the elevator, under a variety of vessel operating scenarios. See Section 5.8.

elevator, mine: an elevator installed in the mine hoistway, used to provide access to the mine for personnel, materials, equipment, and supplies. To meet the requirements of a mine elevator, the components must be designed and installed in conformance to Part 2 of this Code, except as modified in 5.9. Mine elevators are similar to electric passenger elevators but are modified to operate in the mine environment.

elevator, multicompartment: an elevator having two or more compartments located one above the other.

elevator, observation: an elevator that permits exterior viewing by passengers while the car is traveling.

elevator, outside emergency: an elevator operating on the outside of a building having up to five compartments that is operated only by emergency personnel and used solely for emergency evacuation of building occupants and transportation of a limited number of emergency responders involved in the evacuation.

elevator, passenger: an elevator used primarily to carry persons other than the operator and persons necessary for loading and unloading.

elevator, power: an elevator utilizing energy other than gravitational or manual to move the car.

elevator, electric: a power elevator where the energy is applied by means of an electric driving machine.

elevator, hydraulic: a power elevator in which the energy is applied, by means of a liquid under pressure, in a hydraulic jack.

elevator, direct-acting hydraulic: a hydraulic elevator in which the energy is applied by a direct hydraulic driving machine.

elevator, electrohydraulic: a hydraulic elevator in which liquid under pressure is supplied by a hydraulic machine.

elevator, maintained-pressure hydraulic: a direct-acting hydraulic elevator in which liquid under pressure is available at all times for transfer into the hydraulic jack.

elevator, roped-hydraulic: a hydraulic elevator in which the energy is applied by a roped-hydraulic driving machine.

elevator, private residence: a power passenger elevator that is limited in size, capacity, rise, and speed, and is installed in a private residence or in a multiple dwelling as a means of access to a private residence.

elevator, rack-and-pinion: a power elevator with or without a counterweight that is supported, raised, and lowered by a motor or motors that drive a pinion or pinions on a stationary rack mounted in the hoistway.

elevator, rooftop: a power passenger or freight elevator operating between a landing at roof level and landings below. It opens onto the exterior roof level of a building through a horizontal opening.

elevator, screw column: a power elevator having an uncounterweighted car that is supported, raised, and lowered by means of a screw thread.

elevator, sidewalk: an elevator of the freight type operating between a landing in a sidewalk or other exterior area and floors below the sidewalk or grade level. It opens onto the exterior area through a horizontal opening.

elevator, special purpose personnel: an elevator that is limited in size, capacity, and speed, and permanently installed in structures such as grain elevators, radio antenna, bridge towers, underground facilities, dams, power plants, and similar structures to provide vertical transportation of authorized personnel and their tools and equipment only.

elevator, used for construction: an elevator being used temporarily, only for construction purposes.

elevator, wind turbine tower: a hoisting and lowering mechanism equipped with a car installed in a wind turbine tower.

elevator discharge level: the floor, served by elevators, that occupants will use to leave the building during an emergency evacuation.

elevator personnel: persons who have been trained in the construction, maintenance, repair, inspection, or testing of equipment.

emergency personnel: persons who have been trained in the operation of emergency or standby power and firefighters' emergency operation or emergency evacuation.

emergency signal device: a device that can be operated from within the elevator car to inform persons outside the hoistway that help is required.

emergency stop switch: a device located as required and readily accessible for operation, that, when manually operated, causes the electric power to be removed from the driving-machine motor and brake of an electric elevator; or from the electrically operated valves and pump motor of a hydraulic elevator; or of a dumbwaiter; or of a material lift.

endurance limit of a component: the maximum stress that can be alternated or reversed within specified limits without producing fracture of the component material.

enforcing authority: see *authority having jurisdiction* and *regulatory authority*.

engineering test: a test carried out by or witnessed by a registered or licensed professional engineer, testing laboratory, or certifying organization to ensure conformance to Code requirements.

entrance assembly, elevator, dumbwaiter, or material lift: the protective assembly that closes the hoistway openings normally used for loading and unloading, including the door panel(s), gate(s), transom panel, fixed side panel, gibs/guides, sill/sill structure, header, frame, and entrance hardware assembly, if provided.

entrance assembly, horizontally sliding type: an entrance assembly in which the door(s) slides horizontally.

entrance assembly, swinging type: an entrance assembly in which the door(s) swings around vertical hinges.

entrance assembly, vertically sliding type: an entrance assembly in which the door(s) slides vertically.

entrance frame, applied: see *applied frame entrance*.

entrance hardware assembly: the track(s), hangers, drive arms, pendant bolts, chains, belts, cables, sheaves, pulleys, hinges, vertically sliding guide shoes, and related hardware that are necessary to suspend and maintain the position of the doors within the entrance assembly.

escalator: power-driven, inclined, continuous stairway used for raising or lowering passengers.

escalator, conventional: an escalator on which the running gear is driven by a single drive shaft at a terminal.

escalator, modular: an escalator on which the running gear along the incline is driven by one or more drive units.

escalator deck: the transverse members of the balustrade, having an interior or exterior section, or both. A high deck is located immediately below the handrail stand. A low deck is located immediately above the skirt panel.

escalator molding: the connecting means between the various portions of the balustrade.

escalator newel: the balustrade termination at the landing.

escalator newel base: the panel located immediately under the newel.

escalator panel, exterior: the panel enclosing the exterior side of the balustrade.

escalator panel, interior: the panel located between the skirt and the escalator high deck or the handrail stand.

escalator skirt: the fixed, vertical panels located immediately adjacent to the steps.

escalator skirt cover, dynamic: the stationary cover that protects the interface between the dynamic skirt panel and the escalator balustrade.

escalator skirt, dynamic: see *skirt panel, dynamic*.

escalator wellway: an opening in a floor provided for escalator installation between two levels of a building.

escalators, tandem operation: escalators used in series with common intermediate landings.

factor of safety: the ratio of the ultimate strength to the working stress of a member under maximum static loading, unless otherwise specified in a particular requirement.

fail safe: a characteristic of a system or its elements whereby any failure or malfunction affecting safety will cause the system to revert to a state that is known to be safe.

fire barrier: a fire-resistance-rated vertical or horizontal assembly of material designed to restrict the spread of fire in which the openings are protected.

fire-protection rating: a designation indicating the duration of the fire test exposure to which a fire door assembly (entrance) was exposed and for which it met all the acceptance criteria as determined in accordance with a recognized fire test standard. Ratings are stated in hours or minutes.

fire-resistance rating: a designation indicating the duration of the fire test exposure to which components of building construction (walls, floors, roofs, beams, and columns) are exposed and for which it met all the acceptance criteria as determined in accordance with a recognized fire test standard. Ratings are stated in hours or minutes.

fire-resistive construction: a method of construction that prevents or retards the passage of hot gases or flames, specified by the building code.

fixed side panel: a panel used to close a hoistway enclosure opening on the side of a hoistway entrance.

flat steps: the distance, expressed in step lengths, that the leading edge of the escalator step travels after emerging from the comb before moving vertically.

gate: the moveable portion(s) of an entrance that closes the opening. A gate has through openings.

horizontally sliding collapsible gate: a series of horizontally sliding vertical members, joined by a scissors-like linkage that allows the assembly to collapse.

horizontally sliding noncollapsible gate: a noncollapsible assembly consisting of one or more sections that slide horizontally.

vertically sliding gate: a counterweighted or counterbalanced assembly, consisting of one or more sections that move vertically to open or close.

gate, semiautomatic: a gate that is opened manually and that is closed automatically as the car leaves the landing.

governor: see *speed governor*.

governor pull-through tension (force): the magnitude of the tensile load developed in the moving governor rope after the governor rope retarding means is actuated.

governor rope retarding means: a mechanical means of developing a sufficient force in the governor rope to activate the car or counterweight safeties or to trip the governor rope releasing carrier, where used. Such mechanical means include, but are not limited to, rope-gripping jaws, clutch mechanisms, and traction arrangements.

guide rope fixes: wire guide rope attachment hardware securing the guiding system to the structure.

guiding means, ladder: the guide system where the tower ladder is used to guide the car within the travel path.

hall lantern: an audible and visual signaling device located at a hoistway entrance to indicate which car is answering the call and the car's intended direction of travel.

handrail stand: the uppermost portion of the balustrade that supports and guides the handrail.

hard, copy: a written record or log of all items specified in the maintenance records.

hoistway (shaft), elevator, dumbwaiter, or material lift: an opening through a building or structure for the travel of elevators, dumbwaiters, or material lifts, extending from the pit floor to the roof or floor above.

hoistway, blind: the portion of a hoistway where hoistway entrances are not provided.

hoistway, multiple: a hoistway with more than one elevator, dumbwaiter, or material lift.

hoistway, single: a hoistway with a single elevator, dumbwaiter, or material lift.

hoistway, mine: The area within a mine shaft, and its aboveground structure required for the elevator equipment, associated supports, and operations, including a minimum of 450 mm (18 in.) around same.

hoistway access switch: a switch, located at a landing, the function of which is to permit operation of the car with the hoistway door at this landing and the car door or gate open, in order to permit access to the top of the car or to the pit.

hoistway door: see *door*.

hoistway door electric contact: see *door or gate electric contact*.

hoistway door or gate locking device: a device that secures a hoistway door or gate in the closed position and prevents it from being opened from the landing side except under certain specified conditions.

hoistway door combination mechanical lock and electric contact: a combination mechanical and electrical device with two related, but entirely independent functions, that are

(a) to prevent operation of the driving machine by the normal operating device unless the hoistway door is in the closed position

(b) to lock the hoistway door in the closed position and prevent it from being opened from the landing side unless the car is within the landing zone

NOTE: As there is no positive mechanical connection between the electric contact and the door locking mechanism, this device ensures only that the door will be closed, but not necessarily locked, when the car leaves the landing. Should the lock mechanism fail to operate as intended when released by a stationary or retiring car-cam device, the door can be opened from the landing side even though the car is not at the landing. If operated by a stationary car-cam device, it does not prevent opening the door from the landing side as the car passes the floor.

hoistway door interlock: a device having two related and interdependent functions, that are

(a) to prevent the operation of the driving machine by the normal operating device unless the hoistway door is locked in the closed position

(b) to prevent the opening of the hoistway door from the landing side unless the car is within the landing zone and is either stopped or being stopped

hoistway door interlock retiring cam device: a device that consists of a retractable cam and its actuating mechanism and that is entirely independent of the car door or hoistway door power operator.

hoistway gate separate mechanical lock: a mechanical device the function of which is to lock a hoistway gate in the closed position after the car leaves a landing and prevent the gate from being opened from the landing side unless the car is within the landing zone.

hoistway enclosure: the fixed structure, consisting of vertical walls or partitions, that isolates the hoistway

from all other areas or from an adjacent hoistway and in which entrances are installed.

hoistway gate: usually a counterweighted (counterbalanced) assembly, consisting of one or more sections that are guided in the vertical direction to open or close. The gate may be of wood or metal construction. Wood gates may consist of either horizontal or vertical slats. Metal gates are usually constructed of perforated or expanded metal.

hospital service: a special case of operation by a designated attendant used only for medical emergencies.

hydraulic jack: a unit consisting of a cylinder equipped with a plunger (ram) or piston, that applies the energy provided by a liquid under pressure.

hydraulic machine: a unit consisting of pump, motor, valves, and associated internal piping, that converts electrical energy and supplies it as a liquid under pressure.

in-car stop switch: a device located in the car and accessible for operation by elevator personnel only, that, when manually operated, causes the electric power to be removed from the driving-machine motor and brake of an electric elevator or from the electrically operated valves and pump motor of a hydraulic elevator.

inclined elevator: see *elevator, inclined*.

installation: a complete elevator, dumbwaiter, escalator, material lift, or moving walk, including its hoistway, hoistway enclosures and related construction, and all machinery and equipment necessary for its operation.

installation, existing: an installation that has been completed or is under construction prior to the effective date of this Code.

installation, new: any installation not classified as an existing installation by definition, or an existing elevator, dumbwaiter, escalator, material lift, inclined lift, or moving walk moved to a new location subsequent to the effective date of this Code.

intended car movement: controlled movement of an elevator car, including starting, leveling, running, and stopping, due to

(a) operation control

(b) motion control

(c) continuous pressure on an operating device during inspection operation, inspection operation with open door circuits, or hoistway access operation

NOTE: "Stopping" includes movement of an elevator car towards rest once stopping is initiated, and any movement of an elevator car due to suspension system elasticity that occurs after the brake is set, since this movement was the result of the intended operation.

interlock: see *car door interlock* and *hoistway door interlock*.

labeled/marked: equipment or material to which has been attached a label, symbol, or other identifying mark of an approved or accredited independent certifying organization, concerned with product evaluation, that

maintains periodic inspection of production of labeled/ marked equipment or material, and by whose labeling/ marking the manufacturer indicates compliance with appropriate standards or performance in a specified manner.

NOTE: For the purpose of this definition, *accredited* means that an organization has been evaluated and approved by an Authorized Agency to operate a Certification/Listing program, and is designated as such in a publication of the Authorized Agency.

landing, dumbwaiter: that portion of a floor, balcony, platform, or landing door used to discharge and receive materials.

landing, elevator or material lift: that portion of a floor, balcony, or platform used to receive and discharge passengers or freight.

landing, bottom terminal: the lowest landing served by the elevator or material lift that is equipped with a hoistway entrance.

landing, top terminal: the highest landing served by the elevator or material lift that is equipped with a hoistway entrance.

landing, escalator or moving walk: the stationary area at the entrance to or exit from an escalator, a moving walk, or moving walk system.

landing, lower, escalator: that landing of least elevation of the two landings.

landing, lower, moving walk: that landing of least elevation of the two landings. On moving walks where the two landings are of equal elevation, the lower landing is that landing designated by the manufacturer.

landing, upper, escalator: that landing of greatest elevation of the two landings.

landing, upper, moving walk: that landing of greatest elevation of the two landings. On moving walks where the two landings are of equal elevation, the upper landing is that landing designated by the manufacturer.

landing, next available: the first landing in the direction of travel that the elevator is electrically and mechanically capable of serving with a normal slowdown and stop.

landing zone: a zone extending from a point 450 mm (18 in.) below a landing to a point 450 mm (18 in.) above the landing.

left, right convention: left and right designations of escalator and moving walk components are determined by facing the equipment at the lower landing.

leveling: controlled car movement toward the landing, within the leveling zone, by means of a leveling device, that vertically aligns the car platform sill relative to the hoistway landing sill to attain a predetermined accuracy.

leveling device, elevator, dumbwaiter, or material lift car: the portion of a motion control system comprised of a device or group of devices that, either automatically or under control of the operator, initiates leveling, and automatically stops the car at the landing.

leveling device, anticreep: a leveling device used on hydraulic elevators to correct automatically a change in car level caused by leakage or contraction of fluid in the hydraulic system.

leveling device, inching: a leveling device that is controlled by the operator by means of continuous-pressure switches.

leveling device, one-way automatic: a device that corrects the car level only in case of under-run of the car, but will not maintain the level during loading and unloading.

leveling device, two-way automatic maintaining: a device that corrects the car level on both under-run and over-run, and maintains the level during loading and unloading.

leveling device, two-way automatic nonmaintaining: a device that corrects the car level on both under-run and over-run, but will not maintain the level during loading and unloading.

leveling zone: the limited distance above or below an elevator, dumbwaiter, or material lift landing within which the leveling device is permitted to cause movement of the car toward the landing.

listed/certified: equipment or materials accepted for inclusion in a publication by a certifying organization.

NOTE: The means for identifying *listed/certified* equipment may vary for each organization concerned with product evaluation, some of which do not recognize equipment as listed/certified unless it is also labeled/marked. The authority having jurisdiction utilizes the system employed by the listing/certifying organization to identify a listed/certified product.

load, dynamic: the load applied as a result of acceleration or deceleration.

load, impact: a suddenly applied load.

load, static: the load applied as a result of the weight.

lower landing, escalator: see *landing, lower, escalator*.

lower landing, moving walk: see *landing, lower, moving walk*.

machine, driving: the power unit that applies the energy necessary to drive an elevator or other equipment covered by the scope of this Code.

driving machine, chain, dumbwaiter or material lift: a driving machine in which the motion of a car is obtained through a connection between a driven sprocket and the suspension chains.

driving machine, electric: a driving machine in which the energy is applied by an electric motor. It includes the motor, driving-machine brake, and the driving sheave or drum, together with its connecting gearing, belt, or chain, if any. See Nonmandatory Appendix F.

driving machine, direct: an electric driving machine, the motor of which is directly connected mechanically to the driving sheave, drum, or shaft without the use of belts or chains, either with or without intermediate gears.

geared driving machine: a direct driving machine in which the energy is transmitted from the motor to the driving sheave, drum, or shaft through gearing.

winding drum machine: a geared driving machine in which the suspension ropes are fastened to and wind on a drum.

traction machine: a direct driving machine in which the motion of a car is obtained through friction between the suspension ropes and a traction sheave.

geared traction machine: a geared-drive traction machine.

gearless traction machine: a traction machine, without intermediate gearing, that has the traction sheave and the brake drum mounted directly on the motor shaft.

worm-geared machine: a direct driving machine in which the energy from the motor is transmitted to the driving sheave or drum through worm gearing.

driving machine, indirect: an electric driving machine, the motor of which is connected indirectly to the driving sheave, drum, gear reducer, or shaft by means of a belt drive or chain drive.

belt driving machine: an indirect driving machine equipped with a belt system as the connecting means.

chain driving machine: an indirect driving machine with a chain system as the connecting means.

driving machine, rack-and-pinion: an electric driving machine in which the motion of the car is obtained by a power-driven rotation pinion(s) mounted on the car, traveling on a stationary rack mounted in the hoistway.

driving machine, screw: an electric driving machine, the motor of which drives a nut on a vertical screw or rotates a vertical screw to raise or lower an elevator car.

driving machine, hydraulic: a driving machine in which the energy is provided by a hydraulic machine and applied by a hydraulic jack.

chain-hydraulic drive machine: a hydraulic driving machine in which the drive member of the hydraulic jack is connected to the car by chains or indirectly coupled to the car by means of chains and sprockets.

direct hydraulic driving machine: a hydraulic driving machine in which the driving member of the hydraulic jack is directly attached to the car frame or platform.

roped-hydraulic driving machine: a hydraulic driving machine in which the driving member of the hydraulic jack is connected to the car by wire ropes or indirectly coupled to the car by means of wire ropes and sheaves. It includes multiplying sheaves, if any, and their guides.

machine room and control room, remote, elevator, dumbwaiter, material lift: a machine room or control room that is not attached to the outside perimeter or surface of the walls, ceiling, or floor of the hoistway. (See Nonmandatory Appendix Q.)

machine room, elevator, dumbwaiter, material lift: an enclosed machinery space outside the hoistway,

intended for full bodily entry, that contains the electric driving machine or the hydraulic machine. The room could also contain electrical and/or mechanical equipment used directly in connection with the elevator, dumbwaiter, or material lift. (See Nonmandatory Appendix Q.)

machinery space, elevator, dumbwaiter, material lift: a space inside or outside the hoistway, intended to be accessed with or without full bodily entry, that contains elevator, dumbwaiter, or material lift mechanical equipment, and could also contain electrical equipment used directly in connection with the elevator, dumbwaiter, or material lift. This space could also contain the electric driving machine or the hydraulic machine. (See Nonmandatory Appendix Q.)

machinery space and control space, remote, elevator, dumbwaiter, material lift: a machinery space or control space that is not within the hoistway, machine room, or control room, and that is not attached to the outside perimeter or surface of the walls, ceiling, or floor of the hoistway. (See Nonmandatory Appendix Q.)

main floor: the floor providing normal egress from a building.

maintained pressure: the hydraulic pressure between the pressure source and the control valves of a maintained pressure hydraulic elevator.

maintenance: a process of routine examination, lubrication, cleaning, and adjustment of parts, components, and/or subsystems for the purpose of ensuring performance in accordance with the applicable Code requirements. (See also *repair* and *replacement*.)

maintenance control program (MCP): a documented set of maintenance tasks, maintenance procedures, examinations, and tests to ensure that equipment is maintained in compliance with the requirements of 8.6.

maintenance interval: the specified period between the occurrences of a specific maintenance task.

maintenance procedure: an instruction or sequence of instructions for performing a specific task(s).

maintenance task: a maintenance activity (work) that needs to be accomplished.

manually (manual) reset, elevator:

(a) a type or feature of an elevator part or component that, when actuated, requires intervention of a person in order to reinstate it to its non-actuated state.

(b) a type of action required to be taken by a person to reinstate an elevator part or component from an actuated state to its non-actuated state.

manual reset, escalator and moving walk: a means, not accessible to the general public or authorized personnel, requiring on-site intervention by elevator personnel prior to restarting the escalator or moving walk.

material lift: an elevator designed or modified for the purpose of transporting materials that are manually or automatically loaded or unloaded and are not a vertical reciprocating conveyor (see 1.3). Material lifts without an automatic transfer device are Type A or Type B. On Type A material lifts no persons are permitted to ride. On Type B material lifts authorized personnel are permitted to ride.

may: indicates permission, not a mandatory requirement.

means, compensation: the method by which unbalanced forces due to suspension means are reduced, utilizing one or more compensation members and their terminations.

means, suspension: tensile components that support, raise, and lower a car, counterweight, or both.

mechanical lock: see *hoistway door combination mechanical lock and electric contact* and *hoistway gate separate mechanical lock*.

member, compensation: a single component of a traction elevator the weight of which provides tensile forces on the car and counterweight that reduce unbalanced forces due to the weight of the suspension means.

member, suspension: an individual load-carrying component of the suspension means (e.g., a single rope or belt).

mode of operation: a way in which a safety-related system is intended to be used, with respect to the rate of demands made upon it, that may be either

(a) *low demand mode:* where the frequency of demands for operation made on an electrical safety function is not greater than one per year and not greater than twice the proof-test frequency

(b) *high demand or continuous mode:* where the frequency of demands for operation made on a safety-related system is greater than one per year or greater than twice the proof-test frequency

NOTE: High demand or continuous mode covers those safety-related systems that implement continuous control to maintain functional safety.

(c) *proof-test:* a periodic test performed to detect failures in a safety-related system so that, if necessary, the system can be restored to an “as new” condition or as close as practical to this condition

NOTE: See IEC 61508-4, Clause 3.8.5 for additional information on this definition.

modernization: see *alteration*.

module: the increment of rise in a modular escalator that one drive unit is capable of powering.

molding, escalator: see *escalator molding*.

moving walk: a type of passenger-carrying device on which passengers stand or walk, and in which the passenger-carrying surface remains parallel to its direction of motion and is uninterrupted.

moving walk, belt pallet type: a moving walk with a series of connected and power-driven pallets to which a continuous belt treadway is fastened.

moving walk, belt type: a moving walk with a power-driven continuous belt treadway.

moving walk, edge-supported belt type: a moving walk with the treadway supported near its edges by a succession of rollers.

moving walk, pallet type: a moving walk with a series of connected and power-driven pallets that together constitute the treadway.

moving walk, roller-bed type: a moving walk with the treadway supported throughout its width by a succession of rollers.

moving walk, slider-bed type: a moving walk with the treadway sliding upon a supporting surface.

moving walk newel: the balustrade termination at the landing.

moving walk newel base: the panel located immediately under the newel.

moving walk wellway: an opening in a floor provided for moving walk installation.

newel, escalator: see *escalator newel*.

newel, moving walk: see *moving walk newel*.

newel base, escalator: see *escalator newel base*.

newel base, moving walk: see *moving walk newel base*.

nonstop switch, elevator: a switch that, when operated, will prevent the elevator from making registered landing stops.

normal stopping means: that portion of the operation control that initiates stopping of the car in normal operation at landings.

Occupant Evacuation Operation: the operation of an elevator system for occupant evacuation under emergency conditions.

operating device: the car switch, push buttons, key or toggle switches, or other devices used to actuate the operation control.

operating speed in the down direction: the speed at which a hydraulic elevator, dumbwaiter, or material lift is set to lower with rated load.

operation, inspection: a special case of continuous-pressure operation used for troubleshooting, maintenance, repair, adjustments, rescue, and inspection.

overhead structure: all of the structural members, walls, platforms, etc., supporting the elevator machinery, sheaves, and equipment at the top of the hoistway.

pallet, moving walk: one of a series of rigid platforms that together form an articulated treadway or the support for a continuous treadway.

pallet band: the complete assembly formed by all of the pallets and their interconnecting means.

panel, exterior escalator: see *escalator panel, exterior*.

panel, interior escalator: see *escalator panel, interior*.

parking device, elevator: an electrical or mechanical device, the function of which is to permit the opening of the hoistway door from the landing side when the car is within the landing zone of that landing. The device may also be used to close the door.

penetrate a floor: to pass through or pierce a floor in such a way that the opening has a continuous perimeter and is provided only to allow the equipment to pass through the floor.

periodic tests, category: a grouping of tests performed at common time intervals required by the authority having jurisdiction.

Phase I Emergency Recall Operation: the operation of an elevator where it is automatically or manually recalled to the recall level and removed from normal service because of activation of firefighters' emergency operation.

Phase II Emergency In-Car Operation: the operation of an elevator by firefighters where the elevator is under their control.

piston: a short cylindrical member that is provided with a sealing means that travels with the member within a hydraulic cylinder. Pistons may be coupled to the elevator, dumbwaiter, or material lift by a coupling means that passes through a sealing means provided in the cylinder head.

piston, rod: the coupling means between the piston and its driven member.

pit, dumbwaiter, material lift: the portion of a hoistway extending from the floor level of the bottom terminal landing to the floor at the bottom of the hoistway.

pit, elevator: the portion of a hoistway extending from the sill level of the bottom terminal landing to the floor at the bottom of the hoistway.

platform, landing: permanent deck installed in wind turbine towers to access tower components.

plunger (ram): a long cylindrical compression member that is directly or indirectly coupled to the car frame. This member is not provided with a sealing means. Where used in assembly with a cylinder, the sealing means is provided on the cylinder head. In the case of telescopic plungers and cylinders, a sealing means may be used in the moving plunger, that is also a cylinder.

plunger gripper: a mechanical device attached to a supporting structure in the pit, that stops and holds the car by gripping the plunger.

position indicator: a device that indicates the position of the elevator, dumbwaiter, or material lift car in the hoistway. It is called a hall position indicator when placed at a landing or a car position indicator when placed in the car.

power unit, hydraulic: see *hydraulic machine*.

pressure piping: the piping for a hydraulic elevator between the pump and the hydraulic jack.

private residence: a separate dwelling or a separate apartment in a multiple dwelling that is occupied only by the members of a single family unit.

private residence elevator: see *elevator*.

rated load, elevator, dumbwaiter, material lift, or escalator: the load that the equipment is designed and installed to lift at the rated speed.

rated load, moving walk: the load that the moving walk is designed and installed to move, horizontally or at an incline, at the rated speed.

rated load performance: the operation of the elevator with its rated load at rated speed.

rated speed: the speed at which the elevator, dumbwaiter, escalator, moving walk, or material lift is designed to operate under the following conditions:

elevator, dumbwaiter, or material lift: the speed in the up direction with rated load in the car. (See also *operating speed in the down direction*.)

escalator: the rate of travel of the steps, measured along the centerline of the steps in the direction of travel, with rated load on the steps. In the case of a reversible escalator, the rated speed shall be the rate of travel of the steps in the up direction, measured along the centerline of the steps on the incline, with rated load on the steps.

moving walk: the rate of travel of the treadway, horizontally or at an incline, with rated load on the treadway. In the case of reversible inclined moving walks, the rated speed is the rate of travel of the treadway in the up direction, measured along the centerline of the treadway surface in the direction of travel, with rated load on the treadway.

readily accessible: capable of being reached quickly for operation, renewal, or inspection, without requiring those to whom ready access is a requisite to climb over or remove obstacles or resort to portable ladders, chairs, etc.

recall level: the designated or alternate level that cars are returned to when Phase I Emergency Recall Operation is activated.

records, electronic: a viewable computer-generated record or log of all items specified in the maintenance records.

recycling operation, telescope plunger: an operation for restoring the relative vertical positions of the multiple plungers in a telescoping plunger arrangement.

regulatory authority: the person or organization responsible for the administration and enforcement of the applicable legislation or regulation governing the design, construction, installation, operation, inspection, testing, maintenance, or alteration of equipment covered by this Code. (See also *authority having jurisdiction*.)

rehabilitation: see *alteration; maintenance; repair; and replacement*.

releasing carrier, governor rope: a mechanical device to which the governor rope may be fastened, calibrated to control the activation of a safety at a predetermined tripping force.

remote machine and control rooms: rooms that do not share a common wall, floor, or ceiling with the hoistway.

repair: reconditioning or renewal of parts, components, and/or subsystems necessary to keep equipment in compliance with applicable Code requirements. (See also *replacement* and *maintenance*.)

replacement: the substitution of a device or component and/or subsystems, in its entirety, with a unit that is basically the same as the original for the purpose of ensuring performance in accordance with applicable Code requirements. (See also *repair* and *maintenance*.)

residual strength: the actual breaking strength of a suspension member at any time during its operational life cycle.

NOTE: The residual strength will be reduced as the suspension member is used and is subjected to wear.

restricted area: (applicable to Part 7) an area accessible only to authorized personnel who have been instructed in the use and operation of the equipment.

rise: the vertical distance between the bottom terminal landing and the top terminal landing of an elevator, dumbwaiter, or material lift.

rise, escalator and moving walk: the vertical distance between the top and bottom landings of the escalator or moving walk.

rope, aircraft cable: a wire rope built for a special purpose having special flexibility properties, zinc-coating, high breaking strength, and antirust qualities. Designed originally for use with aircraft controls.

rope, car counterweight: wire rope used to connect the car and counterweight that does not pass over the driving means.

rope, counterweight: wire rope used to raise and lower the counterweight on an electric elevator, dumbwaiter, or material lift having a winding drum machine.

rope, governor: wire rope with at least one end fastened to the safety activating means or governor rope releasing carrier, passing over and driving the governor sheave, and providing continuous information on the speed and direction of the car or counterweight.

rope, safety drum (also known as "Tail rope" and "Minne Line"): a corrosion-resistant wire rope used to connect the governor rope to the safety. Primarily used with wedge clamp safeties.

rope, suspension (hoisting): wire rope used to raise and lower an elevator, dumbwaiter, or material lift car or its counterweight, or both.

rope equalizer, suspension: a device installed on an elevator, dumbwaiter, or material lift car or counterweight to equalize automatically the tensions in the suspension wire ropes.

rope-fastening device, auxiliary: a device attached to the car or counterweight or to the overhead dead-end rope-hitch support that will function automatically to support the car or counterweight in case the regular wire rope fastening fails at the point of connection to the car or counterweight or at the overhead dead-end hitch.

rope sprocket drive: a driving means consisting of wire rope with fixed links at constant intervals throughout its length. The links engage in slots on a grooved drive cog to provide a positive drive force.

runby, bottom, elevator car: the distance between the car buffer striker plate and the striking surface of the car buffer when the car floor is level with the bottom terminal landing.

runby, bottom, elevator counterweight: the distance between the counterweight buffer striker plate and the striking surface of the counterweight buffer when the car floor is level with the top terminal landing.

runby, top, direct-plunger hydraulic elevator: the distance the elevator car can run above its top terminal landing before the plunger strikes its mechanical stop.

running gear, escalator: all the components of an escalator moving along the tracks.

running gear, moving walk: all the components of a moving walk moving along the tracks.

safety, car or counterweight: a mechanical device attached to the car, car frame, or to an auxiliary frame; or to the counterweight or counterweight frame; to stop and hold the car or counterweight under one or more of the following conditions: predetermined overspeed, free fall, or if the suspension ropes slacken.

safety, self-resetting: a car or counterweight safety released and reset by movement in the up direction.

safety bulkhead: a closure at the bottom of the cylinder located above the cylinder head and provided with an orifice for controlling the loss of fluid in the event of cylinder head failure.

safety integrity level (SIL): the discrete level (one out of a possible four) for specifying the safety integrity requirements of the safety functions to be allocated to the E/E/PE safety-related system, where safety integrity level 4 has the highest level of safety integrity and safety integrity level 1 has the lowest (see IEC 61508).

screw column: a vertical structural member provided with screw threads that support the car of a screw column elevator, dumbwaiter, or material lift. The screw column may be either in tension or compression.

seal, adjustment: a device or means to prevent adjustment of a component that must be broken to change the adjustment. Sealing includes a method to document the date and name of the person and/or firm applying the seal or other means to acquire this information.

seismic switch: a device activated by ground movement to provide a signal that a potentially damaging earthquake is imminent.

sequence operation: see *door, vertically sliding sequence operation*.

shaft: see *hoistway*.

shall: indicates a mandatory requirement.

should: indicates a recommendation, not a mandatory requirement.

sight guard: a vertical member mounted on the hoistway side of the leading edge of the hoistway door. It is used to reduce the opening between the leading edges of the hoistway door and the car door.

signal device, elevator car flash: one providing a signal light in the car, that is illuminated when the car approaches the landings at which a landing signal registering device has been actuated.

signal registering device, elevator landing: a button or other device located at the elevator landing, that, when actuated by a waiting passenger, causes a stop signal to be registered in the car.

signal system, elevator separate: one consisting of buttons or other devices located at the landings, that, when actuated by a waiting passenger, illuminates a flash signal or operates an annunciator in the car indicating floors at which stops are to be made.

signal transfer device, elevator automatic: a device by means of which a signal to be registered in a car is automatically transferred to the next car following, in case the first car passes a floor for which a signal has been registered without making a stop.

signal transfer switch, elevator: a manually operated switch, located in the car, by means of which the operator

can transfer a signal to the next car approaching in the same direction, when the operator desires to pass a floor at which a signal has been registered in the car.

SIL rated: electrical/electronic/programmable electronic system (E/E/PES) that is listed/certified to a safety integrity level that is in accordance with the applicable requirements of IEC 61508-2 and IEC 61508-3.

skirt, escalator: see *escalator skirt*.

skirt panel, dynamic: the moving vertical panels, with a positive mechanical connection to the running gear, adjacent to, and moving with the steps.

slack-rope switch: a device that automatically causes the electric power to be removed from the elevator driving-machine motor and brake when the suspension ropes of a winding drum machine become slack.

sleeving (liner): the insertion of a smaller diameter cylinder inside the existing cylinder of a hydraulic jack.

sling: see *car frame*.

slope, moving walk: the angle that the centerline of the treadway makes with the horizontal.

software system failure: a behavior of the software, including its support (host) hardware, that is not in accordance with the intended function.

solid-state device: an element that can control current flow without moving parts.

speed governor: a continuously operating speed monitoring and detection device that, at predetermined speeds, provides signals to the controller and imparts a retarding force to activate the car or counterweight safety.

speed governor, escalator and moving walk: a continuously operating speed monitoring and detection device that, at predetermined speeds, provides signals to the controller to stop the escalator or moving walk.

starters control panel, elevator: an assembly of devices by means of which the starter may control the manner in which an elevator or group of elevators function.

static switching: switching of circuits by means of solid-state devices.

step band: the complete assembly formed by all of the steps and their interconnecting means.

suspension member, noncircular elastomeric-coated steel (hoisting): a noncircular suspension member, such as an elastomeric-coated steel belt constructed of encapsulated steel cords, used to raise and lower an elevator, dumbwaiter, or material lift car or its counterweight or both.

sway control guide: a device attached to the car or the counterweight used to limit the sway of suspension means, compensating means, traveling cables, etc., to prevent tangling or snagging on other hoistway components.

sway control guide suspension means: tensile components that support, raise, and lower sway control guides for electric traction elevators.

tail line: the slack portion of the suspension member extending below the traction climbing driving machine.

tandem operation escalators: see *escalators, tandem operation*.

terminal landing: see *landing, elevator or material lift*.

terminal speed-limiting device, emergency: a device that automatically reduces the car and counterweight speed to within the rated buffer striking speed prior to buffer engagement.

terminal speed-reducing device, hydraulic: a device on hydraulic elevators that will reduce the speed prior to contacting the stop ring in the up direction.

terminal stopping device, emergency: a device that automatically causes the power to be removed from the driving-machine motor and brake if the car fails to slow down as intended when approaching the terminal landing.

terminal stopping device, final: a device that automatically causes the power to be removed from a driving-machine motor and brake, or from a hydraulic machine, after the car has passed a terminal landing.

terminal stopping device, machine final (stop-motion switch): final terminal stopping device operated directly by the driving machine.

terminal stopping device, normal: device(s) to slow down and stop an elevator, dumbwaiter, or material lift car automatically at or near a terminal landing.

threshold comb, moving walk: see *comb, escalator and moving walk*.

threshold plate, moving walk: see *combplate, escalator and moving walk*.

transom: a panel or panels used to close a hoistway enclosure opening above a hoistway entrance.

travel path: in a wind turbine tower elevator, the space defined by the projected footprint of the car, inclusive of any horizontal displacement of the car, from the bottom landing platform to the uppermost point of travel or the final limit.

traveling cable: a cable made up of electric conductors, that provides electrical connection between an elevator, dumbwaiter, material lift car, or counterweight, and a fixed outlet in the hoistway or machine room.

treadway, moving walk: the passenger-carrying member of a moving walk.

truck zone, elevator: the limited distance above an elevator landing within which the truck zoning device permits movement of the elevator car.

truck zoning device, elevator: a device that will permit the operator in the car to move a freight elevator within the truck zone with the car door or gate and a hoistway door open.

type test: a test carried out by or witnessed by a certifying organization concerned with product evaluation and the issuing of certificates to ensure conformance to Code requirements.

unintended car movement: any movement of an elevator car that is not intended car movement resulting from a component or system failure.

unlocking device, hoistway door: a mechanical device, the function of which is to unlock and permit the opening of a hoistway door from a landing irrespective of the position of the car.

unlocking zone: a zone extending from the landing floor level to a point not less than 75 mm (3 in.) nor more than 175 mm (7 in.), except not more than 450 mm (18 in.) for freight elevators with vertically sliding doors, above and below the landing.

upper landing, escalator: see *landing, upper, escalator*.

upper landing, moving walk: see *landing, upper, moving walk*.

valley break: a broken wire in a wire rope in which the outside wire of a strand breaks in the immediate vicinity of the point where it contacts a wire or wires of an adjacent strand, generally at a point not visible when the wire rope is examined externally. One end of the broken wire is long enough to reach from one valley to

the next one and the other end of the broken wire generally cannot be seen.

valve, overspeed: a device installed in the pressure piping of a hydraulic elevator, between the hydraulic machine and the hydraulic jack, that restricts and ceases oil flow from the hydraulic jack through the pressure piping when such flow exceeds a preset value.

volatile memory: memory lost when operating power is removed.

waiting-passenger indicator: an indicator that shows at which landings and for which direction elevator hall stop-or-signal calls have been registered and are unanswered.

weatherproof: so constructed or protected that exposure to the weather will not interfere with successful operation.

width, moving walk: the exposed width of the treadway.

window: an assembly consisting of a surrounding frame and one or more sashes, ventilators, or fixed lights, or a combination of these, designed to be installed in a wall opening for the purpose of admitting light or air, or both.

working pressure: the pressure measured at the hydraulic machine when lifting car and its rated load at rated speed, or with Class C2 loading when leveling up with maximum static load.

yield strength: the tensile stress that is sufficient to produce a permanent deformation of 0.2%.

Part 2

Electric Elevators

SCOPE

Part 2 applies to electric elevators installed at an angle greater than 70 deg from the horizontal. It applies to other equipment only as referenced in the applicable Part.

NOTE: See also Part 8 for additional requirements that apply to electric elevators.

SECTION 2.1 CONSTRUCTION OF HOISTWAYS AND HOISTWAY ENCLOSURES

2.1.1 Hoistway Enclosures

Hoistway enclosures shall conform to 2.1.1.1, 2.1.1.2, or 2.1.1.3.

2.1.1.1 Fire-Resistive Construction

2.1.1.1.1 Where fire-resistive construction is required, hoistways shall be enclosed in conformance with the requirements of the building code (see 1.3).

2.1.1.1.2 Partitions between hoistways and

- (a) machinery spaces outside the hoistway
- (b) machine rooms
- (c) control spaces outside the hoistway
- (d) control rooms

that have a fire-resistance rating, shall be of noncombustible solid or openwork construction that meets the requirements of 2.1.1.2.2(d)(1), (2), and (3). Partitions of solid construction shall be permitted to have openings essential for ropes, drums, sheaves, and other elevator equipment.

Openwork construction shall reject a ball 25 mm (1 in.) in diameter, except where there are openings essential for ropes, drums, sheaves, and other elevator equipment.

2.1.1.1.3 Hoistway enclosure openings shall be protected with entrances or access doors having a fire-protection rating conforming to the requirements of the building code.

2.1.1.2 Non-Fire-Resistive Construction

2.1.1.2.1 Where fire-resistive construction is not required by the building code, hoistway construction shall conform to 2.1.1.2.2 or 2.1.1.3.

2.1.1.2.2 The hoistway shall be fully enclosed conforming to 2.1.1.2.2(a), (b), (c), and (d); or 2.1.1.2.2(a), (b), and (e).

(a) Enclosures and doors shall be unperforated to a height of 2 000 mm (79 in.) above each floor or landing and above the treads of adjacent stairways. The enclosure shall be unperforated, adjacent to, and for 150 mm (6 in.) on either side of any moving equipment that is within 100 mm (4 in.) of the enclosure.

(b) Partitions between hoistways and

- (1) machinery spaces outside the hoistway
- (2) machine rooms
- (3) control spaces outside the hoistway
- (4) control rooms

shall be of solid or openwork construction that meets the requirements of 2.1.1.2.2(d)(1), (2), and (3). Partitions of solid construction shall be permitted to have openings essential for ropes, drums, sheaves, and other elevator equipment. Openwork construction shall reject a ball 25 mm (1 in.) in diameter, except where there are openings for ropes, drums, sheaves, and other elevator equipment.

(c) Openwork enclosures, where used above the 2 000 mm (79 in.) level, shall reject a ball 25 mm (1 in.) in diameter.

(d) Openwork enclosures shall be

- (1) at least 2.2 mm (0.087 in.) thick wire, if of steel wire grille
- (2) at least 2.2 mm (0.087 in.) thick, if of expanded metal
- (3) so supported and braced as to deflect not over 15 mm (0.6 in.) when subjected to a force of 450 N (100 lbf) applied horizontally at any point

(e) Enclosures shall be permitted to be glass, provided it is laminated glass conforming to ANSI Z97.1, 16 CFR Part 1201, or CAN/CGSB-12.1, whichever is applicable (see Part 9). Markings as specified in the applicable standard shall be on each separate piece of glass and shall remain visible after installation.

2.1.1.2.3 Entrances shall be in conformance with 2.11, except 2.11.14, 2.11.15, 2.11.16, and 2.11.18.

2.1.1.3 Partially Enclosed Hoistways. For elevators that are not fully enclosed, protection at least 2 400 mm (94.5 in.) high shall be provided on the hoistway sides that are located 1 500 mm (59 in.) or less from elevator equipment to areas accessible to other than elevator personnel. Such protection shall comply with 2.1.1.2.

2.1.1.4 Multiple Hoistways. The number of elevators permissible in a hoistway shall be in conformance with the building code.

2.1.1.5 Strength of Enclosure. The hoistway enclosure adjacent to a landing opening shall be of sufficient strength to maintain, in true lateral alignment, the hoistway entrances. Operating mechanisms and locking devices shall be supported by the building wall, if load-bearing, or by other building structure. Adequate consideration shall be given to pressure exerted on hoistway enclosures as a result of windage and elevator operation.

2.1.2 Construction at Top and Bottom of the Hoistway

2.1.2.1 Construction at Top of the Hoistway. The top of the hoistway shall be enclosed as required by the building code.

2.1.2.2 Construction at Bottom of Hoistway. Pits extending to the ground shall have noncombustible floors, and shall be designed to prevent entry of ground water into the pit. The pit floor of any hoistway not extending to the ground shall be of construction having a fire-resistance rating at least equal to that required for the hoistway enclosure. (See also 2.2 and 2.6.)

2.1.2.3 Strength of Pit Floor. The pit equipment, beams, floor, and their supports shall be designed and constructed to meet the applicable building code requirements and to withstand the following loads, without permanent deformation, in the manner in which they occur:

(a) the impact load due to car or counterweight buffer engagement at 125% of the rated speed or 125% of the striking speed where reduced stroke buffers are used (see 8.2.3)

(b) the part of the load transmitted due to the application of the car safety, or where applicable, the counterweight safety

(c) compensation up-pull load where compensation tie-down is applied (see 2.21.4.2)

(d) the loads imposed by a driving machine where applicable (see 2.9)

(e) any other elevator-related loads that are transmitted to the pit floor

2.1.3 Floor Over Hoistways

2.1.3.1 General Requirements

2.1.3.1.1 A metal or concrete floor shall be provided at the top of the hoistway

(a) where a machine room or control room is located above the hoistway

(b) below overhead sheaves and other equipment that are located over the hoistway and means of access conforming to 2.7.6.3.3 are not provided

(c) below governors that are located over the hoistway and means of access conforming to 2.7.6.3.4 are not provided

2.1.3.1.2 Floors are not required below secondary and deflecting sheaves of traction-type machines located over the hoistway.

2.1.3.2 Strength of Floor. Overhead floors shall be capable of sustaining a concentrated load of 1 000 N (225 lbf) on any 2 000 mm² (3 in.²) area, and in addition, where it constitutes the floor of the main or secondary level machinery space, it shall be designed for a live load of not less than 6 kPa (125 lbf/ft²) in all open areas.

Where the elevator driving machine is to be supported solely by the machine room floor slab, the floor slab shall be designed in accordance with 2.9.4 and 2.9.5.

2.1.3.3 Construction of Floors. Floors shall be of concrete or metal construction with or without perforations. Metal floors shall conform to the following:

(a) If of bar-type grating, the openings between bars shall reject a ball 20 mm (0.8 in.) in diameter.

(b) If of perforated sheet metal or of fabricated open-work construction, the openings shall reject a ball 25 mm (1 in.) in diameter.

2.1.3.4 Area to Be Covered by Floor. Where a floor over a hoistway is required by 2.1.3.1, the floor shall extend over the entire area of the hoistway where the cross-sectional area is 10 m² (108 ft²) or less. Where the cross-sectional area is greater, the floor shall extend not less than 600 mm (24 in.) beyond the general contour of the machine or sheaves or other equipment, and to the entrance to the machinery space at or above the level of that floor. Where the floor does not cover the entire horizontal area of the hoistway, the open or exposed sides shall be provided with a standard railing conforming to 2.10.2.

2.1.4 Control of Smoke and Hot Gases

When required by the building code, hoistways shall be provided with means to prevent the accumulation of smoke and hot gases.

Where hoistway pressurization is provided, it shall be designed, installed, and maintained so as not to impede elevator operation.

NOTE (2.1.4): Excessive pressurization could prevent doors, complying with 2.13.4, from closing. Air introduced into the hoistway could cause erratic operation by impingement of traveling cables, selector tapes, governor ropes, compensating ropes, and other components sensitive to excessive movement or deflection.

2.1.5 Windows and Skylights

In jurisdictions not enforcing the NBCC, windows in the walls of hoistway enclosures are prohibited.

Windows and skylights and their frames and sashes in machine rooms and control rooms shall conform to the requirements of the building code (see 1.3).

2.1.6 Projections, Recesses, and Setbacks in Hoistway Enclosures

Hoistway enclosures shall have flush surfaces on the hoistway side, subject to the requirements of 2.1.6.1 and 2.1.6.2.

2.1.6.1 On sides for loading and unloading, landing sills, hoistway doors, door tracks, and hangers shall be permitted to project inside the hoistway enclosure. Sills shall be guarded as required by 2.11.10.1.

2.1.6.2 On sides not used for loading and unloading

(a) beams, floor slabs, or other building construction making an angle less than 75 deg with the horizontal shall not project more than 100 mm (4 in.) inside the hoistway enclosure unless the top surface of the projection is beveled at an angle not less than 75 deg with the horizontal

(b) separator beams between adjacent elevators are not required to have bevels

(c) where recesses or setbacks exceeding 100 mm (4 in.) occur in the enclosure wall, the top of the recess or setback shall be beveled at an angle of not less than 75 deg with the horizontal

(d) bevels are not required if the projections, recesses, and setbacks are covered with material conforming to the following:

(1) it shall be equal to or stronger than 1.110 mm (0.0437 in.) wire

(2) it shall have openings not exceeding 25 mm (1 in.)

(3) it shall be supported and braced such that it will not deflect more than 25 mm (1 in.) when subjected to a force of 4.79 kPa (100 lbf/ft²) applied horizontally at any point

pit floor shall be permitted to remain in place, provided that the maximum encroachment of such footings does not exceed 15% of the cubic content of the pit, and further provided that it is impracticable to remove the footing

2.2.2.3 Permanent provisions shall be made to prevent accumulation of ground water in the pit (see 2.1.2.2).

2.2.2.4 Drains and sump pumps, where provided, shall comply with the applicable plumbing code, and they shall be provided with a positive means to prevent water, gases, and odors from entering the hoistway.

2.2.2.5 In elevators provided with Firefighters' Emergency Operation, a drain or sump pump shall be provided. The sump pump/drain shall have the capacity to remove a minimum of 11.4 m³/h (3,000 gal/h) per elevator.

2.2.2.6 Sumps and sump pumps in pits, where provided, shall be covered. The cover shall be secured and level with the pit floor.

2.2.3 Guards Between Adjacent Pits

2.2.3.1 Where there is a difference in level between the floors of adjacent pits, a metal guard, unperforated, or perforated with openings that will reject a ball 50 mm (2 in.) in diameter, shall be installed for separating such pits. Guards shall extend not less than 2 000 mm (79 in.) above the level of the higher pit floor and a self-closing access door shall be permitted.

2.2.3.2 Where the difference in level is 600 mm (24 in.) or less, a standard railing conforming to 2.10.2 shall be permitted to be installed in lieu of the guard.

2.2.4 Pit Access

Safe and convenient access shall be provided to all pits, and shall conform to 2.2.4.1 through 2.2.4.6.

2.2.4.1 Access shall be by means of the lowest hoistway door or by means of a separate pit access door.

2.2.4.2 There shall be installed in the pit of each elevator, where the pit extends more than 900 mm (35 in.) below the sill of the pit access door (lowest hoistway door or separate pit access door), a fixed vertical ladder of noncombustible material, located within reach of the access door. The ladder is permitted to be retractable or nonretractable. Nonretractable ladders, where provided, shall conform to 2.2.4.2.1 through 2.2.4.2.6. Retractable ladders, where provided, shall conform to 2.2.4.2.1 through 2.2.4.2.3 and 2.2.4.2.5 through 2.2.4.2.8. When in the extended position, retractable ladders shall conform to 2.2.4.2.4.

2.2.4.2.1 The ladder shall extend not less than 1 200 mm (48 in.) above the sill of the access door or handgrips shall be provided to the same height.

SECTION 2.2 PITS

2.2.1 General

A pit shall be provided for every elevator.

2.2.2 Design and Construction of Pits

2.2.2.1 The construction of the pit walls, the pit floor, and any pit access doors (see 2.2.4) shall conform to 2.1.1 and 2.1.2.

2.2.2.2 The floor of the pit shall be approximately level, except that

(a) trenches or depressions shall be permitted for the installation of buffers, compensating sheaves and frames, and vertically sliding biparting hoistway doors, where structural conditions make such trenches or depressions necessary

(b) in existing buildings, where new elevators are installed or existing elevators are altered, existing foundation footings extending above the general level of the

2.2.4.2.2 The ladder rungs, cleats, or steps shall be a minimum of 400 mm (16 in.) wide. When obstructions are encountered, the width shall be permitted to be decreased to less than 400 mm (16 in.). The reduced width shall be as wide as the available space permits, but not less than 225 mm (9 in.).

2.2.4.2.3 The ladder rungs, cleats, or steps shall be spaced 300 mm (12 in.) \pm 13 mm (\pm 0.5 in.) on center, shall be provided to not less than the height of access door sill, and shall be designed to minimize slipping (e.g., knurling, dimpling, coating with skid-resistant material, etc.).

2.2.4.2.4 A clear distance of not less than 115 mm (4.5 in.) from the centerline of the rungs, cleats, or steps to the nearest permanent object in back of the ladder shall be provided.

2.2.4.2.5 Side rails, if provided, shall have a clear distance of not less than 115 mm (4.5 in.) from their centerline to the nearest permanent object.

2.2.4.2.6 The ladder and its attachments shall be capable of sustaining a load of 135 kg (300 lb).

2.2.4.2.7 Retractable ladders that are in the line of movement of the car or counterweight when not fully retracted, shall operate a retractable ladder electrical device (see 2.26.2.38) that shall cause the power to be removed from the elevator driving-machine motor and brake unless the ladder is in its fully retracted position.

2.2.4.2.8 Retractable ladders shall be capable of being extended, mechanically secured and unsecured, and retracted from the access door, and

(a) the force(s) required to extend a retractable ladder from the fully retracted position to the extended and mechanically secured position shall not exceed 220 N (50 lbf)

(b) after being extended and mechanically secured, a retractable ladder shall remain secured in the extended position when subjected to a horizontal force not to exceed 2 220 N (500 lbf)

(c) the force(s) required to retract a retractable ladder from its extended position to its fully retracted position, after being unsecured, shall not exceed 220 N (50 lbf)

(d) the ladder shall be mechanically secured when in the retracted position

2.2.4.3 Pit access by a ladder shall not be permitted when the pit floor is more than 3 000 mm (120 in.) below the sill of the access door, except where there is no building floor below the bottom terminal landing, this height shall be permitted to be greater but not more than 4 200 mm (165 in.).

2.2.4.4 Pits shall be accessible only to elevator personnel.

2.2.4.5 Separate pit access door, when provided, shall be subject to the following requirements:

(a) If the door swings into the pit, it shall be located so that it does not interfere with moving equipment.

(b) If the door swings out, and the lowest structural or mechanical part, equipment, or device installed beneath the car platform, except guide shoes or rollers or safety jaw assemblies, projects below the top of the separate pit access door opening when the car is level with the bottom terminal landing

(1) an electric contact conforming to 2.26.2.26 shall be provided to prevent operation of the elevator when the door is open

(2) the door shall be provided with a vision panel(s) that is glazed with clear wired glass not less than 6 mm (0.25 in.) thick, will reject a ball 150 mm (6 in.) in diameter, and have an area of not more than 0.03 m² (47 in.²)

(c) The door shall provide a minimum opening of 750 mm (29.5 in.) in width and 1 825 mm (72 in.) in height.

(d) The door shall be equipped with a barrier conforming to 2.11.1.2(i), where the door sill is located more than 300 mm (12 in.) above the pit floor.

(e) The door shall be self-closing and provided with a spring-type lock arranged to permit the door to be opened from inside of the pit without a key. Such doors shall be kept closed and locked. A key shall be required to unlock the lock from outside the hoistway. The key shall be of Group 1 Security (see 8.1).

2.2.4.6 Means to unlock the access door from inside the pit shall be provided. The means shall be located

(a) when no pit ladder is provided, not more than 1 825 mm (72 in.) vertically above the pit floor, or

(b) when a pit ladder is provided, not more than 1 825 mm (72 in.) vertically above a rung, cleat, or step. The minimum distance from the top rung, cleat, or step to the top of the pit ladder or handhold shall not be less than 1 200 mm (48 in.) (see 2.2.4.2.1 and Nonmandatory Appendix J, Fig. J-1), and

(c) with the door in the closed position, in a plane not more than 1 000 mm (39 in.) horizontally from a rung, cleat, or step of the pit ladder (see Nonmandatory Appendix J, Fig. J-1).

2.2.5 Illumination of Pits

A permanent lighting fixture shall be provided and shall conform to 2.2.5.1 through 2.2.5.3.

2.2.5.1 The lighting shall provide an illumination of not less than 100 lx (10 fc) at the pit floor and at a pit platform, when provided.

2.2.5.2 The light bulb(s) shall be externally guarded to prevent contact and accidental breakage.

2.2.5.3 The light switch shall be so located as to be accessible from the pit access door.

2.2.6 Stop Switch in Pits

An enclosed stop switch(es), meeting the requirements of 2.26.2.7 and 2.2.6.1 through 2.2.6.3, shall be installed in the pit of each elevator.

2.2.6.1 The stop switch shall be so located as to be accessible from the pit access door. Where access to the pits of elevators in a multiple hoistway is by means of a single access door, the stop switch for each elevator shall be located adjacent to the nearest point of access to its pit from the access door.

- (13) **2.2.6.2** In elevators where access to the pit is through the lowest landing hoistway door, a stop switch shall be located approximately 450 mm (18 in.) above the floor level of the landing, within reach from this access floor and adjacent to the pit ladder, if provided. When the pit exceeds 1 700 mm (67 in.) in depth, an additional stop switch is required adjacent to the pit ladder and approximately 1 200 mm (47 in.) above the pit floor. Where more than one switch is provided, they shall be wired in series.

2.2.7 Minimum Pit Depths Required

The pit depth shall be not less than is required for the installation of the buffers, compensating sheaves, if any, and all other elevator equipment located therein and to provide the minimum bottom car clearance and runby required by 2.4.1.

2.2.8 Access to Underside of Car

Where the distance from the pit floor to the underside of the plank channels or slings exceeds 2 100 mm (83 in.), with the car at the lowest landing, a means shall be permanently installed or permanently stored in the pit to provide access to the equipment on the underside of the car. When access is provided by means of a working platform it shall conform to the requirements of 2.7.5.3.2 through 2.7.5.3.6.

SECTION 2.3 LOCATION AND GUARDING OF COUNTERWEIGHTS

2.3.1 Location of Counterweights

Counterweights shall be located in the hoistway of the elevator that they serve, or in a remote hoistway subject to the limitations and requirements of 2.3.3.

2.3.2 Counterweight Guards

- (13) **2.3.2.1** Metal guards shall be installed in the pit and/or a machine room or control room located underneath the hoistway on all open sides of the counterweight runway, except that
- (a) the guard, or portion thereof, is not required on the side facing the car where there is no space greater than 500 mm (20 in.) between any adjacent combination

of compensation means, suspension means, counterweight rails, and guard(s) that blocks the access to the counterweight runway

(b) where pit-mounted buffers are used, the guard is not required where the bottom of the counterweight resting on its compressed buffer is 2 130 mm (84 in.) or more above the pit floor, or above the machine or control room floor if located underneath the hoistway

2.3.2.2 Guards shall

(a) extend from the lowest part of the counterweight assembly when the counterweight is resting on the fully compressed buffer to a point not less than 2 100 mm (83 in.) and not more than 2 450 mm (96 in.) above the pit floor

(b) be the full width of the area being guarded

(c) not prevent determination of the counterweight runby

(d) be fastened to a metal frame reinforced and braced to be at least equal in strength and stiffness to 2 mm (0.074 in.) thick sheet steel

(e) if perforated, reject a ball 25 mm (1 in.) in diameter

2.3.2.3 Guarding of Counterweights in a Multiple-Elevator Hoistway.

Where a counterweight is located between elevators, the counterweight runway shall be guarded on the side next to the adjacent elevator. The guard shall be of noncombustible material. The guard, if of openwork material, shall reject a ball 25 mm (1 in.) in diameter and be made from material equal to or stronger than 1.110 mm (0.0437 in.) diameter wire. The guard shall be so supported that when subjected to a force of 450 N (100 lbf) applied over an area of 100 mm × 100 mm (4 in. × 4 in.) at any location, the deflection shall not reduce the clearance between the guard and the counterweight below 25 mm (1 in.).

2.3.3 Remote Counterweight Hoistways

Where elevators are not provided with either compensating means or counterweight safeties, the counterweights shall be permitted to be located in a remote hoistway conforming to 2.3.3.1 through 2.3.3.6.

2.3.3.1 The hoistway shall be fully enclosed and shall have a fire-resistance rating, conforming to 2.1.1.1 if it penetrates a fire barrier.

2.3.3.2 Construction at the top and bottom of the hoistway shall conform to 2.1.2.

2.3.3.3 Permanent means shall be provided for inspection, repair, and maintenance of the counterweight, deflecting and secondary sheaves, hoistway, ropes, counterweight guide rails, and counterweight buffers or bumpers. Entry doors into the separate counterweight hoistway shall be provided at top, bottom, and center of counterweight hoistway, but in no case shall the entry doors be more than 11 m (36 ft) from sill to

sill. Doors shall be located and of such width to provide unobstructed access to the space between the counterweight guides. The height of the door shall be at least 1 975 mm (78 in.). Doors shall conform to 2.11.1.2(b) through (e), inclusive. An enclosed stop switch, meeting the requirements of 2.26.2.5(a), (b), and (c), a permanent electric light switch, duplex receptacle, and light shall be provided in the hoistway immediately inside the entry door.

2.3.3.4 Ropes and sheaves leading to the separate counterweight hoistways shall be protected against unauthorized access.

2.3.3.5 Not more than four counterweights shall be located in a single separate counterweight hoistway. Multiple counterweights located in a single hoistway shall be separated by means of an unperforated metal guard at the top, bottom, and center of the hoistway. Guards shall extend a minimum of 2 450 mm (96 in.) in length opposite the entry door. Doors and all other means described in 2.3.3.3 shall be provided for each counterweight.

2.3.3.6 There shall be a clearance of not less than 600 mm (24 in.) between the weight in the counterweight frame and the wall containing the entry door.

2.3.4 Counterweight Runway Enclosures

Where a counterweight is located in the same hoistway as the car, the runway for the counterweight shall be permitted to be separated from the runway for the car, provided it conforms to 2.3.4.1 and 2.3.4.2.

2.3.4.1 The partition shall be noncombustible. Unperforated metal partitions shall be equal to or stronger than 1.2 mm (0.047 in.) thick sheet steel. Open-work partitions shall be either wire grille at least 2.2 mm (0.087 in.) in diameter or expanded metal at least 2.2 mm (0.087 in.) in thickness.

2.3.4.2 The counterweight runway shall be permitted to be fully enclosed for the full height, provided that the partitions are removable in sections weighing not more than 25 kg (55 lb), that permit inspection and maintenance of the entire counterweight assembly and the inspection of the counterweight guide rails and guide-rail brackets.

SECTION 2.4 VERTICAL CLEARANCES AND RUNBYS FOR CARS AND COUNTERWEIGHTS

2.4.1 Bottom Car Clearances

2.4.1.1 When the car rests on its fully compressed buffers or bumpers, there shall be a vertical clearance of not less than 600 mm (24 in.) between the pit floor and the lowest structural or mechanical part, equipment,

or device installed beneath the car platform, except as specified in 2.4.1.2.

2.4.1.2 The 600 mm (24 in.) clearance does not apply to

(a) any equipment on the car within 300 mm (12 in.) horizontally from any side of the car platform

(b) any equipment located on or traveling with the car located within 300 mm (12 in.) horizontally from either side of the car frame centerline parallel to the plane of the guide rails

(c) any equipment mounted in or on the pit floor located within 300 mm (12 in.) horizontally from either side of the car frame centerline parallel to the guide rail

2.4.1.3 In no case shall the available refuge space be less than either of the following:

(a) a horizontal area of 600 mm × 1 200 mm (24 in. × 48 in.) with a height of 600 mm (24 in.)

(b) a horizontal area of 450 mm × 900 mm (18 in. × 35 in.) with a height of 1 070 mm (42 in.)

2.4.1.4 Trenches and depressions or foundation encroachments permitted by 2.2.2.2 shall not be considered in determining these clearances.

2.4.1.5 When the car is resting on its fully compressed buffers or bumpers, no part of the car, or any equipment attached thereto or equipment traveling with the car, shall strike any part of the pit or any equipment mounted therein.

2.4.1.6 In any area in the pit, outside the refuge space, where the vertical clearance is less than 600 mm (24 in.), that area shall be clearly marked on the pit floor. Markings shall not be required in the area under the platform guard and guiding means if that is the only area in the pit where the vertical clearance is less than 600 mm (24 in.). The marking shall consist of alternating 100 mm (4 in.) diagonal red and white stripes. In addition, a sign with the words "DANGER LOW CLEARANCE" shall be prominently posted on the hoistway enclosure and be visible from within the pit and the entrance to the pit. The sign shall

(a) conform to the requirements of ANSI Z535.4 or CAN/CSA-Z321 (see Part 9)

(b) be made of durable material and shall be securely fastened

2.4.2 Minimum Bottom Runby for Counterweighted Elevators

The bottom runby of cars and counterweights shall be not less than the requirements stated in 2.4.2.1 and 2.4.2.2.

2.4.2.1 Where oil buffers are used, the bottom runby shall be not less than 150 mm (6 in.), except that

(a) where practical difficulties prevent a sufficient pit depth or where a top clearance cannot be provided to

Table 2.4.2.2 Minimum Bottom Runby for Counterweight Elevators With Spring Buffers or Solid Bumpers and Rheostatic Control or Single-Speed AC Control

| Rated Speed, m/s (ft/min) | Runby, mm (in.) |
|------------------------------------|--------------------|
| Not over 0.13 (not over 25) | 75 (3) |
| Over 0.13 to 0.25 (over 25 to 50) | 150 (6) |
| Over 0.25 to 0.50 (over 50 to 100) | 225 (9) |
| Over 0.50 to 1.0 (over 100 to 200) | 300 (12) |

obtain the runby specified, it shall be permitted to be reduced

(b) where spring-return-type oil buffers are used, the runby shall be permitted to be eliminated so that the buffers are compressed by amounts not exceeding those permitted by 2.22.4.8, when the car floor is level with the terminal landings

2.4.2.2 Where spring buffers or solid bumpers are used, the bottom runby shall be not less than 150 mm (6 in.), except for rheostatic and single-speed AC control, not less than shown in Table 2.4.2.2.

2.4.3 Minimum Bottom Runby for Uncounterweighted Elevators

The bottom runby of uncounterweighted elevators shall be not less than

(a) 75 mm (3 in.) where the rated speed does not exceed 0.15 m/s (30 ft/min)

(b) 150 mm (6 in.) where the rated speed exceeds 0.15 m/s (30 ft/min)

2.4.4 Maximum Bottom Runby

In no case shall the maximum bottom runby exceed

(a) 600 mm (24 in.) for cars

(b) 900 mm (35 in.) for counterweights

2.4.5 Counterweight Runby Data Plate

A data plate permanently and securely attached shall be provided in the pit, in the vicinity of the counterweight buffer, indicating the maximum designed counterweight runby. The data plate shall conform to 2.16.3.3, except that the letters shall be not less than 25 mm (1 in.) in height.

2.4.6 Maximum Upward Movement of the Car

2.4.6.1 Counterweighted Elevators. The maximum upward movement of a counterweighted elevator above the top landing shall be no more than the sum of either of the following:

(a) for elevators without tie-down compensation, dimensions specified in 2.4.6.1.1(a) through (c)

(b) for elevators with tie-down compensation, dimensions specified in 2.4.6.1.1(a), (b), and (d)

2.4.6.1.1 The following shall be used when calculating the maximum upward movement of a counterweighted elevator:

(a) the designed maximum bottom counterweight runby [see 2.4.4(b)]

(b) the stroke of the counterweight buffer, determined as follows:

(1) for full-stroke buffers, the stroke of the buffer used, or the remaining stroke when the buffer is compressed with the car at the top terminal landing (see 2.4.2 and 2.22.4.8); or

(2) for reduced-stroke oil buffers (see 2.22.4.1.2), the stroke of the buffer used.

(c) one-half of the gravity stopping distance, based on

(1) 115% of the rated speed where oil buffers are used, or 115% of the reduced striking speed when emergency terminal speed-limiting devices meeting the requirements of 2.25.4 are used and no compensating rope tie-down device in conformance with 2.21.4.2 is provided (see 8.2.4 for gravity stopping distances); or

(2) the governor tripping speed where spring buffers are used.

(d) the distance to which the compensating rope tie-down device, if provided (see 2.21.4.2), limits the jump of the car when the counterweight strikes the buffers at speeds specified in 2.4.6.1.1(c) plus the distance to account for the amount of compensation rope stretch.

2.4.6.2 Uncounterweighted Elevators. The maximum upward movement of an uncounterweighted elevator above the top landing shall be no more than the distance from the top landing to the point

(a) where the driving machine operates the final terminal stopping switch (2.25.3.3.2) for a winding drum machine; or

(b) where the car operates the upper final terminal stopping device (2.25.3.3.1) plus gravity stopping distance based on 115% of the rated speed for a traction machine.

2.4.7 Top of Car Clearances

2.4.7.1 When the car has reached its maximum upward movement, the clearance above the car top, measured vertically up to the horizontal plane described by the lowest part of the overhead structure or other obstruction and measured within the projection of the car enclosure top exclusive of the area outside the standard railing (2.10.2) where provided, shall be not less than 1 100 mm (43 in.). In no case shall the following additional clearances be less than:

(a) 600 mm (24 in.) above the car crosshead assembly except as permitted in 2.4.7.1(b) when the crosshead is located over the car enclosure top or the distance

which any sheave assembly mounted in or on the crosshead projects above the top of the car crosshead, whichever is greater, but in no case shall there be less than 150 mm (6 in.) clearance above the sheave assembly.

(b) 300 mm (12 in.) above the car crosshead assembly where the crosshead is adjacent to the car enclosure top. The crosshead shall not overlap the car enclosure top by more than 100 mm (4 in.) horizontally.

(c) 600 mm (24 in.) above equipment attached to and projecting above the car enclosure top, exclusive of

(1) standard railings (see also 2.14.1.7.2)

(2) areas outside of the standard railing, the vertical clearance shall be not less than 100 mm (4 in.)

(3) roller and sliding guide assemblies (see also 2.4.9)

(4) gatepost(s) for vertically sliding gates (see also 2.4.9). Spreader bars between gateposts with horizontal and vertical clearances not in compliance with 2.14.1.7.2 shall have yellow and black diagonal stripes of not less than 25 mm (1 in.) wide along the length of the spreader bar, mounted at a location visible from the car top

- (13) **2.4.7.2** Any horizontal area above the car enclosure top and within the railing if supplied which could contain a circle with a diameter of equal to or greater than 350 mm (14 in.) that does not have a vertical clearance of 1 100 mm (43 in.) when the car has reached its maximum upward movement shall be clearly marked. The marking shall consist of alternating 50 mm (2 in.) diagonal red and white stripes. In addition, when markings are provided, sign(s) with the words "DANGER LOW CLEARANCE" shall be prominently posted on the crosshead and be visible from the hoistway entrance(s). The sign(s) shall

(a) conform to the requirements of ANSI Z535.4 or CAN/CSA-Z321 (see Part 9)

(b) be made of durable material and shall be securely fastened

NOTE (2.4.7): See Nonmandatory Appendix G.

2.4.8 Top of Counterweight Clearances

The top of counterweight clearance shall be not less than the sum of the following items:

(a) the bottom car runby (see 2.4.2)

(b) the stroke of the car buffer used, or the remaining stroke when the buffer is compressed with the car at the bottom terminal landing (see 2.4.2 and 2.22.4.8)

(c) 150 mm (6 in.)

(d) one-half of the gravity stopping distance based on

(1) 115% of the rated speed where oil buffers are used, or 115% of the reduced striking speed when emergency terminal speed-limiting devices meeting the requirements of 2.25.4 are used and no provision is made to prevent the jump of the car at counterweight buffer engagement; or

(2) the governor tripping speed where spring buffers are used (see 8.2.5 for gravity stopping distances)

(e) the distance to which the compensating rope tie-down device, if provided (see 2.21.4.2), limits the jump of the counterweight when the car strikes the buffers at speeds specified in 2.4.8(d) plus the distance to account for the amount of compensation rope stretch

2.4.9 Equipment on Top of Car Not Permitted to Strike Overhead Structure

When the car has reached its maximum upward movement (2.4.6), roller and sliding guide assemblies and gateposts for vertically sliding gates shall not strike any part of the overhead structure or the equipment located in the hoistway.

SECTION 2.5 HORIZONTAL CAR AND COUNTERWEIGHT CLEARANCES

2.5.1 Clearances Between Cars, Counterweights, and Hoistway Enclosures

2.5.1.1 Between Car and Hoistway Enclosures. The clearance between the car and the hoistway enclosure shall be not less than 20 mm (0.8 in.), except on the sides used for loading and unloading.

2.5.1.2 Between Car and Counterweight and Counterweight Guard. The clearance between the car and the counterweight shall be not less than 25 mm (1 in.). The clearance between the car and the counterweight guard, counterweight and the counterweight guard, and between the counterweight and the hoistway enclosure shall be not less than 20 mm (0.8 in.).

2.5.1.3 Between Cars in Multiple Hoistways. The running clearance between the cars and any equipment attached thereto, of elevators operating in a multiple hoistway, shall be not less than 50 mm (2 in.).

2.5.1.4 Between Car and Landing Sills. The clearance between the car platform sill and the hoistway edge of any landing sill, or the hoistway side of any vertically sliding counterweighted or counterbalanced hoistway door, or of any vertically sliding counterbalanced biparting hoistway door, shall be not less than

(a) where car side guides are used

(1) 13 mm (0.5 in.) for all elevators except freight elevators

(2) 20 mm (0.8 in.) for freight elevators

(b) where car corner guides are used, 20 mm (0.8 in.)

The maximum clearance shall be not more than 32 mm (1.25 in.).

2.5.1.5 Clearance Between Loading Side of Car Platforms and Hoistway Enclosures

2.5.1.5.1 The clearance between the edge of the car platform sill and the hoistway enclosure or fascia plate for the full width of the clear hoistway door opening shall be not more than

- (a) 190 mm (7.5 in.) for vertically sliding doors
- (b) 125 mm (5 in.) for other doors

2.5.1.5.2 This clearance shall be maintained until the car is resting on its fully compressed buffer.

2.5.1.5.3 The clearance is not limited on passenger elevators, provided that

(a) a car door interlock conforming to 2.14.4.2 is provided to prevent a door from being opened unless the car is within the unlocking zone

(b) the strength of the door complies with 2.11.11.2, 2.11.11.4, 2.11.11.6, 2.11.11.7, and 2.11.11.8

2.5.1.6 Clearance Between Car Platform Apron and Pit Enclosure. Where the lowest landing sill projects into the hoistway, the clearance between the car platform apron and the pit enclosure or fascia plate shall be not more than 32 mm (1.25 in.). This clearance shall be maintained until the car is resting on its fully compressed buffer.

2.5.1.7 Measurement of Clearances. The clearances specified in 2.5.1 shall be measured with no load on the car platform.

SECTION 2.6 PROTECTION OF SPACE BELOW HOISTWAYS

Where a hoistway does not extend to the lowest floor of the building and there is space below the hoistway that is accessible, requirements of 2.6.1 and 2.6.2 shall be complied with.

2.6.1 Where the Space Is Underneath the Counterweight and/or Its Guides

Where the space is underneath the counterweight and/or its guides

(a) the counterweight shall be provided with a counterweight safety conforming to 2.17.4

(b) spring buffers, if used, shall conform to 2.22, except that they shall not be fully compressed when struck by the counterweight at the following speeds (see 2.1.2.3):

- (1) at governor tripping speed where the counterweight safety is governor operated, or
- (2) 125% of the rated speed where the counterweight safety is not governor operated

2.6.2 Where the Space Is Underneath the Car and/or Its Guides

Where the space is underneath the car and/or its guides and if spring buffers are used, they shall be so designed and installed that they will not be fully compressed solid or to a fixed stop when struck by the car with its rated load at the governor tripping speed (see 2.1.2.3).

SECTION 2.7 MACHINERY SPACES, MACHINE ROOMS, CONTROL SPACES, AND CONTROL ROOMS

A machinery space outside the hoistway containing an electric driving machine and a motor controller shall be a machine room.

2.7.1 Enclosure of Rooms and Spaces

Machinery space and control space enclosures located outside the hoistway and machine room and control room enclosures shall conform to the requirements of 2.7.1.1 or 2.7.1.2, and shall also conform to 2.7.1.3, as applicable.

2.7.1.1 Fire-Resistive Construction. Where the building code requires fire-resistive construction, the construction shall conform to the requirements of 2.7.1.1.1 and 2.7.1.1.2.

2.7.1.1.1 Spaces containing machines, motor controllers, sheaves, and other machinery shall be separated from the remainder of the building by a fire-resistive enclosure conforming to the requirements of the building code.

2.7.1.1.2 Openings in room and space enclosures shall be protected with access doors having a fire-protection rating conforming to the requirements of the building code.

NOTES (2.7.1.1):

- (1) See 2.1.3 for floors of machine rooms and control rooms over the hoistway.
- (2) See 2.8.1 for separating elevator machinery from building machinery.
- (3) See 2.1.1.1.2 for partitions between machine rooms and hoistways.

2.7.1.2 Non-Fire-Resistive Construction. Where the building code does not require fire-resistive construction, the construction shall conform to the requirements of 2.7.1.2.1 and 2.7.1.2.2.

2.7.1.2.1 Enclosure of the rooms or spaces shall comply with the following:

(a) Machine rooms and control rooms shall be enclosed with noncombustible material to a height of not less than 2 000 mm (79 in.).

(b) Machinery spaces shall be enclosed with noncombustible material to a height of not less than 2 000 mm (79 in.), or to the height of the machinery space if it is less than 2 000 mm (79 in.).

(c) Control spaces shall be enclosed with noncombustible material to a height of not less than 2 000 mm (79 in.).

2.7.1.2.2 The room and space enclosure, if of openwork material, shall reject a ball 50 mm (2 in.) in diameter.

2.7.1.3 Floors

2.7.1.3.1 Difference in Floor Levels. Where there is a difference in level exceeding 400 mm (16 in.), a standard railing conforming to 2.10.2 shall be provided (see also 2.7.3.3.1 and 2.7.3.3.2).

NOTE: Differences in levels of floors should be avoided where practicable.

2.7.1.3.2 Where machine beams are provided, the floor shall be located above or level with the top of the machine beams.

2.7.2 Maintenance Path and Clearance

2.7.2.1 Maintenance Path in Machine Rooms and Control Rooms. A clear path of not less than 450 mm (18 in.) shall be provided to all components that require maintenance.

2.7.2.2 Maintenance Path in Machinery Spaces and Control Spaces. All components requiring maintenance in machinery spaces and control spaces shall have safe and convenient access.

2.7.2.3 Maintenance Clearance in Machine Rooms and Control Rooms. A clearance of not less than 450 mm (18 in.) shall be provided in the direction required for maintenance access.

2.7.2.4 Maintenance Clearance in Machinery Spaces and Control Spaces

2.7.2.4.1 Where a space is intended to be accessed with full bodily entry, then the requirements of 2.7.2.3 shall apply.

2.7.2.4.2 Where a space is not intended to be accessed with full bodily entry, then all components requiring maintenance shall have safe and convenient access.

NOTE (2.7.2): For electrical clearance requirements, see NFPA 70 or CSA-C22.1, whichever is applicable (see Part 9).

2.7.3 Access to Machinery Spaces, Machine Rooms, Control Spaces, and Control Rooms

2.7.3.1 General Requirements

2.7.3.1.1 A permanent and unobstructed means of access shall be provided to

- (a) machine rooms and control rooms
- (b) machinery spaces and control spaces outside the hoistway
- (c) machinery spaces and control spaces inside the hoistway that do not have a means of access to the space as specified in 2.7.3.1.2.

2.7.3.1.2 Access to machinery spaces and control spaces inside the hoistway

- (a) from the pit shall comply with 2.2.4 and 2.7.5.2.4
- (b) from the car top shall comply with 2.12.6 and 2.12.7

(c) from a platform shall comply with 2.7.5.3.5

(d) from inside the car shall comply with 2.7.5.1.4

2.7.3.1.3 Access to other locations within the building or access to machinery and equipment not related to elevators through the machinery space, machine room, control spaces, or control rooms shall not be permitted. (13)

2.7.3.2 Passage Across Roofs. The requirements of 2.7.3.2.1 and 2.7.3.2.2 shall be conformed to where passage over roofs is necessary to reach the means of access to machinery spaces, machine rooms, control spaces, and control rooms.

2.7.3.2.1 A stairway with a swinging door and platform at the top level, conforming to 2.7.3.3, shall be provided from the top floor of the building to the roof level. Hatch covers, as a means of access to roofs, shall not be permitted.

2.7.3.2.2 Where the passage is over a roof having a slope exceeding 15 deg from the horizontal, or over a roof where there is no parapet or guardrail at least 1 070 mm (42 in.) high around the roof or passageway, a permanent, unobstructed and substantial walkway not less than 600 mm (24 in.) wide, equipped on each side with a railing conforming to 2.10.2 shall be provided from the building exit door at the roof level to the means of access. (13)

2.7.3.3 Means of Access. The means of access to the following shall conform to 2.7.3.3.1 through 2.7.3.3.6:

(a) machine rooms, control rooms, and machinery spaces and control spaces outside the hoistway, and machinery spaces and control spaces inside the hoistway that do not have a means of access to the space as specified in 2.7.3.1.2

(b) between different floor levels in machine rooms, in control rooms, and in machinery spaces or control spaces outside the hoistway

(c) from within machine rooms or control rooms to machinery spaces and control spaces

2.7.3.3.1 A permanent, fixed, noncombustible ladder or stair shall be provided where the floor of the room or the space above or below the floor or roof from which the means of access leads, or where the distance between floor levels in the room or space, is more than 200 mm (8 in.).

2.7.3.3.2 A permanent, noncombustible stair shall be provided where the floor of the room or the space above or below the floor or roof from which the means of access leads, or where the distance between floor levels in the room or space, is 900 mm (35 in.) or more. Vertical ladders with handgrips shall be permitted to be used in lieu of stairs for access to overhead machinery spaces, except those containing controllers and motor generators.

2.7.3.3.3 Permanent, fixed, noncombustible ladders shall conform to ANSI A14.3.

2.7.3.3.4 Permanent, noncombustible stairs shall have a maximum angle of 60 deg from the horizontal, and shall be equipped with a noncombustible railing conforming to 2.10.2.1, 2.10.2.2, and 2.10.2.3.

2.7.3.3.5 A permanent, noncombustible platform or floor shall be provided at the top of the stairs conforming with the following:

(a) Railings conforming to 2.10.2 shall be provided on each open side.

(b) The floor of the platform shall be at the level of not more than 200 mm (8 in.) below the level of the access-door sill.

(c) The depth of the platform shall be not less than 750 mm (29.5 in.), and the width not less than the width of the door.

(d) The size of the platform shall be sufficient to permit the full swing of the door plus 600 mm (24 in.) from the top riser to the swing line of the door.

2.7.3.3.6 Where a ladder is provided, a permanent, noncombustible platform or floor shall be provided at the top of the ladder, conforming with the following:

(a) Railings conforming to 2.10.2 shall be provided on each open side.

(b) The floor of the platform shall be located below the level of the access-door sill by a vertical distance of not more than 200 mm (8 in.) where full bodily entry is required, and by a vertical distance of not more than 900 mm (35 in.) where full bodily entry is not required.

(c) The depth of the platform shall be not less than 915 mm (36 in.) and the width not less than the width of the door or a minimum of 915 mm (36 in.), whichever is greater.

(d) The size of the platform shall be sufficient to permit the full swing of the door plus 600 mm (24 in.) from the standard railing to the swing line of the door.

(e) The ladder or handgrips shall extend a minimum of 1 220 mm (48 in.) above the platform floor level and shall be located on the access door/panel strike jamb side of the platform.

(f) The railing on the access side shall be provided with a hinged section not less than 600 mm (24 in.) wide with a latchable end adjacent to the ladder.

2.7.3.4 Access Doors and Openings

2.7.3.4.1 Access doors shall be

(a) self-closing and self-locking

(b) provided with a spring-type lock arranged to permit the doors to be opened from the inside without a key

(c) kept closed and locked

2.7.3.4.2 Access doors to machine rooms and control rooms shall be provided. They shall be of a minimum width of 750 mm (29.5 in.) and a minimum height

of 2 030 mm (80 in.). Keys to unlock the access doors shall be Group 2 Security (see 8.1).

2.7.3.4.3 Access doors for spaces specified in 2.7.4.2, 2.7.4.3, and 2.7.4.4 other than those for machine rooms or control rooms shall be a minimum width and height of 750 mm (29.5 in.). Keys to unlock the access doors shall be Group 2 Security (see 8.1).

2.7.3.4.4 Access doors for control spaces outside the hoistway shall be a minimum width and height of 750 mm (29.5 in.). Keys to unlock the access doors shall be Group 2 Security (see 8.1).

2.7.3.4.5 Doors are not required at openings in machine room or control room floors for access to machinery spaces outside the hoistway, provided the access opening is provided on all four sides with a standard railing conforming to 2.10.2, one side of which is arranged to slide or swing to provide access to the ladder or stairs leading to the space. Trap doors, where provided, shall have a standard railing conforming to 2.10.2 or guard wings on all open nonaccess sides.

2.7.3.4.6 Access openings located in the machinery space floor, secondary level floor, machine room floor, control space floor, or control room floor for access into the hoistway shall be provided with doors that shall be kept closed and locked. Keys to unlock the access doors shall be of Group 1 Security (see 8.1).

2.7.3.4.7 Access openings in elevator hoistway enclosures where full bodily entry is not necessary for maintenance and inspection of components shall be

(a) located to permit the required maintenance and inspection

(b) of maximum width of 600 mm (24 in.) and a maximum height of 600 mm (24 in.). These dimensions shall be permitted to be increased, provided that any resultant opening through the access opening into the hoistway shall reject a 300 mm (12 in.) diameter ball.

(c) provided with doors that shall be kept closed and locked. Keys to unlock the access doors to the elevator hoistways shall be of Group 1 Security (see 8.1).

2.7.3.5 Stop Switch for Machinery Spaces or Control Spaces. A stop switch conforming to 2.26.2.24, or a disconnecting means where required by NFPA 70 or CSA-C22.1, whichever is applicable (see Part 9), accessible and visible from the point of access to machinery spaces or control spaces shall be provided for each elevator. Where access to machinery spaces is from the pit, from the top of the car, or from inside the car, the stop switch in the pit, the stop switch on top of the car, or, where provided, the emergency stop switch in the car, respectively, meet these requirements.

2.7.4 Headroom in Machinery Spaces, Machine Rooms, Control Spaces, and Control Rooms

2.7.4.1 Elevator machine rooms, control rooms, and machinery spaces containing an elevator driving

machine not located in the hoistway shall have a clear headroom of not less than 2 130 mm (84 in.). (See also 2.7.4.5.)

2.7.4.2 Where a floor or platform is provided at the top of the hoistway (see 2.1.3), machinery spaces above such a floor or platform shall have a clear headroom of not less than the following:

(a) spaces containing motor-generators, 2 130 mm (84 in.)

(b) spaces containing only overhead, secondary, or deflecting sheaves, 1 070 mm (42 in.)

(c) spaces containing overhead, secondary, or deflecting sheaves, and governors, signal machines, or other equipment, 1 350 mm (53 in.)

2.7.4.3 Where floors are provided under overhead, secondary, or deflecting sheaves [see 2.7.4.2(b) and (c)], the machine and supporting beams shall be permitted to encroach on the required headroom, provided there is a clearance of not less than 900 mm (35 in.) high and minimum width of 750 mm (29.5 in.) in the path of access to sheaves, governors, signal machines, or other equipment.

2.7.4.4 Where a machinery space is located outside but not above the hoistway, the headroom of the area from which any work is performed on the equipment located inside such space shall be not less than 2 000 mm (78 in.), except

(a) spaces containing motor-generators, the headroom shall be not less than 2 130 mm (84 in.)

(b) spaces containing only overhead, secondary, or deflecting sheaves, the headroom shall be not less than 1 070 mm (42 in.)

(c) spaces containing overhead, secondary, or deflecting sheaves, and governors, signal machines, or other equipment, the headroom shall be not less than 1 350 mm (53 in.)

(d) as permitted in 2.7.4.3

2.7.4.5 When working from inside the car, or from the top of the car in accordance with 2.7.5.1, or from the pit in accordance with 2.7.5.2, the headroom when the means required by 2.7.5.1 or 2.7.5.2 are engaged shall

(a) comply with the height of working space requirements of NFPA 70 or CSA-C22.1, whichever is applicable (see Part 9)

(b) in no case be less than 1 350 mm (53 in.)

2.7.4.6 Control spaces outside the hoistway intended for full bodily entry shall have a clear headroom of not less than 2 000 mm (78 in.) or the height of the equipment, whichever is the greater.

NOTE: For control spaces outside the hoistway not intended for full bodily entry, see NFPA 70 or CSA-C22.1, whichever is applicable (see Part 9).

2.7.5 Working Areas Inside the Hoistway and in the Pit

2.7.5.1 Working Areas in the Car or on the Car Top.

The requirements of 2.7.5.1.1 through 2.7.5.1.4 shall be complied with if maintenance or inspections of the elevator driving-machine brake, emergency brake, elevator motion controller, or motor controller are to be carried out from inside the car or from the car top.

2.7.5.1.1 If maintenance or inspection of the elevator driving-machine brake or an emergency brake, or of elevator motion controllers or motor controllers from inside the car or from the car top could result in unexpected vertical car movement, a means to prevent this movement shall be provided.

2.7.5.1.2 The means shall

(a) be independent of the elevator driving-machine brake, emergency brake, motion controller, and motor controller

(b) support not less than the unbalanced weight of the system with no load and up to rated load (see also 2.16.8) in the car and all suspension ropes in place. The minimum factor of safety shall be not less than 3.5, and the materials used shall not have an elongation of less than 15% in a length of 50 mm (2 in.) when tested in accordance with ASTM E8.

(c) when in the engaged position, actuate an electrical device conforming to 2.26.2.34, that shall cause the power to be removed from the elevator driving-machine motor and brake

(d) not cause stresses and deflections that exceed the applicable requirements for the structure(s) to which the means transmits load based on 100% of the static unbalanced weight of the system (see also 2.16.8)

(e) have a sign in conformance with the requirements of ANSI Z535.2 or CAN/CSA-Z321, whichever is applicable, that shall be prominently posted in the work area stating: "WARNING! Engage ' ____ ' before maintaining or inspecting brake, emergency brake, or controller. Follow manufacturers instructions for use of ' ____ '" (see 8.6.11.6). Unless the means has been designed to support not less than the unsuspended car with rated load (see also 2.16.8), it shall also contain the following wording: "Elevator suspension means must be in place during use."

NOTE: Substitute name of actual means for " ____ " in the above signage.

(f) be so designed as to prevent accidental disengagement

(g) when engaged, not require electrical power or the completion or maintenance of an electrical circuit to remain engaged.

2.7.5.1.3 When the means required in 2.7.5.1.1 is engaged, egress from the working area shall be provided (see also 2.7.3.4.3 and 8.6.11.7).

The use of the car top emergency exit for egress and re-entry is permitted subject to the following:

(a) all edges of the exit opening are smooth and free of burrs

(b) means shall be provided to descend safely to the floor of the car, and subsequently ascend safely to the car top

(c) the means required in 2.7.5.1.1 shall not be arranged to be engaged at a position that would permit a vertical gap between the bottom of the vertical face of the platform guard and the elevator landing sill.

2.7.5.1.4 If provided, equipment access panels in the car for access to equipment outside the car shall comply with 2.14.2.2(g)(1), (2), and (5) and shall be provided with

(a) a key-operated lock capable of being locked without a key

(b) an electrical switch that shall cause the power to be removed from the driving machine motor and brake when the access panel is open (see 2.26.2.35)

(c) a key that shall be Group 1 Security (see 8.1)

The access panels shall be kept closed and locked, shall not be self-closing, and shall be self-locking.

2.7.5.2 Working Areas in the Pit. The requirements of 2.7.5.2.1 through 2.7.5.2.4 shall be complied with if maintenance or inspections of the elevator driving-machine brake or an emergency brake or of elevator motion controllers or motor controllers is to be carried out from the pit.

2.7.5.2.1 The following shall be provided:

(a) a means in compliance with 2.7.5.1.1, 2.7.5.1.2, and 2.7.4.5 shall be provided; or

(b) a mechanical device shall be provided to stop vertical car movement to create a vertical clearance as required by 2.7.4.5 between the floor of the working area and the lowest part of the car, and between the floor of the working area and the counterweight where a counterweight guard in conformance with 2.3.2 is not provided.

(1) The mechanical device shall be able to stop vertical car movement at up to and including 115% of rated speed with rated load. The retardation shall not exceed that required by 2.22.3 or 2.22.4, as applicable.

(2) The mechanical device shall be permitted to be moved into the active position manually or automatically.

(3) When the mechanical device is in the active position, it shall operate an electrical contact, which when in the open position, shall permit the car to move only on inspection operation [see 2.26.1.4.1 and 2.26.9.3(d)]. The electrical contact shall be positively opened mechanically and its opening shall not depend solely on springs.

(4) A sign in conformance with the requirements of ANSI Z535.2 or CAN/CSA-Z321, whichever is applicable, shall be prominently posted in the work area stating: "WARNING! Position ' _____ ' before maintaining or inspecting brake, emergency brake, or controller. Follow manufacturers instructions for use of ' _____ '" (see 8.6.11.6).

NOTE: Substitute name of actual device for " _____ " in the above signage.

(5) The mechanical device shall be designed to prevent accidental movement from the active position.

(6) The mechanical device shall not require electrical power or the completion or maintenance of an electrical circuit to be maintained in the active position.

2.7.5.2.2 Pit inspection operation, in compliance with 2.26.1.4, shall be permitted to be provided in the pit (see 2.26.1.4.4).

2.7.5.2.3 When the means required in 2.7.5.2.1 is in the active position, safe and convenient egress from the working area shall be provided (see also 2.7.3.4.3 and 8.6.11.7).

(a) Where the egress is through the landing door

(1) the landing door shall be openable from the hoistway side

(2) the means shall be arranged to provide vertical clearance of not less than 1 220 mm (48 in.) between the bottom edge of the platform guard and the elevator landing

(b) Where the egress is through a separate pit access door, the door opening shall not be blocked by the car.

2.7.5.2.4 Where maintenance or inspections of the elevator driving-machine brake or an emergency brake or of elevator motion controllers or motor controllers is to be carried out from the pit, and the distance from the pit floor to this equipment is more than 2 100 mm (83 in.), a means shall be permanently installed or permanently stored in the pit to provide access to the equipment.

2.7.5.3 Working Platforms. A platform located in the car, on the car, or in the hoistway shall be permitted for access to and maintenance and inspection of equipment in machinery spaces or control spaces in the hoistway and shall comply with 2.7.5.3.1 through 2.7.5.3.6 (see also 8.6.11.8).

2.7.5.3.1 A working platform shall be permanently installed, and it shall be permitted to be retractable. Retractable platforms, that are in the line of movement of the car or counterweight when in the operating position, shall operate a working platform electrical device(s) (see 2.26.2.36) that shall cause the power to be removed from the elevator driving-machine motor and brake unless the platform is in its fully retracted position (see 8.6.11.8).

(ED) **2.7.5.3.2** A working platform shall be able to support in any position at least 2 000 N (450 lbf), with a load concentration of at least 1 000 N (225 lbf) over an area of 40 000 mm² (64 in.²) with a factor of safety of not less than 5. If the platform is to be used for handling heavy equipment, the dimensions and the strength of the platform shall be considered accordingly.

2.7.5.3.3 A working platform shall be provided with a standard railing conforming to 2.10.2 on the open or exposed sides where the perpendicular distance between the edges of the platform and the adjacent hoistway enclosure exceeds 300 mm (12 in.) horizontal clearance, and the difference in level between the platform and the surrounding surface exceeds 400 mm (16 in.).

2.7.5.3.4 Where a car or counterweight passes within 300 mm (12 in.) horizontally from a working platform, a means of protection against shearing hazards shall be provided to a height as measured from the platform standing surface of not less than 2 130 mm (84 in.), or not less than the maximum upward movement of the car or counterweight. The means shall be at least equal in strength and stiffness to 2 mm (0.074 in.) thick sheet steel. If perforated, it shall reject a ball 25 mm (1 in.) in diameter.

(13) **2.7.5.3.5** Where the access to a working platform that is in the line of movement of the car or counterweight is not through the elevator landing doors, but through an access panel or door in the hoistway, the access panel or door shall meet the requirements of 2.11.1.2(b), (d), and (e) through (i).

2.7.5.3.6 Working platform inspection operation, in compliance with 2.26.1.4, shall be permitted to be provided at the location of a working platform. [See 2.7.5.5(b) for additional requirements when the working platform is in the line of movement of the car.]

2.7.5.4 Working Platforms in the Line of Movement of the Car or Counterweight. Working platforms in the line of movement of the car or counterweight shall be permitted

(a) where retractable stops are provided and the car is

(1) below the platform, the travel of the elevator shall be limited by a retractable stop(s) in such a manner that the car shall be stopped below the platform at least the distance required for car top refuge space (see 2.4.12.1)

(2) above the platform, the travel of the elevator shall be limited by a retractable stop(s) in such a manner that the car shall be stopped above the platform at least the distance required in 2.7.4.5; or

(b) where the elevator is provided with a device conforming to 2.7.5.1.1 and 2.7.5.1.2.

2.7.5.5 Retractable Stops. Retractable stops, where provided, shall

(a) be equipped with a retractable stop electrical device(s) (see 2.26.2.37), that shall cause the power to be removed from the elevator driving-machine motor and brake, unless the stops are completely in the retracted position.

(b) be permitted to be equipped with an electrical device(s) that permits operation of the car only on inspection operation when the platform is in the operating position and the stops are in the fully extended position. When provided with such an electrical device and the stop(s) is in the extended position, an additional stopping device conforming to 2.25.3.1 and 2.25.3.3 through 2.25.3.5 shall cause the car to stop before it strikes the movable stop(s). This additional stopping device shall be rendered ineffective when the stop(s) is in the retracted position. Any electrical device(s) used to render the additional stopping device ineffective shall be in conformance with 2.26.4.3, 2.26.9.3.1(a), 2.26.9.3.2, and 2.26.9.4.

(c) be operable from outside the hoistway or from the platform.

(d) be able to stop the car traveling at 115% of rated speed with rated load. The retardation shall not exceed that required by 2.22.3 or 2.22.4, as applicable.

(e) be so designed as to prevent accidental disengagement.

2.7.6 Location of Machinery Spaces, Machine Rooms, Control Spaces, Control Rooms, and Equipment

2.7.6.1 Location of Machine Rooms and Control Rooms. Elevator machine rooms and control rooms, where provided, shall not be located in the hoistway.

2.7.6.2 Location of Machinery Spaces and Control Spaces. Machinery spaces and control spaces shall be permitted to be located inside or outside the hoistway.

NOTE: Inside the hoistway includes, but is not limited to, on or in the car, on the counterweight, or in the pit.

2.7.6.3 Location of Equipment. The location of equipment used directly in connection with the elevator shall conform to the requirements of 2.7.6.3.1 through 2.7.6.3.4.

2.7.6.3.1 The electric driving machine shall be located in a machinery space or machine room.

2.7.6.3.2 The motor controller shall be located in a machinery space, machine room, control space, or control room.

A motor controller shall be permitted to be located outside the specified spaces, provided it is enclosed in a locked cabinet. The locked cabinet shall be

(a) readily accessible for maintenance and inspection at all times.

(b) provided with cabinet door(s) or panel(s) that are not self-closing, that are self-locking, and that shall be kept closed and locked. Keys shall be Group 1 Security (see 8.1).

(c) lit by permanently installed electric lighting with a lighting intensity of at least 200 lx (19 fc) at the floor level.

(d) located in a space that is provided with natural or mechanical means to keep the ambient air temperature and humidity in the range specified by the elevator equipment manufacturer to ensure safe and normal operation of the elevator. The temperature and humidity range shall be permanently posted on the cabinet.

NOTE (2.7.6.3.2): For electrical clearance requirements, see NFPA 70 or CSA-C22.1, whichever is applicable (see Part 9).

2.7.6.3.3 Where sheaves and other equipment (except governors) are located overhead inside the hoistway, they shall be provided with a means of access from outside the hoistway conforming to the requirements of 2.7.3.3, unless they can be inspected and serviced from the top of the car.

2.7.6.3.4 Where a governor is located inside the hoistway, means of access conforming to the requirements of 2.7.3.3 and 2.7.3.4 for inspection and servicing the governor shall be provided from outside the hoistway. The access opening shall not be required where

(a) the governor can be inspected and serviced from the top of the car or adjacent car, and the governor can be tripped for testing from the adjacent car or outside the hoistway; and means are furnished to prevent movement of the car when servicing the governor. A sign with the words "SECURE CAR AGAINST MOVEMENT BEFORE SERVICING THE GOVERNOR" shall be prominently posted and be visible from the governor. The sign shall conform to ANSI Z535.2 or CAN/CSA-Z321, whichever is applicable. The sign shall be of such material and construction that the letters and figures stamped, etched, cast, or otherwise applied to the face shall remain permanently and readily legible; and

(b) for elevators in a single hoistway, the governor can be reset automatically when the car is moved in the up direction or the governor can be reset from outside the hoistway.

2.7.6.4 Means Necessary for Tests. Where an elevator driving-machine brake or an emergency brake, or an elevator motion controller or motor controller is located in the hoistway or pit, means necessary for tests that require movement of the car or release of the driving-machine brake or emergency brake, shall be provided and arranged so that they can be operated from outside the hoistway and shall conform to 2.7.6.4.1 through 2.7.6.4.3. These means are also permitted to be used by elevator personnel for passenger rescue.

2.7.6.4.1 Where direct observation of the elevator drive sheave or ropes is not possible from the location

of the means necessary for tests that require movement of the car or release of the driving-machine brake or emergency brake, display devices or the equivalent shall be provided. They shall be visible from the location of the means and shall convey the following information about the elevator simultaneously:

(a) the direction of movement

(b) the reaching of a position within the door unlocking zone

(c) an indication of the speed

The display devices or the equivalent shall remain operable during a failure of the normal building power supply. The power source shall be capable of providing for the operation of the display devices or the equivalent for at least 4 h. Where batteries are used, a monitoring system shall be provided. In the event that during normal operation of the car, the monitoring indicates insufficient power to operate the display devices or the equivalent, the car shall not be permitted to restart after a normal stop at a landing.

2.7.6.4.2 The means necessary for tests shall be permitted to be located within an inspection and test panel conforming to the requirements of 2.7.6.5.2.

2.7.6.4.3 A means to move the car from outside the hoistway shall be provided and it shall conform to the following:

(a) it shall not be dependent on the availability of normal power.

(b) it shall be accessible for operation by elevator personnel only with a key that is Group 1 Security (see 8.1).

(c) it shall allow the car to move only with continuous effort.

(d) if the car is moved manually, the effort required to move the car in the direction of load imbalance shall not exceed 400 N (90 lbf). If the means used is removable, it shall be stored outside the hoistway and access to the means shall be with a key that is Group 1 Security. It shall be suitably marked to indicate the machine for which it is intended.

(e) Where the manual effort required to move the car exceeds 400 N (90 lbf), a means of electrical operation shall be provided to allow the car to be moved. This means of electrical operation shall require constant pressure operating devices to move the car, and when activated, operation of the car by all other operating means shall be prevented. A failure of a single constant pressure operating device shall not permit the elevator to move or continue to move. Where batteries are used for this electrical operation, a monitoring system shall be provided. In the event that during normal operation of the car the monitoring system indicates insufficient power to move the car, the car shall not be permitted to restart after a normal stop at a landing.

2.7.6.5 Inspection and Test Panel

2.7.6.5.1 The inspection and test panel shall be required where any of the following are not accessible from outside the hoistway:

(a) the devices necessary for the manual reset of the detection means for ascending car overspeed protection [see 2.19.1.2(a)(4)], and protection against unintended car movement [see 2.19.2.2(a)(4)], or

(b) the circuits of the following devices:

(1) the car-safety mechanism switch (see 2.26.2.9)

(2) the car buffer switch, where provided (see 2.26.2.22)

(3) the top and bottom final terminal stopping devices (see 2.26.2.11)

(4) the car and counterweight governor switches, where provided (see 2.26.2.10)

2.7.6.5.2 The inspection and test panel, where provided, shall be accessible from outside the hoistway and shall

(a) be readily accessible for maintenance and inspection at all times.

(b) have the required devices located behind a locked door or panel that does not open into the hoistway, that is not self-closing, that is self-locking, and that shall be kept closed and locked. Keys shall be of Group 1 Security (see 8.1).

(c) be provided with a stop switch, conforming to 2.26.2.24.

(d) be lit by permanently installed electric lighting with a lighting intensity of at least 200 lx (19 fc) at the floor level. A switch placed inside or close to the enclosure shall control lighting of the enclosure.

(e) include the display devices as required by 2.7.6.4.1.

(f) include the "CAR DOOR BYPASS" and "HOISTWAY DOOR BYPASS" switches where required by 2.26.1.5.

(g) include the devices necessary for the manual reset of the detection means for ascending car overspeed protection [see 2.19.1.2(a)(4)], and protection against Unintended Car Movement [see 2.19.2.2(a)(4)] where these devices are not accessible from outside the hoistway.

(h) where the circuits of the devices in 2.7.6.5.1(b)(1) through (4) are not accessible from outside the hoistway, include landing inspection operation in conformance with 2.26.1.4.4, and that shall be permitted to render ineffective the following electrical protective devices, individually or as a group or groups, in conformance with the requirements of 2.26.9.3.1(a), 2.26.9.3.2, and 2.26.9.4:

(1) the car-safety mechanism switch (see 2.26.2.9)

(2) the car buffer switch, where provided (see 2.26.2.22)

(3) the top and bottom final terminal stopping devices (see 2.26.2.11)

(4) the car and counterweight governor switches, where provided (see 2.26.2.10)

NOTE (2.7.6.5): For electrical clearance requirements, see NFPA 70 or CSA-C22.1, whichever is applicable (see Part 9). See also 2.8.3.3.2.

2.7.6.6 Equipment Exposure to Weather. Machines, control equipment, sheaves, and other machinery shall not be exposed to the weather unless they are suitable for the application.

2.7.7 Machine Rooms and Control Rooms Underneath the Hoistway

When a machine room or control room is located underneath the hoistway, it shall conform to 2.7.7.1 through 2.7.7.5.

2.7.7.1 The machine or control room shall have a solid ceiling (pit floor, at the normal pit depth) of concrete or steel above the machine room or control room, with a minimum 2 130 mm (84 in.) clearance above the machine room or control room floor.

2.7.7.2 The ceiling of the machine or control room shall be capable of sustaining a concentrated load of 1 000 N (225 lbf) on any 2 000 mm² (3 in.²) area, and it shall be designed for a live load of 6 kPa (125 lbf/ft²) and loads imposed by rails and/or buffers, if applicable.

2.7.7.3 The car and counterweight guide rails and buffer supports shall be permitted to extend into the machine room and be supported by the machine room floor. If the counterweight buffer or buffer support extends to the machine room or control room floor, a counterweight safety is not required unless the space below the machine room is not permanently secured against access. If a counterweight buffer is supported at the machine room ceiling (pit floor), a counterweight safety is required. (See 2.6.1 for additional requirements.)

2.7.7.4 The solid ceiling (pit floor at normal pit depth) shall be permitted to be slotted for the penetration of equipment (suspension ropes, selector drives, electrical conduit, rails, buffers, etc.). Passage and guards shall be provided in conformance with 2.3.2 and 2.10.1 for both the machine or control room and pit. A counterweight guard shall be installed at the pit floor as well as the machine or control room floor if the counterweight extends into the machine or control room and 2.3.2.1(a) does not apply. The guard in the machine or control room shall extend to the ceiling.

2.7.7.5 Compensating ropes or chains and traveling cables shall not extend into the machine room located underneath the hoistway.

2.7.8 Remote Machine Rooms and Control Rooms

Elevators that are provided with remote machine rooms and/or control rooms shall conform to 2.7.8.1 through 2.7.8.4.

2.7.8.1 Ropes and sheaves leading to the remote machine room that penetrate fire barriers shall be fully enclosed, and the enclosures shall conform to 2.1.1.1.

2.7.8.2 Rope and sheave enclosures leading to the remote machine room shall be protected against unauthorized access.

2.7.8.3 Permanent means of access shall be provided to the enclosures for inspection, repair, and maintenance of hoist ropes passing over sheaves that are not located in the hoistway or remote machine rooms. Access doors to these enclosures shall be provided at each sheave location, conforming to 2.7.3.4. Access openings shall be provided for inspection and maintenance of hoist ropes passing over sheaves and shall conform to 2.7.3.4. A stop switch meeting the requirements of 2.26.2.23, a permanent electric duplex receptacle, a light switch, and light shall be provided in the enclosures immediately inside the access doors and openings.

2.7.8.4 A permanent means of communication between the elevator car and remote machine room and or control room shall be provided.

2.7.9 Lighting, Temperature, and Humidity in Machinery Spaces, Machine Rooms, Control Spaces, and Control Rooms

2.7.9.1 Lighting. Permanently installed electric lighting shall be provided in all machinery spaces, machine rooms, control spaces, and control rooms. The illumination shall be not less than 200 lx (19 fc) at the floor level, at the standing surface of a working platform (see 2.7.5.3), or at the level of the standing surface when the car is in the blocked position (see 2.7.5.1). The light switch shall be located at the point of entry

(a) for machinery spaces and control spaces, and

(b) for machine rooms and control rooms, inside the room and where practicable on the lock-jamb side of the access door

2.7.9.2 Temperature and Humidity. Machinery spaces, machine rooms, control spaces, and control rooms shall be provided with natural or mechanical means to keep the ambient air temperature and humidity in the range specified by the elevator equipment manufacturer to ensure safe and normal operation of the elevator. The temperature and humidity range shall be permanently posted in the machine room, control room, control space, or where specified by the equipment manufacturer, in the machinery space.

SECTION 2.8 EQUIPMENT IN HOISTWAYS, MACHINERY SPACES, MACHINE ROOMS, CONTROL SPACES, AND CONTROL ROOMS

2.8.1 Equipment Allowed

Only machinery and equipment used directly in connection with the elevator shall be permitted in elevator

hoistways, machinery spaces, machine rooms, control spaces, and control rooms.

2.8.2 Electrical Equipment and Wiring

2.8.2.1 Installation of electrical equipment and wiring shall conform to NFPA 70 or CSA-C22.1, whichever is applicable (see Part 9).

2.8.2.2 Only such electrical wiring, raceways, cables, coaxial wiring, and antennas used directly in connection with the elevator, including wiring for signals, for communication with the car, for lighting, heating, air conditioning, and ventilating the car, for fire detecting systems, for pit sump pumps, and for heating and lighting the hoistway and/or the machinery space, machine room, control space, or control room shall be permitted to be installed inside the hoistway, machinery space, machine room, control space, or control room.

2.8.2.3 Bonding conductors from the lightning protection system grounding down conductor to long vertical metal bodies in the hoistway such as elevator rails and vertical wireways shall be permitted to be installed in the hoistway as required by NFPA 780, or CAN/CSA-B72, whichever is applicable (see Part 9). The lightning protection system grounding down conductor shall not be permitted in the hoistway, and the elevator rails shall not be used as the lightning protection system grounding down conductor. Bonding conductors installed in the hoistway shall not interfere with the operation of the elevator.

2.8.3 Pipes, Ducts, Tanks, and Sprinklers

2.8.3.1 Steam and hot-water pipes shall be permitted to be installed in hoistways, machinery spaces, machine rooms, control spaces, and control rooms for the purpose of heating these areas only, subject to 2.8.3.1.1 through 2.8.3.1.3.

2.8.3.1.1 Heating pipes shall convey only low-pressure steam [100 kPa (15 psi) or less] or hot water [100°C (212°F) or less].

2.8.3.1.2 All risers and return pipes shall be located outside the hoistway. When the machinery space, machine room, control space, or control room is located above the roof of the building, heating pipes for the machinery space, machine room, control space, or control room shall be permitted to be located in the hoistway between the top floor and the machinery space, machine room, control space, or control room.

2.8.3.1.3 Traps and shutoff valves shall be provided in accessible locations outside the hoistway.

2.8.3.2 Ducts shall be permitted to be installed in the hoistway, machinery space, machine room, control space, or control room for the purpose of heating, cooling, ventilating, and venting these areas only and shall not encroach upon the required clearances.

2.8.3.3 Sprinkler systems conforming to NFPA 13 or the NBCC, whichever is applicable (see Part 9), shall be permitted to be installed in the hoistway, machinery space, machine room, control space, or control room subject to 2.8.3.3.1 through 2.8.3.3.4.

2.8.3.3.1 All risers shall be located outside these spaces. Branch lines in the hoistway shall supply sprinklers at not more than one floor level. When the machinery space, machine room, control space, or control room is located above the roof of the building, risers and branch lines for these sprinklers shall be permitted to be located in the hoistway between the top floor and the machinery space, machine room, control space, or control room.

2.8.3.3.2 In jurisdictions not enforcing the NBCC, where elevator equipment is located or its enclosure is configured such that application of water from sprinklers could cause unsafe elevator operation, means shall be provided to automatically disconnect the main line power supply to the affected elevator and any other power supplies used to move the elevator upon or prior to the application of water.

(a) This means shall be independent of the elevator control and shall not be self-resetting.

(b) Heat detectors and sprinkler flow switches used to initiate main line elevator power shutdown shall comply with the requirements of NFPA 72.

(c) The activation of sprinklers outside of such locations shall not disconnect the main line elevator power supply. See also 2.27.3.3.6.

2.8.3.3.3 Smoke detectors shall not be used to activate sprinklers in these spaces or to disconnect the main line power supply.

2.8.3.3.4 In jurisdictions not enforcing the NBCC, when sprinklers are installed not more than 600 mm (24 in.) above the pit floor, 2.8.3.3.4(a) and (b) apply to elevator electrical equipment and wiring in the hoistway located less than 1 200 mm (48 in.) above the pit floor, except earthquake protective devices conforming to 8.4.10.1.2(d); and on the exterior of the car at the point where the car platform sill and the lowest landing hoistway door sill are in vertical alignment.

(a) Elevator electrical equipment shall be weather-proof (Type 4 as specified in NEMA 250).

(b) Elevator wiring, except traveling cables, shall be identified for use in wet locations in accordance with the requirements in NFPA 70.

2.8.3.4 Other pipes or ducts conveying gases, vapors, or liquid and not used in connection with the operation of the elevator shall not be installed in any hoistway, machinery space, machine room, control space, or control room. Where a machinery space, machine room, control space, control room, or hoistway

extend above the roof of a building, pipes shall be permitted from roof drains to the closest point where they can be diverted out of this space. Pipes shall be covered to prevent leakage or condensate from entering the machinery space, machine room, control space, control room, or hoistway.

2.8.3.5 Where permitted and provided, pipes, drains, and tanks, or similar equipment that contains liquids, shall not be located directly above the elevator equipment and shall not encroach upon the required clearances in the hoistway, machinery space, machine room, control space, or control room.

2.8.4 Electrical Heaters

Listed/certified electrical heaters shall be permitted.

2.8.5 Air Conditioning

Air conditioning equipment is permitted to be installed in machinery spaces, machine rooms, control spaces, or control rooms for the purpose of cooling these areas only, subject to 2.8.5.1 through 2.8.5.5.

2.8.5.1 Air conditioning equipment shall not be located directly above elevator equipment.

2.8.5.2 The clear headroom below suspended air conditioning equipment shall conform to 2.7.4.

2.8.5.3 Means shall be provided to collect and drain condensation water from these spaces. Condensation drains shall not be located directly above elevator equipment. Drains connected directly to sewers shall not be installed.

2.8.5.4 Safe and convenient access within the elevator machinery space, machine room, control space, or control room shall be provided to the air-conditioning equipment for servicing and maintaining.

NOTE: See also 2.7.3.1.

2.8.5.5 There shall be no exposed gears, sprockets, belts, pulleys, or chains.

NOTES (2.8.5):

(1) See 2.8.3.2 for requirements for duct work.

(2) These requirements do not pertain to air-conditioning equipment used to cool selective elevator equipment.

2.8.6 Miscellaneous Equipment

Enclosed moving, rotating, hanging machinery, equipment, stationary decorative lighting, stationary signage or other stationary special effects devices, securely attached to either one or more of the car, counterweight, or hoistway shall be permitted, provided that the elevator, including the equipment and devices, conforms to 2.4, 2.5, 2.8.1, 2.14.2.1.1, 2.15.7, 8.2.2.1, and 8.2.9.1. Any unenclosed moving, rotating, or hanging machinery or equipment, attached to the exterior of the car or counterweight, interior of the hoistway, exterior

of the car, or any other elevator equipment in the hoistway is prohibited unless it is used in conjunction with the designed use of the elevator.

SECTION 2.9 MACHINERY AND SHEAVE BEAMS, SUPPORTS, AND FOUNDATIONS

2.9.1 Supports Required

Machines, machinery, sheaves, and hitches shall be supported by overhead beams, structural floors, structural walls, or guide rails.

2.9.1.1 Machines, machinery, and sheaves shall be so supported and maintained in place as to prevent any part from becoming loose or displaced under the conditions imposed in service.

2.9.1.2 Supporting beams, if used, shall be of steel or reinforced concrete.

2.9.1.3 Beams are not required under machine(s), sheave(s), and machinery or control equipment that is supported on floors, provided such floors are designed and installed to support the load imposed thereon, or where supported by guide rails or structural walls designed to meet the requirements of 2.9.3.3.

2.9.2 Loads on Machinery and Sheave Beams, Floors, or Foundations and Their Supports

2.9.2.1 Overhead Beams, Floors, and Their Supports. Overhead beams, floors, and their supports shall be designed for not less than the sum of the following loads:

(a) the load resting on the beams and supports, that shall include the complete weight of the machine, sheaves, controller, governor, and any other equipment, together with that portion, if any, of the machinery space, machine room, control space, or control room floor supported thereon

(b) two times the sum of the tensions in all wire ropes supported by the beams, floors, and their supports with rated load in the car

NOTE [2.9.2.1(b)]: These tensions are doubled to take care of accelerations and decelerations.

2.9.2.2 Foundations, Beams, and Floors for Machinery and Sheaves Not Located Directly Over the Hoistway. The supports for machines and sheaves located below or at the sides of the hoistway shall meet the requirements of 2.9.2.2.1 through 2.9.2.2.4.

2.9.2.2.1 The foundation shall support the total weight of the machine, sheaves, and other equipment, and the floor, if any.

2.9.2.2.2 The sheave beams and the foundation bolts shall withstand two times the vertical force component acting thereon as a result of the tension in all the

suspension ropes, less the weight of the machine or sheaves.

2.9.2.2.3 The sheave beams and the foundation bolts shall withstand two times the horizontal force component, if any, acting thereon as a result of the tension in all the suspension ropes.

2.9.2.2.4 The foundation shall withstand two times the overturning moment, if any, acting thereon as a result of the tension in all the suspension ropes.

2.9.3 Securing of Machinery and Equipment to Beams, Foundations, Guide Rails, Structural Walls, or Floors

2.9.3.1 Overhead Beams and Floors

2.9.3.1.1 Where overhead beams and floors are used to support machinery or equipment, the machinery or equipment shall be secured to and supported on or from the top of overhead beams or floors, except for the following equipment:

(a) secondary or deflecting sheaves of traction elevators

(b) devices and their accessories for limiting or retarding car speed

2.9.3.1.2 Securing bolts or fastenings are not required where sound isolation in compression is used between bases of machinery or equipment and supporting beams or floors.

2.9.3.2 Beams or Foundations Supporting Machinery and Sheaves Not Located Directly Over the Hoistway

2.9.3.2.1 Machines and sheaves located below or at one side of a hoistway shall be anchored to beams, foundations, or floors with bolts, conforming to ASTM A307, of sufficient size and number to withstand the applicable load conditions specified in 2.9.2.2. Based on these initial loads, total tension in anchor bolts shall not exceed 85 MPa (12,000 psi) of net section, and the total shear shall not exceed 60 MPa (9,000 psi) of actual area in the shear plane. (See also 2.9.3.5.)

2.9.3.2.2 Where bolts are used through greater than 5 deg sloping flanges of structural shapes, the bolt heads shall be of the tipped or beveled head type or shall be fitted with beveled steel washers, and nuts on greater than 5 deg sloping flanges shall seat on beveled steel washers.

2.9.3.3 Securing of Machines, Sheaves, Equipment, and Hitches to Guide Rails or Structural Walls

2.9.3.3.1 Machines, sheaves, equipment, and hitches shall be permitted to be secured to and supported by the guide rails or structural walls, provided that the tension in the hoisting ropes and the weight of the equipment will not develop direct tensions in the bolts or rivets.

2.9.3.3.2 Securing bolts or fastenings are not required where sound isolation in compression is used between bases of machinery or equipment and their supports.

2.9.3.3.3 Bolts used to secure equipment to the guide rails or structural walls shall conform to ASTM A307, and be of sufficient size and number to withstand the applicable load conditions specified in 2.9.2.2. Based on these initial loads, total tension in support bolts shall not exceed 85 MPa (12,000 psi) of net section, and the total shear in bolts and rivets shall not exceed 60 MPa (9,000 psi) of actual area in the shear plane. The requirements of 2.9.3.2.2 for bolts and 2.9.3.4.3 and 2.9.3.4.4 for hitch plates shall also apply. The stresses in welds due to tensions in the hoisting ropes shall not exceed 55 MPa (8,000 psi) on the throat area of the welds. (See also 2.9.3.5.)

2.9.3.3.4 Guide rails used to support machines, equipment, sheaves, and hitches shall meet the requirements of 2.23.4.

2.9.3.4 Overhead Hoisting-Rope Hitches

2.9.3.4.1 Where hoisting ropes are secured to the structure above a hoistway, the hitch plates and hitch-plate blocking beams, where used, shall be secured to and mounted on top of overhead beams, machine beams, or on top of auxiliary beams connected to the webs of overhead beams.

2.9.3.4.2 Hitch plates, blocking, or auxiliary beams shall be secured by bolts conforming to ASTM A307, rivets conforming to ASTM A502, or welding conforming to 8.8, and shall be so located that the tension in the hoisting ropes will not develop direct tensions in the bolts or rivets. Where bolts and rivets are subjected to shearing stresses due to tension in the hoisting ropes, the total shear shall not exceed 60 MPa (9,000 psi) of actual area in the shear plane. The stresses in welds due to tensions in the hoisting ropes shall not exceed 55 MPa (8,000 psi) on the throat area of the welds. (See also 2.9.3.5.)

2.9.3.4.3 The hitch plate supporting structure shall be designed to withstand two times the sum of the tensions in all hoisting ropes attached to the hitch plates. (See also 2.15.13.)

2.9.3.4.4 Total stresses in hitch plates and hitch-plate shapes shall not exceed 85 MPa (12,000 psi).

2.9.3.5 Bolts Made of Steel. Bolts made of steel used to comply with the requirements of 2.9.3.2.1, 2.9.3.3.3, and 2.9.3.4.2 having a greater strength than specified by ASTM A307 shall be permitted, provided that the maximum allowable stresses increased proportionally based on the ratio of the ultimate strengths. Elongation shall conform to the requirements of the corresponding ASTM specification.

2.9.3.6 Cast Metals in Tension or Bending. Cast metals having an elongation of less than 20% in a length of 50 mm (2 in.), when measured in accordance with ASTM E8, that are subject to tension or bending, shall not be used to support machinery or equipment from the underside of overhead beams or floors.

2.9.4 Allowable Stresses for Machinery and Sheave Beams or Floors, Their Supports, and Any Support Members That Transmit Load to the Guide Rails or Structural Walls

2.9.4.1 The unit stresses for all machinery and sheave beams and floors and their supports, based on the loads computed as specified in 2.9.2 or 2.9.6, whichever is greater, shall not exceed 80% of those permitted for static loads by the following standards:

(a) *Structural Steel.* AISC Book No. S326 or CAN/CSA-S16.1, whichever is applicable (see Part 9).

(b) *Reinforced Concrete.* ANSI/ACI 318 or CAN3-A23.3, whichever is applicable (see Part 9).

2.9.4.2 Where stresses due to loads, other than elevator loads supported on the beams or floor, exceed those due to the elevator loads, 100% of the permitted stresses are permitted.

2.9.4.3 Cast Metals in Tension or Bending. Cast metals having an elongation of less than 20% in a length of 50 mm (2 in.), when measured in accordance with ASTM E8, that are subject to tension or bending, shall not be used to support machinery or equipment from guide rails or structural walls.

2.9.5 Allowable Deflections of Machinery and Sheave Beams, Their Supports, and Any Support Members Loaded in Bending That Transmit Load to Guide Rails or Structural Walls

The allowable deflections of machinery and sheave beams, their immediate supports, and any support members loaded in bending that transmit load to guide rails or structural walls under static load shall not exceed $\frac{1}{1666}$ of the span.

2.9.6 Allowable Stresses Due to Emergency Braking

Machinery and sheave beams, supports, any support members that transmit load to guide rails or structural walls and any fastenings subject to forces due to the application of the emergency brake (see 2.19.4) shall be designed to withstand the maximum forces developed during the retardation phase of the emergency braking so that the resulting stresses due to the emergency braking and all other loading acting simultaneously, if applicable, shall not exceed those specified in 2.9.4.

SECTION 2.10 GUARDING OF EQUIPMENT AND STANDARD RAILING

2.10.1 Guarding of Equipment

In machinery spaces, machine rooms, control spaces, and control rooms, the following shall be guarded to protect against accidental contact:

(a) driving-machine sheaves and ropes whose vertical projection upon a horizontal plane extends beyond the base of the machine, unless the driving-machine sheave is so located as to minimize the possibility of contact

(b) sheaves

(c) exposed gears, sprockets, tape or rope sheaves, or drums of selectors, floor controllers, or signal machines, and their driving ropes, chains, or tapes

(d) keys, keyways, and screws in projecting shafts

Handwinding wheels and flywheels that are not guarded shall have yellow markings.

2.10.2 Standard Railing

A standard railing shall be substantially constructed of metal and shall consist of a top rail, intermediate rail or equivalent structural member or solid panel, and toe-board.

(13) **2.10.2.1 Top Rail.** The top rail shall have a smooth surface, and the upper surface shall be located at a vertical height of not less than 1 070 mm (42 in.) and not more than 1 095 mm (43 in.) from the working surface.

2.10.2.2 Intermediate Rail, Member, or Panel. The intermediate rail or equivalent structural member or solid panel shall be located approximately centered between the top rail and the working surface.

2.10.2.3 Toe-Board. The toe-board shall be securely fastened and have a height not less than 100 mm (4 in.) above the working surface.

2.10.2.4 Strength of Standard Railing. A standard railing shall be capable of resisting anywhere along its length the following forces when applied separately, without deflecting more than 75 mm (3 in.) and without permanent deformation:

(a) a force of at least 890 N (200 lbf) applied in any lateral or downward vertical direction, at any point along the top rail.

(b) a force of at least 666 N (150 lbf) applied in any lateral or downward vertical direction at any point along the center of the intermediate rail, member, or panel. If the standard railing is a solid panel extending from the top rail to the toe-board, the application of the force specified in 2.10.2.4(a) shall be considered to meet the requirements of 2.10.2.4(b).

(c) a force of 225 N (50 lbf) applied in a lateral direction to the toe-board.

SECTION 2.11 PROTECTION OF HOISTWAY OPENINGS

2.11.1 Entrances and Emergency Doors Required

2.11.1.1 Hoistway Landing Entrances. All elevator hoistway landing openings shall be provided with entrances that shall guard the full height and width of the openings. Entrances shall be at least 2 030 mm (80 in.) in height and 800 mm (31.5 in.) in width.

2.11.1.2 Emergency Doors in Blind Hoistways. (13)

Where an elevator is installed in a single blind hoistway, there shall be installed in the blind portion of the hoistway an emergency door at every third floor, but not more than 11 m (36 ft) from sill to sill, conforming to the following:

(a) The clear opening shall be at least 700 mm (28 in.) wide and 2 030 mm (80 in.) high.

(b) It shall be easily accessible and free from fixed obstructions.

(c) It shall be either of the horizontally sliding or swinging single-section type, irrespective of the type of door installed at other landings.

(d) It shall be self-closing and self-locking and shall be marked, in letters not less than 50 mm (2 in.) high, "DANGER, ELEVATOR HOISTWAY."

(e) It shall be provided with an electric contact that will prevent the operation of the driving machine unless the door is closed (see 2.26.2.25).

(f) It shall be unlocked from the landing side only through the use of a cylinder-type lock, having not less than five pins or five discs. The cylinder lock shall

(1) not be unlocked by any key that will open any other lock or device used for any purpose in the building

(2) be so designed that the key shall be removable only in the locked position

(g) It shall be openable from the hoistway side without the use of a key.

(h) The key shall be of Group 1 Security (see 8.1). This key shall also be made available to emergency personnel during an emergency.

(i) A hinged self-closing barrier independent of the door shall be installed horizontally across the entrance on the hoistway side at a height of 1 070 mm (42 in.). The barrier shall not open into the hoistway.

2.11.1.3 Telephone as Alternative to Emergency Doors. Where an elevator is installed in a single blind hoistway, and there are no landings from which to gain access through an emergency door, a means of two-way conversation conforming to 2.27.1.1.4 shall be provided.

NOTE: Examples are pulp mills, grain elevators, dams, or similar locations.

2.11.1.4 Access Openings for Cleaning of Car and Hoistway Enclosures. Nonremovable sliding or swing panels or doors in the hoistway conforming to 2.11.1.2(d), (f), (g), and (i) shall be permitted for access

to car or hoistway transparent enclosures for cleaning purposes. An electromechanical device shall be provided that will prevent the operation of the driving machine unless the access panels or doors are closed and locked (see 2.26.2.32). Keys used to unlock the access panels or doors shall be Group 2 Security (see 8.1).

2.11.2 Types of Entrances

2.11.2.1 Passenger Elevators. For passenger elevators, entrances shall be one of the following types:

- (a) horizontally sliding
- (b) horizontally swinging, single-section
- (c) combination horizontally sliding and swinging
- (d) hand- or power-operated vertically sliding that slide up to open

2.11.2.2 Freight Elevators. For freight elevators, entrances shall be one of the following types:

- (a) horizontally sliding
- (b) swinging, single-section
- (c) combination horizontally sliding and swinging
- (d) center-opening, two-section horizontally swinging, subject to restrictions of 2.11.2.3
- (e) vertically sliding biparting counterbalanced (see 2.16.4)
- (f) vertically sliding counterweighted, single- or multisection

2.11.2.3 Limitations of Use of Center-Opening Swinging Entrances. Center-opening swinging entrances shall be permitted only

- (a) for freight elevators that can be operated only from the car; or
- (b) for freight elevators not accessible to the general public that can be operated from outside the hoistway, and that are located in factories, warehouses, garages, and similar industrial buildings.

2.11.3 Closing of Hoistway Doors

2.11.3.1 Horizontally sliding or single-section swinging doors of automatic-operation elevators shall be provided with door closers arranged to close an open door automatically if the car, for any reason, leaves the landing zone.

2.11.3.2 On center-opening doors, if there is an interlock on only one panel, the door closer required by 2.11.3.1 shall be provided on the leading panel that operates in the opposite direction (see 2.11.11.7).

2.11.4 Location of Horizontally Sliding or Swinging Hoistway Doors

Horizontally sliding or swinging doors shall be so located that the distance from the hoistway face of the doors to the edge of the hoistway landing sill, measured from the face of the door section nearest to the car, shall be not more than the requirements specified in 2.11.4.1 and 2.11.4.2.

2.11.4.1 For elevators that can be operated only from the car, 100 mm (4 in.), except that where new elevators are installed in existing multiple hoistways or where alterations involving replacement of the doors are made to existing elevators in multiple hoistways, and the location of the door openings is such that the 100 mm (4 in.) dimension specified cannot be maintained, the distance specified is permitted to be increased to not more than 125 mm (5 in.) where horizontally sliding doors are used.

2.11.4.2 For elevators with automatic or continuous-pressure operation, 19 mm (0.75 in.) for swinging doors and 57 mm (2.25 in.) for sliding doors, except that

- (a) freight elevators not accessible to the general public, and that are located in factories, warehouses, garages, and similar industrial buildings are permitted to have single-section or center-opening two-section horizontally swinging doors conforming to 2.11.4.1; or
- (b) for swinging doors used on elevators with automatic and continuous-pressure operation, the distance shall be permitted to be increased from 19 mm to 57 mm (0.75 in. to 2.25 in.) if such doors are emergency doors conforming to 2.11.1. (See also 2.14.4.5.)

2.11.5 Projection of Entrances and Other Equipment Beyond the Landing Sills (13)

Entrances and equipment shall not project into an elevator hoistway beyond the line of the landing sill, except for

- (a) equipment required for interlocking, indicator and signal devices, door operating devices, door guiding devices, and door retaining devices
- (b) vertical slide entrances

2.11.6 Opening of Hoistway Doors

2.11.6.1 When the car is within the unlocking zone, the hoistway doors shall be openable by hand from within the car without the use of tools.

2.11.6.2 Means shall not be provided for locking out of service the doors at

- (a) the top terminal landing
- (b) the bottom terminal landing
- (c) the designated and alternate landings for elevators equipped with Phase I Emergency Recall Operation, when Phase I is effective
- (d) no landing for elevators equipped with Phase II Emergency In-Car Operation when Phase II is effective

2.11.6.3 Egress from the interior of the car to any elevator landing by means of the car and hoistway doors shall be unrestricted once the car and hoistway doors are open. Additional doors or devices, that are not part of nor function with the elevator but are provided in lieu of an enclosed elevator lobby in order to guard (13)

against the migration of smoke in or out of the hoistway, shall comply with the following:

- (a) The building code.
- (b) The additional door or device, in any position, shall not interfere with the function and operation of the elevator.
- (c) The additional door or device shall not interfere with the fire-resistance rating and operation of the hoistway entrance. Direct or mechanical attachment (i.e., welding, holes, bolts, or rivets) shall not be made to hoistway doors or frames, unless the additional door or device and the hoistway elevator entrance are listed as a complete assembly by a certifying organization.
- (d) Additional doors or devices when in the closed position shall not prevent firefighters from visually observing the elevator landing (lobby) when the elevator hoistway door is no more than one-quarter open.
- (e) Additional doors or devices shall be permitted to be deployed only at those hoistway openings of elevators where fire alarm initiating devices used to initiate Phase I Emergency Recall Operation associated with that elevator have been activated.

NOTE: It is recommended that all additional doors or devices deployed in front of hoistway doors shall be cleared (returned to open/standby position) by authorized or emergency personnel prior to removing the elevator from Phase I Emergency Recall Operation and returning to normal operation. It is recommended in the case of an unintended deployment, authorized personnel should return doors to the open or standby position.

2.11.6.4 Handles or other means provided for operation of manually operated doors shall be so located that it is not necessary to reach the back of any panel, jamb, or sash to operate them.

2.11.7 Glass in Hoistway Doors

Glass in hoistway doors shall conform to 2.11.7.1 and 2.11.7.2.

2.11.7.1 Vision Panels. Manually operated or self-closing hoistway doors of the vertically or horizontally sliding type, for elevators with automatic or continuous-pressure operation, shall be provided with a vision panel. Vision panels shall not be required at landings of automatic operation elevators where a hall position indicator is provided. In multisection doors, the vision panel is required in one section only, but is permitted to be placed in all sections. All horizontally swinging elevator doors shall be provided with vision panels. Vision panels are permitted for any type of hoistway door.

Where required or used, vision panels shall conform to 2.11.7.1.1 through 2.11.7.1.7.

2.11.7.1.1 The area of any single vision panel shall be not less than 0.015 m² (24 in.²), and the total area of one or more vision panels in any hoistway door shall be not more than 0.055 m² (85 in.²).

2.11.7.1.2 Each clear panel opening shall reject a ball 150 mm (6 in.) in diameter.

2.11.7.1.3 Muntins used between panel sections shall be of noncombustible material and of substantial construction.

2.11.7.1.4 Panel opening shall be glazed with either of the following:

- (a) clear wire glass not less than 6 mm (0.25 in.)
- (b) other transparent glazing material not less than 6 mm (0.25 in.) thick that meets the impact safety standard 16 CFR Part 1201 or CAN/CGSB-12.1, CAN/CGSB-12.11, or CAN/CGSB-12.12, whichever is applicable (see Part 9)

2.11.7.1.5 The center of the panel shall be located not less than 1 300 mm (51 in.) and not more than 1 700 mm (67 in.) above the landing, except that for vertically sliding biparting counterbalanced doors, it shall be located to conform to the dimensions specified insofar as the door design will permit.

2.11.7.1.6 Vision panels in power-operated doors shall be substantially flush with the surface of the landing side of the door.

2.11.7.1.7 Vision panels shall be protected by protective grilles made of steel not less than 1.4 mm (0.055 in.) thick, in accordance with the following specifications:

- (a) Grilles shall be sized to fit within or over the vision panel frame and completely cover the vision panel opening in the hoistway door.
- (b) Grilles shall be secured by means that deter removal by common tools.
- (c) Grilles shall contain openings that shall be not larger than 19 mm × 19 mm (0.75 in. × 0.75 in.) in diameter. Such openings shall be spaced at 25 mm (1 in.) center-to-center.
- (d) Grille edges shall be free of burrs and beveled.
- (e) Grilles shall be installed on the hoistway side of the door.

2.11.7.2 Glass Doors. Where provided, glass hoistway doors shall conform to 2.11.7.2.1 through 2.11.7.2.5.

2.11.7.2.1 The glass shall be laminated glass conforming to 16 CFR Part 1201 or CAN/CGSB-12.1. Markings as specified in the applicable standard shall be on each separate piece of glass and shall remain visible after installation.

2.11.7.2.2 The glass shall be not less than 60% of the total visible door panel surface area as seen from the landing side of the doors. Door lap shall not be used in calculating glass size.

2.11.7.2.3 In power-operated doors, the glass panel shall be substantially flush with the surface of the landing side of the door.

2.11.7.2.4 A nonglass edge shall be provided on the leading edge of the door panel.

2.11.7.2.5 The glass door shall conform to 2.11.11.5.7 for horizontally sliding type entrances, 2.11.12.4 for vertically sliding type entrances, or 2.11.13.3 for swinging entrances.

2.11.8 Weights for Closing or Balancing Doors

Hoistway door weights, where used for closing or balancing doors, shall be guided or restrained to prevent them from coming out of their runway. The bottom of the guides or other restraining means shall be so constructed as to retain the weights if the weight suspension means breaks.

2.11.9 Hoistway Door Locking Devices and Power Operation

2.11.9.1 Locking Devices. Doors shall be provided with door locking devices conforming to 2.12.

2.11.9.2 Power Operation. Where hoistway doors are power operated or are opened or closed by power, their operation shall conform to 2.13.

2.11.10 Landing-Sill Guards, Landing-Sill Illumination, Hinged Landing Sills, and Tracks on Landings

2.11.10.1 Landing-Sill Guards

2.11.10.1.1 Landing sills shall be guarded on the underside with guard plates of smooth metal not less than 1.4 mm (0.055 in.) thick, extending the full width of the car sill exposed to the landing entrance, and securely fastened in place. Landing-sill guards are not required for

- (a) vertically sliding biparting counterbalanced doors
- (b) vertically sliding counterweighted doors that slide down to open
- (c) elevators where the landing sills do not project into the hoistway

2.11.10.1.2 Where a car leveling device is provided and the hoistway edge of the sill is either flush with or projects into the hoistway, the guard shall have a straight vertical face extending below the sill not less than the depth of the leveling zone plus 75 mm (3 in.). Where the sill projects inward from the hoistway enclosure, the bottom of the guard shall also be beveled at an angle of not less than 60 deg and not more than 75 deg from the horizontal, or the guard shall be extended from the hoistway edge of the landing sill to the top of door hanger pocket of the entrance next below.

2.11.10.1.3 Where no car leveling device is provided and the sill projects inward from the general line of the hoistway, the guard shall be either beveled at an angle of not less than 60 deg and not more than 75 deg from the horizontal, or have a straight vertical face

extending from the hoistway edge of the landing sill to the top of door hanger pocket of the entrance below.

2.11.10.1.4 A horizontal door guiding groove with a maximum width of 10 mm (0.375 in.) shall be permitted at the transition of the landing-sill guard and the landing sill, provided the following requirements are met:

- (a) door power pre-opening in accordance with 2.13.2.2.2 shall not be permitted
- (b) leveling/re-leveling shall be initiated before vertical exposure of the groove is revealed
- (c) where exposure to the groove is revealed, the car shall not re-level with open doors
- (d) edges forming the groove shall be configured to prevent hazards

2.11.10.2 Illumination at Landing Sills. The building corridors shall be so lighted that the illumination at the landing sills, when an elevator is in service, shall be not less than 100 lx (10 fc).

2.11.10.3 Hinged Hoistway Landing Sills. Hinged hoistway landing sills provided in connection with vertically sliding, biparting, counterbalanced doors of freight elevators shall be hinged on the landing side so that they can be lowered only when the landing doors are in the fully opened position.

2.11.11 Entrances, Horizontal Slide Type

2.11.11.1 Landing Sills. Landing sills shall (13)

- (a) be of metal and of sufficient strength to support the loads to be carried by the sills when loading and unloading the car, and be secured in place
- (b) be substantially flush with the floor surface of the elevator landings
- (c) be so designed and maintained as to provide a secure foothold over the entire width of the door opening
- (d) be permitted to include the corresponding member of a bottom guiding means (see 2.11.11.5.7 and 2.11.11.6)

2.11.11.2 Hangers, Tracks, and Track Supports. Hangers, tracks, and their supports and fastenings for doors shall be constructed to withstand, without damage or appreciable deflection, an imposed static load equal to four times the weight of each panel as applied successively downward and upward at the vertical centerline of the panel. (See 2.11.11.5.7 and 2.11.11.5.8.)

2.11.11.3 Entrance Frames

2.11.11.3.1 Where used, entrance frames shall be anchored to the sills and to the building structure or the track supports. The head of the entrance frame shall not be used to support the weight of the wall over the frame.

2.11.11.3.2 Where decorative material is applied to listed/certified frames, it shall conform to the requirements of the certifying organization.

2.11.11.4 Hangers. Hangers shall conform to 2.11.11.4.1 and 2.11.11.4.2.

2.11.11.4.1 Means shall be provided to prevent the hangers from jumping the track.

2.11.11.4.2 Stops shall be provided in the entrance assembly to prevent hangers from overrunning the end of the track.

2.11.11.5 Panels. Panels shall conform to 2.11.11.5.1 through 2.11.11.5.8.

2.11.11.5.1 The panels shall overlap the top and sides of the opening, and each other, in the case of multispeed entrances, by not less than 13 mm (0.5 in.).

Where entrances without frames are used, the overlap shall extend the thickness of the facing used to finish the opening plus 13 mm (0.5 in.) or more.

2.11.11.5.2 The clearance shall not exceed 10 mm (0.375 in.) between

- (a) the panel and the frame
- (b) the panel and the wall, where entrances without frames are used in masonry or concrete
- (c) related panels of multispeed entrances
- (d) the panel and the sill measured vertically

2.11.11.5.3 The leading panel edge of side-opening entrances shall not close into pockets in the strike jamb and shall be smooth and free of sharp projections.

2.11.11.5.4 The meeting panel edges of center-opening entrances shall be smooth and free of sharp projection.

The meeting panel edges of center-opening entrances shall be protected with not less than one resilient male member extending the full height of the panel. The resilient members shall be permitted to interlock by not more than 10 mm (0.375 in.).

When in the closed position, the distance between the metal parts of the meeting panels shall not exceed 13 mm (0.5 in.).

2.11.11.5.5 No areas shall be depressed or raised more than 3 mm (0.125 in.) from the adjacent area and edges shall be beveled at not more than 30 deg to the panel surface.

2.11.11.5.6 Where decorative material is applied to listed/certified panels, it shall conform to the requirements of the certifying organization.

2.11.11.5.7 The entrance assembly shall be capable of withstanding a force of 2 500 N (560 lbf) applied on the landing side at right angles to and approximately at the center of a panel. This force shall be distributed over an area of approximately 100 mm × 100 mm

(4 in. × 4 in.). There shall be no appreciable permanent displacement or deformation of any parts of the entrance assembly resulting from this test.

2.11.11.5.8 Means shall be provided to prevent opening of locked doors more than 20 mm (0.8 in.) per panel at the farthest point from the interlock when a force of 135 N (30 lbf) is applied in the opening direction at the leading edge of the door at the farthest point from the interlock.

2.11.11.6 Bottom Guides. Bottom guides shall conform to the following:

- (a) The bottom of each panel shall be guided by one or more members.
- (b) Guide members shall be securely fastened.
- (c) The guide members and any reinforcements or guards shall engage the corresponding member by not less than 6 mm (0.25 in.). (See 2.11.11.5.7.)

2.11.11.7 Multipanel Entrances. Panels of multipanel doors shall conform to either 2.11.11.7.1 or 2.11.11.7.2. Multiple-speed and center-opening multiple-speed doors shall also conform to 2.11.11.7.3.

2.11.11.7.1 Panels shall be interconnected directly or through their hangers so as to assure simultaneous movement of all panels. The factor of safety of the interconnecting means shall not be less than 10 for cast iron or 5 for other materials.

2.11.11.7.2 Panels shall be equipped with hoistway door interlocks on each driven panel and provided with a door closer(s) installed to comply with 2.11.3.1. All panels shall move simultaneously when the car is at the landing.

2.11.11.7.3 Multiple-speed and center-opening multiple-speed panels shall be provided with secondary mechanical interconnecting means to ensure that individual panels of multiple panel doors moving in the same direction cannot become separated from the panel that is locked by the interlock in the event that the normal interconnecting means fails.

2.11.11.7.4 Where cable and pulleys are used to connect panels of multisection sliding doors, each pulley shall be equipped with a guard to prevent the cable from leaving the pulley.

2.11.11.8 Hoistway Door Safety Retainers. The top and bottom of horizontally sliding doors shall be provided with a means of retaining the closed door panel in position if the primary guiding means fail, and preventing displacement of the door panel top and bottom by more than 20 mm (0.8 in.) when the door panel is subjected to a force of 5 000 N (1,125 lbf) in the direction of the hoistway applied at right angles to the panel over an area of 300 mm × 300 mm (12 in. × 12 in.) at the approximate center of the panel.

The retaining means shall also withstand, without detachment or permanent deformation, a force of 1 000 N (225 lbf) applied upward at any point along the width of the door panel and, while this force is maintained, an additional force of 1 100 N (250 lbf) applied at right angles to the door at the center of the panel. This force shall be distributed over an area of 300 mm × 300 mm (12 in. × 12 in.).

The retaining means shall not be subjected to wear or stress during normal door operation or maintenance.

2.11.11.9 Beams, Walls, Floors, and Supports. The building structural supports of the entrance, such as building beams, walls, and floors, shall be designed to withstand the horizontal forces stipulated in 2.11.11.8.

2.11.11.10 Hoistway Door to Sill Clearance. The horizontal distance from the hoistway side of the leading edge of the hoistway door, or sight guard, if provided, to the edge of the landing sill, shall not exceed 13 mm (0.5 in.). The vertical clearance between the sight guard, if provided, and the landing sill shall not exceed 13 mm (0.5 in.).

2.11.12 Entrances, Vertical Slide Type

2.11.12.1 Landing Sills

2.11.12.1.1 Landing sills shall be of metal and of sufficient strength to support the loads to be carried by the sills when loading and unloading the car, and be secured in place (see 2.16.2.2 for classes of loading); the load on the sill during loading and unloading shall be considered to be the same as that on the platform members specified in 8.2.2.6.

2.11.12.1.2 Landing sills shall be secured to the building structure in substantially the same plane as the elevator landing floor.

2.11.12.2 Entrance Frames. Where used, frames shall conform to 2.11.12.2.1 through 2.11.12.2.4.

2.11.12.2.1 Entrance frames shall be anchored to the sills and to the building structure or track supports.

2.11.12.2.2 The weight of the wall above the frame shall be supported by either of the following:

- (a) lintel
- (b) the head of the frames when designed to support the load

2.11.12.2.3 In gypsum board (dry wall) construction, the frame side jambs shall be extended and securely fastened to the building structure above the frame.

2.11.12.2.4 Where decorative material is applied to listed/certified frames, it shall conform to the requirements of the certifying organization.

2.11.12.3 Rails. The panel guide rails shall be securely fastened to the building structure and the

entrance frame, at intervals, throughout their entire length.

Rails and their supports shall withstand the forces specified in 2.11.12.4.6. Where truckable sills are provided as specified in 2.11.12.4.2, the rails shall withstand any reactions that could be transmitted to the rails as a result of loading and unloading operations.

2.11.12.4 Panels. Panels shall conform to 2.11.12.4.1 through 2.11.12.4.8.

2.11.12.4.1 The panels shall be constructed of noncombustible material, or of a structural core made of combustible material if covered with not less than 0.45 mm (0.0175 in.) sheet metal.

2.11.12.4.2 The lower panel of biparting entrances and the top of the panel of vertical slide entrances that slide down to open shall be provided with a truckable sill designed for the loads specified in 2.11.12.1.1. Provisions shall be made to transmit the panel sill load to the building structure.

2.11.12.4.3 Panels of biparting counterbalanced entrances shall conform to the following:

(a) They shall be provided with means to stop the closing panels when the distance between the closing rigid members of the panel is not less than 20 mm (0.8 in.) and not more than 50 mm (2 in.).

(b) A fire-resistive, nonshearing, and noncrushing member of either the meeting or overlapping type shall be provided on the upper panel to close the distance between the rigid door sections when in contact with the stops. This member shall allow a minimum compressible clearance of 20 mm (0.8 in.).

(c) Rigid members that overlap the meeting edge, and center-latching devices, are prohibited.

2.11.12.4.4 The panels, with their attachments for doors that slide up to open, shall overlap the sides and top of the entrance opening by at least 50 mm (2 in.) when in the closed position. Other vertically sliding panels and their attachments shall overlap their entrance openings and sills by at least 50 mm (2 in.) when in the closed position. The overlap shall extend at least 50 mm (2 in.) beyond the thickness of any facing used to finish the opening.

2.11.12.4.5 The clearance between a panel and the frame lintel, between a panel and the sill, and between related panels of multispeed entrances, shall not exceed 25 mm (1 in.).

2.11.12.4.6 Panels, rails, and door guides shall conform to the strength requirements of 2.11.11.5.7. Hangers, guides, and guide shoes shall not be permanently displaced or deformed by more than 20 mm (0.8 in.) when their panel is subjected to a force of 5 000 N (1,125 lbf) in the direction of the hoistway applied at right angles to the panel over an area of

300 mm × 300 mm (12 in. × 12 in.) at the approximate center of the panel.

2.11.12.4.7 Means shall be provided to close the opening between the upper panel of pass-type entrances and the entrance frame lintel. The sum of the clearance between the panel, the device used to close the opening, and the entrance lintel shall not exceed 25 mm (1 in.).

2.11.12.4.8 Means shall be provided to prevent the opening of locked doors more than 25 mm (1 in.) per panel at the farthest point from the interlock when a force of 135 N (30 lbf) is applied in the opening direction at the leading edge of the door at the farthest point from the interlock.

2.11.12.5 Guides. Panel guides shall conform to 2.11.12.5.1 through 2.11.12.5.3.

2.11.12.5.1 Each panel shall be equipped with not less than four guide members or with continuous guides.

2.11.12.5.2 Guide members shall be securely fastened to the panels.

2.11.12.5.3 Guide members shall be designed to withstand the forces specified in 2.11.12.4.6.

2.11.12.6 Counterweighting or Counterbalancing. Single or multisection vertically sliding panels shall be so counterweighted, and vertically sliding biparting panels shall be so counterbalanced, that they will not open or close by gravity.

Fastenings shall be provided to prevent the fall of a counterweight, and the detachment or dislodgment of counterweight parts or of balancing weights. Suspension means and their connections, for vertically sliding biparting counterbalanced doors and for the counterweights of vertically sliding counterweighted doors, shall have a factor of safety of not less than 5.

2.11.12.7 Sill Guards. Where the panel sill or other structural member projects more than 13 mm (0.5 in.) into the hoistway or beyond the panel surface below it, the projection shall be provided with a metal guard not less than 1.4 mm (0.055 in.) thick and beveled at an angle of not less than 50 deg and not more than 75 deg from the horizontal.

2.11.12.8 Pull Straps. Manually operated vertically sliding biparting entrances shall be provided with pull straps on the inside and outside of the door.

The length of the pull straps shall conform to 2.11.12.8.1 and 2.11.12.8.2.

2.11.12.8.1 The bottom of the strap shall be not more than 2 000 mm (79 in.) above the landing when the panel is in the fully opened position.

2.11.12.8.2 The length of the strap shall not be extended by means of ropes or other materials.

2.11.13 Entrances, Swinging Type

2.11.13.1 Landing Sills. Landing sills shall

(a) be of metal and of sufficient strength to support the loads to be carried by the sills when loading and unloading the car, and be secured in place

(b) be substantially flush with the floor surface of the elevator landings

(c) be so designed and maintained as to provide a secure foothold over the entire width of the door opening

2.11.13.2 Entrance Frames. Frames shall conform to 2.11.13.2.1 and 2.11.13.2.2.

2.11.13.2.1 They shall be designed to support in place the panels with their hinges or pivots, closer if attached to the frame and interlock. They shall withstand the forces referred to in 2.11.13.3.5, and the forces resulting from the normal opening of the door or normal attempts to open it when locked in the closed position.

2.11.13.2.2 Where decorative material is applied to listed/certified panels, it shall conform to the requirements of the certifying organization.

2.11.13.3 Panels. Panels shall conform to 2.11.13.3.1 through 2.11.13.3.7.

2.11.13.3.1 The panels shall overlap the part of the frame against which they close by not less than 13 mm (0.5 in.).

2.11.13.3.2 The clearance between a panel and its sill shall not exceed 10 mm (0.375 in.).

2.11.13.3.3 Handles or knobs on the hoistway side of door panels are not permitted. Unlatching devices that do not project beyond the face of the door panel on the hoistway side shall be permitted.

2.11.13.3.4 Where decorative material is applied to listed/certified panels, it shall conform to the requirements of the certifying organization.

2.11.13.3.5 Panels and their assembled accessories shall

(a) be capable of withstanding a force on the handle of not less than 450 N (100 lbf) in the opening direction of a closed and locked door. There shall be no permanent displacement or deformation of the handle or the door panel resulting from this force.

(b) conform to 2.11.11.5.7.

(c) not be permanently displaced or deformed by more than 20 mm (0.75 in.) when the panel is subjected to a force of 5 000 N (1,125 lbf) in the direction of the hoistway, applied at right angles to the panel over an area of 300 mm × 300 mm (12 in. × 12 in.) at the approximate center of the panel.

2.11.13.3.6 Center-opening horizontally swinging doors shall have one door section provided with an overlapping astragal on its vertical edge, except where

each door section is provided with a landing door interlock [see 2.12.2.4.4(c)].

2.11.13.3.7 Center-opening horizontally swinging doors shall have door stops provided at the top entrances that will stop each door panel when closed and that will meet the requirements specified in 2.11.13.3.5.

2.11.13.4 Hinges. Hinges of the mortise and surface type shall conform to the requirements of NFPA 80, Table 2-4.3.1.

2.11.13.5 Entrances With Combination Horizontally Sliding and Swinging Panels. Where both the sliding and swinging panels are not equipped with hoistway door interlocks or locks and contacts conforming to 2.12, the horizontally sliding and swinging panels forming a part of the entrance shall be so interconnected that

- (a) the swinging panel can be opened only when the sliding panel is in the open position
- (b) both panels swing as a unit

2.11.14 Fire Tests

2.11.14.1 In jurisdictions enforcing the NBCC

(a) the fire-protection rating of entrances and doors shall be determined in accordance with the requirements specified in the NBCC (CAN4-S104)

(b) where required, the hoistway door interlock mechanism and associated wiring shall remain operational for a period of 1 h when subjected to the standard fire exposure test described in CAN4-S104

NOTE (2.11.14.1): Requirements 2.11.14.2 through 2.11.18 do not apply in jurisdictions enforcing the NBCC.

2.11.14.2 In jurisdictions not enforcing the NBCC, 2.11.15 through 2.11.18, and 2.11.14.2.1 through 2.11.14.2.3 apply where fire-resistive construction is required by 2.1.1.1.3.

2.11.14.2.1 Entrances shall be subjected to the type tests specified in 8.3.4.

2.11.14.2.2 The following basic types of entrances shall be tested:

- (a) *Horizontally Sliding Type.* Test a side-sliding and a center-opening assembly.
- (b) *Swinging Type.* Test a single swinging assembly.
- (c) *Vertically Sliding Type.* Test a biparting assembly.

2.11.14.2.3 When an entrance assembly has been tested for one type of wall construction, i.e., masonry or drywall, only the frame-to-wall interface shall be acceptable to the certifying organization for other types of construction.

2.11.15 Marking

2.11.15.1 Labeling of Tested Entrance Assembly.

In jurisdictions not enforcing the NBCC, a single label listing covered components included per 2.11.15.1.1, or

separate labels on all individual components per 2.11.15.1.2 shall be provided.

2.11.15.1.1 Each entrance shall be labeled. Each label shall be permanently attached to the equipment and shall be readily visible after installation. The following data shall be on the label:

- (a) certifying organization's name or identifying symbol
- (b) the name, trademark, or file number by which the organization that manufactured the product can be identified
- (c) statement of compliance with 8.3.4
- (d) a list of the component items found in the definition of Entrance Assembly that are covered by the label

2.11.15.1.2 Labels, conforming to 2.11.15.1.1(a) and (b), shall be provided for each entrance as follows:

- (a) One label shall be provided for each door panel.
- (b) Each frame shall be labeled, except where frames are installed in masonry or concrete and the panel overlaps the wall in conformance with 2.11.11.5.1 and 2.11.11.5.2, or 2.11.12.4.4.

(1) One label shall be provided for each section of a frame, or for each piece of a knockdown frame; or

(2) A single label shall be provided for the entire frame where the label states that it includes both the fixed side panels and the transom

(c) One label shall be provided for the frame, except that no label is required where frames are installed in masonry or concrete and the panel overlaps the wall in conformance with 2.11.11.5.1 and 2.11.11.5.2, or 2.11.12.4.4.

(d) A single label may be provided for the entire entrance assembly where components are equivalent to those tested as a complete assembly.

2.11.15.1.3 Where the entrance hardware assembly has been tested in a complete entrance assembly, a single label, conforming to 2.11.15.1.1, shall be provided for the entrance hardware assembly.

2.11.15.1.4 Where a component of the entrance hardware assembly has not been tested as part of the complete assembly, a label conforming to 2.11.15.1.1 shall be applied to the component.

2.11.15.2 Other Entrance Assemblies. In jurisdictions not enforcing the NBCC, the following shall apply. Other entrance assemblies of the three basic types (see 2.11.14) shall qualify for labeling or listing/certification:

(a) when composed of panel(s), frame, and hardware of the same type as tested and not exceeding the overall height and width of any panel and frame of the largest size tested; or

(b) when such panel(s), frame, and hardware are modified, and test or technical data demonstrates that the modifications will meet the performance requirements of the test procedure in 8.3.3.

All other elements of the assembly shall conform to all other applicable requirements of this Code.

2.11.15.3 Entrances Larger Than Tested Assemblies. In jurisdictions not enforcing the NBCC, the following shall apply. When the entrance is too large for the regularly available test facilities, the certifying organization shall be permitted to issue oversize certificates or oversize labels, or such entrances shall be permitted to be used subject to approval by the authority having jurisdiction.

2.11.16 Factory Inspections

In jurisdictions not enforcing the NBCC, the following shall apply. The manufacturing facilities for the production of entrances or components thereof shall be inspected by the certifying organization at random at least quarterly, or if they are not manufactured on a continuous basis, at the time they are being produced, to assure that production methods are such that entrances or components thereof similar to those tested are being produced.

2.11.17 Transoms and Fixed Side Panels

In jurisdictions not enforcing the NBCC, the following shall apply. Transoms and fixed side panels shall be permitted to close openings above and beside the horizontally sliding or horizontally swinging type entrances, provided that

(a) the opening closed by the transom and fixed side panel does not exceed in width or height the dimensions of the entrance in which it is installed

(b) the transom panels and fixed side panels are

(1) constructed in a manner equivalent to the construction of the entrance panels

(2) secured

2.11.18 Installation Instructions

In jurisdictions not enforcing the NBCC, the following shall apply:

(a) Instructions detailing the application and installation of door listed/certified panels and entrance hardware shall be provided.

(b) Where frames are used, instructions detailing the listed/certified frame-to-wall interface shall be provided.

2.11.19 Gasketing of Hoistway Entrances

Where gasketing material is applied to entrances with a fire-protection rating, it shall conform to 2.11.19.1 through 2.11.19.4.

2.11.19.1 The gasketing material shall be subjected to the tests specified in UL 10B, NFPA 252, or CAN4-S104, whichever is applicable (see Part 9).

2.11.19.2 The gasketing material shall withstand the maximum elevated temperature tests as defined by ANSI/UL 1784 standard without deterioration.

2.11.19.3 Each section of the gasketing material shall be labeled. Each label shall bear the name of the manufacturer certifying agency, and a statement indicating conformance with 2.11.19.1 and 2.11.19.2. The label shall be visible after installation. (13)

2.11.19.4 Labeled gasketing material shall conform to 2.11.16 or the NBCC, whichever is applicable.

NOTES (2.11.19):

(1) See also 2.1.1.5, 2.11.3, and 2.13.4 for additional requirements to be considered when gasketing material is applied to a hoistway entrance.

(2) These requirements do not evaluate the air and/or smoke leakage performance of the gasketing material.

SECTION 2.12 HOISTWAY DOOR LOCKING DEVICES AND ELECTRIC CONTACTS, AND HOISTWAY ACCESS SWITCHES

2.12.1 General

2.12.1.1 When the car is stopped within the unlocking zone, the hoistway doors shall be unlocked, or locked but openable from the landing side either manually or by power.

2.12.1.2 When the car is outside the unlocking zone, the hoistway doors shall be openable from the landing side only by a hoistway door unlocking device (see 2.12.6, 2.12.7, and Nonmandatory Appendix B).

2.12.1.3 For security purposes, hoistway doors shall be permitted to be locked out of service, subject to the requirements of 2.11.6.

2.12.1.4 Passenger elevator hoistway doors shall be equipped with interlocks conforming to 2.12.2.

2.12.1.5 Freight elevator hoistway doors shall be equipped with interlocks conforming to 2.12.2 or combination mechanical locks and electric contacts conforming to, and where permitted by, 2.12.3.

2.12.2 Interlocks

2.12.2.1 General. Each entrance at a landing to an elevator used for passengers or freight and not conforming to 2.12.3.1 shall be equipped with one or more interlocks meeting the design requirements of 2.12.2.4.

2.12.2.2 Closed Position of Hoistway Doors. Hoistway doors shall be considered to be in the closed position under the following conditions. These dimensions apply to the doors in their normal operating condition (see 2.14.4.11):

(a) for horizontally sliding or swinging doors, when the leading edge of the door is within 10 mm (0.375 in.) of the nearest face of the jamb or when the panels of center-opening doors are within 10 mm (0.375 in.) of contact with each other

(b) for vertically sliding counterweighted doors, when the leading edge of the door is within

10 mm (0.375 in.) of the sill for doors that slide up to open, or 10 mm (0.375 in.) of the lintel for doors that slide down to open

(c) for vertically sliding biparting counterbalanced doors, when the astragal on the upper panel is within 19 mm (0.75 in.) of the lower panel

2.12.2.3 Operation of the Driving Machine With a Hoistway Door Unlocked or Not in the Closed Position.

Operation of the driving machine when a hoistway door is unlocked or not in the closed position (see 2.12.2.2) shall be permitted under one of the following conditions:

(a) by a car leveling or truck zoning device (see 2.26.1.6)

(b) when a hoistway access switch is operated (see 2.12.7)

(c) when a bypass switch is activated (see 2.26.1.5)

2.12.2.4 General Design Requirements. Interlocks shall conform to 2.12.2.4.1 through 2.12.2.4.7.

2.12.2.4.1 Interlock contacts shall be positively opened by the locking member or by a member connected to and mechanically operated by the locking member, and the contacts shall be maintained in the open position by the action of gravity, or by a restrained compression spring, or by both, or by means of the opening member (see 2.26.2.14). Contacts shall be open when the hoistway door interlock is unlocked. If the contacts are maintained in the open position by other than the locking member, the interlock shall be located such that the contacts cannot be manually closed from the car or landing when the doors are open.

The electrical contact bridging means shall withstand a separating force of 200 N (45 lbf) in any direction from the locking member.

2.12.2.4.2 The locking member of the interlock shall hold the door in the locked position by means of gravity, or by a restrained compression spring, or by both, or by means of a positive linkage.

2.12.2.4.3 The interlock shall lock the door in the closed position with a minimum engagement of 7 mm (0.28 in.) of the locking members before the interlock contacts are closed and before the driving machine can be operated, except as permitted in 2.12.2.3.

Devices that permit operation of the driving machine by the normal operating device when the door is closed but before it is locked are not interlocks and are not permitted where interlocks are required by this Code.

2.12.2.4.4 Interlocks, used with multisection doors, shall conform to the following requirements:

(a) They shall lock all sections of the door, but shall be permitted to be applied to only one section of the door, provided the device used to interconnect the door sections is so arranged that locking one section will prevent the opening of all sections.

(b) Where used with vertically sliding biparting counterbalanced doors, they shall be so arranged that the interlock contacts are mechanically held in the open position by the door or devices attached thereto, unless the door is in the closed position.

(c) Where used with center-opening horizontally swinging doors, either

(1) both door panels shall be equipped with interlocks; or

(2) where the door panels are so arranged that one panel can be opened only after the other panel has been opened, the interlock is not required on the section that opens last, if that door panel is provided with a door electric contact conforming to 2.14.4.2.3, 2.14.4.2.5, and 2.26.2.15, except that terms "door or gate" and "car door or gate" shall be replaced with the term "hoistway door" or "hoistway door section" and the term "accessible from inside the car panel" with the term "accessible from the landing side when the hoistway doors are closed."

(d) Where used with combination horizontally sliding and swinging doors, either

(1) the sliding and swinging panels shall both be equipped with interlocks; or

(2) where the sliding and swinging panels are interconnected in conformity with the requirements of 2.11.13.5, the interlock is not required on the swinging panel, provided that the interlock on the sliding panel is so designed and installed that the car cannot be operated unless the sliding and swinging panels are both locked in the closed position, as defined in 2.12.2.2.

(e) Where a door closer, used with a combination sliding and swinging door, is arranged to be disconnected to allow the sliding panel to swing, it shall be so designed and installed that it shall not make the interlock contact when disconnected and released.

2.12.2.4.5 Interlock systems employing a single master switch for more than one door are prohibited.

2.12.2.4.6 Mercury tube switches shall not be used.

2.12.2.5 Interlock Retiring Cam Device. Retiring cams used to actuate an interlock shall exert a force at least double the average force required to operate the interlock and shall have a movement at least 13 mm (0.5 in.) more than the average movement required to operate the interlock.

An interlock retiring cam device shall be permanently marked by the manufacturer with its rated horizontal force and rated horizontal movement.

The rated horizontal force shall be the static force exerted by a retiring cam device in the horizontal direction when extended a distance equal to 75% of its rated horizontal movement. The rated horizontal movement shall be the horizontal distance traveled by the retiring cam device from the fully retired position to the fully extended position.

2.12.2.6 Location. Interlocks shall be so located that they are not accessible from the landing side when the hoistway doors are closed.

2.12.3 Hoistway Door Combination Mechanical Locks and Electric Contacts

2.12.3.1 Where Permitted. Hoistway door combination mechanical locks and electric contacts shall be permitted only on freight elevators equipped with manually operated vertically sliding doors and only at the following landings:

(a) the top terminal landing and the landing whose sill is located not more than 1 225 mm (48 in.) below the top terminal landing sill, provided that the elevator rise does not exceed 4 570 mm (15 ft)

(b) any landing whose sill is within 1 525 mm (60 in.) of the pit floor, regardless of the elevator rise

2.12.3.2 Closed Position of Hoistway Doors.

Hoistway doors shall be considered to be in the closed position under the following conditions. These dimensions apply to the doors in their normal operating condition (see also 2.14.4.11):

(a) for vertically sliding counterweighted doors, when the leading edge of the door is within 10 mm (0.375 in.) of the sill for doors that slide up to open, or 10 mm (0.375 in.) of the lintel for doors that slide down to open

(b) for vertically sliding biparting counterbalanced doors, when the astragal on the upper panel is within 19 mm (0.75 in.) of the lower panel

2.12.3.3 Operation of the Driving Machine With a Hoistway Door Not in the Closed Position. Operation of the driving machine when a hoistway door is not in the closed position shall be permitted under one of the following conditions:

(a) by a car leveling or truck zoning device (see 2.12.2.2 and 2.26.1.6)

(b) when a hoistway access switch is operated (see 2.12.7)

(c) when bypass switch is activated (see 2.26.1.5)

2.12.3.4 General Design Requirements. Combination mechanical locks and electric contacts shall conform to 2.12.3.4.1 through 2.12.3.4.6.

2.12.3.4.1 They shall be so designed that the locking member and the electric contact are mounted on and attached to a common base, in such a manner that there is a fixed relation between the location of the contact and the location of the locking member.

They shall be so installed and adjusted that the electric contact cannot close until the door is in the closed position as specified in 2.12.3.2, and so that the locking member is in a position to lock the door when or before the contact closes. In order to prevent motion of the door from opening the electric contact while the door is locked

in the closed position, multiple-locking points shall, where necessary, be provided on the locking mechanism.

2.12.3.4.2 The electric contact shall be positively opened by the locking bar of the mechanical lock or by a lever or other device attached to and operated by the door, and the electric contact shall be maintained in the open position by the action of gravity or by a restrained compression spring, or by both, or by positive mechanical means. (See 2.26.2.14.)

2.12.3.4.3 The mechanical lock shall hold the door in the locked position by means of gravity or by a restrained compression spring, or by both.

2.12.3.4.4 Combination mechanical locks and electric contacts used with vertical-slide multiple-panel doors shall conform to the following requirements:

(a) They shall lock all panels of the door, but shall be permitted to be applied to only one section of the door, provided the device used to interconnect the door sections is so arranged that locking one panel will prevent the opening of all panels.

(b) Where used with vertically sliding biparting counterbalanced doors, the electric contact shall be so arranged that it is mechanically held in the open position by the door or a device attached thereto, unless the door is in the closed position.

2.12.3.4.5 Mercury tube switches shall not be used.

2.12.3.5 Location. Combination mechanical locks and electric contacts shall be so located that they are not accessible from the landing side when the hoistway doors are closed.

2.12.4 Listing/Certification Door Locking Devices and Door or Gate Electric Contacts

2.12.4.1 Type Tests. Each type and make of hoistway door interlock, hoistway door combination mechanical lock and electric contact, and door or gate electric contact, shall conform to the type tests specified in 8.3.3, unless tested prior to

(a) August 1, 1996, and shall have been subjected to the tests specified in A17.1a-1994, Section 1101; or

(b) March 23, 2002 in jurisdictions enforcing CSA B44 and shall have been subjected to the tests specified in CSA B44S1-97, Clause 11.4.

The tests shall be done by or under the supervision of a certifying organization.

2.12.4.2 Listing/Certification. Each type and make of hoistway door interlock, hoistway door combination mechanical lock and electric contact, and door or gate electric contact shall conform to the general requirements for tests and certification specified in 8.3.1.

- (ED) **2.12.4.3 Identification Marking.** Each listed/certified device shall be labeled. It shall be permanently attached to the device, and shall be so located as to be readily visible when the device is installed in its operating position.

The labels shall include the following data:

- (a) the name, trademark, or certifying organization file number by which the organization that manufactured the product can be identified
- (b) the certifying organization name or identifying symbol
- (c) statement of compliance with ASME A17.1/CSA B44
- (d) a distinctive type, model, or style letter or number
- (e) rated voltage and current, and whether AC or DC
- (f) rated test force and rated test movement when the device is of a type released by an interlock retiring cam (see 8.3.3.4.7)
- (g) date (month and year) devices subjected to type test specified in 2.12.4.1
- (h) if the device has only been type tested and listed/certified for use on a private residence elevator, the label shall indicate the restricted use

- (13) 2.12.5 DELETED; MOVED TO 2.14.5.7

2.12.6 Hoistway Door Unlocking Devices

2.12.6.1 General. Except in jurisdictions that limit the use of hoistway door unlocking devices, they shall be provided for use by elevator and emergency personnel for each elevator at every landing where there is an entrance.

2.12.6.2 Location and Design. Hoistway door unlocking devices shall conform to 2.12.6.2.1 through 2.12.6.2.5.

2.12.6.2.1 The device shall unlock and permit the opening of a hoistway door from a landing irrespective of the position of the car.

2.12.6.2.2 The device shall be designed to prevent unlocking the door with common tools.

2.12.6.2.3 Where a hoistway unlocking device consists of an arrangement whereby a releasing chain, permanently attached to a door locking mechanism, is kept under a locked panel adjacent to the landing door, such a panel shall be self-closing and self-locking and shall not have identifying markings on its face.

2.12.6.2.4 The hoistway door unlocking device shall be Group 1 Security (see 8.1). The operating means shall also be made available to emergency personnel during an emergency.

2.12.6.2.5 The unlocking device keyway and locked panel (see 2.12.6.2.3), if provided, shall be located

at a height not greater than 2 100 mm (83 in.) above the landing.

2.12.7 Hoistway Access Switches

2.12.7.1 General

2.12.7.1.1 Hoistway access switches shall be provided when the rated speed is greater than 0.75 m/s (150 ft/min) at

- (a) the lowest landing when a separate pit access door is not provided
- (b) the top landing

2.12.7.1.2 For elevators with a rated speed of 0.75 m/s (150 ft/min) or less, a hoistway access switch shall be provided at the top landing when the distance from the top of the car to the landing sill exceeds 900 mm (35 in.) when the car platform is level with the landing immediately below the top landing.

2.12.7.1.3 When one or more hoistway access switches are provided but not required, the switch(es) shall be provided at the landing(s) specified in 2.12.7.1.1. Additional hoistway access switches shall be permitted at other landings only when switches specified in 2.12.7.1.1 have been provided.

2.12.7.2 Location and Design. Hoistway access switches shall conform to 2.12.7.2.1 through 2.12.7.2.3.

2.12.7.2.1 The switch shall be installed adjacent to the hoistway entrance at the landing with which it is associated. The switch shall be labeled "ACCESS" and shall be a three-position switch, labeled "UP," "OFF," and "DOWN" (in that order), with the "OFF" position as the center position. The switch shall be rotated clockwise to go from the "UP" to "OFF" to "DOWN" positions. (13)

2.12.7.2.2 The switch shall be of the continuous-pressure spring-return type, and shall be operated by a cylinder-type lock having not less than a five-pin or five-disk combination, with the key removable only when the switch is in the "OFF" position. The key shall be Group 1 Security (see 8.1).

2.12.7.2.3 The switch shall (13)

- (a) use contacts that are positively opened mechanically; their openings shall not be solely dependent on springs, or
- (b) be SIL rated with an SIL equal to or greater than the SIL indicated for the applicable device shown in Table 2.26.4.3.2

2.12.7.3 Hoistway Access Operation. Hoistway access operation shall conform to 2.12.7.3.1 through 2.12.7.3.4. (13)

2.12.7.3.1 Except as permitted in 2.26.1.4.3(d), a separate switch labeled "ACCESS" with two positions labeled "OFF" and "ENABLE" shall be provided in the

car and shall be key operated or behind a locked cover. The key shall be Group 1 Security (see 8.1).

2.12.7.3.2 When in the “ENABLE” position the elevator shall be on hoistway access operation and shall conform to the following:

- (a) operation by car and landing operating devices shall be disabled
- (b) automatic power operation of the hoistway door and/or car door or gate shall be disabled
- (c) automatic operation by a car-leveling device shall be disabled
- (d) stopping the car at the access landing by a car-leveling device while operating a hoistway access switch at the landing shall be permitted
- (e) enable the hoistway access switches at the landing and their operation in accordance with 2.12.7.3.3 except where either top-of-car inspection operation (see 2.26.1.4.2) or in-car inspection operation (see 2.26.1.4.3) is in effect

2.12.7.3.3 The operation of a hoistway access switch at the landing shall permit movement of the car with the hoistway door located adjacent to the switch at the landing unlocked or not in the closed position, and with only the car door or gate associated with this hoistway door unlocked or not in the closed position, subject to the following requirements:

- (a) The operation of the hoistway access switch at the landing shall not render ineffective the hoistway door interlock or electric contact at any other landing, nor shall the car move if any other hoistway door is unlocked.
- (b) The car shall not be operated at a speed greater than 0.75 m/s (150 ft/min). For elevators with static control, a means independent from the normal means to control the speed shall be provided to limit the speed of the car on hoistway access operation to a maximum of 0.75 m/s (150 ft/min), should the normal means to control this speed (mechanical, electrical, or solid-state devices) fail to do so.

The car speed-sensing device used for the means to limit the speed of the car while operating in response to an access switch shall be permitted to be either a separate car speed-sensing device from that of the normal speed control system or the same car speed-sensing device, provided that a separate means is used to continuously verify the proper operation of this speed-sensing device. Where the same car speed-sensing device is used, the detection of a failure of this car speed-sensing device while operating in response to an access switch shall cause the power to be removed from the driving-machine motor and brake.

The car speed-sensing device(s) and, where required, the verification means described above, shall conform to the following:

- (1) a common actuating means (e.g., a driving-machine shaft, brake drum, etc.) shall be permitted provided that it is not dependent on the following connection types, unless the connection is continuously monitored:
 - (a) traction (excluding the traction between the drive sheave and suspension means and the traction between the governor and governor rope)
 - (b) friction (except for interference fits), or
 - (c) a flexible coupling where positive engagement is not assured between coupling halves.

Where monitoring is required, the monitoring shall detect a failure that prevents conformance with this requirement while operating in response to an access switch and shall cause the electric power to be removed from the elevator driving-machine motor and brake.

- (2) a common member (e.g., tape, target, wire, etc.) that is sensed by both speed-sensing devices shall be permitted, provided that

- (a) the member is monitored such that when its presence is not detected while operating in response to an access switch, this shall cause the electric power to be removed from the elevator driving-machine motor and brake

- (b) the common member is securely mounted in such a manner that horizontal movement of the car shall not affect the operation of the sensors

- (3) a common mounting means shall be permitted

- (c) The movement of the car initiated and maintained by the hoistway access switch at the lowest landing, if this landing is the normal means of access to the pit, shall be limited in the up direction to the point where the bottom of the platform guard is even with hoistway entrance header.

- (d) The movement of the car initiated and maintained by the access switch at a landing other than the lowest landing shall be limited in the down direction to a travel not greater than the height of the car crosshead above the car platform, and limited in the up direction to the distance the platform guard extends below the car platform.

- (e) the hoistway access switch at the landing shall only control the movement of the car within the zone specified in 2.12.7.3.3(c) or 2.12.7.3.3(d). Control circuits related to, or operated by, the hoistway access switches shall comply with 2.26.9.3(c), (d), and (e) and 2.26.9.4.

2.12.7.3.4 When in the “OFF” position, the “ACCESS” switch in the car shall disable hoistway access operation by means of the hoistway access switches at the landings.

SECTION 2.13 POWER OPERATION OF HOISTWAY DOORS AND CAR DOORS

2.13.1 Types of Doors and Gates Permitted

Where both a hoistway door and a car door or gate are opened and/or closed by power, the hoistway door and the car door or gate shall both be either of the horizontally sliding type or vertically sliding type.

2.13.2 Power Opening

2.13.2.1 Power Opening of Car Doors or Gates.

Power opening of a car door or gate shall be subject to the requirements of 2.13.2.1.1 and 2.13.2.1.2.

- (13) **2.13.2.1.1** Power opening shall occur only at the landing where the car is stopping, or is leveling, or at rest, and shall start only when the car is within the unlocking zone where an automatic car-leveling device is provided, except that on freight elevators with vertically sliding doors and static control, power shall not be applied to open car doors until the car is within 300 mm (12 in.) of the landing.

2.13.2.1.2 Collapsible car gates shall not be power opened to a distance exceeding one-third of the clear gate opening, and in no case more than 250 mm (10 in.).

2.13.2.2 Power Opening of Hoistway Doors. Power opening of a hoistway door shall conform to 2.13.2.2.1 through 2.13.2.2.3.

- (13) **2.13.2.2.1** Power opening shall occur only at the landing where the car is stopping, leveling, or at rest, and shall start only when the car is within the unlocking zone where an automatic car-leveling device is provided, except that on freight elevators with vertically sliding doors and static control, opening shall not start until the car is within 300 mm (12 in.) of the landing.

2.13.2.2.2 Power opening shall be permitted to be initiated automatically through control circuits, provided that the car is being automatically stopped or leveled, and that, when stopping under normal operating conditions, the car shall be at rest or substantially level with the landing before the hoistway door is fully opened.

2.13.2.2.3 Sequence opening of vertically sliding hoistway doors and adjacent car doors or gates shall comply with 2.13.6.

2.13.3 Power Closing

2.13.3.1 Power Closing or Automatic Self-Closing of Car Doors or Gates Where Used With Manually Operated or Self-Closing Hoistway Doors

2.13.3.1.1 Where a car door or gate of an automatic or continuous-pressure operation passenger elevator is closed by power, or is of the automatically

released self-closing type, and faces a manually operated or self-closing hoistway door, the closing of the car door or gate shall not be initiated unless the hoistway door is in the closed position, and the closing mechanism shall be so designed that the force necessary to prevent closing of a horizontally sliding car door or gate from rest is not more than 135 N (30 lbf).

2.13.3.1.2 Requirement 2.13.3.1.1 does not apply where a car door or gate is closed by power through continuous pressure of a door closing switch, or of the car operating device, and where the release of the closing switch or operating device will cause the car door or gate to stop or to stop and reopen.

2.13.3.2 Power Closing of Horizontally Sliding Hoistway Doors and Horizontally Sliding Car Doors or Gates by Continuous-Pressure Means. Horizontally sliding hoistway doors with manually closed, or power-operated, or power-closed horizontally sliding car doors or gates shall be permitted to be closed by continuous-pressure means, subject to the requirements of 2.13.3.2.1 through 2.13.3.2.4.

2.13.3.2.1 The release of the closing means shall cause the hoistway door, and a power-operated or power-closed car door or gate, to stop or to stop and reopen.

2.13.3.2.2 The operation of the closing means at any landing shall not close the hoistway door at any other landing, nor the car door or gate when the elevator car is at any other landing.

2.13.3.2.3 Any closing means at a landing shall close only that hoistway door and the car door or gate at the side where such means is located.

2.13.3.2.4 For elevators having more than one hoistway opening at any landing level, a separate closing means shall be provided in the car for each car door or gate and its adjacent hoistway door, except that a separate closing means need not be furnished for a horizontally sliding hoistway door and adjacent car door or gate that conform to 2.13.4.

2.13.3.3 Power Closing of Horizontally Sliding Hoistway Doors and Horizontally Sliding Car Doors or Gates by Momentary Pressure or by Automatic Means.

Power closing by momentary pressure or by automatic means shall be permitted only for automatic or continuous-pressure operation elevators. The closing of the doors shall be subject to the requirements of 2.13.3.3.1 and 2.13.3.3.2.

2.13.3.3.1 The closing of the doors shall conform to 2.13.4.

2.13.3.3.2 A momentary pressure switch or button shall be provided in the car, the operation of which shall cause the doors to stop or to stop and reopen.

The switch or button shall be identified as required by 2.26.12.

2.13.3.4 Power Closing of Vertically Sliding Hoistway Doors and Vertically Sliding Car Doors or Gates

2.13.3.4.1 Vertically sliding hoistway doors with manually closed, or power-operated, or power-closed vertically sliding car doors or gates, where closed by continuous-pressure means, shall conform to 2.13.3.4.1(a) through (e).

(a) The release of the continuous-pressure closing means shall cause the hoistway door, and a power-operated or power-closed car door or gate to immediately initiate a reversal, and to fully reopen. Reopening by release of the continuous-pressure closing means shall be permitted to be disabled when the hoistway door is within 250 mm (10 in.) of full close.

(b) The continuous-pressure closing means shall not close the hoistway door, car door, or gate at any other landing.

(c) Any continuous-pressure closing means at a landing shall close only that hoistway door and the car door or gate at the entrance where such means is located. The continuous-pressure closing means shall be located where the full opening of the door that it controls is visible.

(d) For elevators having more than one hoistway opening at any landing level, a separate continuous-pressure closing means shall be provided in the car for each car door or gate and its adjacent hoistway door. The continuous-pressure closing means shall be located adjacent to the door(s) or gate(s) that it controls.

(e) Where a door close button or switch is provided, it shall be labeled "CLOSE."

2.13.3.4.2 Vertically sliding hoistway doors with power-operated vertically sliding car doors or gates shall be permitted to be closed by momentary pressure or automatic means only for automatic or continuous-pressure operation elevators.

2.13.3.4.3 Power-operated vertically sliding doors shall have a door open means conforming to the following:

(a) A momentary-pressure door open switch or button labeled "OPEN" shall be provided at each landing and in the car which when operated shall cause the car door or gate and hoistway door at the landing to immediately initiate a reversal, and to fully reopen or reopen by a distance of not less than 300 mm (12 in.). The markings shown in Table 2.26.12.1 do not apply.

(b) The door open switch or button shall not open the hoistway door, car door, or gate at any other landing.

(c) Any door open switch or button at a landing shall open only that hoistway door and the car door or gate at the entrance where such means is located. The opening switch or button shall be located adjacent to the door(s) or gate(s) that it controls.

(d) For elevators having more than one hoistway opening at any landing level, a separate door open switch or button shall be provided in the car for each car door or gate and its adjacent hoistway door.

2.13.3.4.4 The average closing speed shall not exceed 0.3 m/s (1 ft/s) for a vertical slide-up to open hoistway door or for each panel of a vertically sliding biparting hoistway door, and shall not exceed 0.6 m/s (2 ft/s) for a vertically sliding car door or gate.

2.13.3.4.5 Vertical slide-up to open hoistway doors with power-operated vertical slide-up to open car doors or gates without sequence operation (see 2.13.6) shall conform to 2.13.3.4.5(a) through (c), 2.13.3.4.8, and 2.13.3.4.9.

(a) Device(s) shall be provided that detect an object in the shape of a rectangular prism measuring 170 mm (6.75 in.) high, with a base 140 mm (5.5 in.) wide and 140 mm (5.5 in.) deep, oriented with the base parallel to the floor and the width parallel to the face of the door, in the following locations:

(1) anywhere within the opening width of the hoistway door and car door or gate when located immediately adjacent to the vertical plane established by the landing side of the hoistway door and where the object is located wholly within a vertical zone extending from the landing floor to a horizontal plane at

(a) 1 880 mm (74 in.) above the floor; or

(b) the leading edge of the door if the leading edge is less than 1 880 mm (74 in.) above the floor

(2) anywhere within the opening width of the hoistway door and car door or gate when located immediately adjacent to the vertical plane established by the car side of the car door or gate and where the object is located wholly within a vertical zone extending from the car floor to a horizontal plane at

(a) 1 880 mm (74 in.) above the floor; or

(b) the leading edge of the door if the leading edge is less than 1 880 mm (74 in.) above the floor.

NOTE [2.13.3.4.5(a)]: See Nonmandatory Appendix S, Figs. S-1 and S-2.

(b) Device(s) shall be provided that detect an object in the shape of a rectangular prism measuring 400 mm (16 in.) high, with a base 210 mm (8.25 in.) wide and 210 mm (8.25 in.) deep, oriented with the base parallel to the floor and the width parallel to the face of the door in the following location:

(1) anywhere within the opening width of the hoistway door and car door or gate when wholly or partially located between the vertical planes established by the landing side of the hoistway door and the car side of the car door or gate, and wholly located between horizontal planes at 480 mm (19 in.) above the car floor or landing floor and at

(a) 1 500 mm (59 in.) above the associated car or landing floor; or

(b) the leading edge of the door if the leading edge is less than 1 500 mm (59 in.) above the floor

NOTE [2.13.3.4.5(b)]: See Nonmandatory Appendix S, Fig. S-3.

(c) Device(s) shall be provided that detect an object in the shape of a rectangular prism measuring 50 mm (2 in.) high, with a base 95 mm (3.75 in.) wide and 125 mm (5 in.) deep, oriented with the base parallel to the floor and the width parallel to the face of the door anywhere within the opening width of the car door or gate that is located on the car floor immediately adjacent to the vertical plane established by the car side of the lower panel of the car door or gate.

Detection device(s) shall not be required when the car door or gate is provided with

(1) a means to stop the closing panel when the distance between rigid members of the panel and the car platform is not less than 50 mm (2 in.) when fully closed, and

(2) a nonshearing, noncrushing member on the leading edge of the panel that shall provide a minimum clearance at full compression of 50 mm (2 in.) when fully closed

NOTE [2.13.3.4.5(c)]: See Nonmandatory Appendix S, Fig. S-4.

2.13.3.4.6 Vertical slide-up to open hoistway doors with power-operated vertical slide-up to open car doors or gates with sequence operation (see 2.13.6) shall conform to 2.13.3.4.6(a) through (g), 2.13.3.4.8, and 2.13.3.4.9.

(a) Closing in compliance with 2.13.6.1.2 shall be provided.

(b) A yellow and black diagonally striped hazard-warning of not less than 38 mm (1.5 in.) wide shall be provided along the landing side leading edge of the lowermost hoistway door panel.

(c) Device(s) shall be provided that detect an object in the shape of a rectangular prism measuring 170 mm (6.75 in.) high, with a base 140 mm (5.5 in.) wide and 140 mm (5.5 in.) deep, oriented with the base parallel to the floor and the width parallel to the face of the door, in the following locations:

(1) anywhere within the opening width of the car door or gate when located immediately adjacent to the vertical plane established by the landing side of the car door or gate and where the object is located wholly within a vertical zone extending from the car floor to a horizontal plane at

(a) 1 880 mm (74 in.) above the floor; or

(b) the leading edge of the door if the leading edge is less than 1 880 mm (74 in.) above the floor.

NOTE [2.13.3.4.6(c)(1)]: See Nonmandatory Appendix S, Fig. S-5.

(2) anywhere within the opening width of the hoistway door and car door or gate when located immediately adjacent to the vertical plane established by the car side of the car door or gate and where the object is

located wholly within a vertical zone extending from the car floor to a horizontal plane at

(a) 1 880 mm (74 in.) above the floor; or

(b) the leading edge of the door if the leading edge is less than 1 880 mm (74 in.) above the floor

NOTE [2.13.3.4.6(c)(2)]: See Nonmandatory Appendix S, Fig. S-2.

(d) Device(s) shall be provided that detect an object in the shape of a rectangular prism measuring 400 mm (16 in.) high, with a base 210 mm (8.25 in.) wide and 210 mm (8.25 in.) deep, oriented with the base parallel to the floor and the width parallel to the face of the door in the following location:

(1) anywhere within the opening width of the hoistway door and car door or gate when wholly or partially located between the vertical planes established by the landing side of the car door or gate and the car side of the car door or gate, and wholly located between horizontal planes at 480 mm (19 in.) above the car floor and at

(a) 1 500 mm (59 in.) above the car floor; or

(b) the leading edge of the door if the leading edge is less than 1 500 mm (59 in.) above the floor

NOTE [2.13.3.4.6(d)]: See Nonmandatory Appendix S, Fig. S-6.

(e) Device(s) shall be provided that detect an object in the shape of a rectangular prism measuring 50 mm (2 in.) high, with a base 95 mm (3.75 in.) wide and 125 mm (5 in.) deep, oriented with the base parallel to the floor and the width parallel to the face of the door anywhere within the opening width of the car door or gate that is located on the car floor immediately adjacent to the vertical planes established by the car side and the landing side of the lower panel of the car door or gate.

Detection device(s) shall not be required when the car door or gate is provided with

(1) a means to stop the closing panel when the distance between rigid members of the panel and the car platform is not less than 50 mm (2 in.), and

(2) a nonshearing, noncrushing member that shall provide a minimum clearance at full compression of 50 mm (2 in.) when in contact with the stops

NOTE [2.13.3.4.6(e)]: See Nonmandatory Appendix S, Figs. S-4 and S-7.

(f) A continuously sounding audible signal shall be provided with a sound level of 10 dBA minimum above ambient but shall not exceed 90 dBA when measured at the landing with car door or gate closed, which shall sound 5 s prior to car door or gate closing and continue to sound until the hoistway door is fully closed.

(g) A flashing visual signal shall be provided that is visible from the landing with the car door or gate closed and shall light 5 s prior to car door or gate closing and continue to light until the hoistway door is fully closed.

2.13.3.4.7 Vertical biparting hoistway doors with power-operated car doors or gates shall conform to 2.13.3.4.7(a) through (g), 2.13.3.4.8, and 2.13.3.4.9.

(a) Closing in compliance with 2.13.6.1.2 shall be provided.

(b) The closing speed of each biparting hoistway panel shall be limited to a maximum of 0.15 m/s (0.5 ft/s) when the closing panels are 250 mm (10 in.) or less from full close.

(c) A yellow and black diagonally striped hazard-warning of not less than 38 mm (1.5 in.) wide shall be provided along the landing side leading edge of the lowermost hoistway door panel.

(d) Device(s) shall be provided that detect an object in the shape of a rectangular prism measuring 170 mm (6.75 in.) high, with a base 140 mm (5.5 in.) wide and 140 mm (5.5 in.) deep, oriented with the base parallel to the floor and the width parallel to the face of the door, in the following locations:

(1) anywhere within the opening width of the car door or gate when located immediately adjacent to the vertical plane established by the landing side of the car door or gate and where the object is located wholly within a vertical zone extending from the car floor to a horizontal plane at

(a) 1 880 mm (74 in.) above the floor; or

(b) the leading edge of the door if the leading edge is less than 1 880 mm (74 in.) above the floor

NOTE [2.13.3.4.7(d)(1)]: See Nonmandatory Appendix S, Fig. S-8.

(2) anywhere within the opening width of the car door or gate when located immediately adjacent to the vertical plane established by the car side of the car door or gate and where the object is located wholly within a vertical zone extending from the car floor to a horizontal plane at

(a) 1 880 mm (74 in.) above the floor; or

(b) the leading edge of the door if the leading edge is less than 1 880 mm (74 in.) above the floor

NOTE [2.13.3.4.7(d)(2)]: See Nonmandatory Appendix S, Fig. S-9.

(e) Device(s) shall be provided that detect an object in the shape of a rectangular prism measuring 400 mm (16 in.) high, with a base 210 mm (8.25 in.) wide and 210 mm (8.25 in.) deep, oriented with the base parallel to the floor and the width parallel to the face of the door in the following location:

(1) anywhere within the opening width of the car door or gate when wholly or partially located between the vertical planes established by the landing side of the car door or gate and the car side of the car door or gate, and wholly located between horizontal planes at 480 mm (19 in.) above the car floor and at

(a) 1 500 mm (59 in.) above the car floor; or

(b) the leading edge of the door if the leading edge is less than 1 500 mm (59 in.) above the floor

NOTE [2.13.3.4.7(e)]: See Nonmandatory Appendix S, Fig. S-10.

(f) Device(s) shall be provided that detect an object in the shape of a rectangular prism measuring 50 mm (2 in.) high, with a base 95 mm (3.75 in.) wide and 125 mm (5 in.) deep, oriented with the base parallel to the floor and the width parallel to the face of the door anywhere within the opening width of the car door or gate that is located on the car floor immediately adjacent to the vertical planes established by the car side and the landing side of the lower panel of the car door or gate.

Detection device(s) shall not be required when the car door or gate is provided with

(1) a means to stop the closing panel when the distance between rigid members of the panel and the car platform is not less than 50 mm (2 in.), and

(2) a nonshearing, noncrushing member that shall provide a minimum clearance at full compression of 50 mm (2 in.) when in contact with the stops

NOTE [2.13.3.4.7(f)]: See Nonmandatory Appendix S, Fig. S-11.

(g) Device(s) shall be provided that detect an object in the shape of a rectangular prism measuring 50 mm (2 in.) high, with a base of 250 mm (10 in.) wide and 95 mm (3.75 in.) deep, oriented with the base parallel to the floor and the width parallel to the face of the door, that is located on the car floor anywhere within the horizontal distance between the car side of the hoistway door to the vertical plane of the landing side of the car door or gate, measured at 50 mm (2 in.) above the car floor.

Detection device(s) shall not be required when the horizontal distance from the car side of the fully open hoistway door measured at the hoistway door sill to the vertical plane of the landing side of the fully closed car door or gate measured at 50 mm (2 in.) above the car floor, is less than 95 mm (3.75 in.).

NOTE [2.13.3.4.7(g)]: See Nonmandatory Appendix S, Fig. S-12.

2.13.3.4.8 If an object has been detected in accordance with 2.13.3.4.5(a), (b), or (c), 2.13.3.4.6(c), (d), or (e), or 2.13.3.4.7(d), (e), (f), or (g), where applicable, the hoistway door and car door or gate shall not close, or if closing, shall cause the car door or gate and the hoistway door at the landing to immediately initiate a reversal, and to fully reopen or reopen by a distance of not less than 300 mm (12 in.).

2.13.3.4.9 After the door has reached its fully opened position and before door closing is initiated, the device(s) used to comply with 2.13.3.4.5(a), (b) or (c); 2.13.3.4.6(c), (d), or (e); or 2.13.3.4.7(d), (e), (f), or (g), where applicable, shall be checked to assure that it is capable of sensing the defined objects and sending the appropriate signal to the control that initiates the starting, stopping, and direction of motion of the door(s). If the device(s) is incapable of sensing the defined object

or sending the appropriate signal, power closing of the door(s) or gate(s) shall be rendered inoperative.

2.13.3.4.10 When building conditions would render ineffective or nonoperational the detection means required by 2.13.3.4.5(a), (b), or (c), 2.13.3.4.6(c), (d), or (e), or 2.13.3.4.7(d), (e), (f), or (g), the following shall be provided in lieu of compliance with 2.13.3.4.5(a), (b), or (c), 2.13.3.4.6(c), (d), or (e), or 2.13.3.4.7(d), (e), (f), or (g):

(a) continuous-pressure closing of the car door or gate and hoistway door in compliance with 2.13.3.4.1

(b) usage shall be limited to authorized personnel only. A sign in compliance with 2.16.5.2 shall be provided but shall read: "THIS IS A FREIGHT ELEVATOR, NOT A PASSENGER ELEVATOR, AND NOT FOR PUBLIC USE. NO PERSONS OTHER THAN AUTHORIZED PERSONNEL ARE PERMITTED TO OPERATE THIS ELEVATOR."

(c) sequence operation in compliance with 2.13.6.1

(d) the average closing speed of the car door or gate shall be limited to 0.20 m/s (0.67 ft/s)

NOTE (2.13.3.4.10): Such building conditions include but are not limited to environments with high levels of particulates, environments impacted by detector emissions, large opening widths, excessive cold, wash down environments, etc.

2.13.4 Closing Limitations for Power-Operated Horizontally Sliding Hoistway Doors and Horizontally Sliding Car Doors or Gates

2.13.4.1 Where Required. Where a power-operated horizontally sliding hoistway door or car door/gate or both is closed by momentary pressure or by automatic means (see 2.13.3.3), or is closed simultaneously with another door or car door/gate or both from one continuous-pressure means (see 2.13.3.2.3 and 2.13.3.2.4), the closing mechanism shall be designed and installed to conform to 2.13.4.2 and the reopening device shall be designed and installed to conform to 2.13.5.

2.13.4.2 Closing Mechanism

2.13.4.2.1 Kinetic Energy

(a) Where the hoistway door and the car door/gate are closed in such a manner that stopping either one manually will stop both, the kinetic energy of the closing door system shall be based upon the sum of the hoistway and the car door weights, as well as all parts rigidly connected thereto, including the rotational inertia effects of the door operator and the connecting transmission to the door panels.

(b) Where a reopening device conforming to 2.13.5 is used, the closing door system shall conform to the following requirements:

(1) The kinetic energy computed for the actual closing speed at any point in the Code zone distance defined by 2.13.4.2.2 shall not exceed 23 J (17 ft-lbf).

(2) The kinetic energy computed for the average closing speed as determined in accordance with 2.13.4.2.2 shall not exceed 10 J (7.37 ft-lbf).

(c) Where a reopening device is not used, or has been rendered inoperative (see 2.13.5), the closing door system shall conform to the following requirements:

(1) The kinetic energy computed for the actual closing speed at any point in the Code zone distance defined by 2.13.4.2.2 shall not exceed 8 J (6 ft-lbf).

(2) The kinetic energy computed for the average closing speed within the Code zone distance (see 2.13.4.2.2), or in any exposed opening width, including the last increment of door travel, shall not exceed 3.5 J (2.5 ft-lbf).

2.13.4.2.2 Door Travel in the Code Zone Distance

(a) For all side sliding doors using single or multiple-speed panels, the Code zone distance shall be taken as the horizontal distance from a point 50 mm (2 in.) away from the open jamb to a point 50 mm (2 in.) away from the opposite jamb.

(b) For all center-opening sliding doors using single or multiple-speed panels, the Code zone distance shall be taken as the horizontal distance from a point 25 mm (1 in.) away from the open jamb to a point 25 mm (1 in.) from the center meeting point of the doors.

(c) The average closing speed shall be determined by measuring the time required for the leading edge of the door to travel the Code zone distance.

2.13.4.2.3 Door Force.

The force necessary to prevent closing of the hoistway door (or the car door or gate if power operated) from rest shall not exceed 135 N (30 lbf) (see 2.13.3.1). This force shall be measured on the leading edge of the door with the door at any point between one-third and two-thirds of its travel.

2.13.4.2.4 Data Plate.

A data plate conforming to 2.16.3.3 shall be attached to the power door operator or to the car crosshead and shall contain the following information:

(a) minimum door closing time in seconds for the doors to travel the Code zone distance as specified in 2.13.4.2.2 corresponding to the kinetic energy limits specified in 2.13.4.2.1(b)(2)

(b) minimum door closing time in seconds for the doors to travel the Code zone distance as specified in 2.13.4.2.2 corresponding to the kinetic energy limits specified in 2.13.4.2.1(c)(2), if applicable [see 2.27.3.1.6(e)]

(c) where heavier hoistway doors are used at certain floors, the minimum door closing time in seconds corresponding to the kinetic energy limits specified in 2.13.4.2.1(b)(2) and 2.13.4.2.1(c)(2), if applicable, for the corresponding floors shall be included on the data plate

2.13.5 Reopening Device for Power-Operated Horizontally Sliding Car Doors or Gates

2.13.5.1 Where required by 2.13.4, a power-operated car door shall be provided with a reopening device that will function to stop and reopen a car door and the adjacent landing door sufficiently to permit passenger transfer in the event that the car door or gate is obstructed while closing. If the closing kinetic energy is reduced to 3.5 J (2.5 ft-lbf) or less, the reopening device shall be permitted to be rendered inoperative. The reopening device used shall be effective for substantially the full vertical opening of the door (see 2.13.4.2).

2.13.5.2 For center-opening doors, the reopening device shall be so designed and installed that the obstruction of either door panel when closing will cause the reopening device to function.

2.13.5.3 Where Phase I Emergency Recall Operation by a fire alarm initiating device (see 2.27.3.2.3) is not provided, door reopening devices that can be affected by smoke or flame shall be rendered inoperative after the doors have been held open for 20 s. Door closing for power-operated doors shall conform to 2.13.5.

2.13.6 Sequence Operation for Power-Operated Hoistway Doors With Car Doors or Gates

2.13.6.1 Operating Requirements. The sequence operation of a hoistway door and adjacent power-operated vertically sliding car door or gate shall conform to 2.13.6.1.1 and 2.13.6.1.2.

2.13.6.1.1 In opening, the hoistway door shall be opened at least two-thirds of its travel before the car door or gate can start to open.

2.13.6.1.2 In closing, the car door or gate shall be closed at least two-thirds of its travel before the hoistway door can start to close.

SECTION 2.14 CAR ENCLOSURES, CAR DOORS AND GATES, AND CAR ILLUMINATION

2.14.1 Passenger and Freight Enclosures, General

2.14.1.1 Enclosure Required. Elevators shall be equipped with a car enclosure.

2.14.1.2 Securing of Enclosures

2.14.1.2.1 The enclosure shall be securely fastened to the car platform and so supported that it cannot loosen or become displaced in ordinary service, on the application of the car safety, on buffer engagement, or the application of the emergency brake (see 2.19).

2.14.1.2.2 The car enclosure shall be so constructed that removable portions cannot be dismantled from within the car.

2.14.1.2.3 Enclosure linings, decorative panels, light fixtures, suspended ceilings, and other apparatus or equipment attached within the car enclosure shall be securely fastened and so supported that they will not loosen or become displaced in ordinary service, on car safety application, or on buffer engagement.

2.14.1.2.4 Panels attached to the car enclosure for decorative or other purposes shall either

(a) not be unfastened from inside the car by the use of common tools; or

(b) be permitted to be removed from inside the car when perforations, exceeding that which would reject a ball 13 mm (0.5 in.) in diameter, in the enclosure used for panel hanging or support have permanent means to prevent straight through passage beyond the running clearance.

2.14.1.3 Strength and Deflection of Enclosure Walls. The enclosure walls shall be designed and installed to withstand a force of 330 N (75 lbf) applied horizontally at any point on the walls of the enclosure without permanent deformation and so that the deflection will not reduce the running clearance below the minimum specified in 2.5.1, nor cause the deflection to exceed 25 mm (1 in.).

2.14.1.4 Number of Compartments in Passenger and Freight Elevator Cars. Cars shall not have more than two compartments. Where elevators have two compartments, one shall be located above the other, and the elevator shall conform to 2.14.1.4.1 through 2.14.1.4.6.

2.14.1.4.1 The elevator shall be used exclusively for passengers or exclusively for freight at any one time. If freight is to be carried in only one compartment, means shall be provided to lock the other compartment out of service.

2.14.1.4.2 Each compartment shall conform to the requirements of this Section, except that a trap door in the floor of the upper compartment shall provide access to the top emergency exit for the lower compartment.

2.14.1.4.3 Where either or both compartments are intended for passenger service, the minimum rated load for each compartment shall conform to 2.16.1.

Where one compartment is intended for freight use, its minimum rated load shall conform to 2.16.1 or shall be based on the freight loads to be handled, if greater than the minimum rated load required by 2.16.1.

Where both compartments are used exclusively for freight, the minimum rated load of each compartment shall conform to 2.16.2.

The rated load of the elevator shall be the sum of the rated loads of the individual compartments.

2.14.1.4.4 An emergency stop switch, where required by 2.26.2.5, shall be provided in each compartment, and these emergency stop switches shall be so

connected that the car cannot run unless both are in the run position.

2.14.1.4.5 An in-car stop switch, where required by 2.26.2.21, shall be provided in each compartment, and these switches shall be so connected that the car cannot run unless both are in the run position.

2.14.1.4.6 All hoistway doors shall be closed and locked and the car doors for each compartment closed before the car can be operated.

2.14.1.5 Top Emergency Exits. An emergency exit with a cover shall be provided in the top of all elevator cars, except cars in partially enclosed hoistways (see 2.14.1.5.2).

2.14.1.5.1 Top emergency exits shall conform to the following requirements:

(a) The top emergency exit opening shall have an area of not less than 0.26 m^2 (400 in.^2) and shall measure not less than 400 mm (16 in.) on any side.

(b) The top emergency exit and suspended ceiling opening, if any, shall be so located as to provide a clear passageway, unobstructed by fixed equipment located in or on top of the car. Equipment is permitted directly above the exit opening, provided that

(1) it is not less than 1 070 mm (42 in.) above the top of the car; or

(2) the exit is located to allow unobstructed passage of a parallelepiped volume measuring 300 mm \times 500 mm by 1 500 mm (12 in. \times 20 in. by 59 in.) at an angle not less than 60 deg from the horizontal (see Nonmandatory Appendix C).

(c) The top emergency exit cover shall open outward. It shall be hinged or securely attached with a chain when in both the open and closed positions. If a chain is used, it shall be not more than 300 mm (12 in.) in length and have a factor of safety of not less than 5. The exit cover shall only be openable from the top of the car, where it shall be openable without the use of special tools. The exit cover of the lower compartment of a multideck elevator shall be openable from both compartments. On elevators with two compartments, if the emergency exit of the lower compartment does not open directly into the upper compartment, a guarded passageway shall be provided between the lower compartment roof and the upper compartment floor.

(d) The movable portion (exit panel) of the suspended ceiling that is below the top exit opening shall be restrained from falling. It shall be permitted to be hinged upward or downward, provided that the exit permits a clear opening with the top exit opening.

(1) A minimum clear headroom of 2 030 mm (80 in.) above the car floor shall be maintained when downward-swinging suspended ceiling exit panels are used.

(2) Upward-opening suspended ceiling exit panels shall be restrained from closing when in use and shall

not diminish the clear opening area of the corresponding top exit opening.

(3) The movable portion and the fixed portion of a suspended ceiling shall not contain lamps that could be shattered by the rescue operation using the top emergency exit. The movable portion of the suspended ceiling shall be permitted to contain light fixtures connected to the stationary portion of the suspended ceiling wiring by means of a plug and socket or by flexible armored wiring. Flexible wiring shall not be used to support or restrain the exit opening in the suspended ceiling in the open position.

(e) Where elevators installed in enclosed hoistways are provided with special car top treatments such as domed or shrouded canopies, the exit shall be made accessible, including the car top refuge space as specified in 2.4.12.

(f) Immediately adjacent to the top emergency exit there shall be a space available for standing when the emergency exit cover is open. This space shall be permitted to include a portion of the refuge area (see 2.4.12). All exit covers shall be provided with a car top emergency exit electrical device (see 2.26.2.18) that will prevent operation of the elevator car if the exit cover is open more than 50 mm (2 in.), and the device shall be so designed that it

(1) is positively opened

(2) cannot be closed accidentally when the cover is removed

(3) must be manually reset from the top of the car and only after the cover is within 50 mm (2 in.) of the fully closed position

(4) shall be protected against mechanical damage

2.14.1.5.2 On elevators in partially enclosed hoistways, means shall be provided to facilitate emergency evacuation of passengers. Such means shall not require a top emergency exit. A top emergency exit shall be permitted.

2.14.1.6 Car Enclosure Tops

2.14.1.6.1 The car enclosure top shall be so designed and installed as to be capable of sustaining a load of 135 kg (300 lb) on any area 600 mm \times 600 mm (24 in. \times 24 in.), or 45 kg (100 lb) applied to any point, without permanent deformation. The resulting deflection under these loads shall be limited to prevent damage to any equipment, devices, or lighting assemblies fastened to or adjacent to the car enclosure top.

2.14.1.6.2 Two unobstructed horizontal areas, each one not less than 350 mm (14 in.) by 350 mm (14 in.), shall be provided on the car enclosure top. The two unobstructed areas shall be no closer to one another than 600 mm (24 in.), centerline to centerline, apart. The areas shall be within the projection of the car enclosure top exclusive of the area outside of a standard railing (2.10.2), where provided.

2.14.1.7 Railing and Equipment on Car Enclosure Top

2.14.1.7.1 A standard railing conforming to 2.10.2 shall be provided on the outside perimeter of the car enclosure top on all sides where the perpendicular distance between the edges of the car enclosure top and the adjacent hoistway enclosure exceeds 300 mm (12 in.) horizontal clearance and on sides where there is no hoistway enclosure. If clearances require (see 2.14.1.7.2) the standard railing to be located more than 100 mm (4 in.) from the edge of the outside perimeter of the car enclosure top, the top of the car enclosure outside of the railing shall be clearly marked. The marking shall consist of alternating 100 mm (4 in.) diagonal red and white stripes. The forces specified in 2.10.2.4 shall not deflect the railing beyond the perimeter of the car top.

The top-of-car enclosure, or other surface specified by the elevator installer, shall be the working surface referred to in 2.10.2.

2.14.1.7.2 When the car has reached its maximum upward movement (2.4.6.1), the following minimum clearances shall be provided from the top rail of the standard railing to building structure or equipment not attached to the car:

- (a) 100 mm (4 in.) vertically
- (b) 100 mm (4 in.) horizontally in the direction towards the hoistway enclosure
- (c) 300 mm (12 in.) horizontally towards the centerline of the car enclosure top

NOTE (2.14.1.7.2): See Nonmandatory Appendix G.

2.14.1.7.3 A working platform or equipment that is not required for the operation of the elevator or its appliances, except where specifically provided herein, shall not be located above the top of an elevator car.

2.14.1.7.4 Devices that detect unauthorized access to the top of the car shall be permitted. These devices shall only be permitted to initiate an alarm. Audible alarms shall not exceed 90 dBA measured 1 m (40 in.) from the source.

2.14.1.8 Glass in Elevator Cars

2.14.1.8.1 Where enclosures include panels of glass, or transparent or translucent plastic, the panels shall

(a) be constructed of laminated glass that complies with the requirements of 16 CFR Part 1201, Sections 1201.1 and 1201.2; or be constructed of laminated glass, safety glass, or safety plastic that comply with CAN/CGSB-12.1, CAN/CGSB-12.11, or CAN/CGSB-12.12, whichever is applicable (see Part 9)

(b) be provided with a handrail or framing designed to guard the opening should the panel become detached, where wall panels are wider than 300 mm (12 in.)

(c) be mounted in the structure so that the assembly shall withstand the required elevator tests without damage (see 2.14.1.2)

2.14.1.8.2 Glass used for lining walls or ceilings shall conform to 2.14.1.8.1(a) and (c), except that tempered glass shall be permitted, provided that

(a) it conforms to ANSI Z97.1, 16 CFR Part 1201, Sections 1201.1 and 1201.2, or CAN/CGSB-12.1, whichever is applicable (see Part 9)

(b) the glass is not subjected to further treatment such as sandblasting, etching, heat treatment, painting, etc., that could alter the original properties of the glass

(c) the glass is bonded to a nonpolymeric coating, sheeting, or film backing having a physical integrity to hold the fragments when the glass breaks

(d) the glass is tested and conforms to the acceptance criteria for laminated glass as specified in ANSI Z97.1, or 16 CFR Part 1201, Section 1201.4, or CAN/CGSB-12.11, whichever is applicable (see Part 9)

2.14.1.8.3 Markings as specified in the applicable glazing standard shall be on each separate piece, and shall remain visible after installation.

2.14.1.9 Equipment Inside Cars

2.14.1.9.1 Apparatus or equipment not used in connection with the function or use of the elevator shall not be installed inside of any elevator car, except as follows:

- (a) Support rails (handrails) are permitted.
- (b) Fastening devices for padded protective linings are permitted.
- (c) Lift hooks, conveyor tracks, and support beams for freight handling, mounted in the ceiling of passenger elevator, shall clear the car floor to a height of 2 450 mm (96 in.) (see 2.16.9).
- (d) Picture frames, graphic display boards, plaques, and other similar visual displays shall be mounted to withstand the required elevator tests without damage. All edges shall be beveled or rounded. The material shall conform to 2.14.1.2 and 2.14.2.1. When attached to the car wall less than 2 130 mm (84 in.) above the floor, projections from the car wall, excluding support rails, shall not be greater than 38 mm (1.5 in.).
- (e) Conveyor tracks shall be permitted in freight elevators cars.
- (f) Heating equipment, ventilating fans, and air-conditioning equipment, if used, shall be securely fastened in place and located above the car ceiling or outside the enclosure.

2.14.1.9.2 Passenger car floors shall have no projections or depressions greater than 6 mm (0.25 in.).

2.14.1.10 Side Emergency Exits. Side emergency exits are prohibited.

2.14.2 Passenger-Car Enclosures

2.14.2.1 Material for Car Enclosures, Enclosure Linings, and Floor Coverings. All materials exposed to

the car interior and the hoistway shall be metal, glass, or shall conform to 2.14.2.1.1 through 2.14.2.1.4.

2.14.2.1.1 In jurisdictions not enforcing NBCC

(a) materials in their end-use configuration, other than those covered by 2.14.2.1.1(b) and (c), 2.14.2.1.3, and 2.14.2.1.4, shall conform to the following requirements, based on the tests conducted in accordance with the requirements of ASTM E84, ANSI/UL 723, or CAN/ULC-S102:

- (1) flame spread rating of 0 to 75
- (2) smoke development of 0 to 450

(b) napped, tufted, woven, looped, and similar materials in their end-use configuration on car enclosure walls shall conform to 8.3.7. The enclosure walls to which this material is attached shall conform to 2.14.2.1.1(a).

(c) floor covering, underlayment, and its adhesive shall have a critical radiant flux of not less than 0.45 W/cm^2 , as measured by ASTM E648.

(13) 2.14.2.1.2 In jurisdictions enforcing the NBCC

(a) materials in their end-use configuration, other than those covered by 2.14.2.1.2(b), 2.14.2.1.3, and 2.14.2.1.4, shall conform to the following requirements, based on the tests conducted in accordance with the requirements of ASTM E84, ANSI/UL 723, or CAN/ULC-S102:

- (1) flame spread rating of 0 to 75
- (2) smoke development classification of 0 to 450

(b) floor surfaces shall have a flame spread rating of 0 to 300, with a smoke development classification of 0 to 450, based on the test conducted in accordance with the requirements of CAN/ULC-S102.2

2.14.2.1.3 Padded protective linings, for temporary use in passenger cars during the handling of freight, shall be of materials conforming to either 2.14.2.1.1(a) or (b) or 2.14.2.1.2(a), whichever is applicable. The protective lining shall clear the floor by not less than 100 mm (4 in.).

2.14.2.1.4 Handrails, operating devices, ventilating devices, signal fixtures, audio and visual communication devices, and their housings are not required to conform to 2.14.2.1.

2.14.2.2 Openings Prohibited. Openings or hinged or removable panels in an enclosure are prohibited, other than as required for the following:

- (a) signal, operating, and communication equipment
- (b) entrances
- (c) vision panels
- (d) top emergency exit
- (e) ventilation
- (f) access panels for cleaning of glass on observation elevators (see 2.14.2.6)

(g) equipment access panels for maintenance and inspection of equipment shall conform to the following requirements (see also 2.7.5.1.4):

- (1) be of hinged type.
- (2) open only into the car.

(3) be provided with a lock so arranged that the door shall be openable from inside the car only by a specially shaped removable key. Locks shall be so designed that they cannot be opened from the inside by the use of ordinary tools or instruments. Keys shall be Group 1 Security (see 8.1).

(4) be provided with electric contacts that conform to 2.14.4.2.3(b) through (e) and 2.26.2.35, and are located so as to be inaccessible from the inside of the car. When opened, the contact shall cause power to be removed from the driving-machine motor and brake.

(5) be of the same material and construction as required for the enclosure.

2.14.2.3 Ventilation

2.14.2.3.1 Natural ventilation openings conforming to the following shall be provided in car enclosures:

(a) Openings exposed to the inside of the car shall not be located in the portion of the enclosure walls extending from a point 300 mm (12 in.) above the floor to a point 1 825 mm (72 in.) above the floor.

(b) Openings less than 300 mm (12 in.) above the floor shall reject a ball 25 mm (1 in.) in diameter and be guarded to prevent straight-through passage.

(c) Openings above the 1 825 mm (72 in.) level shall reject a ball 50 mm (2 in.) in diameter and be guarded to prevent straight-through passage.

(d) Openings in the car ceiling shall be protected and shall conform to 2.14.1.6.

(e) The total area of natural ventilation openings shall be not less than 3.5% of the inside car floor area divided equally between the bottom and top of the car enclosure.

(f) The total unrestricted opening in or around the car doors or gates shall be permitted to be included as part of the total natural ventilation required.

(g) The unrestricted opening provided by forced ventilation systems shall be permitted to be part of the natural ventilation area on the part of the car in which it is located.

2.14.2.3.2 Ventilating fans or blowers, if used, shall be located above the car ceiling or outside the enclosure and shall be securely fastened in place.

2.14.2.3.3 Forced ventilation conforming to the following shall be provided on observation elevators with glass walls exposed to direct sunlight:

(a) There shall be a minimum air handling capacity to provide one air change per minute based on net inside car volume.

(b) An auxiliary power source capable of providing the minimum air handling capacity for a continuous period of at least 1 h shall be provided on each elevator car.

NOTE (2.14.2.3.3): Special consideration should be given to elevators such as observation and parking garage elevators, when they are exposed to the elements. In extreme cases, emergency power may be required for this purpose.

2.14.2.4 Headroom in Elevator Cars. A minimum clear headroom of 2 025 mm (80 in.) above the car floor shall be provided.

2.14.2.5 Vision Panels. Vision panels are not required, but where used, shall

(a) be of a total area of not more than 0.1 m² (155 in.²) and contain no single glass panel having a width exceeding 150 mm (6 in.)

(b) be provided with wire-glass panels or laminated-glass panels conforming to 16 CFR Part 1201 or CAN/CGSB-12.11, whichever is applicable (see Part 9). Markings as specified in the applicable standard shall be on each separate piece of laminated glass, and shall remain visible after installation.

(c) be located in the car door or in the front return panel of the car enclosure

(d) have the inside face of a car door vision panel, grille, or cover located substantially flush with the inside surface of the car door

(e) have fasteners that are located on the hoistway side. It shall not be possible to remove the fasteners with common tools.

2.14.2.6 Access Panels. Nonremovable sliding or swing panels shall be permitted for access to the car or hoistway transparent enclosures for cleaning purposes. Such panels or doors shall

(a) if hinged, open only into the car

(b) be provided with cylinder-type locks, having not less than a five-pin or a five-disc combination, or a lock that provides equivalent security, arranged so that they can be unlocked with a key from the car side, and the key shall be Group 2 Security (see 8.1)

(c) be manually openable from the hoistway side

(d) be self-locking

(e) be provided with a device arranged so that the panel must be in the closed and locked position (see 2.26.2.31) before the elevator can operate

(f) have a bottom edge a minimum of 1 070 mm (42 in.) from the floor in cases where the adjacent hoistway wall is more than 140 mm (5.5 in.) from the car enclosure or where there is no adjacent hoistway wall

2.14.3 Freight-Car Enclosure

2.14.3.1 Enclosure Material. Enclosures shall be of metal without perforations to a height of not less than 1 825 mm (72 in.) above the floor.

Above the 1 825 mm (72 in.) level, the walls and top of the enclosure shall be metal with or without perforations, except that portion of the enclosure wall in front of and extending 150 mm (6 in.) on each side of the counterweight, that shall be without perforations.

Perforated portions of enclosures shall reject a ball 25 mm (1 in.) in diameter.

Freight elevators that are permitted to carry passengers (see 2.16.4) shall conform to 2.14.2.2.

2.14.3.2 Openings in Car Tops. Hinged or removable panels shall not be provided in car tops, except those required for emergency exit, and for equipment access (see 2.7.5.1.4).

2.14.3.3 Ventilation. If ventilating grilles or louvers are provided in the enclosure below the 1 825 mm (72 in.) level, they shall be located not more than 300 mm (12 in.) above the floor and shall reject a ball 50 mm (2 in.) in diameter.

2.14.4 Passenger and Freight Car Doors and Gates, General Requirements

2.14.4.1 Where Required. A door shall be provided at each entrance to a passenger car and a door or gate shall be provided at each entrance to a freight car.

2.14.4.2 Door and Gate Electric Contacts and Door Interlocks

2.14.4.2.1 Each car door or gate shall be provided with a door or gate electric contact conforming to 2.26.2.15, 2.14.4.2.3, and 2.14.4.2.5, or a car door interlock conforming to 2.26.2.28, 2.14.4.2.4, and 2.14.4.2.5.

2.14.4.2.2 A car door interlock shall be required for

(a) car doors of elevators where the clearance between the loading side of the car platform and hoistway enclosure exceeds the maximum specified in 2.5.1.5

(b) car doors of elevators that face an unenclosed portion of the hoistway during the travel of the car

2.14.4.2.3 Car door and gate electric contacts shall

(a) prevent operation of the driving machine when the car door or gate is not in the closed position, except under one of the following conditions:

(1) when a hoistway access switch is operated (see 2.12.7)

(2) when a car-leveling or truck-zoning device is operated (see 2.26.1.6)

(3) when a bypass switch is activated (see 2.26.1.5)

(b) be positively opened by a lever or other device attached to and operated by the door or gate

(c) be maintained in the open position by the action of gravity or by a restrained compression spring, or by both, or by positive mechanical means

(d) be so designed or located that they shall not be accessible from within the car

(e) not utilize mercury tube switches

2.14.4.2.4 Car door interlocks shall

(a) prevent operation of the driving machine when the car door is not in the closed and locked position, except

(1) when the car is within the unlocking zone for that entrance

(2) under the conditions specified in 2.14.4.2.3(a)

(b) prevent opening of the car door from within the car, except when the car is in the unlocking zone for that entrance

(c) hold the car door in the locked position by means of gravity or by a restrained compression spring, or by both, or by means of a positive linkage

(d) be so located that they are not accessible from within the car when the car doors are closed

(e) be designed in accordance with 2.12.2.4

2.14.4.2.5 Each type and make of car door electric contact, car gate electric contact, and car door interlock shall

(a) be type tested in conformance with 2.12.4.1

(b) be listed/certified in conformance with 2.12.4.2

(c) be marked in conformance with 2.12.4.3

2.14.4.2.6 A hoistway door interlock meeting the requirements of 2.12.2 and 2.12.4 shall be permitted to be used as a car door interlock.

2.14.4.3 Type and Material for Doors. Doors shall be of the horizontally or vertically sliding type and of material conforming to 2.14.2.1.

2.14.4.4 Type of Gates. Gates, where permitted, shall be of the horizontally sliding or vertically sliding type, conforming to 2.14.4.7, 2.14.5, and 2.14.6.

2.14.4.5 Location

2.14.4.5.1 Doors or gates for automatic or continuous-pressure operation elevators, except freight elevators equipped with horizontally swinging doors and not accessible to the general public, located in factories, warehouses, garages, and similar buildings, shall be so located that the distance from the face of the car door or gate to the face of the hoistway door shall be not more than the following:

(a) where a swinging-type hoistway door and car gate or folding car door are used, 100 mm (4 in.)

(b) where a swinging-type hoistway door and a car door are used, 140 mm (5.5 in.)

(c) where a sliding-type hoistway door and a car door or gate are used, 140 mm (5.5 in.)

(d) on freight elevators that are equipped with horizontally swinging doors and that are not accessible to the general public (i.e., located in factories, warehouses, garages, and similar buildings), the distance specified

in 2.14.4.5.1(a), (b), and (c) shall be not more than 165 mm (6.5 in.)

2.14.4.5.2 The distances specified shall be measured as follows:

(a) where a multisection car door and multisection hoistway door are used, or where one of these doors is multisection and the other is single section, between the sections of the car door and the hoistway door nearest to each other

(b) where a multisection car door and a swinging-type hoistway door are used, between the hoistway door and the section of the car door farthest from it

(c) where a car gate is used, between the car gate and that section of the hoistway door nearest to the car gate

(d) where a folding car door is used, between the hoistway door and the car door panel furthest from the hoistway door, when closed (see 2.12.2.2 and 2.14.4.11)

2.14.4.6 Strength of Doors, Gates, and Their Guides, Guide Shoes, Tracks, and Hangers. Doors and gates and their guides, guide shoes, tracks, and hangers shall be so designed, constructed, and installed that when the fully closed door or gate is subjected to a force of 335 N (75 lbf), applied on an area 300 mm (12 in.) square at right angles to and approximately at the center of the door or gate, it will not deflect more than 13 mm (0.5 in.) toward the hoistway door.

Where a swing-type hoistway door and car gate or folding door are used, the gate or folding door shall not deflect more than 13 mm (0.5 in.) when subjected to a force of 335 N (75 lbf) when applied to the hoistway side of the car gate or folding door at the following locations:

(a) an area 100 mm (4 in.) square at right angles at the approximate center of the gate or folding door opening

(b) an area 100 mm (4 in.) square at right angles at 25% and 75% of the door width at a height of 450 mm (18 in.) from the floor level

For individual panels of folding doors of a width less than 100 mm (4 in.), the specified forces in (a) and (b) shall be applied over an area 100 mm (4 in.) tall by the width of the individual panel.

When subjected to a force of 1 100 N (250 lbf) similarly applied, doors and vertically sliding gates shall not break or be permanently deformed and shall not be displaced from their guides or tracks.

Where multisection doors, gates, or folding doors are used, each panel shall withstand the forces specified.

2.14.4.7 Vertically Sliding Doors and Gates. Vertically sliding doors or gates shall conform to 2.14.4.7.1 through 2.14.4.7.5.

2.14.4.7.1 They shall be of the balanced counterweighted type or the biparting counterbalanced type.

2.14.4.7.2 Gates shall be constructed of wood or metal, and shall be of a design that will reject a ball

50 mm (2 in.) in diameter, except that if multisection vertical lift gates are used, the panel shall be designed to reject a ball 10 mm (0.375 in.) in diameter.

2.14.4.7.3 Doors shall be constructed of material conforming to 2.14.2.1.

2.14.4.7.4 Doors or gates shall guard the full width of the car entrance openings, and their height shall conform to 2.14.5.4 or 2.14.6.2.3.

2.14.4.7.5 Balanced counterweighted doors or gates shall be either single or multiple section, and shall slide either up or down to open, conforming to 2.14.5.3 and 2.14.6.2.

2.14.4.8 Weights for Closing or Balancing Doors or Gates. Weights used to close or balance doors or gates shall be located outside the car enclosure and shall be guided or restrained to prevent them from coming out of their runway.

The bottom of the guides or other restraining means shall be so constructed as to retain the weights if the weight suspension means breaks.

Weights that extend beyond the hoistway side of the car door or gate guide rail shall be guarded to prevent accidental contact.

2.14.4.9 Factor of Safety for Suspension Members. Suspension members of vertically sliding car doors or gates, and of weights used with car doors or gates, shall have a factor of safety of not less than 5. At least two independent suspension means shall be provided so that the failure of one suspension means shall not permit the car doors or gates to fall; or a safety device shall be provided to prevent the doors or gates from falling, if the suspension means fails.

2.14.4.10 Power-Operated and Power-Opened or Power-Closed Doors or Gates. The operation of power-operated and power-opened or power-closed doors or gates shall conform to 2.13.

2.14.4.11 Closed Position of Car Doors or Gates. Car doors or gates shall be considered to be in the closed position under the following conditions:

(a) for horizontally sliding doors or gates, when the clear open space between the leading edge of the door or gate and the nearest face of the jamb does not exceed 50 mm (2 in.) except where car doors are provided with a car door interlock(s), 10 mm (0.375 in.)

(b) for vertically sliding counterweighted doors or gates, when the clear open space between the leading edge of the door or gate and the car platform sill does not exceed 50 mm (2 in.)

(c) for horizontally sliding center-opening doors, or vertically sliding biparting counterbalanced doors, when the door panels are within 50 mm (2 in.) of contact with each other, except where horizontally sliding

center-opening car doors are provided with a car door interlock(s), 10 mm (0.375 in.)

2.14.5 Passenger Car Doors

2.14.5.1 Number of Entrances Permitted. There shall be not more than two entrances to the car, except in existing buildings where structural conditions make additional entrances necessary.

2.14.5.2 Type Required. Horizontally or vertically sliding doors subject to the restrictions of 2.14.5.3 shall be provided at each car entrance. Folding car doors are not permitted.

2.14.5.3 Vertically Sliding Doors. Vertically sliding doors shall be

(a) of the balanced counterweighted type that slide in the up direction to open

(b) power operated where facing a power-operated vertically sliding counterbalanced or a vertically sliding-down-to-open hoistway door

2.14.5.4 Dimensions of Doors. Doors, when in the fully closed position, shall protect the full width and height of the car entrance opening.

2.14.5.5 Openings in Doors. There shall be no openings in doors, except where vision panels are used.

2.14.5.6 Door Panels

2.14.5.6.1 Door panels shall have a flush surface on the side exposed to the car interior. The panels shall have no area or molding depressed or raised more than 3 mm (0.125 in.) and areas raised or depressed shall be beveled at not more than 30 deg to the panel surface.

2.14.5.6.2 Panels shall overlap the top and sides of the car entrance opening by not less than 13 mm (0.5 in.) when in the closed position.

2.14.5.6.3 The vertical clearance between a panel and the sill, or in the case of a vertically sliding door the vertical clearance between the leading edge and the sill, shall not exceed 10 mm (0.375 in.) when in the fully closed position.

2.14.5.6.4 The horizontal clearance shall not exceed 13 mm (0.5 in.) for horizontally sliding panels and 25 mm (1 in.) for vertically sliding panels between

(a) the car side of a panel and the related car entrance jamb

(b) related panels of multispeed entrances

(c) the car side of the panel and the related car head jamb

2.14.5.6.5 The leading edges of doors shall be free of sharp projections.

2.14.5.6.6 The meeting panel edges of center-opening entrances shall be protected with not less than one resilient male member extending the full height

of the panel. The meeting edges shall be permitted to interlock by not more than 10 mm (0.375 in.). When in the closed position, the distance between the metal parts of the meeting panels shall not exceed 13 mm (0.5 in.).

2.14.5.6.7 The clearance between the leading edge of the trailing panel of multiple-speed panels and the jamb shall not exceed

- (a) 13 mm (0.5 in.) for horizontal slide
- (b) 25 mm (1 in.) for vertical slide

(13) **2.14.5.7 Restricted Opening of Car Doors.** Car doors of passenger elevators shall be provided with a car door interlock conforming to 2.14.4.2 or 2.14.5.7.1 through 2.14.5.7.5.

2.14.5.7.1 When a car is outside the unlocking zone, the car doors shall be so arranged that when in the closed position they shall be restricted from opening more than 100 mm (4 in.) from inside the car.

2.14.5.7.2 Car doors shall be openable from outside the car without the use of a special tool(s).

2.14.5.7.3 The doors shall be openable from within the car (see 2.14.5.8) when the car is within the unlocking zone, except as specified in 2.14.5.7.4(b)(1).

NOTE (2.14.5.7): See also 2.12.1 and Nonmandatory Appendix B, Unlocking Zone.

2.14.5.7.4 If the means used to restrict car door opening requires electrical power for its functioning, it shall comply with 2.14.5.7.4(a) through 2.14.5.7.4(d).

(a) The means shall not use electrical power to maintain restricted opening of the car door in accordance with 2.14.5.7.1.

(b) The means shall operate in accordance with 2.14.5.7.1 and 2.14.5.7.3 and the following:

(1) an alternate power source shall be provided that shall permit the means to operate for not less than one (1) hr upon loss of normal power

(2) the alternate power source shall be

(a) monitored and when it is detected that there is sufficient capacity to operate the means for not less than one (1) hr, an audible signal conforming to 2.14.5.7.4(d) shall operate

(b) provided with readily visible information that indicates the expiration date of the alternate power source in lettering not less than 5 mm (0.25 in.) high

(c) On automatic operation, the portion of the means dependent on power shall be monitored and when it is detected that it has failed to operate in accordance with 2.14.5.7.1, an audible signal conforming to 2.14.5.7.4(d) shall operate.

(d) The audible signal required by 2.14.5.7.4(b)(2)(a) or 2.14.5.7.4(c) shall be at least 10 dBA above ambient, not exceeding 80 dBA, measured inside the car.

2.14.5.7.5 Strength. The means to restrict door opening shall comply with 2.14.5.7.1 when subjected to

a force of 1 000 N (225 lbf) applied in the opening direction of the door and at a location anywhere along the leading edge of the door.

2.14.5.8 Manual Opening of Car Doors. Car doors shall be so arranged that when the car is stopped within the unlocking zone (see 2.14.5.7.3) and power to the door operator is cut off, they and the mechanically related hoistway door, if any, shall be movable by hand from inside the car except as specified in 2.14.5.7.4(b)(1). The force required at the edge of sliding doors to move them shall not exceed 330 N (75 lbf). (13)

2.14.5.9 Glass in Car Doors

2.14.5.9.1 Vision panels, where provided, shall conform to 2.14.2.5.

2.14.5.9.2 Glass doors, where provided, shall conform to the following requirements:

(a) The glass shall be laminated glass conforming to the requirements of 16 CFR Part 1201, or be laminated glass, safety glass, or safety plastic conforming to the requirements of CAN/CGSB-12.1, whichever is applicable (see Part 9). Markings as specified shall be on each separate piece, and shall remain visible after installation.

(b) The glass shall be not less than 60% of the total visible door panel surface area as seen from the car side of the doors. Door lap shall not be used in calculating glass size.

(c) In power-operated doors, the glass panel shall be substantially flush with the surface of the car side of the door.

(d) The glass shall conform to the applicable strength requirements of 2.14.4.6.

(e) The glass shall be so mounted that it, and its mounting structure, will withstand the required elevator tests without becoming damaged or dislodged.

(f) A nonglass edge shall be provided on the leading edge of the door panel.

2.14.5.10 Folding Car Doors

2.14.5.10.1 Folding car doors shall conform to 2.14.4 except paras. 2.14.4.4, 2.14.4.7, and 2.14.4.9. They shall also conform to all of 2.14.5 except paras. 2.14.5.3, 2.14.5.6.2, 2.14.5.7, and 2.14.5.9.

2.14.5.10.2 The effort needed to prevent a folding car door from closing shall conform to 2.13.4.2.3.

2.14.5.10.3 Folding car doors shall not be power opened to a distance exceeding one-third of the clear opening, and in no case more than 250 mm (10 in.).

2.14.5.10.4 Handles of manually operated folding car doors nearest the car operating device on elevators operated from the car only shall be so located that the nearest handle is not more than 1 220 mm (48 in.) from the car operating device when the folding door is

closed, and between 1 220 mm (48 in.) and 380 mm (15 in.) above the car floor.

2.14.6 Freight Elevator Car Doors and Gates

2.14.6.1 Type of Gates

2.14.6.1.1 For elevators designed for Class A loading (see 2.16.2.2), car gates shall be the vertically sliding type (see 2.14.6.2), the horizontally sliding collapsible type (see 2.14.6.3), or a car door of the folding type (see 2.14.5.9).

2.14.6.1.2 For elevators designed for Class B or Class C loading (see 2.16.2.2), car gates shall be of the vertically sliding type (see 2.14.6.2).

2.14.6.2 Vertically Sliding Doors and Gates

2.14.6.2.1 On elevators used exclusively for freight, car doors and gates shall be either of the balanced counterweighted type that slide up or down to open, or of the biparting counterbalanced type. They shall be manually operated or power operated. Where power-operated vertically sliding biparting counterbalanced or power-operated vertically sliding counterweighted hoistway doors are provided, facing car doors and gates shall be of the power-operated balanced counterweighted type that slide up to open.

2.14.6.2.2 Where used on freight elevators permitted to carry passengers (see 2.16.4), car doors shall conform to 2.14.5.

2.14.6.2.3 Car doors and gates shall protect the full width of the car entrance opening, and their height shall be determined as follows:

(a) car doors and gates shall extend from a point not more than 25 mm (1 in.) above the car floor to a point not less than 1 825 mm (72 in.) above the car floor

(b) where a vertically sliding car gate with a door reopening device is provided, the 25 mm (1 in.) maximum dimension specified shall be measured from the car floor to the bottom of the leading member

2.14.6.2.4 The horizontal clearance between the car side of a panel and the related car entrance jamb or between related panels of multispeed doors or gates shall not exceed 25 mm (1 in.).

2.14.6.3 Collapsible-Type Gates

2.14.6.3.1 Collapsible-type gates shall protect the full width of the car entrance opening, and they shall extend from the car floor to a height of not less than 1 825 mm (72 in.) when fully closed.

2.14.6.3.2 When in the fully closed (extended) position, the opening between vertical members shall not be more than 115 mm (4.5 in.).

2.14.6.3.3 Every vertical member shall be restricted from moving perpendicular to the direction of travel more than 13 mm (0.5 in.).

2.14.6.3.4 They shall not be power opened, except as permitted by 2.13.2.1.2.

2.14.6.3.5 When in the fully opened (collapsed) position, collapsible gates shall be permitted to be arranged to swing inward.

2.14.6.3.6 Handles of manually operated collapsible gates nearest the car operating device on elevators operated from the car only shall be so located that the nearest handle is not more than 1 225 mm (48 in.) from the car operating device when the gate is closed (extended position), and not more than 1 225 mm (48 in.) above the car floor. Gate handles shall be provided with finger guards.

2.14.7 Illumination of Cars and Lighting Fixtures

2.14.7.1 Illumination and Outlets Required. Cars shall be provided with electric lighting conforming to 2.14.7.1.1 through 2.14.7.1.4.

2.14.7.1.1 Not less than two lamps or sets of lamps of approximately equal illumination shall be provided. Systems using only one of the two required lamps or sets of lamps to provide the required illumination shall be permitted and shall comply with the following:

(a) Each lamp or set of lamps shall provide the minimum illumination in conformance with 2.14.7.1.2.

(b) Systems shall be arranged to automatically illuminate the unlit lamp or set of lamps immediately following a failure of the first lamp or set of lamps.

(c) Systems shall be designed so that an audible or visual signal notifies authorized personnel when one lamp or set of lamps is not functional.

2.14.7.1.2 The minimum illumination at the car threshold, with the door closed, shall be not less than

(a) 50 lx (5 fc) for passenger elevators

(b) 25 lx (2.5 fc) for freight elevators

2.14.7.1.3 Each elevator shall be provided with auxiliary lighting and shall conform to the following:

(a) The intensity of auxiliary lighting illumination shall be not less than 2 lx (0.2 fc), measured at any point between 1 225 mm (48 in.) and 890 mm (35 in.) above the car floor and approximately 300 mm (12 in.) centered horizontally in front of a car operating panel containing any of the following:

(1) car operating device(s)

(2) door open button

(3) rear or side door open button

(4) door close button

(5) rear or side door close button

(6) "PHONE" button and operating instructions, or

(7) "ALARM" switch

(b) Illumination is not required in front of additional car operating panels where the devices listed in 2.14.7.1.3(a) are duplicated.

(c) Auxiliary lights shall be automatically turned on in all elevators in service after normal car lighting power fails.

(d) The power source shall be located on the car.

(e) The power system shall be capable of maintaining the light intensity specified in 2.14.7.1.3(a) for a period of at least 4 h.

(f) Not less than two lamps or sets of lamps of approximately equal illumination shall be provided. Systems using only one of the two required lamps or sets of lamps to provide the required illumination shall be permitted and shall comply with the following:

(1) Each lamp or set of lamps shall provide the minimum illumination in conformance with 2.14.7.1.3(a).

(2) Systems shall be arranged to automatically illuminate the unlit lamp or set of lamps immediately following a failure of the first lamp or set of lamps.

(3) Systems shall be designed so that an audible or visual signal notifies authorized personnel when one lamp or set of lamps is not functional.

(g) Battery-operated units, where provided, shall

(1) comply with CSA C22.2 No. 141 or UL 924 (see Section 9)

(2) have a 4 h rating minimum

(3) be permanently connected to the car light branch circuit

(4) have an output rating that includes the auxiliary lights and if connected, the emergency signaling device (see 2.27.1.1.3)

(h) The lamps used for auxiliary lighting are permitted to be the same lamps used for normal illumination in conformance with 2.14.7.1.1.

2.14.7.1.4 Each elevator shall be provided with lighting and a duplex receptacle fixture on the car top. The lighting shall be permanently connected, fixed, or portable, or a combination thereof, to provide an illumination level of not less than 100 lx (10 fc) measured at the point of any elevator part or equipment, where maintenance or inspection is to be performed from the car top. All lighting shall be equipped with guards. The light switch shall be accessible from the landing when accessing the car top.

2.14.7.2 Light Control Switches

2.14.7.2.1 Light control switches for in-car lighting shall be permitted. When provided, they shall

(a) be located in or adjacent to the operating device in the car.

(b) in elevators having automatic operation, be of the key-operated type or located in a fixture with a locked cover. The key shall be Group 2 Security (see 8.1).

2.14.7.2.2 Automatic operation of the car lights shall be permitted. When provided, the operating circuit

shall be arranged to turn off the lights only when the following conditions exist for not less than 5 min:

(a) the car is at a floor

(b) the doors are closed

(c) there is no demand for service

(d) the car is on automatic operation

Momentary interruption of any of the above conditions shall cause the car lights to turn on.

2.14.7.3 Car Lighting Devices

2.14.7.3.1 Glass used for lighting fixtures shall conform to 2.14.1.8.

2.14.7.3.2 Suspended glass used in lighting fixtures shall be supported by a metal frame secured at not less than three points.

2.14.7.3.3 Fastening devices shall not be removable from the fixture.

2.14.7.3.4 Glass shall not be drilled for attachment.

2.14.7.3.5 Light troughs supporting wiring raceways and other auxiliary lighting equipment, where used, shall be of metal, except where lined with noncombustible materials.

2.14.7.3.6 Materials for light diffusion or transmission shall be of metal, glass, or materials conforming to 2.14.2.1.1 and shall not come in contact with light bulbs and tubes.

2.14.7.4 Protection of Light Bulbs and Tubes. Light bulbs and tubes within the car shall

(a) be equipped with guards, be recessed, or be mounted above a drop ceiling to prevent accidental breakage. Cars that operate with the drop ceiling removed shall have a permanent separate guard for the light bulb or tube.

(b) be so mounted in the structure that the structure and the bulb or tube will withstand the required elevator tests without being damaged or becoming dislodged.

SECTION 2.15 CAR FRAMES AND PLATFORMS

2.15.1 Car Frames Required

Every elevator shall have a car frame (see 1.3).

2.15.2 Guiding Means

2.15.2.1 Car frames shall be guided on each guide rail by upper and lower guiding members attached to the frame. Guiding means shall be designed to withstand the forces imposed during normal operation of the elevator, loading and unloading, emergency stopping, and the application of safeties.

(13)

2.15.2.2 Means shall be provided to prevent the car from being displaced by more than 13 mm (0.5 in.) from its normal running position.

This protection shall be provided by either of the following:

(a) a guiding means wherein no failure or wear of the guiding member shall allow the car to be displaced more than 13 mm (0.5 in.) from its normal running position

(b) a retention means that shall be permitted to be integral with the guiding means

2.15.2.3 All components of the means required to limit displacement in accordance with 2.15.2.2 shall have minimum factor of safety of 5.

2.15.3 Design of Car Frames and Guiding Members

The frame and its guiding members shall be designed to withstand the forces resulting under the loading conditions for which the elevator is designed and installed (see 2.16).

2.15.4 Underslung or Sub-Post Frames

The vertical distance between the centerlines of the top and bottom guide shoes of an elevator car having a sub-post car frame or having an underslung car frame located entirely below the car platform shall be not less than 40% of the distance between guide rails.

2.15.5 Car Platforms

2.15.5.1 Every elevator car shall have a platform consisting of a nonperforated floor attached to a platform frame supported by the car frame, and extending over the entire area within the car enclosure.

2.15.5.2 The platform frame members and the floor shall be designed to withstand the forces developed under the loading conditions for which the elevator is designed and installed.

2.15.5.3 Platform frames are not required where laminated platforms are provided.

2.15.5.4 Laminated platforms shall be permitted to be used for passenger elevators having a rated load of 2 300 kg (5,000 lb) or less.

2.15.5.5 The deflection at any point of a laminated platform, when uniformly loaded to rated capacity, shall not exceed $\frac{1}{960}$ of the span. The stresses in the steel facing shall not exceed one-fifth of its ultimate strength, and the stresses in the plywood core shall not exceed 60% of the allowable stresses in Section 3.14 of the American Plywood Association Plywood Design Specification or CSA O86.1, as applicable (see Part 9).

2.15.6 Materials for Car Frames and Platform Frames

2.15.6.1 Materials Permitted. Materials used in the construction of car frames and platforms shall conform to 2.15.6.1.1 through 2.15.6.1.4.

2.15.6.1.1 Car frames and outside members of platform frames shall be made of steel or other metals.

2.15.6.1.2 Platform stringers of freight elevators designed for Class B or Class C loading shall be of steel or other metals.

2.15.6.1.3 Platform stringers of passenger elevators and of freight elevators designed for Class A loading shall be made of steel or other metals, or of wood.

2.15.6.1.4 Cast iron shall not be used for any part subject to tension, torsion, or bending, except for guiding supports and guide shoes.

2.15.6.2 Requirements for Steel. Steel used in the construction of car frames and platforms shall conform to 2.15.6.2.1 through 2.15.6.2.3.

2.15.6.2.1 Car-Frame and Platform-Frame Members. Steel shall be rolled, formed, forged, or cast, conforming to the requirements of the following specifications:

(a) *Rolled and Formed Steel.* ASTM A36 or ASTM A283 Grade D or CAN/CSA-G40.21.

(b) *Forged Steel.* ASTM A668 Class B.

(c) *Cast Steel.* ASTM A27 Grade 60/30.

2.15.6.2.2 Rivets, Bolts, and Rods. Steel used for rivets, bolts, and rods shall conform to the following specifications:

(a) ASTM A502, Rivets

(b) ASTM A307, Bolts and Rods

2.15.6.2.3 Steels of Other Strength. Steels of greater or lesser strength than those specified by 2.15.6.2.1 shall be permitted to be used, provided they have an elongation of not less than 20% in a length of 50 mm (2 in.) when tested in accordance with ASTM E8, and provided that the stresses and deflections conform to 2.15.10 and 2.15.11, respectively.

Rivets, bolts, and rods made of steel having greater strength than specified by ASTM A307 and ASTM A502 shall be permitted to be used and the maximum allowable stresses increased proportionally, based on the ratio of the ultimate strengths. Elongation shall conform to the requirements of the corresponding ASTM specifications.

2.15.6.3 Requirements for Metals Other Than Steel. Metals other than steel shall be permitted to be used in the construction of car frames and platforms, provided the metal used has the essential properties to meet all the requirements for the purpose in accordance with good engineering practice, and provided the stresses and deflections conform to 2.15.10 and 2.15.11, respectively.

2.15.6.4 Requirements for Wood Used for Platform Floors and Stringers. Wood used for platform stringers and platform floors and sub-floors shall be of structural

quality lumber or exterior-type plywood conforming to the requirements of the following:

- (a) ASTM D245, Structural Grades of Lumber
- (b) ASTM D198, Static Tests of Structural Timbers
- (c) ANSI Voluntary Product Standard PS 1-74 or CSA O151, Softwood Plywood, Construction and Industrial

2.15.7 Car Frame and Platform Connections

2.15.7.1 Internal Connections. Connections between members of car frames and platforms shall be riveted, bolted, or welded, and shall conform to 2.15.7.3.

2.15.7.2 Connection Between Car Frame and Platform. The attachment of the platform to the car frame shall be done in accordance with good engineering practice and shall develop the required strength to transmit the forces safely from the platform to the car frame in accordance with 2.15.10. Bolts, nuts, and welding, where used, shall conform to 2.15.7.3.

2.15.7.3 Bolts, Nuts, and Welding

2.15.7.3.1 Bolts, where used through greater than 5 deg sloping flanges of structural members, shall have bolt heads of the tipped-head type or shall be fitted with bevelled washers.

2.15.7.3.2 Nuts used on greater than 5 deg sloping flanges of structural members shall sit on beveled washers.

2.15.7.3.3 All welding shall conform to 8.8.

2.15.8 Protection of Platforms Against Fire

All platform materials exposed to the hoistway shall be either of the following:

- (a) metal
- (b) other materials that, in their end-use configuration, conform to the following requirements, based on the tests conducted in accordance with the requirements of ASTM E84, UL 723, NFPA 255, or CAN/ULC-S102.2, whichever is applicable (see Part 9):
 - (1) flame spread rating of 0 to 75
 - (2) smoke development of 0 to 450

2.15.9 Platform Guards (Aprons)

The entrance side of the platform of passenger and freight elevators shall be provided with smooth metal guard plates of not less than 1.5 mm (0.059 in.) thick steel, or material of equivalent strength and stiffness, adequately reinforced and braced to the car platform and conforming to 2.15.9.1 through 2.15.9.4.

2.15.9.1 The guard plate shall extend not less than the full width of the widest hoistway-door opening.

- (13) **2.15.9.2** The guard plate shall have a straight vertical face, extending below the floor surface of the platform. A horizontal door guiding groove is permitted

below the floor surface for door operating devices, door guiding devices, and door retaining devices in accordance with 2.15.9.5. The guard plate shall conform to one of the following:

(a) where the elevator is required to conform to 2.19.2.2(b) the depth of the truck zone, where provided, plus 75 mm (3 in.), but in no case less than 1 220 mm (48 in.)

(b) where the elevator is not required to conform to 2.19.2.2(b) the depth of the leveling zone or truck zone, where provided, plus 75 mm (3 in.), but in no case less than 525 mm (21 in.) from the floor surface

2.15.9.3 The lower portion of the guard shall be bent back at an angle of not less than 60 deg nor more than 75 deg from the horizontal.

2.15.9.4 The guard plate shall be securely braced and fastened in place to withstand a constant force of not less than 650 N (145 lbf) applied at right angles to and at any position on its face without deflecting more than 6 mm (0.25 in.), and without permanent deformation.

Where the car entrance on the truck loading side is provided with a collapsible-type gate and the height of the hoistway door opening is greater than the distance from the car floor to the car top, a head guard extending the full width of the door opening shall be provided on the car to close the space between the car top and the soffit of the hoistway-door opening when the car platform is level with the floor at the truck loading landing entrance.

2.15.9.5 A horizontal door guiding groove with a maximum width of 10 mm (0.375 in.) shall be permitted at the transition of the car sill guard and the car sill, in accordance with the following requirements: (13)

(a) door power pre-opening in accordance with 2.13.2.2.2 shall not be permitted

(b) leveling/re-leveling shall be initiated before vertical exposure of the groove is revealed

(c) where exposure to the gap is revealed the car shall not re-level with open doors

(d) edges forming the gap shall be configured to prevent hazards

2.15.10 Maximum Allowable Stresses in Car Frame and Platform Members and Connections

2.15.10.1 The stresses in car frame and platform members and their connections, based on the static load imposed upon them, shall not exceed the following:

(a) for steels meeting the requirements of 2.15.6.2.1 and 2.15.6.2.2, as listed in Table 2.15.10.1

(b) for steels of greater or lesser strength, as permitted by 2.15.6.2.3, the allowable stresses listed in Table 2.15.10.1 are to be adjusted proportionally, based on the ratio of the ultimate strengths

Table 2.15.10.1 Maximum Allowable Stresses in Car Frame and Platform Members and Connections, for Steels Specified in 2.15.6.2.1 and 2.15.6.2.2

| Member Type | Stress Type | Maximum Stress, MPa (psi) | Area Basis |
|--|----------------------|------------------------------|------------------------------|
| Car crosshead | Bending | 95 (14,000) | Gross section |
| Car frame plank (normal loading) | Bending | 95 (14,000) | Gross section |
| Car frame plank (buffer reaction) | Bending | 190 (27,500) | Gross section |
| Car frame uprights (stiles) | Bending plus tension | 115 (17,000) 140 (20,200) | Gross section Net section |
| Hoisting rope hitch plate and shapes | Bending plus tension | 75 (11,000) | Net section |
| Platform framing | Bending | 95 (14,000) | Gross section |
| Platform stringers | Bending | 115 (17,000) | Gross section |
| Threaded brace rods and other tension members except bolts | Tension | 60 (9,000) | Net section |
| Bolts | Tension | 55 (8,000) | Net section |
| Bolts in clearance holes | Shear | 55 (8,000) | Actual area in shear plane |
| | Bearing | 120 (17,500) | Gross section |
| Rivets or tight body-fit bolts | Shear | 75 (11,000) | Actual area in shear plane |
| | Bearing | 140 (20,000) | Gross section |
| Any framing member normal loading | Compression | Note (1) | Gross section |

NOTE:

(1) The maximum allowable compressive stress in any member at normal loading shall not exceed 80% of those permitted for static loads by the AISC #S326 or CSA S16.1.

(c) for metals other than steel, as permitted by 2.15.6.3, the allowable stresses listed in Table 2.15.10.1 are to be adjusted proportionally, based on the ratio of the ultimate strengths

2.15.10.2 Car frame members, brackets, and their connections subject to forces due to the application of the emergency brake (see 2.19.4) shall be designed to withstand the maximum forces developed during the retardation phase of the emergency braking so that the resulting stresses due to the emergency braking and all other loading acting simultaneously, if applicable, shall not exceed 190 MPa (27,500 psi).

2.15.11 Maximum Allowable Deflections of Car Frame and Platform Members

The deflections of car frame and platform members based on the static load imposed upon them shall be not more than the following:

- (a) for crosshead, plank, and platform frame members, $\frac{1}{960}$ of the span
- (b) for uprights (stiles), as determined by 8.2.2.5.3

2.15.12 Car Frames With Sheaves

Where a hoisting-rope sheave is mounted on the car frame, the construction shall conform to 2.15.12.1 through 2.15.12.3.

2.15.12.1 Where multiple sheaves mounted on separate sheave shafts are used, provision shall be made

to take the compressive forces, developed by tension in the hoisting ropes between the sheaves, on a strut or struts between the sheave shaft supports, or by providing additional compressive strength in the car frame or car-frame members supporting sheave shafts.

2.15.12.2 Where the sheave shaft extends through the web of a car-frame member, the reduction in area of the member shall not reduce the strength of the member below that required. Where necessary, reinforcing plates shall be welded or riveted to the member to provide the required strength. The bearing pressure shall in no case be more than that permitted in Table 2.15.10.1 for bolts in clearance holes.

2.15.12.3 Where the sheave is attached to the car crosshead by means of a single-threaded rod or specially designed member or members in tension, the requirements of 2.15.12.3.1 and 2.15.12.3.2 shall be conformed to.

2.15.12.3.1 The single rod, member, or members shall have a factor of safety 50% higher than the factor of safety required for the suspension wire ropes, but in no case shall have a factor of safety of less than 15.

2.15.12.3.2 The means for fastening the single-threaded rod, member, or members to the car frame shall conform to 2.15.13.

2.15.13 Suspension-Rope Hitch Plates or Shapes

Where cars are suspended by hoisting ropes attached to the car frame or to the overhead supporting beams

by means of rope shackles, the shackles shall be attached to steel hitch plates or to structural or formed steel shapes.

Such plates or shapes shall be secured to the underside or to the webs of the car-frame member with bolts, rivets, or welds so located that the tensions in the hoisting ropes will not develop direct tension in the bolts or rivets.

The stresses shall not exceed those permitted by 2.9.3.3.

2.15.14 Calculation of Stresses in Car-Frame and Platform-Frame Members

The calculation of the stresses and deflection in the car-frame plank and uprights and platform frames shall be based on the formulas and data in 8.2.2.

2.15.15 Platform Side Braces

Where side bracing and similar members are attached to car-frame uprights, the reduction in area of the upright shall not reduce the strength of the upright below that required by 2.15.

2.15.16 Hinged Platform Sills

Hinged platform sills, where used, shall conform to 2.15.16.1 through 2.15.16.3.

- (13) **2.15.16.1** Hinged platform sills shall be provided with electric contacts conforming to the following requirements that will prevent operation of the elevator by the normal operating device unless the hinged sill is within 50 mm (2 in.) of its fully retracted position, provided that when in this position, the sill does not reduce the clearance specified in 2.5.1.4. The electric contacts shall

(a) be positively opened by a lever or other device attached to and operated by the hinged platform sill

(b) be maintained in the open position by the action of gravity or by a restrained compression spring, or by both, or by positive mechanical means

(c) be so designed or located that they shall not be accessible from within the car

(d) not utilize mercury tube switches

2.15.16.2 The elevator shall be permitted to be operated by the leveling device in the leveling zone with the sill in any position.

2.15.16.3 The strength of the sills shall conform to 2.11.11.1.

2.15.17 Fastening of Compensation Means

Fastenings to the car of the suspension ropes' compensation means shall conform to 2.21.4.

SECTION 2.16 CAPACITY AND LOADING

2.16.1 Minimum Rated Load for Passenger Elevators

2.16.1.1 Minimum Load Permitted. The rated load (ED) in kg (lb) for passenger elevators shall be based on the inside net platform area, and shall be not less than shown by Fig. 8.2.1.2 (see Nonmandatory Appendix D).

The inside net platform area shall be determined at a point 1 000 mm (39 in.) above the floor and inside of any panels or wall surfaces, but exclusive of any handrails and space for doors as shown in Fig. 2.16.1.1. To allow for variations in car designs, an increase in the maximum inside net area not exceeding 5% shall be permitted for the various rated loads. See Table 2.16.1.1.

2.16.1.2 Use of Partitions for Reducing Inside Net Platform Area. Where partitions are installed in elevator cars for the purpose of restricting the platform net area for passenger use, they shall be permanently bolted, riveted, or welded in place. Gates, doors, or handrails shall not be used for this purpose. Partitions shall be so installed as to provide for approximately symmetrical loading.

2.16.1.3 Carrying of Freight on Passenger Elevators. When freight is to be carried on a passenger elevator, the requirements of 2.16.1.3.1 and 2.16.1.3.2 shall be conformed to.

2.16.1.3.1 The minimum rated load shall conform to 2.16.1 or 2.16.2, whichever is greater.

2.16.1.3.2 The elevator shall be designed for applicable class of freight elevator loading.

2.16.2 Minimum Rated Load for Freight Elevators

2.16.2.1 Minimum Load Permitted. The minimum rated load for freight elevators in pounds shall be based on the weight and class of the load to be handled, but shall in no case be less than the minimum specified in 2.16.2.2 for each class of loading based on the inside net platform area.

2.16.2.2 Classes of Loading and Design Requirements. Freight elevators shall be designed for one of the following classes of loading.

2.16.2.2.1 Class A: General Freight Loading. Where the load is distributed, the weight of any single piece of freight or of any single hand truck and its load is not more than 25% of the rated load of the elevator, and the load is handled on and off the car platform manually or by means of hand trucks.

For this class of loading, the rated load shall be based on not less than 240 kg/m² (49 lb/ft²) of inside net platform area.

2.16.2.2.2 Class B: Motor Vehicle Loading. Where the elevator is used solely to carry automobile trucks or

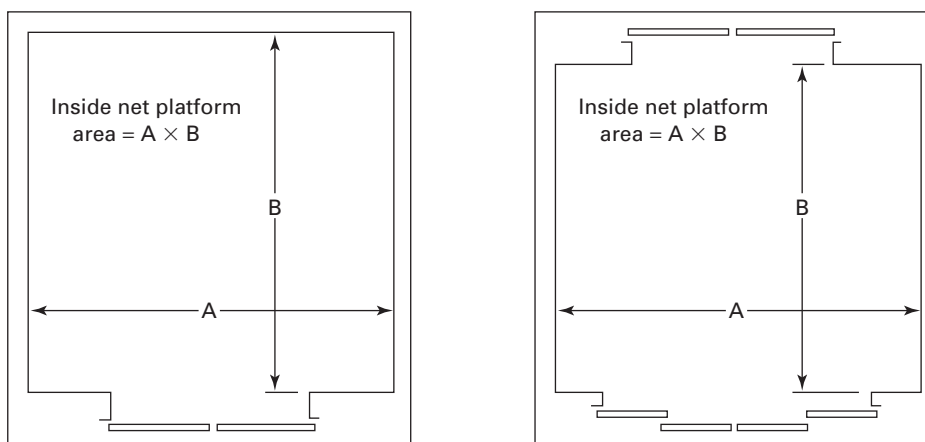
Fig. 2.16.1.1 Inside Net Platform Areas for Passenger Elevators**Table 2.16.1.1 Maximum Inside Net Platform Areas for the Various Rated Loads**

| SI Units | | Imperial Units | |
|-------------------|--|-------------------|---|
| Rated Load, kg | Inside Net Platform Area, m ² | Rated Load, lb | Inside Net Platform Area, ft ² |
| 230 | 0.65 | 500 | 7.0 |
| 270 | 0.77 | 600 | 8.3 |
| 320 | 0.89 | 700 | 9.6 |
| 450 | 1.23 | 1,000 | 13.3 |
| 550 | 1.45 | 1,200 | 15.6 |
| 700 | 1.76 | 1,500 | 18.9 |
| 800 | 2.05 | 1,800 | 22.1 |
| 900 | 2.25 | 2,000 | 24.2 |
| 1 150 | 2.70 | 2,500 | 29.1 |
| 1 350 | 3.13 | 3,000 | 33.7 |
| 1 600 | 3.53 | 3,500 | 38.0 |
| 1 800 | 3.92 | 4,000 | 42.2 |
| 2 000 | 4.29 | 4,500 | 46.2 |
| 2 250 | 4.65 | 5,000 | 50.0 |
| 2 700 | 5.36 | 6,000 | 57.7 |
| 3 200 | 6.07 | 7,000 | 65.3 |
| 3 600 | 6.77 | 8,000 | 72.9 |
| 4 100 | 7.48 | 9,000 | 80.5 |
| 4 500 | 8.18 | 10,000 | 88.0 |
| 5 400 | 9.57 | 12,000 | 103.0 |
| 7 000 | 11.62 | 15,000 | 125.1 |
| 8 000 | 13.65 | 18,000 | 146.9 |
| 9 000 | 14.98 | 20,000 | 161.2 |
| 11 500 | 18.25 | 25,000 | 196.5 |
| 13 500 | 21.46 | 30,000 | 231.0 |

GENERAL NOTE: To allow for variations in cab designs, an increase in the maximum inside net platform area not exceeding 5% shall be permitted for the various rated loads.

passenger automobiles up to the rated capacity of the elevator.

For this class of loading, the rated load shall be based on not less than 145 kg/m² (30 lb/ft²) of inside net platform area.

2.16.2.2.3 Class C. There are three types of Class C loadings:

(a) *Class C1: Industrial Truck Loading.* Where the static load during loading and unloading does not exceed the rated load.

(b) *Class C2: Industrial Truck Loading.* Where the static load during loading and unloading is permitted to exceed the rated load.

(c) *Class C3: Other Loading With Heavy Concentrations.* Where the static load during loading and unloading does not exceed the rated load.

2.16.2.2.4 Class C loadings in 2.16.2.2.3 apply where the weight of the concentrated load including a powered industrial or hand truck, if used, is more than 25% the rated load and where the load to be carried does not exceed the rated load. (For concentrated loads exceeding the rated load, see 2.16.6.)

The following are additional requirements:

(a) For Class C1, Class C2, and Class C3 loadings, the rated load of the elevator shall be not less than the load (including any truck) to be carried, and shall in no case be less than 240 kg/m² (49 lb/ft²) of inside net platform area.

The elevator shall be provided with a two-way automatic leveling device (see 1.3).

(b) For Class C1 and Class C2 loadings, the following additional requirements shall apply:

(1) For elevators with rated loads of 9 000 kg (20,000 lb) or less, the car platform shall be designed for a loaded truck of weight equal to the rated load or

for the actual weight of the loaded truck to be used, whichever is greater.

(2) For elevators with rated loads exceeding 9 000 kg (20,000 lb), the car platform shall be designed for a loaded truck weighing 9 000 kg (20,000 lb), or for the actual weight of the loaded truck to be used, whichever is greater.

(c) For Class C2 loading, the following requirements shall apply:

(1) The maximum load on the car platform during loading or unloading shall not exceed 150% of rated load.

(2) For any load in excess of rated load on elevators with a rated load of 9 000 kg (20,000 lb) or less, the driving-machine motor, brake, and traction relation shall be adequate to sustain and level the full 150% of rated load.

(3) For any load in excess of the rated load on elevators with a rated load exceeding 9 000 kg (20,000 lb), the driving-machine motor, brake, and traction relation shall be adequate to sustain and level the rated load plus either 4 500 kg (10,000 lb), or the weight of the unloaded truck to be used, whichever is greater.

NOTES (2.16.2):

- (1) When the entire rated load is loaded or unloaded in increments by an industrial truck, the load imposed on the car platform, while the last increment is being loaded or the first increment unloaded, will exceed the rated load by part of the weight of the empty industrial truck.
- (2) Requirement 2.16.2 does not prohibit the carrying of an industrial truck on a freight elevator of Class C2 or Class C3 loading, provided that the total weight on the elevator does not exceed the rated load of the elevator, and the elevator is designed to meet the requirements of 8.2.2 and 8.2.9, as appropriate, for the load involved.

2.16.3 Capacity and Data Plates

2.16.3.1 Plates Required and Locations. Every elevator shall be provided with a capacity plate and a data plate permanently and securely attached.

The capacity plate shall be located in a conspicuous position inside the car.

The data plate shall be located on the car crosshead, or inside the car for underslung elevators having no crosshead.

2.16.3.2 Information Required on Plates

2.16.3.2.1 Capacity plates shall indicate the rated load of the elevator in kilograms or pounds or both (see Nonmandatory Appendix D), and, in addition, this plate or a separate plate shall indicate

(a) the capacity lifting one-piece loads where the elevator conforms to 2.16.7

(b) for freight elevators designed for Class C2 loading, the maximum load the elevator is designed to support while being loaded or unloaded [see 2.16.2.2.4(c)]

2.16.3.2.2 Data plates shall indicate

(a) the weight of the complete car, including the car safety and all auxiliary equipment attached to the car

(b) the rated load and speed

(c) the suspension-means data required by 2.20.2.1

(d) the name or trademark of the manufacturer and year manufactured

(e) rail lubrication instructions (see 2.17.16)

2.16.3.3 Material and Marking of Plates (13)

2.16.3.3.1 Permanent data plates and marking plates shall be metal or durable plastic with 1.6 mm (0.063 in.) minimum thickness.

2.16.3.3.2 The plates shall be securely fastened to prevent removal by hand when subjected to a force of 67 N (15 lb) in any direction.

2.16.3.3.3 All Code required data shall be formed such that the characters remain permanently and readily legible and conform to the following:

(a) The height of the letters and figures shall be not less than

(1) 6 mm (0.25 in.) for passenger elevator capacity plates

(2) 25 mm (1 in.) for freight elevator capacity plates

(3) 3 mm (0.125 in.) for data plates

(b) They shall have a minimum character stroke width of 0.5 mm (0.02 in.).

(c) They shall be provided with a durable means to prevent common containments (such as paint, adhesives, oil, and grease) from adhering to the data plate parent surface or permit the removal of these contaminants without obscuring the Code required data.

2.16.4 Carrying of Passengers on Freight Elevators (ED)

Freight elevators conforming to 2.16.4.1 through 2.16.4.8 shall be permitted to carry passengers.

2.16.4.1 The elevator shall not be accessible to the general public.

2.16.4.2 The rated load shall not be less than that required by 2.16.1.

2.16.4.3 The elevator shall conform to 2.16.8.

2.16.4.4 Hoistway entrances shall conform to 2.12.1.1 and 2.11.2.1, or shall be power-operated doors conforming to 2.11.2.2(e).

2.16.4.5 Car doors shall be provided, and shall conform to 2.14.5.

2.16.4.6 Openings in car enclosures shall conform to 2.14.2.2.

2.16.4.7 The factors of safety for suspension wire ropes shall conform to Table 2.20.3 for passenger elevators. (13)

- (13) **2.16.4.8** Power-operated vertically sliding doors shall be power closed conforming to the following:

- (a) requirement 2.13.3.4
- (b) supporting chains, cables, or ropes shall not be exposed to the car interior

2.16.5 Signs Required in Freight Elevator Cars

2.16.5.1 Signs Required. Signs, in addition to the capacity and data plates required by 2.16.3.1, shall be provided inside the car and shall be located in a conspicuous position and permanently and securely fastened to the car enclosure, subject to the requirements of 2.16.5.1.1 through 2.16.5.1.3.

2.16.5.1.1 For every freight elevator, the sign shall specify the type of loading (see 2.16.2.2) for which the elevator is designed and installed, with one of the following markings.

(a) "CLASS A LOADING. ELEVATOR TO BE LOADED OR UNLOADED MANUALLY OR BY MEANS OF HAND TRUCKS ONLY. NO SINGLE PIECE OF FREIGHT OR SINGLE HAND TRUCK AND ITS LOAD SHALL EXCEED ____ KG (____ LB)."

(b) "CLASS B LOADING. THIS ELEVATOR DESIGNED TO TRANSPORT MOTOR VEHICLES HAVING A MAXIMUM GROSS WEIGHT NOT TO EXCEED ____ KG (____ LB)."

(c) "CLASS C1 LOADING. THIS ELEVATOR DESIGNED TO TRANSPORT LOADED INDUSTRIAL TRUCK. MAXIMUM COMBINED WEIGHT OF INDUSTRIAL TRUCK AND LOAD NOT TO EXCEED ____ KG (____ LB)."

(d) "CLASS C2 LOADING. THIS ELEVATOR DESIGNED FOR LOADING AND UNLOADING BY INDUSTRIAL TRUCK. MAXIMUM LOADING AND UNLOADING WEIGHT WHILE PARKED NOT TO EXCEED ____ KG (____ LB). MAXIMUM WEIGHT TRANSPORTED NOT TO EXCEED ____ KG (____ LB)."

(e) "CLASS C3 LOADING. THIS ELEVATOR DESIGNED TO TRANSPORT CONCENTRATED LOADS NOT TO EXCEED ____ KG (____ LB)."

2.16.5.1.2 For freight elevators not permitted to carry passengers, the sign shall read: "THIS IS A FREIGHT ELEVATOR, NOT A PASSENGER ELEVATOR, AND NOT FOR GENERAL PUBLIC USE."

2.16.5.1.3 For freight elevators permitted to carry passengers (see 2.16.4), a sign reading "PASSENGERS ARE PERMITTED TO RIDE THIS ELEVATOR."

- (13) **2.16.5.2 Material and Marking of Signs.** The sign shall conform to the requirements of ANSI Z535.4 or CAN/CSA-Z321 (see Part 9), except that the letters shall be not less than 13 mm (0.5 in.) high. The sign shall be made of durable material and shall be securely fastened.

2.16.6 Overloading of Freight Elevators

Freight elevators shall not be loaded in excess of their rated load as specified on the capacity plate required by 2.16.3, except for

(a) static loads on elevators loaded and unloaded by industrial trucks as noted on capacity or separate plate [see 2.16.2.2.3 and 2.16.3.2.1(b)]

(b) elevators designed and installed to conform to 2.16.7 to carry one-piece loads exceeding their rated load

2.16.7 Carrying of One-Piece Loads Exceeding the Rated Load

Passenger and freight elevators shall be permitted to be used, where necessary, to carry one-piece loads greater than their rated load, provided they are designed, installed, and operated to conform to 2.16.7.1 through 2.16.7.11.

2.16.7.1 A locking device shall be provided that will hold the car at any landing, independently of the hoisting ropes, while the car is being loaded or unloaded.

2.16.7.2 The locking device shall be so designed that it cannot be unlocked until the entire weight of the car and load is suspended on the ropes.

2.16.7.3 A removable wrench or other device shall be provided to operate the locking device.

2.16.7.4 The locking device shall be so designed that the locking bars will be automatically withdrawn should they come into contact with the landing locks when the car is operated in the up direction.

2.16.7.5 A special capacity plate shall be provided inside the elevator car and located in a conspicuous place that shall bear the words "CAPACITY LIFTING ONE-PIECE LOADS" in letters, followed by figures giving the special capacity in kilograms (pounds) for lifting one-piece loads for which the machine is designed. For material and size of letters, see 2.16.3.3.

2.16.7.6 The car frame, car platform, sheaves, shafts, ropes, and locking devices shall be designed for the specified "Capacity Lifting One-Piece Loads," provided that

(a) in the design of the car frame, platform, sheaves, shafts, and ropes, the allowable stress is permitted to be 20% higher than those permitted for normal loading

(b) the factor of safety for the locking device is not less than 5

2.16.7.7 The car safeties shall be designed to stop and hold the specified "Capacity Lifting One-Piece Loads" with the ropes intact. The safety is not required to conform to the safety stopping distances specified in Table 2.17.3 if applied while the elevator is carrying a one-piece load exceeding the rated load.

2.16.7.8 Where there is an occupied space, or an unoccupied space not secured against unauthorized access (see 2.6), under the hoistway, the requirements of 2.16.7.8.1 through 2.16.7.8.4 shall be conformed to.

2.16.7.8.1 The machine shall be designed to operate the “Capacity Lifting One-Piece Loads” at slow speed.

2.16.7.8.2 The car safety shall be designed to stop and hold the car with this load, independently of the hoisting ropes.

2.16.7.8.3 The counterweight safety, where required by 2.6, shall be designed to stop and hold the entire weight of the counterweight, independently of the ropes.

2.16.7.8.4 Under the conditions described in 2.16.7.8.2 and 2.16.7.8.3, the car and counterweight safeties are not required to conform to the safety stopping distances specified in Table 2.17.3 when the elevator is carrying a one-piece load exceeding the rated load and the counterweight is provided with additional weight as required by 2.16.7.9.

2.16.7.9 For traction machines, where it is necessary to secure adequate traction, an additional counterweight shall be added during the period of use with one-piece loads so that the total overbalance is at least equal to 45% of the “Capacity Lifting One-Piece Loads.”

2.16.7.10 A special operating device of the car switch or continuous-pressure type shall be provided in a machine room, control space located outside the hoistway, or control room to operate the elevator.

Means shall be provided to visually observe the driving machine when this special operating device is operated. When this device is operative, all other operating devices shall be inoperative (see 2.26.1.3).

2.16.7.11 The “Capacity Lifting One-Piece Loads” of any passenger traction elevator shall not exceed 1.33 times the rated load of the elevator.

2.16.8 Additional Requirements for Passenger Overload in the Down Direction

Passenger elevators and freight elevators permitted by 2.16.4 to carry passengers shall be designed and installed to safely lower, stop, and hold the car with an additional load up to 25% in excess of the rated load.

The elevator is not required to attain rated load performance under the passenger overload conditions specified but shall conform to

(a) requirement 2.17.2, except that 125% of the rated load shall be used in place of the rated load.

(b) requirement 2.17.3, except that 125% of the rated load shall be used in the first paragraph in place of the rated load. Second paragraph of 2.17.3, except that 125% of the rated load shall be used in place of the rated

load, and the rated load performance including safety stopping distance is not required.

(c) requirement 2.24.2.3, except that 125% of rated load shall be used in place of the rated load.

(d) requirement 2.24.8, except that 125% of the rated load shall be used in place of the rated load.

(e) requirement 2.25.2.1, except that 125% of the rated load shall be used in place of the rated load.

(f) requirement 2.26.9.8, except that 125% of the rated load shall be used in place of the rated load.

(g) requirement 2.26.10, except that 125% of the rated load shall be used in place of the rated load.

(h) requirement 2.19.2.2(b), except that 125% of the rated load shall be used in place of the rated load.

(i) requirement 2.27.2.1, except that 125% of rated load shall be used in place of rated load.

(j) requirement 2.7.5.1.2(b), except that 125% of rated load shall be used in place of rated load.

2.16.9 Special Loading Means

Where special means (lift hooks, conveyor tracks, and support beams) that exert loads upon the car frame or platform, or both, are used to carry loads other than as described in 2.16.2.2, the effects of their loading on the car frame and platform shall be considered in accordance with 8.2.2.1 and 8.2.9.1. The allowable stresses and deflections shall be as specified in 2.15.10 and 2.15.11. The connections shall conform to 2.15.7.

SECTION 2.17 CAR AND COUNTERWEIGHT SAFETIES

2.17.1 Where Required and Location

The car of every elevator suspended as required by 2.20.1 shall be provided with one or more car safety devices of one of the types identified in 2.17.5. Safeties shall be attached to the car frame, and at least one safety shall be located within or below the car frame.

All car safeties shall be mounted on a single car frame and shall operate only on one pair of guide rails between which the frame is located.

2.17.2 Duplex Safeties

Where duplex (two) safeties are provided, the lower safety device shall be capable of developing not less than one-half of the force required to stop the entire car with rated load (see 2.16.8). Duplexed safety devices shall be arranged so as to function approximately simultaneously.

Type A or Type C safety devices (see 2.17.5) shall not be used in multiple (duplexed).

2.17.3 Function and Stopping Distance of Safeties

The safety device, or the combined safety devices, where furnished, shall be capable of stopping and sustaining the entire car with its rated load from governor tripping speed (see also 2.16.8).

Table 2.17.3 Maximum and Minimum Stopping Distances for Type B Car Safeties With Rated Load and Type B Counterweight Safeties

| SI Units | | | | Imperial Units | | | |
|------------------|----------------------------------|------------------------|--------|---------------------|-------------------------------------|-------------------------|------|
| Rated Speed, m/s | Maximum Governor Trip Speed, m/s | Stopping Distances, mm | | Rated Speed, ft/min | Maximum Governor Trip Speed, ft/min | Stopping Distances, in. | |
| | | Min. | Max. | | | Min. | Max. |
| 0–0.63 | 0.90 | 25 | 380 | 0–125 | 175 | 1 | 15 |
| 0.75 | 1.05 | 50 | 415 | 150 | 210 | 2 | 16 |
| 0.87 | 1.25 | 75 | 485 | 175 | 250 | 3 | 19 |
| 1.00 | 1.40 | 100 | 540 | 200 | 280 | 4 | 22 |
| 1.12 | 1.55 | 125 | 605 | 225 | 308 | 5 | 24 |
| 1.25 | 1.70 | 150 | 675 | 250 | 337 | 6 | 27 |
| 1.50 | 2.00 | 200 | 840 | 300 | 395 | 8 | 33 |
| 1.75 | 2.30 | 250 | 1 025 | 350 | 452 | 10 | 40 |
| 2.00 | 2.55 | 330 | 1 200 | 400 | 510 | 13 | 48 |
| 2.25 | 2.90 | 430 | 1 480 | 450 | 568 | 17 | 58 |
| 2.50 | 3.15 | 505 | 1 700 | 500 | 625 | 20 | 68 |
| 3.00 | 3.70 | 710 | 2 250 | 600 | 740 | 28 | 91 |
| 3.50 | 4.30 | 940 | 2 950 | 700 | 855 | 38 | 128 |
| 4.00 | 4.85 | 1 200 | 3 680 | 800 | 970 | 49 | 150 |
| 4.50 | 5.50 | 1 540 | 4 660 | 900 | 1,085 | 61 | 183 |
| 5.00 | 6.00 | 1 835 | 5 500 | 1,000 | 1,200 | 75 | 222 |
| 5.50 | 6.60 | 2 220 | 6 600 | 1,100 | 1,320 | 90 | 268 |
| 6.00 | 7.20 | 2 640 | 7 800 | 1,200 | 1,440 | 107 | 316 |
| 6.50 | 7.80 | 3 100 | 9 110 | 1,300 | 1,560 | 126 | 371 |
| 7.00 | 8.40 | 3 595 | 10 530 | 1,400 | 1,680 | 146 | 427 |
| 7.50 | 9.00 | 4 125 | 12 050 | 1,500 | 1,800 | 168 | 490 |
| 8.00 | 9.60 | 4 695 | 13 670 | 1,600 | 1,920 | 191 | 555 |
| 8.50 | 10.20 | 5 300 | 15 400 | 1,700 | 2,040 | 215 | 628 |
| 9.00 | 10.80 | 5 940 | 17 240 | 1,800 | 2,160 | 241 | 700 |
| 9.50 | 11.40 | 6 620 | 19 180 | 1,900 | 2,280 | 269 | 779 |
| 10.00 | 12.00 | 7 335 | 21 220 | 2,000 | 2,400 | 299 | 862 |

Type B safeties shall stop the car with its rated load from governor tripping speed within the range of the maximum and minimum stopping distances as determined by the formulas in 8.2.6. Table 2.17.3 and Fig. 8.2.6 show the maximum and minimum stopping distances for various governor tripping speeds, when tested in conformance with 8.10 and 8.11.

2.17.4 Counterweight Safeties

Counterweight safeties, where furnished [see 2.6 and 2.19.3.2(a)(1)], shall conform to the requirements for car safeties, except as specified in 2.17.7 and 2.18.1.

2.17.5 Identification and Classification of Types of Safeties

Car safety devices (safeties) are identified and classified on the basis of performance characteristics after the safety begins to apply pressure on the guide rails. On this basis, there are three types of safeties.

2.17.5.1 Type A Safeties. Safeties that develop a rapidly increasing pressure on the guide rails during the stopping interval, the stopping distance being very short due to the inherent design of the safety. The operating force is derived entirely from the mass and the motion of the car or the counterweight being stopped. These safeties apply pressure on the guide rails through eccentrics, rollers, or similar devices, without any flexible medium purposely introduced to limit the retarding force and increase the stopping distance.

2.17.5.2 Type B Safeties. Safeties that apply limited pressure on the guide rails during the stopping interval, and which provide stopping distances that are related to the mass being stopped and the speed at which application of the safety is initiated. Retarding forces are reasonably uniform after the safety is fully applied. Safeties that require or do not require continuous tension in the governor rope to operate the safety during the entire stopping interval shall be permitted. Minimum and

maximum distances are specified on the basis of governor tripping speed (see 2.17.3).

2.17.5.3 Type C Safeties (Type A With Oil Buffers).

Safeties that develop retarding forces during the compression stroke of one or more oil buffers interposed between the lower members of the car frame and a governor-operated Type A auxiliary safety plank applied on the guide rails. The stopping distance is equal to the effective stroke of the buffers.

2.17.6 Reserved for Future Use

2.17.7 Governor-Actuated Safeties and Car Safety Mechanism Switches Required

2.17.7.1 Counterweight safeties, where provided for rated speeds over 0.75 m/s (150 ft/min), and car safeties, shall be actuated by separate speed governors.

Counterweight safeties for rated speeds of not over 0.75 m/s (150 ft/min) shall be permitted to be operated as a result of the breaking or slackening of the suspension ropes and shall be permitted to be of the inertia or other approved type without governors.

Where counterweight safeties are furnished to provide ascending car overspeed protection in accordance with 2.19.1.1, they shall be actuated by a counterweight speed governor (see 2.17.4).

2.17.7.2 Every car safety shall be provided with a switch, operated by the car safety mechanism (see 2.26.2.9).

A switch operated by the safety mechanism is not required on counterweight safeties.

2.17.7.3 The car safety mechanism switch shall operate before or at the time of application of the safety.

2.17.7.4 Switches operated by the car safety mechanism shall be of a type that cannot be reset until the car safety mechanism has been returned to the unapplied position.

2.17.8 Limits of Use of Various Types of Safeties

2.17.8.1 Type A (Instantaneous) Safeties. Type A safeties shall be permitted on elevators having a rated speed of not more than 0.75 m/s (150 ft/min).

When overspeed occurs, with the hoisting rope intact, such safeties shall be actuated by the governor.

On the parting of the hoisting ropes (free fall), Type A governor-operated safeties shall apply without appreciable delay, and their application shall be independent of the speed action of the governor and of the location of the break in the hoisting ropes (inertia application), and shall be permitted to be accomplished by the use of a governor and governor rigging having a sufficiently high value of inertia to apply the safety on free fall independently of the speed action of the governor (see 8.10 for inertia-application test of car safety).

2.17.8.2 Type C (Combination Instantaneous and Oil-Buffer Safety). Type C safeties shall be permitted subject to the requirements of 2.17.8.2.1 through 2.17.8.2.8.

2.17.8.2.1 The rated speed shall be not more than 2.5 m/s (500 ft/min).

2.17.8.2.2 The oil buffers shall conform to all requirements specified in 2.22 for oil buffers, except that the stroke shall be based on governor tripping speed and on an average retardation not exceeding 9.81 m/s^2 (32.2 ft/s^2).

2.17.8.2.3 After the buffer stroke, as defined in 2.17.8.2.2, has been completed, provision shall be made for an additional travel of the plunger or piston of not less than 10% of the buffer stroke, to prevent excessive impact on the buffer parts and the auxiliary safety plank.

2.17.8.2.4 Where the distance between guide rails exceeds 2 450 mm (96 in.), the safety shall be provided with two oil buffers of substantially identical calibration, and the buffers shall be so located as to develop minimum stresses in the auxiliary safety plank during safety operation.

Buffers shall be located in line with and symmetrically between the guide rails.

2.17.8.2.5 The auxiliary safety plank shall be so supported and guided below the car frame that the clearances specified in 2.17.10 for the safety parts are maintained during normal operation.

The auxiliary safety plank shall be so designed that the maximum stresses in the plank shall not exceed those specified for similar car-frame members in 2.15.

2.17.8.2.6 The rail-gripping device of the auxiliary safety plank shall be so arranged and connected as to prevent the plank from being out of level more than 13 mm (0.5 in.) in the length of the plank when the safety is operated to stop the car.

2.17.8.2.7 An electric switch shall be provided and so arranged and connected that the elevator cannot be operated by means of the normal operating device if any buffer is compressed more than 10% of its stroke (see 2.26.2.13).

2.17.8.2.8 Means shall be provided to prevent operation of the elevator by means of the normal operating device if the oil level in buffer is below the minimum level (see 2.26.2.13).

2.17.9 Application and Release of Safeties

2.17.9.1 Means of Application. Safeties shall be applied mechanically. Electric, hydraulic, or pneumatic devices shall not be used to apply the safeties required by 2.17, nor to hold such safeties in the retracted position.

2.17.9.2 Level of Car on Safety Application. The application of a Type A or Type B safety to stop the car, with its rated load centered on each quarter of the platform symmetrically with relation to the centerlines of the platform, shall not cause the platform to be out of level more than 30 mm/m (0.36 in./ft) in any direction. (See 2.17.8.2.6 for Type C safeties.)

2.17.9.3 Release. When car safeties are applied, no decrease in tension in the governor rope or motion of the car in the down direction shall release the safeties, but such safeties shall be permitted to be released by the motion of the car in the up direction.

2.17.9.4 Force Providing Stopping Action to Be Compressive. Safeties shall be so designed that, on their application, the forces that provide the stopping action shall be compressive forces on each side of the guide-rail section.

2.17.10 Minimum Permissible Clearance Between Rail-Gripping Faces of Safety Parts

In the normally retracted position of the safety, the distance between the rail-gripping faces of the safety parts shall be not less than the thickness of the guide rail plus 3.5 mm (0.14 in.), and the clearance on any side between the gripping face and the guide rail shall be not less than 1.5 mm (0.06 in.), as measured on the side of the rail toward which the car frame is pressed with sufficient force to take up all clearances in the guide-shoe assembly. Safety jaws, while in the retracted position, shall be so restrained as to prevent a reduction of this minimum clearance.

2.17.11 Maximum Permissible Movement of Governor Rope to Operate the Safety Mechanism

For all Type B safeties, the movement of the governor rope, relative to the car or the counterweight, respectively, required to operate the safety mechanism from its fully retracted position to a position where the safety jaws begin to exert pressure against the guide rails, shall not exceed the following values based on rated speed:

- (a) for car safeties
 - (1) 1 m/s (200 ft/min) or less, 1 070 mm (42 in.)
 - (2) 1.01 m/s (201 ft/min) to 1.9 m/s (375 ft/min), 915 mm (36 in.)
 - (3) over 1.9 m/s (375 ft/min), 756 mm (30 in.)
- (b) for counterweight safeties, all speeds, 1 070 mm (42 in.)

Drum-operated car and counterweight safeties, requiring continual unwinding of the safety drum rope to fully apply the safety, shall be so designed that not less than three turns of the safety rope will remain on the drum after the overspeed test of the safety has been made with rated load in the car.

2.17.12 Minimum Factors of Safety and Stresses of Safety Parts and Rope Connections

2.17.12.1 Parts of safeties, except springs, safety-rope drums, leading sheaves, and their supporting brackets and safety-jaw gibs, shall have a factor of safety of not less than 3.5, and the materials used shall have an elongation of not less than 15% in a length of 50 mm (2 in.) when tested in accordance with ASTM E8. Forged, cast, or welded parts shall be stress relieved.

2.17.12.2 Springs are permitted in the operation of car or counterweight safeties. Where used, and where partially loaded prior to safety operation, the loading on the spring shall not produce a fibre stress exceeding one-half the elastic limit of the material. During operation of the safety, the fibre stress shall not exceed 85% of the elastic limit of the material. Helical springs, where used, shall be in compression.

2.17.12.3 Safety-rope drums, leading sheaves, and their supporting brackets and safety-jaw gibs, are permitted to be made of cast iron and other metals provided such parts have a factor of safety of not less than 10.

2.17.12.4 Rope used as a connection from the safety to the governor rope, including rope wound on the safety-rope drum, shall be not less than 9.5 mm (0.375 in.) in diameter, shall be made of metal, and shall be corrosion resistant. The factor of safety of the rope shall be not less than 5. Tiller-rope construction shall not be used.

2.17.12.5 The factors of safety shall be based upon the maximum stresses developed in the parts during the operation of the safety when stopping rated load from governor tripping speed.

2.17.12.6 Safety-rope leading sheave brackets and other safety operating parts shall not be attached to or supported by wood platform members.

2.17.13 Corrosion-Resistant Bearings in Safeties and Safety-Operating Mechanisms

Bearings in safeties and in the safety-operating mechanisms shall be of corrosion-resistant construction, with one or both members of the bearing made of, or electroplated with, a corrosion-resistant material.

2.17.14 Marking Plates for Safeties

A metal plate shall be securely attached to each safety so as to be readily visible, and shall be marked in a legible and permanent manner with letters and figures not less than 6 mm (0.25 in.) in height indicating:

- (a) the type of safety, based on 2.17.5
- (b) the maximum tripping speed in m/s (ft/min) for which the safety is permitted
- (c) the maximum weight in kg (lb), that the safety is designed and installed to stop and sustain

(d) the force in N (lbf) required to activate the safety or rope releasing carrier, if provided

(e) the manufacturer's name or trademark

2.17.15 Governor-Rope Releasing Carriers

Where a governor-rope releasing carrier is used to prevent actuation of the safety by the inertial forces of the governor-rope system, or used for any other purpose, the governor-rope releasing carrier on the car (or on the counterweight) shall be set to require a tension in the governor rope, to pull the rope from the carrier, of not more than 60% of the pull-through tension developed by the governor. The means to regulate the governor-rope pull-out force shall be mechanical and shall be sealed. The carrier shall be designed so that the pull-out tension cannot be adjusted to exceed the amount specified without breaking the seal.

2.17.16 Rail Lubricants and Lubrication Plate

Rail lubricants or coatings that will reduce the holding power of the safety, or prevent its functioning as required in 2.17.3, shall not be used (see 8.7 for maintenance requirements).

A metal plate as required by 2.16.3.2 shall be securely attached to the car crosshead in an easily visible location, and, where lubricants are to be used, shall carry the notation, "CONSULT MANUFACTURER OF THE SAFETY FOR THE CHARACTERISTICS OF THE RAIL LUBRICANT TO BE USED." If lubricants are not to be used, the plate shall so state.

If lubricants other than those recommended by the manufacturer are used, a safety test shall be made to demonstrate that the safety will function as required by 2.17.3.

SECTION 2.18 SPEED GOVERNORS

2.18.1 Speed Governors Required and Location

2.18.1.1 Counterweight safeties, where provided with rated speeds over 0.75 m/s (150 ft/min), and car safeties shall be actuated by separate speed governors.

Where counterweight safeties are furnished to provide ascending car overspeed protection in accordance with 2.19.1.1, they shall be actuated by a counterweight speed governor (see 2.17.4).

2.18.1.2 The governor shall be located where it cannot be struck by the car or the counterweight in case of overtravel, and where there is adequate space for full movement of governor parts.

2.18.2 Tripping Speeds for Speed Governors

2.18.2.1 Car Speed Governors. Speed governors for car safeties shall be set to trip at car speeds as follows:

(a) at not less than 115% of the rated speed.

(b) at not more than the tripping speed listed opposite the applicable rated speed in Table 2.18.2.1. Maximum tripping speeds for intermediate rated speeds shall be determined from Fig. 8.2.5. For rated speeds exceeding 10 m/s (2,000 ft/min), the maximum tripping speeds shall not exceed 120% of the rated speed.

2.18.2.2 Counterweight Speed Governors. Speed governors, where provided for counterweight safeties, shall be set to trip at an overspeed greater than that at which the car speed governor is to trip, but not more than 10% higher.

2.18.3 Sealing and Painting of Speed Governors

2.18.3.1 Speed governors shall have their means of speed adjustment sealed after test. If speed governors are painted after sealing, all bearing and rubbing surfaces shall be kept free or freed of paint and a hand test made to determine that all parts operate freely as intended.

2.18.3.2 Where the rope retarding means provides for adjustment of the rope pull-through force (tension), means shall be provided to seal the means of adjustment of the rope tension.

2.18.3.3 Seals shall be of a type that will prevent readjustment of the sealed governor adjustments without breaking the seal. Provision shall be made to enable affixing seals after tests.

2.18.4 Speed-Governor Overspeed Switch

2.18.4.1 Where Required and Function

2.18.4.1.1 A switch shall be provided on every car and counterweight speed governor (see 2.26.2.10).

2.18.4.1.2 The switches required in 2.18.4.1.1 shall be positively opened and operated by the overspeed action of the governor, except that the counterweight governor switch shall be permitted to be operated upon activation of the counterweight governor-rope retarding means (see 2.18.6.1). (13)

2.18.4.1.3 The switches required in 2.18.4.1.1 shall remain in the open position until manually reset. (13)

NOTE: Manual reset includes means such as a finger, hand or cable-actuated lever, cam, etc., or some form of electromechanical actuation from the location of elevator controllers located outside the hoistway or the enclosure as specified in 2.7.6.5.

2.18.4.2 Setting of Car Speed-Governor Overspeed Switches. The setting of the car speed-governor overspeed switch shall conform to 2.18.4.2.1 through 2.18.4.2.5.

2.18.4.2.1 For rated speeds more than 0.75 m/s (150 ft/min), up to and including 2.5 m/s (500 ft/min), the car speed-governor overspeed switch shall open in the down direction of the elevator at not more than 90%

Table 2.18.2.1 Maximum Car Speeds at Which Speed Governor Trips and Governor Overspeed Switch Operates

| SI Units | | | Imperial Units | | |
|------------------|--------------------------------------|--|---------------------|---|---|
| Rated Speed, m/s | Maximum Car Governor Trip Speed, m/s | Maximum Car Speed at Which Governor Operates, Down, m/s [Note (1)] | Rated Speed, ft/min | Maximum Car Governor Trip Speed, ft/min | Maximum Car Speed at Which Governor Operates, Down, ft/min [Note (1)] |
| 0–0.63 | 0.90 | 0.81 | 0–125 | 175 | 175 |
| 0.75 | 1.05 | 0.95 | 150 | 210 | 210 |
| 0.87 | 1.25 | 1.13 | 175 | 250 | 225 |
| 1.00 | 1.40 | 1.26 | 200 | 280 | 252 |
| 1.12 | 1.55 | 1.40 | 225 | 308 | 277 |
| 1.25 | 1.70 | 1.53 | 250 | 337 | 303 |
| 1.50 | 2.00 | 1.80 | 300 | 395 | 355 |
| 1.75 | 2.30 | 2.07 | 350 | 452 | 407 |
| 2.00 | 2.55 | 2.30 | 400 | 510 | 459 |
| 2.25 | 2.90 | 2.61 | 450 | 568 | 512 |
| 2.50 | 3.15 | 2.84 | 500 | 625 | 563 |
| 3.00 | 3.70 | 3.52 | 600 | 740 | 703 |
| 3.50 | 4.30 | 4.09 | 700 | 855 | 812 |
| 4.00 | 4.85 | 4.61 | 800 | 970 | 921 |
| 4.50 | 5.50 | 5.23 | 900 | 1,085 | 1,031 |
| 5.00 | 6.00 | 5.70 | 1,000 | 1,200 | 1,140 |
| 5.50 | 6.60 | 6.27 | 1,100 | 1,320 | 1,254 |
| 6.00 | 7.20 | 6.84 | 1,200 | 1,440 | 1,368 |
| 6.50 | 7.80 | 7.41 | 1,300 | 1,560 | 1,482 |
| 7.00 | 8.40 | 7.98 | 1,400 | 1,680 | 1,596 |
| 7.50 | 9.00 | 8.55 | 1,500 | 1,800 | 1,710 |
| 8.00 | 9.60 | 9.12 | 1,600 | 1,920 | 1,824 |
| 8.50 | 10.20 | 9.69 | 1,700 | 2,040 | 1,938 |
| 9.00 | 10.80 | 10.26 | 1,800 | 2,160 | 2,052 |
| 9.50 | 11.40 | 10.83 | 1,900 | 2,280 | 2,166 |
| 10.00 | 12.00 | 11.40 | 2,000 | 2,400 | 2,280 |

NOTE:

(1) See 2.18.4.2.5.

of the speed at which the governor is set to trip in the down direction.

2.18.4.2.2 For rated speeds more than 2.5 m/s (500 ft/min), the car speed-governor overspeed switch shall open in the down direction of the elevator at not more than 95% of the speed at which the governor is set to trip in the down direction.

2.18.4.2.3 For elevators with static control, the car speed-governor overspeed switch shall open in the down direction of the elevator at not more than 90% of the speed at which the governor is set to trip in the down direction.

2.18.4.2.4 The switch, when set as specified in either 2.18.4.2.1, 2.18.4.2.2, or 2.18.4.2.3, shall open in the

up direction at not more than 100% of the speed at which the governor is set to trip in the down direction.

2.18.4.2.5 The speed-governor overspeed switch shall be permitted to open in the down direction of the elevator at not more than 100% of the speed at which the governor is set to trip in the down direction, subject to the following requirements: (13)

(a) A speed-reducing switch conforming to 2.18.4.1.3 is provided on the governor, that will reduce the speed of the elevator in case of overspeed, and that shall be set to open as specified in 2.18.4.2.1, 2.18.4.2.2, or 2.18.4.2.3.

(b) Subsequent to the first stop of the car following the opening of the speed-reducing switch, the car shall remain inoperative until the switch is manually reset.

2.18.4.3 Setting of the Counterweight Governor Switch. Where the counterweight governor switch is operated by the overspeed action (see 2.18.2.2), the switch shall be set to open when the counterweight is descending at a speed greater than the elevator rated speed, but not more than the speed at which the counterweight governor is set to trip.

(13) 2.18.4.4 DELETED

2.18.5 Governor Ropes

Governor ropes shall comply with the requirements of ASME A17.6, Part 1, and 2.18.5.1 through 2.18.5.3.

2.18.5.1 Material and Factor of Safety. Governor ropes shall be made of iron, steel, monel metal, phosphor bronze, or stainless steel. They shall be of a regular-lay construction and not less than 6 mm (0.25 in.) in diameter. The factor of safety of governor ropes shall be not less than 5. Where provided, ropes of a diameter less than 9.5 mm (0.375 in.) shall have a factor of safety of not less than 8 and shall be of a six-, eight-, or nine-strand construction. Tiller-rope construction shall not be used.

2.18.5.2 Speed-Governor-Rope Clearance. During normal operation of the elevator, the governor rope shall run free and clear of the governor jaws, rope guards, or other stationary parts.

2.18.5.3 Governor-Rope Tag. A metal data tag shall be securely attached to the governor-rope fastening. This data tag shall bear the following wire-rope data:

- (a) the diameter (mm or in.)
- (b) the manufacturer's rated breaking strength
- (c) the grade of material used
- (d) the year and month the rope was installed
- (e) whether nonpreformed or preformed
- (f) construction classification
- (g) name of the person or organization who installed the rope
- (h) name or trademark by which the manufacturer of the rope can be identified

A new tag shall be installed at each rope renewal. The material and marking of the rope data tag shall conform to 2.16.3.3, except that the height of the letters and figures shall be not less than 1.5 mm (0.06 in.).

2.18.6 Design of Governor-Rope Retarding Means for Type B Safeties

Type B car and counterweight safeties shall be activated by a speed governor with a governor-rope retarding means conforming to 2.18.6.1 through 2.18.6.5.

2.18.6.1 Upon activation at the tripping speeds given by 2.18.2, the means shall retard the rope with a force that is at least 67% greater than the force required to

activate the safety or to trip the governor-rope releasing carrier, where used (see 2.17.15).

2.18.6.2 The means shall be set to allow the governor rope to slip through the speed governor at a rope tension (the governor pull-through tension) higher than required to activate the safety or to trip the releasing carrier as specified in 2.17.15. The maximum tension in the rope shall not exceed one-fifth of the rated ultimate strength of the rope.

2.18.6.3 The means shall be designed to prevent appreciable damage to, or deformation of, the governor rope resulting from its application (stopping action).

2.18.6.4 The means shall provide a continuous tension in the governor rope as required to operate the safety during the entire stopping interval in accordance with 2.17.5.2.

2.18.6.5 The governor shall be arranged to be manually tripped or activated to facilitate the tests specified in 8.10 and 8.11.

NOTE: Manually tripped or activated includes means such as but not limited to a finger, hand or cable-actuated lever, cam, etc., or some form of electromechanical actuation.

2.18.7 Design of Speed-Governor Sheaves and Traction Between Speed-Governor Rope and Sheave

2.18.7.1 The arc of contact between the governor rope and the governor sheave shall, in conjunction with a governor-rope tension device, provide sufficient traction to cause proper functioning of the governor.

2.18.7.2 Where jawless governors are used and where the force imparted to the governor rope (see 2.18.6.1) is necessary to activate the safety, including tripping the releasing carrier, if used, and is dependent upon the tension in the governor rope, a switch or switches shall be provided that is mechanically opened by the governor tension sheave before the sheave reaches its upper or lower limit of travel. This switch(es) shall be of the manually reset type and shall conform to 2.26.4.3. Subsequent to the first stop of the car following the opening of the switch, the car shall remain inoperative until the switch is manually reset.

2.18.7.3 Governor sheave grooves shall have machine-finished surfaces. Governor tension sheaves shall have machine-finished grooves for rated car speeds of more than 0.75 m/s (150 ft/min). Machined governor sheave grooves shall have a groove diameter of not more than 1.15 times the diameter of the governor rope.

2.18.7.4 Where governor ropes of a diameter of 9.5 mm (0.375 in.) or greater are used, the pitch diameter of governor sheaves and governor tension sheaves shall be not less than the product of the diameter of the rope

Table 2.18.7.4 Multiplier for Determining Governor Sheave Pitch Diameter

| Rated Speed, m/s (ft/min) | Number of Strands | Multiplier |
|------------------------------|-------------------|------------|
| 1.00 or less (200 or less) | 6 | 42 |
| 1.00 or less (200 or less) | 8 or 9 | 30 |
| Over 1.00 (over 200) | 6 | 46 |
| Over 1.00 (over 200) | 8 or 9 | 32 |

and the applicable multiplier listed in Table 2.18.7.4, based on the rated speed and the number of strands in the rope. Where governor ropes of a diameter less than 9.5 mm (0.375 in.) are used, the governor sheave shall have a pitch diameter of not less than the product of the diameter of the rope and a multiplier of 30.

2.18.8 Factors of Safety in Load-Bearing Parts of Speed Governor

2.18.8.1 Material, except cast iron, used in load-bearing parts of speed governors shall have a factor of safety of not less than 3.5, and the materials used shall have an elongation of not less than 15% in a length of 50 mm (2 in.) when tested in accordance with ASTM E8. Forged, cast, or welded parts shall be stress relieved. Cast iron shall have a factor of safety of not less than 10.

2.18.8.2 The factors of safety shall be based upon the maximum stresses developed in the parts during normal or governor tripping operation.

2.18.9 Speed-Governor Marking Plate

A metal plate shall be securely attached to each speed governor and shall be marked in a legible and permanent manner with letters and figures not less than 6 mm (0.25 in.) in height indicating the following:

(a) the speed in m/s (ft/min) at which the governor is set and sealed to trip the governor-rope retarding means

(b) the size, material, and construction of the governor rope on which the governor-rope retarding means were designed to operate

(c) the governor pull-through tension (force) in N (lbf) (see 2.18.6.2)

(d) manufacturer's name or trademark

(e) statement "DO NOT LUBRICATE GOVERNOR ROPE"

SECTION 2.19 ASCENDING CAR OVERSPEED AND UNINTENDED CAR MOVEMENT PROTECTION

2.19.1 Ascending Car Overspeed Protection

2.19.1.1 Purpose. Ascending car overspeed protection shall be provided to prevent the car from striking the hoistway overhead structure as a result of a failure in

(a) the electric driving-machine motor, brake, coupling, shaft, or gearing

(b) the control system

(c) any other component upon which the speed of the car depends, except the suspension ropes and the drive sheave of the traction machine

2.19.1.2 Where Required and Function. All electric traction elevators, except those whose empty car weight exceeds the total weight of the suspension ropes and counterweight, shall be provided with a device to prevent an ascending elevator from striking the hoistway overhead structure. This device (see 2.26.2.29) shall

(a) detect an ascending car overspeed condition at a speed not greater than 10% higher than the speed at which the car governor is set to trip (see 2.18.2.1).

(1) If the overspeed detection means requires electrical power for its functioning

(a) a loss of electrical power to the ascending car overspeed detection and control means shall cause the immediate activation of the emergency brake as required in 2.19.1.2(b)

(b) the occurrence of a single ground, or the failure of any mechanically operated switch that does not meet the requirements of 2.26.4.3.1, any single magnetically operated switch, contactor, or relay, or any single solid-state device, or a failure of a software system not conforming to 2.26.4.3.2, shall not render the detection means inoperative

(2) The failure of any single mechanically operated switch that does not meet the requirements of 2.26.4.3 shall not render the detection means inoperative.

(3) When a fault specified in 2.19.1.2(a)(1)(b) or 2.19.1.2(a)(2) is detected, the car shall stop at or before the next landing for which a demand was registered, and shall not be permitted to restart.

(4) Once actuated by overspeed, the overspeed detection means shall remain actuated until manually reset, and the car shall not start or run unless the detection means is reset.

(b) decelerate the car when loaded with any load up to its rated load [see 2.16.8(h)] by applying an emergency brake conforming to 2.19.3. The car shall not start or run unless the emergency brake is reset.

2.19.2 Unintended Car Movement Protection

2.19.2.1 Purpose. Protection shall be provided with a means to detect unintended car movement (see 1.3) and stop the car movement, as a result of failure in any of the following:

(a) electric driving-machine motor, brake, coupling, shaft, or gearing

(b) control system

(c) any other component upon which intended car movement depends, except suspension means and drive sheave of the traction machine

(ED) **2.19.2.2 Where Required and Function.** All electric traction elevators shall be provided with a means (see 2.26.2.30) that shall

(a) detect unintended car movement in either direction away from the landing with the hoistway door not in the locked position and the car door or gate not in the closed position.

NOTE [2.19.2.2(a)]: Freight elevators provided with combination mechanical locks and contacts on the hoistway door shall detect the closed position of the hoistway door and the closed position of the car door or gate.

(1) If the detection means requires electrical power for its functioning, then

(a) a loss of electrical power to the unintended movement detection and control means shall cause the immediate activation of the emergency brake as required in 2.19.2.2(b)

(b) the occurrence of a single ground, or the failure of any mechanically operated switch that does not meet the requirements of 2.26.4.3.1, any single magnetically operated switch, contactor, or relay, or any single solid-state device, or a failure of a software system not conforming to 2.26.4.3.2, shall not render the detection means inoperative

(2) The failure of any single mechanically operated switch that does not meet the requirements of 2.26.4.3, shall not render the detection means inoperative.

(3) When a fault specified in 2.19.2.2(a)(1)(b) or 2.19.2.2(a)(2) is detected, the car shall stop at or before the next landing for which a demand was registered, and shall not be permitted to restart.

(4) Once actuated by unintended movement, the detection means shall remain actuated until manually reset, and the car shall not start or run unless the detection means is reset.

(b) upon detection of unintended car movement, stop and hold the car, with any load up to rated load [see also 2.16.8(h)], by applying an emergency brake conforming to 2.19.3. The stopped position of the car shall be limited in both directions, to a maximum of 1 220 mm (48 in.) as measured from the landing sill to the car sill. The car shall not start or run unless the emergency brake provided for the unintended movement protection is reset.

2.19.3 Emergency Brake (See Nonmandatory Appendix F)

2.19.3.1 Where Required

2.19.3.1.1 When required by 2.19.1 for protection against ascending car overspeed, an emergency brake (see 1.3) conforming to 2.19.3.2 shall be provided.

2.19.3.1.2 When required by 2.19.2 for protection against unintended car movement, an emergency brake (see 1.3) conforming to 2.19.3.2 shall be provided.

2.19.3.1.3 When required by 2.25.4.1.1 to reduce the car and counterweight speed such that the rated buffer striking speed is not exceeded, an emergency brake (see 1.3) conforming to 2.19.3.2 shall be provided. (13)

2.19.3.1.4 A single device shall be permitted to meet the requirements of 2.19.3.1.1, 2.19.3.1.2, and 2.19.3.1.3, or separate devices shall be provided. (13)

2.19.3.2 Requirements. The emergency brake is permitted to consist of one or more devices and shall (13)

(a) function to decelerate the car by acting on one or more of the following (see also 2.19.4):

(1) counterweight [e.g., counterweight safety (see 2.17.4 and 2.17.7)]

(2) car

(3) suspension or compensation means system

(4) drive sheave of a traction machine

(5) brake drum or braking surface of the driving-machine brake, provided that the driving-machine brake surface is integral (cast or welded) with or directly attached to the driving-machine sheave. Attachments, where used, shall conform to 2.24.3 and 2.24.4.1. Welding, where used, shall conform to 8.8.

(b) be mechanically independent of the driving-machine brake [see also 2.19.3.2(a)(5)]

(c) not be used to provide, or assist in providing, the stopping of the car when on automatic operation, unless applied as required in 2.19.1, 2.19.2, and 2.25.4.1.1, or as permitted in 2.19.3.2(e) and (f)

(d) be permitted to be applied only after the car is stopped when on automatic operation, except as required in 2.19.1, 2.19.2, and 2.25.4.1.1

(e) be permitted to be applied to a stationary or moving braking surface when any electrical protective device (2.26.2) is actuated

(f) be permitted to be applied to a stationary or moving braking surface when on continuous-pressure operation (e.g., continuous-pressure inspection operation, inspection operation with open door circuits, or hoistway access operation)

(g) not require the application of electrical power for its activation, nor be rendered inoperative by the failure of any power supply

(h) not on its own cause the car average retardation to exceed 9.8 m/s^2 (32.2 ft/s^2) during the stopping or slowdown phase during ascending car overspeed

(i) be designed so that the factors of safety based on the maximum stresses developed in the parts subject to load during the operation of the emergency brake shall comply with the following:

(1) Where an emergency brake is applied only when protecting against either an ascending car overspeed condition or unintended car movement with the car and hoistway doors open, the minimum factors of safety, when applied during the retardation phase of

emergency braking, shall be not less than those specified in 2.17.12.1.

(2) Where an emergency brake is applied as permitted in 2.19.3.2(d), (e), and (f), the minimum factors of safety, when applied during the retardation phase of emergency braking, shall be not less than those specified in 2.24.3.1 and 2.24.3.2. Degradation of the emergency brake due to wear shall be considered.

(3) Where an emergency brake acts on the suspension or compensation means

(a) the factor of safety with respect to the breaking strength of the suspension and compensation member shall be not less than 5 at any time during the retardation phase, and

(b) it shall be designed to prevent appreciable damage or deformation to the suspension and compensation member resulting from its activation

(j) be arranged to be tested in accordance with the requirements specified in 8.10.2

(k) if the design of the emergency brake is such that field adjustment or servicing is required and the emergency brake acts on the brake drum or braking surface of the driving-machine brake, it shall be provided with a sign stating "EMERGENCY BRAKE." The sign shall be located on the emergency brake at a location visible from the area likely to require service. The sign shall be of such material and construction that the letters shall remain permanently and readily legible. The height of the letters shall be not less than 6 mm (0.25 in.).

2.19.3.3 Marking Plate Requirements. The emergency brake shall be provided with a marking plate indicating the range of total masses (car with attachments and its load) for which it is permitted to be used, the range of speeds at which it is set to operate, and the criteria such as rail lubrication requirements that are critical to the performance.

2.19.4 Emergency Brake Supports

All components and structural members, including their fastenings, subjected to forces due to the application of the emergency brake shall be designed to withstand the maximum forces developed during the retardation phase of the emergency braking so that the resulting stresses shall not exceed those permitted for the applicable type of equipment as follows:

- (a) machinery and sheave beams (see 2.9.6)
- (b) guide rails and their supports (see 2.23.5.3)
- (c) counterweight frames (see 2.21.2.3.3)
- (d) car frames (see 2.15.10.2)
- (e) machines, sheaves, and bedplates (see 2.24.3.2)

SECTION 2.20

SUSPENSION MEANS AND THEIR CONNECTIONS

2.20.1 Suspension Means

Elevator cars and counterweights shall be suspended by steel wire ropes, aramid fiber ropes, or noncircular

elastomeric-coated steel suspension members attached to the car frame or passing around sheaves attached to the car frame specified in 2.15.1. Suspension means that have previously been installed and used on another installation shall not be reused. All suspension members in a set of suspension means shall be the same material, grade, construction, and dimensions. A suitable means shall be provided to protect the suspension means during the installation process.

Only the following shall be permitted:

(a) steel wire ropes constructed in accordance with ASME A17.6, Part 1

(b) aramid fiber ropes constructed in accordance with ASME A17.6, Part 2

(c) noncircular elastomeric-coated steel suspension members constructed in accordance with ASME A17.6, Part 3

2.20.2 Suspension-Means Data

2.20.2.1 Crosshead Data Plate. The crosshead data plate required by 2.16.3 shall bear the following suspension-means data:

(a) type of suspension means

(b) the number of suspension members

(c) either the diameter or the width and thickness in millimeters (mm) or inches (in.), as applicable

(d) the elevator manufacturer's required minimum breaking force per suspension member in kilo Newtons (kN) or pounds-force (lbf), as applicable

2.20.2.2 Data Tag at Suspension-Means Fastening

2.20.2.2.1 Pertinent data located on the suspension means shall be provided by one of the following:

(a) A data tag securely attached to one of the suspension-means fastenings.

(b) Permanent marking of the required information on the suspension means and visible in the vicinity of the suspension-means fastening.

(c) A combination of (a) and (b) provided that all required information is furnished.

(d) If (a) or (c) applies, the material and marking of the tag shall conform to 2.16.3.3, except that the height of the letters and figures shall be not less than 1.5 mm (0.06 in.).

(e) If (a) or (c) applies, a new tag shall be installed at each suspension-means replacement.

2.20.2.2.2 The following data shall be provided:

(a) type of suspension (steel wire rope, aramid fiber rope, or noncircular elastomeric-coated steel suspension member)

(b) either the diameter or the width and thickness in millimeters or inches, as applicable

(c) the suspension-means manufacturer's minimum breaking force in kN or lbf, as applicable

(d) the residual strength determined by the elevator manufacturer in kN or lbf, as applicable

(e) the grade of material used or the suspension-means manufacturer's designation, as applicable

(f) construction classification, where applicable

(g) for steel wire rope, non-preformed, if applicable

(h) for steel wire rope, finish coating, if applicable

(i) for steel wire rope, compacted strands, if applicable

(j) name or trademark of the suspension-means manufacturer

(k) name of person or organization who installed the suspension means

(l) the month and year the suspension means were installed

(m) the month and year the suspension means were first shortened

(n) lubrication information, if applicable

(ED) 2.20.3 Factor of Safety

The factor of safety of the suspension means shall be not less than shown in Table 2.20.3. Figure 8.2.7 gives the minimum factor of safety for intermediate speeds. The factor of safety shall be based on the actual speed of the suspension means corresponding to the rated speed of the car.

Where suspension means are different from traditional steel wire ropes, technical criteria for essential safety requirements and parameters, such as minimum factor of safety, monitoring, residual strength, replacement, etc., shall be selected on the basis of best engineering practice compatible with the product technology, including performance testing under elevator operating conditions for its range of application.

The minimum factor of safety for any suspension means shall be not less than the values shown in Table 2.20.3 except that the factor of safety of steel wire suspension ropes with diameters equal to or greater than 8 mm (0.315 in.) but less than 9.5 mm (0.375 in.) shall be not less than 12 or they shall meet the requirements of 2.20.8.2. See also Nonmandatory Appendix U.

The factor of safety shall be calculated by the following formula:

$$f = \frac{S \times N}{W}$$

where

N = number of runs of suspension members under load. For 2:1 arrangements, N shall be two times the number of suspension members used, etc.

S = manufacturer's rated breaking force in kN (lbf) of one suspension member

W = maximum static load in kN (lbf) imposed on all suspension members with the car and its rated load at any position in the hoistway

Table 2.20.3 Minimum Factors of Safety for Suspension Members

| Suspension-Member Speed, m/s (ft/min) | Minimum Factor of Safety | |
|--|--------------------------|---------|
| | Passenger | Freight |
| 0.25 (50) | 7.60 | 6.65 |
| 0.37 (75) | 7.75 | 6.85 |
| 0.50 (100) | 7.97 | 7.00 |
| 0.62 (125) | 8.10 | 7.15 |
| 0.75 (150) | 8.25 | 7.30 |
| 0.87 (175) | 8.40 | 7.45 |
| 1.00 (200) | 8.60 | 7.65 |
| 1.12 (225) | 8.75 | 7.75 |
| 1.25 (250) | 8.90 | 7.90 |
| 1.50 (300) | 9.20 | 8.20 |
| 1.75 (350) | 9.50 | 8.45 |
| 2.00 (400) | 9.75 | 8.70 |
| 2.25 (450) | 10.00 | 8.90 |
| 2.50 (500) | 10.25 | 9.15 |
| 2.75 (550) | 10.45 | 9.30 |
| 3.00 (600) | 10.70 | 9.50 |
| 3.25 (650) | 10.85 | 9.65 |
| 3.50 (700) | 11.00 | 9.80 |
| 3.75 (750) | 11.15 | 9.90 |
| 4.00 (800) | 11.25 | 10.00 |
| 4.25 (850) | 11.35 | 10.10 |
| 4.50 (900) | 11.45 | 10.15 |
| 4.75 (950) | 11.50 | 10.20 |
| 5.00 (1,000) | 11.55 | 10.30 |
| 5.25 (1,050) | 11.65 | 10.35 |
| 5.50 (1,100) | 11.70 | 10.40 |
| 5.75 (1,150) | 11.75 | 10.45 |
| 6.00 (1,200) | 11.80 | 10.50 |
| 6.25 (1,250) | 11.80 | 10.50 |
| 6.50 (1,300) | 11.85 | 10.55 |
| 6.75 (1,350) | 11.85 | 10.55 |
| 7.00–10.00 (1,400–2,000) | 11.90 | 10.55 |

2.20.4 Minimum Number and Diameter of Suspension Means

2.20.4.1 Steel Wire Ropes. The minimum number of suspension members used shall be three for traction elevators and two for drum-type elevators.

Where a car counterweight is used, the number of counterweight ropes used shall be not less than two.

The term "diameter," where used in reference to ropes, shall refer to the nominal diameter as given by the rope manufacturer.

The minimum diameter of hoisting and counterweight ropes shall be 4.0 mm (0.156 in.). Outer wires of steel wire ropes shall be not less than 0.21 mm (0.008 in.) in diameter.

2.20.4.2 Aramid Fiber Ropes. The minimum number of suspension members used shall be three. The term “diameter,” where used in reference to ropes, shall refer to the nominal diameter as given by the rope manufacturer. Aramid fiber ropes shall not be used on drum machines.

2.20.4.3 Noncircular Elastomeric-Coated Steel Suspension Members. The minimum number of suspension members used shall be three. Noncircular elastomeric-coated steel suspension members shall not be used on drum machines.

2.20.5 Suspension-Member Equalizers

2.20.5.1 Suspension-member equalizers, where provided, shall be of the individual compression-spring type or shall meet the requirements of 2.20.5.3. Springs in tension shall not be used to attach suspension members.

2.20.5.2 Single-bar-type equalizers shall be permitted only for winding-drum machines with two steel wire ropes, to attach the ropes to the dead-end hitch plate, provided it meets the requirements of 2.20.5.3.

2.20.5.3 Equalizers other than the individual compression-spring type shall be permitted, provided that their strength is established through tensile engineering tests. Such tests shall show the ultimate strength of the equalizers and its fastenings in its several parts and assembly to be not less than 10% in excess of the strength of the suspension members as required by 2.20.3.

2.20.6 Securing of Suspension Steel Wire Ropes to Winding Drums

Suspension steel wire ropes of winding-drum machines shall have the drum ends of the ropes secured on the inside of the drum by clamps.

Where the ropes extend beyond their clamps or sockets, means shall be provided to prevent the rope ends from coming out of the inside of the drum and to prevent interference with other parts of the machine.

2.20.7 Rope Turns on Winding Drums

Suspension wire ropes of winding-drum machines shall have not less than one full turn of the rope on the drum when the car is resting on the fully compressed buffers. Winding-drum machines shall not have multiple layers of suspension wire ropes.

2.20.8 Suspension-Means Monitoring and Protection

(ED) 2.20.8.1 Protection Against Traction Loss. All electric traction elevators shall be provided with a traction-loss detection means to detect loss of traction between suspension members and the drive sheave [see 8.6.1.2.1(f)]. This means shall

(a) be based upon the type of suspension members and the application.

(b) detect relative motion [see 2.20.11, 8.10.2.2.2(cc)(3), and 8.6.4.19.12] between the drive sheave and suspension members before any suspension member parts, and function in accordance with 2.20.8.1(c) in not greater than the smaller of the following:

(1) 45 sec

(2) the time for traveling the full travel, plus 10 sec, with a minimum of 20 sec if the full travel is less than 10 sec

NOTE [2.20.8.1(b)]: This relative motion between suspension members and drive sheave is independent of normal creep (see Section 1.3) of the suspension members. Compliance with the detection requirement can be accomplished by any method that will determine the relative position of the suspension means with respect to the rotational position of the drive sheave. This can be accomplished by timers or position- and velocity-measuring devices, as an example.

(c) when actuated, cause the removal of electrical power from the driving-machine motor and brake. The means shall comply with the requirements of 2.26.4.4, 2.26.7, 2.26.8.3, 2.26.9.5.3, and 2.26.9.6.3. No single ground shall render the traction-loss detection means ineffective.

(d) once actuated by traction loss, comply with the following:

(1) The traction-loss detection means shall remain actuated until manually reset.

(2) The car shall not start or run unless the traction-loss detection means is manually reset [see 8.6.1.2.1(f) and 8.6.11.11].

(3) The manual-reset means shall be key-operated or behind a locked cover. The key shall be Group 1 Security (see Section 8.1).

(4) The removal or restoration of main line power shall not reset the traction-loss detection means.

(e) be arranged to be tested in accordance with the requirements in 8.10.2.2.2(cc)(3)(c) and 8.6.4.19.12.

(f) be included in the Maintenance Control Program [see 8.6.1.2.1(f)] with sufficient detail to ensure that testing can be accomplished by elevator personnel.

2.20.8.2 Broken Suspension Member. All electric traction elevators, excluding those with steel wire ropes greater than or equal to 8 mm (0.315 in.), shall be provided with a broken-suspension-member detection means. The means shall

(a) operate at or before the separation of a suspension member

(b) when actuated, automatically function to stop the car in a controlled manner at or before the next landing for which a demand was registered, and the elevator shall not be permitted to restart except on hoistway access or inspection operation

(c) be arranged to be tested in accordance with the requirements in 8.10.2.2.2(ss)(1), and instructions for testing shall be included in the Maintenance Control

Program [see 8.6.1.2.1(f)] with sufficient detail to ensure that testing can be accomplished by elevator personnel

(d) remain actuated until manually reset

NOTE [2.20.8.2(d)]: This does not require the means itself to remain actuated, only that the elevator shall not be permitted to restart except on hoistway access or inspection operation until a manual reset is performed.

(ED) 2.20.8.3 Suspension-Member Residual Strength.

All electric traction elevators, excluding those with steel wire ropes, shall be provided with residual-strength detection means. The means shall

(a) operate before any suspension member is reduced in strength to 60% of its rated breaking force

(b) when actuated, automatically function to stop the car at the next available landing, open the doors, and prevent the elevator from restarting except on hoistway access or inspection operation

(c) be arranged to be tested in accordance with the requirements in 8.10.2.2.2(ss)(2), and instructions for testing shall be included in the Maintenance Control Program [see 8.6.1.2.1(f)] with sufficient detail to ensure that testing can be accomplished by elevator personnel

(d) remain actuated until manually reset

NOTE [2.20.8.3(d)]: This does not require the means itself to remain actuated, only that the elevator shall not be permitted to restart except on hoistway access or inspection operation until a manual reset is performed.

2.20.9 Suspension-Member Fastening

Both ends of all suspension members shall be fastened in such a manner that all portions of the individual suspension members, except the portion inside the sockets, shall be readily visible.

2.20.9.1 Types of Suspension-Member Fastenings

2.20.9.1.1 Fastenings shall be

(a) by individual tapered member sockets conforming to 2.20.9.4 or other types of fastenings that have undergone adequate tensile engineering tests, provided that

(1) such fastenings conform to 2.20.9.2 and 2.20.9.3;

(2) the member socketing shall be such as to develop at least 80% of the ultimate breaking strength (minimum breaking force) of the strongest member to be used in such fastenings; or

(b) by individual wedge rope sockets conforming to 2.20.9.5; or

(c) by individual wedge noncircular elastomeric-coated steel suspension-member sockets conforming to 2.20.9.9; and

(d) from the same manufacturer and type for any one dead-end hitch plate

2.20.9.1.2 U-bolt-type rope clamps or similar devices shall not be used for suspension-rope fastenings.

2.20.9.2 Adjustable Shackle Rods. The car ends, or the car or counterweight dead ends where multiple

roping is used, of all suspension means of traction-type elevators shall be provided with shackle rods of a design that will permit individual adjustment of the suspension-member lengths. Similar shackle rods shall be provided on the car or counterweight ends of compensation means.

2.20.9.3 General Design Requirements. Suspension-means fastenings shall conform to 2.20.9.3.1 through 2.20.9.3.9.

2.20.9.3.1 The portion of the suspension-means fastening that holds the suspension-means socket and the shackle rod may be in one piece (unit construction), or they may be separate.

2.20.9.3.2 The socket shall be either fabricated, cast, or forged steel, provided that where the socket and the shackle rod are in one piece (unit construction), the entire fastening shall be of forged steel.

2.20.9.3.3 Where the shackle rod and suspension-means socket are not in one piece, the shackle rod shall be of forged or rolled steel having an elongation of not less than 20% in a gauge length of 50 mm (2 in.).

2.20.9.3.4 Cast or forged steel suspension-means sockets, shackle rods, and their connections shall be made of unwelded steel having an elongation of not less than 20% in a gauge length of 50 mm (2 in.) when measured in accordance with ASTM E8, and conforming to ASTM A668, Class B for forged steel and ASTM A27, Grade 60/30 for cast steel, and shall be stress relieved. Steels of greater strength shall be permitted, provided they have an elongation of not less than 20% in a length of 50 mm (2 in.).

2.20.9.3.5 Fabricated sockets shall be permitted provided that the following conditions are met:

(a) Socket components shall be of rolled steel construction having an elongation of not less than 20% in a gauge length of 50 mm (2 in.).

(b) The factor of safety of the weld and heat-affected zone shall not be less than 12.

(c) Welding shall be performed by welders qualified to 8.8.1.

(d) Welds shall conform to 8.8.2.

2.20.9.3.6 Where the shackle rod is separate from the socket, the fastening between the two parts shall be positive, and such as to prevent their separation under all conditions of operation of the elevator.

Where the connection of the two parts is threaded, the thread design, tolerance, and manufacture shall conform to the requirements of ASME B1.13M, M-6H/6g, or equivalent, coarse or fine threads (ASME B1.1, UNC or UNF Class 2A and Class 2B threads). The thread size and the length of the thread engagement of the rod in the socket shall be sufficient to ensure that the engaged members are aligned and that the strength requirements

Fig. 2.20.9.4 Tapered Rope Sockets

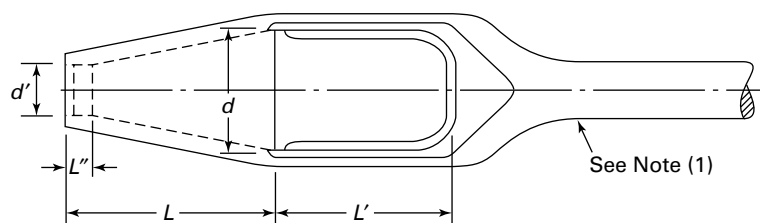

NOTE:

- (1) Rope socket and shackle rod may be in one piece, as shown (unit construction) or the socket and rod may be separate (see 2.20.9.3).

of 2.20.9.3.7 are met. In addition, means shall be provided to restrict the turning of the rod in the socket and prevent unscrewing of the connection in normal operation.

Eye bolts used as connections with clevis-type sockets shall be of forged steel conforming to ASTM A668, Class B (heat treated), without welds.

2.20.9.3.7 Sockets shall be of such strength that the suspension member will break before the socket is materially deformed.

2.20.9.3.8 The shackle rod, eye bolt, or other means used to connect the suspension-member socket to the car or counterweight shall have a strength at least equal to the manufacturer's minimum breaking force of the suspension member.

2.20.9.3.9 Fastenings incorporating antifriction devices that will permit free spinning of the suspension members shall not be used.

2.20.9.4 Tapered Rope Sockets. The use of tapered rope sockets shall be permitted only for steel wire ropes 8 mm (5/16 in.) or greater. When used, the tapered rope sockets shall be of a design as shown in Fig. 2.20.9.4 and shall conform to 2.20.9.2, 2.20.9.3, and 2.20.9.4.1 through 2.20.9.4.5.

2.20.9.4.1 The axial length L of the tapered portion of the socket shall be not less than 4.75 times the diameter of the wire rope used.

2.20.9.4.2 The axial length, L' , of the open portion of the rope socket shall be not less than 4 times the diameter of the wire rope used.

2.20.9.4.3 The length of the straight bore, L'' , at the small end of the socket shall be not more than 13 mm (0.5 in.) nor less than 3 mm (0.125 in.), and its outer edge shall be rounded and free from cutting edges.

2.20.9.4.4 The diameter, d , of the hole at the large end of the tapered portion of the socket shall be not less than 2.25 times nor more than 3 times the diameter of the wire rope used.

2.20.9.4.5 The diameter, d' , of the hole at the end of the tapered portion of the socket shall be not more than shown in Table 2.20.9.4.5.

2.20.9.5 Wedge Rope Sockets. The use of wedge rope socket assemblies shall be permitted only for steel wire and aramid ropes. When used, the wedge rope socket assemblies shall be of a design as shown in Fig. 2.20.9.5 and shall conform to 2.20.9.2, 2.20.9.3, and 2.20.9.5.1 through 2.20.9.5.7. Socket and wedge surfaces that contact the rope shall be free of burrs or sharp edges that could damage the rope.

2.20.9.5.1 A test specimen consisting of the strongest suspension rope for a given dimension and wedge socket assembly shall be subjected to a destructive tensile engineering test. The rope socketing shall develop at least 80% of the minimum breaking force of the strongest rope to be used in such a fastening without the rope slipping through the assembly.

2.20.9.5.2 Wedge socket assemblies shall be of such a strength that when tested as in 2.20.9.5.1, the rope shall break before the socket or wedge is materially deformed.

2.20.9.5.3 Suppliers of wedge sockets shall submit certification showing that the sockets, with visible permanent manufacturer's identification, have successfully passed the tests described in 2.20.9.5.1 and 2.20.9.5.2 at a testing laboratory.

2.20.9.5.4 When the steel wire rope has been seated in the wedge socket by the load on the rope, the wedge shall be visible, and at least two wire-rope retaining clips shall be provided to attach the termination side to the load-carrying side of the rope (see Fig. 2.20.9.5). The first clip shall be placed a maximum of 4 times the rope diameter above the socket, and the second clip shall be located within 8 times the rope diameter above the first clip. The purpose of the two clips is to retain the wedge and prevent the rope from slipping in the socket should the load on the rope be removed for any reason. The clips shall be designed and

Table 2.20.9.4.5 Relation of Rope Diameter to Diameter of the Small Socket Hole

| Nominal Rope Diameter, mm | Maximum Diameter of Hole, d' , mm | Nominal Rope Diameter, in. | Maximum Diameter of Hole, d' , in. |
|---------------------------|---------------------------------------|--|--|
| 8 to 12 inclusive | 2.5 larger than nominal rope diameter | $\frac{5}{16}$ to $\frac{7}{16}$ inclusive | $\frac{3}{32}$ larger than nominal rope diameter |
| 13 to 19 inclusive | 3 larger than nominal rope diameter | $\frac{1}{2}$ to $\frac{3}{4}$ inclusive | $\frac{1}{8}$ larger than nominal rope diameter |
| 22 to 29 inclusive | 4 larger than nominal rope diameter | $\frac{7}{8}$ to $1\frac{1}{8}$ inclusive | $\frac{5}{32}$ larger than nominal rope diameter |
| 32 to 40 inclusive | 5 larger than nominal rope diameter | $1\frac{1}{4}$ to $1\frac{1}{2}$ inclusive | $\frac{3}{16}$ larger than nominal rope diameter |

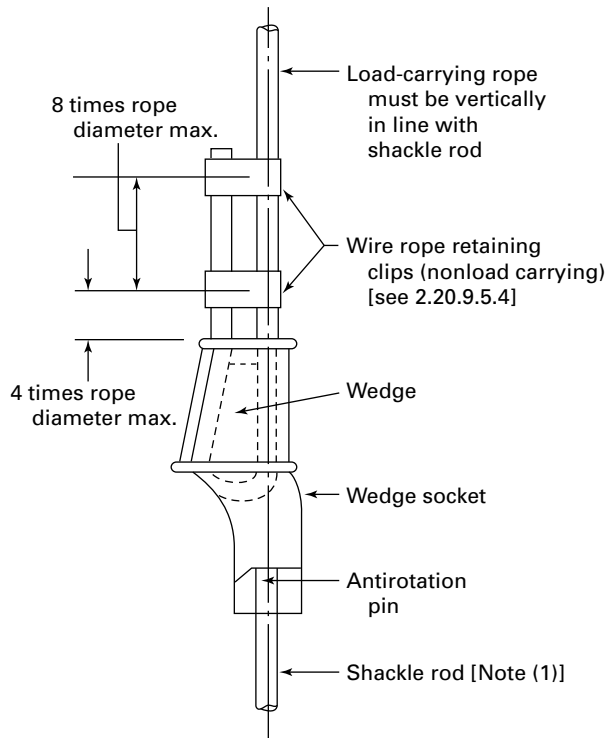
Fig. 2.20.9.5 Wedge Rope Sockets**NOTE:**

- (1) Rope socket and shackle rod may be in one piece, as shown (unit construction) or the socket and rod may be separate (see 2.20.9.3).

installed so that they do not distort or damage the rope in any manner.

2.20.9.5.5 Means shall be provided to prevent the aramid fiber rope from slipping in the socket should the load on the rope be removed for any reason.

2.20.9.5.6 Markings on the wedge socket assembly components shall be as follows:

(a) Each socket shall be permanently and legibly marked or color coded to identify the corresponding wedge, or wedges, and rope size and material to be used in the assembly. The markings shall be visible after installation.

(b) Each wedge shall be permanently and legibly marked or color coded to identify the corresponding socket, or sockets, and rope size and material, within which it is to be inserted to form an assembly. The markings shall be visible after installation.

2.20.9.5.7 Load-carrying rope shall be in line with shackle rod, and the sockets shall be permitted to be staggered in the direction of travel of the elevator and counterweight, where used.

2.20.9.6 Rope Socket Embedment Medium. Only babbitt metal or thermosetting resin compositions intended for elevator wire rope socketing shall be used to secure ropes in tapered sockets. The embedment material shall conform to 2.20.9.6.1 through 2.20.9.6.3.

2.20.9.6.1 Babbitt Metal. Babbitt metal shall contain at least 9% of antimony and shall be clean and free from dross.

2.20.9.6.2 Thermosetting Resin Composition

(ED)

(a) *Physical Properties.* The thermoset resin composition shall have the following properties:

(1) Uncured (Liquid) Material

(a) *Viscosity of Resin-Catalyst Mixture.* The viscosity of the resin-catalyst mixture shall be sufficiently low to permit rapid, complete saturation of the rope rosette in order to prevent entrapment of air.

(b) *Flash Point.* All components shall have a minimum flash point of 27°C (80°F).

(c) *Shelf Life.* All components shall have a minimum of 1 year shelf life at 21°C (70°F).

(d) *Pot Life and Cure Time.* After mixing, the resin-catalyst mixture shall be pourable for a minimum of 8 min at 21°C (70°F) and shall cure within 1 h after hardening. Heating of the resin mixture in the socket to accelerate curing shall follow the resin manufacturer's instructions.

(2) Cured Resin

(a) *Socket Performance.* Resin, when cured, shall develop sufficient holding strength to solvent-washed wire in wire-rope sockets to develop 80% of the ultimate strength of all types of elevator wire rope. No slippage of wire is permissible when testing resin-filled rope socket assemblies in tension; however, after testing, some seating of the resin cone shall be permitted to be apparent

and is acceptable. Resin terminations shall also be capable of withstanding tensile shock loading.

(b) *Shrinkage.* The volumetric shrinkage of fully cured resin shall not exceed 2%. The use of an inert filler in the resin is permissible.

(c) *Curing.* The resin-catalyst mixture shall be capable of curing either at ambient [16°C to 38°C (60°F to 100°F)] or elevated temperatures. At temperatures below 16°C (60°F), an elevated temperature cure shall be used.

(b) *Materials Required.* The thermoset resin composition intended for elevator wire rope socketing shall be supplied in two parts consisting of preweighed resin and preweighed catalyst, each packaged separately within a kit. Each kit containing the thermoset resin composition shall consist of the following:

- (1) preweighed thermoset resin
- (2) preweighed catalyst
- (3) necessary materials for mixing and pouring
- (4) detachable label on resin container

(c) *Marking*

(1) *Resin Container.* The label on the resin container shall show the following information:

- (a) product name
- (b) part designation (e.g., "Part A" or "Resin")
- (c) manufacturer's name or trademark and address
- (d) mixing instructions
- (e) ICC information
- (f) safety warnings and cautions
- (g) packaging date
- (h) flash point
- (i) shelf life
- (j) storage instructions
- (k) curing instructions
- (l) net weight
- (m) a statement certifying that the product conforms to 2.20.9.6.2 of ASME A17.1/CSA B44

2.20.9.6.3 Catalyst Container. The label on the catalyst container shall show the following information:

- (a) product name
- (b) part designation (e.g., "Part B," "Catalyst," or "Hardener")
- (c) manufacturer's name or trademark and address
- (d) safety warnings and cautions
- (e) flash point
- (f) storage instructions
- (g) net weight

2.20.9.7 Method of Securing Wire Ropes in Tapered Sockets. Where the tapered type of socket is used, the method and procedure to be followed in making up the fastening shall conform to the following as applicable.

2.20.9.7.1 Handling. The rope to be socketed shall be carefully handled to prevent twisting, untwisting, or kinking.

2.20.9.7.2 Seizing of Rope Ends. The rope ends to be socketed shall be seized before cutting with seizing in accordance with the following:

(a) The seizing shall be done with annealed iron wire, provided that other methods of seizing be permitted, that give the same protection from loss of rope lay. Where iron wire is used for seizing, the length of each seizing shall be not less than the diameter of the rope.

(b) For nonpreformed rope, three seizings shall be made at each side of the cut in the rope. The first seizing shall be close to the cut end of the rope, and the second seizing shall be spaced back from the first the length of the end of the rope to be turned in. The third seizing shall be at a distance from the second equal to the length of the tapered portion of the socket.

(c) For preformed rope, one seizing shall be made at each side of the cut in the rope. The seizing shall be at a distance from the end of the rope equal to the length of the tapered portion of the socket plus the length of the portion of the rope to be turned in.

2.20.9.7.3 Spreading of Rope Strands. After the rope has been seized, it shall be inserted into the socket through the hole in the small end, a sufficient distance for manipulation, and where nonpreformed rope is used, the first two seizings shall be removed. The rope strands shall then be spread apart, and where rope with fibre core is used, the fibre core shall be cut away as close as possible to the remaining seizing.

2.20.9.7.4 Removal of Grease or Oil. Thorough cleaning of the outer wires of the strand surface and the inside of the rope socket is required for good adhesion. Brush or dip in clean solvents is recommended.

2.20.9.7.5 Turning in of Rope Strands. The exposed rope strands shall then be bent, turned in, and bunched closely together, each strand being turned back the same distance. The portion turned in (rope rosette) shall have a length of not less than 2.5 times the diameter of the rope, and such that, when the rope is pulled as far as possible into the socket, the bend of the turned-in strands shall be slightly overflush with the mouth of the tapered socket (large end) and will be visible when the socket has been completed (see 2.20.9.7.9). Where rope with steel core is used, the steel core shall be cut off even with tops of the looped strands.

2.20.9.7.6 Insertion of Bent-In Rope Strands in Socket. The rope end shall be pulled as far as possible into the socket, so that the remaining seizing projects outside the hole at the small end of the socket.

2.20.9.7.7 Position of Socket Preparatory to Pouring Embedment Medium. The socket shall be held in a vertical position with the large end up, and the rope held in

a position truly axial with the socket. Tape or waste shall be permitted to be wound around the rope at the small end of the socket to prevent the embedment medium from seeping through, but shall be removed after completion of the socket.

2.20.9.7.8 Preparation of Embedment Medium

(a) Babbitt Metal

(1) *Heating of Babbitt.* The babbitt shall be heated to a fluidity just sufficient to char a piece of soft wood such as white pine without igniting it. Care shall be taken not to overheat the babbitt sufficiently to damage the rope.

(2) *Heating of Socket Basket and Pouring of Babbitt.* The rope socket basket shall be heated by a blowtorch flame sufficiently to prevent chilling of the babbitt and to ensure that the babbitt, when poured, will completely fill the basket, including all the spaces between the rope strands. Following this the molten babbitt shall be poured slowly and evenly into the basket until it is filled to a point level with the top of the opening in the large end.

(b) Thermosetting Resin Composition

(1) The manufacturer's directions shall be strictly followed in handling, mixing, pouring, and curing the resin material.

(2) New containers of resin and catalyst shall be utilized for each set of rope sockets. The entire quantity of resin and catalyst shall be mixed when the containers are opened.

(3) Resin sockets shall not be poured at a temperature below 16°C (60°F) without first warming the socket and the resin composition to 21°C to 32°C (70°F to 90°F). The socket shall be permitted to be warmed using the electrical resistance heating devices intended for curing resin sockets.

(4) Curing of resin sockets shall be accomplished by heating at elevated temperature following the manufacturer's suggested schedule and directions. Cure time shall not exceed 30 min. Electrical resistance heating devices designed to fit around the sockets, or other means of providing controlled, evenly distributed heat, shall be used to provide the elevated temperature for curing. Open flames or exposed electrical resistance heating elements shall not be used.

(5) Upon completion of the socketing, the label from the container of resin shall be attached to one of the rope sockets for inspection purposes and shall be suitably protected.

2.20.9.7.9 Inspection of Sockets After Completion.

A visual inspection of the completed sockets shall be made after they have cooled and the tape or waste has been removed from the small end of the sockets. The visual inspection shall verify that

(a) the embedment medium is visible at the small end of the socket

(b) the bends of all of the individual rope strands (see 2.20.9.7.5) are approximately the same height above the embedment medium and visible within the range of not less than one-half the diameter of the rope strand above the embedment medium and that there is not more than 1.5 mm (0.06 in.) clearance between the embedment medium and the underside of the bend in the rope strand

(c) no loss of rope lay has occurred where the wire rope enters the socket

2.20.9.7.10 Lubrication of Wire Rope After Socket Attachment. After the resin has cured, the wire ropes shall be lubricated at the base of the socket (small end) to replace the lubricant that was removed during the cleaning operation required under 2.20.9.7.4.

2.20.9.8 Antirotation Devices. Where rotation of suspension members can occur, means shall be provided to prevent the rotation of the suspension members without restricting their movement horizontally or vertically.

2.20.9.9 Wedge Noncircular Elastomeric-Coated Steel Suspension-Member Sockets. Wedge socket assemblies for noncircular elastomeric-coated steel suspension members shall conform to 2.20.9.2, 2.20.9.3, and 2.20.9.9.1 through 2.20.9.9.5.

2.20.9.9.1 A test specimen consisting of the strongest noncircular elastomeric-coated steel suspension member for given noncircular elastomeric-coated steel suspension-member dimensions and wedge socket assembly shall be subjected to a destructive tensile engineering test. The noncircular elastomeric-coated steel suspension-member socket shall develop at least 80% of the manufacturer's minimum breaking force of the strongest noncircular elastomeric-coated steel suspension member to be used in such a fastening without the noncircular elastomeric-coated steel suspension member slipping through the assembly.

2.20.9.9.2 Wedge noncircular elastomeric-coated steel suspension-member socket assemblies shall be of such a strength that when tested as in 2.20.9.9.1, the noncircular elastomeric-coated steel suspension member shall break before the socket or wedge is materially deformed.

2.20.9.9.3 Suppliers of noncircular elastomeric-coated steel suspension-member wedge sockets shall submit certification showing that the sockets, with visible permanent manufacturer's identification, have successfully passed the tests described in 2.20.9.9.1 and 2.20.9.9.2 at a testing laboratory.

2.20.9.9.4 When the noncircular elastomeric-coated steel suspension member has been seated in the wedge socket by the load on the noncircular elastomeric-coated steel suspension member, the wedge shall be visible and the end of the noncircular elastomeric-coated

steel suspension member shall be prevented from slipping in the socket should the load on the noncircular elastomeric-coated steel suspension member be removed for any reason.

2.20.9.9.5 Markings on the wedge socket assembly components shall be as follows:

(a) Each socket shall be permanently and legibly marked or color coded to identify the noncircular elastomeric-coated steel suspension-member size to be used in the assembly. The markings shall be visible after installation.

(b) Each wedge shall be permanently and legibly marked or color coded to identify the corresponding socket or sockets and noncircular elastomeric-coated steel suspension-member size within which it is to be inserted to form an assembly. The markings shall be visible after installation.

2.20.10 Auxiliary Rope Fastening Devices

Auxiliary rope fastening devices, designed to support elevator cars or counterweights if any regular rope fastening fails, shall be permitted to be provided, subject to the requirements of 2.20.10.1 through 2.20.10.9.

2.20.10.1 They shall be approved on the basis of adequate tensile and fatigue engineering tests.

2.20.10.2 The device and its fastenings, in its several parts and assembly, shall have a strength at least equal to that of the manufacturer's breaking strength of the rope to which it is to be attached.

2.20.10.3 Steel parts used in the device shall be cast or forged with an elongation of not less than 20%, conforming to ASTM A668, Class B, for forgings and ASTM A27, Grade 60/30 for cast steel, and shall be stress relieved.

2.20.10.4 The device shall be so designed and installed that

(a) it will not become operative unless there is a failure of the normal rope fastening

(b) it will function in a rope movement of not over 38 mm (1.5 in.)

(c) it will not interfere with the vertical or rotational movements of the rope during normal service

2.20.10.5 Means shall be provided to cause the electric power to be removed from the driving-machine motor and brake when any auxiliary fastening device operates. Such means shall

(a) have all electrical parts enclosed

(b) be of the manually reset type that can be reset only when the wire rope or ropes have been resocketed and the auxiliary rope fastening device has been restored to its normal running position

2.20.10.6 The method used to attach the device to the rope shall be such as to prevent injury to, or appreciable deformation of, the rope.

2.20.10.7 The installation of the device shall not reduce the required overhead clearances.

2.20.10.8 The car-frame supports for the fastening members of the device shall conform to 2.15.13, or where existing conditions will not permit compliance with this requirement, other means of fastening shall be permitted to be used subject to the approval of the enforcing authority.

2.20.10.9 Each device shall be permanently marked with the name or trademark of the manufacturer by means of metal tags or plates with the following data of the wire rope for which they are designated to be used:

(a) diameter of the rope in millimeters (mm) or inches (in.)

(b) manufacturer's rated breaking strength of the rope

(c) construction classification of the wire rope

The material and marking of the tags or plates shall conform to 2.16.3.3, except that the height of the letters and figures shall be not less than 1.5 mm (0.06 in.).

2.20.11 Suspension-Member Test

Each type of suspension means designed to support elevator cars or counterweights shall be subjected to the engineering tests specified in 8.3.12 except suspension means conforming to the following:

(a) steel wire ropes conforming to the requirements of 5.2.1.20, 5.3.1.12, 5.4.8, 7.2.6, and 7.5.6

(b) steel wire ropes conforming to the requirements of Section 2.20 with diameters 9.5 mm (0.375 in.) and greater with outer wire diameters not less than 0.56 mm (0.024 in.)

(c) steel wire ropes conforming to the requirements of Section 2.20 with diameters of not less than 8.0 mm (0.315 in.) with outer wire diameters not less than 0.48 mm (0.019 in.) when used with a safety factor not less than 12, per 2.20.3

SECTION 2.21 COUNTERWEIGHTS

2.21.1 General Requirements

2.21.1.1 Frames. Weight sections of a counterweight shall be mounted in structural or formed metal frames so designed as to retain them securely in place (see 2.21.2.6).

2.21.1.2 Retention of Weight Sections. Means shall be provided to retain weight sections in place in the event of buffer engagement or safety application or if they become broken.

Where tie rods are used, a minimum of two shall be provided, that shall pass through all weight sections. Tie-rods shall be provided with a lock nut and cotter pin at each end.

(13) 2.21.1.3 Guiding Means

2.21.1.3.1 Counterweight frames shall be guided on each guide rail by upper and lower guiding members attached to the frame. Guiding members shall be designed to withstand the forces imposed during normal operation of the elevator, loading and unloading, emergency stopping, and the application of safeties.

2.21.1.3.2 Means shall be provided to prevent the counterweight from being displaced by more than 13 mm (0.5 in.) from its normal running position.

This protection shall be provided by either of the following:

(a) a guiding means wherein no failure or wear of the guiding member shall allow the counterweight to be displaced more than 13 mm (0.5 in.) from its normal running position

(b) a retention means that shall be permitted to be integral with the guiding means

2.21.1.3.3 All components of the means required to limit the displacement in accordance with 2.21.1.3.2 shall have minimum factor of safety of 5.

2.21.1.4 Independent Car Counterweights. Where an independent car counterweight is provided, it shall run in separate guide rails and shall not be of sufficient weight to cause undue slackening of the hoisting ropes during acceleration or retardation of the elevator car.

2.21.2 Design Requirements for Frames and Rods

2.21.2.1 Material. Frames and rods shall be made of steel or other metals conforming to 2.15.6.2 and 2.15.6.3, provided that where steels of greater strength than those specified, or where metals other than steel are used, the factor of safety used in the design shall conform to 2.21.2.3.

2.21.2.2 Frame Connections. Connections between frame members shall conform to 2.15.7.

2.21.2.3 Factor of Safety

2.21.2.3.1 The frame members and their connections shall be designed with a factor of safety of not less than 5 with the elevator at rest and the counterweight at the top of its travel.

2.21.2.3.2 The counterweight frame shall be designed with a factor of safety of not less than 2.5 at buffer engagement or safety application.

2.21.2.3.3 The frame members, brackets, and their connections subject to forces due to the application of the emergency brake (see 2.19.4) shall be designed to withstand the maximum forces developed during the retardation phase of the emergency braking so that the resulting stresses due to the emergency braking and all other loading acting simultaneously, if applicable, shall not exceed 190 MPa (27,500 psi).

2.21.2.4 Sheaves. Where a hoisting sheave or sheaves are mounted in the frame, the requirements of 2.15.12 shall apply (see also 2.24.2 and 2.24.3 for requirements for sheaves).

2.21.2.5 Suspension-Rope Hitch or Shapes. Where counterweights are suspended by ropes attached directly to the frames by means of rope fastenings, the rope attachments shall conform to 2.15.13.

2.21.2.6 Securing of Weights in Frames. The weights shall be so mounted and secured in the frames as to prevent shifting of the weights by an amount that will reduce the running clearances to less than those specified in 2.5.1.2.

2.21.3 Cars Counterbalancing One Another

An elevator car shall not be used to counterbalance another elevator car.

2.21.4 Compensation Means

Compensation means, such as compensating ropes or chains or other mechanical means and their attachments (except for safety hooks, where used) to tie the counterweight and car together, shall be capable of withstanding, with a factor of safety of 5, any forces to which the means is subjected with the elevator at rest.

The maximum suspended weight of compensation means with car or counterweight at the top of its travel and one-half total weight of tension sheave assembly, where used, shall be included.

The factor of safety for compensation means shall be based on the minimum, breaking load, or breaking force as appropriate to the tensile testing method.

2.21.4.1 Connections. A connection shall be provided between the car or counterweight and the compensation means. The connection shall be bolted or welded and shall conform to 2.15.7.3.

2.21.4.1.1 Cast iron, where used, shall have a factor of safety of not less than 10, based on maximum stress developed.

2.21.4.1.2 When compensation ropes are used with a tension sheave, one end of each rope shall be provided with a means to individually adjust rope length.

2.21.4.2 Tie-Down Compensation Means. For rated speeds greater than 3.5 m/s (700 ft/min), a tie-down compensation means shall be provided and fastened to the building structure to limit the jump of the car or counterweight as a result of car or counterweight buffer engagement or safety application.

The compensation means, connection, building structural members, and fastenings shall be capable of withstanding the maximum forces to which they are

Table 2.22.3.1 Minimum Spring Buffer Stroke

| Rated Car Speed, m/s (ft/min) | Minimum Stroke, mm (in.) |
|----------------------------------|-----------------------------|
| 0.5 or less (100 or less) | 38 (1.5) |
| 0.51 to 0.75 (101 to 150) | 63 (2.5) |
| 0.76 to 1.00 (151 to 200) | 100 (4.0) |

subjected due to car or counterweight buffer engagement or safety application with a factor of safety of not less than 2.5.

SECTION 2.22 BUFFERS AND BUMPERS

2.22.1 Type and Location

2.22.1.1 Type of Buffers. Buffers of the spring, oil, or equivalent type shall be installed under the cars and counterweights of passenger and freight elevators subject to the requirements of 2.22.1.1.1 through 2.22.1.1.3.

2.22.1.1.1 Spring buffers or their equivalent shall be permitted to be used where the rated speed is not in excess of 1 m/s (200 ft/min).

2.22.1.1.2 Oil buffers or their equivalent shall be used where the rated speed is in excess of 1 m/s (200 ft/min).

2.22.1.1.3 Where Type C safeties are used (see 2.17.8.2), car buffers are not required if solid bumpers are installed.

2.22.1.2 Location. Buffers or bumpers shall be located so as to retard the car and counterweight without exceeding allowable design stresses in the car frame and counterweight frame.

2.22.2 Solid Bumpers

Solid bumpers, where permitted, shall be made of wood or other suitably resilient material of sufficient strength to withstand without failure the impact of the car with rated load, or the counterweight, descending at governor tripping speed.

The material used shall be of a type that will resist deterioration or be so treated as to resist deterioration.

2.22.3 Spring Buffers

2.22.3.1 Stroke. The stroke of the buffer spring, as marked on its marking plate, shall be equal to or greater than the value specified in Table 2.22.3.1.

2.22.3.2 Load Rating

2.22.3.2.1 Buffers for cars and counterweights shall be capable of supporting, without being compressed solid or to a fixed stop, a static load having a minimum of 2 times the total weight of

- (a) the car and its rated load for car buffers
- (b) the counterweight for counterweight buffers

2.22.3.2.2 Buffers for cars and counterweights shall be compressed solid or to a fixed stop with a static load of three times the weight of

- (a) the car and its rated load for car buffers
- (b) the counterweight for counterweight buffers

2.22.3.2.3 Where the space below the hoistway is not permanently secured against access, the load rating specified in 2.22.3.2.1 shall be increased to meet the requirements of 2.6.1(b) and 2.6.2.

2.22.3.3 Marking Plates. Each spring buffer shall be provided with a marking plate showing its load rating and stroke and the number of springs. Where the springs are removable, each spring shall be identified, and the assembly marking plate shall indicate this identification. Markings shall be made in a permanent and legible manner.

2.22.4 Oil Buffers

2.22.4.1 Stroke. The minimum stroke of oil buffers shall be based on the requirements of 2.22.4.1.1 or 2.22.4.1.2.

2.22.4.1.1 The stroke shall be such that the car or the counterweight, on striking the buffer at 115% of the rated speed, shall be brought to rest with an average retardation of not more than 9.81 m/s^2 (32.2 ft/s^2).

2.22.4.1.2 Where terminal speed reducing device is installed that conforms to 2.25.4.1, and that will limit the speed at which the car or counterweight can strike its buffer, the buffer stroke shall be based on at least 115% of such reduced striking speed and on an average retardation not exceeding 9.81 m/s^2 (32.2 ft/s^2). In no case shall the stroke used be less than 50% of the stroke required by 2.22.4.1.1 for rated speeds under 4 m/s (800 ft/min), nor less than $33\frac{1}{3}\%$, or 450 mm (18 in.), whichever is greater, for rated speeds of 4 m/s (800 ft/min) or more.

NOTE (2.22.4.1): Figure 8.2.4 indicates the minimum buffer strokes for various initial velocities. Table 2.22.4.1 indicates the minimum buffer strokes for the most usual rated speeds. See formula in 8.2.4 for calculation of buffer strokes differing from or exceeding those listed in Table 2.22.4.1.

2.22.4.2 Retardation. Oil buffers shall develop an average retardation not in excess of 9.81 m/s^2 (32.2 ft/s^2), and shall develop no peak retardation greater than 24.5 m/s^2 (80.5 ft/s^2), having a duration exceeding 0.04 s with any load in the car, from rated load to a minimum load of 70 kg (154 lb), when the buffers are struck with an initial speed of not more than

- (a) 115% of the rated speed for buffers conforming to 2.22.4.1.1
- (b) 115% of the predetermined reduced speed for buffers conforming to 2.22.4.1.2

(13)

Table 2.22.4.1 Minimum Oil Buffer Strokes

| SI Units | | | Imperial Units | | |
|---------------------|--------------------------------|--------------------------|------------------------|-----------------------------------|---------------------------|
| Rated Speed, m/s | 115% of Rated Speed, m/s | Minimum Stroke, mm | Rated Speed, ft/min | 115% of Rated Speed, ft/min | Minimum Stroke, in. |
| 1.00 | 1.15 | 65 | 200 | 230 | 2.75 |
| 1.12 | 1.29 | 85 | 225 | 259 | 3.50 |
| 1.25 | 1.44 | 105 | 250 | 288 | 4.25 |
| 1.50 | 1.73 | 155 | 300 | 345 | 6.25 |
| 1.75 | 2.01 | 205 | 350 | 403 | 8.25 |
| 2.00 | 2.30 | 270 | 400 | 460 | 11.00 |
| 2.25 | 2.59 | 340 | 450 | 518 | 13.75 |
| 2.50 | 2.88 | 425 | 500 | 575 | 17.00 |
| 3.00 | 3.45 | 605 | 600 | 690 | 24.75 |
| 3.50 | 4.03 | 825 | 700 | 805 | 33.25 |
| 4.00 | 4.60 | 1 080 | 800 | 920 | 43.75 |
| 4.50 | 5.18 | 1 365 | 900 | 1,035 | 55.50 |
| 5.00 | 5.75 | 1 685 | 1,000 | 1,150 | 68.50 |
| 5.50 | 6.32 | 2 040 | 1,100 | 1,265 | 83.00 |
| 6.00 | 6.90 | 2 425 | 1,200 | 1,380 | 98.50 |
| 6.50 | 7.48 | 2 845 | 1,300 | 1,495 | 115.50 |
| 7.00 | 8.05 | 3 300 | 1,400 | 1,610 | 134.50 |
| 7.50 | 8.63 | 3 790 | 1,500 | 1,725 | 154.00 |
| 8.00 | 9.20 | 4 310 | 1,600 | 1,840 | 175.25 |
| 8.50 | 9.78 | 4 870 | 1,700 | 1,955 | 197.75 |
| 9.00 | 10.35 | 5 460 | 1,800 | 2,070 | 221.75 |
| 9.50 | 10.93 | 6 080 | 1,900 | 2,185 | 247.00 |
| 10.00 | 11.50 | 6 740 | 2,000 | 2,300 | 273.75 |

2.22.4.3 Factor of Safety for Oil-Buffer Parts. The factor of safety of parts of oil buffers, based on the yield point for compression members and on the ultimate strength and elongation for other parts, at gravity retardation with the maximum load for which the buffer is designed, when tested in accordance with ASTM E8 using a 50 mm (2 in.) gauge length, shall be not less than

- (a) 3 for materials having an elongation 20% or more
- (b) 3.5 for materials having an elongation from 15% to 20%
- (c) 4 for materials having an elongation from 10% to 15%
- (d) 5 for materials having an elongation less than 10%
- (e) 10 for cast iron parts

2.22.4.4 Slenderness Ratio for Members Under Compression as Columns. The slenderness ratio (L/R) for members of oil buffers under compression as columns shall be not more than 80.

The slenderness ratio (L/R) specified applies only to those main buffer members that are subject to the impact of the fully loaded car when striking the buffer.

2.22.4.5 Plunger Return Requirements. Oil buffers shall be so designed that

(a) the buffer plunger of gravity-return and spring-return-type oil buffers, when the buffer is filled with oil shall, when released after full compression, return to its fully extended position within 90 s

(b) the plunger of a spring-return-type oil buffer with a 20 kg (44 lb) weight resting on it shall, when released after being depressed 50 mm (2 in.), return to the fully extended position within 30 s

(c) gas spring-return oil buffers shall be provided with a switch conforming to 2.26.2.22 that shall be actuated if the plunger is not within 13 mm (0.5 in.) of the fully extended position

2.22.4.6 Means for Determining Oil Level. Oil buffers shall be provided with means for determining that the oil level is within the maximum and minimum allowable limits. Transparent sight gauges shall be permitted to be used provided they meet the requirements for the purpose in accordance with good engineering practice. They shall resist shock loading on the buffer or pressure

rise as a result of impact, and not be stained by the presence of buffer oil or a means shall be provided to ensure that any staining does not affect the reading of the oil level.

2.22.4.7 Type Tests and Certification for Oil Buffers

2.22.4.7.1 Each type of oil buffer shall be subjected to the type tests as specified in 8.3.2 and to the certification process as specified in 8.3.1.

2.22.4.7.2 A type test on an oil buffer shall be permitted to be acceptable for similarly designed buffers, provided that the longest stroke of the type is subjected to the type test; and the load range of the buffer is within the maximum and minimum range for the oil portings of the given buffer.

(ED) 2.22.4.7.3 Oil buffers tested in accordance with the test requirements of prior editions of ASME A17.1/CSA B44 shall be acceptable without being retested, provided the buffer has been listed/certified to a previous edition of the Code or on submittal by the person or organization installing the buffers of the test certificate stating that the buffer, when tested, met the specified test requirements of that edition of the Code.

2.22.4.8 Compression of Buffers When Car Is Level With Terminal Landings. Car and counterweight oil buffers of the mechanical spring-return type shall be permitted to be compressed not to exceed 25% of their stroke when the car is level with the terminal landings (see 2.4.2.1).

2.22.4.9 Buffer Oil Requirements. Oils used in oil buffers shall have a pour point of -18°C (0°F), or lower, as defined in ASTM D97, and a viscosity index of 75, or higher, as defined in ASTM D2270.

2.22.4.10 Load Ratings of Oil Buffers. The minimum and maximum load ratings of car and counterweight oil buffers, as indicated on the buffer marking plate, shall conform to 2.22.4.10.1 through 2.22.4.10.3.

2.22.4.10.1 The minimum load rating shall be not greater than

(a) for car oil buffers, the total weight of the car as marked on the car crosshead data plate plus 70 kg (150 lb)

(b) for counterweight oil buffers, the weight of the counterweight used

2.22.4.10.2 The maximum load rating shall be not less than

(a) for car oil buffers, the total weight of the car as marked on the crosshead data plate plus the rated load

(b) for counterweight oil buffers, the weight of the counterweight used

2.22.4.10.3 When compensating rope tie-down is present, the increase in load shall be taken into account (see 2.21.4.2).

2.22.4.11 Buffer Marking Plate. Every installed oil buffer shall have permanently attached thereto a metal plate, marked by the manufacturer in a legible and permanent manner, indicating

(a) the maximum and minimum loads and the maximum striking speeds for which the buffer has been rated for use in conformance with the requirements in 2.22

(b) the permissible range in viscosity of the buffer oil to be used, stated in Saybolt Seconds Universal at 38°C (100°F)

(c) the viscosity index number of the oil to be used

(d) the pour point in degrees Celsius (Fahrenheit) of the oil to be used

(e) the stroke of the buffer in mm (in.)

(f) the composition of the gas, if used

(g) the name, trademark, or file number by which the organization that manufactured the product can be identified

(h) the certification marking in accordance with 8.3.1.3

SECTION 2.23 CAR AND COUNTERWEIGHT GUIDE RAILS, GUIDE-RAIL SUPPORTS, AND FASTENINGS

2.23.1 Guide Rails Required

Elevator cars and counterweights shall be provided with guide rails.

2.23.2 Material

Guide rails, guide-rail brackets, rail clips, fishplates, and their fastenings shall be either of the following:

(a) of steel or other metals conforming to 2.23

(b) where steel presents an accident hazard, as in chemical or explosive plants, guide rails shall be permitted to be of selected wood or other suitable nonmetallic materials, provided the rated speed of the car does not exceed 0.75 m/s (150 ft/min).

2.23.2.1 Requirements for Steel, Where Used

(a) Rails, brackets, fishplates, and rail clips shall be made of open-hearth steel, or its equivalent, having a tensile strength of not less than 380 MPa (55,000 psi) and having an elongation of not less than 22% in a length of 50 mm (2 in.) when measured in accordance with ASTM E8.

(b) Bolts shall conform to ASTM A307.

(c) Rivets shall conform to ASTM A502.

(d) Maximum permissible stresses and deflections shall conform to 2.23.5.

2.23.2.2 Requirements for Metals Other Than Steel.

Metals other than steel shall be permitted to be used, provided the factor of safety is not less than, and the deflections are not more than, the values specified in this section, and provided that cast iron is not used.

Fig. 2.23.3 Elevator Guide Rails

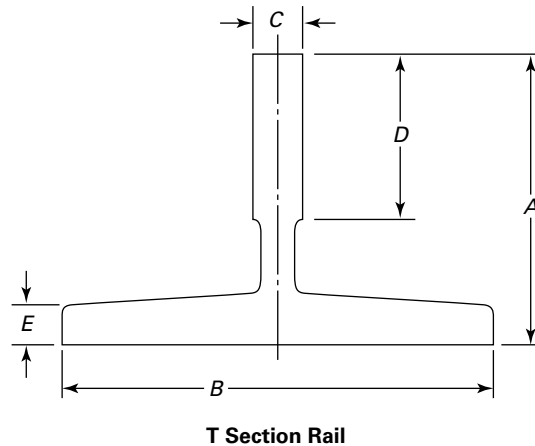

Table 2.23.3 T-Section Guide-Rail Dimensions

| Nominal Mass, kg/m | SI Units | | | | | Nominal Weight, lb/ft | Imperial Units | | | | |
|--------------------|------------------------|-------|------|------|------|--------------------------------|---------------------------------|-------------------------------|--------------------------------|---------------------------------|---------------------------------|
| | Nominal Dimensions, mm | | | | | | Nominal Dimensions, in. | | | | |
| | A | B | C | D | E | | A | B | C | D | E |
| 8.5 | 68.3 | 82.6 | 9.1 | 25.4 | 6.0 | 5 ³ / ₄ | 2 ¹¹ / ₁₆ | 3 ¹ / ₄ | 2 ³ / ₆₄ | 1 | 1 ⁵ / ₆₄ |
| 9.5 | 49.2 | 69.9 | 15.9 | 25.4 | 7.9 | 6 ¹ / ₄ | 1 ¹⁵ / ₁₆ | 2 ³ / ₄ | 5 ⁵ / ₈ | 1 | 5 ⁵ / ₁₆ |
| 12.0 | 61.9 | 88.9 | 15.9 | 31.8 | 7.9 | 8 | 2 ⁷ / ₁₆ | 3 ¹ / ₂ | 5 ⁵ / ₈ | 1 ¹ / ₄ | 5 ⁵ / ₁₆ |
| 16.5 | 88.9 | 114.3 | 15.9 | 38.1 | 7.9 | 11 | 3 ¹ / ₂ | 4 ¹ / ₂ | 5 ⁵ / ₈ | 1 ¹ / ₂ | 5 ⁵ / ₁₆ |
| 18.0 | 88.9 | 127.0 | 15.9 | 44.5 | 7.9 | 12 | 3 ¹ / ₂ | 5 | 5 ⁵ / ₈ | 1 ³ / ₄ | 5 ⁵ / ₁₆ |
| 22.5 | 88.9 | 127.0 | 15.9 | 50.0 | 12.7 | 15 | 3 ¹ / ₂ | 5 | 5 ⁵ / ₈ | 1 ³¹ / ₃₂ | 1 ¹ / ₂ |
| 27.5 | 108.0 | 139.7 | 19.1 | 50.0 | 12.7 | 18 ¹ / ₂ | 4 ¹ / ₄ | 5 ¹ / ₂ | 3 ³ / ₄ | 1 ³¹ / ₃₂ | 1 ¹ / ₂ |
| 33.5 | 101.6 | 139.7 | 28.6 | 50.8 | 14.3 | 22 ¹ / ₂ | 4 | 5 ¹ / ₂ | 1 ¹ / ₈ | 2 | 9 ⁹ / ₁₆ |
| 44.5 | 127.0 | 139.7 | 31.8 | 57.2 | 17.5 | 30 | 5 | 5 ¹ / ₂ | 1 ¹ / ₄ | 2 ¹ / ₄ | 1 ¹¹ / ₁₆ |

2.23.3 Rail Section

Guide rails shall be either of the following:

(a) T-section, conforming to the nominal weights and dimensions shown in Fig. 2.23.3 and Table 2.23.3

(b) other shapes, subject to the following requirements:

(1) They shall have a section modulus and moment of inertia equal to or greater than that of the section shown in Fig. 2.23.3 for a given loading condition.

(2) They shall have a sectional area sufficient to withstand the compressive forces resulting from the application of the car or counterweight safety device, if used.

2.23.4 Maximum Load on Rails in Relation to the Bracket Spacing

The maximum load on guide rails in relation to the bracket spacing shall conform to 2.23.4.1 through 2.23.4.3. In addition to the loads specified therein any static and dynamic loads imposed by the support of

machines, sheaves, and hitches, if any, on one or more guide rails shall be taken into account in determining rail size and bracket spacing.

The combination of all vertical loads on any single guide rail shall not exceed one-half of the values specified in Fig. 2.23.4.1-1 in relation to the bracket spacing. This load requirement is not intended to limit design, and more detailed design and calculation methods shall be permitted to be used, provided that the moments and vertical loads induced into the rail system are taken into account in the calculations.

EXAMPLES (2.23.4):

- (1) *SI Units.* For 2 750 kg total weight of car plus load and a 2 150 kg counterweight, both roped 2:1; 90 kg suspension weight, 70 kg compensation weight, 20 kg traveling cable weight, and a machine weight of 360 kg; and with the machine supported in the overhead by one guide rail; the impacted reaction on that guide rail due to the machine loading is 2 750 kg + 2 150 kg + 90 kg + 70 kg + 20 kg + 360 kg = 5 440 kg. The equivalent static loading per pair of guide rails is 5 440 kg and given a

22.5 kg/m rail, there is a maximum bracket spacing of 4 050 mm.

- (2) *Imperial Units.* For 6,000 lb total weight of car plus load and a 4,700 lb counterweight, both roped 2:1; 200 lb suspension weight; 150 lb compensation weight; 45 lb traveling cable weight, and a machine weight of 800 lb; and with the machine supported in the overhead by one guide rail; the impacted reaction on that guide rail due to the machine loading is 6,000 lb + 4,700 lb + 200 lb + 150 lb + 45 lb + 800 lb = 11,895 lb. The equivalent static loading per pair of guide rails is 11,895 lb and given a 15 lb rail, there is a maximum bracket spacing of 13 ft 3 in.

2.23.4.1 With Single Car or Counterweight Safety.

Where a single car or counterweight safety is used, the maximum suspended weight of the car and its rated load, or the maximum suspended weight of the counterweight, including the weight of any compensation means and of any traveling cables suspended therefrom per pair of guide rails, shall not exceed the maximum specified in Fig. 2.23.4.1-1 for the size of the rail and the bracket spacing used, except that the bracket spacing shall be permitted to exceed the values specified in Fig. 2.23.4.1-1, provided that

(a) the guide rail is reinforced or a rail of larger size is used

(b) the moment of inertia of a single reinforced rail or of a single larger size T-section about the x - x axis parallel to the base of the rail is not less than that required by Fig. 2.23.4.1-1 for the given weight of car plus load, or the counterweight with safety device, at the bracket spacing used

(c) where the bracket spacings exceed those shown on Figs. 2.23.4.1-1 and 2.23.4.1-2, the rail system

(1) conforms to 2.23.5

(2) is designed to limit the deflection during the application of the safety with a fully loaded car to not more than 6 mm (0.25 in.) per rail

EXAMPLES [2.23.4.1(c)]:

- (1) *SI Units.* For 5 500 kg total weight of car plus load and a bracket spacing of 4 875 mm, there is required
- (a) 27.5 kg/m rail without reinforcement; or
- (b) 22.5 kg/m rail with reinforcement having a combined moment of inertia of $3.3 \text{ mm} \times 10^6 \text{ mm}^4$.
- (2) *Imperial Units.* For 12,000 lb total weight of car plus load and a bracket spacing of 16 ft 0 in., there is a required
- (a) 18.5 lb rail without reinforcement; or
- (b) 15 lb rail with reinforcement having a combined moment of inertia of 8 in.⁴

2.23.4.2 With Two (Duplex) Car or Counterweight Safeties. Where the car or counterweight is provided with two safety devices, the loads specified in Fig. 2.23.4.1-1 shall be permitted to be increased by the factors specified in Table 2.23.4.2.

2.23.4.3 Counterweight With No Safety

2.23.4.3.1 Guide rails for counterweights not provided with a safety device shall be fastened to the building structure at intervals specified in

Table 2.23.4.3.1, except as specified in 2.23.4.3.2, and the weight of the counterweight for each size of guide rail shall not exceed that specified in Table 2.23.4.3.1.

2.23.4.3.2 The bracket spacing specified shall be permitted to be increased by an amount determined by Figs. 2.23.4.1-1 and 2.23.4.1-2, subject to the following requirements:

(a) where guide rails are reinforced or a larger rail section is used having a moment of inertia, about an axis parallel to the base [x - x axis in Fig. 2.23.4.1-2], at least equal to that of the rail sections shown in Table 2.23.3, based on the weight of the counterweight

(b) where intermediate tie brackets, approximately equally spaced, are provided between the guide rails at intervals of not over 2 130 mm (84 in.)

2.23.4.3.3 Intermediate tie brackets, approximately equally spaced, shall be provided between the guide rails at intervals as specified in Table 2.23.4.3.3. Intermediate tie brackets are not required to be fastened to the building structure.

2.23.5 Stresses and Deflections

2.23.5.1 Guide Rails

2.23.5.1.1 For steels conforming to 2.23.2.1, the stresses in a guide rail, or in the rail and its reinforcement shall not exceed 105 MPa (15,000 psi), based upon the class of loading, and the deflection shall not exceed 6 mm (0.25 in.). The loads used to determine the guide-rail stress and deflection shall include vertical and moment loads transferred into the rail, that are imposed by equipment supported by the guide rail, combined with the horizontal forces imposed on the rail during loading, unloading, or running, calculated without impact (see 2.16.2.2 and 8.2.2.6).

2.23.5.1.2 Where steels of greater strength than those specified in 2.23.2.1 are used, the stresses specified may be increased proportionately, based on the ratio of the ultimate strengths.

2.23.5.2 Brackets, Fastenings, and Supports. The guide-rail brackets, their fastenings, and supports, such as building beams and walls, shall be capable of resisting the horizontal forces imposed by the class of loading (see 2.16.2.2 and 8.2.2.6) with a total deflection at the point of support not in excess of 3 mm (0.125 in.).

2.23.5.3 Allowable Stresses Due to Emergency Braking. Guide rails, brackets, supports, and their fastenings subject to forces due to the application of the emergency brake (see 2.19.4) shall be designed to withstand the maximum forces developed during the retardation phase of the emergency braking so that the resulting stresses due to the emergency braking and all other loading acting simultaneously, if applicable, shall not exceed 190 MPa (27,500 psi).

Fig. 2.23.4.1-1 Maximum Weight of a Car With Rated Load or of Counterweight With Safety Device for a Pair of Guide Rails as Specified in 2.23.4.1

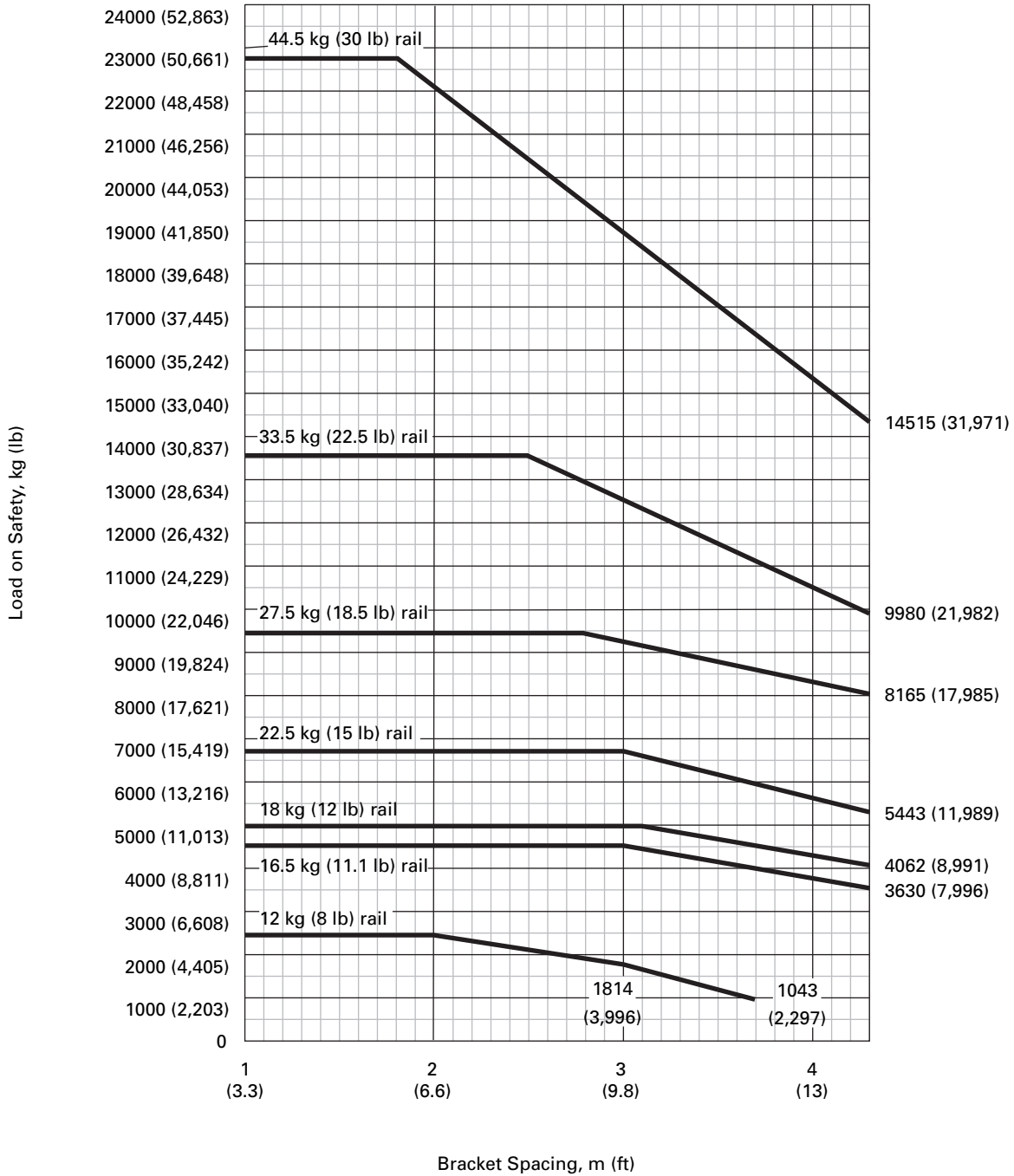

Fig. 2.23.4.1-2 Minimum Moment of Inertia About x-x Axis for a Single Guide Rail With Its Reinforcement

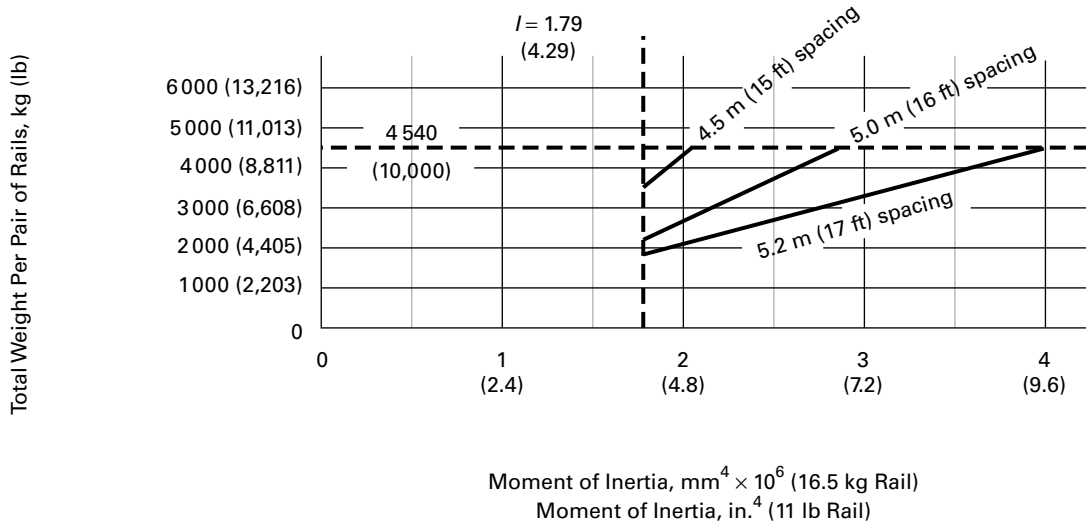
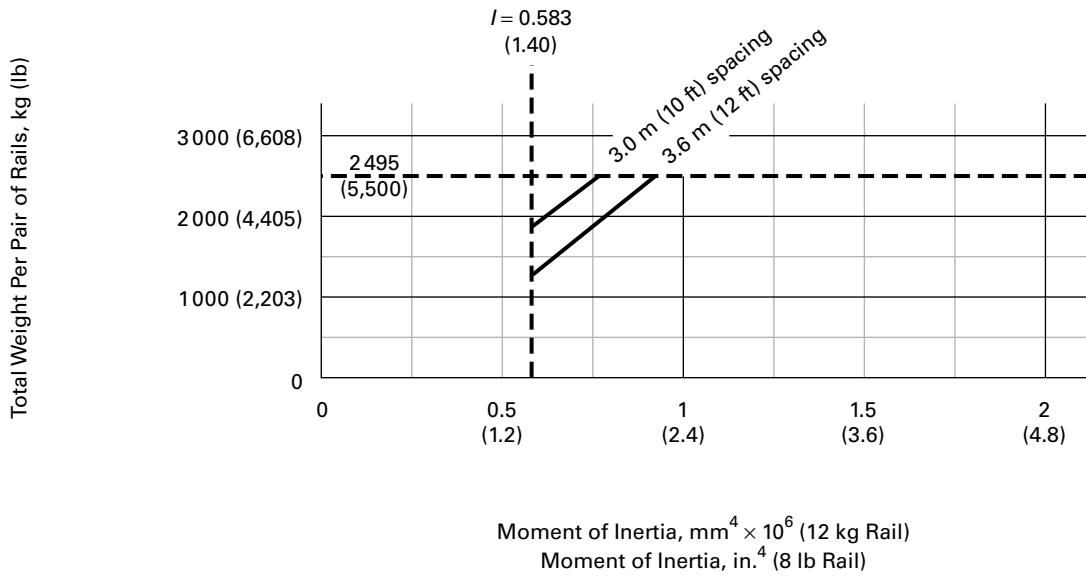
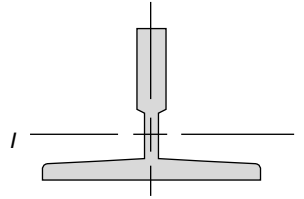

Fig. 2.23.4.1-2 Minimum Moment of Inertia About x-x Axis for a Single Guide Rail With Its Reinforcement (Cont'd)

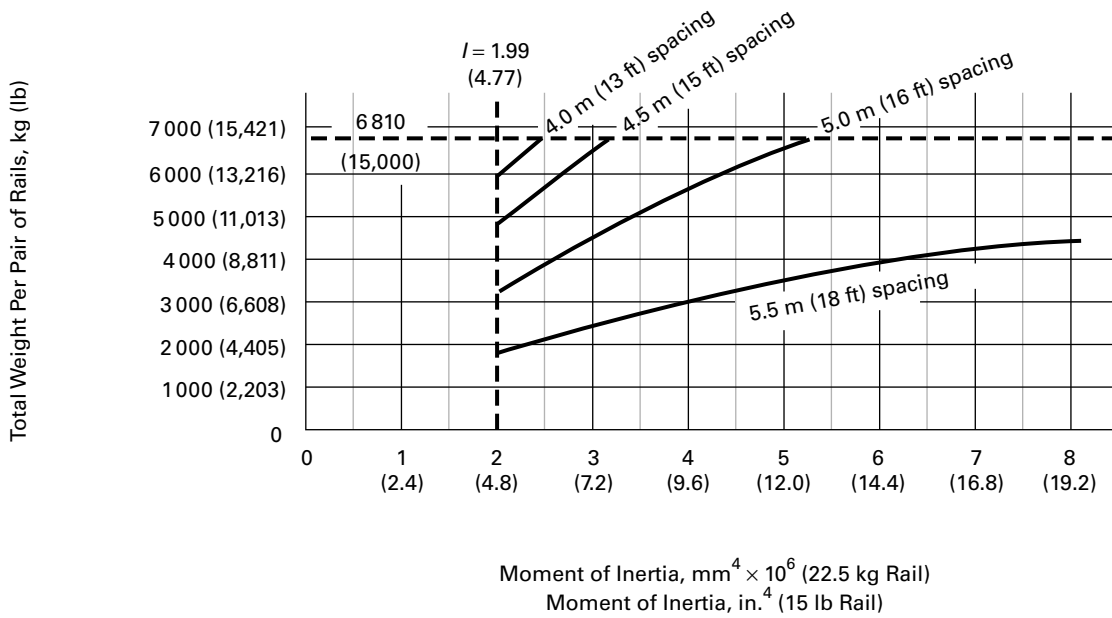
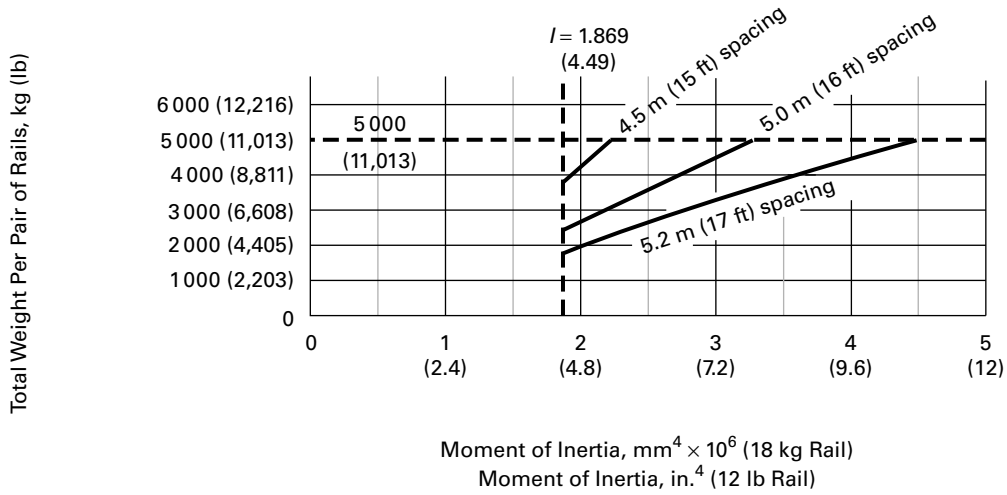
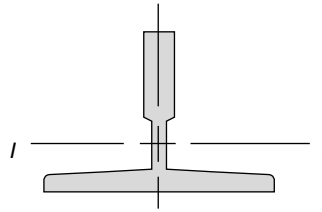

Fig. 2.23.4.1-2 Minimum Moment of Inertia About x-x Axis for a Single Guide Rail With Its Reinforcement (Cont'd)

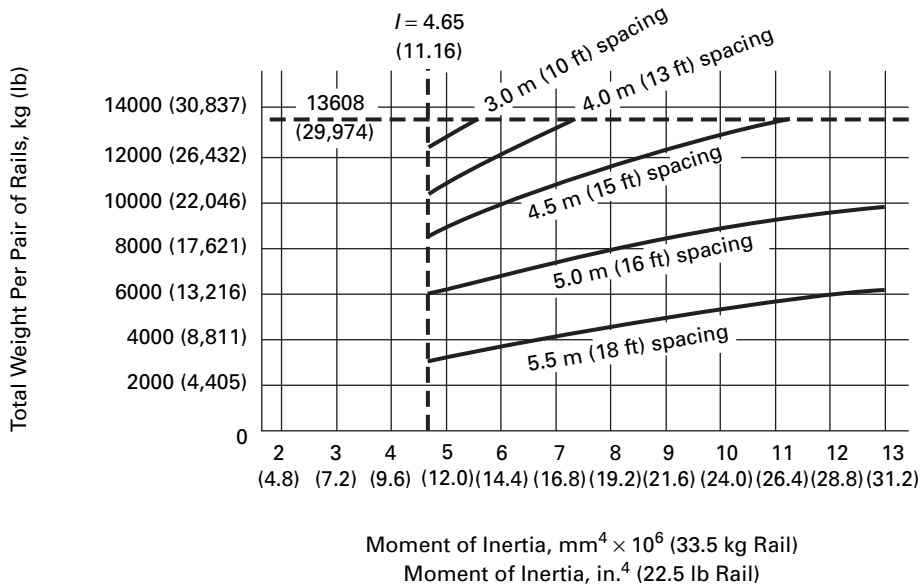
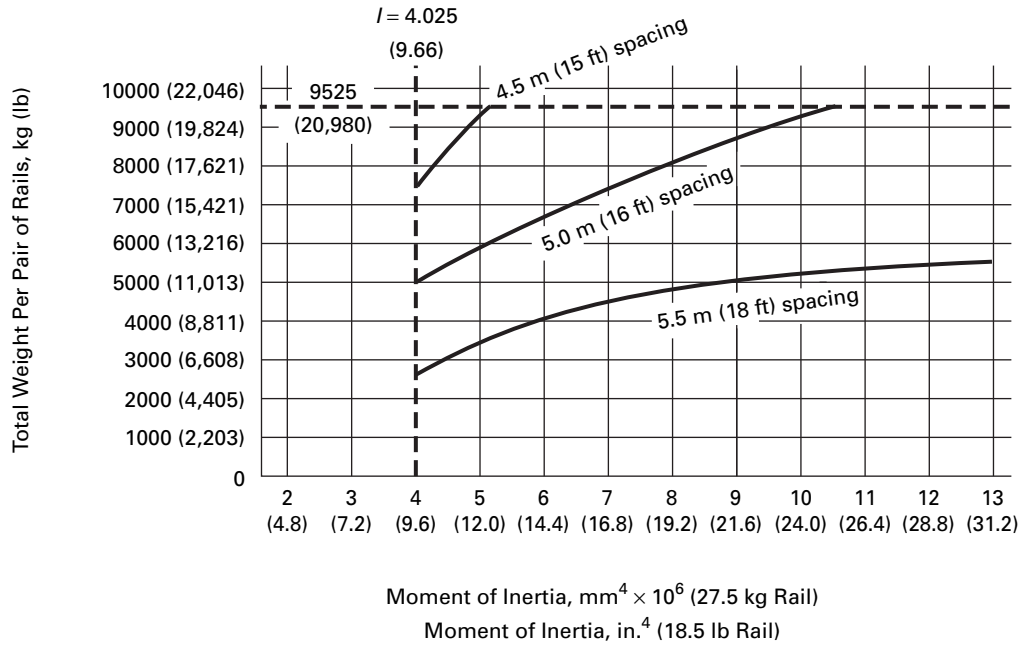
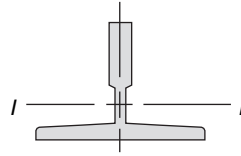

Fig. 2.23.4.1-2 Minimum Moment of Inertia About x-x Axis for a Single Guide Rail With Its Reinforcement (Cont'd)

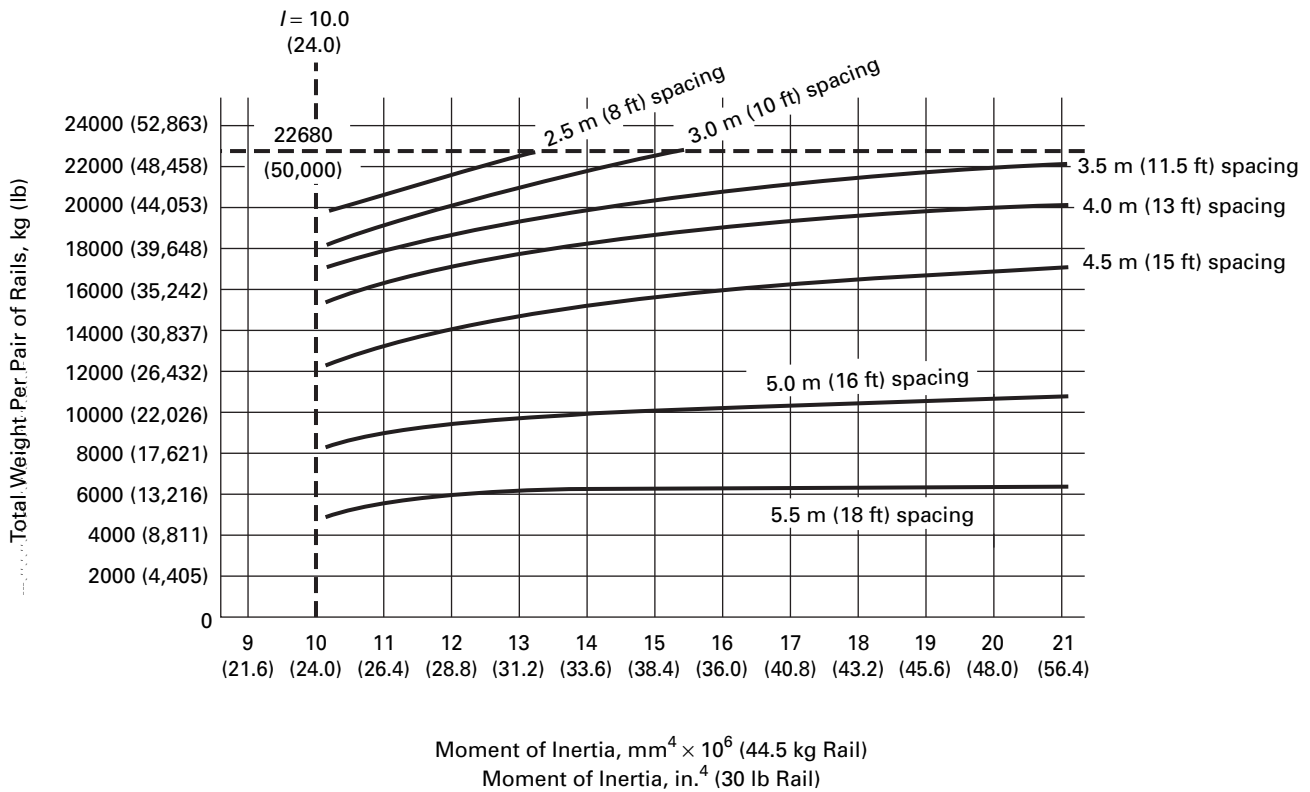
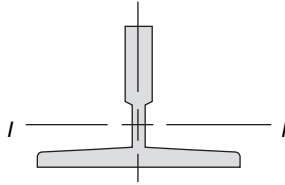

Table 2.23.4.2 Load Multiplying Factor for Duplex Safeties

| Vertical Distance Between Safeties, mm (in.) | Multiply Load in Fig. 2.23.4.1-1 by |
|--|--|
| 5 400 (212 or more) | 2.00 |
| 4 600 (182) | 1.83 |
| 3 700 (146) | 1.67 |
| 2 700 (106) | 1.50 |

Table 2.23.4.3.1 Guide Rails for Counterweight Without Safeties

| Mass of Counterweight, kg | SI Units | | Weight of Counterweight, lb | Imperial Units | |
|---------------------------|----------------------------------|---|-----------------------------|-------------------------------------|---|
| | Nominal Mass of Guide Rail, kg/m | Maximum Bracket Spacing Without Reinforcement, mm | | Nominal Weight of Guide Rail, lb/ft | Maximum Bracket Spacing Without Reinforcement, ft |
| 3 000 | 9.5 | 3 000 | 6,600 | 6 ¹ / ₄ | 10 |
| 4 000 | 8.5 | 4 400 | 8,800 | 5 ³ / ₄ | 14.5 |
| 7 000 | 12.0 | 4 900 | 15,000 | 8 | 16 |
| 12 000 | 16.5 | 4 900 | 27,000 | 11 | 16 |
| 13 000 | 18.0 | 4 900 | 29,000 | 12 | 16 |
| 18 000 | 22.5 | 4 900 | 40,000 | 15 | 16 |
| 25 000 | 27.5 | 4 900 | 56,000 | 18 ¹ / ₂ | 16 |
| 36 000 | 33.5 | 4 900 | 80,000 | 22 ¹ / ₂ | 16 |
| 60 000 | 44.5 | 4 900 | 133,000 | 30 | 16 |

Table 2.23.4.3.3 Intermediate Tie Brackets

| Nominal Distance Between Fastenings to Building Structure, mm (in.) | | Number of Intermediate Tie Brackets |
|---|-----------------------|-------------------------------------|
| For 8.5 kg (6 ¹ / ₄ lb) Rail | For All Other Rails | |
| 0–3 300 (0–130) | 0–3 700 (0–146) | 0 |
| 3 301–3 800 (130–150) | 3 701–4 300 (147–169) | 1 |
| 3 801–4 400 (150–173) | 4 301–4 900 (170–193) | 2 |

2.23.6 Guide-Rail Surfaces

Guide-rail surfaces used for guiding a car or counterweight shall be sufficiently smooth and true to operate properly with the guiding members. Those surfaces that the car or counterweight safeties engage shall be smooth and true within the tolerances required to ensure proper safety application without excessive retardation or excessive out-of-level platform conditions resulting (see 2.17.3, 2.17.9.2, and 2.17.16).

2.23.7 Rail Joints and Fishplates

2.23.7.1 Type and Strength of Rail Joints. Metal guide-rail sections shall be joined together as specified in 2.23.7.2. The jointed rail sections shall withstand the forces specified in 2.23.5.1 without exceeding the stress and deflection limitations.

2.23.7.2 Design and Construction of Rail Joints

2.23.7.2.1 The joints of metal guide rails with T-section profiles as specified in 2.23.3(a) shall conform to the following requirements:

(a) The ends of the rails shall be accurately machined with a tongue and matching groove centrally located in the web.

(b) The backs of the rail flanges shall be accurately machined, in relation to the rail guiding surfaces, to a uniform distance front to back of the rails to form a flat surface for the fishplates.

(c) The ends of each rail shall be bolted to the fishplates with not fewer than four bolts that conform to Table 2.23.7.2.1.

(d) The width of the fishplate shall be not less than the width of the back of the rail.

(e) The thickness of the fishplates and the diameter of the bolts for each size of guide rail shall be not less than specified in Table 2.23.7.2.1.

(f) The diameter of bolt holes shall not exceed the diameter of the bolts by more than 2 mm (0.08 in.) for guide rails nor 3 mm (0.125 in.) for fishplates.

2.23.7.2.2 Joints of different design and construction shall be permitted to be used, provided they are equivalent in strength and will adequately maintain the accuracy of the rail alignment.

2.23.8 Overall Length of Guide Rails

The car and counterweight guide rails shall extend at the top and bottom to prevent the guiding members (see 2.15.2 and 2.21.1.3) from disengaging from the guide rails in the event that either the car or counterweight reaches its extreme limit of travel.

2.23.9 Guide-Rail Brackets and Building Supports

2.23.9.1 Design and Strength of Brackets and Supports

2.23.9.1.1 The building construction forming the supports for the guide rails and the guide-rail brackets shall be designed to

(a) safely withstand the application of the car or counterweight safety when stopping the car and its rated load or the counterweight

(b) withstand the forces specified in 2.23.5.2 within the deflection limits specified

2.23.9.1.2 Walls of bricks, terra-cotta, hollow blocks, and similar materials shall not be used for attachment of guide-rail brackets unless adequately reinforced.

Table 2.23.7.2.1 Minimum Thickness of Fishplates and Minimum Diameter of Fastening Bolts

| SI Units | | | Imperial Units | | |
|----------------------------------|--------------------------------------|-------------------------------|-------------------------------------|---------------------------------------|--------------------------------|
| Nominal Mass of Guide Rail, kg/m | Minimum Thickness of Fish Plates, mm | Minimum Diameter of Bolts, mm | Nominal Weight of Guide Rail, lb/ft | Minimum Thickness of Fish Plates, in. | Minimum Diameter of Bolts, in. |
| 8.5 | 9.5 | M12 | 5 ³ / ₄ | 3/ ₈ | 1/ ₂ |
| 9.5 | 9.5 | M12 | 6 ¹ / ₄ | 3/ ₈ | 1/ ₂ |
| 12.0 | 14.0 | M12 | 8 | 9/ ₁₆ | 1/ ₂ |
| 16.5 | 17.0 | M16 | 11 | 11/ ₁₆ | 5/ ₈ |
| 18.0 | 17.0 | M16 | 12 | 11/ ₁₆ | 5/ ₈ |
| 22.5 | 17.0 | M16 | 15 | 11/ ₁₆ | 5/ ₈ |
| 27.5 | 20.0 | M20 | 18 ¹ / ₂ | 13/ ₁₆ | 3/ ₄ |
| 33.5 | 20.0 | M20 | 22 ¹ / ₂ | 13/ ₁₆ | 3/ ₄ |
| 44.5 | 23.0 | M20 | 30 | 15/ ₁₆ | 3/ ₄ |

2.23.9.1.3 Where necessary, the building construction shall be reinforced to provide adequate support for the guide rails.

2.23.9.2 Bracket Fastenings

2.23.9.2.1 Guide-rail brackets shall be secured to their supporting structure by one of the following means:

(a) by bolts or rivets

(b) by using clip fastenings to mount brackets to the building structure, provided that

(1) the friction force of such clips has a minimum factor of safety of 10

(2) an additional means, having a safety factor of not less than 5, of resisting horizontal shear is incorporated

(c) by welding conforming to 8.8

2.23.9.2.2 Fastening bolts and bolt holes in brackets and their supporting beams shall conform to 2.23.10.

2.23.9.3 Slotted guide-rail brackets having single-bolt fastenings shall be provided with an additional means to prevent lateral movement of the rail bracket. Such means shall have a factor of safety of not less than 5.

2.23.10 Fastening of Guide Rails to Rail Brackets

2.23.10.1 Type of Fastenings. Guide rails shall be secured to their brackets by clips, welds, or bolts.

Bolts used for fastening shall be of such strength as to withstand the forces specified in 2.23.5.2 and 2.23.9.1.

Welding, where used, shall conform to 8.8.

2.23.10.2 Size of Bolts for Fastening. The size of bolts used for fastening the guide rails or rail clips to the brackets shall be not less than specified in Table 2.23.10.2.

2.23.10.3 Bolt Holes for Fastenings. The diameter of holes or the width of slots for fastening bolts shall

Table 2.23.10.2 Minimum Size of Rail-Fastening Bolts

| SI Units | | Imperial Units | |
|----------------------------------|------------------------------------|-------------------------------------|-------------------------------------|
| Nominal Mass of Guide Rail, kg/m | Minimum Diameter of Rail Bolts, mm | Nominal Weight of Guide Rail, lb/ft | Minimum Diameter of Rail Bolts, in. |
| 8.5 | M12 | 5 ³ / ₄ | 1/ ₂ |
| 9.5 | M12 | 6 ¹ / ₄ | 1/ ₂ |
| 12.0 | M12 | 8 | 1/ ₂ |
| 16.5 | M16 | 11 | 5/ ₈ |
| 18.0 | M16 | 12 | 5/ ₈ |
| 22.5 | M16 | 15 | 5/ ₈ |
| 27.5 | M16 | 18 ¹ / ₂ | 5/ ₈ |
| 33.5 | M20 | 22 ¹ / ₂ | 3/ ₄ |
| 44.5 | M20 | 30 | 3/ ₄ |

not exceed the diameter of the bolt by more than 2 mm (0.08 in.).

SECTION 2.24 DRIVING MACHINES AND SHEAVES

2.24.1 Type of Driving Machines

All driving machines shall be of the traction type, except that winding-drum machines shall be permitted for freight elevators, subject to the following:

(a) They shall not be provided with counterweights.

(b) The rated speed of the elevator shall not exceed 0.25 m/s (50 ft/min).

(c) The travel of the elevator car shall not exceed 12.5 m (40 ft).

NOTE (2.24.1): See 4.1 for rack-and-pinion machines and 4.2 for screw machines.

2.24.2 Sheaves and Drums

2.24.2.1 Material and Grooving. Sheaves and drums used with suspension and compensating members shall be constructed of materials conforming to 2.24.2.1.1 or 2.24.2.1.2 and provided with finished grooves or shall be permitted to be lined with nonmetallic groove material. Sheaves and drums shall comply with 2.24.3.

2.24.2.1.1 Sheaves. Driving-machine sheaves shall be integral with or directly attached to driving-machine shafts. Sheaves shall be provided with steel shafts and metal bearings. Sheaves constructed of plastic, fiber-reinforced plastic, or combinations thereof shall be non-regroovable. Permanent and legible marking shall be provided on or adjacent to the nonmetallic sheaves stating, "Regrooving of sheave is not permitted."

2.24.2.1.2 Drums. Drums used with suspension and compensating members shall be constructed of metal.

2.24.2.2 Minimum Pitch Diameter. Sheaves and drums used with suspension and compensating means (see 2.20.1) shall have a pitch diameter of not less than

(a) 40 times the diameter of steel wire rope where used for suspension ropes

(b) 40 times the cord diameter (see ASME A17.6, 3.3.3.1.1) of noncircular elastomeric-coated steel suspension members where used for suspension

(c) 16 times the functional diameter (see ASME A17.6, 2.3.3.1.2) of the load-carrying fibers of aramid ropes where used for suspension or compensation

(d) 32 times the diameter of steel wire ropes and cord diameter of noncircular elastomeric-coated steel suspension members where used for compensation

2.24.2.3 Traction

2.24.2.3.1 For Steel Wire Ropes. Where the grooves are used to provide traction, sufficient traction shall be provided between the rope and groove, and in the event of nonmetallic lining failure, between the rope and the remaining sheave groove, to safely stop and hold the car with rated load [see 2.16.8(c)] from rated speed in the down direction.

2.24.2.3.2 For Aramid Fiber Ropes. Where grooves are used to provide traction, sufficient traction shall be provided between the rope cover and the groove, and in the event of failure of the cover, between the load-carrying portion of the rope and the sheave groove, to safely stop and hold the car with rated load [see 2.16.8(c)] from rated speed in the down direction. Undercut grooves shall not be permitted with aramid fiber rope.

2.24.2.3.3 For Noncircular Elastomeric-Coated Steel Suspension Members. Where surfaces are used to provide traction, sufficient traction shall be provided

between the noncircular elastomeric-coated steel suspension member and the surface, and in the event of failure of the elastomeric coating, between the load-carrying cords and the sheave contact surface, to safely stop and hold the car with rated load [see 2.16.8(c)] from rated speed in the down direction.

2.24.2.3.4 If either the car or the counterweight bottoms on its buffers or becomes otherwise immovable

(a) the suspension members shall slip on the drive sheave and not allow the car or counterweight to be raised, or

(b) the driving system shall stall and not allow the car or counterweight to be raised

2.24.2.4 Minimum Sheave and Drum Diameter.

Drive sheaves and drums shall be permanently and legibly marked to state the minimum sheave or drum diameter, measured at the bottom of the groove, that is required to maintain structural integrity (see 2.24.3).

2.24.2.5 Retaining and Guarding of Suspension Members

2.24.2.5.1 Retaining Means. A means shall be provided to retain each suspension member in its respective position on all sheaves used in the suspension of the elevator when subjected to any retardation that can cause a slackening of the suspension members. Where suspension-system retainers are designed in accordance with 8.4.3.1, this requirement is met.

2.24.2.5.2 Guarding Means. Guards shall be provided to a minimum height of 1 000 mm (39 in.) above the machine-room floor or base of a working platform, where used, to protect the suspension members from accidental contact by foreign objects. Guards shall be designed to allow easy access for inspection purposes.

2.24.3 Factor of Safety for Driving Machines, Sheaves, and Drums

The factor of safety to be used in the design of driving machines, sheaves, and drums used with suspension means and compensating means shall be not less than

(a) 8 for metals having an elongation of at least 14% in a gauge length of 50 mm (2 in.) when tested in accordance with ASTM E8.

(b) 10 for cast iron, or for metals having an elongation of less than 14% in a gauge length of 50 mm (2 in.) when tested in accordance with ASTM E8.

(c) 10 for sheaves of plastic, fiber-reinforced plastic, or combinations thereof. The material used shall ensure that the factor of safety is not less than 8 during the service life of the sheave.

The load to be used in determining the factor of safety shall be the resultant of the maximum tensions in the suspension means leading from the sheave or drum with the elevator at rest and with the rated load in the car.

2.24.3.1 Factors of Safety Based on Alternating/Reversing Stresses

2.24.3.1.1 Driving-machine components subjected to alternating or reversing stresses shall have a factor of safety of not less than 1.5.

2.24.3.1.2 This factor of safety shall be the ratio of the endurance limit of the components (see 1.3) to the actual alternating or reversing stress to which the components can be subjected under any normal operating condition. The endurance limit shall be based on 10^7 cycles of stress reversals. The actual stress shall include all designed or anticipated load conditions and stress risers, such as sharp corners, shock loading, surface finish, keyways, material variations, alignment tolerances, etc.

2.24.3.2 Factors of Safety at Emergency Braking.

Driving-machine components including bedplate, where used, subject to forces due to the application of the emergency brake (see 2.19.4) shall be designed to withstand the maximum forces developed during the retardation phase of the emergency braking so that the factor of safety resulting from the emergency braking and all other loading acting simultaneously, if applicable, shall be not less than those specified in 2.24.3(a) and 2.24.3(b).

(13) 2.24.4 Fasteners and Connections Transmitting Load

2.24.4.1 Fasteners and Rigid Connections. Fasteners and rigid connections shall comply with 2.24.4.1.1 through 2.24.4.1.4 in accordance with good engineering practice.

2.24.4.1.1 When fasteners are used to transmit load, the shearing load shall not be applied to the threaded portion of fasteners. Where more than one fastener shares the shearing load, the clearance between the fasteners and holes shall be designed with tolerance fits that will provide even distribution of the shear loading across all of the fasteners.

2.24.4.1.2 Set screws shall not be permitted to transmit torque.

2.24.4.1.3 When the connection is designed to transmit the torque by the friction of the clamped surfaces resulting from the applied fastener torques, 2.24.4.1.1 shall not apply.

2.24.4.1.4 The factors of safety to be used in the design of fasteners transmitting load or clamped surfaces transmitting torque in driving machines and sheaves shall be not less than those specified in 2.24.3.

2.24.4.2 Flexible Connections. Where flexible couplings are used to transmit load, means shall be provided to prevent disengagement of the coupling components in the event of the failure of or excessive motion in the flexible connection.

2.24.5 Shaft Fillets and Keys

A fillet shall be provided at any point of change in the diameter of driving-machine shafts and sheave shafts to prevent excessive stress concentrations in the shafts (see 2.24.3.1).

Shafts that support drums, sheaves, gears, couplings, and other members, and that transmit torque, shall be provided with tight-fitting keys.

2.24.6 Cast-Iron Worms and Worm Gears

Worms and worm gears made of cast iron shall not be used in elevator driving machines.

2.24.7 Friction Gearing and Clutches

Friction gearing or a clutch mechanism shall not be used to connect a driving-machine drum or sheave to the main driving mechanism.

2.24.8 Braking System and Driving-Machine Brakes (See Nonmandatory Appendix F, Table F-1)

2.24.8.1 General Requirements. The elevator shall be provided with a braking system conforming to 2.24.8.2.

2.24.8.2 Braking System

2.24.8.2.1 The braking system shall consist of a driving-machine brake and in addition shall be permitted to include other braking means, such as electrically assisted braking.

2.24.8.2.2 The braking system shall be capable of decelerating the car from its rated speed when it is carrying its rated load (see 2.16.8) in the down direction, or empty car in the up direction from the speed at which the governor overspeed switch is set. Any deceleration not exceeding 9.8 m/s^2 (32.2 ft/s^2) is acceptable, provided that all factors such as, but not limited to, system heat dissipation and allowable buffer striking speeds are considered. The loss of main line power shall not reduce the braking system capacity below the requirements stated here.

2.24.8.3 Driving-Machine Brake. The driving machine shall be equipped with a friction brake applied by a spring or springs, or by gravity, and released electromechanically or electrohydraulically (see 1.3) in conformance with 2.26.8. The driving-machine brake, on its own, shall be capable of

(a) holding the car at rest with its rated load (see 2.16.8 and 2.26.8)

(b) holding the empty car at rest

(c) decelerating the empty car traveling in the up direction from the speed at which the governor overspeed switch is set. Any deceleration not exceeding 9.8 m/s^2 (32.2 ft/s^2) is acceptable provided that all factors such as, but not limited to, system heat dissipation and allowable buffer striking speeds are considered.

2.24.8.4 Means for Manual Release. Means shall be permitted for manual release of the driving-machine brake. The means shall permit car movement in a gradual, controllable manner. Provision shall be made to prevent unintended actuation of the device. The manual release device shall be designed to be hand applied only with continuous effort. The brake shall reapply at its fully adjusted capacity in the absence of the hand-applied effort. Devices required in accordance with 2.19 are permitted to be temporarily disabled when the manual release device is in use.

2.24.8.5 Marking Plates for Brakes. The brake setting and method of measurement shall be permanently and legibly marked on the driving machine.

2.24.8.6 Driving-Machine Brake Design. The driving-machine brake design shall ensure contact of the friction material on the braking surface consistent with good engineering practice. Means shall be provided to protect the braking surfaces from contamination caused by any driving-machine fluid leak.

2.24.9 Indirect Driving Machines

2.24.9.1 Belt and Chain Drives. Indirect driving machines, utilizing V-belt drives, tooth drive belts, or drive chains, shall include not less than three belts or chains operating together in parallel as a set. Belt and chain drive sets shall be preloaded and matched for length in sets.

2.24.9.2 General Requirements

2.24.9.2.1 Belt sets shall be selected on the basis of the manufacturer's rated breaking strength and a factor of safety of 10. Chain and sprocket sets shall be selected on the basis of recommendations set forth in the Supplementary Information section of ASME B29.1M, using a service factor of 2. Offset links in chain are not permitted.

2.24.9.2.2 Sprockets in a chain drive set and also a driven set shall be assembled onto a common hub, with teeth cut in-line after assembly to assure equal load distribution on all chains. Tooth sheaves for a belt drive shall be constructed in a manner to assure equal load distribution on each belt in the set.

2.24.9.2.3 Load determination for both the belt and chain sets shall be based on the maximum static loading on the elevator car, that is the full load in the car at rest and at a position in the hoistway that creates the greatest load, including either the car or counterweight resting on its buffer.

2.24.9.2.4 Chain drives and belt drives shall be guarded to protect against accidental contact and to prevent foreign objects from interfering with the drives.

2.24.9.3 Monitoring and Brake Location. Each belt or chain shall be continuously monitored by a broken

belt or chain device, that shall function to stop the car at the next available landing and prevent it from running, in the event that any belt or chain in the set breaks or becomes excessively slack. The driving-machine brake shall be located on the traction sheave or drum assembly side of the driving machine so as to be fully effective in the event that the entire belt set or chain set should break.

2.24.10 Means for Inspection of Gears

Each gear case of geared machines shall have access to permit inspection of the contact surfaces of the gears. Such access need not provide a direct view of all gears, but shall be located and sized adequately to allow access by fibre optic or similar visual inspection instrumentation.

SECTION 2.25 TERMINAL STOPPING DEVICES

2.25.1 General Requirements

2.25.1.1 Normal terminal stopping devices required by 2.25.2, emergency terminal stopping devices required by 2.25.4.2, and emergency terminal speed-limiting devices required by 2.25.4.1 shall be permitted to use mechanically operated, magnetically operated, optical, or solid-state devices for determining car position and speed.

2.25.1.2 Final terminal stopping devices required by 2.25.3 shall use only mechanically operated switches for determining car position.

2.25.1.3 Terminal stopping devices that are located on the car or in the hoistway shall be of the enclosed type and securely mounted in such a manner that horizontal movement of the car shall not affect the operation of the device.

2.25.2 Normal Terminal Stopping Devices

2.25.2.1 Where Required and Function. Normal terminal stopping devices shall conform to 2.25.2.1.1 through 2.25.2.1.3.

2.25.2.1.1 Normal terminal stopping devices shall be provided and arranged to detect the position of the car and cause the car to slow down and stop the car automatically, at or near the top and bottom terminal landings, with any load up to and including rated load in the car and from any speed attained in normal operation (see 2.16.8). (13)

2.25.2.1.2 The normal terminal stopping devices shall function independently of the operation of the normal stopping means and of the final terminal stopping device, such that the failure of the normal stopping means and/or the failure of the final terminal stopping devices shall not prevent the normal terminal (13)

stopping device from functioning as specified in 2.25.2.1.1, except that

(a) a common position sensing actuating means (e.g., a cam, etc.) that is not physically part of the position sensing devices shall be permitted for the actuation of the position sensing device(s) of the normal terminal stopping devices and the position sensing device of

- (1) the normal stopping means, and/or
- (2) the final terminal stopping devices

(b) a common member (e.g., tape, target, wire, etc.) that is sensed by both the normal terminal stopping devices and normal stopping means shall be permitted, provided that

(1) the member is monitored such that when its presence is not detected, this shall cause the electric power to be removed from the elevator driving-machine motor and brake, and

(2) the common member is securely mounted in such a manner that horizontal movement of the car shall not affect the operation of the sensors

(c) a common mounting means shall be permitted for the position sensing devices of the normal terminal stopping devices and the position sensing device of

- (1) the normal stopping means, and/or
- (2) the final terminal stopping devices

(d) on elevators with a rated speed of 0.75 m/s (150 ft/min) or less, the normal terminal stopping device shall be permitted to be used as the normal stopping means

2.25.2.1.3 The device shall be so designed and installed that it will continue to function until the final terminal stopping device operates.

2.25.2.2 Location of Stopping Devices. Normal terminal stopping devices shall be located as specified in 2.25.2.2.1 and 2.25.2.2.2.

2.25.2.2.1 Stopping devices for traction machines shall be located on the car, in the hoistway, a machinery space, machine room, control space, or control room, and shall be operated by the movement of the car.

2.25.2.2.2 Stopping devices for winding-drum machines shall be located on the car or in the hoistway, and shall be operated by the movement of the car.

2.25.2.3 Indirectly Operated Normal Terminal Stopping Devices. Stopping devices that are not located on the car or in the hoistway shall conform to 2.25.2.3.1 through 2.25.2.3.3.

2.25.2.3.1 The stopping device shall be mounted on and operated by a stopping means mechanically connected to and driven by the car.

Stopping means depending on friction or traction shall not be used.

2.25.2.3.2 Tapes, chains, ropes, or similar devices mechanically connecting the stopping device to the car and used as a driving means shall be provided with a device that will cause the electric power to be removed from the elevator driving-machine motor and brake if the driving means fails (see 2.26.2.6).

2.25.2.3.3 If mechanically operated switches are used, only one set of floor-stopping contacts is necessary for each terminal landing on floor controllers or other similar devices used to stop the car automatically at the landings (such as automatic operation, signal operation, etc.), provided these contacts and the means for operating them conform to 2.25.2.3.1 and 2.25.2.3.2. These contacts shall be permitted to serve also as the normal terminal stopping devices.

2.25.3 Final Terminal Stopping Devices

2.25.3.1 General Requirements. Final terminal stopping devices shall conform to 2.25.1 and the following:

- (a) They shall be mechanically operated.
- (b) Operating cams shall be of metal.
- (c) The switch contacts shall be directly opened mechanically.

2.25.3.2 Where Required and Function. Final terminal stopping devices shall be provided and arranged to cause the electric power to be removed automatically from the elevator driving-machine motor and brake after the car has passed a terminal landing.

The device shall be set to function as close to the terminal landing as practicable, but so that under normal operating conditions it will not function when the car is stopped by the normal terminal stopping device.

Where spring buffers are provided, the device shall function before the buffer is engaged.

The device shall be so designed and installed that it will continue to function

(a) at the top terminal landing, until the car has traveled above this landing a distance equal to the counterweight runby plus 1.5 times the buffer stroke, but in no case less than 0.6 m (2 ft)

(b) at the bottom terminal landing, until the car rests on its fully compressed buffer

The operation of final terminal stopping devices shall prevent movement of the car by the normal operating devices in both directions of travel.

2.25.3.3 Location. Final terminal stopping devices shall be located as specified in 2.25.3.3.1 and 2.25.3.3.2.

2.25.3.3.1 Traction machine elevators shall have final terminal stopping switches operated by cams.

One of the assemblies (i.e., switch or cam) shall be mounted on the car and the other in the hoistway. Where the final terminal stopping switch assembly is located on the car, and the signals from the switches are transmitted

through wiring in the traveling cable, the design shall be such that any single ground or short circuit shall not render the final terminal stopping device ineffective.

2.25.3.3.2 Winding-drum-machine elevators shall have two sets of final terminal stopping switches, one located on and operated by the driving machine, and the other located in the hoistway and operated by cams attached to the car (see 2.25.3.5).

2.25.3.4 Controller Devices Controlled by Final Terminal Stopping Device. The normal terminal stopping device and final terminal stopping devices shall not control the same controller devices unless two or more separate and independent controller devices are provided, two of which shall complete both the driving-machine motor and the driving-machine brake circuits in either direction of travel.

Elevators employing a two- or three-phase alternating-current driving-machine motor, which is not driven from a direct-current source through a static inverter, shall be provided with a means to inhibit the flow of alternating-current in each phase.

The control circuits shall be so designed and installed that a single ground or short circuit shall not prevent both the normal terminal stopping device and final terminal stopping device control circuits from stopping the car.

2.25.3.5 Additional Requirements for Winding-Drum Machines. Final terminal stopping devices for winding-drum machines shall conform to 2.25.3.5.1 through 2.25.3.5.3.

2.25.3.5.1 Stopping switches, located on and operated by the driving machine, shall not be driven by chains, ropes, or belts.

2.25.3.5.2 Where a two- or three-phase AC driving-machine motor is used, the mainline circuit to the driving-machine motor and the circuit of the driving-machine brake coil shall be directly opened either by the contacts of the machine stop switch or by stopping switches mounted in the hoistway and operated by a cam attached to the car. The opening of these contacts shall occur before or coincident with the opening of the final terminal stopping switch required by 2.25.3.2.

2.25.3.5.3 Driving machines equipped with a direct-current brake and having a DC mainline control switch in the driving-machine motor circuit controlled by a final terminal stopping switch located in the hoistway and operated by a cam attached to the car need not conform to 2.25.3.5.2. This does not eliminate the need for a machine-operated switch.

2.25.4 Emergency Terminal Stopping Means

2.25.4.1 Emergency Terminal Speed-Limiting Device. Emergency terminal speed-limiting devices shall be installed on all elevators where reduced stroke

buffers are used (see 2.22.4.1.2 and 2.26.2.12), and shall conform to 2.25.4.1.1 through 2.25.4.1.9.

2.25.4.1.1 If the normal terminal stopping device fails to slow down the car at the terminal as intended, the emergency terminal speed-limiting device shall reduce the car and counterweight speed such that the rated buffer striking speed is not exceeded. The emergency terminal speed-limiting device shall remove power from the driving-machine motor and brake and shall either

(a) apply an emergency brake(s) conforming to 2.19.3 in combination with the removal of power from the driving-machine motor and brake (see also 2.25.4.1.3), or

(b) apply an emergency brake(s) conforming to 2.19.3 if removal of power from the driving-machine motor and brake fails to reduce the car and counterweight speed as intended.

2.25.4.1.2 The operation of the emergency terminal speed-limiting device shall be independent of the operation of the normal terminal stopping device such that the failure of the normal terminal stopping device shall not prevent the emergency terminal speed-limiting device from functioning as specified, except that

(a) a common position sensing actuating means (e.g., a cam, etc.) not physically part of the position sensing devices shall be permitted for the actuation of both the position sensing device of the emergency terminal speed-limiting device and the position sensing device of the normal terminal stopping device

(b) a common member (e.g., tape, target, wire, etc.) that is sensed by both the emergency terminal speed-limiting device and the normal terminal stopping means shall be permitted, provided that

(1) the member is monitored such that when its presence is not detected, this shall cause the electric power to be removed from the elevator driving-machine motor and brake, and

(2) the common member is securely mounted in such a manner that horizontal movement of the car shall not affect the operation of the sensors

(c) a common mounting means shall be permitted for the position sensing devices of the emergency terminal speed-limiting device and the normal terminal stopping device

2.25.4.1.3 The car speed-sensing device used for the emergency terminal speed-limiting device shall be permitted to be either a separate car speed-sensing device from that of the normal speed control system or the same car speed-sensing device, provided that a separate means is used to continuously verify the proper operation of this speed-sensing device. Where the same car speed-sensing device is used, the detection of a failure of this car speed-sensing device shall cause the power to be removed from the driving-machine motor and brake.

The car speed-sensing device(s) and, where required, the verification means described above, shall conform to the following:

(a) a common actuating means (e.g., a driving-machine shaft, brake drum, etc.) shall be permitted provided that it is not dependent on the following connection types, unless the connection is continuously monitored:

(1) traction (excluding the traction between the drive sheave and suspension means and the traction between the governor and governor rope)

(2) friction (except for interference fits)

(3) a flexible coupling where positive engagement is not assured between coupling halves

Where monitoring is required, the monitoring shall detect a failure that prevents conformance with this requirement and shall cause the electric power to be removed from the elevator driving-machine motor and brake.

(b) a common member (e.g., tape, target, wire, etc.) that is sensed by both speed-sensing devices shall be permitted, provided that

(1) the member is monitored such that when its presence is not detected, this shall cause the electric power to be removed from the elevator driving-machine motor and brake

(2) the common member is securely mounted in such a manner that horizontal movement of the car shall not affect the operation of the sensors

(c) a common mounting means shall be permitted

(13) **2.25.4.1.4** The emergency terminal speed-limiting device shall provide a retardation not in excess of 9.81 m/s^2 (32.2 ft/s^2).

2.25.4.1.5 The emergency terminal speed-limiting devices shall be so designed and installed that a single short circuit caused by a combination of grounds, or by other conditions, shall not render the device ineffective.

2.25.4.1.6 The emergency terminal speed-limiting devices shall be located on the car, in the hoistway, or a machinery space, machine room, control space, or control room, and shall be operated by the movement of the car.

2.25.4.1.7 Mechanically operated switches, where located on the car or in the hoistway, shall conform to 2.25.3.1.

(13) **2.25.4.1.8** Where the operation of emergency terminal speed-limiting devices is dependent on car position relative to the terminal landings

(a) friction or traction drives shall not be used for the determination of the position of the car relative to the terminal landings, except where 2.25.4.1.9(a)(1) or 2.25.4.1.9(a)(2) is complied with

(1) The position sensing device for the emergency terminal speed-limiting device is driven by the overspeed governor and the car position is corrected before the car approaches a terminal landing and also compensated for governor rope creep over the governor sheave.

(2) An additional, separate emergency terminal speed-limiting position sensing device not relying on the same friction or traction drive is used to verify the emergency terminal speed-limiting device position sensing device. When the verification determines that the position sensing devices deviate to the extent that the emergency terminal speed-limiting device cannot stop the car as required, the power shall be removed from the driving-machine motor and brake.

(b) if tape, chain, or rope is used for connection to the car, a switch shall be provided to remove electrical power from the driving-machine motor and brake should this connection fail (see 2.26.2.6)

2.25.4.1.9 Where magnetically operated, optical, or solid-state devices are used for position sensing, a single short circuit caused by a combination of grounds or by other conditions, or the failure of any single magnetically operated, optical, or solid-state device shall not

(a) render the emergency terminal speed-limiting device inoperative

(b) permit the car to restart after a normal stop

2.25.4.2 Emergency Terminal Stopping Device. (13)

Emergency terminal stopping devices shall be installed on all elevators with static control and rated speeds over 1 m/s (200 ft/min) and shall conform to 2.25.4.2.1 and 2.25.4.2.2, except for elevators with static generator-field control that use the normal terminal stopping device to limit the generator-field current directly, or elevators that have an emergency terminal speed-limiting device that complies with 2.25.4.1.

2.25.4.2.1 The emergency terminal stopping device shall cause power to be removed from the driving-machine motor and brake should the normal stopping means and the normal terminal stopping device fail to cause the car to slow down at the terminal as intended.

2.25.4.2.2 The emergency terminal stopping device shall function independently of the normal terminal stopping device and the normal speed control system such that the failure of the normal terminal stopping device and/or the failure of the normal speed control system shall not prevent the emergency terminal stopping device from functioning as specified, except that

(a) for both the position sensing device of the emergency terminal stopping device and the position sensing device of the normal terminal stopping device

(1) a common actuating means (e.g., a cam, etc.) that is not physically part of the position sensing devices shall be permitted

(2) a common member (e.g., tape, target, wire, etc.) that is sensed by both the emergency terminal stopping device and normal terminal stopping means shall be permitted, provided that

(a) the member is monitored such that when its presence is not detected, this shall cause the electric power to be removed from the elevator driving-machine motor and brake, and

(b) the common member is securely mounted in such a manner that horizontal movement of the car shall not affect the operation of the sensors

(3) a common mounting means shall be permitted for the position sensing devices of the emergency terminal stopping device and the normal terminal stopping device

(b) The car speed-sensing device used for the emergency terminal stopping device shall be permitted to be either a separate car speed-sensing device from that of the normal speed control system or the same car speed-sensing device, provided that a separate means is used to continuously verify the proper operation of this speed-sensing device. Where the same car speed-sensing device is used, the detection of a failure of this car speed-sensing device shall cause the power to be removed from the driving-machine motor and brake.

The car speed-sensing device(s) and, where required, the verification means described above, shall conform to the following:

(1) a common actuating means (e.g., a driving-machine shaft, brake drum, etc.) shall be permitted provided that it is not dependent on the following connection types, unless the connection is continuously monitored:

(a) traction (excluding the traction between the drive sheave and suspension means and the traction between the governor and governor rope)

(b) friction (except for interference fits), or

(c) a flexible coupling where positive engagement is not assured between coupling halves

Where monitoring is required, the monitoring shall detect a failure that prevents conformance with this requirement and shall cause the electric power to be removed from the elevator driving-machine motor and brake.

(2) a common member (e.g., tape, target, wire, etc.) that is sensed by both speed-sensing devices shall be permitted, provided that

(a) the member is monitored such that when its presence is not detected, this shall cause the electric power to be removed from the elevator driving-machine motor and brake

(b) the common member is securely mounted in such a manner that horizontal movement of the car shall not affect the operation of the sensors

(3) a common mounting means shall be permitted

SECTION 2.26

OPERATING DEVICES AND CONTROL EQUIPMENT

2.26.1 Operation and Operating Devices

2.26.1.1 Types of Operating Devices. All operating devices shall be of the enclosed electric type.

Rope or rod operating devices actuated manually, or rope operating devices actuated by wheels, levers, or cranks, shall not be used.

2.26.1.2 For Car-Switch Operation Elevators. Handles of lever-type operating devices of car-switch operation elevators shall be so arranged that they will return to the stop position and latch there automatically when the hand of the operator is removed.

2.26.1.3 Additional Operating Devices for Elevators Equipped to Carry One-Piece Loads Greater Than the Rated Load. Elevators equipped to carry one-piece loads greater than their rated load shall be provided with an additional operating device of the continuous-pressure type to operate the elevator at a speed not exceeding 0.75 m/s (150 ft/min) under such conditions. The normal operating devices shall be inoperative during such operation (see 2.16.7.10).

2.26.1.4 Inspection Operation. See Appendix R, Table R-1.

2.26.1.4.1 General Requirements

(13)

(a) *Operating Devices*

(1) Operating devices for inspection operation shall be provided

(a) on the top of the car

(b) at the inspection and test panel when required by 2.7.6.5.2(h)

(2) Operating devices for inspection operation shall also be permitted

(a) in the car

(b) in a machinery space outside the hoistway

(c) in a machine room

(d) in a control space outside the hoistway

(e) in a control room

(f) in the pit in accordance with 2.7.5.2.2

(g) at a working platform in accordance with 2.7.5.3.6

(b) A switch for transferring control of the elevator to the operating devices for inspection operation shall be provided, that shall

(1) be manually operated

(2) be labeled "INSPECTION"

(3) have two positions, labeled "INSPECTION" or "INSP" and "NORMAL" or "NORM"

(4) when in the "INSPECTION" position

(a) enable inspection operation by means of the inspection operating devices

(b) except as provided, in 2.26.1.4.2(f), cause the movement of the car to be solely under the control of the inspection operating devices that shall be

(1) through a contact that is positively opened mechanically; their opening shall not depend solely on springs, or

(2) SIL rated with a SIL equal to or greater than the SIL indicated for the applicable device shown in Table 2.26.4.3.2

(c) disable automatic power door opening and closing and car leveling, except as provided in 2.26.1.4.2(f)

(5) when in the "NORMAL" position, disable inspection operation by means of the inspection operating devices

(c) Inspection operating devices shall

(1) be of the continuous-pressure type

(2) be labeled "UP" and "DOWN," respectively

(d) Inspection operation shall conform to the following:

(1) the speed of the car shall not exceed 0.75 m/s (150 ft/min)

For elevators with static control, a means independent from the normal means to control the speed shall be provided to limit the inspection speed to a maximum of 0.75 m/s (150 ft/min), should the normal means to control this speed (mechanical, electrical, or solid-state devices) fail to do so.

The car speed-sensing device used for the means to limit the speed of the car while on inspection operation shall be permitted to be either a separate car speed-sensing device from that of the normal speed control system or the same car speed-sensing device, provided that a separate means is used to continuously verify the proper operation of this speed-sensing device. Where the same car speed-sensing device is used, the detection of a failure of this car speed-sensing device while on inspection operation shall cause the power to be removed from the driving-machine motor and brake.

The car speed-sensing device(s) and, where required, the verification means described above, shall conform to the following:

(a) a common actuating means (e.g., a driving-machine shaft, brake drum, etc.) shall be permitted provided that it is not dependent on the following connection types, unless the connection is continuously monitored:

(1) traction (excluding the traction between the drive sheave and suspension means and the traction between the governor and governor rope)

(2) friction (except for interference fits), or

(3) a flexible coupling where positive engagement is not assured between coupling halves

Where monitoring is required, the monitoring shall detect a failure that prevents conformance with this requirement while on inspection operation and shall

cause the electric power to be removed from the elevator driving-machine motor and brake.

(b) a common member (e.g., tape, target, wire, etc.) that is sensed by both speed-sensing devices shall be permitted, provided that

(1) the member is monitored such that when its presence is not detected while on inspection operation, this shall cause the electric power to be removed from the elevator driving-machine motor and brake

(2) the common member is securely mounted in such a manner that horizontal movement of the car shall not affect the operation of the sensors

(c) a common mounting means shall be permitted

(2) be subject to the electrical protective devices required by 2.26.2, except as permitted by 2.26.1.5

(3) fully closed doors shall be permitted to be held in the closed position with power applied

(e) Inspection operation shall be used only by elevator personnel.

2.26.1.4.2 Top-of-Car Inspection Operation. Top-of-car inspection operation shall conform to 2.26.1.4.1 and the following:

(a) A stop switch (see 2.26.2.8) shall be permanently located on the car top and readily accessible to a person, while standing at the hoistway entrance normally used for access to the car top.

(b) The transfer switch [see 2.26.1.4.1(b)] shall be located on the car top and shall be so designed as to prevent accidental transfer from the "INSPECTION" to "NORMAL" position.

(c) A separate device of the continuous-pressure type labeled "ENABLE" shall be provided adjacent to the inspection operating devices.

(d) The inspection operating devices shall become effective only when the "ENABLE" device is activated.

(e) The inspection operating devices [see 2.26.1.4.1(c)], shall be permitted to be of the portable type, provided that

(1) the "ENABLE" device [see 2.26.1.4.2(c)], and a stop switch, in addition to the stop switch required in 2.26.1.4.2(a) are included in the portable unit

(2) the flexible cord is permanently attached so that the portable unit cannot be detached from the car top

(f) Separate additional devices of the continuous-pressure type shall be permitted to be provided on the car top to make power door opening and closing and automatic car leveling operative from the top of the car for testing purposes.

(g) When on top-of-car inspection operation, a separate additional device shall be permitted to render ineffective the top final terminal stopping device, and the buffer switch for gas spring-return counterweight oil buffers, in conformance with the requirements of 2.26.4.3, 2.26.9.3.1(a), 2.26.9.3.2, and 2.26.9.4, and it shall

allow the car to be moved to a position in conformance with the requirements of 2.7.4.5 and 2.7.5.1.3(c).

(h) The inspection operating devices shall be readily accessible to a person while standing in one of the horizontal areas described in 2.14.1.6.2 on the car enclosure top.

(13) **2.26.1.4.3 In-Car Inspection Operation.** When in-car inspection operation is provided, it shall conform to 2.26.1.4.1, and the transfer switch [see 2.26.1.4.1(b)]

(a) shall be located in the car.

(b) shall be key-operated or placed behind a locked cover. Keys to operate or access the switch shall be Group 1 Security (see 8.1).

(c) shall be rendered ineffective if top-of-car inspection operation is activated.

(d) when in the "INSPECTION" position, shall not enable hoistway access switch(es). A third switch position labeled "ACCESS ENABLE" shall be permitted to enable the hoistway access switches (see 2.12.7.3.1).

2.26.1.4.4 Machinery Space Outside the Hoistway, Machine Room, Control Space Outside the Hoistway, Control Room, Pit, Landing, and Working Platform Inspection Operations. Where inspection operation in a machinery space outside the hoistway, machine room, control space outside the hoistway, control room, pit, or at an inspection and test panel, or a working platform is provided, it shall conform to 2.26.1.4.1 and the following:

(a) The transfer switch [see 2.26.1.4.1(b)] shall be

(1) located in the pit, where provided in accordance with 2.7.5.2.2 (Pit Inspection Operation)

(2) located in the inspection and test panel as required by 2.7.6.5.2(h) (Landing Inspection Operation)

(3) located in the machinery space outside the hoistway, machine room, control space outside the hoistway, or control room, as applicable

(4) located at a working platform where required by 2.7.5.3.6 (Working Platform Inspection Operation)

(5) rendered ineffective if top-of-car inspection operation, in-car inspection operation, or hoistway access operation is activated, or when a car door or hoistway door bypass switch is in the "BYPASS" position

(b) Only one mode of the inspection operation as described in 2.26.1.4.4(a)(1) through (4) shall be permitted to be operative at any time. If more than one inspection operation transfer switch, as permitted in 2.26.1.4.4(a)(1) through (4), is in the "INSPECTION" position, the controls shall prevent operation of the car from any location as described in 2.26.1.4.4(a)(1) through (4).

(c) Pit inspection operation where provided shall also conform to 2.26.1.4.2(c) and (d). When the pit transfer switch is in the "INSPECTION" position, the controls shall prevent operation of the car when any inspection transfer switch, other than that in the pit, is in the

"INSPECTION" position, or when hoistway access operation is enabled.

(d) Where inspection operation from a working platform is provided and the working platform transfer switch is in the "INSPECTION" position, the controls shall prevent operation of the car when any other inspection transfer switch, other than that at the working platform, is in the "INSPECTION" position, or when hoistway access operation is enabled.

2.26.1.5 Inspection Operation With Open Door Circuits. A single set of switches marked "CAR DOOR BYPASS" and "HOISTWAY DOOR BYPASS" shall be provided. The switches shall be accessible from outside of the hoistway. They shall be located

(a) in a controller enclosure for the elevator located outside the hoistway in a control room, a control space, the machine room, a machinery space, or a motor controller complying with 2.7.6.3.2; or

(b) in the inspection and test panel (see 2.7.6.5)

The switches shall prepare the control system so that, only when top-of-car or in-car inspection operation is activated, the car shall be permitted to be moved with open door contacts. The switches shall conform to 2.26.1.5.1 through 2.26.1.5.8.

2.26.1.5.1 When switching to either "BYPASS" (13) or "OFF" position, they shall

(a) have contacts that are positively opened mechanically; their opening shall not be solely dependent on springs, or

(b) be SIL rated with a SIL equal to or greater than the SIL indicated for the applicable device shown in Table 2.26.4.3.2

2.26.1.5.2 The positions of the "BYPASS" switches shall be clearly marked "BYPASS" and "OFF."

2.26.1.5.3 The related circuits shall comply with 2.26.9.3 and 2.26.9.4.

2.26.1.5.4 When either or both of the switches are in the "BYPASS" position, all means of operation shall be made inoperative except top-of-car and in-car inspection operation [see also 2.26.1.4.4(c) and (d)].

2.26.1.5.5 When the "CAR DOOR BYPASS" switch is in the "BYPASS" position, it shall permit top-of-car and in-car inspection operation with open car door interlocks or car door or gate contacts.

2.26.1.5.6 When the "HOISTWAY DOOR BYPASS" switch is in the "BYPASS" position, it shall permit top-of-car and in-car inspection operation with open hoistway door interlocks or contacts.

2.26.1.5.7 Each of the "BYPASS" switches shall be permitted to be replaced by a set of switches used to bypass individual groups of door contacts. Each switch in this set shall be marked to identify the specific door contacts bypassed.

2.26.1.5.8 A warning sign shall be mounted adjacent to the "BYPASS" switches stating, "Jumpers shall not be used to bypass hoistway door or car door electric contacts."

2.26.1.6 Operation in Leveling or Truck Zone. Operation of an elevator in a leveling or truck zone at any landing by a car leveling or truck zoning device, when the hoistway doors, or the car doors or gates, or any combination thereof, are not in the closed position, is permissible, subject to the requirements of 2.26.1.6.1 through 2.26.1.6.7.

2.26.1.6.1 Operating devices of manually operated car leveling devices or truck zoning devices shall be of the continuous-pressure type and located in the car.

2.26.1.6.2 Car platform guards, conforming to 2.15.9, shall be provided. Where a car leveling device is used, landing sill guards, conforming to 2.11.12.7, shall also be provided.

2.26.1.6.3 The leveling zone at any landing shall not extend more than 450 mm (18 in.) above and below any landing where an automatic leveling device is used, and not more than 250 mm (10 in.) above and below any landing where a manually operated leveling device is used.

2.26.1.6.4 The truck zone at any landing shall not extend more than 1 700 mm (67 in.) above the landing.

2.26.1.6.5 Where a truck or leveling zone for one hoistway entrance extends into the door interlocking zone for a second entrance, the truck zoning or leveling operation shall be inoperative unless the hoistway door at the second entrance is in the closed position.

Where a truck or leveling zone for one hoistway entrance extends into the leveling zone for a second entrance, the leveling operation for the second entrance shall be inoperative while the hoistway door at the first entrance is open.

(13) **2.26.1.6.6** A leveling or truck-zoning device shall not move the car at a speed exceeding 0.75 m/s (150 ft/min).

For elevators with static control, a means independent from the normal means to control the speed shall be provided to limit the leveling speed to a maximum of 0.75 m/s (150 ft/min) with the doors open, should the normal means to control this speed (mechanical, electrical, or solid-state devices) fail to do so.

The car speed-sensing device used for the means to limit the speed of the car while leveling with open doors shall be permitted to be either a separate car speed-sensing device from that of the normal speed control system or the same car speed-sensing device, provided that a separate means is used to continuously verify the proper operation of this speed-sensing device. Where the same car speed-sensing device is used, the

detection of a failure of this car speed-sensing device while leveling with open doors shall cause the power to be removed from the driving-machine motor and brake.

The car speed-sensing device(s) and, where required, the verification means described above, shall conform to the following:

(a) a common actuating means (e.g., a driving-machine shaft, brake drum, etc.) shall be permitted provided that it is not dependent on the following connection types, unless the connection is continuously monitored:

(1) traction (excluding the traction between the drive sheave and suspension means and the traction between the governor and governor rope)

(2) friction (except for interference fits), or

(3) a flexible coupling where positive engagement is not assured between coupling halves

Where monitoring is required, the monitoring shall detect a failure that prevents conformance with this requirement while leveling with open doors and shall cause the electric power to be removed from the elevator driving-machine motor and brake.

(b) a common member (e.g., tape, target, wire, etc.) that is sensed by both speed-sensing devices shall be permitted, provided that

(1) the member is monitored such that when its presence is not detected, this shall cause the electric power to be removed from the elevator driving-machine motor and brake

(2) the common member is securely mounted in such a manner that horizontal movement of the car shall not affect the operation of the sensors

(c) a common mounting means shall be permitted

2.26.1.6.7 For elevators with static control, an inner landing zone extending not more than 75 mm (3 in.) above and 75 mm (3 in.) below the landing shall be provided. A car shall not move if it stops outside of the inner landing zone unless the doors are fully closed.

2.26.2 Electrical Protective Devices

(ED)

When an electrical protective device is activated (operated, opened), it shall cause the electric power to be removed from the elevator driving-machine motor and brake. [See also 2.26.3, 2.26.4.3, 2.26.4.4, 2.26.7, 2.26.8.3(c), 2.26.9.3, and 2.26.9.4.] Electrical protective devices shall be provided as specified in 2.26.2.1 through 2.26.2.39.

When an electrical protective device is activated (operated, opened), it shall be permitted to cause the emergency brake to apply (see 2.19.3).

2.26.2.1 Slack-Rope Switch. Winding-drum machines shall be provided with a slack-rope device equipped with a slack-rope switch of the enclosed manually reset type. This switch shall operate whenever the ropes are slack.

2.26.2.2 Motor-Generator Running Switch. Where generator-field control is used, means shall be provided to prevent the application of power to the elevator driving-machine motor and brake unless the motor generator set connections are properly switched for the running condition of the elevator. It is not required that the electrical connections between the elevator driving machine motor and the generator be opened in order to remove power from the elevator motor.

2.26.2.3 Compensating-Rope Sheave Switch. Compensating-rope sheaves shall be provided with a compensating-rope sheave switch or switches mechanically opened by the compensating-rope sheave before the sheave reaches its upper or lower limit of travel.

(13) **2.26.2.4 Motor Field Sensing Means.** Where direct current is supplied to an armature and shunt field of an elevator driving-machine motor, a motor field current sensing means shall be provided, that shall cause the electric power to be removed from the driving-machine motor armature, and brake unless current is flowing in the shunt field of the motor, except for static control elevators provided with a device to detect an overspeed condition prior to, and independent of, the operation of the governor overspeed switch, except that

(a) a common actuating means (e.g., a governor shaft or sheave, etc.) that is not physically part of the speed-sensing devices shall be permitted for the actuation of both the speed-sensing device of the overspeed detection device and the governor overspeed switch

(b) a common mounting means shall be permitted for the speed-sensing device of the overspeed detection device and the governor overspeed switch

This device shall cause power to be removed from the elevator driving-machine motor armature and machine brake.

2.26.2.5 Emergency Stop Switch. An emergency stop switch shall not be provided on passenger elevators. On all freight elevators, an emergency stop switch shall be provided in the car, and located in or adjacent to each car operating panel.

When open ("STOP" position), this switch shall cause the electric power to be removed from the elevator driving-machine motor and brake.

Emergency stop switches shall

(a) be of the manually opened and closed type

(b) have red operating handles or buttons

(c) be conspicuously and permanently marked "STOP," and shall indicate the "STOP" and "RUN" positions

(d) while opened, cause the audible device to sound (see 2.27.1.2)

NOTE (2.26.2.5): See 2.26.2.21 for in-car stop switch requirements for passenger elevators.

(ED) **2.26.2.6 Broken Rope, Tape, or Chain Switches.** The switch or switches that shall be opened by a failure of

a rope, tape, or chain, shall be provided when required by 2.25.2.3.2 or 2.25.4.1.7(b).

2.26.2.7 Stop Switch in Pit. A stop switch conforming to 2.26.2.5(a), (b), (c) shall be provided in the pit of every elevator (see 2.2.6).

2.26.2.8 Stop Switch on Top of Car. A stop switch conforming to 2.26.2.5(a), (b), and (c) shall be provided on the top of every elevator car.

2.26.2.9 Car Safety Mechanism Switch. A switch, conforming to 2.17.7 shall be required where a car safety is provided.

2.26.2.10 Speed-Governor Overspeed Switch. A speed-governor overspeed switch shall be provided when required by 2.18.4.1 and shall conform to 2.18.4.1.2, 2.18.4.1.3, 2.18.4.2, and 2.18.4.3. (ED)

2.26.2.11 Final Terminal Stopping Devices. Final terminal stopping devices, conforming to 2.25.3, shall be provided for every electric elevator.

2.26.2.12 Emergency Terminal Speed-Limiting Devices. Where reduced-stroke oil buffers are provided, as permitted by 2.22.4.1.2, emergency terminal speed-limiting devices conforming to 2.25.4.1 shall be provided.

2.26.2.13 Buffer Switches for Oil Buffers Used With Type C Car Safeties. Oil level and compression switches conforming to 2.17.8.2.7 and 2.17.8.2.8 shall be provided for all oil buffers used with Type C safeties (see 2.17.5.3).

2.26.2.14 Hoistway Door Interlocks and Hoistway Door Electric Contacts. Hoistway door interlocks or hoistway door electric contacts conforming to 2.12 shall be provided for all elevators.

2.26.2.15 Car Door and Gate Electric Contacts. Car door or gate electric contacts, conforming to 2.14.4.2, shall be provided for all elevators; except when car door interlock, conforming to 2.26.2.28 is provided.

2.26.2.16 Emergency Terminal Stopping Devices. Emergency terminal stopping devices conforming to 2.25.4.2 shall be provided for all elevators where static control is used, unless exempted by 2.25.4.2.

2.26.2.18 Car Top Emergency Exit Electrical Device. An electrical device conforming to 2.14.1.5.1(f) shall be provided on the car top emergency exit cover.

2.26.2.19 Motor-Generator Overspeed Protection. Means shall be provided to cause the electric power to be removed automatically from the elevator driving-machine motor and brake should a motor-generator set, driven by a DC motor, overspeed excessively.

2.26.2.20 Electric Contacts for Hinged Car Platform Sills. Hinged car platform sills, where provided, shall be equipped with electric contacts conforming to 2.15.16.

2.26.2.21 In-Car Stop Switch. On passenger elevators, a stop switch, either key operated or behind a locked cover, shall be provided in the car and located in or adjacent to the car operating panel. The key shall be Group 1 Security (see 8.1).

The switch shall be clearly and permanently marked "STOP" and shall indicate the "STOP" and "RUN" positions.

When opened ("STOP" position), this switch shall cause the electric power to be removed from the elevator driving-machine motor and brake.

2.26.2.22 Buffer Switches for Gas Spring-Return Oil Buffers. Buffer switches conforming to 2.22.4.5(c) shall be provided.

2.26.2.23 Stop Switch in Remote Machine and Control Rooms. A stop switch conforming to 2.26.2.5(a), (b), and (c) shall be provided in remote machine and control rooms where required by 2.7.8.

2.26.2.24 Stop Switch for Machinery Spaces and Control Spaces. A stop switch conforming to 2.26.2.5(a), (b), and (c) shall be provided where required by 2.7.3.5.

(13) **2.26.2.25 Blind Hoistway Emergency Door Electric Contact.** An electric contact conforming to 2.11.1.2(e) shall be provided on every emergency door in a blind hoistway.

2.26.2.26 Pit Access Door Electric Contact. An electric contact shall be provided on each pit access door where required by 2.2.4.5.

2.26.2.27 Stop Switch in Remote Counterweight Hoistways. A stop switch conforming to 2.26.2.5(a), (b), and (c) shall be provided in the remote counterweight hoistway where required by 2.3.3.3.

2.26.2.28 Car Door Interlock. An interlock conforming to 2.14.4.2 shall be provided where required by 2.14.4.2.1.

2.26.2.29 Ascending Car Overspeed Protection Device. An overspeed device shall be provided when required by 2.19.1 and shall meet the requirements of 2.19.1.2(a).

2.26.2.30 Unintended Car Movement Device. An unintended car movement device shall be provided when required by 2.19.2 and shall meet the requirements of 2.19.2.2(a). Where generator-field control is used, this electrical protective device shall also cause the power to be removed from the drive motor of the motor-generator set.

2.26.2.31 Car Access Panel Locking Device. A locking device conforming to 2.14.2.6 shall be provided where required by 2.14.2.6(e).

2.26.2.32 Hoistway Access Opening Locking Device. Access openings in the hoistway shall be provided with a locking device where required by 2.11.1.4.

2.26.2.33 Firefighters' Stop Switch. Where required by 2.27.3.3.1(m), a firefighters' stop switch shall

(a) be of the manually opened and closed type

(b) have red operating handles or buttons

(c) be conspicuously and permanently marked "STOP," and shall indicate the "STOP" and "RUN" positions

(d) be of a toggle or push-to-stop configuration

2.26.2.34 Unexpected Car Movement Device. An unexpected car movement device shall be provided where required by 2.7.5.1.2(c). This requirement shall be permitted to be satisfied by another device specified in 2.26.2, provided that the means required by 2.7.5.1.1 actuates the electrical device.

2.26.2.35 Equipment Access Panel Electrical Device. An electric contact on equipment access panels in the car shall be provided where required by 2.7.5.1.4 or 2.14.2.2(g).

2.26.2.36 Working Platform Electrical Device. An electric contact conforming to 2.14.4.2.3(b), (c), and (e) shall be provided where required by 2.7.5.3.1.

2.26.2.37 Retractable Stop Electrical Device. An electric contact conforming to 2.14.4.2.3(b), (c), and (e) shall be provided where required by 2.7.5.5(a).

2.26.2.38 Retractable Ladder Electrical Device. An electrical contact conforming to the following shall be provided where required by 2.2.4.2.7:

(a) be positively opened by a device attached to and operated by the ladder

(b) not utilize mercury tube switches

2.26.2.39 Sway Control Guide Slack Suspension Detection Means. An electrical device conforming to the following shall be provided where required by 2.30.2(d):

(a) It shall operate whenever any of the suspension members of the sway control guide become slack.

(b) It shall be of the manually reset type.

2.26.3 Contactors and Relays for Use in Critical Operating Circuits

Where electromechanical contactors or relays are provided to fulfill the requirements of 2.26.8.2, and 2.26.9.3 through 2.26.9.7, they shall be considered to be used in critical operating circuits. If contact(s) on these electromechanical contactors or relays are used for monitoring purposes, they shall be prevented from changing state if the contact(s) utilized in a critical operating circuit fail to open in the intended manner. The ability of the monitoring contact(s) to perform this function shall not be solely dependent upon springs.

2.26.4 Electrical Equipment and Wiring

2.26.4.1 All electrical equipment and wiring shall conform to NFPA 70 or CSA-C22.1, whichever is applicable (see Part 9).

2.26.4.2 Electrical equipment shall be listed/certified and labeled/marked. CSA B44.1/ASME A17.5 defines the scope and applicable requirements for this listing/certification.

2.26.4.3 The devices covered by 2.26.2 shall meet the requirements of either 2.26.4.3.1 or 2.26.4.3.2.

(13) **2.26.4.3.1** They shall have contacts that are positively opened mechanically; their opening shall not be solely dependent on springs. Exceptions are devices described by 2.26.2.4, 2.26.2.19, 2.26.2.29, and 2.26.2.30; and 2.26.2.12 and 2.26.2.16 where magnetically operated, optical, or solid-state devices are used.

(13) **2.26.4.3.2** They shall be listed/certified to a SIL rating in accordance with the applicable requirements of IEC 61508-2 and IEC 61508-3 with a SIL rating equal to or greater than the SIL indicated for the applicable device shown in Table 2.26.4.3.2. They shall be labeled/marked with part identification. Wiring diagrams (see 8.6.1.6.3) shall include part identification, SIL, and certification information that shall be in accordance with the certifying organization's requirements.

Assemblies containing SIL rated devices shall be labeled or tagged with the statement: "Assembly contains SIL rated devices. Refer to Maintenance Control Program and wiring diagrams prior to performing work."

The detection of a dangerous fault (e.g., with diagnostic tests, proof-tests, or by any other means) in SIL rated devices that can tolerate a single fault shall cause the elevator to revert to a known fail-safe condition. Where necessary, to maintain the integrity of the SIL rated devices and maintain the fail-safe condition prior to a second fault that could lead to a dangerous condition, a manual reset shall be required to remove the SIL rated devices from the fail-safe condition.

(13) **2.26.4.4** Control equipment shall be tested in accordance with the testing requirements of ISO 22200:2009. Control equipment tested in accordance with the testing requirements of EN 12016:1998 prior to one year after the effective date of the 2013 Edition of this Code need not be retested in accordance with the testing requirements of ISO 22200:2009.

The control equipment shall be exposed to interference levels at the test values specified for "safety circuits." The interference shall not cause any of the conditions described in 2.26.9.3.1(a) through (e) or render the traction-loss detection means ineffective, and shall not cause the car to move while on inspection operation.

(ED) **2.26.4.4.1** The test for voltage dips in Table 6 of EN 12016:1998 shall be permitted to be conducted by either using the times specified in Table 6, or using a voltage reduction of 30% of the nominal input voltage for 0.5 cycles at 60 Hz and a voltage reduction of 60% of nominal input voltage for 5 cycles at 60 Hz.

NOTE: The test requirements for voltage dips in 2.26.4.4.1 are adjusted for 60 Hz operation.

2.26.4.4.2 If enclosure doors or suppression equipment must remain installed to meet the above requirements, warning signs to that effect shall be posted on the control equipment.

2.26.4.5 In jurisdictions enforcing CSA-C22.1, power supply line disconnecting means, shall not be opened automatically by a fire alarm system.

2.26.5 System to Monitor and Prevent Automatic Operation of the Elevator With Faulty Door Contact Circuits

Means shall be provided to monitor the position of power-operated car doors that are mechanically coupled with the landing doors while the car is in the landing zone, in order

(a) to prevent automatic operation of the car if the car door is not closed (see 2.14.4.11), regardless whether the portion of the circuits incorporating the car door contact or the interlock contact of the landing door coupled with the car door, or both, are closed or open, except as permitted in 2.26.1.6

(b) to prevent the power closing of the doors during automatic operation if the car door is fully open and any of the following conditions exist:

(1) the car door contact is closed or the portion of the circuit, incorporating this contact is bypassed

(2) the interlock contact of the landing door that is coupled to the opened car door is closed or the portion of the circuit, incorporating this contact is bypassed

(3) the car door contact and the interlock contact of the door that is coupled to the opened car door are closed, or the portions of the circuits incorporating these contacts are bypassed

2.26.6 Phase Protection of Motors

Elevators having a polyphase AC power supply shall be provided with means to prevent the starting of the elevator drive motor or door motor if a reversal of phase rotation, or phase failure of the incoming polyphase AC power, will cause the elevator car or elevator door(s) to operate in the wrong direction.

2.26.7 Installation of Capacitors or Other Devices to Make Electrical Protective Devices Ineffective

The installation of capacitors or other devices, the operation or failure of which will cause an unsafe operation of the elevator, is prohibited.

No permanent device that will make the traction-loss detection means or any required electrical protective device ineffective shall be installed except as provided in 2.7.6.5.2(h), 2.12.7.1, 2.26.1.4.2(g), 2.26.1.5, 2.26.1.6, and 2.27.3.1.6(c) (see 8.6.1.6.1).

(13) **Table 2.26.4.3.2 SIL for Electrical Protective Devices and Other Electrical Safety Functions**
(ED)

| Requirement | Device Name | Safety Function | SIL |
|---------------|---|--|--------------------------------|
| 2.12.7.2.3 | Hoistway access switches | Check hoistway access operation | 3 |
| 2.26.1.4.1(b) | Inspection transfer switch | Check on enable of inspection operation | 3 |
| 2.26.1.5 | Bypass switches | Check bypass device for bypassing landing and car door device(s) | 3 |
| 2.26.1.6 | Car leveling or truck zoning device | Check on leveling (re-leveling) with car and hoistway doors not in the closed position | 2 |
| 2.26.2.1 | Slack-rope switch | Check the tension of winding drum machine ropes | 2 |
| 2.26.2.2 | Motor-generator running switch | Check that the motor generator is switched for the running condition | 1 |
| 2.26.2.3 | Compensating-rope sheave switch | Check the position limits of compensating-rope sheave | 2 |
| 2.26.2.4 | Motor field sensing means | Check for current flow in the motor shunt field | 1 |
| 2.26.2.5 | Emergency stop switch | Check that the stop switch is actuated | 3 |
| 2.26.2.6 | Broken rope, tape, or chain switches | Check for a failure of a rope, tape, or chain | 2 |
| 2.26.2.7 | Stop switch in pit | Check that the stop switch is actuated | 3 |
| 2.26.2.8 | Stop switch on top of car | Check that the stop switch is actuated | 3 |
| 2.26.2.9 | Car safety mechanism switch | Check on the operation of the car safety mechanism | 1 |
| 2.26.2.10 | Speed-governor overspeed switch | Check on overspeed | 2 |
| 2.26.2.11 | Final terminal stopping devices | Check that the car has passed a terminal landing | 1 |
| 2.26.2.12 | Emergency terminal speed-limiting devices | Check on retardation in the case of reduced stroke buffers | 2 |
| 2.26.2.13 | Buffer switches for oil buffers used with Type C car safeties | Check on the return to normal. Extended position of buffer. | 1 |
| 2.26.2.14 | Hoistway door interlocks and hoistway door electric contacts | Check on locked and/or closed position of landing doors | 3 |
| 2.26.2.15 | Car door and gate electric contacts | Check on closed position of car door [Note (2)] | 3 |
| 2.26.2.16 | Emergency terminal stopping devices | Check on stopping at terminal landings | 1 |
| 2.26.2.18 | Car top emergency exit electrical device | Check on the closed position of the car top exit | 2 |
| 2.26.2.19 | Motor-generator overspeed protection | Check on overspeed of DC driven motor generator sets | 1 |
| 2.26.2.20 | Electric contacts for hinged car platform sills | Check on the retracted position of car platform sill. Obsolete technology. | SIL rated device not permitted |
| 2.26.2.21 | In-car stop switch | Check that the stop switch is actuated | 3 |
| 2.26.2.22 | Buffer switches for gas spring-return oil buffers | Check on the return to normal extended position of buffer | 3 |
| 2.26.2.23 | Stop switch in remote machine and control rooms | Check that the stop switch is actuated | 3 |
| 2.26.2.24 | Stop switch for machinery spaces and control spaces | Check that the stop switch is actuated | 3 |
| 2.26.2.25 | Blind hoistway emergency door electronic contact | Check on the closed position of blind hoistway door | 2 |
| 2.26.2.26 | Pit access door electric contact | Check on the closed position of pit access doors | 2 |

Table 2.26.4.3.2 SIL for Electrical Protective Devices and Other Electrical Safety Functions (Cont'd)

| Requirement | Device Name | Safety Function | SIL |
|-------------|--|--|---|
| 2.26.2.27 | Stop switch in remote counter-weight hoistways | Check that the stop switch is actuated | 3 |
| 2.26.2.28 | Car door interlock | Check on locking and closed position of car doors | 3 |
| 2.26.2.29 | Ascending car overspeed protection device | Check on the ascending car overspeed protection means | 2 |
| 2.26.2.30 | Unintended car movement device | Check on unintended car movement with doors open | 2 |
| 2.26.2.31 | Car access panel locking device | Check on locked position of car access panel | SIL rated device not permitted [see Note (1)] |
| 2.26.2.32 | Hoistway access opening locking device | Check on locked position of hoistway access openings | SIL rated device not permitted [see Note (1)] |
| 2.26.2.33 | Firefighters' stop switch | Check that the stop switch is actuated | 3 |
| 2.26.2.34 | Unexpected car movement device | Check on actuation of unexpected car movement means | 3 |
| 2.26.2.35 | In-car equipment access panel device | Check on closed position of access panel in the car | 2 |
| 2.26.2.36 | Working platform electrical device | Check on fully retracted position of working platform | 4 |
| 2.26.2.37 | Retractable stop electrical device | Check on fully retracted position of retractable stops | 2 |
| 2.26.2.39 | Sway control guide electrical device | Check for slack suspension on guide | 2 |

GENERAL NOTES:

- (a) For the purpose of this Standard, the SIL represents the requirement for a device operating in the low demand mode and the probability of failure to perform its safety function on demand (see CEI IEC 61508-1, Table 2). However, where the device is used for continuous control to maintain functional safety, for example when the use of a stop switch solely prevents an elevator controller from operating in automatic operation, the SIL shall represent the requirement for a device considered operating in the high demand mode and the dangerous failure rate of the device (see CEI IEC 61508-1, Table 3 and definition).
- (b) For the purposes of this Standard, SIL refers to SIL rating of a E/E/PES to the applicable requirements of CEI IEC 61508-2 and CEI IEC 61508-3.
- (c) The SIL values specified in Table 2.26.4.3.2 are based on a proof-test frequency of no more than half the rate of demand on the safety function. The inspection frequencies provided in Nonmandatory Appendix N serve as a reference to this proof-test interval and are addressed in the Maintenance Control Program. See requirement 8.6.1.4.1(a).
- (d) It is possible to use several lower safety integrity level systems to satisfy the need for a higher safety integrity level function provided that the implementation is certified.
- (e) The summary of functions described in the "Safety Function" column are for reference only. The referenced Code item in the "Requirement" column must be used to determine the safety function of the item in the "Device Name" column.

NOTES:

- (1) A device rated SIL 4 or less cannot fulfill this function.
- (2) For the application of a SIL 3 ELECTRICAL/ELECTRONIC/PROGRAMMABLE ELECTRONIC SYSTEMS device for freights and cars with swing hoistway doors, an independent monitoring of the closed car door gate position by the elevator control is required to prevent the car from moving if the car/gate door is open.

2.26.8 Release and Application of Driving-Machine Brakes

2.26.8.1 Driving-machine brakes shall not be electrically released until power has been applied to the driving-machine motor except as permitted by 2.7.6.4.3.

- (13) **2.26.8.2** Two means shall be provided to independently remove power from the brake. The electrical protective devices required by 2.26.2 shall control both means, except that leveling shall be permitted to take place with power opening of doors and gates in conformance with 2.13.2.1.1 and 2.13.2.2.1.

One of the means shall be either a contactor, or SIL rated device(s) with a SIL of not less than the highest SIL of the function for the electrical protective devices involved with removing power from the brake and shall be listed/certified in accordance with the applicable requirements of IEC 61508-2 and IEC 61508-3. SIL rated devices shall be identifiable on wiring diagrams (see 8.6.1.6.3) with part identification, SIL, and certification identification information that shall be in accordance with the certifying organization's requirements. This means is not required to remove power from the driving-machine motor.

If the brake circuit is ungrounded, power shall be interrupted at all power feed lines to the brake.

Assemblies containing SIL rated devices shall be labeled or tagged with the statement: "Assembly contains SIL rated devices. Refer to the Maintenance Control Program and wiring diagrams prior to performing work."

2.26.8.3 The driving-machine brake shall apply automatically when

- (a) the operating device of a car switch or continuous-pressure-operation elevator is in the stop position
- (b) a normal stopping means functions
- (c) any electrical protective device is activated
- (d) there is a loss of power to the driving-machine brake
- (e) the traction-loss detection means is actuated [see 2.20.8.1(c)]

2.26.8.4 The application of the brake shall be permitted to occur on or before the completion of the slow-down and leveling operations, under conditions described in 2.26.8.3(a) and (b).

2.26.8.5 The brake shall not be permanently connected across the armature or field of a direct-current elevator driving-machine motor.

2.26.9 Control and Operating Circuits

The design and installation of the control and operating circuits shall conform to 2.26.9.1 through 2.26.9.8.

2.26.9.1 If springs are used to actuate switches, contactors, or relays to break the circuit to stop an elevator at the terminal landings, they shall be of the compression type.

2.26.9.2 The completion or maintenance of an electric circuit shall not be used to interrupt the power to the elevator driving-machine motor or brake at the terminal landings, nor to stop the car when any of the electrical protective devices (see 2.26.2) operate. Requirement 2.26.9.2 does not apply to dynamic braking, nor to speed control switches.

2.26.9.3 Protection Against Failures

2.26.9.3.1 The occurrence of a single ground or the failure of any single magnetically operated switch, contactor, or relay, or any single device that limits the leveling or truck zone, or any single solid-state device not a part of a software system; or a failure of a software system in circuits not in conformance with 2.26.9.3.2(b), shall not (ED)

(a) render any electrical protective device ineffective (see 2.26.2)

(b) permit the car to move beyond the leveling or truck zone if any hoistway-door interlock is unlocked or if any hoistway door or car door or gate electric contact is not in the closed position (see 2.26.1.6)

(c) permit speeds in excess of those specified in 2.12.7.3.3(b), 2.26.1.4.1(d)(1), and 2.26.1.6.6

(d) permit the car to revert to normal operation when the electrical contact required by 2.7.5.2.1(b)(3) is in the open position, or the electrical device as permitted in 2.7.5.5(b) is activated, or on hoistway access switch operation (see 2.12.7.3), or on inspection operation (see 2.26.1.4), or on bypass operation (see 2.26.1.5)

(e) render ineffective any hoistway-door or car door interlock, or car door or gate electric contact, or hoistway door combination mechanical lock and electric contact when either a hoistway access switch (see 2.12.7.3) or a "BYPASS" switch (see 2.26.1.5) is in the "OFF" position.

2.26.9.3.2 Methods used to satisfy 2.26.9.3.1 using software systems are permitted, provided that (13)

(a) a non-software-controlled means is also used to remove power from the driving-machine motor and brake, or

(b) the software system and related circuits are listed/certified to a SIL rating that is in accordance with the applicable requirements of IEC 61508-2 and IEC 61508-3. This software system and its related circuits shall have a SIL of not less than the highest SIL value of the safety function(s) in Table 2.26.4.3.2 used in the circuit. The software system and related circuits shall be identifiable on wiring diagrams (see 8.6.1.6.3) with part identification, SIL, and certification identification information that shall be in accordance with the certifying organization's requirements.

Assemblies containing SIL rated devices shall be labeled or tagged with the statement: "Assembly contains SIL rated devices. Refer to Maintenance Control Program and wiring diagrams prior to performing work."

2.26.9.4 Methods used to satisfy 2.26.9.3 shall be checked prior to each start of the elevator from a landing, when on automatic operation. When a single ground or failure as specified in 2.26.9.3 occurs, the car shall not be permitted to restart.

2.26.9.5 Except for elevators employing alternating-current hoist motors driven from a direct-current source through a static inverter (see 2.26.9.6), elevators with driving motors employing static control without motor-generator sets shall conform to 2.26.9.5.1 through 2.26.9.5.4.

(13) **2.26.9.5.1** Two means shall be provided to remove power independently from the driving-machine motor. At least one shall conform to either 2.26.9.5.1(a) or 2.26.9.5.1(b).

(a) An electromechanical contactor arranged to

(1) open each time the car stops, or

(2) open, at the latest, each time the car reverses direction, except for releveling, and it has been verified at each stop that there is no current flow exceeding normal leakage current through the other means

(b) An E/E/PES, with a SIL of not less than the highest SIL value of the applicable function as shown in Table 2.26.4.3.2 for the electrical protective devices involved and shall be listed/certified to a SIL rating that is in accordance with the applicable requirements of IEC 61508-2 and IEC 61508-3. It shall be identifiable on wiring diagrams (see 8.6.1.6.3) with part identification, SIL, and certification identification information that shall be in accordance with the certifying organization's requirements.

Assemblies containing SIL rated devices shall be labeled or tagged with the statement: "Assembly contains SIL rated devices. Refer to Maintenance Control Program and wiring diagrams prior to performing work."

2.26.9.5.2 The means used for conformance to 2.26.9.5.1 shall cause power to be removed from the driving-machine brake.

2.26.9.5.3 The electrical protective devices required by 2.26.2 and the traction-loss detection means required by 2.20.8.1 shall control both means, except that leveling shall be permitted to take place with power opening of doors and gates in conformance with 2.13.2.1.1 and 2.13.2.2.1.

2.26.9.5.4 Where contactors are used to satisfy 2.26.9.5.1 or 2.26.8.2, after each time the contactor is required to open in conformance with 2.26.9.5.1(a) or

2.26.9.5.2, the car shall not respond to a signal to start unless the contactor(s) is in the de-energized position. After each stop in conformance with 2.26.9.5.1(a)(2), the car shall not respond to a signal to start if current flow exceeding normal leakage current through the other means is detected.

2.26.9.6 Elevators employing alternating-current driving motors driven from a direct-current power source through a static inverter shall conform to 2.26.9.6.1 through 2.26.9.6.4.

2.26.9.6.1 Two separate means shall be provided to independently inhibit the flow of alternating current through the solid-state devices that connect the direct-current power source to the alternating-current driving motor. At least one of the means shall conform to either 2.26.9.6.1(a) or 2.26.9.6.1(b).

(a) An electromechanical relay arranged to

(1) open each time the car stops, or

(2) open, at the latest, each time the car reverses direction, except for releveling, and it has been verified at each stop that there is no current flow exceeding normal leakage current through the other means

(b) An E/E/PES, with a SIL of not less than the highest SIL value of the applicable function as shown in Table 2.26.4.3.2 for the electrical protective devices involved and shall be listed/certified to a SIL rating that is in accordance with the applicable requirements of IEC 61508-2 and IEC 61508-3. It shall be identifiable on wiring diagrams (see 8.6.1.6.3) with part identification, SIL, and certification identification information that shall be in accordance with the certifying organization's requirements.

Assemblies containing SIL rated devices shall be labeled or tagged with the statement: "Assembly contains SIL rated devices. Refer to Maintenance Control Program and wiring diagrams prior to performing work."

2.26.9.6.2 The means used for conformance to 2.26.9.6.1(a) or 2.26.9.6.1(b) shall cause power to be removed from the driving-machine brake circuit.

2.26.9.6.3 The electrical protective devices required by 2.26.2 and the traction-loss detection means required by 2.20.8.1 shall control both means that inhibit the flow of alternating current through the solid-state devices, except that leveling shall be permitted to take place with power opening of the doors and gates as restricted by 2.13.2.1.1 and 2.13.2.2.1.

2.26.9.6.4 Where relays are used to satisfy 2.26.9.6.1(a) and contactors are used to satisfy 2.26.8.2, after each time the relay is required to open in conformance to 2.26.9.6.1(a) or the contactor is required to open in conformance to 2.26.9.6.2, the car shall not respond to a signal to start unless the relay that inhibits the flow of alternating current through the solid-state devices, as

well as the contactors in the brake circuit, are in the de-energized position. After each stop in conformance to 2.26.9.6.1(a)(2), the car shall not respond to a signal to start if current flow exceeding normal leakage current through the other means is detected.

2.26.9.7 Where generator-field control is used, means shall be provided to prevent the generator from building up and applying sufficient current to the elevator driving-machine motor to move the car when the elevator motor control switches are in the "OFF" position. The means used shall not interfere with maintenance of an effective dynamic-braking circuit during stopping and standstill conditions.

2.26.9.8 The control circuits shall be so designed and installed that the car speed in the down direction with rated load in the car, under normal operating conditions with the power supply on or off, shall not exceed governor tripping speed, or 125% of rated speed, whichever is the lesser (see also 2.16.8).

2.26.10 Absorption of Regenerated Power

When a power source is used that, in itself, is incapable of absorbing the energy generated by an overhauling load, means for absorbing sufficient energy to prevent the elevator from attaining governor tripping speed or a speed in excess of 125% of rated speed, whichever is less, shall be provided on the load side of each elevator power supply line disconnecting means (see 2.16.8).

2.26.11 Car Platform to Hoistway Door Sills Vertical Distance

Where ANSI/ICC A117.1 or ADAAG is not applicable, the vertical distance between the car platform sill and the hoistway door sill on passenger elevators shall be in accordance with the following:

- (a) it shall not exceed 13 mm (0.5 in.) on initial stop at a landing
- (b) the car shall relevel if the vertical distance exceeds 25 mm (1 in.) while loading or unloading

2.26.12 Symbols

2.26.12.1 Where reference is made requiring wording to designate a specific function, the symbols as shown in Table 2.26.12.1 shall be substituted for, or used in conjunction with, the required wording.

2.26.12.2 The emergency stop switch shall have the "STOP" and "RUN" positions conspicuously and permanently marked as required by 2.26.2.5(c).

2.26.12.3 Where Braille is provided it shall conform to the requirements in Table 2.26.12.1.

NOTE (2.26.12): See also ANSI/ICC A117.1, ADAAG, and B44 Appendix E.

SECTION 2.27 EMERGENCY OPERATION AND SIGNALING DEVICES

NOTE (2.27): Additional requirements, including those for fire-fighters' communications systems, may be found in the building code.

2.27.1 Car Emergency Signaling Devices

2.27.1.1 Emergency Communications

2.27.1.1.1 A two-way communications means between the car and a location staffed by authorized personnel shall be provided.

2.27.1.1.2

(a) Two-way communications shall be directed to a location(s) staffed by authorized personnel who can take appropriate action.

(b) If the call is not acknowledged [2.27.1.1.3(c)] within 45 s, the call shall be automatically directed to an alternate on- or off-site location.

2.27.1.1.3 The two-way communication means within the car shall comply with the following requirements: **(13)**
(ED)

(a) In jurisdictions enforcing NBCC, Appendix E of ASME A17.1/CSA B44, or in jurisdictions not enforcing NBCC, ICC/ANSI A117.1.

(b) A push button to actuate the two-way communication means shall be provided in or adjacent to a car operating panel. The push button shall be visible and permanently identified with the "PHONE" symbol (see 2.26.12.1). The identification shall be on or adjacent to the "PHONE" push button. When the push button is actuated, the emergency two-way communication means shall initiate a call for help and establish two-way communications.











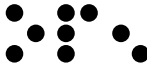
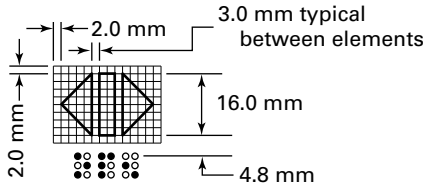

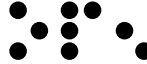
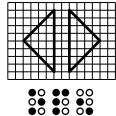

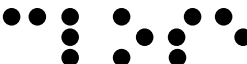
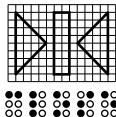
(c) A visual indication on the same panel as the "PHONE" push button shall be provided, that is activated by authorized personnel, to acknowledge that two-way communications link has been established. The visual indication shall be extinguished when the two-way communication link is terminated.

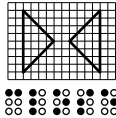
(d) The two-way communication means shall provide on demand to authorized personnel, information that identifies the building location and elevator number and that assistance is required.

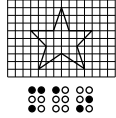
(e) After the call acknowledgement signals are sent [2.27.1.1.3(c)], the two-way voice communications shall be available between the car and authorized personnel.

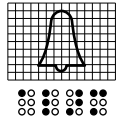
(f) The two-way communications, once established, shall be disconnected only when authorized personnel outside the car terminate the call or a timed termination occurs. A timed termination by the two-way communication means in the elevator, with the ability to extend the call by authorized personnel, is permitted if voice notification is sent a minimum of 3 min after communication has been established. Upon notification, authorized personnel shall have the ability to extend the call;

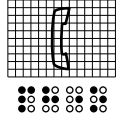
Table 2.26.12.1 Symbol Identification

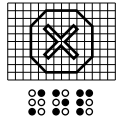
| Function | Tactile Symbol | Braille Message Where Provided | Proportions (Open Circles Indicate Unused Dots Within Each Braille Cell) |
|----------------------|---|---|---|
| Door Open |  |  OP"EN" |  |
| Rear/Side Door Open |  |  REAR/SIDE OP"EN" |  |
| Door Close |  |  CLOSE |  |
| Rear/Side Door Close |  |  REAR/SIDE CLOSE |  |
| Main |  |  MA"IN" |  |
| Alarm |  |  AL"AR"M |  |
| Phone |  |  PH"ONE" |  |
| Emergency Stop |  |  "ST"OP |  |

automatic disconnection shall be permitted if the means to extend are not enacted within 20 s of the voice notification.

(g) The two-way communication means shall not use a handset in the car.

(h) The two-way communications shall not be transmitted to an automated answering system. The call for help shall be answered by authorized personnel.

(i) Operating instructions shall be incorporated with or adjacent to the "PHONE" push button.

- (13) **2.27.1.1.4** Where the elevator rise is 18 m (60 ft) or more, a two-way voice communication means within the building accessible to emergency personnel shall be provided and comply with the following requirements:

(a) The means shall enable emergency personnel within the building to establish two-way voice communications to each car individually. Two-way voice communication shall be established without any intentional delay and shall not require intervention by a person within the car. The means shall override communications to outside of the building.

(b) Two-way voice communications, once established, shall be disconnected only when emergency personnel outside the car terminates the call or a timed termination occurs. A timed termination by the two-way communication means in the elevator, with the ability to extend the call by authorized personnel, is permitted if voice notification is sent a minimum of 3 min after communication has been established. Upon notification, authorized personnel shall have the ability to extend the call; automatic disconnection shall be permitted if the means to extend are not enacted within 20 s of the voice notification.

(c) Once the two-way voice communication has been established, the visual indication [see 2.27.1.1.3(c)] within the car shall illuminate. The visual indication shall be extinguished when the two-way communication is terminated.

(d) Operating instructions shall be incorporated with or adjacent to the two-way voice communication outside the car. Instructions shall conform to 2.27.7.3.

2.27.1.1.5 If the two-way communications means is normally connected to the building power supply, it shall automatically transfer to a source of standby or emergency power as required by the applicable building code or, where applicable, Standard for Health Care Facilities (ANSI/NFPA-99), after the normal power supply fails. The power source shall be capable of providing for illumination of the visual indication [see 2.27.1.1.3(c)] within the car, and the means of two-way communications for at least 4 h; and the audible signaling device (see 2.27.1.2) for at least 1 h.

- (13) **2.27.1.1.6**

(a) The two-way communications means within the car shall include a means to verify operability of the telephone line, where

(1) verification of the telephone line operability shall be automatically performed

(2) verification may be continuous or periodic

(3) periodic verification shall be at least on a daily basis

(4) verification shall not require activation of the two-way communications link(s)

If means other than a telephone line (e.g., VOIP, network, intercom, etc.) is used for the two-way communications, similar verification of this equivalent means shall be performed.

(b) If the verification means in 2.27.1.1.6(a) determines that the telephone line or equivalent means is not functional, an audible and illuminated visual signal shall be activated. A minimum of one visual and one audible signal shall be provided for each group of elevators controlled by a "FIRE RECALL" switch.

(1) The visual signal shall

(a) be located at the designated landing in the vicinity of the "FIRE RECALL" switch and visible to elevator user(s)

(b) be labeled "ELEVATOR COMMUNICATIONS FAILURE" in red letters a minimum of 5 mm (0.25 in.) high

(c) illuminate intermittently

(d) continue illuminating intermittently until the telephone line or equivalent means is functional

(2) The audible signal shall

(a) be 10 dBA minimum above ambient, but shall not exceed 80 dBA measured at the designated landing "FIRE RECALL" switch

(b) sound at least once every 30 s with a minimum duration of half a second

(c) continue to sound until silenced by authorized personnel or the telephone line or equivalent means is functional

(3) A means to silence the audible signal shall be provided and shall be accessible only to authorized personnel. The signal when silenced shall remain silent for a period of no less than 12 hr or until activated by the next failed periodic verification [see 2.27.1.1.6(a)(3)].

(4) The verification means in 2.27.1.1.6(a) shall continue to monitor the operability of the telephone line or equivalent means while the telephone line or equivalent means is not functional on a continuous basis or periodically with intervals of not more than 5 min.

When the verification determines that the operability of the telephone line or equivalent means has been restored after being nonfunctional, the audible signal shall be silenced unless the signal has already been silenced in accordance with 2.27.1.1.6(b)(3) and the illuminated visual signal shall be extinguished.

2.27.1.2 Emergency Stop Switch Audible Signal.

When an emergency stop switch (2.26.2.5) is provided,

an audible signaling device shall be provided. The audible signaling device shall

(a) have a rated sound pressure rating of not less than 80 dBA nor greater than 90 dBA at 3 m (10 ft)

(b) respond without delay after the switch has been activated

(c) be located inside the building and audible inside the car and outside the hoistway

(d) for elevators with a rise greater than 30 m (100 ft), be duplicated as follows:

(1) one device shall be mounted on the car

(2) a second device shall be placed at the designated level

2.27.2 Emergency or Standby Power System

Elevators provided with an emergency or standby power system to operate the elevator in case the normal power supply fails shall comply with the requirements of 2.27.2.1 through 2.27.2.5.

NOTE (2.27.2): Requirements for emergency or standby power systems are addressed in the building code. Requirements for health care facilities are addressed in NFPA 99 and NFPA 70, Article 517.

2.27.2.1 The emergency or standby power system shall be capable of operating the elevator(s) with rated load (see 2.16.8), at least one at a time, unless otherwise required by the building code.

2.27.2.2 The transfer between the normal and the emergency or standby power system shall be automatic.

(13) **2.27.2.3** An illuminated signal(s) marked "ELEVATOR EMERGENCY POWER" shall be provided in the elevator lobby at the designated level for each group of elevators or for any single elevator not in a group. The signal(s) shall indicate that the normal power supply has failed and the emergency or standby power is in effect for one or more of the cars in that group of elevators or that single elevator.

2.27.2.4 Where the emergency or standby power system is not capable of operating all elevators simultaneously, the elevators shall conform to requirements 2.27.2.4.1 through 2.27.2.4.6.

2.27.2.4.1 A selector switch(es) marked "ELEVATOR EMERGENCY POWER" in red lettering a minimum of 5 mm (0.25 in.) in height, that is key-operated or under a locked cover (see 2.27.8), shall be provided to permit the selection of the elevator(s) to operate on the emergency or standby power system. The key shall be Group 3 Security (see 8.1).

2.27.2.4.2 The selector switch(es) positions shall be marked to correspond with the elevator identification number (see 2.29) and a position marked "AUTO."

2.27.2.4.3 The selector switch(es) shall be located at the designated level in view of all elevator entrances,

or if located elsewhere means shall be provided adjacent to the selector switch(es) to indicate that the elevator is at the designated level with the doors in the normally open position.

2.27.2.4.4 An automatic means shall be provided (13) to select each elevator one or more at a time as follows:

(a) When selected, an elevator that is not on designated attendant operation, inspection operation, or Firefighters' Emergency Operation shall return to the designated level where power-operated doors at the landing where the illuminated signal (see 2.27.2.3) is located shall open and remain open. Where more than one entrance is provided at the designated level, the other doors are permitted to open. The selection shall then be automatically transferred to another elevator until all elevators have been selected.

(b) When selected, elevators on designated attendant operation, inspection operation (2.26.1.4), or Firefighters' Emergency Operation (2.27.3 through 2.27.7) shall operate in accordance with those requirements and shall remain selected until the car is stopped and the doors are open, except as specified in 2.27.2.4.4(c). For cars on Firefighters' Emergency Operation, the in-car visual signal [2.27.3.1.6(h) and 2.27.3.3.8] shall not activate until the car is selected.

(c) If any selected car does not move for more than 20 s to 30 s, the selection shall be transferred to another car, until all elevators have been selected.

(d) After all elevators have been selected, the process shall repeat for any cars that failed to move to give them a second opportunity.

2.27.2.4.5 After all cars have been recalled, moved to a floor, or failed to move after a second opportunity, one or more of the elevators, identified by the manual selection switch(es) (see 2.27.2.4.1), shall be selected to remain in operation. If no elevator(s) has been manually selected [switch(es) in "AUTO" position], it shall be permissible to automatically select the elevator(s) to remain in operation. Preference shall be given to cars on Hospital Service followed by cars on Firefighters' Phase II Emergency In-Car Operation.

The manual selection switch(es) shall not override the automatic power selection until

(a) the automatic return sequence is complete (see 2.27.2.4.4); or

(b) a "FIRE RECALL" switch is in the "ON" position (see 2.27.3.1).

Operation of the manual selection switch(es) shall not cause a car to be deselected until the elevator is stopped.

2.27.2.4.6 A visual means, located adjacent to the manual selector switches, shall be provided to indicate which elevator(s) is currently selected.

2.27.2.5 When the emergency or standby power system is designed to operate only one elevator at a

time, the energy absorption means (if required) shall be permitted to be located on the supply side of the elevator power disconnecting means, provided all other requirements of 2.26.10 are conformed to when operating any of the elevators the power might serve. Other building loads, such as power and lights that can be supplied by the emergency or standby power system, shall not be considered as a means of absorbing the regenerated energy for the purposes of conforming to 2.26.10, unless such loads are normally powered by the emergency or standby power system.

2.27.3 Firefighters' Emergency Operation: Automatic Elevators

Firefighters' Emergency Operation shall apply to all automatic elevators except where the hoistway or a portion thereof is not required to be fire-resistive construction (see 2.1.1.1), the rise does not exceed 2 000 mm (80 in.), and the hoistway does not penetrate a floor.

NOTE (2.27.3): When the structure (building, etc.) is located in a flood hazard area, the alternate and designated levels (see 8.12.1) should be above the base flood elevation.

2.27.3.1 Phase I Emergency Recall Operation

- (13) **2.27.3.1.1** A three-position key-operated switch that will not change position without a deliberate action by the user, shall be

(a) provided only at the designated level for each single elevator or for each group of elevators.

(b) labeled "FIRE RECALL" and its positions marked "RESET," "OFF," and "ON" (in that order), with the "OFF" position as the center position. The "FIRE RECALL" letters shall be a minimum of 5 mm (0.25 in.) high. Text shall be either red on a background that contrasts with red, or a color that contrasts with red on a red background.

(c) located in the lobby within sight of the elevator or all elevators in that group and shall be readily accessible.

- (13) **2.27.3.1.2** An additional key-operated "FIRE RECALL" switch, with two positions that will not change position without a deliberate action by the user, marked "OFF" and "ON" (in that order), shall be permitted only at the fire command center.

NOTE (2.27.3.1.2): In jurisdictions enforcing NBCC, the Fire Command Center (FCC) is known as the Central Alarm and Control Facility (CACF).

2.27.3.1.3 The switch(es) shall be rotated clockwise to go from the "RESET" (designated level switch only), to "OFF" to "ON" positions. Keys shall be removable only in the "OFF" and "ON" positions.

2.27.3.1.4 Only the "FIRE RECALL" switch(es) or fire alarm initiating device located at floors that are served by the elevator, or in the hoistway, or in an elevator machine room, or a control space, or a control room

(see 2.27.3.2) shall initiate Phase I Emergency Recall Operation.

2.27.3.1.5 All "FIRE RECALL" switches shall be provided with an illuminated visual signal to indicate when Phase I Emergency Recall Operation is in effect.

2.27.3.1.6 When a "FIRE RECALL" switch is in the "ON" position all cars controlled by the switch shall operate as follows: (13) (ED)

(a) A car traveling towards the designated level shall continue nonstop to the designated level and power-operated doors shall open and remain open. On cars with more than one entrance, if the doors for another entrance can be opened at the designated level, only the doors serving the lobby where the "FIRE RECALL" switch is located shall automatically open and remain open. Once at the designated level, all in-car door open button(s) shall be operative. Once the doors at an entrance other than the entrance serving the lobby where the "FIRE RECALL" switch is located, are opened by means of an in-car door open button, they shall initiate reclosing within 15 s of reaching the normal open position.

(b) A car traveling away from the designated level shall reverse at or before the next available landing without opening its doors and proceed to designated level.

(c) A stopped car shall have the in-car stop switch (see 2.26.2.21) and the emergency stop switch in the car (see 2.26.2.5) when provided, rendered inoperative as soon as the car moves away from the landing. A moving car shall have the in-car stop switch and the emergency stop switch in the car when provided, rendered inoperative without delay. Once the emergency stop switch in the car and the in-car stop switch have been rendered inoperative, they shall remain inoperative while the car is on Phase I Emergency Recall Operation. All other stop switches required by 2.26.2 shall remain operative.

(d) A car standing at a landing other than the designated level, with the doors open and the in-car stop switch and the emergency stop switch in the car when provided, in the run position, shall conform to the following:

(1) Elevators having automatic power-operated horizontally sliding doors shall close the doors without delay and proceed to the designated level.

(2) Elevators having power-operated vertically sliding doors provided with automatic or momentary pressure closing operation shall have the closing sequence initiated without delay in accordance with 2.13.3.4, and the car shall proceed to the designated level.

(3) Elevators having power-operated doors provided with continuous pressure closing operation (see 2.13.3.2), or elevators having manual doors, shall be provided with a visual and audible signal system [see 2.27.3.1.6(h)] to alert an operator to close the doors and

shall, when the doors are closed, proceed to the designated level. Sequence operation, if provided, shall remain effective.

(e) Door reopening devices for power-operated doors that are sensitive to smoke or flame shall be rendered inoperative without delay. Door reopening devices not sensitive to smoke or flame (e.g., mechanically actuated devices) are permitted to remain operative.

(1) Door closing for power-operated horizontally sliding doors shall conform to 2.13.5.

(2) Door closing for power-operated vertically sliding doors shall conform to 2.13.6.1.2 and shall have an average closing car door or gate speed not to exceed 0.20 m/s (0.67 ft/s).

(f) Floor selection means, lanterns, and indicators

(1) in the car

(a) floor selection means shall be rendered inoperative

(b) car call-registered lights and car lanterns, where provided, shall be extinguished and remain inoperative

(c) position indicators and car-direction indicators, where provided, shall remain operative

(2) at the fire command center

(a) position indicators and car-direction indicators, where provided, shall remain operative

(3) at the designated level

(a) hall call-registered lights and hall lanterns, where provided, shall be extinguished and remain inoperative

(b) position indicators and car-direction indicators, where provided, shall remain operative

(4) at all landings, except at the designated level

(a) hall call-registered lights and hall lanterns, where provided, shall be extinguished and remain inoperative

(b) position indicators and car-direction indicators, where provided, shall be extinguished and remain inoperative

(g) Where provided on elevators with vertically sliding doors, corridor door open and door close buttons shall remain operative.

(h) An illuminated visual and audible signal system shall be activated. The visual signal shall be one of the symbols shown in Fig. 2.27.3.1.6(h) and located on the car-operating panel. The entire circular or square area or the outline of the hat, or the outline of the area shown in Fig. 2.27.3.1.6(h) shall be illuminated. The visual signal shall remain activated until the car is restored to automatic operation. When the door is open, the audible signal shall remain active until the door is closed. When the door is closed, the audible signal shall remain active for a minimum of 5 s. The audible signal shall not be active when the car is at the recall level.

(i) A car stopped at a landing shall have the in-car door open button(s) rendered inoperative as soon as the

car moves away from the landing. The in-car door open button(s) shall remain inoperative when a car stops to reverse direction. Once the in-car door open button(s) has been rendered inoperative, it shall remain inoperative until the car has returned to the designated level.

(j) Where an additional "FIRE RECALL" switch is provided, both "FIRE RECALL" switches shall be in the "ON" position to recall the elevator to the designated level if the elevator was recalled to the alternate level (see 2.27.3.2.4).

(k) To remove the elevator(s) from Phase I Emergency Recall Operation, the "FIRE RECALL" switch shall be rotated first to the "RESET," and then to the "OFF" position, provided that

(1) the additional two-position "FIRE RECALL" switch, where provided, is in the "OFF" position

(2) no fire alarm initiating device is activated (see 2.27.3.2)

(l) Means used to remove elevators from normal operation shall not prevent Phase I Emergency Recall Operation, except

(1) as specified in this Code

(2) as controlled by elevator personnel

(m) No device, that measures load, shall prevent operation of the elevator at or below the capacity and loading required in 2.16.

(n) If the normal power supply, emergency power supply, and standby power supply are not available and the elevator is equipped with an alternate source of power that can move the car to a floor, but is insufficient to move the car to the recall level, the following requirements shall apply:

(1) The visual signal [2.27.3.1.6(h)] shall extinguish.

(2) A car that is not at a landing shall move to the closest landing it is capable of reaching.

(3) A car that has automatic power-operated horizontally sliding doors or power-operated vertically sliding doors provided with automatic closing operation and is stopped at a landing, shall open the doors, and then within 15 s, initiate reclosing.

(4) A car that is stopped at a landing shall have its door open button operative.

(5) A car stopped at a landing shall not move until normal power, emergency power, or standby power becomes available.

2.27.3.2 Phase I Emergency Recall Operation by Fire Alarm Initiating Devices

2.27.3.2.1 In jurisdictions not enforcing the NBCC, smoke detectors or other automatic fire detectors in environments not suitable for smoke detectors (fire alarm initiating devices) used to initiate Phase I Emergency Recall Operation shall be installed in conformance with the requirements of NFPA 72, and shall be located

(a) at each elevator lobby served by the elevator

(13)
(ED)

Fig. 2.27.3.1.6(h) Visual Signal

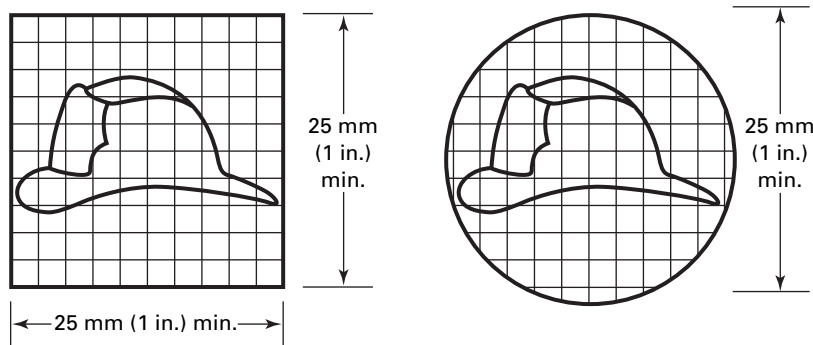

(b) in the associated elevator machine room, machinery space containing a motor controller or driving machine, control space, or control room

(c) in the elevator hoistway, when sprinklers are located in those hoistways

(13) **2.27.3.2.2** In jurisdictions enforcing the NBCC, smoke detectors, or heat detectors in environments not suitable for smoke detectors (fire alarm initiating devices), used to initiate Phase I Emergency Recall Operation, shall be installed in conformance with the requirements of the NBCC, and shall be located

(a) at each elevator lobby served by the elevator

(b) in the associated elevator machine room, machinery space containing a motor controller or driving machine, control space, or control room

(c) in the elevator hoistway, when sprinklers are located in those hoistways

NOTE (2.27.3.2.2): Smoke and heat detectors (fire alarm initiating devices) are referred to as fire detectors in the NBCC. Pull stations are not deemed to be fire detectors.

(ED) **2.27.3.2.3** Phase I Emergency Recall Operation to the designated level shall conform to the following:

(a) The activation of a fire alarm initiating device specified in 2.27.3.2.1(a) or 2.27.3.2.2(a) at any floor, other than at the designated level, shall cause all elevators that serve that floor, and any associated elevator of a group automatic operation, to be returned nonstop to the designated level.

(b) The activation of a fire alarm initiating device specified in 2.27.3.2.1(b) or 2.27.3.2.2(b) shall cause all elevators having any equipment located in that room or space, and any associated elevators of a group automatic operation, to be returned nonstop to the designated level. If the machine room is located at the designated level, the elevator(s) shall be returned nonstop to the alternate level.

(c) In jurisdictions not enforcing NBCC, the activation of a fire alarm initiating device specified in 2.27.3.2.1(c) shall cause all elevators having any equipment in that

hoistway, and any associated elevators of a group automatic operation, to be returned nonstop to the designated level, except that initiating device(s) installed at or below the lowest landing of recall shall cause the car to be sent to the upper recall level.

(d) In jurisdictions enforcing the NBCC, the initiation of a fire detector in the hoistway shall cause all elevators having any equipment in that hoistway, and any associated elevators of a group automatic operation, to be returned nonstop to the designated level, except that initiating device(s) installed at or below the lowest landing of recall shall cause the car to be sent to the upper recall level.

(e) The Phase I Emergency Recall Operation to the designated level shall conform to 2.27.3.1.6(a) through (n).

2.27.3.2.4 Phase I Emergency Recall Operation to an alternate level (see 1.3) shall conform to the following:

(a) the activation of a fire alarm initiating device specified in 2.27.3.2.1(a) or 2.27.3.2.2(a) that is located at the designated level, shall cause all elevators serving that level to be recalled to an alternate level, unless Phase I Emergency Recall Operation is in effect

(b) the requirements of 2.27.3.1.6(f), (j), (m), and (n)

(c) the requirements of 2.27.3.1.6(a), (b), (c), (d), (e), (g), (h), (i), (k), and (l), except that all references to the "designated level" shall be replaced with "alternate level"

2.27.3.2.5 The recall level shall be determined by the first activated fire alarm initiating device for that group (see 2.27.3.2.1 or 2.27.3.2.2).

If the car(s) is recalled to the designated level by the "FIRE RECALL" switch(es) [see also 2.27.3.1.6(j)], the recall level shall remain the designated level.

2.27.3.2.6 When Phase I Emergency Recall (13) Operation is initiated by a fire alarm initiating device for any location listed in 2.27.3.2.6(a) through (e), as required by 2.27.3.2.3 or 2.27.3.2.4, the visual signal [see

2.27.3.1.6(h) and Fig. 2.27.3.1.6(h)] shall illuminate intermittently only in a car(s) with equipment in that location, as follows:

- (a) machine room
- (b) machinery space containing a motor controller or driving machine
- (c) control room
- (d) control space
- (e) hoistway

- (13) **2.27.3.2.7** In jurisdictions not enforcing the NBCC, listed relay(s) or other listed appliance(s) as specified and defined in NFPA 72 for connection to the fire alarm system shall be provided, and shall be

- (a) installed in conformance with the requirements of NFPA 72
- (b) used to initiate Phase I Emergency Recall Operation
- (c) located outside of any room or space requiring Group I Security (see 8.1)

- (13) **2.27.3.3 Phase II Emergency In-Car Operation.** A three-position (“OFF,” “HOLD,” and “ON,” in that order) key-operated switch that will not change position without a deliberate action by the user, shall be labeled “FIRE OPERATION,” provided in an operating panel in each car, and shall be readily accessible. The label “FIRE OPERATION” lettering shall be a minimum of 5 mm (0.25 in.) high. Text shall be either red on a background that contrasts with red, or a color that contrasts with red on a red background. It shall become effective only when Phase I Emergency Recall Operation is in effect and the car has been returned to the recall level. The switch shall be rotated clockwise to go from “OFF” to “HOLD” to “ON.”

The key shall only be removable in the “OFF” and “HOLD” position. For elevators with power-operated doors, the “OFF,” “HOLD,” and “ON” positions shall not change the mode of operation within Phase II Emergency In-Car Operation until the car is at a landing with the doors in the normal open position, except as required by 2.27.3.3.4 and 2.27.3.4. The three modes of operation within Phase II In-Car Operation (“OFF,” “HOLD,” and “ON”) are specified by 2.27.3.3.1 through 2.27.3.3.4.

For elevators with manual doors, after the car and hoistway doors have been opened at least once at the recall level, the “OFF,” “HOLD,” and “ON” positions shall then change the mode of operation in accordance with 2.27.3.3.1 through 2.27.3.3.4.

- (13) **2.27.3.3.1** When the “FIRE OPERATION” switch is in the “ON” position, the elevator shall be on Phase II Emergency In-Car Operation, for use by emergency personnel only, and the elevator shall operate as follows:

- (a) The elevator shall be operable only by a person in the car.
- (b) Floor selection means, lanterns, and indicators

(1) in the car

(a) floor selection means shall function as required in 2.27.3.3.1(i)

(b) car call-registered lights, where provided, shall remain operative

(c) car lanterns, where provided, shall remain inoperative

(d) position indicators and car-direction indicators, where provided, shall remain operative

(2) at the fire command center

(a) position indicators and car-direction indicators, where provided, shall remain operative

(3) at the designated level

(a) the car shall not respond to hall calls

(b) hall call-registered lights, where provided, shall remain inoperative, except where associated cars of a group have been returned to group automatic operation

(c) position indicators and car-direction indicators, where provided, shall remain operative

(4) at all landings, except at the designated level

(a) the car shall not respond to hall calls

(b) hall call-registered lights, where provided, shall remain inoperative, except where associated cars of a group have been returned to group automatic operation

(c) position indicators, car-direction indicators, and hall lanterns, where provided, shall remain inoperative

(c) Door open and close buttons shall be provided for power-operated doors only and located as required by 2.27.3.3.7. Buttons shall be a minimum of 19 mm (0.75 in.) in the smallest dimension. The door open and door close buttons shall be labeled “OPEN” and “CLOSE” and when applicable “REAR OPEN” and “REAR CLOSE” or “SIDE OPEN” and “SIDE CLOSE” in lettering a minimum of 5 mm (0.25 in.) in height with a contrasting background. The labeling shall be on or adjacent to the buttons. Requirement 2.26.12 does not apply to these buttons. The door open and close buttons shall be operative when the elevator is stopped within an unlocking zone.

(d) The opening of power-operated doors shall be controlled only by a continuous-pressure door open button. If the button is released prior to the doors reaching the normal open position, the doors shall automatically reclose. Requirements 2.13.3.3, 2.13.3.4, 2.13.4.2.1(b)(2), and 2.13.4.2.1(c) do not apply. All door open button(s) in the car shall be operational.

(e) Open power-operated doors shall be closed only by continuous pressure on the door close button. If the button is released prior to the doors reaching the fully closed position, horizontally sliding doors shall automatically reopen, and vertically sliding doors shall automatically stop or stop and reopen. Where provided,

additional door close button(s) in the car shall be operational.

(f) Opening and closing of power-operated car doors or gates that are opposite manual swing or manual slide hoistway doors shall conform to 2.27.3.3.1(d) and (e).

(g) All door reopening devices, except the door open button(s), shall be rendered inoperative. Full-speed closing shall be permitted.

Landing door opening and closing buttons, where provided, shall be rendered inoperative.

(h) Every car shall be provided with a button labeled "CALL CANCEL," located as required in 2.27.3.3.7, that shall be effective during Phase II Emergency In-Car Operation. When activated, all registered calls shall be canceled and a traveling car shall stop at or before the next available landing. The button shall be a minimum of 19 mm (0.75 in.) in the smallest dimension. Button labeling shall be in lettering a minimum of 5 mm (0.25 in.) in height with a contrasting background. The labeling shall be on or adjacent to the button.

(i) Floor selection means shall be provided in the car to permit travel to all landings served by the car, and shall be operative at all times, except as in 2.27.3.3.2 and 8.12.1. Means to prevent the operation of the floor selection means or door-operating buttons shall be rendered inoperative. Floor selection means that provide access to all landings served by the elevator shall be located below the firefighters' operation panel specified by 2.27.3.3.7. The floor selection means shall be operable without the use of keys, cards, tools, or special knowledge. The floor selection means shall be permitted to be located behind the locked cover specified in 2.27.3.3.7, only if floor selection means for all landings served are included behind the locked cover. Where buttons not accessible to the public are provided they shall be a minimum of 19 mm (0.75 in.) in the smallest dimension.

(j) A traveling car shall stop at the next available landing for which a car call was registered. When a car stops at a landing, all registered car calls shall be canceled.

(k) Means used to remove elevators from normal operation shall not prevent Phase II Emergency In-Car Operation, except

- (1) as specified in this Code
- (2) as controlled by elevator personnel

(l) No device, that measures load, shall prevent operation of the elevator at or below the capacity and loading required in 2.16.

(m) Every car shall be provided with a switch, conforming to the requirements of 2.26.2.33 and located as required in 2.27.3.3.7. When the switch is in the "STOP" position, all registered calls shall be canceled and power shall be removed from the elevator driving-machine motor and brake. When the switch is moved to the "RUN" position from the "STOP" position, the car shall not move, except for leveling, until a call is entered. If

the type of switch used is a button, it shall be a minimum of 19 mm (0.75 in.) in the smallest dimension.

NOTE [2.27.3.3.1(m)]: This requirement does not limit the firefighters' stop switch to a specific style of switch. Toggle switches and push/pull buttons are two possible styles. A switch, if provided, should be operable to the "STOP" position by a firefighter wearing protective gloves (see NFPA 1971).

(n) If the normal power supply, emergency power supply, and standby power supply are not available and the elevator is equipped with an alternate source of power that can move the car to a floor, but is insufficient to move the car to all landings, the following requirements shall apply:

(1) The visual signal [2.27.3.1.6(h)] shall illuminate intermittently.

(2) A car that is not at a landing shall not start until a car call is entered. After a car call is entered, the car shall move to the closest landing it is capable of reaching.

(3) A car stopped at a landing shall not move until normal power, emergency power, or standby power becomes available.

2.27.3.3.2 For elevators with power-operated doors, when the car is at a landing, with the doors open, and the "FIRE OPERATION" switch is in the "HOLD" position, the car shall remain at the landing with the doors open. The door close buttons shall be inoperative, and car calls shall not be registered. (13)

For elevators with manual doors, when the car is at a landing and the "FIRE OPERATION" switch is in the "HOLD" position, the car shall remain at the landing and car calls shall not be registered.

If the normal power supply, emergency power supply, and standby power supply are not available and the elevator is equipped with an alternate source of power and the "FIRE OPERATION" switch in the car is in the "HOLD" position, the visual signal [2.27.3.1.6(h)] shall illuminate intermittently.

2.27.3.3.3 When the car is at a landing other than the recall level, with the doors in the normal open position, and the "FIRE OPERATION" switch is in the "OFF" position, power-operated doors shall operate as follows:

(a) Horizontal sliding doors shall close automatically. All door reopening devices shall remain inoperative. Door open buttons in the car shall remain operative. Full-speed closing is permitted. If the "FIRE OPERATION" switch is turned to the "ON" or "HOLD" position prior to the completion of door closing, the doors shall reopen.

(b) Elevators having vertically sliding doors shall have corridor "DOOR OPEN" and "DOOR CLOSE" buttons rendered operative. All door reopening devices shall remain inoperative. Door closing shall be in accordance with 2.27.3.3.1(e). Full-speed closing is permitted. If the "FIRE OPERATION" switch is turned to the "ON"

or "HOLD" position prior to the completion of door closing, the doors shall reopen.

- (13) **2.27.3.3.4** When the doors are in the closed position and the "FIRE OPERATION" switch is placed in the "OFF" position, the car shall return to the recall level in conformance with 2.27.3.1.6(a) through (n) and 2.27.3.2.5.

If the normal power supply, emergency power supply, and standby power supply are not available and the elevator is equipped with an alternate source of power that can move the car to a floor, and the "FIRE OPERATION" switch in the car is in the "OFF" position, the following requirements shall apply:

(a) The visual signal [2.27.3.1.6(h)] shall illuminate intermittently.

(b) The requirements of 2.27.3.1.6(n)(2) through (5) shall apply.

2.27.3.3.5 Elevators shall be removed from Phase II Emergency In-Car Operation only when the "FIRE OPERATION" switch is in the "OFF" position and the car is at the designated level and the doors are in the normal open position.

2.27.3.3.6 The occurrence of an accidental ground or short circuit in elevator electrical equipment located on the landing side of the hoistway enclosure and in associated wiring, as a result of exposure to water, shall not disable Phase II Emergency In-Car Operation once it has been activated.

2.27.3.3.7 The "FIRE OPERATION" switch (2.27.3.3), the "CALL CANCEL" button [2.27.3.3.1(h)], the "STOP" switch [2.27.3.3.1(m)], the door open button(s), the door close button(s), the additional visual signal (2.27.3.3.8), and the operating instructions shown in Fig. 2.27.7.2 shall be grouped together in the firefighters' operation panel behind a locked cover.

The fire department communication system phone jack shall be permitted to be installed in the firefighters' operation panel. No other equipment shall be permitted in the firefighters' operation panel.

The firefighters' operation panel cover shall be operable by the same key that operates the "FIRE OPERATION" switch. The key shall be rotated clockwise to allow the panel to be opened. When open, the cover shall not restrict access to the buttons or switches or the view of the instructions. The cover shall be permitted to open automatically when the car is on Phase I Emergency Recall Operation and at the recall level. When the key is in the "FIRE OPERATION" switch, the cover shall not be capable of being closed. When closed, the cover shall be self-locking.

Where rear or side doors are provided, buttons for the front, rear, or side doors shall be provided in the firefighters' operation panel. The door open and door close buttons for the rear entrance (where provided) shall be labeled "REAR OPEN" and "REAR CLOSE."

Fig. 2.27.3.3.7 Panel Layout

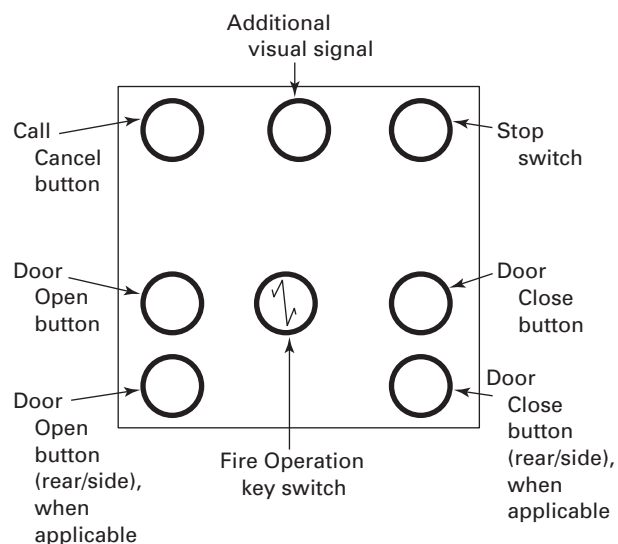

GENERAL NOTES:

- (a) Switches and buttons show only the location not the labeling.
 (b) Not to scale.

The door open and door close buttons for the side entrance (where provided) shall be labeled "SIDE OPEN" and "SIDE CLOSE."

All buttons, switches, and the lock for the panel shall be located more than 1 220 mm (48 in.) and less than 1 830 mm (72 in.) above the floor as measured to the centerline of the button, switch, or lock, and shall be arranged as shown in Fig. 2.27.3.3.7. Requirement 2.26.12 does not apply to these buttons and switches. The front of the cover shall contain the words "FIREFIGHTERS' OPERATION" in red letters at least 10 mm (0.4 in.) high.

The firefighters' operation panel shall be located as follows:

(a) The panel shall be on the same vertical centerline as a floor selection means that provides access to all floors served by the elevator.

(b) The panel and the floor selection means shall be located on the wall of the car containing the door that opens to the lobby where the "FIRE RECALL" switch is located, or immediately adjacent to that wall on a side wall.

2.27.3.3.8 An additional visual signal shall be provided and located as required by 2.27.3.3.7. The additional visual signal shall be one of the symbols shown in Fig. 2.27.3.1.6(h). The entire circular or square area shown in Fig. 2.27.3.1.6(h) shall be illuminated. This additional visual signal shall be activated whenever the visual signal in 2.27.3.1.6(h) is activated.

2.27.3.4 Interruption of Power. The failure and subsequent restoration of electrical power (normal, emergency, or standby) shall not cause any elevator to be

removed from Phase I Emergency Operation or Phase II Emergency In-Car Operation.

(a) Elevators on Phase I Emergency Operation shall be permitted to move only to the next floor in the direction of the recall level to reestablish absolute car position prior to conforming to 2.27.3.1 and 2.27.3.2.

(b) Elevators on Phase II Emergency In-Car Operation with the key in the "OFF" position shall be permitted to move only to the next floor in the direction of the recall level to reestablish absolute car position prior to conforming to 2.27.3.3.3 and 2.27.3.3.4. If the key is moved to the "ON" or "HOLD" position before the doors are fully closed, 2.27.3.4(c) or (d) shall apply, and automatic power-operated doors shall open if in a leveling zone.

(c) Elevators on Phase II Emergency In-Car Operation with the key in the "HOLD" position shall not move, except for leveling within a leveling zone. Automatic power-operated doors shall open if the doors are not fully closed and the car is in a leveling zone.

(d) Elevators on Phase II Emergency In-Car Operation with the key in the "ON" position shall not move, except for leveling within a leveling zone, until a car call is entered. Automatic power-operated doors shall not move until a door open or close button is pressed; after which they shall conform to 2.27.3.3.1(d) and (e). After a car call is entered, the car shall be permitted to move only to the next floor in the direction of the recall level to reestablish absolute car position prior to answering car calls.

2.27.3.5 Multicompartment Elevators. Multicompartment elevators shall also conform to 2.27.3.5.1 through 2.27.3.5.4.

2.27.3.5.1 The "FIRE RECALL" switch (2.27.3.1) shall be located at the designated level served by the upper compartment.

2.27.3.5.2 The "FIRE OPERATION" switch (see 2.27.3.3) shall be located in the upper compartment.

2.27.3.5.3 A means to display the entire floor area in the lower compartment shall be located in the upper compartment. The means shall display the lower compartment only when Firefighters' Emergency Operation is in effect.

2.27.3.5.4 A switch labeled "LOWER CAR LOCKOUT" with two positions marked "OFF" and "ON" shall be located behind the firefighters' operation panel cover (see 2.27.3.3.7).

NOTE (2.27.3.5.4): The switch should be operable by a firefighter wearing protective gloves (see NFPA 1971).

(a) The "LOWER CAR LOCKOUT" switch shall only be functional when Phase II is in effect.

(b) When placed in the "ON" position, the "LOWER CAR LOCKOUT" switch shall

(1) disable all door reopening devices in the lower compartment, and

(2) initiate closing of the lower compartment doors in accordance with 2.13.4.2.1(c).

(c) When the car is stopped at a landing and the "LOWER CAR LOCKOUT" switch is in the "OFF" position, the lower compartment doors shall be opened.

2.27.4 Firefighters' Emergency Operation: Nonautomatic Elevators

Firefighters' Emergency Operation shall apply to all nonautomatic elevators, except where the hoistway or a portion thereof is not required to be fire-resistive construction (see 2.1.1.1), the rise does not exceed 2 000 mm (80 in.), and the hoistway does not penetrate a floor.

2.27.4.1 Phase I Emergency Recall Operation. A (ED) three-position key-operated switch shall be provided at the designated level for each single elevator or for each group of elevators. The three-position switch shall be labeled "FIRE RECALL" and its positions marked "RESET," "OFF," and "ON" (in that order), with the "OFF" position as the center position. The "FIRE RECALL" letters shall be a minimum of 5 mm (0.25 in.) high in red or a color contrasting with a red background. The three-position switch shall be located in the lobby within sight of the elevator or all elevators in that group and shall be readily accessible.

An additional "FIRE RECALL" switch with two positions, "OFF" and "ON" (in that order), shall be permitted only at the fire command center.

The switch(es) shall be rotated clockwise to go from the "RESET" (designated level switch only), to the "OFF" and to the "ON" positions.

All keys shall be removable only in the "OFF" and "ON" positions.

Only the "FIRE RECALL" switch(es) or fire alarm initiating devices located at floors that are served by the elevator, in the hoistway, or in an elevator machine room, a control space, or a control room (see 2.27.3.2) shall initiate Phase I Emergency Recall Operation.

All "FIRE RECALL" switches shall be provided with an illuminated visual signal to indicate when Phase I Emergency Recall Operation is in effect.

When all switches are in the "OFF" position, normal elevator service shall be in effect and the fire alarm initiating devices required by 2.27.4.2 shall be operative.

When a "FIRE RECALL" switch is in the "ON" position, a visual and audible signal shall be provided to alert the attendant to return nonstop to the designated or alternate level. The visual signal shall read "FIRE RECALL — RETURN TO ____" [insert level to which the car should be returned (the designated or alternate level)]. The signal system shall be activated when Phase I Emergency Recall Operation is in effect.

Where an additional "FIRE RECALL" switch is provided, both "FIRE RECALL" switches must be in the

“ON” position to recall the elevator to the designated level if the elevator was recalled to the alternate level.

Where an additional “FIRE RECALL” switch is provided, it shall not affect the visual signal if the designated level fire alarm initiating device (see 2.27.3.2.4) has been activated.

To extinguish the audible and visual signals, the “FIRE RECALL” switch shall be rotated first to the “RESET” and then to the “OFF” position, provided that:

(a) the additional two-position “FIRE RECALL” switch, where provided, is in the “OFF” position

(b) no fire alarm initiating device is activated (see also 2.27.3.2.4)

No device, that measures load, shall prevent operation of the elevator at or below the capacity and loading required in 2.16.

(13) 2.27.4.2 Phase I Emergency Recall Operation by Fire Alarm Initiating Devices

(a) Fire alarm initiating devices shall be installed, in the locations listed in 2.27.4.2(a)(1) through (3), in compliance with the requirements in NFPA 72 or NBCC, whichever is applicable (see Part 9), as follows:

(1) at each elevator lobby served by the elevator

(2) in the associated elevator machine room, machinery space containing a motor controller or driving machine, control space, or control room

(3) in the elevator hoistway, when sprinklers are located in those hoistways

(b) Phase I Emergency Recall Operation, conforming to 2.27.4.1, shall be initiated when any Phase I Emergency Recall Operation fire alarm initiating device specified in 2.27.4.2(a) is activated.

(c) Phase I Emergency Recall Operation, when initiated by a Phase I Emergency Recall Operation fire alarm initiating device, shall be maintained until canceled by moving the “FIRE RECALL” switch to the “RESET,” then “OFF” position.

(d) When a fire alarm initiating device in a location specified by 2.27.4.2(a)(2) or (3) initiates Phase I Emergency Recall Operation as required by 2.27.3.2.3 or 2.27.3.2.4, the visual signal [see 2.27.3.1.6(h) and Fig. 2.27.3.1.6(h)] shall illuminate intermittently only in a car(s) with equipment in that location.

2.27.5 Firefighters’ Emergency Operation: Automatic Elevators With Designated-Attendant Operation

(13) 2.27.5.1 When designated-attendant operation is not in effect, elevators shall conform to 2.27.3 and when Occupant Evacuation Operation is provided shall also conform to 2.27.11.6.

(13) 2.27.5.2 When operated by a designated attendant in the car, except hospital service

(a) elevators parked at the recall level shall conform to 2.27.3 and when Occupant Evacuation Operation is

provided shall also conform to 2.27.11.6 without delay; elevators parked at a floor other than the recall level shall conform to 2.27.3.1.6(h). At the completion of a time delay of not less than 10 s and not more than 30 s, elevators parked at a floor away from the recall level shall conform to 2.27.3 and when Occupant Evacuation Operation is provided shall also conform to 2.27.11.6.

(b) A moving car shall conform to 2.27.3 and when Occupant Evacuation Operation is provided shall also conform to 2.27.11.6.

2.27.5.3 When an elevator that is provided with Firefighters’ Emergency Operation or Occupant Evacuation Operation is on hospital service, a visual signal as shown in Fig. 2.27.3.1.6(h) shall illuminate and a continuous audible signal, audible within the car, shall sound when the “FIRE RECALL” switch(es) (see 2.27.3.1 and 2.27.11.1.2) is in the “ON” position, or when a fire alarm initiating device (see 2.27.3.2) is activated to alert the operator of an emergency. A means located in the car shall be permitted for manually silencing the audible signal, after the signal has been active for at least 5 s. The signal shall be automatically reactivated when the doors open. **(ED)**

The car shall remain under control of the operator until removed from hospital service. An elevator on Firefighters’ Emergency Operation or Occupant Evacuation Operation shall not be placed on hospital service.

2.27.6 Firefighters’ Emergency Operation, Occupant Evacuation Operation: Inspection Operation **(ED)**

When an elevator that is provided with Firefighters’ Emergency Operation or Occupant Evacuation Operation is on inspection operation (see 2.26.1.4 and 2.26.1.5) or when the hoistway access switch(es) has been enabled (see 2.12.7.3.2), a continuous audible signal, audible at the location where the inspection operation is activated, shall sound when the “FIRE RECALL” switch(es) (see 2.27.3.1 and 2.27.11.1.2) is in the “ON” position or when the fire alarm initiating device (see 2.27.3.2 and 2.27.11.5) is activated to alert the operator of an emergency. The car shall remain under the control of the operator until removed from inspection operation or hoistway access operation. Inspection operation or hoistway access operation shall take precedence over Phase I Emergency Recall Operation, Phase II Emergency In-Car Operation, and Occupant Evacuation Operation.

2.27.7 Firefighters’ Emergency Operation: Operating Procedures

2.27.7.1 Instructions for operation of elevators under Phase I Emergency Recall Operation shall be incorporated with or adjacent to the “FIRE RECALL” switch at the designated level. The instructions shall include only the wording shown in Fig. 2.27.7.1.

Fig. 2.27.7.1 Phase I Emergency Recall Operation Instructions

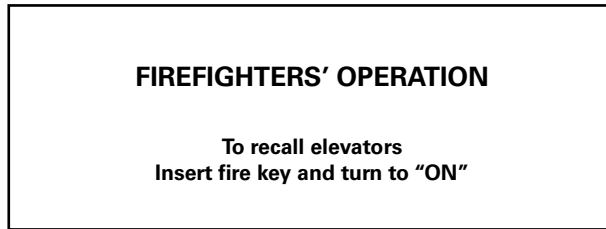



Fig. 2.27.7.2 Phase II Emergency In-Car Operation

| FIRE OPERATION | |
|--|--|
| When |  flashing, exit elevator |
| To operate car | Insert fire key and turn to "ON." Enter floor selection. |
| To cancel floor selection | Press "CALL CANCEL" button. |
| To close door | Press and hold "CLOSE" button. |
| To open door | Press and hold "OPEN" button. |
| To hold car at floor | With doors open, turn key to "HOLD." |
| For emergency stop | Use "STOP" switch. |
| To automatically return to recall floor | Turn key to "OFF." |

2.27.7.2 A sign containing instructions for operation of elevators under Phase II Emergency In-Car Operation shall be incorporated with or adjacent to the switch in each car and shall be visible only when the cover (2.27.3.3.7) is open. The sign shall include only the wording and graphics shown in Fig. 2.27.7.2, except

(a) for elevators with manually operated doors, the instructions for opening and closing the doors shall be permitted to be replaced with short phrases such as "PUSH DOOR" or "PULL DOOR UP"

(b) for elevators with vertically sliding doors, the instructions for returning the car to the recall level shall

be permitted to be expanded to include instructions for closing the door

2.27.7.3 Instructions shall be in letters not less than 3 mm (0.125 in.) in height and shall be permanently installed and protected against removal or defacement.

2.27.7.4 In jurisdictions that enforce the NBCC, a symbol showing a red firefighters' hat on a contrasting background, as shown in Fig. 2.27.3.1.6(h) (figure not to scale), shall be used exclusively to identify elevators that comply with 2.27.3 and additional NBCC requirements. This identification shall be located on the elevator

Fig. 2.27.8 FEO-K1 Key

(13)

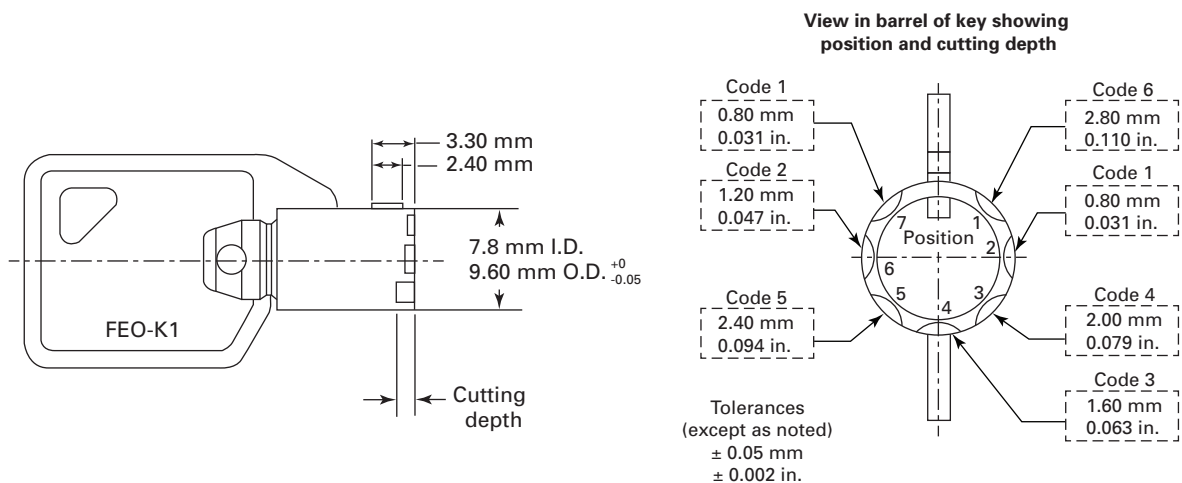

| Position | Bitting Code | Depth of Cut, mm | Depth of Cut, in. |
|----------|--------------|------------------|-------------------|
| 1 | 6 | 2.80 | 0.110 |
| 2 | 1 | 0.80 | 0.031 |
| 3 | 4 | 2.00 | 0.079 |
| 4 | 3 | 1.60 | 0.063 |
| 5 | 5 | 2.40 | 0.094 |
| 6 | 2 | 1.20 | 0.047 |
| 7 | 1 | 0.80 | 0.031 |

entrance frame or adjacent to it at each emergency recall level. The identification on the entrance frame, or adjacent to it, shall be a minimum of 50 mm (2 in.) in height.

(13) **2.27.8 Switch Keys**

The key switches required by 2.27.2 through 2.27.5 and 2.27.11 for all elevators in a building shall be operable by the FEO-K1 key. The keys shall be Group 3 Security (see 8.1). A separate key shall be provided for each switch. These keys shall be kept on the premises in a location readily accessible to firefighters and emergency personnel, but not where they are available to the public. This key shall be of a tubular, 7 pin, style 137 construction and shall have a bitting code of 6143521 starting at the tab sequenced clockwise as viewed from the barrel end of the key and cutting depths shall be in accordance with Fig. 2.27.8. The key shall be coded "FEO-K1." The possession of the "FEO-K1" key shall be limited to elevator personnel, emergency personnel, elevator equipment manufacturers, and authorized personnel during checking of Firefighters' Emergency Operation (see 8.1 and 8.6.11.1).

Where provided, a lock box, including its lock and other components, shall conform to the requirements of UL 1037 (see Part 9).

NOTE (2.27.8): Local authorities may specify additional requirements for a uniform keyed lock box and its location to contain the necessary keys.

2.27.9 Elevator Corridor Call Station Pictograph

When the building code requires a sign be posted adjacent to hall call fixtures instructing occupants not to use the elevator in case of fire, the sign shown in Fig. 2.27.9 shall be provided. The sign shall include only the wording and graphics shown in Fig. 2.27.9. When the building code specifies a different design, 2.27.9 shall not apply.

2.27.10 Reserved for Future Use

(13)

2.27.11 Occupant Evacuation Operation

(13)

Where elevators are provided for occupant evacuation, Occupant Evacuation Operation (OEO) shall be provided to function prior to Firefighter's Emergency Operation and shall conform to 2.27.11.1 through 2.27.11.6. See also Nonmandatory Appendix V.

2.27.11.1 The requirements of 2.27.3.1 shall be modified as follows.

2.27.11.1.1 The three-position switch in the lobby (2.27.3.1.1) and two-position switch in the fire command center (2.27.3.1.2) shall be labeled "GROUP FIRE RECALL" and indicate the elevator group that they control.

2.27.11.1.2 An additional three-position key-operated individual "CAR FIRE RECALL" switch per

Fig. 2.27.9 Elevator Corridor Call Station Pictograph

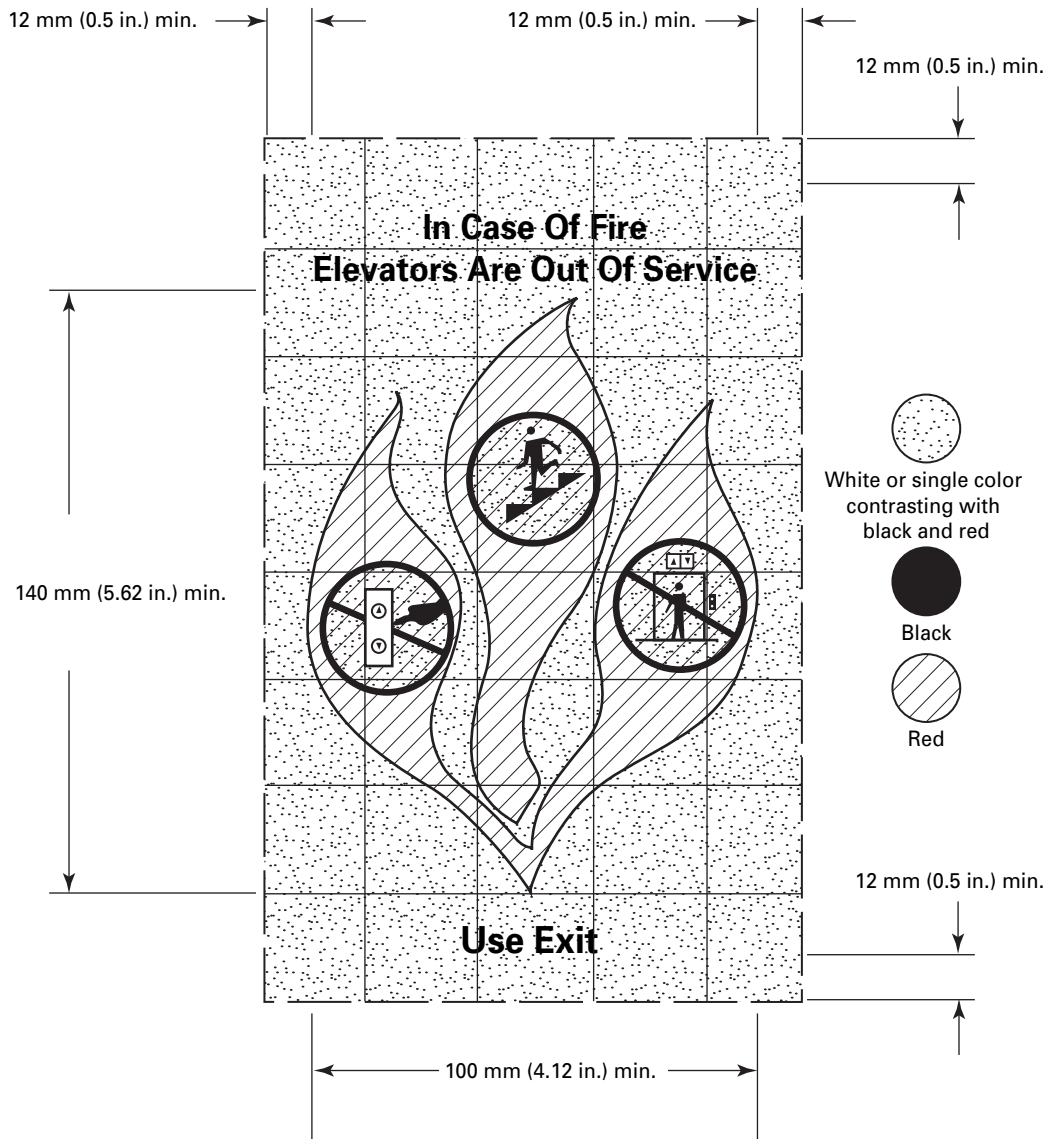

Lettering: 6 mm (0.25 in.) high min., black filled

GENERAL NOTES:

- (a) Grid lines shown for scaling purposes only.
- (b) Aspect ratio shall be maintained as shown.
- (c) The color of the circle interior is permitted to be a different color than the background.

elevator, that will not change position without a deliberate action by the user, shall be located in the lobby at the elevator discharge level adjacent to the elevator it controls. Each switch shall be labeled "CAR ___ FIRE RECALL" (with the car identification, as specified in 2.29.1, inserted), and its positions marked "RESET," "OFF," and "ON" (in that order) in letters a minimum of 5 mm (0.25 in.) high. Text shall be black on a yellow background. Each switch shall control the associated elevator in conformance with 2.27.3.1.6, but shall not control the other elevators controlled by the "GROUP FIRE RECALL" switch (see 2.27.11.1.1).

2.27.11.1.3 Each individual "CAR FIRE RECALL" switch shall terminate Occupant Evacuation Operation for the elevator it controls when placed in the "ON" position. Each "GROUP FIRE RECALL" switch shall terminate Occupant Evacuation Operation for the elevators it controls when placed in the "ON" position.

2.27.11.1.4 Each individual "CAR FIRE RECALL" switch shall be provided with an illuminated visual signal to indicate when Phase I Emergency Recall Operation is in effect for that car (see 2.27.3.1.5).

2.27.11.1.5 To remove an individual elevator from Phase I Emergency Recall Operation, the individual "CAR FIRE RECALL" switch shall be rotated first to the "RESET," and then to the "OFF" position, provided that

(a) the "GROUP FIRE RECALL SWITCH" and the additional two-position "GROUP FIRE RECALL" switch, where provided, are in the "OFF" position

(b) no fire alarm initiating device is activated (see 2.27.3.2)

2.27.11.1.6 A car with its individual "CAR FIRE RECALL" switch in the "ON" position shall not be removed from Phase I Emergency Recall Operation when the "GROUP FIRE RECALL" switch is rotated to the "RESET" position and then to the "OFF" position.

2.27.11.1.7 The designated level shall be the same floor as the elevator discharge level. At the elevator discharge level, only the door(s) serving the lobby where the "GROUP FIRE RECALL" switch is located shall open.

2.27.11.2 The sign required by 2.27.9 shall not be installed. A variable message sign, as defined in ANSI/ICC A117.1, shall be installed for each elevator group on each landing served. It shall be located not less than 2 130 mm (84 in.) and not more than 3 000 mm (120 in.) above the floor and in a central visible location within the elevator lobby. Message text shall be a minimum of 50 mm (2 in.) high and conform to ANSI/ICC A117.1 or Nonmandatory Appendix E, Clause E-20, whichever is applicable (see Part 9 and E-1). The variable message signs shall be powered by the same power supply as the elevator, including emergency or standby power.

Where not prohibited by the building code, when the elevators are not on Occupant Evacuation Operation or Firefighters' Emergency Operation, the variable message signs shall be permitted to display other elevator system status messages.

NOTE: Sample text: "Elevators in normal operation."

2.27.11.3 Where hoistway pressurization is provided, a car on Phase I Emergency Recall, after completing the requirements of 2.27.3.1.6, shall conform to the following:

(a) A car shall close its doors after 15 s.

(b) Door reopening devices, door force limiting devices, kinetic energy limiting devices, and the door open button shall remain active.

(c) At least one operating device normally used to call a car to the landing (e.g., hall call button, keypad) shall be located in the elevator lobby at the elevator discharge level. Actuating this device shall cause all recalled cars to open their doors for 30 s to 45 s, then reclose.

2.27.11.4 A position indicator shall be provided at the elevator discharge level above or adjacent to the entrance for each car. The position indicator shall be powered by the same power supply as the elevator, including emergency or standby power.

2.27.11.5 Fire Alarm System Interface

2.27.11.5.1 Upon activation of an automatic fire alarm initiating device in the building in any area that does not initiate Phase I recall in this group, the fire alarm system shall provide signals to the elevator system in conformance with NFPA 72 indicating the floors to be evacuated. The floors to be evacuated shall be a contiguous block of floors, consisting of at least the floor with an active alarm, two floors above and two floors below. The elevator system shall initiate Occupant Evacuation Operation in accordance with 2.27.11.6 for the indicated floors. It activation of an automatic fire alarm initiating device which does not initiate Phase I recall in this group occurs on an additional floor(s) at any time while Occupant Evacuation Operation in accordance with 2.27.11.6 is in effect, the evacuation zone shall be expanded to include all floors with an active alarm, all floors between the highest and lowest floor with an active alarm plus two floors above the highest floor with an active alarm and two floors below the lowest floor with an active alarm. If the active alarm is on the elevator discharge level, automatic initiation of Occupant Evacuation Operation in accordance with 2.27.11.6 shall not be permitted. Manual initiation by authorized or emergency personnel shall be permitted.

NOTE (2.27.11.5.1): An active alarm refers to the condition caused by the "activation of an automatic fire alarm initiating device" as used in this requirement.

2.27.11.5.2 A means to initiate total building evacuation, labeled "ELEVATOR TOTAL BUILDING EVACUATION" shall be provided at the fire command center location and installed in accordance with NFPA 72. When this means is actuated, the fire alarm system shall provide a signal to the elevator system indicating that all floors are to be evacuated.

2.27.11.6 When any of the signals provided in 2.27.11.5 actuate, the elevators shall conform to 2.27.11.6.1 through 2.27.11.6.10 in order to move occupants from the floors affected by the fire to the elevator discharge level.

2.27.11.6.1 The variable message signs required by 2.27.11.2 shall indicate one of the following messages:

(a) On all floors being evacuated, they shall indicate that the elevators are available for evacuation and the estimated time duration in minutes for the next elevator to arrive.

NOTE: Sample text: "Elevators and stairs available for evacuation. Next car in about 2 minutes."

(b) On all floors not being evacuated, they shall indicate that elevator service is not available.

NOTE: Sample text: "Elevators temporarily dedicated to other floors."

(c) On the elevator discharge level, they shall indicate that the cars are in evacuation mode and that passengers should not use elevators.

NOTE (2.27.11.6.1): Sample text: "Elevators dedicated to evacuation. Do not enter elevator."

(d) If no elevators are available for Occupant Evacuation Operation (fire service, inspection, shut off, etc.), they shall indicate that elevator service is not available. On all floors being evacuated they shall also indicate that occupants should use the stairs.

NOTE: Sample text for floors being evacuated: "Elevators out of service. Use stairs to evacuate." Sample text for other floors: "Elevators out of service."

2.27.11.6.2 Automatic visual signal or variable message sign, and voice notification in each car shall indicate that the car is being used to evacuate the building. In the event that the car stops to pick up passengers at a floor other than the elevator discharge level, the signals shall instruct the passengers to remain in the car. Upon or prior to arrival at the elevator discharge level, passengers shall be notified that they have arrived at the exit floor and to exit quickly. Message text shall be a minimum of 25 mm (1 in.) high and conform to ANSI/ICC A117.1 or Nonmandatory Appendix E, Clause E-20, whichever is applicable (see Part 9 and E-1). Voice notification shall be at least 10 dBA above ambient but not more than 80 dBA measured 1 525 mm (60 in.) above the floor, at the center of the car.

2.27.11.6.3 All landing calls outside of the contiguous block of floors being evacuated shall be canceled and disabled. Building security systems that limit service to these floors shall be overridden. Any landing call within the contiguous block of floors shall call an elevator(s) to that landing. Landing calls entered at the floor with an active alarm shall be given higher priority than the calls at the floors above and below it. If a subsequent active alarm is received from a different floor, the evacuation priority shall be assigned in the sequence received. Once passengers have entered an elevator, it shall proceed only towards the elevator discharge level. When total building evacuation is in effect and no calls are entered at an affected floor, priority shall be based on distance from the elevator discharge level, with the furthest floor served getting highest priority.

2.27.11.6.4 Car calls for all floors, except for the elevator discharge level, shall be canceled and disabled. A car call for the elevator discharge level shall be automatically entered when any landing call is answered.

2.27.11.6.5 Cars that are unoccupied when Occupant Evacuation Operation is actuated shall move without delay to a floor that is being evacuated, and park with their doors closed until a landing call is registered. If the car is in motion away from the floors being evacuated, it shall stop at or before the next available floor, without opening the doors, reverse direction, and move to a floor that is being evacuated.

2.27.11.6.6 Cars that are occupied when Occupant Evacuation Operation is actuated shall proceed without delay to the elevator discharge level. If a reversal of travel direction is needed, it shall be done at or before the next available floor without opening the doors. After opening and closing the doors at the elevator discharge level, they shall proceed without delay to a floor that is being evacuated and park with their doors closed until a landing call is registered.

2.27.11.6.7 When a car answers a landing call at a floor being evacuated, a car call for the elevator discharge level shall be automatically registered. The system shall accept a new landing call as soon as the doors have opened to permit loading at that floor, or sooner. If a new landing call is registered at this floor, it shall be assigned to another car, and not canceled until that car arrives. Actuation of the landing call device shall not prevent a loaded car from closing its doors and leaving the floor.

2.27.11.6.8 While passengers are entering the car at a floor being evacuated, when the load reaches no greater than 80% of car capacity, the door reopening device(s) shall be disabled and the doors shall initiate closing at reduced kinetic energy in accordance with 2.13.4.2.1(c). If the doors stall while closing, they shall

reopen fully, then close. An audible signal shall sound until the doors are closed. If the load exceeds 100% of capacity, the doors shall reopen and remain open and a voice notification and visual signal shall indicate that the car is overloaded.

2.27.11.6.9 Once the block of floors being evacuated has been evacuated, as indicated by a 60 s period in which no landing calls are registered, one car shall park with its doors closed at the lowest floor of the block of floors ready to answer subsequent landing calls within the block of floors; the rest shall park with doors closed at the elevator discharge level. A car parked at the elevator discharge level shall replace the car at the lowest floor of the block, that has answered a landing call.

2.27.11.6.10 Occupant Evacuation Operation shall be terminated when the fire alarm system is reset or the signals provided in 2.27.3.2 are actuated (see 2.27.11.1.3).

SECTION 2.28 LAYOUT DRAWINGS

2.28.1 Information Required on Layout Drawings

Elevator layout drawings shall, in addition to other data, indicate the following:

- (a) the maximum bracket spacing (see 2.23)
- (b) the estimated maximum vertical forces on the guide rails on application of the safety or other retarding device (see 2.23 and 2.19.3)
- (c) in the case of freight elevators for Class B or C loading (see 2.16.2.2), the horizontal forces on the guide-rail faces during loading and unloading, and the estimated maximum horizontal forces in a post-wise direction on the guide-rail faces on the application of the safety device (see 2.23)
- (d) the size and linear weight kg/m (lb/ft) of any rail reinforcement, where provided (see 2.23)
- (e) the total static and impact loads imposed on machinery and sheave beams, supports, and floors or foundations (see 2.9)
- (f) the impact load on buffer supports due to buffer engagement at the maximum permissible speed and load (see 8.2.3)
- (g) where compensation tie-down is applied (see 2.21.4.2), the load on the compensation tie-down supports
- (h) the total static and dynamic loads from the governor, ropes, and tension system
- (i) the horizontal forces on the building structure stipulated by 2.11.11.8 and 2.11.11.9
- (j) the maximum upward movement (see 2.4.6)

SECTION 2.29 IDENTIFICATION

2.29.1 Identification of Equipment

(13)

2.29.1.1 In buildings with more than one elevator, each elevator in the building shall be assigned a unique alphabetical or numerical identification.

2.29.1.2 The identification assigned in 2.29.1.1 shall be a minimum of 50 mm (2 in.) in height unless otherwise specified, and shall be painted on, engraved, or securely attached to the following:

- (a) the driving machine
- (b) MG set
- (c) controller
- (d) selector
- (e) governor
- (f) main line disconnect switch
- (g) the crosshead, or where there is no crosshead, the car frame, such that it is visible from the top of the car
- (h) the car operating panel, minimum of 13 mm (0.5 in.) in height
- (i) adjacent to or on every elevator entrance at the designated level, minimum of 75 mm (3 in.) in height

2.29.1.3 Where any of the following devices for more than one elevator are located in the same enclosure, such devices or a grouping of devices for one elevator with demarcation to establish that all devices within the demarcation belong to that identified elevator shall be identified with the unique alphabetical or numerical identification letter(s) or number(s) of its associated elevator as assigned in 2.29.1.1:

- (a) means to trip the governor and/or means to reset the governor from outside the hoistway as permitted by 2.7.6.3.4
- (b) display devices or their equivalent as required by 2.7.6.4.1
- (c) means to move the car from outside the hoistway as required by 2.7.6.4.3
- (d) stop switches as required by 2.7.6.5.2
- (e) landing inspection operation transfer switches and operating devices as required by 2.7.6.5.2 (see also 2.26.1.4.4)
- (f) "CAR DOOR BYPASS" and "HOISTWAY DOOR BYPASS" switches as required by 2.26.1.5
- (g) means to manually reset the ascending car overspeed detection means as required by 2.19.1.2(a)(4)
- (h) means to manually reset the unintended motion detection means as required by 2.19.2.2(a)(4)
- (i) the earthquake reset button or switch as required by 8.4.10.1.1(a)(2)(b)

2.29.2 Identification of Floors

Hoistways shall have floor numbers, not less than 100 mm (4 in.) in height, on the hoistway side of the enclosure or hoistway doors.

(13)

SECTION 2.30 SWAY CONTROL GUIDES

2.30.1 General Requirements

Where provided, sway control guides shall conform to the following:

(a) Sheaves and drums shall conform to requirements of 2.24.2.1 and 2.24.2.2(b).

(b) There shall be sufficient traction to lower, stop, and hold the car in the event the sway control guide becomes separated from the elevator system.

(c) Safeties shall not be provided for the sway control guide.

(d) All members of the sway control guide shall be designed to meet the strength requirements of 2.15.10.

(e) A sway control guide position switch shall be provided, conforming to the requirements of 2.25.1.2, located in the hoistway, and be operated by a cam attached to the sway control guide frame. The switch shall be located so that it operates after the car final terminal stop switch is actuated.

2.30.2 Suspension Means

Suspension means systems for a sway control guide shall conform to the following:

(a) It shall consist of not less than two suspension members.

(b) The factor of safety of suspension members shall conform to the requirements of 2.20.3.

(c) Means shall be provided to prevent the displacement of the suspension means of the sway control guide during safety or buffer operations.

(d) It shall be provided with a slack suspension detection means conforming to the requirements of 2.26.2.39.

2.30.3 Abrasion Protection

Means shall be provided to minimize the abrasion between the sway control guide and the components being stabilized by this device.

2.30.4 Guiding Members

Sway control frames shall be guided by guiding means attached to the frame. Retention means shall be provided to prevent the frame from being displaced by more than 13 mm (0.5 in.) from its normal running position should any part of the guiding means fail, excluding the guiding member base and its attachment to the frame. The retention means shall be permitted to be integral with the base.

Part 3

Hydraulic Elevators

SCOPE

Part 3 applies to direct-acting hydraulic elevators and the roped-hydraulic types.

NOTE: See also Part 8 for additional requirements that apply to *hydraulic elevators*.

SECTION 3.1 CONSTRUCTION OF HOISTWAYS AND HOISTWAY ENCLOSURES

Hoistways, hoistway enclosures, and related construction shall conform to 2.1.1 through 2.1.6 and 2.29.2, except 2.1.2.3 and 2.1.3.1.2.

3.1.1 Strength of Pit Floor

The pit equipment, beams, floor, and their supports shall be designed and constructed to meet the applicable building code requirements and to withstand the following loads in the manner in which they occur:

- (a) the impact load due to car buffer engagement (see 8.2.3 and 3.22.2)
- (b) where a plunger gripper, or car, or counterweight safety is furnished, the part of the load transmitted by the application of such gripper(s) or safety(s)
- (c) loads imposed by the hydraulic jack
 - (1) to the cylinder during normal operation
 - (2) to the buffer when resting on the buffer or during conditions described in 3.1.1(a)
- (d) hoist rope up-pull, where applicable, for indirect roped-hydraulic elevators

3.1.2 Floors Over Hoistways

The floor shall be located entirely above the horizontal plane required for hydraulic elevator top car clearance.

When a hydraulic pump unit and/or control equipment is located on a floor over the hoistway, access shall comply with 2.7.3.

SECTION 3.2 PITS

Pits shall conform to 2.2, except 2.2.7.

3.2.1 Minimum Pit Depths Required

The pit depth shall not be less than is required for the installation of the buffers, hydraulic jack, platform guard (apron), and all other elevator equipment located

therein, and to provide the minimum bottom clearance and runby required by 3.4.1 and 3.4.2, respectively.

SECTION 3.3 LOCATION AND GUARDING OF COUNTERWEIGHTS

The location and guarding of counterweights, where provided, shall conform to 2.3.

SECTION 3.4 BOTTOM AND TOP CLEARANCES AND RUNBYS FOR CARS AND COUNTERWEIGHTS

Requirement 2.4 does not apply to hydraulic elevators.

3.4.1 Bottom Car Clearance

3.4.1.1 When the car rests on its fully compressed buffers or bumpers, there shall be a vertical clearance of not less than 600 mm (24 in.) between the pit floor and the lowest structural or mechanical part, equipment, or device installed beneath the car platform, including a plunger-follower guide, if provided, except as specified in 3.4.1.2.

3.4.1.2 The 600 mm (24 in.) clearance does not apply to the following:

- (a) any equipment on the car within 300 mm (12 in.) horizontally from any side of the car platform
- (b) any equipment located on or traveling with the car located within 300 mm (12 in.) horizontally from either side of the car frame centerline parallel to the guide rails
- (c) any equipment mounted in or on the pit floor located within 300 mm (12 in.) horizontally from either side of the car frame centerline parallel to the guide rails

3.4.1.3 In no case shall the available refuge space be less than either of the following:

- (a) a horizontal area 600 mm × 1 200 mm (24 in. × 47 in.), with a height of 600 mm (24 in.)
- (b) a horizontal area 450 mm × 900 mm (18 in. × 35 in.), with a height of 1 070 mm (42 in.)

3.4.1.4 Trenches and depressions or foundation encroachments permitted by 2.2.2 shall not be considered in determining these clearances.

3.4.1.5 When the car is resting on its fully compressed buffers or bumpers, no equipment traveling

with the car, including a plunger-follower guide, if provided, shall strike any part of the pit or any equipment mounted therein.

- (13) **3.4.1.6** Where the vertical clearance outside the refuge space is less than 600 mm (24 in.), that area shall be clearly marked on the pit floor. Markings shall not be required in the area under the apron and guiding means. The marking shall consist of alternating 100 mm (4 in.) diagonal red and white stripes. In addition, a sign with the words "DANGER LOW CLEARANCE" in a minimum 50 mm (2 in.) high letters shall be prominently posted on the hoistway enclosure and shall be visible from within the pit and at the entrance to the pit. The sign shall conform to ANSI Z535.2 and ANSI Z535.4, or CAN/CSA-Z321, whichever is applicable (see Part 9). The sign shall be made of a durable material and shall be securely fastened. The letters and figures shall remain permanently and readily legible.

3.4.2 Minimum Bottom and Top Car Runby

3.4.2.1 Bottom Car Runby. The bottom car runby shall be

- (a) not less than 75 mm (3 in.) for operating speed(s) in the down direction up to 0.50 m/s (100 ft/min)
- (b) increased from 75 mm (3 in.) to 150 mm (6 in.) in proportion to the increase in operating speed(s) in the down direction from 0.50 m/s (100 ft/min) to 1 m/s (200 ft/min)
- (c) a minimum of 150 mm (6 in.) for operating speed(s) in the down direction exceeding 1 m/s (200 ft/min)

3.4.2.2 Car Top Minimum Runby. The top runby of the car shall be

- (a) not less than 75 mm (3 in.) for rated speeds up to 0.50 m/s (100 ft/min)
- (b) increased from 75 mm (3 in.) to 150 mm (6 in.) in proportion to the increase in rated speed from 0.50 m/s (100 ft/min) to 1 m/s (200 ft/min)
- (c) a minimum of 150 mm (6 in.) for rated speeds exceeding 1 m/s (200 ft/min)

3.4.3 Car Top and Bottom Maximum Runby

Neither the top nor the bottom runby of the car shall be more than 600 mm (24 in.).

3.4.4 Maximum Upward Movement

The maximum upward movement shall be the distance the car sill is above the top landing when the plunger stop (3.18.4) is engaged.

3.4.5 Top of Car Clearances

The top of car clearances shall conform to 2.4.7 except as specified in 3.4.8.

NOTE (3.4.5): See Nonmandatory Appendix G.

3.4.6 Top Clearance and Bottom Runby of Counterweight

Where a counterweight is provided, the top clearance and the bottom runby of the counterweight shall conform to 3.4.6.1 and 3.4.6.2.

3.4.6.1 Top Clearance. The top clearance shall be not less than the sum of the following:

- (a) the bottom car runby
- (b) the stroke of the car buffers used
- (c) 150 mm (6 in.)

3.4.6.2 Bottom Runby. The bottom runby shall be not less than the sum of the following:

- (a) the distance the car can travel above its top terminal landing until the plunger strikes its mechanical stop
- (b) 150 mm (6 in.)

The minimum runby specified shall not be reduced by rope stretch (see 3.22.2 prohibiting counterweight buffers).

3.4.7 Equipment on Top of Car Not Permitted to Strike Overhead Structure

Equipment on top of the car shall conform to the requirements in 2.4.9.

3.4.8 Clearances Above Hydraulic Jack Projecting Above the Car

When the car has reached its maximum upward movement, a vertical clearance of 100 mm (4 in.) shall be provided from a hydraulic jack attached to the car and the jacks' attachment means to the horizontal plane described by the lowest part of the overhead structure or other obstruction adjacent to the car enclosure top within the vertical projection of the hydraulic jack and its attachment means. Additionally a horizontal clearance in the direction of the centerline of the car top of at least 300 mm (12 in.) shall be provided from the top of the hydraulic jack to any object creating a shearing hazard.

NOTE (3.4.8): See Nonmandatory Appendix G, Fig. G-5.

SECTION 3.5 HORIZONTAL CAR AND COUNTERWEIGHT CLEARANCES

The horizontal car and counterweight clearances shall conform to 2.5.

SECTION 3.6 PROTECTION OF SPACES BELOW HOISTWAY

Requirement 2.6 does not apply to hydraulic elevators. Where there is space below the hoistway that is accessible to persons, requirements of 3.6.1 through 3.6.4 shall be conformed to.

3.6.1 Jack-Supporting Structure

The hydraulic jack shall be supported by a structure of sufficient strength to support the entire static load at rated capacity that is capable of being imposed upon it. The design factor of safety shall be not less than 5, based on ultimate strength for static loads transmitted.

3.6.2 Counterweight Safety Actuation

Where the space referred to in 3.6 falls underneath the counterweight and/or its guides, the counterweight shall be provided with a safety device that functions as a result of the breaking or slackening of the counterweight suspension ropes.

3.6.3 Buffer Types

The car shall be provided with buffers of either of the following types:

- (a) oil buffers conforming to 3.22.1
- (b) spring buffers of a design that will not be fully compressed when struck by a car with rated load at the operating speed in the down direction (see 3.22.1)

3.6.4 Buffer Supports

Car buffer supports shall be provided that will withstand, without permanent deformation, the impact resulting from buffer engagement by a car with rated load at the operating speed in the down direction. The design factor of safety shall conform to 2.22.4.3.

SECTION 3.7 MACHINERY SPACES, MACHINE ROOMS, CONTROL SPACES, AND CONTROL ROOMS

A machinery space outside the hoistway containing a hydraulic machine and a motor controller shall be a machine room.

3.7.1

Machinery spaces, machine rooms, control spaces, and control rooms shall conform to the requirements of 2.7.1 through 2.7.7 and 2.7.9.

3.7.1.1 In 2.7.5.1.1, 2.7.5.2, and 2.7.5.2.4, replace the words "elevator driving-machine brake or an emergency brake" with the words "hydraulic machine."

3.7.1.2 In 2.7.5.1 and 2.7.5.1.2(a), replace the words "elevator driving-machine brake, emergency brake" with the words "hydraulic machine."

3.7.1.3 In 2.7.5.1.2(b), replace the wording with the following: "for a roped-hydraulic elevator support not less than twice the unbalanced weight of the system with no load and up to rated load in the car and all suspension ropes in place; and for a direct-acting hydraulic elevator support not less than twice the weight of the car with rated load."

3.7.1.4 In 2.7.5.1.2(c), 2.7.5.3.1, and 2.7.5.5(a), replace the words "elevator driving-machine motor and brake" with the words "hydraulic machine."

3.7.1.5 In 2.7.5.1.2(e) and 2.7.5.2.1(b)(4), replace the words "before maintaining or inspecting brake, emergency brake" with the words "before maintaining or inspecting the hydraulic machine."

3.7.1.6 In 2.7.5.2.1(b)(1) and 2.7.5.5(d), replace the words "115% of rated speed" with the words "operating speed in the down direction."

3.7.1.7 In 2.7.6.3.1, replace the words "electric driving machine" with the words "hydraulic machine."

3.7.1.8 In 2.7.6.4, replace the wording with the following: "Where hydraulic machine, or an elevator motion controller or motor controller is located in the hoistway or pit, means necessary for tests that require movement of the car shall be provided and arranged so that they can be operated from outside the hoistway and shall conform to 2.7.6.4.1 through 2.7.6.4.2. These means are also permitted to be used by elevator personnel for passenger rescue."

3.7.1.9 In 2.7.6.4.1, replace the first paragraph with the following: "Where direct observation of the elevator or ropes in the case of a roped-hydraulic elevator is not possible from the location of the means necessary for tests that require movement of the car, display devices or the equivalent shall be provided. They shall be visible from the location of the means and shall convey the following information about the elevator simultaneously:"

3.7.1.10 Requirement 2.7.6.4.3 does not apply to hydraulic elevators.

SECTION 3.8 ELECTRICAL EQUIPMENT, WIRING, PIPES, AND DUCTS IN HOISTWAY, MACHINERY SPACES, MACHINE ROOMS, CONTROL SPACES, AND CONTROL ROOMS

Electrical equipment, wiring, pipes, and ducts shall conform to 2.8.

SECTION 3.9 MACHINERY AND SHEAVE BEAMS, SUPPORTS, AND FOUNDATIONS

Machinery and sheave beams, supports, and foundations shall conform to 2.9.

SECTION 3.10 GUARDING OF EXPOSED AUXILIARY EQUIPMENT

Guarding of exposed auxiliary equipment shall conform to 2.10.

SECTION 3.11 PROTECTION OF HOISTWAY LANDING OPENINGS

Protection of hoistway landing openings shall conform to 2.11, except as excluded by 3.11.1.

3.11.1 Emergency Doors

Emergency doors, where required by 2.11.1, are required only when car safeties are provided.

(13) SECTION 3.12 HOISTWAY DOOR LOCKING DEVICES, ELECTRIC CONTACTS, AND HOISTWAY ACCESS SWITCHES

(13) 3.12.1 General

The requirements of 2.12 shall apply.

3.12.2 Car Door or Gate Electric Contacts and Car Door Interlocks

Car door or gate electric contacts and car door interlocks shall conform to 2.14.4.2.

SECTION 3.13 POWER OPERATION, POWER OPENING, AND POWER CLOSING OF HOISTWAY DOORS AND CAR DOORS OR GATES

Power operation, power opening, and power closing of hoistway doors and car doors or gates shall conform to 2.13.

SECTION 3.14 CAR ENCLOSURES, CAR DOORS AND GATES, AND CAR ILLUMINATION

Car enclosures, car doors and gates, and car illumination shall conform to 2.14 except 2.14.2.3.3(b) does not apply where the elevator conforms to the requirements of 3.26.10.

SECTION 3.15 CAR FRAMES AND PLATFORMS

3.15.1 Requirements

3.15.1.1 Direct-acting hydraulic elevators shall be provided with car frames and platforms conforming to 2.15, subject to the modification hereinafter specified. (See 3.18.2.3 for connection between plunger and platform or car frame.)

A car frame shall not be required, provided 3.15.1.1.1 through 3.15.1.1.6 are conformed to.

3.15.1.1.1 The platform frame shall be of such design and construction that all eccentric loads are carried through the structure and plunger attachment into the hydraulic jack (see 3.18.2.3).

3.15.1.1.2 The platform frame shall be guided on each guide rail by single-guiding members attached to the frame.

3.15.1.1.3 The platform frame shall be designed to withstand the forces resulting from the class of loading for which the elevator is designed without exceeding the stresses and deflections in 2.15.10 and 2.15.11 (see 8.2.2.6).

3.15.1.1.4 The hydraulic jack connection to the car shall be designed to transmit the full eccentric moment into the plunger with a factor of safety of not less than 4 (see 3.18.2.3).

3.15.1.1.5 The hydraulic jack shall be designed to withstand the stresses due to bending during the loading and unloading of the platform based on the type of loading for which the elevator is designed (see 8.2.8.1.2).

3.15.1.1.6 Car safeties shall not be provided.

3.15.1.2 Roped-hydraulic elevators shall be provided with car frames and platforms conforming to 2.15.

3.15.2 Maximum Allowable Stresses and Deflections in Car Frame and Platform Members

3.15.2.1 Direct-Acting Hydraulic Elevators. The stresses and deflections in car frame and platform members and their connections, based on the static load imposed upon them, shall be not more than those permitted by 2.15, provided that the maximum stresses in the car frame uprights that are normally subject to compression shall conform to 8.2.9.1.1.

3.15.2.2 Roped-Hydraulic Elevators. The stresses and deflection in car frame and platform members and their connections, based on the static load imposed upon them, shall be not more than those permitted by 2.15, and shall conform to 8.2.2.

3.15.3 Calculations of Stresses and Deflections in Car Frame and Platform Members

3.15.3.1 Direct-Acting Hydraulic Elevators. The calculations of the stresses and deflections in side-post car frame and platform members shall be based on the formulas and data in 8.2.9.

For cars with corner-post or sub-post car frames, the formulas and specified methods of calculations do not generally apply and shall be modified to suit the specific conditions and requirements in each case.

3.15.3.2 Roped-Hydraulic Elevators. The calculations of the stresses and deflections in side-post car frame and platform members shall be based on the formulas and data in 8.2.2.

For cars with corner-post or sub-post car frames, or where the rope hitches are not on the crosshead, the formulas and specified methods of calculations do not

generally apply and shall be modified to suit the specific conditions and requirements in each case.

SECTION 3.16 CAPACITY AND LOADING

3.16.1 Minimum Rated Load for Passenger Elevators

The requirements of 2.16.1 shall apply.

3.16.2 Minimum Rated Load for Freight Elevators

The requirements of 2.16.2 shall apply, except, in 2.16.2.2.4(c) the wording “hydraulic jack, hydraulic machine, pressure piping and fittings” shall be substituted for the wording “driving-machine motor, brake and traction relation.”

3.16.3 Capacity and Data Plates

The requirements of 2.16.3 shall apply, except:

(a) requirement 2.16.3.2.1(a) shall not apply to hydraulic elevators.

(b) on data plates (see 2.16.3.2.2), the weight of the plunger is not to be included in the weight of the complete car, even though it is attached. The plunger weight is to be indicated independently. The operating speed in the down direction shall also be indicated.

(c) requirement 2.16.3.2.2(c) applies only for roped-hydraulic elevators.

(d) requirement 2.16.3.2.2(e) applies only where car safeties are provided.

3.16.4 Carrying of Passengers on Freight Elevators

The requirements of 2.16.4 shall apply, except 2.16.4.3 shall not apply to hydraulic elevators.

3.16.5 Signs Required in Freight Elevators

The requirements of 2.16.5 shall apply.

3.16.6 Overloading of Freight Elevators

The requirements of 2.16.6 shall apply, except 2.16.6(b) shall not apply to hydraulic elevators.

3.16.7 One-Piece Loads Exceeding the Rated Load

Requirement 2.16.7 shall not apply. One-piece loads exceeding rated load shall not be carried on hydraulic elevators.

3.16.8 Additional Requirements for Passenger Overload

Requirement 2.16.8 shall not apply. Hydraulic passenger elevators shall be designed based on 100% of rated load.

3.16.9 Special Loading Means

The requirements of 2.16.9 shall apply.

SECTION 3.17 CAR SAFETIES, COUNTERWEIGHT SAFETIES, PLUNGER GRIPPER, AND GOVERNORS

3.17.1 Car Safeties

Car safeties shall be provided for roped-hydraulic elevators and shall be permitted to be provided for direct-acting hydraulic elevators. When provided, car safeties shall conform to 2.17, and to 3.17.1.1 through 3.17.1.3.

3.17.1.1 The slack-rope device required by 3.18.1.2 shall be permitted to be an additional means of activating the car safety on roped-hydraulic elevators using hydraulic jacks equipped with plungers. The slack-rope device required by 3.18.1.2.5 shall be an additional means of activating the car safety on roped-hydraulic elevators using hydraulic jacks equipped with pistons. (ED)

3.17.1.2 The safety shall be of a type that can be released only by moving the car in the up direction. To return a car to normal operation after a safety set, the car shall be moved hydraulically in the up direction. For repairs of obvious or suspected malfunction, the car shall be permitted to be raised by other means capable of holding the entire car weight. Prior to releasing the other means, the car shall be run hydraulically in the up direction.

If an auxiliary pump is used to move the car in the up direction to release the safeties, it shall

(a) have a relief valve that limits the pressure to not more than 2.3 times the working pressure

(b) be connected between the check valve or control valve and the shutoff valve

3.17.1.3 The switches required by 2.17.7 shall, when operated, remove power from the hydraulic machine motor and control valves before or at the time of application of the safety.

3.17.2 Counterweight Safeties

Counterweight safeties, where provided in accordance with 3.6.2, shall conform to 2.17, provided that safeties shall be operated as a result of the breaking or slackening of the counterweight suspension ropes, irrespective of the rated speed of the elevator.

3.17.3 Plunger Gripper

A plunger gripper shall be permitted to be provided for direct-acting hydraulic elevators using hydraulic jacks equipped with plungers. A plunger gripper shall be capable of stopping and holding the car with its rated load from the actual measured tripping speed per Table 2.18.2.1 and shall conform to 3.17.3.1 through 3.17.3.9. In Table 2.18.2.1 the words “rated speed” shall be replaced by “operating speed in the down direction.”

3.17.3.1 Limits of Application. A plunger gripper shall be permitted, provided that

(a) the external pressure applied to the plunger by the device is symmetrically distributed at locations around the circumference of the plunger. The resulting stress in the plunger shall not exceed 67% of the yield strength at any point of the plunger.

(b) the external pressure applied to the plunger by the device does not exceed 67% of the value that will cause local buckling. Where the external pressure is applied over substantially the full circumference of the plunger, the maximum value shall be permitted to be determined by 8.2.8.6.

(c) during the application, the plunger and the plunger gripper are capable of withstanding any vertical forces imposed upon them, and transfer such forces to the supporting structure. During the application of the device, any loading on the plunger shall not damage the cylinder.

(d) power is removed from the hydraulic machine before or at the time of application.

(13) **3.17.3.2 Means of Application.** A plunger gripper shall mechanically grip the plunger when a loss of hydraulic pressure or fluid causes uncontrolled downward motion to occur. The plunger gripper shall be actuated by either a hydraulic means or an electrical means.

(13) **3.17.3.2.1 Electrical Actuation Means.** Where an electrical actuation means is provided, it shall comply with the following:

(a) The plunger gripper shall be fully operational during a primary electrical system power failure.

(b) The elevator shall not be permitted to restart after a normal stop in the event of the failure within the electrical means used to actuate the gripper of any of the following:

(1) a single mechanically operated switch

(2) a single magnetically operated switch, contactor, or relay

(3) a single solenoid

(4) a single solid-state device

(5) a software system failure

(6) the occurrence of a single ground

(13) **3.17.3.2.2 Inspection and Test Means.** Hydraulic or electrical means other than those required in 3.17.3.2 are permitted to actuate the plunger gripper for inspection and test purposes. Electrical inspection and test means are not required to comply with 3.17.3.2.1.

3.17.3.3 Release

3.17.3.3.1 The plunger gripper shall be released by establishing at least no-load static pressure on the hydraulic system, or by other means capable of holding the entire car weight.

3.17.3.3.2 The elevator shall not be permitted to be restarted without establishing at least no-load static pressure on the hydraulic system.

3.17.3.4 Normally Retracted Position. In the normally retracted position, the following shall apply. (13)

3.17.3.4.1 Clearance. In the normally retracted position of the plunger gripper, any contact between the gripping surface and the plunger shall not cause degradation of the plunger or premature degradation of the gripping surface. (13)

3.17.3.4.2 Hydraulic Holding Means. Hydraulic means are permitted to maintain the plunger gripper in the normally retracted position. (13)

3.17.3.5 Deceleration. The deceleration of the elevator upon actuation of the plunger gripper shall comply with the following criteria:

(a) The average deceleration rate at rated load shall be not less than 0.1 gravity nor more than 1.0 gravity. (See Nonmandatory Appendix P for minimum and maximum stopping distances.)

(b) Any peak deceleration rate in excess of 2.0 gravity shall have a duration of not greater than 0.04 s.

3.17.3.6 Minimum Factors of Safety and Stresses of Safety Parts and Rope Connections

3.17.3.6.1 Compliance with 2.17.12.1 and 2.17.12.6 is required. Springs shall be permitted in the operation of the plunger gripper. The maximum fiber stress in the spring shall not exceed 85% of the elastic limit in the material at any time. The factor of safety of wire ropes, if provided in the construction of the plunger gripper, shall not be less than 5. Tiller-rope construction shall not be used.

3.17.3.6.2 Leaf and roller chains, if provided in the construction of the plunger gripper, shall conform to ASME B29.100 or ASME B29.8.

3.17.3.6.3 The factors of safety shall be based upon the maximum stresses developed in the parts during operation of the gripper when stopping rated load from the tripping speed (see 3.17.3) of the speed-measuring device.

3.17.3.6.4 Rope or tape used to drive an electrical encoder is not required to comply with the requirements for governor rope.

3.17.3.6.5 If a governor is used, it must comply with 2.18.5.1, except lang-lay construction is permitted and the diameter is permitted to be less than 9.5 mm (0.375 in.).

3.17.3.7 Corrosion-Resistant Bearings in Plunger Gripper and Gripper Operating Mechanisms. Compliance with 2.17.13 is required.

- (13) **3.17.3.8 Marking Plate for a Plunger Gripper.** A permanent marking plate shall be securely attached to each plunger gripper. The plate shall be of such material and construction that it is permanent and readily legible. The letters and symbols shall be stamped, etched, cast, or otherwise applied with depressed or raised letters and symbols not less than 3 mm (0.125 in.) in height, indicating
- (a) that it is a plunger gripper.
 - (b) the maximum operating speed in the down direction in m/s (ft/min) for which the plunger gripper shall be permitted to be used.
 - (c) the maximum load in Newtons (lbf) for which the gripper is designed and installed to stop and sustain.
 - (d) the manufacturer's name or trademark and identification number of the device.
 - (e) space for date of acceptance test. Date to be permanently marked following test.
 - (f) the diameter and minimum wall thickness of the plunger for which the device is applicable.

3.17.3.9 Flexible Hoses. Flexible hoses used for the operation of a plunger gripper shall be permitted, provided that their failure does not cause an uncontrolled descent. These flexible hoses are not required to meet the requirements of 3.19.3.3.

3.17.4 Governors

Governors, when provided, shall comply with 2.18, except 2.18.4. In addition, governors shall conform to 3.17.4.1 and 3.17.4.2

3.17.4.1 The term "operating speed in the down direction with rated load" shall be substituted for the words "rated speed" whenever these words appear.

3.17.4.2 For governors located inside the hoistway, see 2.7.6.3.4.

SECTION 3.18 HYDRAULIC JACKS

3.18.1 Hydraulic Jack and Connections

Where multiple hydraulic jacks are used, they shall be hydraulically connected to form a single hydraulic system.

3.18.1.1 Direct-Acting Hydraulic Elevators. The driving member of the hydraulic jack shall be attached to the car frame or car platform with fastenings of sufficient strength to support that member with a factor of safety of not less than 4 and shall be capable of withstanding, without damage, any forces resulting from a plunger stop as described in 3.18.4.2.

Any plunger or cylinder head mechanical connector or connection shall conform to 3.18.2.1, 3.18.2.4, 3.18.4, and 3.18.5.

3.18.1.2 Roped-Hydraulic Elevator

(13)

3.18.1.2.1 The driving member of the hydraulic jack shall be vertical. Cars shall be suspended with not less than two suspension members per hydraulic jack in conformance with 2.15.13 and 2.20.

3.18.1.2.2 The roping ratio that relates the driving member of the hydraulic jack speed to the car speed shall not exceed 1:2.

3.18.1.2.3 Sheaves used to transfer load from the hydraulic jack to the car frame through wire ropes shall conform to 2.24.2, 2.24.3, and 2.24.5.

3.18.1.2.4 Means shall be provided to prevent the ropes, if slack, from leaving the sheave grooves.

3.18.1.2.5 A slack-rope device with an enclosed manually reset switch shall be provided that shall cause the electric power to be removed from the hydraulic machine pump motor and the control valves should any rope become slack.

3.18.1.2.6 The traveling sheave shall be attached with fastenings having a minimum factor of safety of 4, based upon the ultimate strength of the material used. The load to be used in determining the factor of safety shall be the resultant of the maximum tensions in the ropes leading from the sheave with the elevator at rest and with rated load in the car.

3.18.2 Plungers

3.18.2.1 Material. The plunger and connecting couplings for the plunger shall be of materials in accordance with 3.18.2.1.1 and 3.18.2.1.2.

3.18.2.1.1 Tensile, compressive, bending, and torsional loading shall have a factor of safety of not less than 5, based on ultimate strength.

3.18.2.1.2 Pressure loadings shall have a factor of safety not less than that calculated per 8.2.8.5.

3.18.2.2 Plunger Design. Plungers made of steel shall be designed and constructed in compliance with the applicable formula in 8.2.8.1 for calculation of elastic stability, bending, and external pressure. For other materials, the appropriate modulus of elasticity must be utilized.

Plungers subject to internal pressure shall also be designed and constructed in accordance with cylinder design formula in 8.2.8.2.

3.18.2.3 Plunger Connection

3.18.2.3.1 When the hydraulic jack is not subjected to eccentric loading, it shall

(a) carry in tension the weight of the plunger with a factor of safety not less than 4

(b) restrict total vertical movement to less than 20% of the buffer stroke, where vibration damping means are provided

3.18.2.3.2 In addition, when the hydraulic jack is subjected to eccentric loading, the following shall also apply:

(a) The plunger connection to the car shall also be so designed and constructed as to transmit the full eccentric moment into the plunger with a factor of safety not less than 4.

(b) The plunger and the plunger connection to the car shall also be so designed and constructed that the total vertical deflection of the loading edge of the car platform due to eccentric loading of the car shall not exceed 19 mm (0.75 in.).

3.18.2.4 Plunger Joints. Plungers composed of more than one section shall have joints designed and constructed to

(a) carry in tension the weight of all plunger sections below the joint with a factor of safety of not less than 4

(b) transmit in compression the gross load on the plunger with a factor of safety of not less than 5, based on ultimate strength

(c) withstand without damage any forces resulting from a plunger stop as described in 3.18.4.2

(d) for eccentric loading, the joints shall conform to 3.18.2.2 and 3.18.2.3

3.18.2.5 Plungers Subject to External Pressure. For plungers subjected to external pressure, the working pressure shall be not greater than indicated by the formula in 8.2.8.1.3.

3.18.2.6 Plunger Heads Subject to Fluid Pressure. Heads of plungers subject to fluid pressure shall conform to 3.18.3.6.

3.18.2.7 Plunger-Follower Guide

3.18.2.7.1 A plunger-follower guide shall be permitted to be used, provided it is arranged so that the elevator is always in a position where the unsupported length of the plunger conforms to the "maximum free length" as defined in 8.2.8.1. If this length is exceeded, upward movement of the car shall immediately stop, and it shall be permitted to allow the car to return non-stop to the lowest landing; power-operated doors shall open, and electric power shall be removed from the motor and the control valve. After not less than 15 s nor more than 60 s, the doors shall close in compliance with 2.11.3. A manual reset of the means shall be required before the elevator is returned to service. The in-car door open button shall remain operative.

Plunger-follower guides shall be designed and constructed to comply with all applicable requirements of 2.15.

3.18.2.7.2 Telescopic plungers shall have each plunger section internally guided. If more than two movable sections are used, external guides shall be provided for each plunger section. External guides shall be

designed and constructed to comply with all applicable requirements of 2.15.

3.18.3 Cylinders

3.18.3.1 Material. The cylinder and connecting couplings for the cylinder shall be made of materials in compliance with 3.18.3.1.1 and 3.18.3.1.2.

3.18.3.1.1 For tensile, compressive, bending, and torsional loading, the cylinder and connecting couplings shall have a factor of safety of not less than 5, based on ultimate strength.

3.18.3.1.2 For pressure calculations, the cylinder and connecting coupling shall have a factor of safety not less than that calculated as specified in 8.2.8.5.

3.18.3.2 Cylinder Design. Cylinders shall be designed and constructed in accordance with the formula in 8.2.8.2.

3.18.3.3 Clearance at Bottom of Cylinder. Clearance shall be provided at the bottom of the cylinder so that the bottom of the plunger will not strike the safety bulkhead of the cylinder when the car is resting on its fully compressed buffer (see 3.22.1).

3.18.3.4 Safety Bulkhead. Cylinders buried in the ground shall be provided with a safety bulkhead having an orifice of a size that would permit the car to descend at a speed not greater than 0.075 m/s (15 ft/min), nor less than 0.025 m/s (5 ft/min). A space of not less than 25 mm (1 in.) shall be left between the welds of the safety bulkhead and the cylinder head. Safety bulkheads shall conform to 3.18.3.6.

A safety bulkhead shall not be required where a double cylinder is used and where both inner and outer cylinders conform to 3.18.3.

3.18.3.5 Cylinder Packing Heads. Cylinder packing heads shall conform to appropriate requirements of 3.18.4 and 8.2.8.3.

3.18.3.6 Closed Cylinder and Plunger Heads. Closed heads of cylinders, and heads of plungers subject to fluid pressure, shall conform to 3.18.3.6.1 through 3.18.3.6.3.

3.18.3.6.1 Closed Cylinder Heads. Closed heads of cylinders shall be only of dished seamless construction, concave to pressure, except if the bottom of the cylinder is supported, and if the cylinder is not buried.

3.18.3.6.2 Design Formulas. They shall be designed and constructed in accordance with the applicable formulas in 8.2.8.3, provided that steel heads shall in no case have a thickness less than that required for the adjoining shell.

3.18.3.6.3 Dished Seamless Heads, Convex to Pressure. Dished seamless heads, convex to pressure, if used on plungers, shall have a maximum allowable working pressure of not more than 60% of that for heads

of the same dimensions with pressure on the concave side.

3.18.3.7 Collection of Oil Leakage. Means shall be provided to collect for removal any oil leakage from the cylinder head seals or packing gland. The amount collected before removal shall not exceed 19 L (5 gal).

3.18.3.8 Cylinders Buried in the Ground

3.18.3.8.1 Cylinders buried in the ground shall be protected from corrosion due to galvanic or electrolytic action, salt water, or other underground conditions.

3.18.3.8.2 The methods specified in 3.18.3.8.3 shall be considered as acceptable, provided that they

(a) are designed and installed with means for monitoring and maintaining them in accordance with accepted industry practices applicable to the methods

(b) are effective for specific conditions where the cylinder is installed

(c) provide means for checking ongoing compliance with 3.18.3.8.1

(13) **3.18.3.8.3** Cylinders buried in the ground shall be provided with protection from corrosion by one or more of the following methods:

(a) the cylinder shall be constructed of a material that is immune to the stated conditions

(b) the cylinder shall be completely covered or encased in a material that completely surrounds the exterior surface and is immune to the stated conditions. If the space between the protective casing and the cylinder is empty, the casing must be designed to withstand a static head of water from ground level to the bottom of the cylinder, based on the manufacturer's rating of the material used

(c) the cylinder shall be protected by a monitored cathodic protection system

(d) the cylinder shall be protected by a means that will provide an immunity level not less than that provided by the above methods for the stated conditions.

3.18.3.9 Means for Relief of Air or Gas. Cylinders shall be provided with a means to release air or other gas.

3.18.4 Plunger Stops

3.18.4.1 Metal Stops and/or Other Means. Metal stops and/or other means shall be provided at one end of the plunger and at the packing head end of the cylinder to prevent the plunger from traveling beyond the limits of the cylinder.

The metal stops and/or other means shall be so designed and constructed as to stop the plunger traveling in the up direction at maximum speed under full load pressure, should the normal terminal stopping device (see 3.25.1) fail to operate, or at a reduced speed when a terminal speed-reducing device is provided as required by 3.25.2. No running test onto the stop ring is required [see 8.10.3.2.2(s)].

3.18.4.2 Hydraulic System. The connections to the hydraulic machine, plunger, plunger connection, couplings, plunger joints, cylinder, cylinder connecting couplings, or any other parts of the hydraulic system shall be designed and constructed to withstand, without damage, a plunger stop in accordance with 3.18.4.1.

3.18.5 Welding

All welding of hydraulic jack components shall conform to 8.8.

3.18.6 Marking of Hydraulic Jack

(13)

The hydraulic jack shall be permanently and legibly marked. The marking shall be visible after installation. The letters and symbols shall be stamped, etched, cast, or otherwise applied with depressed or raised letters and symbols not less than 3 mm (0.125 in.) in height with the following information:

(a) the name or trademark by which the organization that manufactured the hydraulic jack can be identified

(b) the manufacturer's designation of the type or model

(c) year of manufacture

SECTION 3.19 VALVES, PRESSURE PIPING, AND FITTINGS

3.19.1 Materials and Working Pressures

3.19.1.1 Materials. Pressure piping, valves, fittings, and mufflers shall be designed and made of materials having properties such that a factor of safety not less than that calculated per 8.2.8.5 is achieved.

Piping and fittings of a grade not subjected to listed/certified testing (ASTM or equivalent) shall not be used for hydraulic pressure piping and fittings.

NOTE (3.19.1.1): Examples of two acceptable pipe standards are ASTM A106 and ASTM A53, Type E or S.

3.19.1.2 Working Pressures. The working pressure (see 1.3) shall not exceed the component rated pressure (see 1.3) of the pipes, valves, mufflers, and fittings used on the pressure side of the hydraulic system.

3.19.1.3 Component Proof Test. For elongations greater than or equal to 10%, the component design shall be substantiated either in accordance with 8.2.8.5 or by an unrestrained proof test of 5 times the component rated pressure without resulting in fracture. For elongations of less than 10%, the test value shall be 1.5 times the value indicated by 8.2.8.5 multiplied by the component rated pressure.

3.19.1.4 Component Markings. Valves, fittings, and mufflers shall be pressure rated, and shall bear the manufacturer's name or trademark by which the organization that manufactured the product can be identified, and identification symbols to indicate the materials and

service designations for which the manufacturer's rating applies.

NOTE: Valves and fittings rated for a different system may be used in hydraulic elevator systems when substantiated in accordance with the elevator code.

3.19.2 Pressure Piping

3.19.2.1 Wall Thickness. The minimum wall thickness shall conform to 8.2.8.4.

3.19.2.2 Threading. Pipe lighter than Schedule 40 shall not be threaded.

3.19.2.3 Pipe Supports. Piping shall be so supported as to eliminate undue stresses at joints and fittings, particularly at any section of the line subject to vibration.

3.19.2.4 Pipe, Tubing, or Fittings. Pipe, tubing, or fittings shall be permitted to be used for instrument or control purposes and shall conform to ASME B31.1, para. 122.3.

(13) **3.19.2.5 Pressure Gauge Fittings.** A pressure gauge fitting shall be provided on jack side of the check valve or immediately adjacent to the hydraulic control valve. When a pressure gauge is permanently installed, a shut-off means shall be provided to protect the gauge. Where the hydraulic machine is located in the hoistway, the pressure gauge fittings shall only be accessible to elevator personnel from outside the hoistway (see 8.1).

(13) **3.19.2.6 Hydraulic Pipeline Identification.** A marking shall be applied, to accessible piping that is located outside the elevator machine room or hoistway, stating "Elevator Hydraulic Line" in letters that are at least 19 mm (0.75 in.) high in a contrasting color. The marking shall be visible after installation and applied at intervals not greater than 3 000 mm (120 in.).

(13) **3.19.2.7** Where the hydraulic machine is located in the hoistway and any piping, tubing, or fitting permitted by 3.19.2.4 is located outside the hoistway, means shall be provided to

(a) protect the specified piping, tubing, or fittings from damage, which would cause unsafe elevator operation; or

(b) prevent uncontrolled movement of the elevator in the event of failure of the specified piping, tubing, or fittings.

(13) **3.19.2.8** Where the pressure piping is outside the machine room, machinery space, or hoistway, the pressure piping shall be protected from external damage. Where the pressure piping is buried underground or extends beyond the building containing the hydraulic machine or machine room, the elevator shall be fitted with at least one of the following:

(a) a car safety conforming to 3.17.2

(b) an overspeed valve(s) conforming to 3.19.4.7

(c) a plunger gripper(s) conforming to 3.17.3

3.19.3 Connections and Fittings

3.19.3.1 Connections. All piping connections shall be of the welded, grooved, threaded, or bolted flange type. Threads of valves, piping, and fittings shall conform to the requirements of ASME B1.20.1 or ASME B1.20.3. Hydraulic tube fittings shall conform to SAE J514.

3.19.3.2 Grooved Pipe Fittings

3.19.3.2.1 Grooved pipe fitting assemblies shall be permitted to be used for hydraulic connections. They shall be installed in conformance with the manufacturer's specifications. They shall be installed in locations that will permit disassembly and inspection of all of their component parts.

3.19.3.2.2 Grooved pipe fittings shall be so designed and constructed that failure of a sealing element will not permit separation of the parts connected. The devices or means used for preventing the separation of the parts connected shall be removable only with the use of tools. Devices or means removable with hand-operated quick-release levers or toggles are prohibited.

3.19.3.3 Flexible Hydraulic Connections. Flexible hose and fitting assemblies, and flexible couplings, shall be permitted to be used for hydraulic connections. Where installed between the check valve or control valve and the cylinder, they shall conform to 3.19.3.3.1 and 3.19.3.3.2.

3.19.3.3.1 Flexible hose and fitting assemblies shall

(a) not be installed within the hoistway, nor project into or through any wall. Installation shall be accomplished without introducing any twist in the hose, and shall conform with the minimum bending radius of SAE 100, R2 type, high pressure, steel wire reinforced, rubber-covered hydraulic hose specified in SAE J517.

(b) have a bursting strength sufficient to withstand not less than 10 times working pressure (see 1.3). They shall be tested in the factory or in the field prior to installation at a pressure of not less than 5 times working pressure and shall be marked with date and pressure of test.

(c) conform to the requirements of SAE 100, R2 type hose specified in SAE J517 and be compatible with the fluid used.

(d) be of nonreusable-type fittings.

(e) be permanently labeled/marked, indicating

(1) the name or trademark by which the manufacturer of the hose and fittings can be identified

(2) the type of hose and fitting

(3) the minimum factory test pressure

(4) the minimum bending radius of hose

- (5) the date of installation
- (6) the inspection procedure
- (7) the name of elevator contractor
- (f) have a line overspeed valve conforming to 3.19.4.7.

3.19.3.3.2 Flexible couplings are permitted for hydraulic connections. Such couplings shall be so designed and constructed that failure of the sealing element will not permit separation of the connected parts. The devices or means used to prevent the separation of the connected parts shall be removable only with the use of tools. Any devices or means that are removable with hand-operated quick-released levers are prohibited.

3.19.4 Valves

3.19.4.1 Shutoff Valve. A manually operated shutoff valve shall be provided between the hydraulic machines and the hydraulic jack and shall be located outside the hoistway and adjacent to the hydraulic machine.

Where the hydraulic machine is located in the hoistway, the manually operated shutoff valve shall be permitted to be located inside the hoistway, provided that it is accessible from outside the hoistway to elevator personnel only (see 8.1).

3.19.4.2 Pump Relief Valve

3.19.4.2.1 Each pump or group of pumps shall be equipped with one or more relief valve(s) conforming to the following requirements:

(a) *Type and Location.* The relief valve shall be located between the pump and the check valve and shall be of such a type and so installed in the bypass connection that the valve cannot be shut off from the hydraulic system.

(b) *Size.* The size of the relief valve and bypass shall be sufficient to pass the maximum rated capacity of the pump without raising the pressure more than 50% above the working pressure. Two or more relief valves shall be permitted to be used to obtain the required capacity.

(c) *Sealing.* Relief valves shall be sealed after being set to the correct pressure.

3.19.4.2.2 No relief valve is required for centrifugal pumps driven by induction motors, provided the shut-off, or maximum pressure that the pump can develop, is not greater than 135% of the working pressure at the pump.

3.19.4.3 Check Valve. A check valve shall be provided and shall be so installed that it will hold the elevator car with rated load at any point when the pump stops and the down valves are closed or the maintained pressure drops below the minimum operating pressure.

3.19.4.4 Manual Lowering Valve. A manually operated valve, located on or adjacent to the control valves,

shall be provided and identified, which permits lowering the car at a speed not exceeding 0.10 m/s (20 ft/min). This valve shall be so marked to indicate the lowering position. Where the hydraulic machine is located in the hoistway, the manual lowering valve shall only be accessible to elevator personnel from outside the hoistway (see 8.1).

3.19.4.5 Reserved for Future Use (13)

3.19.4.6 Type Tests, Certification, and Marking Plates for Control Valves

3.19.4.6.1 Each type or model and make of hydraulic control valve shall be subjected to the engineering tests and to the certification process as specified in 8.3.5.

3.19.4.6.2 Hydraulic control valves shall be plainly marked in a permanent manner with the following information: (13) (ED)

(a) certifying organization's name or identifying symbol

(b) the name, trademark, or file number by which the organization that manufactured the product can be identified

(c) statement of compliance with ASME A17.1/CSA B44

(d) type designation

(e) component rated pressure

3.19.4.6.3 The electrical coil data shall be marked on each individual coil (13)

3.19.4.7 Overspeed Valves. When provided, overspeed valves and their connections and attachments shall conform to 3.19.4.7.1 through 3.19.4.7.6.

3.19.4.7.1 Overspeed Valve Tests. Each type or model of overspeed valve shall be subjected to the engineering tests specified in 8.3.9.

3.19.4.7.2 Marking of Overspeed Valves. The overspeed valves shall be plainly marked in a permanent manner with the following:

(a) the name or trademark by which the organization that manufactured the product can be identified

(b) type designation

(c) component rated pressure

(d) maximum and minimum rated flow

3.19.4.7.3 Installation of Overspeed Valves. Overspeed valves shall be installed and mounted as follows:

(a) *Single Jack Arrangements.* Where a single valve is used, it shall be located in the pressure piping within 300 mm (12 in.) of the hydraulic jack. Multiple parallel valves are permitted in lieu of a single valve. These shall be located so as to minimize the distance from the valves to the hydraulic jack.

(b) *Multiple Jack Arrangements.* Multiple jack arrangements shall conform with one of the following:

(1) A single overspeed valve shall be located in the pressure piping within 300 mm (12 in.) of each hydraulic jack. Multiple parallel valves are permitted in lieu of single valves at each hydraulic jack. These shall be located so as to minimize the distance from the valves to each hydraulic jack.

(2) A single overspeed valve shall be located in the pressure piping on the hydraulic machine side of, and immediately before, the tee junction, wye junction, or branch junction that connects the branch pressure pipes to the jacks. Multiple parallel valves are permitted in lieu of a single valve at the junction. For dual hydraulic jack systems, the total length of branch pressure pipe between the tee or wye junction and the jacks shall not exceed the distance between the jacks, measured horizontally, plus 1 m (39 in.). For multiple jack systems, the length of branch pressure piping shall be minimized.

3.19.4.7.4 Strength of Overspeed Valve Pressure Piping and Fittings Between the Overspeed Valve and the Jacks. The factor of safety of the overspeed valve pressure piping and fittings shall be not less than 1.5 times the value obtained using 8.2.8.5, provided that the minimum factor of safety is not less than 4.5, and the minimum percentage elongation is not less than 5 for the overspeed valve and fittings and not less than 20 for the pressure piping.

3.19.4.7.5 Performance Requirements. The overspeed valve shall be constructed, installed, and adjusted to ensure that the elevator obtains the following performance:

(a) The overspeed valve tripping speed shall be not less than 110% nor greater than 140% of the elevator operating speed in the down direction, but in no case shall exceed 0.3 m/s (60 ft/min) above the rated elevator speed.

(b) The average deceleration rate shall be not less than 1.96 m/s^2 (6.44 ft/s²) nor more than 9.81 m/s^2 (32.2 ft/s²).

(c) Any peak deceleration rate in excess of 24.53 m/s^2 (80.5 ft/s²) shall have a duration of not greater than 0.04 s.

3.19.4.7.6 Sealing of the Overspeed Valve. Field-adjustable overspeed valves shall be sealed after field setting.

3.19.5 Piping Buried in the Ground

3.19.5.1 Protection. Piping buried in the ground shall be provided with protection from corrosion by one or more of the following methods:

(a) monitored cathodic protection

(b) a coating to protect the piping from corrosion that will withstand the installation process

(c) a protective casing, immune to galvanic or electrolytic action, salt water, and other known underground conditions, completely surrounding the exterior surfaces of the piping

3.19.5.2 Seals. Piping buried in the ground shall not include seals or other elements potentially requiring service or replacement.

3.19.6 Welding

3.19.6.1 All welding of valves, pressure piping, and fittings shall conform to 8.8.

3.19.6.2 Field welding of pressure piping and fittings shall also be permitted to be performed by welders certified to the requirements pertaining to pressure systems.

3.19.7 Electrical Requirements

Hydraulic control valves shall conform to the electrical requirements in Clause 4 of CSA C22.2 No. 139.

SECTION 3.20 ROPES AND ROPE CONNECTIONS

Where a counterweight is provided, the counterweight shall be connected to the car by not less than two steel wire ropes.

The wire ropes and their connections shall conform to 2.20, except that the factor of safety of the wire ropes shall be not less than 7.

SECTION 3.21 COUNTERWEIGHTS

3.21.1 Counterweights

Counterweights, where provided, shall conform to 2.21. In the event of the separation of the counterweight from the car, the static pressure shall be not more than 140% of the working pressure.

3.21.2 Counterweight Sheaves

Sheaves for counterweight ropes shall conform to 2.24.2, 2.24.3, and 2.24.5.

SECTION 3.22 BUFFERS AND BUMPERS

3.22.1 Car Buffers or Bumpers

Car buffers or bumpers shall be provided and shall conform to 2.22, provided that in applying the requirements of 2.22 to hydraulic elevators 3.22.1.1 through 3.22.1.5 are complied with.

3.22.1.1 The term "operating speed in the down direction with rated load" shall be substituted for the words "rated speed" wherever these words appear.

3.22.1.2 In place of 2.22.3.2, the requirements specified in 3.22.1.2.1 and 3.22.1.2.2 shall be substituted.

3.22.1.2.1 Buffers shall be capable of withstanding without being compressed solid the loading per 8.2.3.2.

3.22.1.2.2 Buffers shall be compressed solid with a loading of 2 times that described in 8.2.3.2.

3.22.1.3 Requirement 2.22.4.1.2 shall not apply. Reduced stroke buffers shall not be provided on hydraulic elevators. Car buffers or bumpers shall be so located that the car will come to rest on the bumper or fully compressed buffer, or to a fixed stop, before the plunger reaches its down limit of travel.

3.22.1.4 When multiple buffers are used, each shall be identical and designed for an equal proportion of the loading described in 3.22.1.2.

3.22.1.5 Plunger weight, less buoyant effects of the plungers at the buffer strike point, shall be added, if applicable, and used in buffer calculations.

3.22.1.6 Solid bumpers are permitted on hydraulic elevators having an operating speed in the down direction of 0.25 m/s (50 ft/min) or less. See 2.22.2 for solid bumper material.

3.22.2 Counterweight Buffers

Where counterweights are provided, counterweight buffers shall not be provided. (See 3.4.6 for required counterweight runby.)

SECTION 3.23 GUIDE RAILS, GUIDE-RAIL SUPPORTS, AND FASTENINGS

3.23.1 Direct-Acting Hydraulic Elevators

Guide rails, guide-rail supports, and their fastenings shall conform to 2.23, with the exceptions specified in 3.23.1.1 through 3.23.1.4.

3.23.1.1 Requirement 2.23.4.1 shall apply only where car safeties are used and the maximum load on the car side for direct-acting hydraulic elevators is the maximum weight of the car and its rated load plus the weight of the plunger or cylinder as applicable.

3.23.1.2 Requirement 2.23.4.2 shall apply only where safeties are used.

3.23.1.3 Requirement 2.23.9.1.1(a) shall apply only where safeties are used.

3.23.1.4 Requirement 2.28 shall not apply.

3.23.2 Roped-Hydraulic Elevators

3.23.2.1 Car and counterweight guide rails, guide-rail supports, and their fastenings shall conform to 2.23.

3.23.2.2 The traveling sheave, if provided, shall be guided by means of suitable guide shoes and guide rails adequately mounted and supported.

SECTION 3.24 HYDRAULIC MACHINES AND TANKS

3.24.1 Hydraulic Machines (Power Units)

3.24.1.1 Marking Plate. The working pressure that is developed in the system shall be measured at the acceptance inspection and test. This pressure shall be labeled/marked on a marking plate. The marking plate shall be mounted permanently on the hydraulic machine. The marking plate shall be of such material and construction that it is permanent and readily legible. The letters and symbols shall be stamped, etched, cast, or otherwise applied with a height not less than 3 mm (0.125 in.). (13)

3.24.2 Tanks

3.24.2.1 Capacity. Tanks shall be of sufficient capacity to provide for an adequate liquid reserve in order to prevent the entrance of air or other gas into the system.

3.24.2.2 Minimum Level Indication. The permissible minimum liquid level shall be clearly indicated.

3.24.3 Atmosphere Storage and Discharge Tanks

3.24.3.1 Covers and Venting. Tanks shall be covered and suitably vented to the atmosphere. Where tanks are located in the hoistway, they shall be vented to prevent accumulation of fumes in the hoistway and their covers shall be of sufficient strength to resist falling objects.

3.24.3.2 Factor of Safety. Tanks shall be so designed and constructed that when completely filled, the factor of safety shall be not less than 4, based on the ultimate strength of the material.

3.24.3.3 Means for Checking Liquid Level. Tanks shall be provided with means for checking the liquid level. Such means shall be accessible without the removal of any cover or other part.

3.24.4 Welding

All welding of hydraulic machine components shall conform to 8.8.

SECTION 3.25 TERMINAL STOPPING DEVICES

3.25.1 Normal Terminal Stopping Devices

3.25.1.1 Where Required and Function. Upper and lower normal terminal stopping devices shall be provided and arranged to detect the position of the car and cause the car to slow down and stop automatically, at or near the top and bottom terminal landings, with any (13)

load up to and including rated load in the car from any speed attained in normal operation. The normal terminal stopping device shall function independently of the operation of the normal stopping means and the terminal speed-reducing device, where provided, such that the failure of the normal stopping means and/or the failure of the terminal speed-reducing device, where provided, shall not prevent the normal terminal stopping device from functioning as specified except

(a) a common actuating means (e.g., a cam, etc.) that is not physically part of the position sensing devices shall be permitted for the actuation of the position sensing device of the normal terminal stopping device and the position sensing device of

(1) the normal stopping means, and/or

(2) the terminal speed-reducing device

(b) a common mounting means shall be permitted for the position sensing device of the normal terminal stopping device and the position sensing device of

(1) the normal stopping means, and/or

(2) the terminal speed-reducing device

The device shall be so designed and installed that it will continue to function until the car reaches its extreme limits of travel.

The device shall be permitted to be rendered inoperative during recycling operation (see 3.26.7).

3.25.1.2 Location of Stopping Devices. Stopping devices shall be located on the car, in the hoistway, in the machine room or control room, or in overhead spaces, and shall be operated by movement of the car.

3.25.1.3 Requirements for Stopping Devices on the Car or in the Hoistway. Stopping devices located on the car or in the hoistway and operated by cams on the car or in the hoistway shall conform to 2.25.1.

3.25.1.4 Requirements for Stopping Devices in a Machine Room, Control Room, or Overhead Space. Stopping devices located in a machine room, control room, or in an overhead space shall conform to 2.25.2.3, except that the device required by 2.25.2.3.2 shall cause the electric power to be removed from the main control valve or from its control switch operating magnets and, in the case of electrohydraulic elevators, where stopping the car is effected by stopping the pump motor, from the pump motor and associated valves.

3.25.2 Terminal Speed-Reducing Devices

3.25.2.1 Where Required. Terminal speed-reducing devices shall be installed for the up direction where the car speed exceeds 0.25 m/s (50 ft/min), to ensure that the plunger does not strike its solid limit of travel at a speed in excess of 0.25 m/s (50 ft/min) (see 3.18.4.1).

3.25.2.2 General Requirements. Terminal speed-reducing devices shall conform to 3.25.2.2.1 and 3.25.2.2.2.

3.25.2.2.1 They shall operate by mechanical, hydraulic, or electrical means independently of the normal terminal stopping device and function to reduce the speed of the car if the normal terminal stopping device fails to cause the car to slow down at the top terminal as intended such that the failure of the normal terminal stopping device shall not prevent the terminal speed-reducing device from functioning as specified except

(a) a common actuating means (e.g., a cam, etc.) that is not physically part of the position sensing devices shall be permitted for the actuation of both the position sensing device of the terminal speed-reducing device and the position sensing device of the normal terminal stopping device

(b) a common mounting means shall be permitted for the position sensing devices of the terminal speed-reducing device and the normal terminal stopping device

3.25.2.2.2 They shall provide retardation not in excess of 9.81 m/s² (32.2 ft/s²).

3.25.2.2.3 They shall be so designed and installed that a single short circuit caused by a combination of grounds or by other conditions shall not render the device ineffective.

3.25.2.3 Requirements for Mechanical or Hydraulic Means. Where the terminal speed-reducing devices are implemented by mechanical or hydraulic means, a means shall be provided to prevent overheating of the drive system (pump and motor). The mechanical or hydraulic means shall not cause permanent deformation to any part upon which the means act.

3.25.2.4 Requirements for Electrical Means. Where the terminal speed-reducing devices are implemented by electrical means, they shall conform to 3.25.2.4.1 through 3.25.2.4.5.

3.25.2.4.1 They shall be so designed and installed that a single short circuit caused by a combination of grounds or by other conditions shall not render the device ineffective.

3.25.2.4.2 Where magnetically operated, optical, or solid-state devices are used for position sensing, a single short circuit caused by a combination of grounds or by other conditions, or the failure of any single magnetically operated, optical, or solid-state device, shall not

(a) render the terminal speed-reducing device inoperative

(b) permit the car to restart after a normal stop

3.25.2.4.3 Mechanically operated switches, where located on the car or in the hoistway, shall conform to the following:

(a) be operated by the movement of the car

(b) have metal operating cams

(c) have contacts that are positively opened mechanically

(d) be of the enclosed type

(e) be securely mounted in such a manner that horizontal movement of the car shall not affect operation of the device

3.25.2.4.4 Electrohydraulic elevators with two means to control upward movement (e.g., pump motor and valve) shall conform to the following:

(a) One or both means to control upward movement of the elevator shall be controlled by the terminal speed-reducing device, either directly or through an intermediate device.

(1) Where an intermediate device is implemented with a solid-state device or software system to satisfy 3.25.2.4.4(a), the failure of any single solid-state device or a software system failure in the intermediate device shall not render the terminal speed-reducing device ineffective.

(2) Redundant devices used to satisfy 3.25.2.4.4(a)(1) shall be checked prior to each start of the elevator from a landing, when on automatic operation. When a failure as specified occurs the car shall not be permitted to restart.

(b) The other means or both means to control upward movement of the elevator are to be controlled by the normal terminal stopping device, either directly or through an intermediate device.

3.25.2.4.5 Electrohydraulic elevators with one means to control upward movement (e.g., pump motor only). One or both of the devices required in 3.26.6.4(a) shall be controlled by the terminal speed-reducing device and the other device or both devices by the normal terminal stopping device.

3.25.3 Final Terminal Stopping Devices

Final terminal stopping devices are not required.

SECTION 3.26 OPERATING DEVICES AND CONTROL EQUIPMENT

3.26.1 Operating Devices and Control Equipment

Operating devices and control equipment shall conform to 2.26, except as modified by the following:

- (a) Requirement 2.26.1.3 does not apply.
- (b) Requirement 2.26.1.4 applies as specified by 3.26.2.
- (c) Requirement 2.26.1.6 applies as specified by 3.26.3.
- (d) Requirement 2.26.2 applies as specified by 3.26.4.
- (e) Requirement 2.26.6 does not apply.
- (f) Requirement 2.26.8 does not apply.
- (g) Requirements 2.26.9.1, 2.26.9.2, 2.26.9.5, 2.26.9.6, and 2.26.9.7 do not apply.
- (h) Requirement 2.26.10 does not apply.

3.26.2 Inspection Operation

Top-of-car operating devices shall be provided and shall conform to 2.26.1.4. In-car and those inspection operations conforming to 2.26.1.4.4 shall be permitted.

The bottom normal terminal stopping device shall be permitted to be made ineffective while the elevator is under the control of the inspection operation device.

3.26.3 Anticreep and Leveling Operation

3.26.3.1 Anticreep Operation. Each elevator shall be provided with an anticreep operation to correct automatically a change in car level. It shall conform to 2.26.1.6.2 and 2.26.1.6.3, and 3.26.3.1.1 through 3.26.3.1.5.

3.26.3.1.1 The anticreep device shall operate the car at a speed not exceeding 0.125 m/s (25 ft/min).

3.26.3.1.2 The anticreep device shall maintain the car within 25 mm (1 in.) of the landing, irrespective of the position of the hoistway door.

3.26.3.1.3 For electrohydraulic elevators, the anticreep device shall be required to operate the car only in the up direction.

3.26.3.1.4 Operation dependent on the availability of the electric power supply is permitted, provided that

(a) the mainline power disconnecting means is kept in the closed position at all times except during maintenance, repairs, and inspection

(b) a sign is placed on the switch stating, "KEEP SWITCH CLOSED EXCEPT DURING MAINTENANCE, REPAIRS, AND INSPECTIONS"

(c) the sign shall be made of durable material and securely fastened and have letters with a height of not less than 6 mm (0.25 in.)

3.26.3.1.5 Only the following, when activated, shall prevent operation of the anticreep device:

- (a) the electrical protective devices listed in 3.26.4.1
- (b) recycling operation (see 3.26.7)
- (c) inspection transfer switch
- (d) hoistway access switch
- (e) low oil protection means (see 3.26.9)
- (f) oil tank temperature shutdown (see 3.26.5 and 3.26.6.5)

3.26.3.2 Operation in Leveling or Truck Zone. Operation of an elevator in a leveling or truck zone at any landing by a car-leveling or truck-zoning device, when the hoistway doors, or the car doors or gates, or any combination thereof, are not in the closed position, is permissible, subject to the requirements of 2.26.1.6.1 through 2.26.1.6.5. A leveling or truck-zoning device shall operate the car at a speed not exceeding 0.125 m/s (25 ft/min).

3.26.4 Electrical Protective Devices

Electrical protective devices shall be provided in conformance with 2.26.2, and the following requirements, except the words “driving-machine motor and brake” in 2.26.2 shall be replaced with “hydraulic machine,” and shall conform to 3.26.4.1 and 3.26.4.2.

3.26.4.1 When in the open position, the electrical protective devices shall prevent operation by all operating means, except as specified in 3.26.4.2.

3.26.4.2 When in the open position, the following devices shall initiate removal of power from the hydraulic machine in such a manner as to produce an average deceleration rate not greater than 9.8 m/s^2 (32.2 ft/s^2) and shall prevent operation by all operating means except the anticreep device:

(a) emergency stop switches, where required by 2.26.2.5

(b) broken rope, tape, or chain switches provided in connection with normal stopping devices, when such devices are located in the machine room, control room, or overhead space

(c) hoistway door interlocks or hoistway door contacts

(d) car door or gate electric contacts; or car door interlocks

(e) hinged car platform sill electric contacts

(f) in-car stop switch, where required by 2.26.2.21

3.26.5 Phase Reversal and Failure Protection

Hydraulic elevators powered by a polyphase AC motor shall be provided with the means to prevent overheating of the drive system (pump and motor) due to phase rotation reversals or failure.

3.26.6 Control and Operating Circuits

The design and installation of the control and operating circuits shall conform to 3.26.6.1 and 3.26.6.2.

3.26.6.1 Springs, where used to actuate switches, contactors, or relays to stop an elevator at the terminals or to actuate electrically operated valves, shall be of the compression type.

3.26.6.2 The completion or maintenance of an electric circuit shall not be used to interrupt the power to the control valve, or to the pump driving motor of electrohydraulic elevators, or both under the following conditions:

(a) to stop the car at the terminals

(b) to stop the car when any of the electrical protective devices operate

3.26.6.3 For electrohydraulic elevators where there are two means of controlling upward movement of the elevator (e.g., a pump motor and a valve), at least one means shall be directly controlled by an electromechanical contactor or relay unless the terminal speed-reducing

device (see 3.25.2) directly removes power from one of the control means.

3.26.6.4 For electrohydraulic elevators where the only means of controlling upward movement of the elevator is the pump motor, the pump motor control shall conform to the following:

(a) Two devices shall be provided to remove power independently from the pump motor. At least one device shall be an electromechanical contactor.

(b) The contactor shall be arranged to open each time the car stops.

(c) The electrical protective devices shall control both devices [see 3.26.6.4(a)] in accordance with 3.26.4.

3.26.6.5 In the pump motor controller for electrohydraulic elevators, when the occurrence of a single ground or the failure of any single magnetically operated switch, contactor, or relay; or any single solid-state device; or a software-system failure causes the liquid in the hydraulic driving machine to rise in temperature above its maximum operating temperature, the following shall occur:

(a) Power shall be removed from the hydraulic driving-machine motor.

(b) The hydraulic driving-machine motor shall not be permitted to restart.

(c) When the doors are closed, the car shall automatically be brought to the lowest landing and then operate in conformance to 3.26.9.2 and 3.26.9.3.

3.26.7 Recycling Operation for Multiple or Telescopic Plungers

Recycling operation shall permit the car to be lowered more than 25 mm (1 in.) below the bottom landing, but not require lowering in order to restore the relative vertical position of the multiple plunger sections, provided that

(a) the car is at rest at bottom landing

(b) the doors and gates are closed and locked

(c) no car calls are registered

(d) the speed during recycling does not exceed normal down leveling speed but in no case shall be more than 0.10 m/s (20 ft/min)

(e) normal operation cannot be resumed until car is returned to bottom landing and normal terminal stopping devices are restored to normal operation

3.26.8 Pressure Switch

When cylinders are installed with the top of the cylinder above the top of the storage tank, a pressure switch shall be provided in the line between the cylinder and the valve, which shall be activated by the loss of positive pressure at the top of the cylinder. The switch shall prevent automatic door opening and the operation of the lowering valve or valves. The door(s) shall be permitted to open by operation of the in-car open button(s), when the car is within the unlocking zone.

3.26.9 Low Oil Protection

3.26.9.1 A means shall be provided to render the elevator on normal operation inoperative if for any reason the liquid level in the tank falls below the permissible minimum. Suitable means include, but are not limited to, the following:

- (a) direct sensing of liquid level
- (b) a pump-run timer

Actuation of the means shall automatically bring the car down to the lowest landing, when the doors are closed.

3.26.9.2 When at the lowest landing, the doors shall comply with the following:

(a) For elevators with power-operated doors that automatically close, the door(s) shall open and shall initiate automatic closing within 15 s.

(b) For elevators with manual doors or with doors that do not automatically close, they shall be provided with a signal system to alert an operator to close the doors.

3.26.9.3 The car shall then shut down. The means shall require manual reset before returning the car to service. For elevators with power-operated doors, the in-car door open button(s) shall remain operative, but the doors shall not be able to be power-opened from the landing.

3.26.10 Auxiliary Power Lowering Operation

Where the auxiliary power supply is provided solely for the purpose of lowering the car, in the case of main power supply failure, the auxiliary lowering operation shall conform to 3.26.10.1 through 3.26.10.3.

3.26.10.1 Auxiliary lowering shall be permitted to be initiated, provided that all operating and control devices, including door open and close buttons, function as with normal power supply, except that the following devices shall be permitted to be bypassed or made inoperative:

- (a) landing and car floor registration devices (or call buttons)
- (b) devices enabling operation by designated attendant (hospital service, attendant operation)
- (c) devices initiating emergency recall operation to the recall level, unless otherwise specified in 3.27
- (d) "FIRE OPERATION" switch, unless otherwise specified in 3.27

3.26.10.2 When the auxiliary lowering operation has been initiated, the car shall descend directly to the lowest landing, except that the operating system shall be permitted to allow one or more intermediate stops, and then, after a predetermined interval, the car shall proceed to the lowest landing, provided the auxiliary power supply is of sufficient capacity to open and close doors at each intermediate stop.

3.26.10.3 If the car and landing doors are power operated, and if the auxiliary power supply is of adequate capacity, the doors shall open when the car stops at the lowest landing and shall close after a predetermined interval.

NOTE (3.26.10): For the main disconnect switch auxiliary contact, see ANSI/NFPA 70 and CSA-C22.1 requirements, where applicable (see Part 9).

SECTION 3.27 EMERGENCY OPERATION AND SIGNALING DEVICES

Emergency operation and signaling devices shall conform to 2.27, except as modified by the following: The requirements of 3.26.9 and 3.18.2.7 shall be modified when Phase I Emergency Recall Operation and Phase II Emergency In-Car Operation are in effect, as specified in 3.27.1 through 3.27.4. The requirements of 2.27.3.2.1(b) and 2.27.3.2.2(b) shall be modified to include a machinery space containing a hydraulic machine.

3.27.1 Phase I Emergency Recall Operation After Device Actuation

If Phase I Emergency Recall Operation is activated while the elevator is responding to any of the following devices, the car shall return to the recall level:

- (a) low oil protection (see 3.26.9)
- (b) plunger-follower guide protection, provided the car is capable of being moved (see 3.18.2.7)
- (c) auxiliary power lowering (see 3.26.10)
- (d) oil tank temperature shutdown (see 3.26.6.5)

If the elevator is incapable of returning to the recall level, the car shall descend to an available floor. Upon arrival, automatic power-operated doors shall open, and then reclose within 15 s. The door open button(s) shall remain operative. The visual signal [2.27.3.1.6(h)] shall extinguish.

3.27.2 Phase I Emergency Recall Operation Prior to Device Actuation

If any of the devices specified in 3.27.1(a), (b), (c), or (d) is activated, while Phase I Emergency Recall Operation is in effect, but before the car reaches the recall level, the car shall do one of the following:

- (a) complete Phase I Emergency Recall Operation, if the car is above the recall level
- (b) descend to an available floor, if the car is below the recall level

Upon arrival, automatic power-operated doors shall open, and then reclose within 15 s. The door open button(s) shall remain operative. The visual signal [2.27.3.1.6(h)] shall extinguish.

3.27.3 Device Actuation at Recall Level

If any of the devices specified in 3.27.1(a), (c), or (d) is activated while the car is stationary at the recall level

and Phase I Emergency Recall Operation is in effect, the following shall apply:

- (a) automatic power-operated doors shall close within 15 s
- (b) the door open button(s) shall remain operational
- (c) the visual signal [see Fig. 2.27.3.1.6(h)] shall illuminate intermittently

3.27.4 Device Actuation With Phase II Emergency In-Car Operation in Effect

If any of the devices specified in 3.27.1(a), (b), (c), or (d) activate while the elevator is on Phase II Emergency In-Car Operation, a traveling car shall stop and all calls shall be canceled. The visual signal [see Fig. 2.27.3.1.6(h)] shall illuminate intermittently. The elevator shall accept calls only to landings below its location and respond in compliance with the requirements for Phase II Emergency In-Car Operation.

SECTION 3.28 LAYOUT DATA

3.28.1 Information Required on Layout Drawing

Elevator layout drawings shall, in addition to other data, indicate the following:

- (a) required clearances and basic dimensions
- (b) the bracket spacing (see 3.23)
- (c) the estimated maximum vertical forces on the guide rails on application of the safety, where provided (see 3.23)
- (d) in the case of freight elevators for Class B or Class C loading (see 2.16.2.2), the horizontal forces on the guide-rail faces during loading and unloading, and the estimated maximum horizontal forces in a post-wise

direction on the guide-rail faces on the application of the safety device, where provided (see 3.23)

- (e) the size and weight per meter (foot) of any rail reinforcement, where provided (see 3.23)
- (f) the impact loads imposed on machinery and sheave beams, supports, and floors or foundations (see 2.9)
- (g) the impact load on buffer supports due to buffer engagement at the maximum permissible load and operating speed in the down direction (see 8.2.3)
- (h) the net vertical load from the elevator system, which includes the total car weight and rated load; plunger, cylinder, and oil; and any structural supports
- (i) the outside diameter and wall thickness of the cylinder, plunger, and piping, and the working pressure
- (j) the total static and dynamic loads from the governor, ropes, and tension system
- (k) rated speed and operating speed in the down direction

(l) the minimum "grade" of pipe (ASTM or recognized standard) required to fulfill the installation requirements for pressure piping, or in lieu of a specific "grade" of pipe, the minimum tensile strength of pipe to be used for the installation (see 3.19)

- (m) the horizontal forces on the building structure stipulated by 2.11.11.8
- (n) the length of the plunger and cylinder
- (o) the clearance between the bottom of the plunger and the bottom head of the cylinder as required by 3.18.3.3

SECTION 3.29 IDENTIFICATION

Identification of equipment and floors shall conform to 2.29, as applicable.

Part 4

Elevators With Other Types of Driving Machines

SCOPE

Part 4 applies to elevators with other types of driving machines.

(a) Requirement 4.1 applies to rack-and-pinion elevators.

(b) Requirement 4.2 applies to screw-column elevators.

(c) Requirement 4.3 applies to hand elevators.

SECTION 4.1 RACK-AND-PINION ELEVATORS

This Section applies to an elevator with a car raised and lowered by a pinion(s) on a rack.

NOTE: See also Part 8 for additional requirements that apply to *rack-and-pinion elevators*.

4.1.1 Hoistways, Hoistway Enclosures, and Related Construction

Hoistways, hoistway enclosures, and related construction shall conform to Part 2, except 2.7 (see 4.1.2) and 2.8 (see 4.1.3).

4.1.2 Machine Rooms and Machinery Spaces

4.1.2.1 Motors, electrical control equipment, and other equipment used in conjunction with the elevator shall be permitted to be located within the hoistway and/or on the car. If it is in a separate machine room and/or machinery space, it shall conform to 2.7.

4.1.2.2 In jurisdictions not enforcing NBCC, the controller shall be permitted to be located on the exterior of the hoistway wall or other approved location apart from the hoistway, elevator machine room, or elevator machinery space. A controller so located shall be available to and used only by inspectors, maintenance personnel, and repair personnel.

In jurisdictions enforcing NBCC, the controller shall be permitted to be located on the exterior of the hoistway wall or other approved location apart from the hoistway, elevator machine room, or elevator machinery space. If the controller is located outside the hoistway, machine room, and machinery spaces, it shall be made accessible only to elevator personnel.

4.1.2.3 A rack-and-pinion machine and its controls, if located on the car, shall be protected by a noncombustible enclosure to prevent accidental contact.

Openwork noncombustible enclosure material shall be permitted to be used for rack-and-pinion machines located on top of the car, provided the openwork material rejects a ball 50 mm (2 in.) in diameter.

4.1.2.4 Access shall be provided to the rack-and-pinion machine for maintenance. Access panels to rack-and-pinion control equipment located in the car shall be provided with an electric contact and lock. The access panel shall be kept closed and locked. The electric contact shall be designed to prevent operation of the rack-and-pinion machine when the access panel is open. The lock shall not be operable by a key that will operate locks or devices for other purposes in the building. The key shall be available to, and used only by, inspectors, maintenance personnel, and repair personnel (see 8.1).

4.1.3 Equipment in Hoistways or Machine Rooms

Electrical equipment, wiring, pipes, and ducts in the hoistway shall conform to 2.8, except that the main feeder of a rack-and-pinion machine located on the car shall be permitted to be installed in the hoistway.

4.1.4 Supports and Foundations

The supports and foundations shall be designed to support all loads imposed by the elevator (including impact loading in the event of a safety application, stop by a speed-limiting device, or drive nut failure) in accordance with the building code. Allowable stresses for machinery and sheave beams or floors and their supports shall be in accordance with 2.9.4.

4.1.5 Emergency Doors

Emergency doors meeting the requirements of 2.11.1 shall be installed in the blind portion of the hoistway, except in elevators having a manually operated device that permits lowering the car at an automatically controlled speed to the nearest landing.

4.1.6 Car Enclosures, Car Doors and Gates, and Car Illumination

The car enclosure, car doors and gates, and car illumination shall conform to 2.14.

4.1.7 Car Frames and Platforms

The car frame and platform shall conform to the design and performance requirements of 2.15.

4.1.8 Capacity and Loading

The elevator shall conform to the capacity and loading requirements of 2.16.

4.1.9 Car Safeties and Speed Governor

The car shall be provided with a safety identified in 2.17.5 or a rack-and-pinion safety. The safety shall be attached to the car frame or supporting structure. All car safeties shall be mounted on a single car frame and shall operate on one pair of guide members or on one vertical rack.

The safety shall be located as required by 2.17.1, or if it is a rack-and-pinion safety, shall be permitted to be located above or in the car, provided that the members to which they are fixed are part of the car frame and are designed to withstand the forces imposed.

Rack-and-pinion safeties are safeties in which a freely rotating safety pinion, a governor, and a safety device shall be permitted to form an integral unit mounted in the car. The freely rotating pinion travels on a stationary rack mounted vertically on the hoist structure. The rotating pinion drives the governor. When the speed of the car reaches the tripping value, the rotating governor actuates the safety device that, in turn, brings the car to a gradual stop.

4.1.9.1 Stopping Distances. In jurisdictions not enforcing NBCC, stopping distances for rack-and-pinion safeties and the travel of the car measured from the governor tripping time to the full stop time shall not exceed the values based on rated speed given in Table 4.1.9.1.

In jurisdictions enforcing NBCC, stopping distances for rack-and-pinion safeties and the travel of the car measured from the governor tripping time to the full stop time shall not exceed the values based on rated speed given in Table 4.1.9.1. When calculating stopping distances, the kinetic energy from the driving unit shall be taken into account.

4.1.10 Counterweights

Counterweights, where provided, shall conform to 2.21.

4.1.11 Car Buffers

Buffers shall conform to 2.22. Kinetic energy from the drive unit shall be taken into account in the design calculations.

4.1.12 Guide Rails, Guide-Rail Supports, and Fastenings

Guide rails, guide-rail supports, and their fastenings shall conform to 2.23.

4.1.13 Rack-and-Pinion Driving Machine

Rack-and-pinion-type drives shall conform to 2.24 (except 2.24.1), and 4.1.13.1 through 4.1.13.6.

4.1.13.1 The rack-and-pinion drive shall consist of one or more power-driven rotating pinions mounted on the car and arranged to travel on a stationary rack mounted on the supporting structure. The drive shall have at least one pinion, one rack, and two backup rollers, which shall act on the same section of rack as the drive pinion. Driving machines utilizing a two-sided rack, where two drive pinions are located so that they are opposite each other and act as backup rollers, shall be deemed to have met this requirement.

4.1.13.2 The pinions and racks shall be of steel or of material having equivalent mechanical properties or better with a minimum factor of safety of 8 based on ultimate stress for the pinion and the rack. They shall be designed to conform to AGMA 218.01, including surface hardening and an assumption of a minimum of 200 000 life cycles.

4.1.13.3 All moving parts of the driving machine shall be properly protected with solid or perforated metal that will reject a ball of 13 mm (0.5 in.) diameter and shall be securely fastened.

4.1.13.4 The rack and pinion shall be so designed that the separation of the pinion from the rack in all directions in excess of 25% of the tooth depth of 6 mm (0.25 in.), whichever is the lesser, cannot occur. A guard shall be provided to prevent foreign material from lodging between the teeth, and clearance between the moving parts and the guard shall not exceed 5 mm (0.1875 in.).

4.1.13.5 Rack sections shall be fastened to the supporting structure with a factor of safety of 5 based on ultimate stress, and with dowels at each joint.

4.1.13.6 The manufacturer shall provide the measurement for checking tooth wear on pinion and rack. The measuring instruction shall be indicated on a metal plate securely fastened and conspicuously displayed on top of the car with letters not less than 3 mm (0.125 in.) high.

4.1.14 Terminal Stopping Devices

4.1.14.1 Normal and Final Terminal Stopping Devices. Normal and final terminal stopping devices shall be provided conforming to 2.25.1, 2.25.2, and 2.25.3, except 2.25.3.3. Normal and final terminal stopping devices shall be permitted to be located on the car and operated by cams attached to the hoistway structure.

4.1.14.2 Emergency Terminal Speed-Limiting Devices. Emergency terminal speed-limiting devices shall conform to 2.25.4.

Table 4.1.9.1 Maximum and Minimum Stopping Distances for Rack-and-Pinion Safeties With Rated Load

| SI Units | | | | Imperial Units | | | |
|------------------|----------------------------------|-----------------------|----------|---------------------|-------------------------------------|------------------------|----------|
| Rated Speed, m/s | Maximum Governor Trip Speed, m/s | Stopping Distance, mm | | Rated Speed, ft/min | Maximum Governor Trip Speed, ft/min | Stopping Distance, in. | |
| | | Min. | Max. | | | Min. | Max. |
| 0.63 | 0.88 | 80.5 | 1 639.3 | 125 | 175 | 3.17 | 64.54 |
| 0.76 | 1.06 | 116.0 | 1 703.5 | 150 | 210 | 4.57 | 67.07 |
| 0.89 | 1.37 | 164.3 | 1 791.2 | 175 | 250 | 6.47 | 70.52 |
| 1.01 | 1.42 | 206.2 | 1 866.9 | 200 | 280 | 8.12 | 73.50 |
| 1.14 | 1.56 | 249.4 | 1 945.3 | 225 | 308 | 9.82 | 76.59 |
| 1.27 | 1.71 | 298.7 | 2 034.2 | 250 | 337 | 11.76 | 80.09 |
| 1.52 | 2.00 | 410.7 | 2 236.4 | 300 | 395 | 16.15 | 88.05 |
| 1.77 | 2.29 | 537.2 | 2 466.5 | 350 | 452 | 21.15 | 97.11 |
| 2.03 | 2.59 | 684.0 | 2 731.0 | 400 | 510 | 26.03 | 107.52 |
| 2.28 | 2.86 | 848.3 | 3 029.9 | 450 | 568 | 33.40 | 119.29 |
| 2.54 | 3.17 | 1 027.1 | 3 098.8 | 500 | 625 | 40.44 | 122.00 |
| 3.04 | 3.75 | 1 439.9 | 4 101.5 | 600 | 740 | 56.69 | 161.48 |
| 3.55 | 4.34 | 1 922.3 | 4 975.0 | 700 | 855 | 75.68 | 195.87 |
| 4.06 | 4.92 | 2 473.9 | 5 974.5 | 800 | 970 | 97.40 | 235.22 |
| 4.57 | 5.51 | 3 095.4 | 7 100.0 | 900 | 1,085 | 121.87 | 279.53 |
| 5.06 | 6.09 | 3 786.3 | 8 305.8 | 1,000 | 1,200 | 149.07 | 327.00 |
| 5.58 | 6.70 | 4 581.4 | 9 791.7 | 1,100 | 1,320 | 180.37 | 385.50 |
| 6.09 | 7.31 | 5 452.3 | 11 379.2 | 1,200 | 1,440 | 214.66 | 448.00 |
| 6.60 | 7.92 | 6 400.8 | 13 083.5 | 1,300 | 1,560 | 252.00 | 515.10 |
| 7.11 | 8.53 | 7 421.1 | 14 935.2 | 1,400 | 1,680 | 292.17 | 588.00 |
| 7.62 | 9.14 | 8 068.3 | 16 924.0 | 1,500 | 1,800 | 333.40 | 666.30 |
| 8.12 | 9.75 | 9 642.8 | 19 050.0 | 1,600 | 1,920 | 381.61 | 750.00 |
| 8.63 | 10.36 | 10 942.3 | 21 313.1 | 1,700 | 2,040 | 430.80 | 839.10 |
| 9.14 | 10.97 | 12 266.4 | 23 713.4 | 1,800 | 2,160 | 482.98 | 933.60 |
| 9.65 | 11.58 | 13 668.7 | 26 750.9 | 1,900 | 2,280 | 538.14 | 1,053.50 |
| 10.16 | 12.19 | 15 145.2 | 28 925.5 | 2,000 | 2,400 | 596.27 | 1,138.80 |

4.1.15 Operating Devices and Control Equipment

4.1.15.1 Applicable Requirements. Operating devices and control equipment shall conform to 2.26 and to the following:

Where the rack-and-pinion machine and its controller are located on the car, the disconnecting means shall be located adjacent to the controller. Auxiliary disconnect means shall be provided at the main landing whenever the main power supply disconnect means (required by NFPA 70 or CSA-C22.1, as applicable; see Part 9) is mounted adjacent to the controller on the car. Auxiliary disconnect means shall be accessible to authorized personnel only in order to be available for their protection and emergency use.

4.1.15.2 Permitted Voltage. Voltage permitted in control and operating circuits shall not exceed 300 V on rack-and-pinion equipment.

4.1.16 Emergency Operation and Signal Devices

Emergency operation and signal service shall conform to 2.27.

4.1.17 Layout Drawings

Elevator layout drawings shall, in addition to the other data required by 2.28, indicate

- (a) the dimensions of the rack and location with respect to the guide rail
- (b) the magnitude of the loads on the rack imposed on the building structure

4.1.18 Welding

Welding shall conform to 8.8.

SECTION 4.2 SCREW-COLUMN ELEVATORS

This Section applies to an elevator having an uncounterweighted car that is supported by a screw column and is raised and lowered by screw thread means.

NOTE: See also Part 8 for additional requirements that apply to *screw-column elevators*.

4.2.1 Hoistways, Hoistway Enclosures, and Related Construction

Hoistways, hoistway enclosures, and related construction shall conform to 2.1, 2.2, 2.10, 2.11, 2.12, and 2.13.

4.2.2 Vertical Clearance and Runby for Cars

4.2.2.1 Bottom Car Clearance. The bottom car clearance shall conform to 2.4.1, provided that, in the determination of the required clearance, any undercar machinery and bracing that is located within 150 mm (6 in.) horizontally from the edge of the car platform or 75 mm (3 in.) horizontally from the centerline of the guide rails is not considered.

4.2.2.2 Minimum and Maximum Bottom and Top Car Runby. The minimum bottom and top car runby shall be not less than

(a) 75 mm (3 in.) for rated speeds not exceeding 0.5 m/s (100 ft/min)

(b) 150 mm (6 in.) for rated speeds exceeding 0.5 m/s (100 ft/min)

The maximum bottom and top car runby shall be not more than 600 mm (24 in.).

4.2.2.3 Top Car Clearance. The top car clearance shall be not less than the sum of the following two items:

(a) the top car runby

(b) the height of the refuge space on top of the enclosure (see 4.2.2.4) or the clearance required for equipment projecting above the top of the car to prevent its striking any part of the overhead structure or equipment located in the hoistway, but in no case less than 1 070 mm (42 in.)

4.2.2.4 Refuge Space on Top-of-Car Enclosure. A refuge space shall be provided on top of the car enclosure conforming to 2.4.12.

4.2.3 Horizontal Car Clearance

The horizontal car clearances shall conform to 2.5, except 2.5.1.2.

4.2.4 Protection of Spaces Below Hoistway

Where the space below the hoistway is used for a passageway, is occupied by persons, or if unoccupied, is not secured against unauthorized access, the requirements specified in 4.2.4.1 through 4.2.4.3 shall be conformed to.

4.2.4.1 The screw column, and any associated framing, shall be supported by a structure of sufficient strength to support the entire load imposed upon it, including the impact if the drive nut should fail.

4.2.4.2 The guide rails shall be supported by a structure of sufficient strength to withstand, without permanent deformation, the impact of a safety application with a fully loaded car.

4.2.4.3 The buffers shall be supported by a structure of sufficient strength to withstand, without permanent deformation, the impact resulting from buffer engagement by the car with its rated load at the maximum speed in the down direction.

4.2.5 Machine Rooms and Machinery Spaces

The machine rooms, machinery spaces, and location of elevator components shall conform to 4.2.5.1 through 4.2.5.6.

4.2.5.1 Motors and other integral mechanical or electrical equipment shall be permitted to be located in machinery space within the hoistway, on the car, in the pit, or in a separate machine room or machinery space.

4.2.5.2 The controller shall be permitted to be located on the car or on the exterior of the hoistway wall or other location apart from the hoistway, machine room, or machinery space. A controller so located shall be readily accessible for maintenance and inspection at all times. Controllers located apart from the hoistway, machine room, or machinery space shall be housed in a locked metal cabinet. The key shall be Group 1 Security (see 8.1).

4.2.5.3 A separate machine room or machinery space, apart from the hoistway, shall conform to 2.7.

4.2.5.4 A screw machine and its controls, if located on the car, shall be protected by a noncombustible enclosure to prevent accidental contact. Openwork enclosures of noncombustible material shall be permitted to be used for screw machines located on top of the car, provided the openwork material rejects a ball 13 mm (0.5 in.) in diameter.

4.2.5.5 Access shall be provided to the screw machine for maintenance. Access panels to screw machines located on the car shall be provided with an electric contact and lock. The electric contact shall be designed to prevent operation of the screw machine when the access panel is open. The access panel shall be kept closed and locked. The key shall be Group 1 Security (see 8.1).

4.2.5.6 Where the screw machine is located in the pit, means shall be permanently provided in the pit for supporting the car and its frame or platform during repairs or adjustments. Clear headroom under the platform shall be not less than 2 130 mm (84 in.) when the car is landed on the supports.

4.2.6 Equipment in Hoistways and Machine Rooms

Electrical wiring, pipes, and ducts in hoistways, machine rooms, and machinery spaces shall conform to 2.8, except, the main feeder of a screw-column elevator shall be permitted to be installed in the hoistway if the screw machine is located in the hoistway, provided there is no intermediate access to the conductors between the

disconnecting means and the termination at the motor or controller.

4.2.7 Supports and Foundations

4.2.7.1 The supports and foundations shall be designed to support all loads imposed by the elevator in accordance with the building code, including impact loading in the event of a car safety application, stop by a safety nut, or controlled descent by a speed-limiting device. The unit stresses in elevator-supporting members and their supports, based on two times the normal loading, shall not exceed those permitted for static loading in accordance with the requirements of the following standards:

- (a) AISC Book No. S326 or CAN/CSA-S16.1, whichever is applicable (see Part 9) for structural steel
- (b) ANSI/ACI 318 or CAN3-A23.3, whichever is applicable (see Part 9) for reinforced concrete

4.2.7.2 Where stresses due to loads, other than elevator loads supported on the beams, floor, or structure, exceed those due to the elevator loads, 100% of the permitted stresses shall be permitted to be used.

NOTE: In determining unit stresses, the maximum normal loading is doubled to take care of impact, accelerating stresses, etc.

4.2.8 Car Enclosures, Car Doors and Gates, and Car Illumination

The car enclosure, car doors and gates, and car illumination shall conform to 2.14.

4.2.9 Car Frames and Platforms

The car frame and platform shall conform to 2.15, except 2.15.12 and 2.15.13.

4.2.10 Capacity and Loading

The capacity and loading shall conform to 2.16.

4.2.11 Car Safeties and Speed Governor

A car safety device and speed governor shall be provided, which shall conform to the design and performance requirements of 2.17 and 2.18, except as specified in 4.2.11.1 and 4.2.11.2.

4.2.11.1 For elevators driven by an alternating-current squirrel cage induction motor and having a down speed of not more than 0.37 m/s (75 ft/min), the car safety and governor are not required if another safety device is provided to either

- (a) limit the down speed of the car with rated load to not over 0.87 m/s (175 ft/min) in the event of failure of the driving means; or
- (b) limit the fall of the elevator in the event of failure of the driving nut to a distance not exceeding 13 mm (0.5 in.), by utilizing a safety nut or other equivalent means.

4.2.11.2 The capability of the alternate safety devices described in 4.2.11.1(a) and (b) to function as required shall be verified by engineering tests as described in 8.3.10.

4.2.12 Safety Nut and Data Tag

4.2.12.1 A safety nut is required on all screw machines that utilize a driving nut made of a material other than metal and shall be permitted to be provided on all screw machines. The safety nut shall be made of metal and designed to withstand the impact without damage if the driving nut should fail.

4.2.12.2 A metal data tag shall be securely attached to each screw machine equipped with a safety nut bearing the following data:

- (a) date of installation of driving and safety nuts
- (b) spacing between driving and safety nuts

4.2.12.3 The material and markings of the safety nut spacing data tag shall conform to 2.16.3.3, except that the height of the letters and figures shall be not less than 1.6 mm (0.0625 in.).

4.2.13 Car Buffers

Car buffers shall be provided, which conform to 2.22, except that solid bumpers shall be permitted to be used for elevators provided with a safety nut [see 4.2.11.1(b)] and having a maximum speed in the down direction of 0.25 m/s (50 ft/min).

4.2.14 Guide Rails, Guide-Rail Supports, and Fastenings

Guide rails, guide-rail supports, and their fastenings shall conform to 2.23, except 2.23.4.2, 2.23.4.3, 2.23.9.1, and 2.23.10.

The fastening of guide rails to brackets or to the elevator-supporting frame shall be by clips, welds, or bolts. The rail structure and the structural members to which it is attached shall withstand the forces specified in 2.23.5.2, and the application of the car safety shall be within the deflection limits specified.

4.2.15 Driving Machine and Screw Column

The screw machine shall function to raise or lower the elevator car acting in conjunction with a screw column that directly supports the elevator car.

The screw column and machine shall conform to 2.24.4, 2.24.5, 2.24.6, 2.24.8, 2.29, and 4.2.15.1 through 4.2.15.11.

4.2.15.1 Screws shall be made of steel. Nuts shall be made of bronze or other materials having an elongation of at least 14% in a length of 50 mm (2 in.).

4.2.15.2 Means shall be provided to maintain the screw in its vertical position under all conditions of operation. Screws suspended from their upper end shall be restrained at their lower end.

4.2.15.3 A vertical casing, closed at the end, shall be provided to enclose and protect the screw column in cases where the screw column extends outside the hoistway and machine room.

4.2.15.4 The screw column and nut and their attachments to the car frame, car platform, or other structure shall provide sufficient strength to support the loads imposed on these connections with a factor of safety of 5.

4.2.15.5 Factors of safety for the driving machine, excluding the screw column and nut, their attachments to the car frame, car platform, or other structure, shall conform to 2.24.3, except that the load used in determining the factor of safety shall be based on the total weight supported with rated load in the car.

4.2.15.6 Screw machines of the indirect drive type shall conform to 2.24.9. The elevator shall be so designed that the elevator car, while carrying 125% of rated load and traveling at rated speed, shall decelerate and stop in the event the driving-belt system or driving-chain system should break.

4.2.15.7 Means shall be provided to prevent the disengagement of the nut from the screw column. This means shall be so designed and constructed as to prevent disengagement in the event of overtravel at full speed and without damage to any part of the elevator installation. Any additional loads imposed by this action shall also be considered in the computations made in accordance with 4.2.15.8.

4.2.15.8 Where the screw column is a compression member, column formulas of 8.2.8.1.1 shall be used in the design with the words "screw column" substituted for the word "plunger" and:

A = net cross-sectional area of screw at root of thread, mm^2 (in.^2)

L = maximum free length of screw, mm (in.)

R = radius of gyration of screw at root of thread, mm (in.)

W = the total weight with rated load plus one-half the weight of the screw column, kg (lb)

W/A = maximum allowable fiber stress

4.2.15.9 Where the screw column is a tension member, the unit stress (considering the root dimension and any associated stress concentration and/or the reduced section at any joints in the screw) shall not exceed one-fifth of the ultimate strength of the material with a maximum fiber stress not to exceed 124 MPa (18,000 psi).

4.2.15.10 Positive mechanical means shall be provided to prevent rotation or separation of sections of a multiple section screw column.

4.2.15.11 Means shall be provided to permit authorized personnel from a position outside the elevator car to raise or lower the car manually in the event

of a power failure, unless emergency or standby power is provided, except that for private residence elevators and special purpose personnel elevators, means to allow a passenger within a stalled car to manually move the car to a landing is acceptable and no other means of moving the stalled car is required.

4.2.16 Terminal Stopping Devices

4.2.16.1 Normal Terminal Stopping Devices. Normal terminal stopping devices shall conform to 2.25.1 and 2.25.2.

4.2.16.2 Final Terminal Stopping Devices. Final terminal stopping devices, conforming to 2.25.3.1 and 2.25.3.3, shall be provided for elevators having a rated speed exceeding 0.5 m/s (100 ft/min). Final terminal stopping devices shall be located in the hoistway and operated by cams attached to the car.

Elevators having a rated speed of 0.5 m/s (100 ft/min) or less shall be designed so that the elevator car will be brought to a stop without damage to the elevator system in the event of overtravel of the elevator at either terminal due to a malfunction.

4.2.16.3 Emergency Terminal Speed-Limiting Devices. Emergency terminal speed-limiting devices shall be installed where reduced stroke buffers are used (see 2.22.4.1.2). These devices shall conform to 2.25.4.

4.2.17 Operating Devices and Control Equipment

4.2.17.1 Applicable Requirements. Operating devices and control equipment shall conform to the following:

(a) Requirement 2.26.1.1, Types of Operating Devices.

(b) Requirement 2.26.1.4, Inspection Operation, except that a top-of-car operating devices are not required on private residence elevators and special purpose personnel elevators. Top-of-car operating devices are not required on any screw-column elevator if there is no mechanical or electrical equipment that requires maintenance from the top of the car.

(c) Requirements 2.26.2.5, 2.26.2.7 through 2.26.2.10, 2.26.2.12 through 2.26.2.15, 2.26.2.18 through 2.26.2.21, 2.26.2.25, and 2.26.2.28, Electrical Protective Devices.

(d) Requirement 2.26.3, Contactors and Relays in Critical Operating Circuits.

(e) Requirement 2.26.4, Requirements of Electrical Equipment and Wiring.

(f) Requirement 2.26.5, System to Monitor and Prevent Automatic Operation of the Elevators With Faulty Door Contact Circuits.

(g) Where the screw machine and its controller are located on the car, in the hoistway, or outside the hoistway, the disconnecting means shall be located adjacent to the controller.

(h) Requirement 2.26.6, Phase Protection of Motors.

(i) Requirement 2.26.7, Installation of Capacitors or Other Devices to Make Electrical Protective Devices Ineffective.

(j) Requirement 2.26.8, Release and Application of Driving-Machine Brakes.

(k) Requirement 2.26.9, Control and Operating Circuits.

(l) Requirement 2.26.11, Car Platform to Hoistway Door Sills Vertical Distance.

(m) Requirement 2.26.13, Operating Device Symbols.

4.2.18 Emergency Operation and Signaling Devices

Emergency operation and signaling devices shall conform to 2.27.

4.2.19 Layout Drawings

Elevator layout drawings shall, in addition to the other data required by 2.28, indicate the following:

(a) the material and dimensions of the screw column, including thread dimensions

(b) the location and amount of the maximum loadings on the building structure

4.2.20 Welding. All welding shall conform to 8.8.

SECTION 4.3 HAND ELEVATORS

This Section applies to hand-operated elevators.

NOTE: See also Part 8 for additional requirements that apply to *hand elevators*.

4.3.1 Hoistways, Hoistway Enclosures, and Related Construction

Hoistways, hoistway enclosures, and related construction shall conform to Part 2, except for the following, which do not apply:

- 2.1.3 Floor Over Hoistways
- 2.1.6 Projections, Recesses, and Setbacks in Hoistway Enclosures
- 2.2 Pits
- 2.3 Location and Guarding of Counterweights
- 2.4 Vertical Clearances and Runbys for Cars and Counterweights
- 2.5 Horizontal Car and Counterweight Clearances
 - 2.7.1.1 Fire-Resistive Construction
 - 2.7.1.2 Non-Fire-Resistive Construction
 - 2.7.2 Maintenance Path and Clearance
 - 2.7.4 Headroom in Machinery Spaces, Machine Rooms, Control Spaces, and Control Rooms
 - 2.7.9.2 Temperature and Humidity
- 2.8 Equipment in Hoistways, Machinery Spaces, Machine Rooms, Control Spaces, and Control Rooms

2.10 Guarding of Equipment and Standard Railing

2.11.2.1 Passenger Elevators

2.11.2.2 Freight Elevators

2.11.3 Closing of Hoistway Doors

2.11.7 Glass in Hoistway Doors

2.11.9 Hoistway Door Locking Devices and Power Operation

2.12 Hoistway Door Locking Devices and Electric Contacts, and Hoistway Access Switches

2.13 Power Operation of Hoistway Doors and Car Doors

4.3.2 Pits

Pits are not required.

4.3.3 Top Clearances

4.3.3.1 Top Car Clearance. The top car clearance shall be not less than the sum of the following:

(a) the bottom counterweight runby, if any

(b) the stroke of the counterweight buffer where a spring-type buffer is used (buffer not required for sidewalk elevators)

(c) 300 mm (12 in.)

4.3.3.2 Top Counterweight Clearance. The top counterweight clearance shall be not less than the sum of the following:

(a) the bottom car runby, if any

(b) the stroke of the car buffer where a spring-type buffer is used (buffer not required for sidewalk elevators)

(c) 150 mm (6 in.)

4.3.4 Enclosures for Machines and Control Equipment

Elevator machines and their control equipment shall be permitted to be located inside the hoistway enclosure at the top or bottom without intervening enclosures or platforms.

Machines of sidewalk elevators having a rise of not more than one floor, and having an opening into the building at the bottom terminal landing only, are not required to be enclosed.

4.3.5 Overhead Beams and Supports, and Access to Machines and Sheaves

4.3.5.1 Overhead Beams and Supports. Overhead beams and their supports shall conform to 2.9.

4.3.5.2 Access to Machines and Sheaves. Adequate and permanent means of access shall be provided to machines and sheaves for maintenance and inspection (see 2.7.3).

4.3.6 Hoistway Entrances

4.3.6.1 Types of Entrances. Entrances will be of the following types:

(a) self-closing or manually operated horizontally sliding or swinging, single section

(b) self-closing or manually operated horizontally swinging, two section (Dutch type) with one section above the other and the lower section extending not less than 1 070 mm (42 in.) above the floor, and arranged to be opened only when the car is in the landing zone and after the upper section has been opened, and to be closed by the closing of the upper section

(c) manually operated vertically sliding counter-weighted single- or multi-section

(d) manually operated vertically sliding biparting counterbalanced

(e) for sidewalk elevator doors in sidewalks or other areas exterior to the building, see 5.5.1.11.2

4.3.6.2 Closing of Hoistway Doors. All doors shall be kept closed, except the door at the floor where the car is being operated or is being loaded or unloaded.

Manually operated doors shall be equipped with approved devices to close them automatically when released by the action of heat. Self-closing doors equipped with hold-open devices shall be equipped with fusible links that will release the door in case of excessive heat.

Landing doors shall be provided with mechanical locks so arranged that the car cannot leave the landing unless the door is closed. The lock or latch shall be arranged to ensure that the door is in a position to be locked when or before the car leaves the landing.

These requirements do not apply to bottom landing doors of sidewalk elevators.

4.3.6.3 Signs on Hoistway Doors. Every hoistway door shall have conspicuously displayed on the landing side in letters not less than 50 mm (2 in.) high the words: "DANGER—ELEVATOR—KEEP CLOSED."

4.3.7 Hoistway Gates for Landing Openings

Hoistway landing openings equipped with horizontally sliding or swinging doors shall also be provided with vertically sliding semiautomatic gates, not less than 1 070 mm (42 in.) high and of a design that will reject a ball 50 mm (2 in.) in diameter. Gates shall be so constructed and guided as to withstand a lateral force of 445 N (100 lbf) concentrated at the center of the gate without being deflected beyond the line of the landing sill, and a force of 1 112 N (250 lbf) without forcing the gate from its guides or without causing it to break or be permanently deformed.

4.3.8 Hoistway Door and Hoistway Gate Locking Devices

Hoistway doors and hoistway gates, where required, shall be provided with locking devices as specified in 4.3.8.1 and 4.3.8.2.

4.3.8.1 Door Latches. Hoistway doors shall be provided with spring-type latches to hold them in the closed position. Such latches shall be capable of being released from both the hoistway and landing side, irrespective of the position of the car.

4.3.8.2 Gate Locks. Hoistway gates required with horizontally sliding or swinging type hoistway doors (see 4.3.7) shall be provided with hoistway gate separate mechanical locks.

(a) *Type Required.* Hoistway gate separate mechanical locks shall be of a type actuated only when the car is within the landing zone by a cam attached to the car.

(b) *General Design Requirements.* The lock shall hold the gate in the closed position by means of gravity or by a restrained compression spring, or by both.

(c) *Closed Position.* Hoistway gates provided with hoistway gate separate mechanical locks shall be considered to be in the closed position when the gate is within 10 mm (0.375 in.) of contact with the landing sill.

4.3.9 Car Enclosures

Cars shall be enclosed on the sides not used for entrance. The deflection of the enclosure shall be not more than 6 mm (0.25 in.) when subjected to a force of 334 N (75 lbf) applied perpendicularly to the car enclosure at any point. The enclosure shall be secured to the car platform or frame in such a manner that it cannot work loose or become displaced in ordinary service.

These requirements do not apply to sidewalk elevators.

4.3.10 Use of Glass in Cars

Glass shall not be used in elevator cars, except as permitted in 2.14.1.8.

4.3.11 Car Frames and Platforms

Car frames and platforms shall be of metal or sound seasoned wood designed with a factor of safety of not less than 4 for metal and 6 for wood, based on the rated load uniformly distributed. Connection between frame members of the car frame and the platform shall be riveted, bolted, or welded.

Sidewalk elevator platforms shall be provided with steel bow irons or stanchions to open sidewalk doors or covers (see 5.5.1.15.2).

4.3.12 Car Compartments

Elevator cars upon which an operator is permitted to ride shall have not more than one compartment.

4.3.13 Cars Counterbalancing One Another

Elevator cars upon which persons are permitted to ride shall not be arranged to counterbalance each other.

4.3.14 Capacity and Loading

4.3.14.1 Minimum Rated Load. The rated load of hand elevators shall be not less than 240 kg/m^2 (50 lb/ft^2) of inside net car area.

4.3.14.2 Capacity Plate. A metal plate shall be fastened in a conspicuous place in the elevator car and shall bear the following information in not less than 6 mm (0.25 in.) letters or numerals, stamped, etched, or raised on the surface of the plate:

- (a) rated load in kg (lb)
- (b) the maximum number of passengers to be carried based on 68 kg (150 lb) per person (if passenger elevator)
- (c) suspension data required by 4.3.16.5

4.3.15 Car Safeties

Elevators having a rise of more than 4.6 m (15 ft) shall be provided with a car safety, attached to the underside of the car frame, capable of stopping and sustaining the car with rated load.

The car safety device is not required to be operated by a speed governor, and is permitted to be of the instantaneous type operated as a result of the breaking or slackening of the suspension members.

Where the rise exceeds 12.5 m (40 ft), driving machines having hand-operated brakes shall also be equipped with an automatic speed retarder.

4.3.16 Suspension Means

4.3.16.1 Type and Number Required. Suspension means shall consist of not less than two wire ropes or chains.

4.3.16.2 Factor of Safety. The factor of safety used in determining the size and number of the suspension members shall be not less than 5, based on the weight of the car and its rated load.

4.3.16.3 Length of Suspension Members. The length of suspension members shall be such as to provide the minimum top car and counterweight clearances specified in 4.3.3.

4.3.16.4 Securing of Drum Ends, and Turns on Drum. Drum ends of suspension members shall be secured to the inside of the drum by clamps or babbitted sockets, and there shall be not less than one complete turn of the suspension members around the winding drum when the car or counterweight is resting on its buffers.

4.3.16.5 Suspension Member Data. The capacity plate required by 4.3.14.2 shall show the size, rated ultimate strength, and material of the suspension members. The date of installation of the suspension members shall be shown on a metal tag attached to the suspension fastening.

4.3.17 Counterweights

4.3.17.1 Counterweight Construction. Sections of counterweights, whether carried in frames or not, shall be secured by at least two tie-rods passing through holes in the sections. The tie-rods shall have locknuts at each end, secured by cotter pins.

4.3.18 Guide Rails and Fastenings

4.3.18.1 Material and Finish. Car and counterweights shall be provided with guide rails of steel or straight-grained seasoned wood free from knots, shakes, dry rot, or other imperfections.

Guide rails for sidewalk elevators shall be of steel. The guiding surfaces of the guide rails for elevators equipped with car safeties shall be finished smooth.

4.3.18.2 Strength of Rails and Fastenings. Guide rails shall be securely fastened with through bolts or clips of such strength, design, and spacing that

- (a) the guide rails and their fastenings shall not deflect more than 6 mm (0.25 in.) under normal operation
- (b) the guide rails and their fastenings shall withstand the application of the safety, where provided, when stopping the car with rated load or when stopping the counterweight

4.3.18.3 Extension of Guide Rails at Top and Bottom of Hoistway. Car and counterweight guide rails shall rest on suitable supports and extend at the top of the hoistway sufficiently to prevent the guide shoes from running off the guide rails in case the car or counterweight travels beyond the terminal landings.

4.3.19 Driving Machines and Sheaves

4.3.19.1 Factors of Safety. The factors of safety, based on static loads, to be used in the design of driving machines and sheaves shall be not less than 8 for wrought iron or wrought steel and 10 for cast iron or other materials.

4.3.19.2 Driving-Machine Brakes. Driving machines shall be equipped with a hand brake or an automatic brake operating in either direction of motion of the elevator, and capable of stopping and holding the car with its rated load. When the brake has been applied, it shall remain in the "ON" position until released by the operator.

4.3.20 Power Attachments

Power attachments are prohibited. Elevators shall not be equipped with any means or attachment for applying electric or other power unless the elevator is permanently and completely converted into a power elevator conforming to all requirements of this Code for electric or hydraulic elevators.

4.3.21 Layout Data

The information provided on layout data shall conform to 2.28.

4.3.22 Inspections and Tests

See 8.10 and 8.11 for the testing requirements for hand elevators.

Part 5

Special Application Elevators

(13)

SCOPE

Part 5 applies to special application elevators as specified in the following requirements:

- (a) Requirement 5.1 applies to inclined elevators.
- (b) Requirement 5.2 applies to limited-use/limited-application elevators.
- (c) Requirement 5.3 applies to private residence elevators.
- (d) Requirement 5.4 applies to private residence inclined elevators.
- (e) Requirement 5.5 applies to power sidewalk elevators.
- (f) Requirement 5.6 applies to rooftop elevators.
- (g) Requirement 5.7 applies to special purpose personnel elevators in jurisdictions not enforcing NBCC.
- (h) Requirement 5.8 applies to shipboard elevators.
- (i) Requirement 5.9 applies to mine elevators in jurisdictions not enforcing NBCC.
- (j) Requirement 5.10 applies to elevators used for construction.
- (k) Requirement 5.11 applies to elevators used in wind turbine towers.
- (l) Requirement 5.12 applies to outside emergency elevators.

SECTION 5.1 INCLINED ELEVATORS

Requirement 5.1 applies to inclined elevators (see 1.3) at other than private residences.

NOTE: See also Part 8 for additional requirements that apply to *inclined elevators*.

5.1.1 General Requirements

5.1.1.1 Hoistways, hoistway enclosures, and related construction shall conform to 5.1.2, 2.1 through 2.13, and 2.29, except as modified by 5.1.1 through 5.1.6 and 5.1.8 through 5.1.10.

5.1.1.2 Machinery and equipment shall conform to 2.14 through 2.28, 8.8, and 8.9, except as modified by 5.1.7, and 5.1.11 through 5.1.22.

5.1.2 Construction of Hoistway and Hoistway Enclosures

5.1.2.1 Fire-Resistive Construction. Hoistway enclosures shall conform to 2.1.1.1.

5.1.2.2 Non-Fire-Resistive Construction. Where fire-resistive construction of the hoistway is not required by the building code, the hoistway shall be enclosed as specified in 5.1.2.2.1 through 5.1.2.2.4.

5.1.2.2.1 Enclosures shall be of solid construction or openwork at least 2 140 mm (84 in.) high. If of openwork, it shall reject a ball 19 mm (0.750 in.) in diameter and be located a minimum of 150 mm (6 in.) from the nearest moving component, or shall reject a ball 50 mm (2 in.) in diameter and be located a minimum of 914 mm (36 in.) from the nearest moving component. Areas of the enclosure located adjacent to landing entrances, and entrances of openwork construction, shall reject a ball 13 mm (0.5 in.) in diameter. All enclosures shall be supported and braced so as to deflect not more than 50 mm (2 in.) when subjected to a force of 444 N (100 lbf) applied horizontally over any 101.6 mm² (4 in.²) area of the enclosure, nor shall the running clearance be reduced to less than 25 mm (1 in.).

5.1.2.2.2 Those portions of the hoistway where the lowest member of the guides or any moving component is at least 2 440 mm (96 in.) above the surface below shall not be required to have any enclosure. Adjacent hoistway enclosures shall be joined under the guides. The underside of any area of the hoistway that crosses any passageway, such as a pathway or roadway, shall be enclosed. The enclosure shall be of solid or openwork construction, shall be full width, and shall extend beyond the area of the passageway on each side a distance at least equal to one-half of the vertical distance between the lowest member of the guides and each edge of the passageway, respectively. If of openwork construction, it shall reject a ball 19 mm (0.75 in.) in diameter.

5.1.2.2.3 Structures used to support the hoistway, and located outside of the enclosure, shall be designed to protect against climbing.

5.1.2.2.4 Acrylics, laminated glass, or wired glass used for enclosures and doors shall be of the following minimum thicknesses:

- (a) acrylics, 6 mm (0.250 in.)
- (b) laminated glass, 9.5 mm (0.375 in.)
- (c) wired glass, 6 mm (0.250 in.)

5.1.3 Pits and Work Spaces

5.1.3.1 Work Space Dimensions. If not otherwise provided by the pit design, each inclined elevator shall

be provided with a work space below the guides extending to each side a minimum of 450 mm (18 in.) beyond the running line of the car or counterweight with a length in the direction of travel of not less than 1 830 mm (72 in.) throughout the length measured from the top of the guides. Such work spaces shall be provided with stop switches and lighting conforming to 2.2.5 and 2.2.6 and shall be equipped with a convenience outlet. On exterior installations, these devices shall be weather-proof.

5.1.3.2 Pit and Work Space Water Removal. In addition to the requirements of 2.2, the means provided for the removal of water on exterior installations shall be ample for weather-caused water collection.

5.1.4 Counterweight Pit Guards

Requirement 2.3.2.1 does not apply.

5.1.5 Clearances for Cars and Counterweights

5.1.5.1 Bottom Car Clearances. Inclined elevators shall conform to 2.4.1 or be provided with one of the following refuge spaces:

(a) a minimum of 610 mm × 610 mm × 2 134 mm (24 in. × 24 in. × 84 in.) high

(b) a minimum of 610 mm × 1 220 mm × 1 220 mm (24 in. × 48 in. × 48 in.)

The refuge space shall be clear of the car and counterweight resting on their fully compressed buffers. This space shall be located to either side of, or toward the downhill end of, the pit in the direction of travel.

5.1.5.2 Top Car Clearance for Uncounterweighted Inclined Elevators. The top car clearance for inclined elevators of less than 20 deg inclination from the horizontal shall include the gravity stopping distance based on 115% of rated speed plus the top car clearance required by 2.4.7.

5.1.6 Protection of Spaces in Line With the Direction of Travel

Requirement 2.6 applies, except that where it states "below the hoistway," it shall mean "beyond the bottom terminal in the direction of travel."

(a) Where 2.6.1 states "underneath," it shall refer to the location stated in 5.1.6.

(b) Where 2.6.2 states "underneath," it shall refer to the location stated in 5.1.6.

5.1.7 Equipment in Hoistways and Machine Rooms

5.1.7.1 Protection of Traveling Cables. Traveling cables shall be suitably protected against abrasion and fouling. This protection shall be permitted to be provided in conjunction with that protection required by 5.1.16.1.

5.1.7.2 Weatherproofing. Components subject to corrosion on installations exposed to the weather shall

be weatherproofed with either exterior coatings, anodizing, plating, galvanizing, or noncorrosive metals or other accepted forms of protection.

5.1.8 Protection of Hoistway Openings

5.1.8.1 Hoistway Door Vision Panels. Where the hoistway enclosure is not required to be fire-resistive construction (see 5.1.2.2), hoistway door vision panels are not required to conform to 2.11.7. The hoistway entrances of such elevators shall be permitted to be provided with vision panels of larger size, including complete door panels, made of any materials conforming to 5.1.2.2.4 and ANSI Z97.1 or 16 CFR Part 1201 or CAN/CGSB-12.1, CAN/CGSB-12.11, and CAN/CGSB-12.12, whichever is applicable.

5.1.8.2 Landing Sill Guards. When a car leveling device is provided, the landing sills shall be guarded in conformance with 2.11.10.1. The guards shall also extend 75 mm (3 in.) beyond the horizontal leveling zone.

5.1.9 Reserved for Future Use

(13)

5.1.10 Access to Hoistways for Inspection, Maintenance, and Repairs

5.1.10.1 Hoistway Access Switches. Elevators installed conforming to 5.1.2.2 are not required to conform to 2.12.7, provided that

(a) the means of access provides equivalent safety to that provided by 2.12.7

(b) if the means of access includes entrance through the hoistway guarding, it is locked under Group 1 Security (see 8.1) and is equipped with a contact meeting the requirements of 2.26.2.26

5.1.10.2 Workspace Access. Where a workspace is required by 5.1.3.1, access to the workplace shall comply with 2.12.7 or 5.1.10.1, except where a separate workspace access door is provided.

5.1.10.3 Special Operating Requirements

5.1.10.3.1 The speed under 2.12.7.3.3(b) shall be not greater than 0.64 m/s (125 ft/min). (ED)

5.1.10.3.2 The movement of the car under 2.12.7.3.3(c) shall be limited to the point where the platform guard is even with the uphill edge of the open hoistway door. (ED)

5.1.10.3.3 The movement of the car under 2.12.7.3.3(d) shall be limited to the point where the uppermost chassis member is even with the downhill edge of the open hoistway door. (ED)

5.1.11 Car Enclosures

5.1.11.1 Car Emergency Exits

5.1.11.1.1 Top Emergency Exits. Requirement 2.14.1.5 applies only where installations are at an angle

greater than 49 deg and where an uphill end emergency exit is not provided.

5.1.11.1.2 Uphill End Emergency Exit. If the installation arrangement is such that the car door cannot be used for an emergency exit when the car is located between landings, the car shall be provided with an emergency exit located in the uphill end of the car. The emergency exit door shall

- (a) be of the hinged type
- (b) open only into the car
- (c) extend from the floor or base moulding to a clear height of not less than 1 524 mm (60 in.) and shall provide a clear width of not less than 356 mm (14 in.) when the door is open
- (d) be provided with a locking means with a nonremovable handle that can be opened only from the exterior of the car. The device shall be permitted to be openable from the interior of the car by use of a special key, which shall be of Group 1 Security (see 8.1).

(e) be provided with an electric contact, which shall not permit the car to start or run, except under inspection conditions as provided for in 5.1.10.1 and 5.1.10.3. The contact shall conform to the following:

- (1) it shall not be accessible from the inside of the car
- (2) it shall be positively opened by a lever or other device attached to and operated by the door
- (3) the contacts shall be maintained in the open position by the action of gravity or by a restrained compression spring, or both, or by positive mechanical means

(f) be of the same material and construction as required for the car enclosure.

5.1.11.1.3 Emergency Exit Unloading Platforms.

An emergency exit unloading platform is not required. If provided, an emergency exit unloading platform shall be attached to the car and shall be retractable and operable only from the exterior of the car. It shall be located only on the uphill end of the car and shall be provided with an electric contact conforming to 5.1.11.1.2(e) and shall only be made in the retracted position of the platform.

5.1.11.2 Car Enclosure Tops. Requirement 2.14.1.6 does not apply. However, if equipment is placed or installed on inclined elevators that will require servicing from the top of the car or a car top emergency exit is provided, the car top shall conform to 2.14.1.6 and 2.14.1.7.

5.1.11.3 Glass and Plastic for Cars and Doors. Glass and safety plastic used in car or for doors shall be laminated glass or safety plastic conforming to the requirements of ANSI Z97.1 or 16 CFR Part 1201.1 or 1202.2; or, be laminated glass or safety glass or safety plastic conforming to the requirements of CAN/CGSB-12.1,

CAN/CGSB-12.11, and CAN/CGSB-12.12, whichever is applicable.

5.1.11.4 Restricted Opening of Car Doors. Inclined elevators shall conform to 2.14.5.7, except that the unlocking zone shall not exceed 152 mm (6 in.) beyond the landing measured in the direction of travel. (13)

5.1.11.5 Collapsible Gates. Requirement 2.14.6.3 shall not apply. Collapsible-type gates are not permitted. (13)

5.1.12 Car Frames and Platforms

5.1.12.1 Materials for Car Frames and Platform Frames. Car frames and platform frames shall conform to 2.15.6.1, except that cast iron shall not be used for guiding supports or guide shoes.

5.1.12.2 Platform Guards (Aprons). The entrance side of the platform shall be provided with smooth metal guard plates of not less than 1.5 mm (0.059 in.) thick steel, or material of equivalent strength and stiffness, reinforced and braced to the car platform and conforming to 5.1.12.2.1 through 5.1.12.2.5.

5.1.12.2.1 It shall extend not less than the full width of the widest hoistway door opening plus the leveling zone in each direction.

5.1.12.2.2 It shall have a straight vertical face in the direction of travel throughout the length described in 5.1.12.2.1 plus 75 mm (3 in.).

5.1.12.2.3 The ends of the guard in each direction of travel shall be bent back at an angle of not less than 60 deg nor more than 75 deg from the face provided for in 5.1.12.2.2.

5.1.12.2.4 The straight vertical facing wall shall extend a minimum of 25 mm (1 in.) below the landing sills at any position above or below the landing to the extent of the leveling zones.

5.1.12.2.5 The guard plate shall be able to withstand a constant force of not less than 667 N (150 lbf) applied at right angles to and at any position on its face without deflecting more than 6 mm (0.25 in.) and without permanent deformation.

5.1.12.2.6 Platform Stringers. Platform stringers made of wood are not permitted.

5.1.13 Capacity and Loading

5.1.13.1 Benches or Seats. The inside net platform area (see Table 2.16.1) shall be permitted to be increased by an amount not greater than 50% of the area of the bench or seat, when a permanently located and nonfolding bench or seat is installed.

5.1.13.2 Data Plates. Data plates shall be located on the uphill member of the car chassis (frame).

5.1.14 Car and Counterweight Safeties

5.1.14.1 Requirements for Safeties. Car and counterweight safeties shall meet the requirements of 2.17, except as modified by 5.1.14.2, 5.1.14.3, 5.1.15, and 5.1.18.4.

5.1.14.2 Functions and Stopping Distance of Safeties. The safety device, or the combined safety devices where furnished, shall be capable of stopping and sustaining the entire car with its rated load from governor tripping speed (see also 2.16.8) with an average horizontal retardation, measured over the total retardation time, not exceeding 2.46 m/s^2 (8.05 ft/s^2).

Type B safeties shall stop the car with its rated load from governor tripping speed within range of the minimum and maximum stopping distances as determined by the formulas in 8.2.11. Table 5.1.14.2 shows the minimum and maximum stopping distances for various governor tripping speeds, when tested in conformance with 8.10 and 8.11.

5.1.14.3 Limits of Use of Various Types of Safeties

5.1.14.3.1 Type A (Instantaneous) Safeties

(a) Type A safeties shall not be used on inclined elevators having a rated speed in excess of 0.64 m/s (125 ft/min) or with a governor tripping speed in excess of 0.75 m/s (150 ft/min).

(b) Type A safeties that develop horizontal retardations exceeding 2.46 m/s^2 (8.05 ft/s^2) shall not be used on inclined elevators.

5.1.14.3.2 Type C Safeties. Type C safeties shall conform to 2.17.8.2, except as modified by the following:

(a) Type C safeties that develop horizontal retardations exceeding 2.46 m/s^2 (8.05 ft/s^2) shall not be used on inclined elevators.

(b) The oil buffers shall conform to all requirements specified in 2.22 for oil buffers, except that the stroke shall be based on governor tripping speed and on an average horizontal retardation not exceeding 2.46 m/s^2 (8.05 ft/s^2).

5.1.15 Speed Governor Drive

5.1.15.1 Rope-Driven Governors. Rope-driven governors are not required.

5.1.15.2 Other Driving Means of Governors. The means used to drive the speed governor shall be positive and fail-safe.

5.1.15.3 Counterweight-Mounted Governor. Where a counterweight operates on guide rails, which are located below the car guide rails and the governor, if required, is located on the counterweight, the overspeed switch shall be permitted to be omitted.

5.1.16 Suspension Ropes and Their Connections

5.1.16.1 Protection of Ropes. Suspension, governor, and compensation ropes shall be protected against abrasion.

5.1.17 Car and Counterweight Buffers

5.1.17.1 Type and Location. The maximum rated speed of inclined elevators for the use of spring-type buffers shall be 0.64 m/s (125 ft/min).

5.1.17.2 Spring Buffer Stroke. The stroke of a spring buffer shall be not less than as specified in Table 5.1.17.2.

5.1.17.3 Vertical and Horizontal Components of Velocity. The speed shall be considered as having vertical and horizontal components defined as in Fig. 5.1.17.3.

5.1.17.4 Oil Buffers. Oil buffers shall conform to 2.22.4, except as modified by 5.1.17.4.1 through 5.1.17.4.5.

5.1.17.4.1 The average horizontal retardation at buffer engagement, with rated load in the car, measured over the stopping distance, shall not exceed 2.46 m/s^2 (8.05 ft/s^2).

5.1.17.4.2 In 2.22.4.1.1, 2.22.4.1.2, and 2.22.4.2, the phrase “an average retardation of not more than 9.81 m/s^2 (32.2 ft/s^2)” is replaced with the phrase “an average horizontal retardation not in excess of 2.46 m/s^2 (8.05 ft/s^2).”

5.1.17.4.3 In 2.22.4.2, the phrase “peak retardation greater than 24.54 m/s^2 (80.5 ft/s^2)” is replaced with the phrase “peak horizontal retardation greater than 6.13 m/s^2 (20.1 ft/s^2).”

5.1.17.4.4 Table 2.22.4.1 is replaced with Table 5.1.17.4.4, which indicates the minimum buffer strokes for the most usual rated speeds and selected angles of inclination.

5.1.17.4.5 The minimum buffer strokes for speeds differing from the values in Table 5.1.17.4.4 shall be based on the formula in 8.2.10.

5.1.18 Car and Counterweight Guide Rails, Guide-Rail Supports, and Fastenings

5.1.18.1 Guide-Rail Section. The guide-rail sections, in conjunction with the guiding members, shall be so designed as to retain the car and counterweights on the rails in case of upthrust or side thrust force, such as caused by foreign objects in or on the guide rail, or from the effects of wind, frost, or snow.

5.1.18.2 Maximum Load on Rails. On inclined elevators where a single system of guide rails or brackets is employed, the sum of the car and counterweight forces shall be used to determine the maximum acceptable rated load. The guide rails, guide-rail brackets, and their

Table 5.1.14.2 Minimum and Maximum Stopping Distances at Given Angles From Horizontal

| SI Units | | | | | | | | | |
|------------------|--------------------|--|-------|-------|-------|-------|-------|-------|-------|
| Rated Speed, m/s | Governor Trip, m/s | Minimum and Maximum Stopping Distance, mm, at Angle From Horizontal, deg | | | | | | | |
| | | 30 | | 45 | | 60 | | 70 | |
| | | Min. | Max. | Min. | Max. | Min. | Max. | Min. | Max. |
| 0-0.63 | 0.90 | 139 | 453 | 114 | 417 | 81 | 369 | 55 | 333 |
| 0.75 | 1.05 | 201 | 541 | 164 | 489 | 116 | 420 | 79 | 367 |
| 0.87 | 1.25 | 285 | 661 | 232 | 586 | 164 | 489 | 113 | 415 |
| 1.00 | 1.40 | 357 | 765 | 292 | 671 | 206 | 549 | 141 | 456 |
| 1.12 | 1.55 | 432 | 872 | 353 | 758 | 249 | 611 | 171 | 498 |
| 1.25 | 1.70 | 517 | 993 | 422 | 858 | 299 | 681 | 204 | 546 |
| 1.50 | 2.00 | 711 | 1 270 | 580 | 1 084 | 410 | 840 | 281 | 655 |
| 1.75 | 2.30 | 930 | 1 584 | 760 | 1 340 | 537 | 1 022 | 368 | 780 |
| 2.00 | 2.55 | 1 185 | 1 948 | 967 | 1 637 | 684 | 1 232 | 468 | 923 |
| 2.25 | 2.90 | 1 469 | 2 355 | 1 200 | 1 970 | 848 | 1 467 | 580 | 1 084 |
| 2.50 | 3.15 | 1 779 | 2 798 | 1 453 | 2 331 | 1 027 | 1 723 | 700 | 1 259 |
| 3.00 | 3.70 | 2 494 | 3 820 | 2 036 | 3 166 | 1 440 | 2 313 | 985 | 1 663 |
| 3.50 | 4.30 | 3 329 | 5 015 | 2 718 | 4 141 | 1 922 | 3 003 | 1 315 | 2 134 |
| 4.00 | 4.85 | 4 285 | 6 382 | 3 499 | 5 257 | 2 474 | 3 792 | 1 692 | 2 674 |

| Imperial Units | | | | | | | | | |
|---------------------|-----------------------|---|-------|-------|-------|------|-------|------|-------|
| Rated Speed, ft/min | Governor Trip, ft/min | Minimum and Maximum Stopping Distance, in., at Angle From Horizontal, deg | | | | | | | |
| | | 30 | | 45 | | 60 | | 70 | |
| | | Min. | Max. | Min. | Max. | Min. | Max. | Min. | Max. |
| 0-125 | 175 | 5.5 | 18.0 | 4.5 | 16.5 | 3.5 | 14.5 | 2.5 | 13.0 |
| 150 | 210 | 8.0 | 21.5 | 6.5 | 19.5 | 5.0 | 17.0 | 3.5 | 14.5 |
| 175 | 250 | 11.5 | 26.0 | 9.5 | 23.0 | 6.5 | 19.5 | 4.5 | 16.5 |
| 200 | 280 | 14.5 | 30.0 | 11.5 | 26.5 | 8.5 | 22.0 | 6.0 | 18.0 |
| 225 | 308 | 17.5 | 34.5 | 14.0 | 30.0 | 10.0 | 24.0 | 7.0 | 20.0 |
| 250 | 337 | 20.5 | 39.0 | 17.0 | 34.0 | 12.0 | 27.0 | 8.5 | 21.5 |
| 300 | 395 | 28.0 | 50.0 | 23.0 | 43.0 | 16.5 | 33.0 | 11.5 | 26.0 |
| 350 | 452 | 37.0 | 62.5 | 30.0 | 53.0 | 21.5 | 40.5 | 14.5 | 31.0 |
| 400 | 510 | 47.0 | 77.0 | 38.5 | 64.5 | 27.0 | 48.5 | 18.5 | 36.5 |
| 450 | 568 | 58.0 | 93.0 | 47.5 | 77.5 | 33.5 | 58.0 | 23.0 | 43.0 |
| 500 | 625 | 70.5 | 110.5 | 57.5 | 92.0 | 40.5 | 68.0 | 28.0 | 50.0 |
| 600 | 740 | 98.5 | 150.5 | 80.5 | 125.0 | 57.0 | 91.0 | 39.0 | 65.5 |
| 700 | 855 | 131.5 | 197.5 | 107.5 | 163.0 | 76.0 | 118.5 | 52.0 | 84.5 |
| 800 | 970 | 169.0 | 251.5 | 138.0 | 207.0 | 97.5 | 149.5 | 67.0 | 105.5 |

Table 5.1.17.2 Spring Buffer Stroke

| Rated Car Speed, m/s (ft/min) | Stroke, mm (in.) |
|-------------------------------|------------------|
| 0.38 or less (75 or less) | 63 (2.5) |
| 0.38-0.63 (75-125) | 125 (5.0) |

Fig. 5.1.17.3 Vertical and Horizontal Components of Velocity

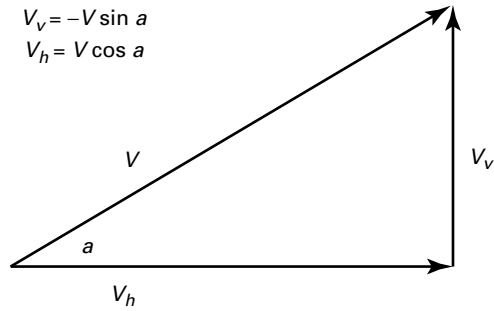

a = angle of travel above horizontal
 V = linear velocity of elevator in direction of travel
 V_h = horizontal component of velocity
 V_v = vertical component of velocity

Table 5.1.17.4.4 Minimum Oil Buffer Strokes at Given Angle From Horizontal

| Rated Speed, m/s | SI Units | | | | | Rated Speed, ft/min | Imperial Units | | | | |
|------------------|---|-------|-------|-------|-------|---------------------|--|--------|--------|-------|-------|
| | Minimum Stroke, mm, at Angle From Horizontal, deg | | | | | | Minimum Stroke, in., at Angle From Horizontal, deg | | | | |
| | 15 | 30 | 45 | 60 | 70 | | 15 | 30 | 45 | 60 | 70 |
| 1.00 | 269 | 241 | 197 | 139 | 95 | 200 | 10.58 | 9.49 | 7.74 | 5.48 | 3.75 |
| 1.12 | 340 | 305 | 249 | 176 | 120 | 225 | 13.39 | 12.00 | 9.80 | 6.93 | 4.74 |
| 1.25 | 420 | 376 | 307 | 217 | 149 | 250 | 16.53 | 14.82 | 12.10 | 8.56 | 5.85 |
| 1.50 | 605 | 542 | 443 | 313 | 214 | 300 | 23.80 | 21.34 | 17.43 | 12.32 | 8.43 |
| 1.75 | 823 | 738 | 602 | 426 | 291 | 350 | 32.40 | 29.05 | 23.72 | 16.77 | 11.47 |
| 2.00 | 1 075 | 964 | 787 | 556 | 380 | 400 | 42.32 | 37.94 | 30.98 | 21.90 | 14.98 |
| 2.25 | 1 360 | 1 220 | 996 | 704 | 482 | 450 | 53.56 | 48.02 | 39.21 | 27.72 | 18.96 |
| 2.50 | 1 679 | 1 506 | 1 229 | 869 | 595 | 500 | 66.12 | 59.28 | 48.40 | 34.23 | 23.41 |
| 3.00 | 2 418 | 2 168 | 1 770 | 1 252 | 856 | 600 | 95.21 | 85.37 | 69.70 | 49.29 | 33.71 |
| 3.50 | 3 292 | 2 951 | 2 410 | 1 704 | 1 166 | 700 | 129.60 | 116.19 | 94.87 | 67.08 | 45.89 |
| 4.00 | 4 299 | 3 855 | 3 147 | 2 226 | 1 522 | 800 | 169.27 | 151.76 | 123.91 | 87.62 | 59.93 |

supports shall be capable of resisting the bending loads of a fully loaded car and its counterweight with a total deflection not in excess of 3 mm (0.125 in.).

5.1.18.3 Guide-Rail Surfaces. Guide rails shall conform to 2.23.6, except that guide rails for inclined elevators with Type A and Type C safeties shall not be required to have finished guiding surfaces.

5.1.18.4 Safety Guide Rail. A single guide rail shall be permitted to be provided for application of the safety and for lateral guiding. It shall be located between the main guide rails.

5.1.19 Driving Machines

Driving machines shall conform to 2.24, except as modified by 5.1.19.1.

5.1.19.1 Winding Drum Machines. Winding drum machines without counterweights shall be permitted to be used for inclined elevators when the net rated load (sine of the angle of inclination times the gross load) does not exceed 454 kg (1,000 lb) and the distance of travel does not exceed 38 m (125 ft), and the rated speed does not exceed 0.50 m/s (100 ft/min).

5.1.20 Operating Devices and Control Equipment

5.1.20.1 Inspection Operation. Requirements 2.26.1.1 through 2.26.1.4 apply, except as referenced and modified in 5.1.20. Where car top is stated there, it shall also mean the uphill end emergency exit exterior inspection device location. Where an inspection operating device is located at the uphill exit, it is permitted to omit one on the car top.

5.1.20.2 Operating Requirements

(a) *Requirement 2.26.1.3.* The speed shall be limited to not exceed 0.64 m/s (125 ft/min).

(b) *Requirement 2.26.1.4.1(d)(1).* The speed shall be limited to not exceed 0.64 m/s (125 ft/min).

5.1.20.3 Top-of-Car Stop Switch. The top-of-car stop switch is not required except where access is provided to the top of car.

5.1.20.4 Machine Room Inspection. Machine room inspection shall not be provided.

5.1.20.5 Slack Rope Device. Slack rope devices shall be provided on traction driving machines of elevators having an inclination of less than 35 deg from horizontal. The devices shall be located on both the car and counterweight sides of the driving machine and conform to 2.26.2.1.

5.1.20.6 Horizontal Retardations at Emergency Electrical Stopping. Horizontal retardations induced on the car due to the emergency stopping of an inclined elevator, caused by the removal of electrical power, shall meet the requirements of 5.1.20.6.1 and 5.1.20.6.2.

5.1.20.6.1 The average horizontal retardation, measured over the total retardation time, shall not exceed 0.98 m/s^2 (3.22 ft/s^2).

5.1.20.6.2 No peak horizontal retardation value exceeding 0.98 m/s^2 (3.22 ft/s^2) shall have a time duration exceeding 0.125 s.

5.1.21 Emergency Operations and Signaling Devices

5.1.21.1 Emergency Signal and/or Communications. Each elevator shall be equipped with an alarm button or switch in the car operating station and an alarm device mounted in a location that shall be readily available to a person who is normally situated in the vicinity when the elevator is in use; or a means of voice communication to a receiving station always attended when the installation is in use. If the alarm device or means of voice communication is normally activated by utility power supply, it shall be backed up by a manual or battery operated device.

5.1.22 End-Loading Inclined Elevators

5.1.22.1 Additional Requirements. Inclined elevators that load and unload passengers through car doors located at the uphill and downhill ends of the car shall conform to the following additional requirements of 5.1.22.

5.1.22.2 Speed. The rated speed shall not exceed 0.50 m/s (100 ft/min).

5.1.22.3 Buffers. The buffers shall be oil type only, installed at both terminals, conforming to 5.1.17.4.

Requirement 2.22.4.8 does not apply to end-loading inclined elevators. The buffer shall be compressed to

within the overtravel distance when the car is level with the terminal landing. Each buffer shall be provided with a switch that shall prevent operation of the elevator by means of the normal operating device in the direction of travel towards that buffer unless it has returned to at least 90% of its stroke.

5.1.22.4 Final Terminal Stopping Devices. The final terminal stopping devices shall conform to 2.25.3.1 and 2.25.3.2, except for 2.25.3.2(a) and shall be located to operate within the reduced runby of end-loading inclined elevators.

5.1.22.5 Retractable Sills. End-loading inclined elevators shall be permitted to be equipped with retractable sill conforming to the following:

(a) They shall be designed so as to function without creating any pinching or shearing hazards.

(b) They shall be equipped with return switches conforming to 2.25.2.1.1 and 2.25.2.1.3, which shall prevent the operation of the car in the direction of travel toward that terminal unless the retractable sill returns to its normal position.

5.1.22.6 Locking Car Doors. Car door locking devices on end-loading inclined elevators shall conform to 2.14.4.2.

5.1.23 Special Requirements for Inclined Elevator Layout Drawings

The forces and loads covered by 2.28.1(b), (c), and (f) shall be calculated based on the angle of inclination from the horizontal.

SECTION 5.2**LIMITED-USE/LIMITED-APPLICATION ELEVATORS**

This Section applies to limited-use/limited-application elevators (see 1.3).

NOTE: See also Part 8 for additional requirements that apply to *limited-use/limited-application elevators*.

5.2.1 Electric Limited-Use/Limited-Application Elevators

5.2.1.1 Construction of Hoistway and Hoistway Enclosures. The construction of hoistway enclosures shall conform to 2.1, except as modified by 5.2.1.1.1 and 5.2.1.1.2.

5.2.1.1.1 Requirement 2.1.1.4 does not apply. Elevators shall be installed in a single hoistway.

5.2.1.1.2 Requirement 2.1.3 applies only when a floor is provided at the top of hoistway.

(a) *Requirement 2.1.3.1.1.* If a floor is provided, it shall be permitted to be of wood.

(b) Requirement 2.1.3.2 does not apply. The floor shall be designed in accordance with other floors in the building. Where the machine is to be supported by the

machine room floor, the floor shall be designed in accordance with 2.9.4 and 2.9.5.

(c) *Requirement 2.1.3.3.* The floor shall be permitted to be of wood.

(13) **5.2.1.2 Pits.** Pits shall conform to 2.2, except as modified by 5.2.1.2.1.

(13) **5.2.1.2.1** Requirement 2.2.2.5 does not apply.

5.2.1.3 Location and Guarding of Counterweights.

The location and guarding of counterweights shall conform to 2.3, except as follows: Where counterweight guards conforming to 2.3.2 are not provided, lightweight chains, approximately 600 mm (24 in.) in length shall be attached to the bottom of the counterweight. These chains shall be spaced at 150 mm (6 in.) intervals to provide a warning to a person in the path of the descending counterweight.

5.2.1.4 Vertical Clearances and Runbys for Cars and Counterweights. Bottom and top car clearances and runbys for cars and counterweights shall conform to 2.4, except as specified in 5.2.1.4.1 through 5.2.1.4.4.

5.2.1.4.1 Bottom Car Clearance. Elevators shall conform to 2.4.1 or 5.2.1.4.2.

5.2.1.4.2 Alternative to Bottom Car Clearance Requirements. When the car rests on its solid bumper or fully compressed buffer, no part of the car or any equipment attached thereto shall strike the pit or any part of the equipment located therein.

5.2.1.4.2.1 Where a machinery space or control space is not located in the pit, a nonremovable means shall be provided to mechanically hold the car above the pit floor to provide an area in the pit for maintenance and inspection, conforming to the following:

(a) It shall hold the car at a height of not less than 900 mm (35 in.) nor more than 2 000 mm (79 in.) above the pit floor and not less than 300 mm (12 in.) above the bottom landing sill, as measured from the underside of the car platform.

(b) The means shall be so designed and constructed as to stop and hold the car at governor tripping speed with rated load in the car.

(c) It shall not cause the stresses and deflections in car frame and platform members and their connections to exceed the limits specified in 2.15.10 and 2.15.11.

(d) If the means does not automatically activate when the lowest hoistway door is opened with the car not at the landing

(1) it shall be capable of being operated without complete bodily entry into the pit.

(2) a sign conforming to ANSI Z535.2, ANSI Z535.4, or CAN/CSA-Z321, whichever is applicable (see Part 9), shall be conspicuously displayed inside the hoistway, which shall include a warning that there is an insufficient bottom car clearance and instructions for operating the

device. The letters shall be not less than 25 mm (1 in.) in height. The sign shall be made of a durable material and shall be securely fastened.

5.2.1.4.2.2 Where a machinery space or control space is located in the pit, 2.7.5.2 applies.

5.2.1.4.3 Top Car Clearance Requirements. Top car clearance shall conform to 2.4 or 5.2.1.4.4.

5.2.1.4.4 Alternative to Top Car Clearance Requirements. (13) In existing buildings where the top car clearance conforming to 5.2.1.4.3 cannot be provided, the following shall apply:

(a) When the car has reached its maximum upper movement, no part of the car or any equipment attached thereto, other than as permitted by 5.2.1.4.4(b), shall strike the overhead structure or any part of the equipment located in the hoistway.

(b) Nonremovable means, independent of the brake, shall be provided to mechanically and electrically prevent upward movement of the car to provide an area above the car for maintenance and inspection, conforming to the following:

(1) The means shall prevent upward movement of the car to provide a refuge space complying with 5.2.1.4.5.

(2) The means shall be so designed and constructed as to stop upward movement of the car at governor-tripping speed with and without rated load in the car.

(3) The means shall not cause the stresses and deflections in car frame and platform members and their connections to exceed the limits specified in 2.15.10 and 2.15.11.

(4) A sign conforming to ANSI Z535.2, ANSI Z535.4, or CAN/CSA-Z321, whichever is applicable (see Part 9), shall be conspicuously displayed inside the hoistway, which shall include a warning that there is an insufficient top car clearance and instructions for operating the means. The letters shall be not less than 25 mm (1 in.) in height. The sign shall be made of a durable material and shall be securely fastened.

(5) The means shall be capable of being operated without complete bodily entry into the hoistway.

(6) The force to actuate the means shall not require more than 90 N (20 lbf).

(7) The top-of-car operating device shall not allow car movement until the means is actuated.

5.2.1.4.5 Refuge Space on Top of Car Enclosure. (13)

(a) An unobstructed horizontal area of not less than 0.5 m² (5.4 ft²) shall be provided on top of the car enclosure for refuge space. It shall measure not less than 600 mm (24 in.) on any side. This area shall be permitted to include the space utilized for the top emergency exit [see 2.14.1.5.1(f)]. The minimum vertical distance in the refuge area between the top of the car enclosure and the overhead structure or other obstruction shall be not

less than 1 100 mm (43 in.) when the car has reached its maximum upward movement.

(b) In any area outside the refuge space where the vertical clearance between the top of the car enclosure and the overhead structure or other obstruction is less than specified in 5.2.1.4.5(a), the top of the car enclosure shall be clearly marked. The marking shall consist of alternating 100 mm (4 in.) diagonal red and white stripes. In addition, a sign with the words "DANGER LOW CLEARANCE" shall be prominently posted on the crosshead and be visible from the entrance. The sign shall conform to ANSI Z535.2 or CAN/CSA-Z321, whichever is applicable (see Part 9). The sign shall be of such material and construction that the letters and figures stamped, etched, cast, or otherwise applied to the face shall remain permanently and readily legible.

5.2.1.5 Horizontal Car and Counterweight Clearances. Horizontal car and counterweight clearances shall conform to 2.5.

5.2.1.6 Protection of Spaces Below Hoistways. The protection of spaces below hoistways shall conform to 2.6.

5.2.1.7 Machinery Spaces, Machine Rooms, Control Spaces, and Control Rooms. Machinery spaces, machine rooms, control spaces, and control rooms shall conform to 2.7, except as modified by 5.2.1.7.1. Equipment shall be permitted to be located in rooms containing other equipment essential to the operation of the building.

NOTE: See 5.2.1.1.2 for floors of machine room and machinery spaces over or at the top of hoistway.

5.2.1.7.1 Requirement 2.7.4.1 does not apply. The minimum headroom shall be 2 000 mm (79 in.).

5.2.1.8 Equipment in Hoistways, Machinery Spaces, Machine Rooms, Control Spaces, and Control Rooms. Electrical equipment, wiring, pipes, and ducts in hoistways, machinery spaces, machine rooms, control spaces, and control rooms shall comply with 2.8.

5.2.1.9 Machinery and Sheave Beams, Supports, and Foundations. Machinery and sheave beams, supports, and foundations shall conform to 2.9.

5.2.1.10 Guarding. The guarding of exposed auxiliary equipment shall conform to 2.10.

5.2.1.11 Protection of Hoistway Landing Openings. The protection of hoistway landing openings shall conform to 2.11, except as modified by the following:

- (a) *Requirement 2.11.2.* Entrances shall be of the horizontal slide or single section swing type.
- (b) Requirement 2.11.10.3 does not apply.
- (c) Requirement 2.11.12 does not apply.
- (d) Requirement 2.11.13.5 does not apply.
- (e) Requirement 2.11.15.3 does not apply.

5.2.1.12 Hoistway Door Locking Devices and Electric Contacts, and Hoistway Access Switches. Hoistway door locking devices, hoistway door and car door electric contacts, and hoistway access switches shall conform to 2.12, except as modified by the following:

- (a) Requirement 2.12.1.5 does not apply. Combination mechanical locks and electric contacts are not permitted.
- (b) *Requirement 2.12.2.3(a).* Truck zoning devices are not permitted.
- (c) Requirement 2.12.3 does not apply.
- (d) *Requirement 2.12.7.3.3(b).* The car cannot be operated at a speed greater than 0.15 m/s (30 ft/min).

5.2.1.13 Power Operation of Hoistway Doors and Car Doors. When provided, power operation, power opening, and power closing of hoistway doors and car doors shall conform to 2.13, except as modified by 5.2.1.13.

- (a) Requirement 2.13.1 does not apply. Both car and hoistway doors shall be of the horizontally sliding type or a power-operated swinging hoistway door with a power-operated horizontally sliding car door shall be permitted. Power operation of accordion or bifold type car doors shall be permitted.
- (b) Vertically sliding doors shall not be permitted.

5.2.1.14 Car Enclosures, Car Doors, and Car Illumination. Car enclosures, car doors, and car illumination shall conform to 2.14, except as modified by the following:

- (a) *Requirement 2.14.1.4.* Cars shall not have more than one compartment.
- (b) Requirement 2.14.1.5 applies only where manual operation (see 5.2.1.28) is not provided. If a top emergency exit is provided, it shall conform to 2.14.1.5.
- (c) Requirement 2.14.1.9.1(c) does not apply. Equipment mounted to the car for freight handling shall not be permitted.
- (d) Requirement 2.14.3 does not apply.
- (e) Requirement 2.14.4.1 does not apply. An unperforated door shall be provided at each entrance to the car.
- (f) Requirement 2.14.4.3 does not apply. Doors shall be of the horizontally sliding, accordion, or bifold type and so arranged to reduce the possibility of pinching. Material shall conform to 2.14.2.1.
- (g) Requirement 2.14.4.4 does not apply.
- (h) Requirement 2.14.4.7 does not apply.
- (i) Requirement 2.14.4.9 does not apply.
- (j) Requirement 2.14.4.11(b) does not apply.
- (k) Requirement 2.14.5.1 does not apply. There shall not be more than two entrances to the car.
- (l) Requirements 2.14.5.2 and 2.14.5.3 do not apply.
- (m) *Requirement 2.14.5.7.* The dimension for the unlocking zone shall be not more than the straight vertical face of the platform guard minus 75 mm (3 in.).

5.2.1.15 Car Frames and Platforms. Car frames and platforms shall conform to 2.15, except as modified by 5.2.1.15.1 and 5.2.1.15.2.

5.2.1.15.1 Underslung or Sub-Post Frames.

Requirement 2.15.4 applies, except the term “guiding surfaces” shall be substituted for the term “guide rails.”

5.2.1.15.2 Platform Guards. Requirement 2.15.9.2 does not apply. The platform guard shall have a straight vertical face, extending below the floor surface of the platform of not less than the depth of the unlocking zone plus 75 mm (3 in.) but in no case less than the maximum distance from the landing that it takes to stop and hold the car upon detection and actuation of the device as prescribed in 2.19.2.

5.2.1.16 Capacity, Loading, Speed, and Rise

5.2.1.16.1 Rated Load and Platform Area. The minimum rated load shall conform to 2.16.1, except as follows:

- (a) The maximum rated load shall not exceed 635 kg (1,400 lb).
- (b) The inside net platform area shall not exceed 1.67 m² (18 ft²).
- (c) Requirements 2.16.1.2 and 2.16.1.3 do not apply.

5.2.1.16.2 Capacity and Data Plates

- (a) Capacity plates shall indicate the rated load of the elevator in kilograms (kg), pounds (lb), or both.
- (b) Data plates shall conform to 2.16.3.2.2.
- (c) The material and marking of plates shall conform to 2.16.3.3.

5.2.1.16.3 Additional Requirements for Passenger Overload. Elevators shall conform to 2.16.8.

5.2.1.16.4 Maximum Rated Speed. The rated speed shall not be more than 0.15 m/s (30 ft/min).

5.2.1.16.5 Maximum Rise. The maximum rise shall not be more than 7.6 m (25 ft).

5.2.1.17 Car and Counterweight. Car and counterweight safeties shall conform to 2.17, except as modified by 5.2.1.17.1.

5.2.1.17.1 Application of Safeties. The force providing the stopping action shall conform to 2.17.9.4 or the following: Where guide-rail sections other than those specified in 2.23.3(a) are used, the application of safety stopping forces shall not cause deformation of the guide-rail section upon whose dimensional stability the stopping capability is dependent.

5.2.1.18 Speed Governors. Speed governors shall conform to 2.18, except as modified by the following:

- (a) Requirement 2.18.2.1(b) does not apply. The tripping speed shall not exceed 0.38 m/s (75 ft/min). On the breakage of the suspension means, the safety shall operate without delay and independently of the governor’s speed action.
- (b) Requirement 2.18.4 does not apply.
- (c) Requirement 2.18.5. Governor ropes shall be not less than 6 mm (0.25 in.) in diameter.

5.2.1.19 Ascending Car Overspeed and Unintended Car Movement Protection. Ascending car overspeed and unintended car movement protection shall conform to 2.19 and 5.2.1.19.1.

5.2.1.19.1 Marking Plate Requirements. The marking plate requirements in 2.19.3.3 shall include the maximum distance from the landing that it takes to stop and hold the car upon detection and actuation of the device as prescribed in 2.19.2.

5.2.1.20 Suspension Ropes and Their Connections.

Suspension ropes and their connections shall conform to 2.20, except for 2.20.1 and 2.20.3. Suspension ropes and their connections shall also conform to 5.2.1.20.1 and 5.2.1.20.2.

5.2.1.20.1 Suspension Means. Cars shall be suspended by ropes attached to the car frame or passing around sheaves attached to the car frame specified in 2.15.1. Ropes that have previously been installed and used on another installation shall not be reused. Only rope having the following classifications shall be used for the suspension of limited-use/limited-application elevator cars and for the suspension of counterweights:

- (a) Iron (low-carbon steel) or steel wire rope, having the commercial classification “Elevator Wire Rope,” or wire rope specifically constructed for elevator use. The wire material for these wire ropes shall be manufactured by the open-hearth or electric furnace process or their equivalent.

- (b) Aircraft cable rope of 7 × 19 construction, classified as MIL-DTL-83420M Spec, shall be permitted in those applications where aircraft cable rope is not subjected to crushing pressures, with the following exceptions permitted:

- (1) nonjacketed, carbon steel, tin- or zinc-coated (Type 1A) 7 × 19 construction (Section 3.4.3.3 of MIL-DTL-83420M Spec)
- (2) identifying color tracer filaments are not required (Section 3.6.2 of MIL-DTL-83420M Spec)

5.2.1.20.2 Factor of Safety. The factor of safety shall be specified in accordance with the following:

- (a) “Elevator Wire Rope” [see 5.2.1.20.1(a)] shall comply with 2.20.3.
- (b) “Aircraft Cable Rope” [see 5.2.1.20.1(b)] shall have a factor of safety of not less than 7.5.

5.2.1.21 Counterweights. Counterweights shall conform to 2.21, except as modified by 5.2.1.21.1.

5.2.1.21.1 Independent Car Counterweights.

Requirement 2.21.1.4 applies, except that the counterweight shall be permitted to utilize the same guide rails as the car.

5.2.1.22 Buffers and Bumpers. Buffers and bumpers shall conform to 2.22, except as modified by 5.2.1.22.1.

5.2.1.22.1 Bumpers. Elastomeric bumpers capable of absorbing the energy of a fully loaded car shall be permitted to be used. The average deceleration shall be less than 9.81 m/s^2 (32.2 ft/s^2) with any load between 61 kg (135 lb) and rated load.

5.2.1.23 Car and Counterweight Guide Rails, Guide-Rail Supports, and Fastenings. Car and counterweight guide rails, guide-rail supports, and fastenings shall conform to 2.23, except as modified by 5.2.1.23.1 and 5.2.1.23.2.

5.2.1.23.1 Use of Common Guide Rails. The same set of guide rails shall be permitted to be used for both the car and counterweight.

5.2.1.23.2 Guide-Rail Sections. Requirements 2.23.3(a) and 2.23.3(b)(1) do not apply. Guide rails, supports, joints, fishplates, and fastenings that do not conform to 2.23 are permitted, provided that the strengths and stresses are consistent with 2.23 for the loads imposed.

Where guide-rail sections other than those specified in 2.23.3(a) are used

(a) requirement 2.23.10.2 does not apply.

(b) the rail joints shall be designed in accordance with 2.23.5.1 and shall adequately maintain the accuracy of the rail alignment.

(c) the deflections shall comply with 2.23. The allowable deflection of the guide rail shall be limited to prevent the safety device from disengaging the rail during the application of the load.

5.2.1.24 Driving Machine and Sheaves. Driving machines and sheaves shall conform to 2.24, except for 2.24.1, 2.24.2.1, and 2.24.2.2. Driving machines and sheaves shall also conform to 5.2.1.24.1 through 5.2.1.24.3.

5.2.1.24.1 Type of Driving Machines. All driving machines shall be of the traction type, except that winding drum machines that do not have multiple cable layers on the drum shall be permitted for elevators, subject to the following: They shall not be provided with counterweights.

5.2.1.24.2 Material and Grooving. Sheave material and grooving shall be subject to the following:

(a) Sheaves and drums used with "Elevator Wire Rope" [see 5.2.1.20.1(a)] shall be of metal and provided with finished grooves for ropes or shall be permitted to be lined with nonmetallic groove material.

(b) Sheaves and drums used with "Aircraft Cable Rope" [see 5.2.1.20.1(b)] shall be of metal and provided with finished "U" grooves that do not subject the aircraft cable rope to crushing pressure.

5.2.1.24.3 Minimum Pitch Diameter. Sheaves and drums used with suspension and compensating ropes shall have a pitch diameter of not less than the following:

(a) For all "Elevator Wire Rope," the diameter shall not be less than 30 times the diameter of the rope, where used with suspension ropes.

(b) For all "Elevator Wire Rope," the diameter shall not be less than 30 times the diameter of the rope, where used with compensating ropes.

(c) For "7 × 19 Aircraft Cable Rope," the diameter shall not be less than 21 times the diameter of the rope, where used with either suspension ropes or compensating ropes.

5.2.1.25 Terminal Stopping Devices. Terminal stopping devices shall conform to 2.25, except as follows:

(a) Requirement 2.25.4 does not apply.

(b) If the driving machine is of the winding drum type, a lower final terminal stopping device shall be used in addition to the slack-rope switch, and two independent upper final terminal stopping devices shall be provided. A separate device shall be used to operate the lower final terminal and one upper final terminal stopping device. All final terminal stopping and slack-rope devices shall operate independently of one another. The power feed lines to the driving machine and brake shall be opened by one or both of the upper final terminal stopping devices and either the slack-rope switch or the lower terminal stopping device, or both.

5.2.1.26 Operating Devices and Control Equipment. Operating devices and control equipment shall conform to 2.26, except as modified by the following:

(a) Requirement 2.26.1.3 does not apply.

(b) Requirement 2.26.2.5 does not apply.

(c) Requirement 2.26.2.10 does not apply.

(d) Requirement 2.26.2.12 does not apply.

(e) Requirement 2.26.2.16 does not apply.

5.2.1.27 Emergency Operations and Signaling Devices. Emergency operation and signaling devices shall conform to 2.27, except as modified by 5.2.1.27.1.

5.2.1.27.1 Phase II Emergency In-Car Operation shall not be provided.

5.2.1.28 Manual Operation. Elevators shall be permitted to be arranged for manual operation in case of power failure. The manual operating device shall conform to the following:

(a) It shall not be accessible from inside the car.

(b) It shall not release the brake.

(c) Upon removal of the device, the car shall not move.

(d) It shall be actuated by mechanical means only.

(e) Instructions shall be posted at or near the manual operating device.

5.2.1.29 Layout Data. The information provided on layout data shall conform to 2.28.

5.2.1.30 Welding. Welding shall conform to 8.8.

5.2.1.31 Identification. Identification shall conform to 2.29.

5.2.2 Hydraulic Limited-Use/Limited-Application Elevators

Hydraulic limited-use/limited-application elevators shall conform to 5.2.1, except as modified by 5.2.2.1 through 5.2.2.15.

(13) 5.2.2.1 Bottom and Top Clearances and Runbys.

Bottom and top clearances and runbys for cars and counterweights shall conform to 3.4, except as follows:

(a) Bottom car clearances shall conform to 3.4.1 or 5.2.1.4.2.

(b) Requirement 3.4.2.1 does not apply. The bottom car runby shall not be less than 50 mm (2 in.).

(c) The top car clearances shall conform to 5.2.1.4.4 or 5.2.2.1.1.

(13) 5.2.2.1.1 Top Car Clearance.

The top car clearance shall not be less than the sum of the following two items (see Nonmandatory Appendix G);

(a) the top car runby

(b) the height of the refuge space on top of the car (see 3.4.7) or the clearance required for equipment projecting above the car top or crosshead (see 3.4.5), whichever is greater.

5.2.2.2 Machinery Spaces, Machine Rooms, Control Spaces, and Control Rooms. Machinery spaces, machine rooms, control spaces, and control rooms shall comply with 3.7, except as modified by 5.2.1.7.

5.2.2.3 Car Frames and Platforms. Car frames and platforms shall conform to 3.15, except as modified by 5.2.1.15.2.

5.2.2.4 Capacity and Loading. The capacity and loading shall conform to 3.16, except as modified by 5.2.1.16.1 and 5.2.1.16.2. Requirement 5.2.1.16.3 does not apply.

5.2.2.5 Alternative to Speed Governor for Roped-Hydraulic Elevators. Car and counterweight safeties and plunger gripper shall conform to 3.17, except as modified by 5.2.2.5.1 and 5.2.2.5.2.

NOTE: See also 5.2.1.18.

5.2.2.5.1 The safeties on roped-hydraulic elevators shall be operated by a speed governor or shall be permitted to be operated by inertia where an overspeed valve conforming to 3.19.4.7 is provided.

5.2.2.5.2 Upon the parting of the suspension ropes, the safeties shall apply without appreciable delay and their application shall be independent of the location of the break in the ropes and shall be permitted to be accomplished by the use of restrained compression

springs or by the action of gravity, or by both, or by positive mechanical means.

5.2.2.6 Hydraulic Jacks and Sheaves. Hydraulic jacks and sheaves shall conform to 3.18. The reference in 3.18.1.2.1 to 2.20 shall be modified by 5.2.1.20. The reference in 3.18.1.2.3 to 2.24.2 shall be modified by 5.2.1.24.2 and 5.2.1.24.3. (13)

5.2.2.7 Valves, Pressure Piping, and Fittings. Valves, pressure piping, and fittings shall conform to 3.19. Requirement 5.2.1.28 does not apply.

5.2.2.8 Counterweights. Counterweights shall conform to 3.21.

5.2.2.9 Buffers and Bumpers. Buffers and bumpers shall conform to 3.22, except as modified by 5.2.1.22.1.

5.2.2.10 Guide Rails, Guide-Rail Supports, and Their Fastenings. Guide rails, guide-rail supports, and their fastenings shall conform to 2.23, except as modified by 3.23 and 5.2.1.23.2.

5.2.2.11 Hydraulic Machines and Tanks. Hydraulic machines and tanks shall conform to 3.24. Requirement 5.2.1.24 does not apply, except as modified by 5.2.2.6.

5.2.2.12 Terminal Stopping Devices. Requirement 5.2.1.25 does not apply. Terminal stopping devices shall conform to 3.25.1 and 3.25.3.

5.2.2.13 Operating Devices and Control Equipment. Requirement 5.2.1.26 does not apply. Operating devices and control equipment shall conform to 3.26.

5.2.2.14 Emergency Operations and Signaling Devices. Requirement 5.2.1.27 does not apply. Emergency operations and signaling devices shall conform to 3.27, except as modified by 5.2.2.14.1.

5.2.2.14.1 Phase II Emergency In-Car Operation shall not be provided.

5.2.2.15 Layout Data. Requirement 5.2.1.29 does not apply. The information provided on layout data shall conform to 3.28.

SECTION 5.3 PRIVATE RESIDENCE ELEVATORS

(13)

Requirements in Section 5.3 apply to elevators installed in or at a private residence. Section 5.3 also applies to similar elevators installed in buildings as a means of access to private residences within such buildings provided the elevators are so installed that they are not accessible to the general public or to other occupants in the building. Elevators conforming to the requirements of Part 2, Part 3, or Sections 4.1, 4.2, or 5.2 are not prohibited from being installed in or at a private residence.

NOTE: See also Part 8 for additional requirements that apply to *private residence elevators*.

5.3.1 Private Residence Electric Elevators

- (13) **5.3.1.1 Construction of Hoistway and Hoistway Enclosures.** The hoistway shall be solidly enclosed throughout its height without grillwork or openings other than for landing or access doors, except that any exterior windows within the hoistway shall be protected by metal grillwork. Grillwork shall reject a ball 76 mm (3 in.) in diameter and shall be securely fastened from the inside of the hoistway. Enclosures shall be of sufficient strength to support in true alignment the hoistway doors and gates and their locking equipment. The fire resistance rating shall be in accordance with the requirements of the building code. Non-fire-resistive enclosures shall be permitted to be glass complying with 2.1.1.2.2(e).

5.3.1.1.1 The enclosure shall be permitted to be omitted on the lowest landing served, provided the elevator

- (a) does not open directly into a garage
- (b) has continuous-pressure operation
- (c) car platform is equipped with a device that, if the platform is obstructed in its downward travel by a force of 18 N (4 lbf) or more applied anywhere at its lower surface, will open an electric contact in the control circuit and thus stop the downward travel of the car within 75 mm (3 in.). The stroke of the device shall be not less than the stopping distance of the platform. This device shall be of a type that will not reset unless it has been returned to its normal position. The elevator shall be permitted to operate in the up direction.

5.3.1.1.2 The enclosure shall be permitted to be omitted on the upper landing on continuous-pressure operation elevators serving only adjacent landings (one-floor rise) conforming to one of the following:

- (a) the floor opening at the upper landing is protected by a partial enclosure and gate at least 910 mm (36 in.) high with openings that will reject a ball 25 mm (1 in.) in diameter and the gate is provided with a combination mechanical lock and electric contact
- (b) the floor opening is provided with a vertically lifting hatch cover which is automatically raised and lowered vertically by the ascending and descending car, provided this cover meets the following requirements:
 - (1) It is fitted with guides to ensure its proper seating.
 - (2) It is designed and installed to sustain a total load of 3.6 kPa (75 lbf/ft²) or 135 kg (300 lb) at any one point.
 - (3) It is equipped with an electric contact that will prevent the upward travel of the car when a force of 90 N (20 lbf) is placed at any point on the top of the hatch cover.

5.3.1.2 Pits

5.3.1.2.1 Guarding of Pits. A pit provided in other than a fully enclosed hoistway shall be guarded by a

solid enclosure at least 2 130 mm (84 in.) high. The entrance shall be provided with a door conforming to 5.3.1.7. When the enclosure does not extend from floor to ceiling, only solid car doors or gates rejecting a 13 mm (0.5 in.) diameter ball shall be used.

5.3.1.2.2 Pit Maintenance. Where a pit is provided, it shall be kept clean and free from dirt and rubbish and the accumulation of water. It shall not be used for storage purposes.

5.3.1.2.3 Stop Switch in Pits. Stop switches conforming to 2.2.6 shall be installed in the pit of each elevator. (13)

5.3.1.3 Top Car Clearance. The top car clearance shall be not less than 152 mm (6 in.) plus 25 mm (1 in.) for each 0.017 m/s (3.3 ft/min) of the rated speed in excess of 0.15 m/s (30 ft/min). Where the machine or its controls are located on the top of the car, a refuge space on top of the car enclosure shall be provided in conformance with 2.4.12.

5.3.1.4 Horizontal Car Clearances

5.3.1.4.1 Between Car and Hoistway Enclosures or Counterweight. There shall be a clearance of not less than 20 mm (0.75 in.) between the car and the hoistway enclosure, and between the car and its counterweight.

5.3.1.4.2 Between Car and Landing Sill. The clearance between the car platform sill and the landing sill shall be not less than 13 mm (0.5 in.) nor more than 32 mm (1.25 in.).

5.3.1.5 Pipes in Hoistways. Pipes conveying steam, gas, or liquids, which if discharged into the hoistway would endanger life, shall not be installed in the hoistway.

5.3.1.6 Guarding of Suspension Means

5.3.1.6.1 Suspension Means Passing Through Floors or Stairs. Ropes and chains passing through a floor or stairway outside the hoistway enclosure shall be enclosed with a solid or openwork enclosure. If of openwork, the enclosure shall reject a ball 13 mm (0.5 in.) in diameter. Means for inspection shall be provided. The floor openings shall not be larger than is necessary to clear the suspension means.

5.3.1.6.2 Suspension or Support Means Having an Opening Facing Away From the Stair. Suspension or support means that operate within a guide or track whose segments total a minimum of 270 deg shall be considered suitably guarded, provided that the centerline of the opening in the guide or track is 180 deg from the closest point of the stair. See Nonmandatory Appendix H, Fig. H-1.

5.3.1.7 Protection of Hoistway Openings

5.3.1.7.1 Where Required. Where a hoistway enclosure is required, landing openings shall be protected by swinging or horizontally sliding doors or gates. Landing openings in solid hoistway enclosures shall be protected the full height by solid swinging or horizontally sliding doors. Their fire-protection rating shall be not less than required by the building code (see 1.3). The doors or gates shall be designed to withstand a force of 670 N (150 lbf) applied horizontally over an area 100 mm × 100 mm (4 in. × 4 in.) in the center of the doors or gates without permanent displacement or deformation.

5.3.1.7.2 Clearance Between Hoistway Doors or Gates and Landing Sills and Car Doors and Gates. The clearance between the hoistway doors or gates and the hoistway edge of the landing sill shall not exceed 75 mm (3 in.). The distance between the hoistway face of the landing door or gate and the car door gate shall not exceed 125 mm (5 in.).

5.3.1.7.3 Projection of Hoistway Doors or Gates Into the Hoistway. The hoistway face of the hoistway door or gate shall not project into the hoistway beyond the line of the landing sill. No hardware, except that required for door-locking and door-operating or signaling devices, shall project into the hoistway beyond the line of the landing sill.

5.3.1.7.4 Locking Devices for Hoistway Doors and Gates. Hoistway doors or gates shall be provided with locking devices.

The locking device shall be of a type that will

(a) either prevent car movement unless the door is locked in the closed position; or

(b) permit the car to start if the door or gate is in the closed position but not locked, provided that the device stops the car if the door or gate fails to lock before the car has moved 150 mm (6 in.) away from the landing. The device shall also prevent the opening of the hoistway door or gate unless the car is within 150 mm (6 in.) of the landing.

The locking device shall conform to 2.12.4.

5.3.1.7.5 Opening of Hoistway Doors or Gates.

Hoistway doors or gates shall be so arranged that it will not be necessary to reach behind any panel, jamb, or sash to operate them.

5.3.1.7.6 Hangers and Stops for Hoistway Sliding Doors. Means shall be provided to prevent a sliding hoistway door from disengaging from its track.

5.3.1.7.7 Access to the Hoistway for Emergency Purposes. Hoistway door unlocking devices shall be provided for all hoistway doors and gates, conforming to 2.12.6.

5.3.1.7.8 Power Operation of Hoistway Doors and Gates. Power opening shall be permitted for hoistway doors and gates and shall conform to 2.13.2.2.1 and 2.13.2.2.2. Power closing shall be permitted for hoistway doors and gates and shall conform to 2.13.3.2 through 2.13.4, and 2.13.6.

5.3.1.7.9 Landing-Sill Guards. Where the elevator is equipped with a two-way leveling device or anticreep device, and the hoistway landing sill projects into the hoistway, a landing-sill guard shall be provided conforming to the following:

(a) it shall have a straight vertical face extending below the sill not less than the depth of the zone where the hoistway door is unlocked below the landing sill plus 50 mm (2 in.)

(b) it shall extend not less than the width of the clear car opening exposed to the landing sill

(c) it shall be securely braced and fastened in place to withstand a force of 670 N (150 lbf) applied horizontally over an area 100 mm × 100 mm (4 in. × 4 in.) in the center of the guard without permanent displacement or deformation

5.3.1.8 Car Enclosures, Car Doors and Gates, and Car Illumination

5.3.1.8.1 Car Enclosure

(a) *Car Enclosure Required.* Except at entrances, cars shall be enclosed on all sides and on the top. The enclosure shall be constructed of solid or of openwork material that will reject a ball 13 mm (0.5 in.) in diameter.

(b) *Securing Enclosures.* Car enclosures shall be secured in conformance with 2.14.1.2 and 2.14.1.3.

(c) *Glass, Plastic, or Acrylics in Elevator Cars.* Glass, plastic, or acrylics, where used in elevator cars, shall conform to the following:

(1) if of glass, it shall meet the requirements of 2.14.1.8

(2) if of plastic or acrylic, it shall meet the requirements of ANSI Z97.1, 16 CFR Part 1201, or CAN/CGSB-12.1, CAN/CGSB-12.11, and CAN/CGSB-12.12, whichever is applicable

(d) *Access Panels for Elevator Equipment Outside of the Car.* Equipment access panels in the car for access to equipment outside the car shall comply with 2.7.5.1.4.

(e) *Number of Compartments.* The car shall not have more than one compartment.

5.3.1.8.2 Car Doors and Gates. A car door or gate that, when closed, will guard the opening to a height of at least 1 675 mm (66 in.) shall be provided at each entrance to the car. Car doors shall be permitted to be of solid or openwork construction that will reject a ball 75 mm (3 in.) in diameter.

Collapsible car gates shall be of a design that, when fully closed (extended position), will reject a ball 75 mm (3 in.) in diameter.

(a) *Power Operation of Car Doors and Gates.* Power opening shall be permitted for car doors and gates, and shall conform to 2.13.2.1 and 2.13.6. Power closing shall be permitted for car doors and gates, and shall conform to 2.13.3 through 2.13.6.

(b) *Car Door or Gate Locking Devices.* Where the hoistway enclosure is not continuous for the full travel of the car, the car door or gate shall be provided with a mechanical lock that will lock the car door or gate if the car is more than 150 mm (6 in.) away from a landing.

(c) *Car Door or Gate Electric Contacts.* Every car door or gate shall be provided with an electric contact conforming to 2.14.4.2.3 and 2.14.4.2.5.

The design of the car door or gate electric contacts shall be such that for a sliding door or gate, the car cannot move unless the door or gate is within 50 mm (2 in.) of the closed position. If the door or gate swings outward to open, the car door or gate must be closed and locked before the car can move.

5.3.1.8.3 Light in Car. The car shall be provided with an electric light. The light shall be controlled by a switch located in the car and near the car entrance, or by automatic means in conformance with 2.14.7.2.2. The minimum illumination at the car threshold, with the door closed, shall be not less than 50 lx (5 fc).

5.3.1.9 Car Frames and Platforms

5.3.1.9.1 Car Frame

(a) *Where Required.* Every elevator shall have a car frame to which the suspension or support means and the safeties are attached.

(b) *Material Permitted.* Car frames shall be made of metal.

(c) *Factor of Safety.* The factor of safety shall be not less than 5 based on the rated load.

(d) *Use of Cast Iron.* Cast iron shall not be used in any member other than for guides or guide shoe brackets.

(e) *Location of Guiding Means.* Primary guiding means shall be attached to the car frame.

5.3.1.9.2 Platforms

(a) *Construction.* Platforms shall be of non-perforated metal or wood. If constructed of wood, they shall be laminated.

Platforms shall be supported by a platform frame or formed metal support pan attached to the car frame. Platforms and platform frame assemblies shall have a safety factor of 5.

(b) *Platform Guards (Aprons).* Where the elevator is equipped with a two-way leveling device, the entrance side(s) of the platform shall be provided with a guard conforming to 2.15.9, except as modified by the following:

(1) Requirement 2.15.9.2 does not apply. The platform guard shall have a straight vertical face, extending below the floor surface of the platform not less than the

depth of the zone where the hoistway door is unlocked above the landing sill plus 50 mm (2 in.). The platform guard shall not strike the pit floor or any obstruction when the elevator is at its lowest point of travel.

5.3.1.10 Capacity, Loading, Speed, and Rise

5.3.1.10.1 Capacity. The maximum inside net platform area shall not exceed 1.4 m² (15 ft²). The minimum rated load shall be not less than the following:

(a) For net platform areas up to and including 1.1 m² (12 ft²), the rated load shall be not less than 195 kg/m² (40 lb/ft²) or 159 kg (350 lb), whichever is greater.

(b) For net platform areas greater than 1.1 m² (12 ft²), the rated load shall be based upon 305 kg/m² (62.5 lb/ft²).

5.3.1.10.2 Speed. The rated speed shall not exceed 0.20 m/s (40 ft/min).

5.3.1.10.3 Rise. The rise shall not exceed 15 m (50 ft).

5.3.1.11 Safeties and Governors

5.3.1.11.1 Safeties Required. Each elevator shall be provided with a car safety as specified in 2.17.5. Where the space below the hoistway is not permanently secured against access, the counterweight shall be provided with a safety. (13)

5.3.1.11.2 Operation of Safeties. The safety shall be of the inertia, rack and pinion, or other type operated by the breakage of the suspension means or by the action of a speed governor. If of the speed-governor type, the governor shall operate the safety at a maximum tripping speed of 0.38 m/s (75 ft/min). On the breakage of the suspension means, the safety shall operate without delay and independently of the speed governor action. (ED)

5.3.1.11.3 Application of Safeties. The application of safeties shall conform to 2.17.9.1, 2.17.9.2, and 2.17.9.3. The forces providing the stopping action shall conform to 2.17.9.4 or the following:

(a) Where guide-rail sections other than those specified in 2.23.3(a) are used, the application of safety stopping forces shall not cause deformation of the guide-rail section upon whose dimensional stability the stopping capability of the safeties is dependent.

(b) Where the car safety is of the rack-and-pinion type, it shall conform to 4.1.9.

5.3.1.11.4 Materials Used in Safeties. The minimum factors of safety and stresses of safety parts and rope connections shall conform to 2.17.12.

5.3.1.11.5 Location of Speed Governor. Where a speed governor is used, it shall be located where it is readily accessible from outside the hoistway and it cannot be struck by any moving object in normal operation or under conditions of overtravel, and where there is sufficient space for full movement of the governor parts.

5.3.1.11.6 Opening of the Motor and Brake Circuit on Safety Application. Where a speed governor is used, the motor circuit and the brake circuit shall be opened before or at the time that the safety applies.

- (13) **5.3.1.11.7 Speed Governor Marking Plate.** Where a speed governor is provided, a metal plate shall be securely attached to each speed governor and shall be marked in a legible and permanent manner with letters and figures not less than 6 mm (0.25 in.) in height indicating the following:

- (a) the speed in m/s (ft/min) at which the governor is set and sealed to cause the governor to trip
- (b) the size, material, and construction of the governor rope
- (c) if the governor is of the governor rope retarding type, the governor pull-through tension (force) in N (lbf)
- (d) manufacturer's name or trademark
- (e) statement "DO NOT LUBRICATE GOVERNOR ROPE"

- (13) **5.3.1.11.8 Governor Ropes.** The governor ropes, where used, shall be of iron, steel, monel metal, or phosphor bronze not less than 6 mm (0.25 in.) in diameter. Tiller-rope construction shall not be used.

5.3.1.12 Suspension Means

5.3.1.12.1 Types Permitted

(a) Suspension means shall be not less than two wire ropes or two steel roller-type chains conforming to ASME B29.1.

(b) Aircraft cable rope of 7 × 19 construction, classified as Mil Spec 83420, shall be permitted in those applications where aircraft cable rope is not subjected to crushing pressures. The following exceptions to Mil Spec 83420 are permitted:

- (1) nonjacketed carbon steel, tin-, or zinc-coated (Type 1-A) 7 × 19 construction (Section 3.2.4 of Mil Spec 83420)
- (2) identifying color tracer filaments are not required (Section 3.5.2 of Mil Spec 83420)

5.3.1.12.2 Suspension Ropes. On elevators having a rated load of 230 kg (500 lb) or less and operating at a rated speed of 0.15 m/s (30 ft/min) or less, suspension ropes shall be not less than 6 mm (0.25 in.) in diameter. Where the rated load exceeds 230 kg (500 lb) or the rated speed exceeds 0.15 m/s (30 ft/min), the ropes shall be not less than 9 mm (0.375 in.) in diameter.

5.3.1.12.3 Factor of Safety of Suspension Means.

The factor of safety of the suspension means shall be not less than 7 for cars with less than or equal to 1.1 m² (12 ft²) of net platform area, and not less than 7.5 for cars with more than 1.1 m² (12 ft²) of net platform area, based on the manufacturer's rated breaking strength.

When the car and counterweight are suspended by steel ropes and the driving means is an endless steel

roller-type chain, the factor of safety of such chain with the rated load in the car shall be not less than 8 based on the ultimate tensile strength.

5.3.1.12.4 Arc of Contact of Suspension Means on Sheaves and Sprockets. The arc of contact of a wire rope on a traction sheave shall be sufficient to produce traction under all load conditions up to rated load. The arc of contact of a chain with a driving sprocket shall not be less than 140 deg.

5.3.1.12.5 Spare Rope Turns on Winding Drums. The spare rope turns on winding drums shall conform to 2.20.7.

5.3.1.12.6 Securing of Wire Suspension Ropes to Winding Drums. The securing of wire suspension ropes to winding drums shall conform to 2.20.6.

5.3.1.12.7 Fastening of Wire Rope Suspension Means to Car or to the Counterweight. The fastening of a wire rope suspension means to a car or to a counterweight shall conform to 2.20.9, or by properly attached fittings as recommended by wire rope manufacturers.

5.3.1.13 Counterweights

5.3.1.13.1 General Requirements. Counterweights, where used, shall conform to the following:

- (a) Counterweights shall run in guide rails.
- (b) Where a car counterweight is used, it shall not be of sufficient weight to cause slackening of any rope during acceleration or retardation of the car.
- (c) The counterweight sections, whether carried in a frame or not, shall be fastened together and shall also be secured to prevent shifting by an amount that will reduce the running clearance to less than 19 mm (0.75 in.) between the counterweight and hoistway.

5.3.1.13.2 Location and Guarding of Counterweights

(a) *Counterweight on Cars Operating Through Hatch Covers.* If a car operates through a hatch cover, the counterweight runway shall be enclosed throughout its height.

(b) *Counterweight Coming Down to Floors or Passing Floors or Stairs.* Where the counterweight runway comes down to a floor or passes floors or stairs, it shall be guarded to a height of at least 2 130 mm (84 in.) above the floor or the stair treads by a solid or openwork enclosure. Openwork enclosures shall reject a ball 13 mm (0.5 in.) in diameter.

(c) *Access to Enclosed Counterweights and Ropes.* Access shall be provided for inspection, maintenance, and repair of an enclosed counterweight and its ropes. Doors on the counterweight enclosure shall be self-closing and self-locking and openable from the outside only with a suitable key. If the enclosure is of such size that the door can be closed when the enclosure is occupied by a person, the door shall be easily openable from the

inside without the use of a key or other instrument. A stop switch conforming to 2.26.2.5 shall be located adjacent to and inside the opening and operable without entering the enclosure.

5.3.1.14 Buffers and Buffer Supports

- (13) **5.3.1.14.1** The car and counterweight shall be provided with spring or oil buffers or elastomeric bumpers, except as specified in 5.3.1.14.3.

(a) Spring buffers shall be so designed and installed that they will not be fully compressed when struck by the car with its rated load or by the counterweight traveling at 125% of the rated speed, or at governor tripping speed where a governor-operated safety is used.

(b) Oil buffers shall comply with 2.22.4.

(c) Elastomeric bumpers capable of absorbing the energy of a fully loaded car shall be permitted to be used. The average deceleration shall be less than 9.81 m/s^2 (32.2 ft/s^2) with any load between 61 kg (135 lb) and rated load.

The elastomeric bumpers shall be marked with the manufacturer's recommended replacement criteria.

5.3.1.14.2 Car and counterweight buffer supports shall be of sufficient strength to withstand without failure the impact resulting from buffer engagement at 125% of the rated speed, or at governor tripping speed where a governor-operated safety is used.

5.3.1.14.3 Buffers shall be permitted to be omitted when the striking speed is 0.25 m/s (50 ft/min) or less if the space below the car and counterweight consists of a nonoccupiable area, and the floor below the car and counterweight has sufficient strength to withstand, without failure, the impact of the car with rated load and counterweight descending at 125% of rated speed or governor tripping speed if a governor is provided.

5.3.1.15 Car and Counterweight Guide Rails and Guide Fastenings. Car and counterweight guide rails and their fastenings shall conform to 2.23.2, 2.23.5, 2.23.6, 2.23.8, and 2.23.9. Where guide-rail sections other than those specified in 2.23.3(a) are used, the allowable deflection of the guide rail shall be limited to prevent the safety device from disengaging the rail during the application of the load.

5.3.1.16 Driving Machines, Sheaves, and Their Supports

5.3.1.16.1 Overhead Machinery Beams and Supports

(a) *Securing of Machinery Beams and Types of Supports.* All machinery and sheaves shall be so supported and secured as to prevent any part from becoming loose or displaced.

Beams supporting machinery shall be of steel, sound timber, or reinforced concrete.

(b) *Overhead Beams and Their Supports.* Overhead beams and their supports shall be designed for not less than the sum of the following:

(1) the load resting on the beams and their supports, which shall include the complete weight of the machine, sheaves, controller, and any other equipment supported thereon

(2) the sum of the tension on all suspension ropes or chains times 2

(c) *Factor of Safety for Overhead Beams and Supports.* The factor of safety for overhead beams and supports based on ultimate strength of material shall be not less than 5 for steel, and 6 for timber and reinforced concrete.

5.3.1.16.2 Driving Machines: General Requirements

(a) *Types of Driving Means.* The driving means shall be one of the following types:

(1) traction

(2) winding drum (see 5.3.1.16.3)

(3) direct plunger hydraulic (see 5.3.2)

(4) roped-hydraulic (see 5.3.2)

(5) screw machine (see 5.3.1.16.4)

(6) chain drive

(7) chain-hydraulic (see 5.3.2)

(8) rack-and-pinion, in jurisdictions enforcing NBCC

(b) *Material for Sheaves and Drums and Minimum Diameter*

(1) Winding drums, traction sheaves, and overhead and deflecting sheaves shall be of cast iron or steel and the pitch diameter shall be not less than one of the following:

(a) 30 times the diameter of the wire suspension means

(b) 21 times the diameter of the wire suspension means for 8×19 steel rope or for 7×19 aircraft cable allowed by 5.3.1.12.1

(2) The rope grooves shall be machined and designed to conform to 2.24.2.1 and 2.24.2.3.

(3) The factor of safety, based on the static load (the rated load plus the weight of the car, ropes, counterweights, etc.) to be used in the design of the driving machine and sheaves shall be not less than 8 for wrought iron and steel, and 10 for cast iron and cast steel and other metals.

(c) *Fastening of Driving Machines and Sheaves to Underside of Overhead Beams*

(1) Overhead driving machines or sheaves shall not be fastened to the underside of the supporting beams, except for idlers or deflecting sheaves including their guards and frames.

(2) Cast iron in tension shall not be used for supporting idler and deflecting sheaves where they are hung beneath the beams.

(d) *Fastenings Transmitting Load.* Fasteners transmitting load shall conform to 2.24.4.

(e) *Friction Gearing, Clutch Mechanisms, or Couplings.* Friction gearings or clutch mechanisms shall not be used for connecting the drum or drive sheave to the main drive gear. Couplings shall not be used for connecting the output shaft to the main drive gear.

(f) *Use of Cast Iron in Gears.* Worm gearing having cast iron teeth shall not be used.

(g) *Driving-Machine Roller Chains and Sprockets.* Driving-machine chains and sprockets shall be of steel and shall conform in all particulars of design and dimensions to ASME B29.1.

(h) *Driving-Machine Brakes.* Driving machines, except hydraulic driving machines, shall be equipped with electrically released, mechanically applied brakes conforming to 2.24.8. The operation of the brake shall conform to 2.26.8.

(i) *Manual Operation.* Private residence elevators shall be arranged for manual operation in case of power failure. The manual operating device shall conform to the following:

- (1) It shall not be accessible from inside the car.
- (2) It shall not release the brake.
- (3) Upon removal of the device, the car shall not move.
- (4) It shall be actuated by mechanical means only.
- (5) Elevators with hydraulic driving machines shall be provided with a manual lowering valve conforming to 3.19.4.4.
- (6) Instructions shall be posted at or near the manual operating device.

(j) *Car Top Mounted Machine or Controller.* Where the machine or its controls are located on top of the car

- (1) they shall be protected by a solid, noncombustible enclosure
- (2) the car top enclosure shall be designed and installed in conformance with 2.14.1.6
- (3) a top-of-car operating device shall be provided in conformance with 2.26.1.4.2
- (4) access shall be provided to the machine or its controls for maintenance. Access panels shall conform to 5.3.1.8.1(d).

5.3.1.16.3 Winding Drum Machines. Winding drum machines shall not be provided with counterweights.

5.3.1.16.4 Screw Machines. Screw machines, where used, shall conform to 4.2.15 and 4.2.20, except that the rated speed shall not exceed 0.20 m/s (40 ft/min).

5.3.1.16.5 Traction Machines. Traction machines shall be provided with a suspension means retainer or

restraint on the drive sheave conforming to one of the following:

(a) *Suspension Means Retainers.* Suspension means retainers shall be continuous over not less than two-thirds of the arc of contact between the suspension means and its sheave or drum and shall be so located that not more than one-sixth of the arc of contact is exposed at each end of the retainer. For double-wrap traction applications the arc of contact for sheaves or drums shall be that length of arc that is uninterrupted by the entry/exit of the suspension means leading to/from the car or counterweight.

(b) *Suspension Means Restraints.* One suspension means restraint, where the arc of contact is 30 deg or less, shall be located at the midpoint of the arc of contact; or, where the arc of contact exceeds 30 deg, suspension means restraints shall be provided at intervals not exceeding 30 deg of arc along the arc of contact and at each end of the arc of contact.

5.3.1.17 Terminal Stopping Devices

5.3.1.17.1 Stopping Devices Required

(a) Upper and lower normal terminal stopping devices operated by the car shall be provided, and shall be set to stop the car at or near the upper and lower terminal landings.

(b) Upper and lower final terminal stopping devices operated by the car to remove power from the motor and the brake shall be provided. They shall be set to stop the car after it travels past the normal terminal stopping device and before an obstruction is struck.

A slack-rope switch conforming to 2.26.2.1 shall be permitted to be used as the lower final terminal stopping device.

(c) If the driving machine is of the winding drum or sprocket and chain-suspension type

(1) a final terminal stopping device operated by the driving machine shall also be provided.

(2) driving-machine-operated final terminal stopping devices are not required when a lower final terminal stopping device is used in addition to the slack-rope switch, and two independent upper final terminal stopping devices are provided. A separate device shall be used to operate the lower final terminal and one upper final terminal stopping devices. All final terminal stopping and slack-rope devices shall operate independently of one another. The power feed lines to the driving machine and brake shall be opened by one or both of the upper final terminal stopping devices and either the slack-rope switch or the lower terminal stopping device, or both.

(3) indirect connections between the final terminal stopping device and the driving machine shall be designed to prevent slippage.

(d) Terminal stopping switches shall conform to 2.25.1.

5.3.1.17.2 Operation of the Stopping Devices. The final terminal stopping device shall act to prevent movement of the car in both directions of travel. The normal and final terminal stopping devices shall not control the same switches on the controller unless two or more separate and independent switches are provided, two of which shall be closed to complete the motor and brake circuit in each direction of travel.

5.3.1.18 Operating Devices and Control Equipment

5.3.1.18.1 Type of Operation. The operation of the car shall be by continuous-pressure means or by automatic means.

5.3.1.18.2 Control and Operating Circuit Requirements. The design and installation of the operating circuits shall conform to 5.3.1.18.2.1 and 5.3.1.18.2.2.

(13) 5.3.1.18.2.1 Design and Installation

(ED) (a) The completion or maintenance of an electric circuit shall not be used neither to interrupt the power to the elevator driving machine or brake at the terminal landings, nor to stop the car when any electrical protective device operates.

(b) If springs are used to actuate switches, contactors, or relays to stop an elevator at the terminal landings, they shall be of the restrained compression type.

(c) The occurrence of a single ground or the failure of any single magnetically operated switch, contactor, or relay, or the failure of any single solid-state device, or a software system failure, shall not

(1) render any electrical protective devices ineffective

(2) permit the car to start if any hoistway door or car door or gate is not in the closed position

(d) If an instantaneous reversible motor is not used, a protective device or circuit shall be provided to prevent the motor from continuing in the same direction if the reversing control is actuated.

5.3.1.18.2.2 Monitoring of the Car Door or Gate Switch Electric Contacts. The elevator controls shall be designed in such a manner that when the car stops at a floor and the landing door or gate and its related electric contact are opened and closed and the car door or gate switch electric contact(s) fails to open, the car shall not be permitted to respond to a call. The car shall be permitted to answer a call only after the car door or gate switch electric contacts have cycled at least once.

5.3.1.18.3 Key-Operated Switches. Any car exterior to a residence shall be operated by means of a key switch. Key-operated switches shall be of continuous-pressure spring-return type, and shall be operated by a cylinder-type lock having not less than a five-pin or five-disk combination with the key removable only when the switch is in the off position. The key shall be Group 4 Security (see 8.1).

5.3.1.18.4 Electrical Equipment and Wiring

(a) All electrical equipment and wiring shall conform to NFPA 70 or CSA-C22.1, whichever is applicable.

(b) Electrical equipment shall be listed/certified and labeled/marked. CSA B44.1/ASME A17.5 defines the scope and applicable requirements for this listing/certification.

(c) The installation of capacitors or other devices, the operation or failure of which will cause an unsafe operation of the elevator, is prohibited.

5.3.1.18.5 Disconnecting Means. Where the controller is located on the car, the disconnecting means shall be located adjacent to the controller. Auxiliary disconnect means shall be provided at the main landing when the main power supply disconnect means is mounted adjacent to the controller on the car.

5.3.1.18.6 Phase Reversal and Failure Protection.

If polyphase alternating-current power supply is used, provide protection in conformance with 2.26.6 and 3.26.5.

5.3.1.18.7 Emergency Stop Switch. An emergency stop switch, conforming to 2.26.2.5(a), (b), and (c), shall be provided in every car and shall have contacts that are positively opened mechanically; their openings shall not be solely dependent on springs.

5.3.1.18.8 Slack-Rope and Slack-Chain Devices for Winding Drum and Roller-Chain-Type Driving Machines.

Winding drum machines with rope suspension shall be provided with a slack-rope device of the manually reset type that will remove power from the motor and brake if the car is obstructed in its descent and the hoisting ropes slacken.

Elevators with roller-chain suspension shall be provided with a slack-chain device that will remove power from the motor and brake if the car is obstructed in its descent and the suspension means slacken. This device need not be of the manually reset type if the chain sprockets are guarded to prevent the chain from becoming disengaged from the sprockets.

5.3.1.19 Emergency Signaling Devices. A telephone connected to a central telephone exchange shall be installed in the car and an emergency signaling device operable from inside the car and audible outside the hoistway shall be provided.

5.3.1.20 Marking Plates

5.3.1.20.1 Capacity Plate. A capacity plate indicating the rated load of the elevator in pounds shall be furnished by the manufacturer and fastened in a conspicuous place inside the car. The letters and figures on such plates shall be not less than 6 mm (0.25 in.) in height.

5.3.1.20.2 Data Plates. A data plate indicating the weight of the elevator, the rated speed, the suspension

means, the manufacturer's name, and the date of installation shall be furnished by the manufacturer. This plate shall be installed in a conspicuous place in the machinery area. The letters and figures on such plates shall be not less than 6 mm (0.25 in.) in height.

5.3.2 Private Residence Hydraulic Elevators

Machinery and equipment for hydraulic elevators shall conform to 5.3.2.

5.3.2.1 General Requirements for Hydraulic Private Residence Elevators. Hoistways, hoistway enclosures, and related construction; cars; counterweights; safeties and governors; guide rails and fastenings; car and counterweight buffer; operating devices and suspension means shall meet the requirements of 5.3.1.1 through 5.3.1.16, and 5.3.1.18 through 5.3.1.20, except as modified in 5.3.2.

5.3.2.2 Driving Machines, Sheaves, and Supports for Direct-Plunger and Roped-Hydraulic Driving Machines

5.3.2.2.1 Direct-plunger, roped-hydraulic, and chain-hydraulic private residence elevator driving machines, sheaves, valves, supply piping, fittings, and tanks shall conform to 3.18, 3.19, and 3.24, except as modified by 5.3.1.16.2 and 5.3.2.

5.3.2.2.2 A pressure switch shall be provided to remove power from the pump motor and the control valve unless there is positive pressure at the control valve.

5.3.2.3 Terminal Stopping Devices. Direct-plunger, roped-hydraulic, and chain-hydraulic private residence elevator terminal stopping devices shall conform to 3.25, except as modified in 3.25.2.

5.3.2.4 Anticreep Leveling Devices. Each elevator shall be provided with an anticreep leveling device conforming to 5.3.2.4.1 through 5.3.2.4.7.

5.3.2.4.1 The anticreep leveling device shall maintain the car within 25 mm (1 in.) of the landing irrespective of the position of the hoistway door.

5.3.2.4.2 For electrohydraulic elevators, the anticreep leveling device shall be required to operate the car only in the up direction.

5.3.2.4.3 For maintained pressure hydraulic elevators, the anticreep leveling device shall be required to operate the car in both directions.

5.3.2.4.4 The operation of the anticreep leveling device shall be permitted to depend on the availability of the electric power supply, provided that the power supply line disconnecting means is kept in the closed position at all times, except during maintenance, repairs, and inspection.

5.3.2.4.5 The anticreep leveling device shall be permitted to be rendered inoperative during recycling operation.

5.3.2.4.6 The following devices shall prevent operation of the elevator by the normal operating device and also the movement of the car in response to the anticreep leveling device: (ED)

- (a) low pressure switch when required by 5.3.2.2.2
- (b) slack-rope switch when required by 3.18.1.2.5
- (c) platform switch when required by 5.3.1.1.1
- (d) hatch cover switch when required by 5.3.1.1.3(c)
- (e) speed governor switch when required by 5.3.1.11.6

5.3.2.4.7 The following devices shall prevent the operation of the elevator by the normal operating device, but the anticreep leveling device shall remain operable:

- (a) hoistway door locking device when required by 5.3.1.7.4
- (b) car door or gate electric contacts when required by 5.3.1.8.2(c)
- (c) emergency stop switch when required by 5.3.1.18.7

SECTION 5.4 PRIVATE RESIDENCE INCLINED ELEVATORS

(13)

Requirement 5.4 applies to inclined elevators installed in or at a private residence. Requirement 5.4 also applies to similar elevators installed in buildings as a means of access to private residences within such buildings, provided the inclined elevators are so installed that they are not accessible to the general public or to other occupants in the building. Inclined elevators conforming to the requirements of Section 5.1 are not prohibited from being installed in or at a private residence.

NOTE: See also Part 8 for additional requirements that apply to *private residence inclined elevators*.

5.4.1 Runway Protection

If the car sides extend less than 1 825 mm (72 in.) above the floor of the car, there shall be no obstruction along the runway, within the arc formed by a 600 mm (24 in.) radius whose center is the outer corner of the top rail of the car enclosure.

When solid guards are installed on the obstruction in both directions of travel, which project at least 350 mm (14 in.) in line with the direction of travel, the running clearance shall be permitted to be reduced to 175 mm (7 in.). The exposed edge of the guard shall be rounded to eliminate shear hazards.

5.4.2 Landing Enclosures and Gates (Where Required)

5.4.2.1 Landing Enclosures. Where a landing platform is provided or if a portion of an existing structure is used as a landing platform, it shall be protected by an enclosure not less than 915 mm (36 in.) high.

5.4.2.2 Landing Gates. The opening in the enclosure shall be guarded by a gate to a height equal to that of the enclosure. The gates shall be permitted to be of the horizontally sliding or of the swinging type and shall be equipped with a combination mechanical lock and electric contact conforming to 2.12.4, 5.3.1.7.4, 5.3.1.7.5, 5.3.1.7.6, and 5.3.1.7.7 where doors and gates exceed 915 mm (36 in.) in height.

5.4.2.3 Construction of Landing Enclosures and Gates. The landing enclosure and gates shall either be of solid construction or of openwork rejecting a 25 mm (1 in.) ball. A force of 670 N (150 lbf) applied at any area 100 mm × 100 mm (4 in. × 4 in.) on the walls of the enclosure shall not reduce the running clearance below 19 mm (0.75 in.) nor cause a deflection exceeding 25 mm (1 in.).

- (13) **5.4.2.4 Clearance Between Landing Doors or Gates and Landing Sills and Car Doors or Gates.** Clearances shall conform to 5.3.1.7.2.

5.4.2.5 Horizontal Clearance Between Car and Landing Sills. The horizontal clearance between the car and landing sills shall conform to 5.3.1.4.2.

5.4.3 Machinery Beams and Supports

- (13) **5.4.3.1 Securing of Machinery Beams and Type of Support.** All machinery and sheaves supports and machinery beams shall conform to 5.3.1.16.1.
- (13) **5.4.3.2 Fastening of Driving Machines and Sheaves to Underside of Beams.** Fastening of driving machines and sheaves shall conform to 5.3.1.16.2(c).
- (13) **5.4.3.3 Factor of Safety of Beams and Supports.** The factor of safety for beams and their supports shall conform to 5.3.1.16.1(c).
- (13) 5.4.3.4 DELETED

5.4.4 Car Enclosures, Car Doors, and Gates

5.4.4.1 Car Enclosures

5.4.4.1.1 Car Enclosures Required. Except at the entrance, cars shall be enclosed on all sides to a height of not less than 1 070 mm (42 in.).

- (13) **5.4.4.1.2 Securing of Car Enclosures.** Car enclosures shall be secured in conformance with 2.14.1.2 and 2.14.1.3.

5.4.4.1.3 Deflection of Car Enclosure Walls. The car enclosure walls shall be of such strength and so designed and supported that when subjected to a force of 334 N (75 lbf) applied horizontally at any point on the walls of the enclosure, the deflection will not reduce the running clearance below 19 mm (0.75 in.) nor to exceed 25 mm (1 in.).

5.4.4.1.4 Platform Guards (Aprons). Requirement 5.3.1.9.1(b) applies, and the guard shall extend horizontally within the zone where the doors or gates are unlocked.

5.4.4.2 Car Doors or Gates

5.4.4.2.1 Doors or Gates Required. A car door or gate that, when closed, will guard the opening to a height of at least 1 070 mm (42 in.) or to the height of the car enclosure, whichever is greater, and shall be provided at each entrance to the car. Through openings in car gates shall reject a ball 75 mm (3 in.) in diameter. The car door or gate shall be designed, constructed, and installed in accordance with 5.3.1.8.2. Power operation shall be permitted for car doors and gates, and shall conform to 5.3.1.8.2(a).

5.4.4.2.2 Door or Gate Electric Contacts. Car doors or gates shall be provided with an electric contact conforming to 2.14.4.2.3 and 2.14.4.2.5.

5.4.4.2.3 Manual Operation. Car doors or gates shall be manually operated.

5.4.4.2.4 Latching of Swinging Gates. If the car gate is of the swinging type, opening outward from the car, the electric contact required by 5.4.4.2.2 shall not close until the gate is securely latched.

5.4.4.3 Use of Glass or Plastics (13)

5.4.4.3.1 Glass or plastics, where used in elevator cars, shall conform to the following: (13)

- (a) if of glass, meet the requirements of 2.14.1.8
- (b) if of plastic, it shall meet the requirements of ANSI Z97.1, 16 CFR Part 1201, or CAN/CGSB-12.1, CAN/CGSB-12.11, and CAN/CGSB-12.12, whichever is applicable

5.4.4.3.2 Glass or plastics shall be secured as required by 5.4.4.1.2. (13)

5.4.4.3.3 Weatherproof Material. Materials shall be of a weatherproof type. (13)

5.4.5 Car and Chassis Construction

5.4.5.1 Car and Platform. Inclined elevator cars shall have frames and platforms of metal or combination metal and wood, or other materials of equal strength. Car frames and platforms shall have a factor of safety of not less than 5, based on the rated load, they suitably prepared and/or protected for exposure to the weather.

5.4.5.2 Chassis Construction. Inclined elevator chassis shall be constructed of metal, except for guiding members. Chassis shall have a factor of safety of not less than 5, based on the rated load. The chassis-guiding members shall be retained and/or enclosed in guides or tracks in such a manner that the chassis cannot be derailed.

5.4.5.3 Use of Cast Iron. Cast iron shall not be used in the construction of any member of the car frame or chassis.

5.4.5.4 Number of Compartments. The car shall not have more than one compartment.

5.4.6 Capacity

5.4.6.1 Rated Load and Platform Area. The rated load and net platform area shall conform to 5.3.1.10.1.

(13) **5.4.6.2 Shelves or Benches.** Shelves or benches permanently fixed to the car structure, which reduce the standing area of the platform, are permitted and shall not exceed 0.55 m² (1.8 ft²). Fifty percent of the net area of shelves or benches shall be added to the standing platform area to calculate the net platform area. Baskets, shelves, or other objects not necessary for operation of the elevator shall not protrude beyond the exterior of the car enclosure.

5.4.6.3 Rated Speed. The rated speed measured along the incline shall not exceed 0.38 m/s (75 ft/min).

5.4.7 Safeties and Governors

5.4.7.1 Car Safeties Required. Each inclined elevator shall be provided with a car safety capable of stopping and sustaining the car with rated load.

5.4.7.2 Operation of Car Safeties. The car safety shall be of Type A, B, or C, as specified in 2.17.5, and shall be operated by a speed governor, complying with the following requirements:

(a) The governor shall be set to trip at not less than 115% nor more than 140% of the rated speed.

(b) Type A safeties shall operate as required by 2.17.8.1.

(c) Type C safeties shall operate as required by 2.17.8.2.

5.4.7.3 Counterweight Safeties. If the construction at the lower end of the rail is not at or below grade at the termination of the rail, counterweight safeties conforming to 5.4.7 shall be provided, except governor operation of the safeties is not required.

5.4.7.4 Location of Speed Governor. The speed governor shall be located where it cannot be struck by the car or counterweight in case of overtravel and where there is sufficient space for full movement of the governor parts and where it is accessible for examination.

5.4.7.5 Opening of Brake and Motor Control Circuits on Safety Application. Power shall be removed from the driving-machine motor and brake before or at the time the safety applies.

(13) **5.4.7.6 Governor Ropes.** Governor ropes, where used, shall conform to 5.3.1.11.7.

5.4.7.7 Slack-Rope and Slack-Chain Devices for Winding Drum and Roller-Chain-Type Driving Machines. (13) Winding-drum and roller-chain-type driving machines shall conform to 5.3.1.18.8.

5.4.7.8 Application of Car Safety. The application of car safeties shall comply with 5.3.1.11.3.

5.4.7.9 Materials Used in Car Safeties. (13) The minimum factors of safety and stresses of safety parts and rope connections shall conform to 5.3.1.11.4.

5.4.7.10 Corrosion-Resistant Bearings in Safeties. Materials used in safeties shall meet the requirements of 2.17.13.

5.4.8 Suspension Means (13)

Suspension means shall conform to 5.3.1.12, except as modified by 5.4.8.1.

5.4.8.1 Types Permitted. Where the chassis is suspended from the driving machine by a wire rope or roller chain, a single suspension means shall be permitted to be used.

5.4.8.2 Factor of Safety of Suspension Means. The suspension means shall have a factor of safety of not less than 8, based on the tension in the rope(s) or chain(s) when raising the car and its rated load. In no case shall the rated breaking strength of the rope(s) or chain(s) be less than 17 800 N (4,000 lbf).

5.4.8.3 Lengthening, Splicing, Repairing, or Replacing Suspension Means. No car or counterweight wire rope shall be lengthened or repaired by splicing. Broken or worn suspension chains shall not be repaired. If one wire rope or a chain of a set is worn or damaged and requires replacement, the entire set of ropes or chains shall be replaced. In the event that a worn chain is replaced, the drive sprocket shall also be replaced.

5.4.9 Counterweight Guiding and Construction (13)

Counterweight guiding and construction shall conform to 5.3.1.13.

5.4.10 Bumpers and Buffers

5.4.10.1 Solid Bumpers. For rated speeds not exceeding 0.25 m/s (50 ft/min), if spring- or equivalent-type buffers are not used, solid bumpers shall be installed.

5.4.10.2 Construction and Requirements for Solid Bumpers. Solid bumpers shall be made of wood or other suitable resilient material of sufficient strength to withstand, without failure, the impact of the car with rated load or the counterweight, descending at 125% of the rated speed.

The material used shall be of a type that will resist deterioration or be so treated as to resist deterioration.

5.4.10.3 Spring Buffers. For rated speeds exceeding 0.25 m/s (50 ft/min), buffers of the spring type shall be installed.

5.4.10.4 Construction and Requirements for Spring Buffers. Spring buffers shall be constructed so as to have a minimum stroke of 19 mm (0.75 in.) and a maximum stroke of 38 mm (1.5 in.) and shall not be fully compressed when struck by the car with its rated load or counterweight traveling at 125% of the rated speed.

(13) **5.4.11 Car and Counterweight Guide and Track Supports and Fastenings**

Car and counterweight guide, track, and track supports and fastenings shall conform to 5.3.1.15.

5.4.11.1 All supporting structures shall meet the requirements of the applicable building code.

(13) **5.4.12 Driving Machines and Sheaves**

(13) **5.4.12.1** Driving machines and sheaves shall conform to 5.3.1.16.2 through 5.3.1.16.5.

(13) **5.4.12.2 Location of Driving Machine, Alignment, and Guarding of Sheaves.** The driving machine shall be permitted to be mounted on the car chassis or placed at a remote location. If remotely located, all intervening sheaves or sprockets shall be placed to ensure that ropes or chains travel in proper alignment. All sheaves or sprockets shall be guarded.

(13) **5.4.12.3 Manual Operation.** Manual operation shall conform to 5.3.1.16.2(i).

(13) **5.4.13 Terminal Stopping Devices**

5.4.13.1 Terminal Stopping Devices. Terminal stopping devices shall conform to 5.3.1.17.

(13) **5.4.14 Operating Devices and Control Equipment**

5.4.14.1 Type of Operation. The inclined elevator shall be operated by weatherproof constant pressure or momentary pressure key switches at each landing and on the car. Key-operated switches shall be of the spring-return type and shall be operated by a cylinder-type lock having not less than five-pin or five-disk combination with the key removable only when the switch is in the off position. The key shall be Group 4 Security (see 8.1).

5.4.14.2 Emergency Stop Switches in Cars. Emergency stop switches shall be provided in the cars and shall conform to 5.3.1.18.7.

5.4.14.3 Control and Operating Circuit Requirements. The design and installation of the control and operating circuits shall conform to 5.3.1.18.2.

5.4.14.4 Hand Rope Operation. Hand rope operation shall not be used.

5.4.14.5 Electrical Equipment and Wiring

5.4.14.5.1 Electrical Equipment and Wiring Requirements. Requirements 5.3.1.18.4, 5.3.1.18.5, and 5.3.1.18.6 apply.

5.4.14.5.2 Electrical Connections. If the driving machine is mounted on the car chassis, electrical connections between the car and power source shall be provided with a means to remove power if the connecting traveling cable part. All electrical connections to the moving chassis and the stationary connections shall be insulated flexible conductors, in accordance with NFPA 70 or CSA-C22.1, whichever is applicable (see Part 9).

5.4.14.5.3 Traveling Cables. Traveling cables shall be Type EO, ETT, or ETP and shall conform to the requirements of NFPA 70 or CSA-C22.1, whichever is applicable (see Part 9). Where traveling cable voltage exceeds 30 V, a means shall be provided to remove the power automatically upon parting of the traveling cable.

5.4.15 Marking Plates

Capacity, data, and code data plates shall be provided as required in 5.3.1.20.1, 5.3.1.20.2, and 8.9. All plates shall be weather resistant.

(13)

**SECTION 5.5
POWER SIDEWALK ELEVATORS**

Requirement 5.5 applies to power sidewalk elevators. Requirement 5.5.1 applies to electric elevators. Requirement 5.5.2 applies to direct-plunger hydraulic elevators.

NOTE: See also Part 8 for additional requirements that apply to *power sidewalk elevators*.

5.5.1 Electric Sidewalk Elevators

5.5.1.1 Construction of Hoistways and Hoistway Enclosures. The construction of hoistway enclosures shall conform to 2.1, except as modified by the following:

- (a) Requirement 2.1.1.1. Hoistways are not required to be enclosed above the top landing.
- (b) Requirement 2.1.1.3 does not apply.
- (c) Requirement 2.1.2.1 does not apply.
- (d) Requirement 2.1.3 does not apply.

5.5.1.2 Pits. Pits shall conform to 2.2. Means shall be provided to automatically remove water from the pit.

5.5.1.3 Location and Guarding of Counterweight. The location and guarding of counterweights shall conform to 2.3.

5.5.1.4 Vertical Clearances and Runbys. Where a car top is provided, bottom and top clearances and runbys for cars and counterweights shall conform to 2.4.

Where no car top is provided, they shall conform to 2.4.1 through 2.4.4 and 2.4.9. When the car has reached

its maximum upward movement, no equipment shall strike the overhead structure or other obstructions.

On elevators with vertical lifting covers, there shall be a clearance of not less than 600 mm (24 in.) between the top of the cover and any obstruction vertically above it when the car has reached its maximum upward movement.

The clearance required by 2.4.1 does not apply below underslung elevators with the car resting on its fully compressed buffers, when a refuge space not less than either of the following is provided:

(a) a horizontal area 600 mm × 1 200 mm (24 in. × 48 in.), with a height of 600 mm (24 in.)

(b) a horizontal area 450 mm × 900 mm (18 in. × 36 in.), with a height of 1 070 mm (42 in.)

5.5.1.5 Horizontal Car and Counterweight Clearances. Horizontal car and counterweight clearances shall conform to 2.5, except as modified by 5.5.1.5.

For sidewalk elevators with adjacent openings, the maximum clearance required by 2.5.1.5 shall be permitted to be increased on the side where the overhead sheaves are located, provided that in such cases this clearance shall not be greater than that required for the installation of the sheaves or sheave beams plus running clearance of not more than 25 mm (1 in.).

5.5.1.6 Protection of Spaces Below Hoistway. Where the hoistway does not extend to the lowest floor of the building, it shall conform to 2.6.

5.5.1.7 Machine Rooms and Machinery Spaces. Machine rooms and machinery spaces shall conform to 2.7.

5.5.1.8 Equipment in Hoistways and Machine Rooms. Electrical equipment, wiring, pipes, and ducts in hoistways and machine rooms shall conform to 2.8 and 5.5.1.8.1 through 5.5.1.8.3.

5.5.1.8.1 Slack-rope switches (where required), lower normal and final terminal stopping devices, and pit stop switches shall be located not less than 600 mm (24 in.) above the pit floor.

5.5.1.8.2 All electrical equipment in the hoistway shall be weatherproof.

5.5.1.8.3 Electrical metal tubing (EMT) shall not be used.

5.5.1.9 Machinery and Sheave Beams, Supports, and Foundations. Machinery and sheave beams, supports, and foundations shall conform to 2.9.

5.5.1.10 Guarding. The guarding of exposed auxiliary equipment shall conform to 2.10.

5.5.1.11 Protection of Hoistway Landing Openings

5.5.1.11.1 Vertical Openings. Vertical hoistway landing openings shall conform to 2.11, except that 2.11.2.1 does not apply.

5.5.1.11.2 Horizontal Openings in Sidewalks and Other Areas Exterior to the Building

(a) The clear opening in a sidewalk that is accessible to the general public when the sidewalk door or cover is open shall be such that the sidewalk permits a minimum 1 200 mm (48 in.) wide unobstructed pedestrian path, which is not normally accessible to vehicular traffic.

(b) Hoistways shall not be located either wholly or partially in front of any entrance to a building.

(c) The side of the door opening nearest to any building wall or other obstruction shall be less than or equal to 100 mm (4 in.), or greater than 914 mm (36 in.), from the wall or obstruction.

(d) Horizontal openings in sidewalks or other areas exterior to the building shall be protected by hinged metal doors or vertically lifting covers having a nonslip upper surface. Such doors or covers shall not be used where the hoistway is located inside the building. Doors or covers shall be of sufficient strength to safely support a static load of not less than 1 460 kg/m² (300 lb/ft²), uniformly distributed.

(e) When in the closed position, doors shall be flush with the adjacent sidewalk or other surface.

(f) Such doors and covers shall conform to 5.5.1.11.3 or 5.5.1.11.4.

(g) All openings between sidewalk door panels and frames shall be provided with gutters to collect rainwater. Their gutters shall be piped rigidly to a discharge point exterior to the hoistway and pit or to the sump pit when provided and designed in accordance with 5.5.1.2.

(h) When subject to vehicular traffic, the doors or covers shall be designed to safely support the loads likely to be imposed on them.

5.5.1.11.3 Hinged-Type Swing Sidewalk Doors

(a) The line of the hinges shall be at right angles to the building wall.

(b) There shall be a minimum clearance of 450 mm (18 in.) between the face of the doors and any obstruction when the doors are in the open position.

(c) The doors shall be opened by the ascending car and shall be self-closing as the car descends, and shall be kept in the closed position when the car is not at the top landing, except as provided for in 5.5.1.11.3(d).

(d) The doors shall be permitted to be held or fastened in the open position when the car is not at the top landing, provided self-closing hinged metal screen panels, which will reject a ball 50 mm (2 in.) in diameter and which will support a static load of not less than 1 136 kg (300 lb) applied on any area 600 mm (24 in.) on a side and not less than 68 kg (150 lb) applied at any point, are installed directly below the watertight sidewalk doors. Screen panels shall be opened and closed automatically by the ascending and descending car and shall always be closed when the car is not at the top landing.

(e) Stops shall be provided to prevent the doors from opening more than 90 deg from their closed position.

5.5.1.11.4 Vertical Lifting Sidewalk Covers

(a) The covers shall be raised and lowered vertically by the ascending and descending car and shall not be held or fastened in the open position when the car is not at the top landing.

(b) Recesses or guides, which will securely hold the cover in place on the stanchions, shall be provided on the underside of the cover.

5.5.1.12 Hoistway Door Locking Devices and Electric Contacts, and Hoistway Access Switches. Hoistway door locking devices, car door or gate electric contacts, and hoistway access switches shall conform to 2.12, except as modified by 5.5.1.12.1 through 5.5.1.12.3.

5.5.1.12.1 Requirement 2.12.1.1 does not apply.

5.5.1.12.2 Interlocks or electric contacts are not required on horizontal hinged-type swinging covers and vertical lifting covers used at the top landing in sidewalks or other areas exterior to the building. Locks, if used, shall be of the spring type and shall be automatically unlocked by the bow irons or stanchions of the car, unless the locks are of the type that permit operation of the elevators to open the cover only if the locking device is in the unlocked position.

5.5.1.12.3 Requirement 2.12.7. Hoistway access switches are not required for access to the top of the car.

5.5.1.13 Power Operation of Hoistway Doors and Car Doors. Power operation, power opening, and power closing of the hoistway doors and car doors or gates shall conform to 2.13.

5.5.1.14 Car Enclosures, Car Doors and Gates, and Car Illumination

5.5.1.14.1 Car Enclosures. Car enclosures shall conform to 2.14.1 and 2.14.3, except as modified by the following:

(a) Car tops are not required. Where provided, the distance between the top of the car and the bow iron or stanchions shall be not less than 1 067 mm (42 in.).

(b) Requirements 2.14.1.5 and 2.14.1.6 apply only when a car top is provided.

(c) The height of the car enclosure required by 2.14.3.1 shall be permitted to be reduced when the height of the bow iron or stanchion is reduced as permitted by 5.5.1.15.2(a).

5.5.1.14.2 Car Doors and Gates. Car doors and gates shall conform to 2.14.4 and 2.14.6.

5.5.1.14.3 Illumination of Cars. Illumination of cars and lighting fixtures shall conform to 2.14.7, except as modified by the following:

(a) Lighting devices are not required in the car if there are lighting devices exterior to the car, which will

provide the minimum illumination specified in 2.14.7.1.2(b) for the full travel of the car.

(b) Requirement 2.14.7.1.3 does not apply.

(c) Requirement 2.14.7.1.4 applies only where a car top is provided.

5.5.1.15 Car Frames and Platforms. Car frames and platforms shall conform to 2.15.

5.5.1.15.1 Car Frames and Platforms of Elevators Traveling Above the Level of the Sidewalk. Sidewalk elevators arranged to travel above the level of the sidewalk or other area exterior to the building shall conform to the following:

(a) Car frames of the underslung rope-suspended-type elevators shall be of sufficient depth to provide the minimum vertical clearance between the car rope hitches or car sheaves and any obstruction in the hoistway vertically above them, as specified in 2.4.8, when the car floor is level with its upper landing level.

(b) The depth of the car frame and the length and spacing of guiding members shall conform to 2.15.4 and, in addition, shall be such as to prevent tipping of the platform when it is at the highest upper landing level.

(c) The car platform shall be provided with metal aprons or guards on all exposed sides conforming to the following:

(1) They shall be made of metal of not less than 1.5 mm (0.059 in.) in thickness.

(2) They shall have a straight vertical face flush with the outer edge of the platform having a depth of not less than the distance between the normal upper terminal landing level and the highest upper landing level plus 75 mm (3 in.).

(3) The lower portion of the guard shall be rounded or beveled at an angle of approximately 75 deg with the horizontal.

5.5.1.15.2 Bow Irons and Stanchions. Where hinged doors or vertically lifting covers are provided at the sidewalk or other exterior area, bow irons or stanchions shall be provided on the car to operate the doors or covers.

Bow irons and stanchions shall conform to the following:

(a) They shall be not less than 2 130 mm (84 in.) high, except that this height shall be permitted to be reduced by an amount necessary to permit the doors or covers to close when the car is at the landing next to the top terminal landing.

(b) They shall be so designed, installed, and braced as to withstand the impact when striking the doors or covers.

(c) Bow irons shall be located approximately symmetrical with respect to the center of the car platform.

(d) Stanchions shall be framed together at their upper ends and provided with spring buffers at the top.

5.5.1.16 Capacity and Loading. Capacity and loading shall conform to 2.16, except as modified by the following:

(a) Requirement 2.16.1 does not apply.

(b) Requirement 2.16.4 does not apply. Sidewalk elevators shall not be permitted to carry passengers.

5.5.1.17 Car and Counterweight Safeties. Safeties shall conform to 2.17, except as modified by the following:

Where the rated speed does not exceed 0.25 m/s (50 ft/min), car safeties that operate as a result of breaking or slackening of the hoisting ropes shall be permitted to be used in lieu of governor-actuated safeties required by 2.17.7.1. The safety shall operate without delay.

5.5.1.18 Speed Governors. Governors, where provided, shall conform to 2.18.

5.5.1.19 Suspension Ropes. Suspension ropes shall conform to 2.20.

5.5.1.20 Counterweights. Counterweights shall conform to 2.21.

5.5.1.21 Buffers and Bumpers. Buffers and bumpers shall conform to 2.22.

5.5.1.22 Guide Rails. Guide rails shall conform to 2.23.

5.5.1.23 Driving Machines and Sheaves. Driving machines and sheaves shall conform to 2.24, except that the ratio of the drum diameter to the rope diameter (see 2.24.2) shall be permitted to be reduced to 24.

5.5.1.24 Terminal Stopping Devices. Terminal stopping devices shall conform to 2.25 (see also 5.5.1.8).

5.5.1.25 Operating Devices and Control Equipment. Operating devices and control equipment shall conform to 2.26, except as modified by 5.5.1.25.1 through 5.5.1.25.4. Where the top opening is located in an area exterior to the building, all electrical equipment on the car shall be weatherproof.

5.5.1.25.1 Types of Operating Devices. Operating devices shall be of the automatic or continuous-pressure type. Operation through openings in the sidewalk or other area exterior to the building shall conform to 5.5.1.25.2.

5.5.1.25.2 Operation Through Openings in Sidewalk or Other Area Exterior to the Building. The operation of elevators through openings in the sidewalk, or through openings in other exterior areas, and which are protected by hinged doors or vertically lifting covers, shall conform to the following:

(a) The elevator shall be operated through the opening, in both the up and down directions, only from the sidewalk or other exterior area or from on the car as

permitted by 5.5.1.25.2(g) and at a speed not exceeding 0.13 m/s (25 ft/min). The operation shall be by means of

(1) key-operated continuous-pressure-type up-and-down switches; or

(2) continuous-pressure-type up-and-down operating buttons on the free end of a detachable, flexible cord not more than 1 525 mm (60 in.) in length.

(b) Key-operated switches shall be of the continuous-pressure spring-return type and shall be operated by a cylinder-type lock having not less than a five-pin or five-disk combination with the key removable only when the switch is in the "OFF" position.

(c) Key-operated switches and plug receptacles for flexible cords shall be weatherproof and shall be installed above the sidewalk or other area on the side of the building wall, located 450 mm (18 in.) or less horizontally from one side of the opening.

(d) Operating buttons, if provided in the elevator car and at any landing below the top landing, shall operate the car only when the bow iron or stanchions are not in contact with the doors or covers in the sidewalk or other exterior area.

(e) When the bow iron or stanchions are in contact with the doors or covers at the sidewalk or other exterior area, it shall be possible to operate the car only by means of either the key switches or the continuous-pressure-type up-and-down buttons on the free end of the flexible cord specified in 5.5.1.25.2(a).

(f) Flexible cords and operating keys shall not be left where they are accessible to unauthorized persons for operation of the elevator.

(g) On sidewalk door openings protected by hinged doors and hinged metal screen panels, once the hinged sidewalk doors are in the full opened position the elevator shall be permitted to be operated from on the car with the sidewalk doors in the full opened position subject to the following:

(1) The elevator shall be provided with self closing hinged metal screen panels in accordance with 5.5.1.11.3 which cover the entire sidewalk opening.

(2) Where the side of the sidewalk door opening is more than 100 mm (4 in.) from any building wall or other obstruction it shall be provided with a secured barrier that can be removed for loading and unloading the elevator at the sidewalk level and that shall be put in place to protect the sidewalk opening when the elevator is being operated from on the car below the sidewalk level. The secured barrier shall comply with 2.10.2.

(3) All of the required sidewalk level barriers are in place and their proper placement has electrically enabled the car operating circuit.

5.5.1.25.3 Top-of-Car Operating Devices and Stop Switch. The requirement for a top-of-car operating device (see 2.26.1.4) applies only where a car top is provided. It shall operate the car at a speed not greater than 0.13 m/s (25 ft/min). It shall not operate when the

bow iron or stanchions are in contact with the doors or covers in the sidewalk or other exterior area.

The requirement for a stop switch on top of the car (see 2.26.2.8) applies only where a car top is provided.

5.5.1.25.4 Maximum Rated Speed. Where the car is not fully enclosed, the rated speed shall not exceed 0.25 m/s (50 ft/min), except as required by 5.5.1.25.2(a) and 5.5.1.25.3.

Where the car is fully enclosed, there is no limit on the rated speed, except as required by 5.5.1.25.2(a) and 5.5.1.25.3.

5.5.1.26 Car Emergency Signaling Devices. If car operating buttons are provided, car emergency signaling devices shall be provided conforming to 2.27.1.1.1 and 2.27.1.2. If the rise is more than 7.6 m (25 ft), the signaling devices shall also conform to 2.27.1.1.2.

5.5.1.27 Layout Data. The information provided on layout data shall conform to 2.28.

5.5.1.28 Welding. Welding shall conform to 8.8.

5.5.2 Direct-Plunger Hydraulic Sidewalk Elevators

5.5.2.1 Hoistways, Hoistway Enclosures, and Related Construction. Hoistways, hoistway enclosures, and related construction shall conform to 5.5.1.1 through 5.5.1.13, and 5.5.2.1 through 5.5.2.18, except 5.5.1.4 and 5.5.1.6.

5.5.2.2 Vertical Clearances and Runbys. Where a car top is provided, bottom and top clearances and runbys for cars and counterweights shall conform to 3.4.

Where no car top is provided, they shall conform to 3.4.1, 3.4.2.1, and 3.4.6.2. When the car has reached its maximum upward movement, no equipment shall strike the overhead structure or other obstruction.

5.5.2.3 Protection of Spaces Below Hoistway. Where the hoistway does not extend to the lowest floor of the building, it shall conform to 3.6.

5.5.2.4 Machine Rooms and Machinery Spaces. Machine rooms and machinery spaces shall conform to 3.7.

5.5.2.5 Emergency Doors. The requirements for emergency doors in single-blind hoistways apply only where a car safety is provided.

5.5.2.6 Car Enclosures, Car Doors and Gates, and Car Illumination. Car enclosures, car doors and gates, and car illumination shall conform to 5.5.1.14.

5.5.2.7 Car Frames and Platforms. Car frames and platforms shall conform to 3.15, 5.5.1.15.1, and 5.5.1.15.2.

5.5.2.8 Capacity and Loading. Capacity and loading shall conform to 2.16, except as modified by 3.16 and 5.5.1.16.

5.5.2.9 Car and Counterweight Safeties. Car safeties, where provided, shall conform to 5.5.1.17 and shall be of the type that can be released only by moving the car in the up direction.

Counterweight safeties, where provided, shall conform to 3.17.2.

5.5.2.10 Hydraulic Jacks. Hydraulic jacks shall conform to 3.18.

5.5.2.11 Valves, Pressure Piping, and Fittings. Valves, pressure piping, and fittings shall conform to 3.19.

5.5.2.12 Counterweights. Where provided, counterweights shall conform to 3.21.

5.5.2.13 Buffers and Bumpers. Buffers and bumpers shall conform to 3.22.

5.5.2.14 Guide Rails, Guide-Rail Supports, and Fastenings. Guide rails and their supports and fastenings shall conform to 3.23.

5.5.2.15 Tanks. Tanks shall conform to 3.24.

5.5.2.16 Terminal Stopping Devices. Terminal stopping devices shall conform to 3.25 (see also 5.5.1.8).

5.5.2.17 Operating Devices and Control Equipment

5.5.2.17.1 Operating devices and control equipment shall conform to 3.26, 5.5.1.25.1, 5.5.1.25.2, and 5.5.1.25.4 and all electrical equipment on the car shall be weatherproof.

5.5.2.17.2 The requirement for a top-of-car operating device (see 3.26.2) applies only where a car top is provided. It shall operate the car at a speed not greater than 0.13 m/s (25 ft/min). It shall not operate when the bow iron or stanchions are in contact with the doors or covers in the sidewalk or other exterior area.

5.5.2.17.3 The requirement for a stop switch on top of the car (see 2.26.2.8 and 3.26.4.1) applies only where a car top is provided.

5.5.2.18 Layout Data. The information provided on layout data shall conform to 3.28.

SECTION 5.6 ROOFTOP ELEVATORS

Requirement 5.6 applies to rooftop elevators. Requirement 5.6.1 applies to electric elevators. Requirement 5.6.2 applies to direct-plunger hydraulic elevators.

NOTE: See also Part 8 for additional requirements that apply to rooftop elevators.

5.6.1 Electric Rooftop Elevators

5.6.1.1 Construction of Hoistway and Hoistway Enclosures. The construction of hoistway enclosures shall conform to 2.1, except as modified by the following:

(a) *Requirement 2.1.1.1.* Hoistways are not required to be enclosed above the rooftop landing.

- (b) Requirement 2.1.1.3 does not apply.
- (c) Requirement 2.1.2.1 does not apply.
- (d) Requirement 2.1.3 does not apply.

5.6.1.2 Pits. Pits shall conform to 2.2. Means shall be provided to automatically remove water from the pit.

5.6.1.3 Location and Guarding of Counterweight.

The location and guarding of counterweights shall conform to 2.3.

5.6.1.4 Vertical Clearances and Runbys. Bottom and top clearances and runbys for cars and counterweights shall conform to 2.4, except as modified by the following:

- (a) Table 2.4.2.2, maximum speed 0.25 m/s (50 ft/min). See 5.6.1.25.4.
- (b) Requirement 2.4.10 does not apply.
- (c) Requirement 2.4.11 does not apply.
- (d) Requirement 2.4.12 does not apply if rise is 6.1 m (20 ft) or less. When refuge space is required, it shall be measured to the underside of the roof door when the bow iron or stanchion is in contact with the door.

5.6.1.5 Horizontal Car and Counterweight Clearances. Horizontal car and counterweight clearances shall conform to 2.5.

5.6.1.6 Protection of Spaces Below Hoistway. Where the hoistway does not extend to the lowest floor of the building, it shall conform to 2.6.

5.6.1.7 Machine Rooms and Machinery Spaces.

Machine rooms and machinery spaces shall conform to 2.7, except as modified by the following:

- (a) Requirement 2.7.3.2.2 does not apply.
- (b) Requirement 2.7.3.5 does not apply.

5.6.1.8 Equipment in Hoistways and Machine Rooms. Electrical equipment, wiring, pipes, and ducts in hoistways and machine rooms shall conform to 2.8 and the following:

- (a) Slack-rope switches (where required), lower normal and final terminal stopping devices, and pit stop switches shall be located not less than 600 mm (24 in.) above the pit floor.
- (b) All electrical equipment in the hoistway shall be weatherproof.
- (c) Electrical metallic tubing (EMT) shall not be used.

5.6.1.9 Machinery and Sheave Beams, Supports, and Foundations. Machinery and sheave beams, supports, and foundations shall conform to 2.9.

5.6.1.10 Guarding. The guarding of exposed auxiliary equipment shall conform to 2.10.

5.6.1.11 Protection of Hoistway Landing Openings

5.6.1.11.1 Vertical Openings. Vertical hoistway landing openings shall conform to 2.11.

5.6.1.11.2 Horizontal Openings in Rooftops

(a) The pedestrian path on a rooftop, when the door or cover is open, shall be such that it permits a minimum 1 200 mm (48 in.) wide unobstructed path that is not normally accessible to vehicular traffic.

(b) Hoistways shall not be located either wholly or partially in front of any entrance to a building or openable window.

(c) The side of the door opening nearest to any building wall or other obstruction shall be 100 mm (4 in.) or less, or greater than 900 mm (36 in.), from the wall or obstruction.

(d) Horizontal openings in rooftops shall be protected by hinged metal doors or vertically lifting covers having a nonslip upper surface. Doors or covers shall be of sufficient strength to safely support a static load of not less than 14.4 kPa (300 lbf/ft²), uniformly distributed.

(e) When in the closed position, doors shall be flush with the landing sill.

(f) Such doors and covers shall conform to 5.6.1.11.3 or 5.6.1.11.4.

(g) All openings between rooftop door panels and frames shall be provided with minimum 50 mm (2 in.) gutters to collect rainwater. The gutters shall be piped rigidly to a discharge point exterior to the hoistway and pit.

5.6.1.11.3 Hinged-Type Rooftop Doors

(a) There shall be a minimum clearance of 450 mm (18 in.) between the face of the doors and any obstruction when the doors are in the open position.

(b) The doors shall be opened by the ascending car and shall be self-closing as the car descends, and shall be kept in the closed position when the car is not at the top landing.

(c) Stops shall be provided to prevent the doors from opening more than 90 deg from their closed position.

(d) Means shall be provided at the meeting edge of biparting rooftop doors to collect and discharge rain water.

(e) The landing sill shall be substantially flush with the floor surface of the elevator landings.

5.6.1.11.4 Vertical Lifting Rooftop Covers

(a) The covers shall be raised and lowered vertically by the ascending and descending car and shall not be held or fastened in the open position when the car is not at the top landing.

(b) Recesses or guides, which will securely hold the cover in place on the stanchions, shall be provided on the underside of the cover.

(c) The landing sill shall be substantially flush with the floor surface of the elevator landings.

5.6.1.11.5 Setting of the Door. The door shall be set in the roof in such a manner that the upper surface of the rooftop door is at least 25 mm (1 in.) above the surface of the roof and pitched at the same angle. The

edge around the rooftop door and the surface of the roof shall be such that a gradual change in surface height is provided.

5.6.1.12 Hoistway Door Locking Devices and Electric Contacts and Hoistway Access Switches. Hoistway door locking devices, car door or gate electric contacts, and hoistway access switches shall conform to 2.12 or 2.14.4, except as modified by the following:

(a) *Requirements 2.12.2 and 2.12.3.* Interlocks or electric contacts are not required on hinged-type swinging covers and vertical lifting covers used at the top landing in rooftops. Locks, if used, shall be of the spring type and shall be automatically unlocked by the bow irons or stanchions of the car, unless the locks are of the type that permit operation of the elevators to open the cover only if the locking device is in the unlocked position.

(b) *Requirement 2.12.7.* Hoistway access switches are not required for access to the top of the car.

5.6.1.13 Power Operation of Hoistway Doors and Car Doors. Power operation, power opening, and power closing of the hoistway doors and car doors or gates shall conform to 2.13.

5.6.1.14 Car Enclosures, Car Doors and Gates, and Car Illumination. Car enclosures, car doors, gates, and car illumination shall conform to 2.14, except as modified by 5.6.1.14.1 and 5.6.1.14.2.

5.6.1.14.1 Requirement 2.14.3.1. The height of the car enclosure shall be permitted to be reduced when the height of the bow iron or stanchion is reduced as permitted by 5.6.1.15.2(a).

5.6.1.14.2 All electrical equipment on the car shall be weatherproof.

5.6.1.15 Car Frames and Platforms. Car frames and platforms shall conform to 2.15, 5.6.1.15.1, and 5.6.1.15.2.

5.6.1.15.1 Platforms

(a) Car frames of the underslung rope-suspended-type elevators shall be of sufficient depth to provide the minimum vertical clearance between the car rope hitches or car sheaves and any obstruction in the hoistway vertically above them, as specified in 2.4.8, when the car floor is level with its upper landing level.

(b) The depth of the car frame and the length and spacing of guiding members shall conform to 2.15.4 and, shall be such as to prevent tipping of the platform when it is at the highest upper landing level.

(c) The car platform shall be provided with metal aprons or guards on all exposed sides conforming to the following:

(1) They shall be made of metal of not less than 1.5 mm (0.059 in.) in thickness.

(2) They shall have a straight vertical face flush with the outer edge of the platform having a depth of not less than the distance between the normal upper

terminal landing level and the highest upper landing level plus 75 mm (3 in.).

(3) The lower portion of the guard shall be rounded or beveled at an angle of approximately 75 deg with the horizontal.

5.6.1.15.2 Bow Irons and Stanchions. Where hinged doors or vertically lifting covers are provided at the rooftop bow irons or stanchions shall be provided on the car to operate the doors or covers. Bow irons and stanchions shall conform to the following requirements:

(a) They shall be not less than 2 130 mm (84 in.) high, measured from the finished car floor, except that this height shall be permitted to be reduced by an amount necessary to permit the doors or covers to close when the car is at the landing next to the top terminal landing.

(b) They shall be so designed, installed, and braced as to withstand the impact when striking the doors or covers.

(c) Bow irons shall be located approximately symmetrical with respect to the center of the car platform.

(d) Stanchions shall be framed together at their upper ends and provided with spring buffers at the top.

5.6.1.16 Capacity and Loading. Capacity and loading shall conform to 2.16.

5.6.1.17 Safeties. Safeties shall conform to 2.17.

5.6.1.18 Governors. Governors, where provided, shall conform to 2.18.

5.6.1.19 Suspension Ropes. Suspension ropes shall conform to 2.20.

5.6.1.20 Counterweights. Counterweights, when provided, shall conform to 2.21.

5.6.1.21 Buffers and Bumpers. Buffers and bumpers shall conform to 2.22.

5.6.1.22 Guide Rails. Guide rails shall conform to 2.23.

5.6.1.23 Driving Machines and Sheaves. Driving machines and sheaves shall conform to 2.24, except that on freight elevators the ratio of the drum diameter to the rope diameter (see 2.24.2) shall be permitted to be reduced to 24 for elevators with a rated load of 1 150 kg (2 500 lb) or less.

5.6.1.24 Terminal Stopping Devices. Terminal stopping devices shall conform to 2.25 and 5.6.1.8.

5.6.1.25 Operating Devices and Control Equipment. Operating devices and control equipment shall conform to 2.26, except as modified by 5.6.1.25.1 through 5.6.1.25.5.

All electrical equipment on the car shall be weatherproof.

Actuation of a landing call button when the car is at the roof level shall illuminate a visual "in-use" signal

at the landing station at which the landing call was registered, and sound an audible and visual alarm at the roof level. The audible alarm shall have a sound pressure rating of not less than 80 dBA nor greater than 90 dBA at 3.05 m (10 ft).

Operation to the roof level shall be in accordance with 5.6.1.25.1.

5.6.1.25.1 Types of Operating Devices. Operating devices in the car and at the lower landing are prohibited on two-stop elevators.

5.6.1.25.2 Operation to the Roof Level. The operation of elevators shall conform to the following:

(a) The operation of elevators between openings in the roof, which are protected by hinged doors or vertically lifting covers, and the first landing below the roof level shall conform to the following:

(1) key-operated continuous-pressure-type up-and-down switches; or

(2) continuous-pressure-type up-and-down operating buttons on the free end of a detachable, flexible cord not more than 1 525 mm (60 in.) in length.

(b) Key-operated switches shall be of the continuous-pressure spring-return type and shall be operated by a cylinder-type lock having not less than a five-pin or five-disk combination with the key removable only when the switch is in the "OFF" position. The key shall be Group 2 Security (see 8.1).

(c) Key-operated switches and plug receptacles for flexible cords shall be weatherproof and shall be installed above the roof level, located within 1 525 mm (60 in.) horizontally from one side of the opening in such a manner that the opening is within clear sight of the operator.

(d) It shall be possible to operate the car only by means of either the key switches or the continuous-pressure-type up-and-down buttons on the free end of the flexible cord specified in 5.6.1.25.2(a).

(e) Flexible cords and operating keys shall not be left where they are accessible to unauthorized persons for operation of the elevator.

(f) Means of two-way communication shall be provided between the car, lower terminal landing, the first landing below the roof level, and the rooftop operating station.

(g) On multiple-stop elevators, the car operating panels shall only be operational for floors below the roof level.

5.6.1.25.3 Top-of-Car Operating Devices and Stop Switch. A top-of-car operating device shall not be provided if the rise is 6.1 m (20 ft) or less.

Top-of-car operating devices, when required, shall conform to 2.26.1.4.

A stop switch shall be provided on top of the car, conforming to 2.26.2.8.

5.6.1.25.4 Maximum Rated Speed. When the car bow iron or stanchion is in contact with the rooftop door or cover, the rated speed shall not exceed 0.13 m/s (25 ft/min).

When the car is fully enclosed, other than when it is running through the rooftop door or cover, there is no limit on the rated speed except as required by 5.6.1.25.2 and 5.6.1.25.3.

5.6.1.25.5 Operation to the Roof Level. Operation to the roof level shall be in accordance with 5.6.1.25.2.

5.6.1.26 Emergency Operation and Signaling Devices. Emergency operation and signaling devices shall conform to 2.27.

5.6.1.27 Welding. Welding shall conform to 8.8.

5.6.2 Direct-Plunger Hydraulic Rooftop Elevators

5.6.2.1 Hoistways, Hoistway Enclosures, and Related Construction. Hoistways, hoistway enclosures, and related construction shall conform to 5.6.1.1 through 5.6.1.13, and 5.6.2.2 through 5.6.2.5, except 5.6.1.4 and 5.6.1.6.

5.6.2.2 Vertical Clearances and Runbys. Where a car top is provided, bottom and top clearances and runbys for cars and counterweights shall conform to 3.4.

Where no car top is provided, they shall conform to 3.4.1, 3.4.2.1, and 3.4.6.2.

5.6.2.3 Protection of Spaces Below Hoistway. Where the hoistway does not extend to the lowest floor of the building, it shall conform to 3.6.

5.6.2.4 Machine Rooms and Machinery Spaces. Machine rooms and machinery spaces shall conform to 3.7.

5.6.2.5 Emergency Doors. The requirements for emergency doors in single blind hoistways shall conform to 2.11.

5.6.2.6 Car Enclosures, Car Doors and Gates, and Car Illumination. Car enclosures, car doors, gates, and car illumination shall conform to 2.14.

5.6.2.7 Car Frames and Platforms. Car frames and platforms shall conform to 3.14, 5.6.1.15.1, and 5.6.1.15.2.

5.6.2.8 Capacity and Loading. Capacity and loading shall conform to 2.16, except as modified by 3.16.

5.6.2.9 Car and Counterweight Safeties

5.6.2.9.1 Car safeties, where provided, shall conform to 2.17, except as modified for freight elevators by 5.6.1.17 and shall be of the type that can be released only by moving the car in the up direction.

5.6.2.9.2 Counterweight safeties, where provided, shall conform to 3.16.

5.6.2.10 Hydraulic Jacks. Hydraulic jacks shall conform to 3.18.

5.6.2.11 Valves, Pressure Piping, and Fittings. Valves, pressure piping, and fittings shall conform to 3.19.

5.6.2.12 Counterweights. Where provided, counterweights shall conform to 3.15.

5.6.2.13 Buffers and Bumpers. Buffers and bumpers shall conform to 3.21 and 3.22.2.

5.6.2.14 Guide Rails. Guide rails and their supports and fastenings shall conform to 3.23 and 3.28.

5.6.2.15 Tanks. Tanks shall conform to 3.24.

5.6.2.16 Terminal Stopping Devices. Terminal stopping devices shall conform to 3.25 and 5.6.1.8.

5.6.2.17 Operating Devices and Control Equipment. Operating devices and control equipment shall conform to 3.26. Requirements 5.6.1.25.1, 5.6.1.25.2, 5.6.1.25.4, 5.6.1.25.5, 5.6.1.26, and 5.6.1.27 and all electrical equipment on the car shall be weatherproof.

5.6.2.17.1 Top-of-Car Operating Device and Stop Switch. Top-of-car operating device when required shall conform to 5.6.1.25.3.

SECTION 5.7 SPECIAL PURPOSE PERSONNEL ELEVATORS

In jurisdictions not enforcing NBCC, requirement 5.7 applies to elevators permanently installed in a wide variety of structures and locations to provide vertical transportation of authorized personnel and their tools and equipment only. Such elevators are typically installed in structures such as grain elevators, radio antennas and bridge towers, underground facilities, dams, power plants, and similar structures where, by reason of their limited use and the types of construction of the structures served, full compliance with Part 2 is not practicable or necessary.

Requirement 5.7 applies to special purpose personnel elevators having a traction, winding drum, screw, or rack-and-pinion driving machine.

NOTE: See also Part 8 for additional requirements that apply to *special purpose personnel elevators*.

5.7.1 Construction of Hoistways and Hoistway Enclosures

5.7.1.1 Hoistways and Hoistway Enclosures. Where the hoistway is adjacent to areas permitting passage of people (e.g., passageways, stairwells, elevator landings), it shall be enclosed to a height of not less than 2 130 mm (84 in.) above the floor or stair treads. The enclosure shall be of sufficient strength to prevent contact between the enclosure and the car or counterweight when the

enclosure is subjected to a force of 1 112 N (250 lbf) applied at right angles at any point over an area of 100 mm × 100 mm (4 in. × 4 in.). Openwork enclosures shall be permitted to be used and shall reject a ball 25 mm (1 in.) in diameter.

5.7.1.2 Floor Over Hoistway. A floor conforming to 2.1.3.1 and 2.1.3.4 shall be provided at the top of the hoistway.

5.7.2 Pits

A pit conforming to 2.2 shall be provided for every elevator.

5.7.3 Location and Enclosing of Counterweights

5.7.3.1 Counterweight Coming Down to Floors or Passing Floors or Stairs. Where a counterweight runway comes down to a floor or passes a floor or stairs, it shall be enclosed to a height of at least 2 130 mm (84 in.) above the floor or the stair treads by a solid or openwork enclosure. The enclosure shall be of sufficient strength to prevent contact between the enclosure and the counterweight when the enclosure is subjected to a force of 1 100 N (250 lbf) applied at right angles at any point over an area of 100 mm × 100 mm (4 in. × 4 in.). Openwork enclosures shall reject a ball 25 mm (1 in.) in diameter and shall be so located as to provide at least 100 mm (4 in.) between the outside of the enclosure and the closest member of the counterweight assembly.

5.7.3.2 Access to Enclosed Counterweights and Ropes. Access shall be provided for inspection, maintenance, and repair of an enclosed counterweight and its ropes. Doors in the counterweight enclosures shall be self-closing and shall be provided with

(a) an electric contact, the opening of which will remove power from the elevator driving-machine motor and brake

(b) a self-locking keyed tumbler lock

5.7.4 Vertical Clearances and Runby

5.7.4.1 Bottom Runby. Bottom runby shall conform to 2.4.2, 2.4.3, and 2.4.4.

5.7.4.2 Top Car Clearance. There shall be a clearance of not less than 762 mm (30 in.) from the highest projection of the car top or the car crosshead or the equipment mounted on the car top and the nearest part of the overhead structure, when the counterweight is resting on its fully compressed buffer as required in 2.4.6.

For rack-and-pinion elevators without counterweights, there shall be a clearance of not less than 762 mm (30 in.) from the highest projection of the car top and the nearest part of the overhead structure, when the car has reached the uppermost limit of its travel. The top car clearance shall conform to 2.4.6 and 2.4.7.

5.7.5 Horizontal Car and Counterweight Clearances

Horizontal car and counterweight clearances shall conform to 2.5 and 5.7.3.1.

5.7.6 Protection of Spaces Below Hoistway

Protection of spaces below hoistways not extending to the lowest level of the structure shall conform to the applicable requirements of 2.6.1.

5.7.7 Overhead Machinery Beams and Supports

5.7.7.1 Securing of Machinery Beams and Type of Supports

5.7.7.1.1 All machinery and sheaves shall be so supported and secured as to effectively prevent any part becoming loose or displaced.

5.7.7.1.2 Beams directly supporting machinery shall be of steel or reinforced concrete.

5.7.7.1.3 Machinery or equipment shall be secured to and supported on, or from the top of, overhead beams or floors, except for the following equipment:

(a) secondary or deflecting sheaves of traction elevators

(b) devices and their accessories for limiting or retarding car speed

(c) driving machines on the car

5.7.7.1.4 Cast iron in tension shall not be used for supporting members for sheaves where they are hung beneath beams.

5.7.7.2 Loads on Overhead Beams and Supports.

The total load on overhead beams shall be equal to the weight of all apparatus resting on the beams, plus twice the maximum load suspended from the beams.

5.7.7.2.1 The load resting on the beams shall include the complete weights of the driving machine, sheaves, controller, etc.

5.7.7.2.2 The load suspended from the beams shall include the sum of the tensions in all ropes suspended from the beams.

NOTE (5.7.7.2): The object in doubling the suspended load is to allow for impact, accelerating stresses, etc.

5.7.7.3 Factor of Safety of Overhead Beams and Supports. The factor of safety for overhead beams and their supports shall be not less than 5 for steel and 6 for reinforced concrete.

5.7.7.4 Allowable Stresses and Deflections. Overhead beams and supports shall conform to 2.9.4 and 2.9.5.

5.7.8 Hoistway Doors and Gates

5.7.8.1 Where Required. The full width of each landing opening shall be protected by doors or gates.

The landing opening shall be at least 2 030 mm (80 in.) in height. The entire entrance assembly shall be capable of withstanding a force of 1 100 N (250 lbf) applied on the landing site at right angles to, and approximately at the center of, a panel. This force shall be distributed over an area of 100 mm × 100 mm (4 in. × 4 in.). There shall be no permanent displacement or deformation of any parts of the entrance assembly resulting from this test. Openwork entrances shall reject a ball 25 mm (1 in.) in diameter.

5.7.8.2 Projections of Hoistway Doors or Gates Into Hoistway. The hoistway face of the landing doors or gates shall not project into the hoistway beyond the landing sill. No hardware, except that required for door locking devices or contacts, signals, or door operating devices, shall project into the hoistway beyond the line of the landing sill.

5.7.8.3 Access to Hoistways for Emergency and Inspection Purposes. A device to unlock and permit opening of the hoistway door from the landing side, regardless of the location of the car in the hoistway, shall be provided at the top and bottom landings and shall be permitted at all landings. This device shall be designed to prevent unlocking the door with common tools.

The operating means for unlocking the door shall be of Group 1 Security (see 8.1).

5.7.8.4 Opening of Hoistway Doors and Gates.

Hoistway doors or gates shall be so arranged that it will not be necessary to reach behind any panel or jamb to operate them.

5.7.8.5 Hangers and Stops for Sliding Hoistway Doors. Hangers, conforming to 2.11.11.4.1 and 2.11.11.4.2, shall be provided.

5.7.8.6 Distance Between Hoistway Doors or Gates and Landing Sills and Car Doors or Gates. The distance between the hoistway doors or gates and the hoistway edge of the landing sill shall not exceed 57 mm (2.25 in.), and the distance between the hoistway faces of the landing door or gate and the car door or gate shall not exceed 133 mm (5.25 in.).

5.7.9 Locking Devices for Hoistway Doors or Gates

Hoistway doors or gates shall be provided with hoistway door interlocks or with locking devices and electric contacts conforming to 2.12.

5.7.10 Car Enclosures, Car Doors and Gates, and Car Illumination

5.7.10.1 Enclosures Required. Except at the entrance, cars shall be fully enclosed with metal at the sides and top. The enclosure at the sides shall be solid or of openwork that will reject a ball of 25 mm (1 in.)

in diameter. The minimum clear height inside the car shall be 1 980 mm (78 in.).

5.7.10.2 Securing Enclosures. The car enclosure shall be secured to the platform in such a manner that it cannot work loose or become displaced in regular service.

5.7.10.3 Illumination in Car. Each car shall be provided with an electric light and a light control switch. The light shall provide illumination of at least 27 lx (2.5 fc) at the landing edge of the car platform.

5.7.10.4 Emergency Exits. When car size and construction permit, and other conditions warrant, an emergency exit with a cover shall be permitted in the top of the car enclosure conforming to 5.7.10.4.1 through 5.7.10.4.4.

5.7.10.4.1 The exit opening shall have an area of not less than 0.227 m² (352 in.²), and shall not measure less than 406 mm (16 in.) on any side.

5.7.10.4.2 The exit shall be so located as to provide a clear passageway unobstructed by fixed elevator equipment located in, or on top of, the car.

5.7.10.4.3 The exit cover shall open outward and shall be hinged, or otherwise attached, to the car top.

5.7.10.4.4 The exit cover shall be equipped with a switch or contact that, when opened, will cause a device to remove power from the machine motor and brake. The exit cover switch or contact shall be of a manual reset type.

5.7.10.5 Car Doors or Gates. A car door or gate that, when closed, shall guard the opening to its full height, shall be provided at each entrance to the car. Car doors shall be of solid or openwork construction that will reject a ball 25 mm (1 in.) in diameter. Collapsible car gates shall be of a design that, when fully closed (extended position), will reject a ball 75 mm (3 in.) in diameter.

5.7.11 Car Construction

5.7.11.1 Car Frames and Platforms. Elevator car frames shall be metal. Elevator car platforms shall be metal or a combination of metal and wood. Where wood is used, the platform shall conform to 2.15.8. Car frames and platforms shall have a factor of safety of not less than 5, based on the rated load.

5.7.11.2 Use of Cast Iron. Cast iron shall not be used in the construction of any member of the car frame or platform other than for guide shoes and guide-shoe brackets.

5.7.11.3 Use of Glass. Glass shall not be used in elevator cars, except for the car light and accessories necessary for the operation of the car or car vision panels that, if provided, shall conform to 2.14.2.5.

5.7.11.4 Number of Compartments. The car shall not have more than one compartment.

5.7.12 Capacity and Loading

5.7.12.1 Capacity and Data Plates. Capacity and data plates, conforming to 2.16.3, shall be provided.

5.7.12.2 Limitation of Load, Speed, and Platform Area. The rated load shall not exceed 454 kg (1,000 lb). The inside net platform area shall not exceed 1.208 m² (13 ft²). The minimum rated load shall not be less than that based on 3.35 kPa (70 lbf/ft²) of inside net platform area or 113 kg (250 lb), whichever is greater. The rated speed shall not exceed 0.76 m/s (150 ft/min). Winding drum machines shall comply with 2.24.1.

5.7.13 Car Safeties and Governors

5.7.13.1 Car Safeties and Governors for Traction and Winding-Drum-Type Elevators. Cars suspended by wire ropes shall be provided with a car safety capable of stopping and sustaining the car with rated load. The safeties shall be Type A and shall conform to 2.17.5.1.

The car safety shall be actuated by a speed governor. The governor shall be operated to set the safety when the car has attained a maximum speed of 0.9 m/s (175 ft/min). The operation of the safety shall conform to 2.17.8.1.

The speed governor shall be located where it cannot be struck by the car or counterweight in case of overtravel and where there is sufficient space for full movement of the governor parts. Governor ropes shall conform to 2.18.5.

5.7.13.2 Car Safeties and Governors for Rack-and-Pinion-Type Elevators. The car shall be provided with one or more safeties identified in 2.17.5. The safeties shall be attached to the car frame or supporting structure. All car safeties shall be mounted on a single car frame and shall operate on one pair of guide members or on one vertical rack.

Rack-and-pinion machines have safeties consisting of a freely rotating safety pinion, a governor, and a safety device that shall be permitted to form an integral unit mounted on the car. The freely rotating pinion travels on a stationary rack mounted vertically in the hoistway. The rotating pinion drives the governor. When the downward speed of the car reaches the tripping value, the rotating governor actuates the safety device, which, in turn, brings the car to a gradual stop.

5.7.13.2.1 Stopping Distances. The travel of the car measured from the governor tripping to the full stop shall not exceed the following values:

- (a) for car safeties: 1 625 mm (64 in.)
- (b) for counterweight safeties: 1 980 mm (78 in.)

5.7.13.2.2 Marking Plates. A metal plate shall be securely attached to each safety so as to be readily visible

and shall be marked in a legible and permanent manner with letters and figures not less than 6.4 mm (0.25 in.) in height, indicating the following:

(a) the maximum governor tripping speed, in m/s (ft/min), for which the safety is rated to be used

(b) the maximum weight, in kg (lb), which the safety, as installed, is designed to stop and sustain

5.7.13.2.3 Governor Ropes. Governor ropes shall conform to 2.18.5, when applicable.

5.7.13.3 Opening of Brake and Motor Control Circuits on Safety Application. The motor control circuit and the brake control circuit shall be opened before, or at the time, the safety applies.

5.7.13.4 Application of Car Safety. A car safety device that depends upon the completion or maintenance of an electric circuit for the application of the safety shall not be used. Car safeties shall be applied mechanically.

5.7.13.5 Minimum Factors of Safety and Stresses of Safety Parts and Rope Connections. The minimum factors of safety and stresses of safety parts and any associated rope connections shall conform to 2.17.12.

5.7.14 Suspension Ropes

5.7.14.1 Types Permitted. Suspension means shall consist of not less than two wire ropes.

Only iron (low-carbon steel) or steel wire ropes, having the commercial classification "Elevator Wire Rope," or wire rope specifically constructed for elevator use shall be used for the suspension of elevator cars and for the suspension of counterweights. The wire material for ropes shall be manufactured by the open-hearth or electric furnace process or their equivalent.

5.7.14.2 Minimum Diameter of Suspension Ropes. The minimum diameter of any suspension rope shall be not less than 9.5 mm (0.375 in.).

5.7.14.3 Factor of Safety of Suspension Means. The factor of safety of the suspension means shall be not less than 7.95.

5.7.14.4 Arc of Contact of Suspension Means on Sheaves. The arc of contact of a wire rope on a traction sheave and the shape of the grooves shall be sufficient to produce adequate traction under all load conditions.

5.7.14.5 Arrangement of Wire Ropes on Winding Drums. All wire ropes anchored to a winding drum shall have not less than one full turn of rope on the drum when the car or counterweight has reached its limit of possible overtravel, including a fully compressed buffer. Each turn of the wire rope on the winding drum shall be in a separate groove on the drum.

5.7.14.6 Lengthening, Splicing, Repairing, or Replacing Suspension Means. No car or counterweight

rope shall be lengthened or repaired by splicing. If one wire rope of a set is worn or damaged and requires replacement, the entire set of ropes shall be replaced.

5.7.14.7 Securing Ends of Suspension Ropes in Winding Drums. The winding drum ends of car and counterweight wire ropes shall be secured by clamps on the inside of the drum or by one of the methods specified in 5.7.14.8 for fastening wire ropes to car or counterweight.

5.7.14.8 Fastening of Rope Suspension Means to Cars and Counterweights. The car or counterweight ends of wire ropes shall be fastened by properly made individual tapered babbitted sockets or by properly attached fittings as recommended by wire-rope manufacturers.

Tapered babbitted rope sockets and the method of babbitting shall conform to 2.20.9.4 and 2.20.9.6. The diameter of the hole in the small end of the socket shall not exceed the nominal diameter of the rope by more than 2.4 mm (0.094 in.).

5.7.15 Counterweight Guiding and Construction

5.7.15.1 Guiding. Counterweights shall be guided to prevent horizontal movement. Guide rails, where used, shall conform to 5.7.17.

5.7.15.2 Car Counterweights. A car counterweight on winding drum elevators shall not be of sufficient weight to cause slackening of any car hoisting rope during acceleration or retardation of the car.

5.7.15.3 Types of Counterweight Construction

(a) One-piece solid or laminated steel counterweights shall be permitted to be used.

(b) Means shall be provided to retain counterweight sections, if used, in place if they become broken, whether carried in a frame or not. If tie rods are used, the sections shall be fastened together by a minimum of two tie rods that pass through all weight sections. Tie rods shall be provided with locknuts and cotter pins at each end.

5.7.16 Car and Counterweight Buffers

5.7.16.1 Car and counterweight buffers shall be provided and shall conform to the applicable requirements of 2.22.

5.7.16.2 For rack-and-pinion elevators, spring buffers, where used, shall be so designed and installed that they will not be fully compressed when struck by the car with its rated load at governor tripping speed where the safety is governor operated, or at 125% of rated speed where the safety is not governor operated. Kinetic energy from the drive unit shall be taken into account in the design calculations. The effect of the counterweight, where used, shall be permitted to be taken into account in the design calculations.

5.7.17 Car Guide Rails and Guide-Rail Fastenings

Car guide rails shall be provided.

5.7.17.1 Material. Guide rails and guide-rail fastenings shall be of steel, or where steel presents a hazard, as in chemical or explosive atmospheres, guide rails shall be permitted to be of selected wood or other suitable nonferrous materials.

(ED) **5.7.17.2 Fastenings, Deflections, and Joints.** Guide rails shall be securely fastened, shall not deflect more than 6 mm (0.25 in.) under normal operation, and shall have their joints well-fitted and strongly secured. Guide rails and their joints and fastenings shall withstand without failure the application of the car safety when stopping the car with its rated load.

5.7.17.3 Extension of Guide Rails at Top and Bottom of Hoistway. Guide rails shall extend from the bottom of the hoistway to a sufficient height above the top landing to prevent the guide shoes from running off the rails when the car or counterweight is at its extreme upper position.

5.7.18 Driving Machines and Sheaves

5.7.18.1 Types of Driving Machines. Driving machines shall be of the traction, drum, screw, or rack-and-pinion type. The installation of belt-drive and chain-drive machines is prohibited.

5.7.18.1.1 Screw Machines. Screw machines shall conform to 4.2.15.

5.7.18.1.2 Rack-and-Pinion Machines. The rack-and-pinion drive shall consist of one or more power-driven rotating pinions mounted on the car and arranged to travel on a stationary vertical rack mounted in the hoistway. The drive shall have at least one pinion, one rack, and two backup rollers. The pinions and rack shall be of steel with a minimum safety factor of 8 for the pinion and the rack. Driving machines located within the car shall be fully enclosed with solid or openwork metal that shall reject a ball 13 mm (0.5 in.) in diameter and that shall be locked.

5.7.18.2 Material and Grooving for Sheaves and Drums. Winding drums, traction sheaves, and overhead and deflecting sheaves shall be of cast iron or steel and of a pitch diameter of not less than 30 times the diameter of the wire suspension ropes, except that where 8 × 19 steel ropes are used on a drum-type machine installation, the pitch diameter of drums and sheaves shall be permitted to be reduced to 21 times the diameter of the rope. The rope grooves shall be machined.

5.7.18.3 Factor of Safety for Driving Machines and Sheaves. The factor of safety for driving machines and sheaves shall conform to 2.24.3.

5.7.18.4 Bolts Transmitting Torque, and Set Screws. Bolts transmitting torque, and set screws shall conform to 2.24.4.

5.7.18.5 Friction-Gearing or Clutch Mechanism. Friction-gearing or clutch mechanisms shall not be used for connecting the drum or sheaves to the main driving mechanism.

5.7.18.6 Use of Cast Iron in Gears. Worms and worm gears made of cast iron shall not be used.

5.7.18.7 Driving-Machine Brakes. Driving machines shall be equipped with electrically released spring-applied friction brakes.

5.7.18.8 Operation of Brake. A single ground or short circuit, a countervoltage, or a motor field discharge shall not prevent the brake magnet from allowing the brake to set when the operating device is placed in the stop position.

5.7.18.9 Access to Machines and Sheaves. A permanent, safe, and convenient means of access to elevator machine rooms and overhead machinery spaces shall be provided for authorized personnel.

5.7.19 Operating Devices and Control Equipment

Operating devices and control equipment shall conform to 2.26, except for the following, which do not apply:

- 2.26.1.2 For Car-Switch Operation Elevators
- 2.26.1.3 Additional Operating Devices for Elevators Equipped to Carry One-Piece Loads Greater Than the Rated Load
- 2.26.1.4 Inspection Operation (NOTE: A top-of-car operating station may be provided, and if provided, shall conform to 2.26.1.4)
- 2.26.1.6 Operation in Leveling or Truck Zone
- 2.26.2.12 Emergency Terminal Speed-Limiting Devices
- 2.26.2.13 Buffer Switches for Oil Buffers Used With Type C Car Safeties
- 2.26.2.14 Hoistway Door Interlocks and Hoistway-Door Electric Contacts
- 2.26.2.20 Electric Contacts for Hinged Car Platform Sills
- 2.26.10 Absorption of Regenerated Power

5.7.20 Operation

5.7.20.1 Types of Operation. The following types of operation shall be permitted:

- (a) continuous-pressure operation.
- (b) momentary-pressure operation with up-down buttons or switches in the car and up-down buttons or switches, or call buttons, at each landing. It is not required that the operation be selective.
- (c) single automatic operation.

5.7.20.2 Hand-Rope Operation. Hand-rope operation shall not be used.

5.7.21 Emergency Signal and/or Communication

Each elevator shall be equipped with an alarm button or switch in the car operating station and an alarm device mounted in a location that shall be readily available to a person who is normally situated in the vicinity when the elevator is in use, or a means of voice communication to a receiving station always attended when the installation is in use. If the alarm device or means of voice communication is normally activated by utility power supply, it shall be backed up by a manual or battery-operated device.

5.7.22 Layout Drawings

Information provided on layout drawings shall conform to 2.28.1.

5.7.23 Welding

All welding shall conform to 8.8.

SECTION 5.8 MARINE ELEVATORS

Section 5.8 applies to elevators installed on board a marine vessel. See also Part 8 for additional requirements that apply to marine elevators.

5.8.1 Electric Marine Elevators

Electric marine elevators shall conform to Part 2, except as modified by 5.8.

5.8.1.1 Hoistway Enclosures. The hoistway shall be entirely enclosed over all of its height by means of a continuous solid steel fire-resistive enclosure with an equivalent fire-resistance rating of 1 h as defined in the 1974 Amendment of SOLAS Regulation 3. Elevators with total travel within one compartment of the vessel shall be permitted to be enclosed with expanded metal having openings the maximum of 25 mm (1 in.). The hoistway enclosure shall be of sufficient strength to prevent contact between the enclosure and the car or counterweight when the enclosure is subjected to a force of 1 112 N (250 lbf) applied at right angles at any point over an area of 100 mm × 100 mm (4 in. × 4 in.).

5.8.1.2 Separate Counterweight Hoistways. The hoistway shall be entirely enclosed over all of its height by means of a continuous solid steel fire-resistive enclosure with an equivalent fire-resistance rating of 1 h as defined in the 1974 Amendment of SOLAS Regulation 3. Where a separate counterweight hoistway is provided on an elevator that has total travel within a single compartment of the vessel, it shall be permitted to be enclosed with expanded metal having openings the maximum of 25 mm (1 in.). The hoistway enclosure shall

be of sufficient strength to prevent contact of the car or counterweight and its enclosure when the enclosure is subjected to a force of 1 112 N (250 lbf) applied at right angles at any point over an area of 100 mm × 100 mm (4 in. × 4 in.).

5.8.1.3 Protection of Space Below Hoistway. All elevators shall be provided with elevator counterweight safeties conforming to 2.17.4.

5.8.1.4 Hoistway Entrances. Except when opening and closing in response to control signals, each hoistway door shall have means to prevent door movement and slamming when the vessel is subjected to conditions up to and including a 30-deg roll and a 10-deg pitch simultaneously.

5.8.1.5 Top Emergency Exits. It shall be permissible to open the top emergency exit cover from the top of car or from within the car. This exit cover shall be provided with an electric contact conforming to 2.12.5. The breaking of this contact shall cause the power to be removed from the elevator driving motor and brake and the power shall be restored only by a manually operated reset switch located inside the elevator enclosure. Means shall be provided within the elevator car to gain access to the top emergency exit. A fixed vertical ladder of noncombustible material shall be provided on the inside of the hoistway to permit access from the top of the car to the hoistway entrance above. Means shall be provided to snap latch the cover closed or fully open.

5.8.1.6 Illumination of Cars. Elevators used primarily for the movement of personnel shall have the electrical power meet the requirements of IEEE 45 with car enclosure lighting to be supplied from the vessel's final emergency power source. In addition, a standby (emergency) lighting power source shall be furnished conforming to 2.14.7.1.3.

5.8.1.7 Traction Driving Machines

5.8.1.7.1 Traction driving machines shall be provided with a device to cause the elevator to stop and remain stopped if

(a) when a start is initiated, the driving machine does not rotate

(b) the car or counterweight is stopped in a downward motion by an obstruction that causes the suspension ropes to slip on the driving sheave

5.8.1.7.2 This device shall function in a time that does not exceed the smaller of the following values:

(a) 45 s

(b) time for car traveling the full travel, plus 10 s with a minimum of 20 s if the full travel time is less than 10 s

5.8.1.7.3 This device shall not affect operation from top-of-car inspection station.

5.8.1.7.4 Driving machines shall be provided with a manual means of operation, allowing the car to

be moved to the nearest landing in the event of a power failure. This shall be done by having the end of the drive motor shaft arranged to receive a crank. The manual effort required to move the car in the upward direction with rated load shall not exceed 400 N. One crank or tool shall be furnished for this purpose.

5.8.1.8 Emergency Operation and Signal Devices

(a) Shipboard elevators shall be required to conform to 2.27.1.1.

(b) In ships or offshore drilling rigs in which a watchman is not continuously available to take action when the required emergency signal is operated, the elevator shall be provided with one of the following additional emergency signaling devices:

(1) a telephone connected to a central telephone exchange system

(2) means within the car for communicating with or signaling to an emergency service that operates 24 h each day

5.8.1.9 Special Conditions. Elevators shall be designed and installed to function in accordance with 2.14 through 2.28 when operating under the following conditions inherent to the installation location:

(a) continuous vibration: 2 mm peak to peak of frequency 0 to 25 Hz

(b) rolling: ± 10 deg, period 10 s

(c) pitching: ± 5 deg, period 7 s

(d) heaving amplitude: $A = 3.8 - 0.01(L - 250)$, where L is the length of the ship, in meters, measured between the perpendicular taken at extremities of the deepest subdivision loadline

5.8.1.10 Handrails. Cars shall be fitted with at least one handrail.

5.8.1.11 Flooring. Cars shall be fitted with slip-resistant flooring.

5.8.2 Hydraulic Shipboard Elevators

Hydraulic shipboard elevators shall conform to Part 3, except as modified by 5.8.1 and 5.8.2.

5.8.2.1 Storage Tanks. Power unit oil storage tanks shall be constructed in such a manner to prevent spillage of hydraulic fluid under the following conditions inherent to the installation location:

(a) rolling: ± 45 deg

(b) pitching: ± 5 deg

5.8.2.2 Special Conditions. Elevators shall be designed and installed to function in accordance with Part 3 when operating under the following conditions inherent to the installation location:

(a) continuous vibration: 2 mm peak to peak of frequency 0 to 25 Hz

(b) rolling: ± 10 deg, period 10 s

(c) pitching: ± 5 deg, period 7 s

(d) heaving amplitude: $A = 3.8 - 0.01(L - 250)$, where L is the length of the ship, in meters, measured between the perpendicular taken at extremities of the deepest subdivision loadline

5.8.2.3 Handrails. Cars shall be fitted with at least one handrail.

5.8.2.4 Flooring. Cars shall be fitted with slip-resistant flooring.

5.8.3 Rack-and-Pinion Shipboard Elevators

Rack-and-pinion shipboard elevators shall conform to 4.1, except as modified by 5.8.1 and 5.8.3.

5.8.3.1 Special Conditions. Elevators shall be designed and installed to function in accordance with 4.1 when operating under the following conditions inherent to the installation location:

(a) continuous vibration: 2 mm peak to peak of frequency 0 to 25 Hz

(b) rolling: ± 10 deg, period 10 s

(c) pitching: ± 5 deg, period 7 s

(d) heaving amplitude: $A = 3.8 - 0.01(L - 250)$, where L is the length of the ship, in meters, measured between the perpendicular taken at extremities of the deepest subdivision loadline

5.8.3.2 Handrails. Cars shall be fitted with at least one handrail.

5.8.3.3 Flooring. Cars shall be fitted with slip-resistant flooring.

SECTION 5.9 MINE ELEVATORS

In jurisdictions not enforcing NBCC, requirement 5.9 applies to elevators as covered by Part 2, permanently installed in mine shafts. The purpose is to provide vertical transportation of mine personnel, their tools, equipment, and mine supplies. By reason of their limited use and the types of construction of the mines served, compliance with Part 2 is modified as follows (see also 1.3):

(a) Substitute "Title 30 Code of Federal Regulations" or "State Mine Laws" (if applicable) for "building code."

(b) Substitute "mine" for "building."

(c) Requirements modified in 5.9.

NOTES (5.9):

(1) Title 30 Code of Federal Regulations provides for certain additional and more stringent requirements. Where applicable, Title 30 requirements have been addressed in this Section.

(2) See also Part 8 for additional requirements that apply to *mine elevators*.

5.9.1 Construction of Hoistways and Hoistway Enclosures

The construction of hoistway enclosures shall conform to 2.1, except as modified by the following:

- (a) Requirement 2.1.1 does not apply, except for 2.1.1.3 and 2.1.1.5, which do apply.
- (b) Requirement 2.1.6.2 does not apply.

5.9.2 Pits

Pits or the area below the elevator shall conform to 2.2, except as modified by 5.9.2.1 and 5.9.2.2.

5.9.2.1 When the pit extends below the mine level, a pit water level alarm shall be provided in an attended location to annunciate water accumulation in the elevator pit. This water level alarm shall be powered from the elevator electrical source. The elevator shall return to the surface and shall not be permitted to start if the power to the water level annunciator is interrupted.

5.9.2.2 When the bottom of the hoistway is located at or above the mine level, a walk-in pit is permitted. A ramp shall be permanently installed to provide access to the mine level from the bottom landing. Required bottom runby and space for the buffers, tension frames, and other equipment normally installed in the pit must be considered when determining the location of the bottom landing. The pit floor shall be so designed to prevent accumulation of water in the area. The area shall be protected with either an unperforated metal guard, or if of openwork, guards shall reject a ball 50 mm (2 in.) in diameter. Guards shall extend not less than 2 000 mm (78 in.) above the level of the pit floor.

5.9.3 Location and Guarding of Counterweights

The location and guarding of counterweights shall conform to 2.3.

5.9.4 Vertical Clearances and Runbys for Cars and Counterweights

Bottom and top car clearances and runbys for cars and counterweights shall conform to 2.4, except 2.4.12 shall have the minimum vertical distance in the refuge area increased from 1 100 mm (43 in.) to 2 000 mm (78 in.).

5.9.5 Horizontal Car and Counterweight Clearances

Horizontal car and counterweight clearances shall conform to 2.5, except as modified by 5.9.5.

Requirement 2.5.1.5 only applies when the car is located at the lower landing.

5.9.6 Protection of Space Below Hoistways

The protection of space below the hoistways shall conform to 2.6.

5.9.7 Machine Rooms and Machinery Spaces

Machine rooms and machinery spaces shall conform to 2.7, except as modified by the following:

- (a) Requirement 2.7.1.1.2 does not apply.
- (b) Note (3) in 2.7.1.1 does not apply.

5.9.8 Equipment in Hoistways and Machine Rooms

Electrical equipment, wiring, pipes, and ducts in hoistways and machinery rooms shall comply with 2.8, except as modified by 5.9.8.1 and 5.9.8.2.

5.9.8.1 Hoistway and Car Wiring. In addition to the requirements of 2.8.1, all wiring, raceways, and traveling cables installed in the hoistway or on the car, used directly in connection with the elevator, shall be suitable for weatherproof (NEMA 4) application. Suitable expansion joints shall be provided in vertical raceways, if necessary, to prevent damage caused by extreme temperature changes.

5.9.8.2 Requirement 2.8.2 does not apply.

(a) All pipes shall be secured to prevent interference with the elevator equipment.

(b) The clearance between pipes, fittings, brackets, and elevator equipment shall be not less than 25 mm (1 in.).

(c) All pipes shall be suitably identified as to its contents.

NOTE (5.9.8): Note (1) in 2.8.4 does not apply.

5.9.9 Machinery and Sheave Beams, Supports, and Foundations

Machinery and sheave beams, supports, and foundations shall conform to 2.9.

5.9.10 Guarding

The guarding of equipment and standard railing shall conform to 2.10.

5.9.11 Protection of Hoistway Openings

The protection of hoistway landing openings shall conform to 2.11, except as modified by the following:

(a) Requirement 2.11.7.2 does not apply. Glass hoistway doors are prohibited.

(b) Requirement 2.11.14 does not apply.

(c) Requirement 2.11.15 does not apply.

(d) Requirement 2.11.16 does not apply.

(e) Requirement 2.11.17 does not apply.

(f) Requirement 2.11.18 does not apply.

(g) Requirement 2.11.19 does not apply.

5.9.12 Hoistway Door Locking Devices and Electric Contacts, and Hoistway Access Switches

Hoistway door locking devices, hoistway door and car door or gate electric contacts, and hoistway access

switches shall conform to 2.12, except as modified by the following:

- (a) In addition, a car door interlock shall be provided.
- (b) Hoistway access switches are not required if a car top access panel is provided.

5.9.13 Power Operation of Hoistway Doors and Car Doors

When provided, power operation of hoistway doors and car doors and gates shall conform to 2.13.

5.9.14 Car Enclosures, Car Doors and Gates, and Car Illumination

Car enclosures, car doors and gates, and car illumination shall conform to 2.14, except as modified by 5.9.14.1 through 5.9.14.5.

5.9.14.1 Car Top Access Panel. A car top access panel shall be provided in the top of all elevator cars. Car top access panels shall conform to the following:

(a) Requirement 2.14.1.5 applies, except as modified by this requirement. The car top access panel will substitute for the car top emergency exit panel.

(b) The car top access panel shall have an area of not less than 0.58 m² (900 in.²) and shall measure not less than 635 mm (25 in.) on any side. The panel shall open outward or slide over the car top. It shall be hinged, or be retained in a track. The movable portion of the access panel, if hinged, shall be provided with means to counterbalance the panel and restrain it from closing when in the open position. The force required to open the access panel or prevent it from closing shall not exceed 45 N (10 lbf). When in the fully opened position, the access panel shall resist accidental closing. The movable portion of the access panel shall not reduce the running clearance. The access panel shall be openable without the use of tools or keys.

(c) The car top access panel shall be provided with a switch whose contacts are positively opened mechanically and their opening shall not be dependent on springs that will initiate a controlled slow down and stop when the access panel is opened. A permanently mounted emergency stop switch shall be located on top of the car, adjacent to the access panel to secure the car prior to transferring to inspection operation.

5.9.14.2 A permanent fixed ladder shall be provided for passage through the car top access panel. The ladder shall project through the car canopy at least 1 070 mm (42 in.) above the car top, or handgrips shall be provided to the same height.

The rungs, cleats, or steps shall be spaced 300 mm (12 in.) on center. A clear distance of not less than 115 mm (4.5 in.) from the centerline of the rungs, cleats, or steps to the nearest permanent object in the back of the ladder shall be provided. Handgrips, if provided, shall have a clear distance of not less than 115 mm (4.5 in.) from their centerline to the nearest permanent object.

5.9.14.3 Car Top Protection. Protection from falling debris shall be provided on all car tops. The car top protection shall

(a) not interfere with the use of the car top access panel

(b) be solid without perforations and shall comply with strength requirements of 2.14.1.6

(c) provide a minimum head height clearance of 2 m (78 in.)

(d) be removable if the car top protection interferes with normal inspection, maintenance, and repairs

5.9.14.4 Requirement 2.14.1.7.2 does not apply.

5.9.14.5 Requirement 2.14.7.1.3 does not apply.

5.9.15 Car Frames and Platforms

Car frames and platforms shall conform to 2.15 and 5.9.15.1.

5.9.15.1 Corrosion Protection. Car frames, platforms, bolts, rivets, and fastenings shall be treated with a corrosion-resistant protective coating, be electroplated, or be made of corrosion-resistant material.

5.9.16 Capacity and Loading

Capacity and loading requirements shall conform to 2.16.

5.9.17 Car and Counterweight Safeties

Car and counterweight safeties shall conform to 2.17, except as modified by 5.9.17.1 through 5.9.17.6.

5.9.17.1 Requirement 2.17.7.2 applies, except every safety shall be provided with a switch, operated by the safety mechanism (see 2.26.2.9).

The counterweight safety switch shall be operated by the safety mechanism or a means to detect application of the safety independent from the counterweight governor switch(es) shall be provided.

5.9.17.2 Requirement 2.17.7.3 applies to both car and counterweight safety mechanism switches.

5.9.17.3 Requirement 2.17.7.4 applies to both car and counterweight safety mechanism switches.

5.9.17.4 Requirement 2.17.9.1 applies, except safeties applied by rope drums are prohibited.

5.9.17.5 Requirement 2.17.9.3 applies to both car and counterweight safeties. When the counterweight safeties are furnished, means shall be provided to release the safeties if both safeties are applied simultaneously.

5.9.17.6 Requirement 2.21.4.2 does not apply.

5.9.18 Speed Governors

Speed governors shall conform to 2.18, except as modified by 5.9.18.1.

5.9.18.1 Governor Rope Tension Sheaves. In addition to the requirements of 2.18.7, the governor rope tension sheave shall be provided with a governor rope tension sheave switch or switches mechanically opened by the governor rope tension sheave before the sheave reaches its upper or lower limit of travel, to cause the elevator speed to be reduced to 0.75 m/s (150 ft/min). This switch shall be manually reset.

5.9.19 Ascending Car Overspeed and Unintended Car Movement Protection

Ascending car overspeed and unintended car movement protection shall conform to 2.19.

5.9.20 Suspension Ropes and Their Connections

Suspension ropes and their connections shall conform to 2.20.

5.9.20.1 Suspension and Compensating Means and Governor Ropes. When elevator suspension or compensating means or governor ropes are exposed to an environment that will cause corrosion, surface pitting, or loss of cross-sectional area, the wire ropes shall be constructed of electrogalvanized or other type of corrosion resistant material suitable for the environment and application.

5.9.21 Counterweights

Counterweights shall conform to 2.21.

5.9.22 Buffers and Bumpers

Buffers and bumpers shall conform to 2.22, except as modified by the following:

(a) Oil buffers shall be suitable for operation at extreme temperatures experienced in the anticipated mining environment.

(b) Requirement 2.22.4.5(c) applies, except that all oil buffers shall be provided with a switch conforming to 2.26.4.3 that will cause the power to be removed from the driving machine when the plunger is not within 13 mm (0.5 in.) of the fully extended position.

5.9.23 Car and Counterweight Guide Rails, Guide-Rail Supports, and Fastenings

Car and counterweight guide rails, guide-rail supports, and fastenings shall conform to 2.23.

5.9.24 Driving Machines and Sheaves

Driving machines and sheaves shall conform to 2.24.

5.9.25 Terminal Stopping Devices

Terminal stopping devices shall conform to 2.25.

5.9.26 Operating Devices and Control Equipment

Operating devices and control equipment shall conform to 2.26, except 2.26.2.5, 2.26.2.21, and 2.26.12.

An emergency stop switch shall be provided in the car, and located in or adjacent to each car operating panel.

When open ("STOP" position), this switch shall cause the electric power to be removed from the elevator driving-machine motor and brake.

Emergency stop switches shall

(a) be of the manually opened and closed type

(b) have red operating handles or buttons

(c) be conspicuously and permanently marked "STOP," and shall indicate the "STOP" and "RUN" positions

(d) while opened, cause the audible device to sound (see 2.27.1.1.1)

(e) conform to 2.26.4.3

5.9.27 Emergency Operations and Signaling Devices

Conformance to 2.27 is not required, except 2.27.1 and 2.27.2 apply.

5.9.28 Layout Drawings

Information required on layout drawings shall conform to 2.28.

5.9.29 Identification

Identification of equipment shall conform to 2.29, except 2.29.2 does not apply.

5.9.30 Welding

Welding shall conform to 8.8, except when welding in or above the hoistway, requirements of 30 CFR 75.1106 and 75.1106-1 apply.

SECTION 5.10 ELEVATORS USED FOR CONSTRUCTION

Requirement 5.10 applies to elevators temporarily used for construction or demolition to provide transportation for construction personnel, tools, and materials only.

Such elevators utilize temporary or permanent equipment in a temporary or permanent location. Because of their special use in a special environment, full compliance with Part 2 and Part 3 is not practical or necessary.

Requirement 5.10.1 applies to electric elevators used for construction.

Requirement 5.10.2 applies to hydraulic elevators of the direct-plunger type used for construction.

Elevators used for construction shall not be accessible to the general public unless they comply with Part 2 or Part 3.

NOTE (5.10): See also Part 8 for additional requirements that apply to *elevators used for construction*.

5.10.1 Electric Elevators Used for Construction

5.10.1.1 Construction of Hoistways and Hoistway Enclosures

5.10.1.1.1 Hoistway Enclosures

(a) Where the hoistway is adjacent to areas permitting passage of people (e.g., stairwells, floors, and work space exterior to the hoistway), it shall be fully enclosed. The enclosure shall be of sufficient strength to prevent contact between the enclosure material and the car or counterweight when the enclosure is subjected to a force of 890 N (200 lbf) applied at right angles at any point on an area 100 mm × 100 mm (4 in. × 4 in.). Openwork enclosures shall be permitted to be used on all but the entrance side of the hoistway and shall reject a ball 25 mm (1 in.) in diameter. Openwork enclosures shall be so located as to provide at least 150 mm (6 in.) clearance between the outside of the enclosure and the closest member of the car or counterweight assembly. Openwork enclosures shall not be used on elevators with car speeds of over 1.75 m/s (350 ft/min).

(b) Overhead protection shall be provided across the entire cross-sectional area of the hoistway. It shall be located above the machine when the machine is located directly over the elevator, and shall be capable of sustaining a concentrated load of 1 335 N (300 lbf) on any area 100 mm × 100 mm (4 in. × 4 in.).

(c) Where the elevator is operating in a multiple hoistway, and work is to be performed in an adjacent portion of that multiple hoistway, the construction elevator's hoistway shall be fully separated. The material used for this separation shall

- (1) be equal to or stronger than 1 mm (0.0437 in.) diameter wire
- (2) have openings not exceeding 25 mm (1 in.)
- (3) be so supported and braced that when subjected to a pressure of 4.79 kPa (100 lbf/ft²) applied horizontally at any point, the deflection shall not exceed 25 mm (1 in.)

5.10.1.1.2 Working Requirements in the Hoistway

(a) Hoisting of materials in any portion of the hoistway of the elevator used for construction is prohibited unless the car is not in use and is unoccupied.

(b) Conformance with 5.10.1.1(c) is required to allow work in adjacent portions of a multiple hoistway.

(c) Hoisting of materials in adjacent portions of a multiple hoistway is prohibited unless under the direct supervision of the elevator contractor.

5.10.1.2 Pits

(a) A pit shall be provided for every elevator.

(b) The design shall conform to 5.10.1.1.1.

(c) Guards between adjacent pits shall conform to 5.10.1.1.1(c).

(d) The minimum pit depth required shall conform to 2.2.7.

5.10.1.3 Location and Guarding of Counterweights

5.10.1.3.1 Location of Counterweights. The location of the counterweights shall conform to 2.3.1.

5.10.1.3.2 Counterweight Pit Guards

(a) Counterweight guards shall be installed in the pit on all open sides of the counterweight runway, except as follows:

(1) Where compensating chains or ropes are attached to the counterweight, the guard shall be permitted to be omitted on the side facing the elevator car.

(2) Where pit-mounted buffers are used, the guard is permitted to be omitted where the bottom of the counterweight resting on its compressed buffer is 2 130 mm (84 in.) or more above the pit floor.

(b) The design, construction, and location of the guards shall conform to 2.3.2.2. Perforated material that will reject a ball 25 mm (1 in.) in diameter shall be permitted to be used.

5.10.1.3.3 Separate Counterweight Hoistways.

Where separate counterweight hoistways are provided, they shall conform to

(a) requirement 2.3.3 for permanent separate hoistway

(b) requirement 5.10.1.1.1 for temporary separate hoistway

5.10.1.4 Vertical Car Clearances and Runby. Top and bottom car clearances and runby shall conform to 2.4.

5.10.1.5 Horizontal Car and Counterweight Clearances

(a) Horizontal car and counterweight clearances shall conform to 2.5.1.1, 2.5.1.2, 2.5.1.3, and 2.5.1.6.

(b) The clearance between the car and landing sills shall conform to 2.5.1.4, except that the maximum clearance shall be not more than 100 mm (4 in.).

5.10.1.6 Protection of Spaces Below Hoistways.

Protection of spaces below hoistways not extending to the lowest level of the structure shall conform to the applicable requirements of 2.6, or the space below the hoistway shall be temporarily secured from occupancy with a fence or wall.

5.10.1.7 Machine Rooms and Machinery Spaces

5.10.1.7.1 General Requirements

(a) Spaces containing machines, control equipment, sheaves, and other machinery shall be fully enclosed and protected from the elements. Enclosures shall be so supported and braced as to deflect not over 25 mm (1 in.) when subjected to a force of 450 N (100 lbf) applied horizontally over an area of 100 mm × 100 mm (4 in. × 4 in.). The overhead protection of the machine room shall conform to 5.10.1.1.1(b). The floor of the machine room shall conform to 5.10.1.7.2.

(b) A safe means of access to the machine room and machinery spaces shall be provided for authorized personnel. Access doors shall be of a minimum height of 1 830 mm (72 in.), and shall be kept closed and locked.

(c) Temporary electric lighting shall be provided in the machine room and machinery spaces. The illumination shall be not less than 100 lx (10 fc) at the floor level.

(d) Machine rooms shall be maintained free of refuse, and shall not be used for the storage of material unnecessary for the construction, maintenance, or operation of the elevator. Flammable liquids having a flash point of less than 38°C (100°F) shall not be kept in the machine room.

5.10.1.7.2 Machine Room and Machinery Space Floors

(a) A metal, concrete, or wood floor shall be provided, except that floors are not required below:

(1) secondary and deflecting sheaves of traction-type machines located over the hoistway

(2) overhead sheaves, governors, and other equipment where the elevator machine is located below or at the side of the hoistway, provided that

(a) means of access for inspection and servicing of governors is provided

(b) sheaves and other equipment (except governors) shall be permitted to be inspected and serviced from the top of the car or by other means

(b) The floor shall be located above, level with, or directly below the machine beams.

(c) Floors shall be designed to carry a minimum live load of 195 kg/m² (40 lb/ft²).

(d) Floors shall be of concrete, wood, or of metal with or without perforations. Wood planking, when used, shall be scaffold grade or equivalent as recognized by approved grading rules for the species of wood used.

(e) The area to be covered by the floor shall conform to 2.1.3.5.

5.10.1.8 Machinery and Sheave Beams, Supports, and Foundations. Beams, supports, and foundations shall conform to 2.9.

NOTE: Temporary structural reinforcement shall be permitted to be used to meet the requirements of 5.10.1.

5.10.1.9 Hoistway Doors and Gates

5.10.1.9.1 Where Required. The full width of each landing opening shall be protected to its full height by doors, gates, transoms, or any combination thereof. The entire entrance assembly shall be capable of withstanding a force of 1 112 N (250 lbf) applied on the landing side at right angles to and approximately at the center of a panel. This force shall be distributed over an area of 100 mm × 100 mm (4 in. × 4 in.). There shall be no permanent displacement or deformation of any parts of

the entrance assembly resulting from this test. Openwork entrances shall reject a ball 25 mm (1 in.) in diameter. Where permanent doors are provided, they shall conform to 2.11 through 2.13.

5.10.1.9.2 Emergency Doors. Emergency doors shall conform to 2.11.1.2.

5.10.1.9.3 Projection of Hoistway Doors or Gates Into the Hoistway. All projections of hoistway doors or gates into the hoistway shall conform to 2.11.5.

5.10.1.9.4 Hoistway Door Vision Panels

(a) Where permanent hoistway doors are installed, vision panels shall conform to 2.11.7.

(b) Where temporary swinging solid hoistway doors are used, a vision panel covered with material that will reject a ball 25 mm (1 in.) in diameter and have a deflection not greater than any other part of the door shall be provided. The total area of the vision panel shall be not more than 0.016 m² (25 in.²) and it shall be located between 1 370 mm (54 in.) and 1 675 mm (66 in.) above the floor level.

5.10.1.9.5 Openings of Hoistway Doors or Gates From the Landing Side

(a) For elevators with car speeds of up to 1.75 m/s (350 ft/min), hoistway doors or gates shall be provided with means that will latch the doors or gates mechanically so that they cannot be opened from the landing side, conforming to 5.10.1.21.1. Means shall be provided at a designated landing for unlatching the hoistway door or gate from the landing side to permit access to the car. At this landing, positive means shall be provided to lock the elevator entrance out of service.

(b) For elevators with car speeds over 1.75 m/s (350 ft/min), hoistway doors shall be provided with either of the following:

(1) interlocks conforming to 2.12.2

(2) combination mechanical locks and electric contacts conforming to 2.12.3

(c) The mechanical locking device, when used on temporary doors, shall be self-latching.

NOTE [5.10.1.9.5(c)]: When permanent doors are installed, it is recommended that the mechanical locking function of the permanent interlocks be used.

5.10.1.9.6 Closing of Hoistway Doors and Gates.

Temporary hoistway doors and gates shall be considered to be in the closed position when the door or gate is fully closed and latched.

Permanent hoistway doors shall conform to 2.12.1. The electrical circuitry for hoistway door interlocks, or combination mechanical locks and electric contacts, does not have to be operational at this time unless the car speed is over 1.75 m/s (350 ft/min).

5.10.1.9.7 Hangers and Stops for Sliding Hoistway Doors. Hangers conforming to 2.11.11.4 shall be provided.

Where permanent hoistway doors are installed, they shall conform to 2.11, 2.12, and 2.13.

5.10.1.9.8 Weights for Closing and/or Balancing Temporary Hoistway Doors or Gates. Weights used to close or balance hoistway doors or gates should be located outside the hoistway enclosure and shall run in guides or be enclosed. Weights located inside the hoistway enclosure shall conform to 2.11.8. Guides shall be of metal, and the bottom of the guide or enclosure shall be so constructed as to retain the weights if their suspension members fail.

5.10.1.10 Car Enclosure, Car Doors and Gates, and Car Illumination

5.10.1.10.1 Enclosures Required. Except at the entrance, cars shall be fully enclosed with metal or wood on the sides and top. The enclosures shall be solid. The minimum clear height inside the car shall be 1 980 mm (78 in.). Car top enclosures shall be constructed to sustain a load of 135 kg (300 lb) on any 0.09 m² (1 ft²) area.

5.10.1.10.2 Securing Enclosure. The enclosure shall be securely fastened to the car platform and so supported that it cannot loosen or become displaced in regular service, on application of the car safety, or on engagement of the buffer.

5.10.1.10.3 Illumination in the Car. Each car shall be provided with an electric light and a light control switch. The light shall provide illumination of at least 50 lx (5 fc) at the landing edge of the car platform. Light bulbs and tubes shall be suitably protected against accidental breakage.

5.10.1.10.4 Top Emergency Exits. Emergency exits with a cover shall be provided in the top of all elevator cars and shall conform to the following:

(a) The exit opening shall have an area of not less than 0.26 m² (400 in.²), and shall measure not less than 400 mm (16 in.) on any side.

(b) The exit shall be so located as to provide a clear passageway unobstructed by fixed elevator equipment located in or on top of the car.

(c) The exit cover shall open outward and shall be hinged or otherwise attached to the car top and so arranged that the cover can be opened from the top of the car only. The cover when opened shall not protrude beyond the perimeter of the car.

(d) Operation of the car with the top emergency exit open is prohibited, except as specified in 5.10.1.10.4(e).

(e) Operation of the car with the top emergency exit open is permissible only when the load cannot be carried totally within the car enclosure and the operation is under the direct supervision of authorized personnel. The car shall not be operated at a speed of more than 0.75 m/s (50 ft/min).

5.10.1.10.5 Use of Glass. Glass shall not be used in elevator cars, except for the car light and accessories necessary for the operation of the car. Glass used for the car light and accessories shall be laminated and meet the requirements of ANSI Z97.1 or CAN/CGSB-12.1, whichever is applicable (see Part 9), except for transparency.

5.10.1.10.6 Number of Compartments. The number of compartments shall conform to 2.14.1.4.

5.10.1.10.7 Car Emergency Signal. Elevators shall be provided with an audible signaling device, or a permanent or portable means of two-way communication.

5.10.1.10.8 Car Doors or Gates. A car door or gate shall be provided at each entrance to the car. When closed, it shall guard the opening to its full height. Car doors shall be solid or openwork construction that will reject a ball 25 mm (1 in.) in diameter. Collapsible car gates shall be of a design that, when fully closed (extended position), will reject a ball 75 mm (3 in.) in diameter. Each door or gate shall be equipped with a car door or gate electric contact conforming to the requirements of 2.14.4.2. Operation of the car with the car door or gate open is prohibited.

5.10.1.11 Car Frames and Platforms. Car frames and platforms shall conform to 2.15, except for 2.15.8.

5.10.1.12 Rated Load and Speed

5.10.1.12.1 Rated Load. The inside net platform area shall be determined by the temporary rated load and shall conform to 2.16.1.

The maximum number of passengers shall be based on the temporary rated load divided by 90 kg (200 lb).

5.10.1.12.2 Reduction of Inside Net Platform Area. Temporary partitions shall be permitted to be installed for the purpose of restricting the inside net platform area. Such partitions shall be securely fastened to prevent unauthorized removal.

The temporary partitions shall be so installed as to provide for approximately symmetrical loading.

Temporary partitions used within a car enclosure to reduce the inside net platform area shall be permitted to be removed only under the supervision of the elevator contractor to accommodate bulky loads that do not exceed the temporary capacity.

5.10.1.12.3 Speed. The car speed shall not exceed 5 m/s (1,000 ft/min) unless permission to do so is granted by the authority having jurisdiction. Related devices such as governors and buffers shall be calibrated to the car speed.

5.10.1.13 Car and Counterweight Safeties. Car and counterweight safeties shall conform to 2.17.

5.10.1.14 Governors. Governors shall conform to 2.18.

5.10.1.15 Ascending Car Overspeed and Unintended Car Movement Protection. Ascending car overspeed and unintended car movement protection shall be provided on new elevators, and on elevators being altered if required in 8.7, in conformance with 2.19.

5.10.1.16 Suspension Means. Elevator cars shall be suspended by steel wire ropes attached to the car frame or passing around sheaves attached to the car frame as required by 2.15.12, except as specified in 5.10.1.16.1 through 5.10.1.16.8.

Elevator cars arranged for progressive rises with continuous suspension ropes on storage reels shall have steel wire ropes attached to the car frame or the stationary hitch-ends with suitable anchorages on the basis of tensile and fatigue in accordance with manufacturer's specifications and conforming to 5.10.1.16.7.

5.10.1.16.1 Types Permitted. Suspension means shall conform to 2.20.1.

5.10.1.16.2 Minimum Number and Diameter of Suspension Ropes. Ropes shall conform to 2.20.4.

5.10.1.16.3 Factor of Safety. Ropes shall conform to 2.20.3. The factor of safety of the suspension wire ropes shall be based on the requirements for freight elevators.

5.10.1.16.4 Spare Rope Turns on Winding Drums. Ropes shall conform to 2.20.7.

5.10.1.16.5 Splicing and Replacement of Suspension Ropes. Suspension wire ropes shall not be lengthened or repaired by splicing. Damaged ropes in a set shall be permitted to be replaced without replacing the whole set.

5.10.1.16.6 Securing of Suspension Wire Ropes to Winding Drums. Ropes shall conform to 2.20.6.

5.10.1.16.7 Suspension-Rope Fastenings. The car and counterweight ends of suspension wire ropes, or the stationary hitch-ends where multiple roping is used, shall be fastened in such a manner that all portions of the rope, except the portion inside the rope sockets, shall be readily visible. Fastening shall be

(a) by individual tapered babbitted rope sockets (see 2.20.9.4)

(b) by means of clamps and wire-rope thimbles or by special fastening devices. Where clamps are used, the fastening shall conform to the following:

(1) Clamps shall not be of the U-bolt type.

(2) Both members of the clamps shall be provided with seats conforming to the lay of the rope.

5.10.1.16.8 Rope Data Tag. Tags shall conform to 2.20.2.2.

5.10.1.17 Counterweights. Counterweight guiding and construction shall conform to 2.21.

5.10.1.18 Car and Counterweight Buffers. Car and counterweight buffers shall conform to 2.22.

5.10.1.19 Car Guide Rails and Guide-Rail Fastenings. Car guide rails and guide-rail fastenings shall conform to 2.23.

5.10.1.20 Driving Machines and Sheaves

5.10.1.20.1 Driving Machines. All driving machines shall conform to 2.24.1, except that winding-drum machines shall be permitted to be used for passenger elevators subject to the requirements of 2.24.1(a), (b), and (c).

5.10.1.20.2 Material and Grooving for Sheaves and Drums. Permanent sheaves and drums shall conform to 2.24.2. Temporary sheaves and drums shall conform to 5.7.18.2.

5.10.1.20.3 Factor of Safety for Driving Machines and Sheaves. The factor of safety for driving machines and sheaves shall conform to 2.24.3.

5.10.1.20.4 Bolts Transmitting Torque, and Set Screws. Bolts transmitting torque, and set screws shall conform to 2.24.4.

5.10.1.20.5 Friction Gearing or Clutch Mechanism. Friction gearing or clutch mechanism is prohibited.

5.10.1.20.6 Use of Cast Iron in Gears. Worms and worm gears made of cast iron are prohibited.

5.10.1.20.7 Driving-Machine Brakes. Driving-machine brakes shall conform to 2.16.8, 2.24.8, and 2.26.8.

5.10.1.21 Operating Devices and Control Equipment

5.10.1.21.1 Applicable Requirements

(a) Operating devices and control equipment on elevators with a car speed of up to 1.75 m/s (350 ft/min) shall conform to 2.26, except for 2.26.1.6, 2.26.2.14, 2.26.4.4, and 2.26.12 that do not apply. See 5.10.1.21.3 regarding temporary wiring requirements.

(b) Operating devices and control equipment on elevators with a car speed of over 1.75 m/s (350 ft/min) shall also conform to 2.26.2.14, where applicable.

(c) Elevators used for construction shall not be required to conform to 2.26.11.

5.10.1.21.2 Operation and Operating Devices.

Operating devices shall conform to 2.26.1.1. All automatic operation elevators shall conform to 2.14.

5.10.1.21.3 Temporary Wiring. Temporary wiring shall conform to Article 305 of NFPA 70 or Section 76 of CSA-C22.1, Part I, whichever is applicable (see Part 9).

5.10.1.22 Floor Numbers. Hoistways shall have floor numbers, not less than 100 mm (4 in.) in height, on the hoistway side of the enclosure or hoistway doors.

5.10.1.23 Capacity and Data Plates or Signs

5.10.1.23.1 Plates or Signs Required and Locations. Every elevator car shall be provided with a capacity plate or sign and a data plate or sign temporarily fastened in place. The capacity plate or sign shall be located in a conspicuous position inside the car.

The data plate or sign shall be located on the car crosshead, or if there is no crosshead, inside the car.

5.10.1.23.2 Information Required on Plates or Signs

(a) Temporary capacity plates or signs shall indicate the maximum load and the maximum number of passengers allowed in the car during the use of the elevator for construction.

(b) Temporary data plates or signs shall indicate

(1) the approximate temporary weight of the car including the car safety and all auxiliary equipment attached to the car

(2) the temporary rated load and temporary speed

(3) the wire rope data required by 2.20.2.1

(4) the manufacturer's name and date of installation

5.10.1.23.3 Marking of Plates or Signs. Plates or signs shall have letters and figures stamped, cast, etched, stenciled, or painted on the surface in such a manner as to be legible. The height of the letters and figures shall be not less than

(a) 25 mm (1 in.) for capacity plates

(b) 3 mm (0.125 in.) for data plates

5.10.2 Hydraulic Elevators Used for Construction

5.10.2.1 Construction of Hoistways and Hoistway Enclosures. Hoistways, hoistway enclosures, and related construction shall conform to 5.10.1.1.

5.10.2.2 Machine Rooms and Machinery Spaces. Machine rooms and machinery spaces shall conform to 5.10.1.7.

5.10.2.3 Protection of Spaces Below Hoistway. Protection of the space below the hoistway shall conform to 3.6.

5.10.2.4 Vertical Clearances and Runby for Cars and Counterweights. Bottom and top clearances and runby for cars and counterweights shall conform to 3.4.

5.10.2.5 Emergency Doors. Emergency doors shall conform to 3.11.1.

5.10.2.6 Mechanical Equipment. Mechanical equipment shall conform to 5.10.1.10, 5.10.1.11, 5.10.1.13 through 5.10.1.15, 5.10.1.17 through 5.10.1.19, and 5.10.1.23.

5.10.2.7 Hydraulic Jack. Hydraulic jacks shall conform to 3.18.

5.10.2.8 Valves, Pressure Piping, and Fittings. Valves, supply piping, and fittings shall conform to 3.19.

5.10.2.9 Counterweight Ropes, Rope Connections, and Sheaves. Counterweight ropes, rope connections, and sheaves shall conform to 3.20.

5.10.2.10 Tanks. Tanks shall conform to 3.24.

5.10.2.11 Terminal Stopping Devices. Terminal stopping devices shall conform to 3.25.

5.10.2.12 Operating Devices and Control Equipment. Operating devices and control equipment shall conform to 5.10.1.21.

SECTION 5.11 WIND TURBINE TOWER ELEVATORS

(13)

Requirement 5.11 applies to elevators permanently installed inside an enclosed wind turbine tower to provide vertical transportation of authorized personnel, their tools, and equipment for the purpose of servicing, maintaining, and inspection of wind turbine equipment.

Such elevators are typically subjected to extreme temperatures, humidity variations, and substantial horizontal motion where, by reason of their limited use and the types of construction of the structures served, full compliance with Part 2 is not practical or necessary.

5.11.1 Construction of Hoistways

5.11.1.1 Full hoistway enclosures are not required.

5.11.1.2 Partial hoistway enclosures shall be required at landing platforms and shall conform to 5.11.11.

5.11.1.3 A floor over the travel path is not required; however, when provided, shall conform to the following.

5.11.1.3.1 Overhead floors shall be capable of sustaining a concentrated load of 1 000 N (225 lb) on any 2 000 mm² (3 in.²) area, and in addition, where it constitutes the floor of the main or secondary level machinery space, it shall be designed for a live load of not less than 6 kPa (125 lb/ft²) in all open areas.

5.11.1.3.2 Floors shall be of metal construction and if perforated, the openings shall reject a ball 25 mm (1 in.) in diameter or be provided with a guard surrounding the perforation a minimum of 50 mm (2 in.) in height.

5.11.2 Pits

5.11.2.1 Pits shall not be provided.

5.11.3 Location and Enclosing of Counterweights

5.11.3.1 Counterweights, where provided, shall have their runways fully enclosed. When provided, counterweights shall run in separate guides.

5.11.3.2 Access to Enclosed Counterweights and Ropes. Access shall be provided for inspection, maintenance, and repair of an enclosed counterweight and its ropes. Doors or gates in the counterweight enclosures shall be self-closing and shall be provided with

(a) an electric contact, the opening of which will remove power from the elevator driving-machine motor and brake

(b) a self-locking keyed tumbler lock

5.11.4 Vertical Clearances for Cars and Counterweights

5.11.4.1 Top Car Clearance. Where access to the car top is required for maintenance or inspection and when the car has reached its maximum upward movement, the clearance above the car top, measured vertically up to the horizontal plane described by the lowest part of the overhead structure or other obstruction and measured within the projection of the car enclosure top exclusive of the area outside the standard railing (see 5.11.10.2), where provided, shall be not less than 1 100 mm (43 in.). In no case shall the following additional clearances be less than:

(a) 600 mm (24 in.) above the car crosshead assembly except when the crosshead is located over the car enclosure top or the distance which any sheave assembly mounted in or on the crosshead projects above the top of the car crosshead, whichever is greater, but in no case shall there be less than 150 mm (6 in.) clearance above the sheave assembly.

(b) 300 mm (12 in.) above the car crosshead assembly where the crosshead is adjacent to the car enclosure top. The crosshead shall not overlap the car enclosure top by more than 100 mm (4 in.) horizontally.

(c) 600 mm (24 in.) above equipment attached to and projecting above the car enclosure top, exclusive of

(1) standard railings

(2) areas outside of the standard railing, the vertical clearance shall be not less than 100 mm (4 in.)

(3) roller and sliding guide assemblies.

Where access to the car top is required for maintenance and inspection of equipment, a railing conforming to 5.11.10.2 within 50 mm (2 in.) of the perimeter of the car enclosure top shall be provided. When the car has reached its maximum upward movement, there shall be a clearance of not less than 100 mm (4 in.) from the highest projection of the car top railing to the nearest part of the overhead structure.

5.11.4.2 Where access to the car top is not required for maintenance or inspection

(a) equipment mounted on the car top shall not strike any part of the overhead structure or the equipment located in the travel path when the car has reached its maximum upward movement, and

(b) a sign shall be provided with the words "DANGER LOW CLEARANCE" prominently posted

on the car top equipment. The sign shall conform to ANSI Z535.2 or CAN/CSA-Z321, whichever is applicable (see Part 9). The sign shall be of such material and construction that the letters and figures stamped, etched, cast, or otherwise applied to the face shall remain permanently legible.

5.11.4.3 Top counterweight clearance, where counterweights are provided, shall not be less than 600 mm (24 in.).

5.11.5 Horizontal Car and Counterweight Clearances

Clearances shall conform to 5.11.5.1 through 5.11.5.4.

5.11.5.1 Between Car and Landing Platforms. The clearance between the car and the landing platform shall be greater than or equal to 25 mm (1 in.) on the sides used for loading and unloading (see Nonmandatory Appendix W).

5.11.5.2 Between Car and Any Stationary Object. There shall be a minimum of 25 mm (1 in.) clearance between the car structure and any stationary objects. Clearances are permitted to be maintained by rollers or similar devices mounted on the car. Clearance shall be measured from the car structure.

5.11.5.3 Between Car and Counterweight and Counterweight Guard. The clearance between the car and the counterweight shall be not less than 40 mm (1.5 in.) at all times and under all operating conditions. The clearance between the car and the counterweight guard, counterweight and the counterweight guard, and between the counterweight and the hoistway enclosure shall be not less than 20 mm (0.8 in.).

5.11.5.4 Measurement of Clearances. The clearances shall be measured with no load on the car platform.

5.11.6 Protection of Spaces Below the Travel Path

Where the travel path does not extend to the lowest floor of the structure and there is space below the travel path that is accessible, the floor shall be capable of

(a) sustaining a concentrated load of 1 kN (225 lb) on any 2 000 mm² (3 in.²) area, and

(b) a live load of not less than 6 kPa (125 lb/ft²) in all open areas.

5.11.7 Machinery Spaces, Machine Rooms, Control Spaces, and Control Rooms

Elevator machine rooms and control rooms are not permitted in wind turbine towers.

5.11.7.1 Elevator equipment shall be located in machinery spaces and control spaces on the car or outside the travel path and shall conform to the following.

5.11.7.2 The motor controller shall be

(a) located in a machinery space and control space, in an enclosure with a door(s) or panel(s) that is (are) not self-closing and that shall be kept closed

(b) readily accessible for maintenance and inspection at all times

(c) lit by permanently installed electric lighting with a lighting intensity of at least 200 lx (19 fc) at the cabinet when power is applied to the motor controller or temporary lighting with a lighting intensity of at least 200 lx (19 fc) at the cabinet when power is removed from the motor controller

5.11.7.3 All equipment shall be designed for the ambient air temperature and humidity range specified by the wind turbine manufacturer. The temperature and humidity range shall be permanently posted on the cabinet. The height of the letters and figures shall be not less than 3 mm (0.125 in.).

5.11.8 Equipment in the Travel Path, Machinery Space, and Control Spaces

5.11.8.1 Electrical Equipment and Wiring. Installation of electrical equipment and wiring shall conform to NFPA 70 or CSA C22.1, whichever is applicable (see Part 9). Turbine electrical generation equipment is permitted in spaces outside the travel path provided the non-elevator equipment does not interfere with the operation of the elevator equipment.

5.11.9 Machinery and Sheave Beams, Supports, and Foundations

Overhead machinery beams and supports shall conform to 5.11.9.1 through 5.11.9.4.

5.11.9.1 Securing of Machinery Beams and Type of Supports

5.11.9.1.1 All machinery and sheaves shall be so supported and secured as to effectively prevent any part becoming loose or displaced.

5.11.9.1.2 Overhead beams directly supporting machinery shall be of steel.

5.11.9.1.3 Machinery or equipment shall be secured to and supported on, or from the top of, overhead beams, except for the following equipment:

(a) secondary or deflecting sheaves of traction elevators

(b) devices and their accessories for limiting or retarding car speed

(c) driving machines on the car

5.11.9.1.4 Cast iron in tension shall not be used for supporting members for sheaves where they are hung beneath beams.

5.11.9.2 Loads on Overhead Beams and Supports. Overhead beams, floors, and their supports shall be

designed for not less than the load imposed by the guide ropes of rope-guided systems plus twice the sum of the following loads:

(a) the load secured to or supported by the beams and supports, that shall include the complete weight of the machine, sheaves, controller, governor, and any other equipment, together with that portion, if any, of the machinery space or control space supported thereon; and

(b) the sum of the tensions in all suspension members supported by the beams and their supports with rated load in the car

NOTE (5.11.9.2): The object in doubling the suspended load is to allow for impact, accelerating stresses, etc.

5.11.9.3 Factor of Safety of Overhead Beams and Supports. The factor of safety for overhead beams and their supports shall be not less than 5 for steel.

5.11.9.4 Allowable Stresses and Deflections for Machinery and Sheave Beams, Their Supports, and Any Support Members That Transmit Load to the Turbine Tower Walls

5.11.9.4.1 The unit stresses for all machinery and sheave beams and their supports, based on the loads computed as specified in 5.11.9.2, tensions shall not exceed 80% of those permitted for static loads by AISC Book No. S326 or CAN/CSA-S16.1, whichever is applicable (see Part 9).

5.11.9.4.2 The allowable deflections of machinery and sheave beams, their immediate supports, and any support members loaded in bending that transmit load to guide rails or turbine tower walls under static load shall not exceed $\frac{1}{1666}$ of the span.

5.11.10 Guarding of Equipment and Standard Railing

5.11.10.1 Guarding of Equipment. In machinery and control spaces, the following shall be guarded to protect against accidental contact:

(a) exposed sheaves and pinch points

(b) exposed gears, sprockets, and chains

(c) exposed keys, keyways, and screws in projecting shafts

5.11.10.2 Standard Railing. A standard railing shall be substantially constructed of metal and shall consist of a top rail, intermediate rail or equivalent structural member or solid panel, and toe-board.

5.11.10.2.1 The top rail shall have a smooth surface, and the upper surface shall be located at a vertical height of 1 070 mm (42 in.) from the working surface.

5.11.10.2.2 The intermediate rail or equivalent structural member or solid panel shall be located approximately centered between the top rail and the working surface.

5.11.10.2.3 The toe-board shall be securely fastened and have a height not less than 100 mm (4 in.) above the working surface.

5.11.10.2.4 A standard railing shall be capable of resisting anywhere along its length the following forces when applied separately, without deflecting more than 75 mm (3 in.) and without permanent deformation:

(a) a force of at least 890 N (200 lbf) applied in any lateral or downward vertical direction, at any point along the top rail.

(b) a force of at least 666 N (150 lbf) applied in any lateral or downward vertical direction at any point along the center of the intermediate rail, member, or panel. If the standard railing is a solid panel extending from the top rail to the toe-board, the application of the force specified in 5.11.10.2.4(a) shall be considered to meet the requirements of 5.11.10.2.4(b).

(c) a force of 225 N (50 lbf) applied in a lateral direction to the toe-board.

5.11.10.3 A standard railing protecting the openings in landing platforms shall be provided and conform to 5.11.11.5.

5.11.11 Protection of Landing Platform Openings

Protection of landing openings shall conform to 5.11.11.1 through 5.11.11.7.

5.11.11.1 A landing platform door or gate shall be permanently installed and shall be one of the following types:

- (a) horizontally sliding
- (b) horizontally swinging
- (c) combination horizontally sliding and swinging

5.11.11.2 Landing platform doors and gates shall be openable with not more than 50 N (11 lbf) and be self-closing or provided with a means to assure the door is closed when the car is not at a landing.

5.11.11.3 The horizontal distance between the travel path side of the door or gate and the edge of the landing platform shall be less than or equal to 65 mm (2.5 in.) (see Nonmandatory Appendix W).

5.11.11.4 The landing platform shall be so lighted that the illumination, when the elevator is in service, shall be not less than 27 lx (2.5 fc) at the standing surface.

5.11.11.5 Landing Platform Enclosures. Where the travel path is adjacent to areas accessible by authorized or elevator personnel, the landing platform enclosure shall conform to 5.11.11.5.1 through 5.11.11.5.5.

5.11.11.5.1 It shall be enclosed to a height of not less than 1 070 mm (42 in.) above the floor or stair treads with a standard railing (see 5.11.10.2).

5.11.11.5.2 It shall be at the bottom landing and have a solid or openwork enclosure that rejects a ball 25 mm (1 in.) in diameter.

5.11.11.5.3 It shall be of sufficient strength to prevent contact between the enclosure and the car or counterweight when the enclosure is subjected to a force of

(a) 890 N (200 lbf) applied within 50 mm (2 in.) of the top edge, and

(b) 1 112 N (250 lbf) applied at right angles at any point over an area of 100 mm × 100 mm (4 in. × 4 in.)

5.11.11.5.4 It shall have a horizontal clearance of no less than 90 mm (3.5 in.) and no more than 150 mm (6 in.) between loading side of the car and inside of landing platform enclosure (see Nonmandatory Appendix W).

5.11.11.5.5 It shall be provided with a means of entrance to the car complying with 5.11.11.2, and at the bottom landing the door or gate shall also be self-latching or provided with a means to assure the door is closed and latched when the car is not at a landing.

5.11.11.6 Landing platform horizontally sliding doors and gates shall have means provided to prevent the hangers from jumping the track and stops provided in the assembly to prevent hangers from overrunning the end of the track.

5.11.11.7 The hoistway face or hardware of the landing platform doors or gates shall not project into the travel path beyond the edge of the landing platform.

5.11.12 Landing Platform Door Locking Devices and Electric Contacts

5.11.12.1 Landing platform door mechanical lock and electric contacts are not required except where automatic call operation is provided.

5.11.12.2 Where required by 5.11.26.1.2(c), landing platform door mechanical lock and electric contacts shall be provided and conform to 5.11.12.3.

5.11.12.3 General Design Requirements. Combination mechanical locks and electric contacts shall conform to 5.11.12.3.1 through 5.11.12.3.5.

5.11.12.3.1 They shall be so designed that the locking member and the electric contact are mounted on and attached to a common base, in such a manner that there is a fixed relation between the location of the contact and the location of the locking member.

They shall be so installed and adjusted that the electric contact cannot close until the door is in the closed position and so that the locking member is in a position to lock the door when or before the contact closes. In order to prevent motion of the door from opening the electric contact while the door is locked in the closed position, multiple-locking points shall, where necessary, be provided on the locking mechanism.

5.11.12.3.2 The electric contact shall be positively opened by the locking bar of the mechanical lock or by a lever or other device attached to and operated by the door, and the electric contact shall be maintained in the open position by the action of gravity or by a restrained compression spring, or both, or by positive mechanical means.

5.11.12.3.3 The mechanical lock shall hold the door in the locked position by means of gravity or by a restrained compression spring, or both.

5.11.12.3.4 Mercury tube switches shall not be used.

5.11.12.3.5 Listing/Certification Door Locking Devices and Door or Gate Electric Contacts

5.11.12.3.5.1 Type Tests. Each type and make of landing platform door combination mechanical lock and electric contact shall conform to the type tests specified in 8.3.3. The tests shall be done by or under the supervision of a certifying organization.

5.11.12.3.5.2 Listing/Certification. Each type and make of landing platform door combination mechanical lock and electric contact shall conform to the general requirements for tests and certification specified in 8.3.1.

5.11.12.3.5.3 Identification Marking. Each listed/certified device shall be labeled. It shall be permanently attached to the device, and shall be so located as to be readily visible when the device is installed in its operating position.

The labels shall include the following data:

(a) the name, trademark, or certifying organization file number by which the organization that manufactured the product can be identified

(b) the certifying organization name or identifying symbol

(c) statement of compliance with ASME A17.1 or CSA B44

(d) a distinctive type, model, or style letter or number

(e) rated voltage and current, and whether AC or DC

(f) rated test force and rated test movement when the device is of a type released by an actuating device mounted on the car when tested per 8.3.3.4.7, except the term "retiring cam" shall be replaced with the words "actuating device mounted on the car"

(g) date (month and year) devices subjected to type test specified in 5.11.12.3.5.1

(h) if the device has only been type tested and listed/certified for use on a wind turbine tower elevator, the label shall indicate the restricted use

5.11.13 Power Operation of Landing Platform Doors and Car Doors or Gates

Power operation of landing platform doors and car doors or gates is prohibited.

5.11.14 Car Enclosures, Car Doors and Gates, and Car Illumination

5.11.14.1 Cars shall be enclosed with metal at the sides and top. The enclosure walls shall be designed to reject a 25 mm (1 in.) ball up to a height of 2 135 mm (84 in.).

5.11.14.2 The minimum clear height inside the car shall be no less than 2 000 mm (78 in.). The clear height shall be permitted to be reduced to 1 930 mm (76 in.) provided all projections below 2 000 mm (78 in.) are marked with yellow and black diagonal stripes of not less than 25 mm (1 in.) in width.

5.11.14.3 Vision panels are permitted in the enclosure walls provided they are located 1 000 mm (39 in.) above the floor.

5.11.14.4 Where enclosures include panels of glass, or transparent or translucent plastic, the panels shall

(a) be constructed of laminated glass that complies with the requirements of 16 CFR Part 1201, Sections 1201.1 and 1201.2; or be constructed of laminated glass, safety glass, or safety plastic that comply with CAN/CGSB-12.1, CAN/CGSB-12.11, or CAN/CGSB-12.12, whichever is applicable (see Part 9)

(b) be mounted in the structure so that the assembly shall withstand the required elevator tests without damage

(c) have markings as specified in the applicable glazing standard, shall be on each separate piece, and shall remain visible after installation

5.11.14.5 The car enclosure top shall be so designed and installed as to be capable of sustaining a load of 135 kg (300 lb) on any area 600 mm × 600 mm (24 in. × 24 in.), or 45 kg (100 lb) applied to any point, without permanent deformation. The resulting deflection under these loads shall be limited to prevent damage to any equipment, devices, or lighting assemblies fastened to or adjacent to the car enclosure top.

5.11.14.6 Where the car top is intended to be used for operation of the car for maintenance or inspection, it shall be provided with a car top standard railing conforming to 5.11.10.2.

5.11.14.7 Illumination in the car shall be provided from a permanent light source inside or outside the car. The light source shall provide illumination of at least 27 lx (2.5 fc) at the floor of the car platform with car door or gate in the closed position.

5.11.14.8 Emergency Lighting. Illumination in the car shall be provided from an emergency light source in the car or from outside the car. The light source shall provide a minimum level of illumination of 2 lx (0.2 fc), measured at any point between 1 225 mm (48 in.) and

890 mm (35 in.) above the car floor and approximately 300 mm (12 in.) centered horizontally in front of a car.

5.11.14.8.1 Emergency lights shall be automatically turned on when normal car lighting power fails.

5.11.14.8.2 The power system shall be capable of maintaining the minimum light intensity specified for a period of at least 30 min.

5.11.14.8.3 Not less than two lamps of approximately equal wattage shall be used.

5.11.14.8.4 Battery-operated units mounted on the car, where provided, shall

(a) conform to CSA C22.2 No. 141 or UL 924

(b) be permanently connected to a car light circuit provided from the elevator controller

5.11.14.9 Means for emergency exit from the car shall be provided and shall conform to 5.11.14.9.1 and either 5.11.14.9.2 or 5.11.14.9.3.

5.11.14.9.1 Rated personnel protective equipment anchorage point(s), appropriate to the number of persons the car is designed to carry, shall be provided for safe emergency exit conforming to 29 CFR OSHA 1910.66 (Appendix C) or CSA-Z259.16.04.

5.11.14.9.2 Emergency exit through the car door or gate is permitted where the distance from the point of emergency exit to the accessible means of evacuation does not exceed 1 100 mm (43 in.).

5.11.14.9.3 Access through the top or bottom of a ladder-guided car is permitted where

(a) the distance from the point of access to the accessible means of evacuation is equal to or less than 1 100 mm (43 in.) and the exit

(b) the opening has an area of not less than 227 000 mm² (352 in.²), and shall not measure less than 380 mm (15 in.) on any side

(c) be so located as to provide a clear passageway, unobstructed by fixed elevator equipment located in, or on top of, the car

(d) the access covers are hinged, or otherwise attached, to the car and open in the upward direction only

(e) the access cover(s) is (are) equipped with a switch or contact that, when opened, removes power from the driving-machine motor and brake

5.11.14.10 Car Doors and Gates. Each car shall be equipped with a car door or gate conforming to the following:

(a) when closed, guard the opening to its full height

(b) be mechanically prevented from unintentional opening

(c) be openable from inside the car and from outside the car at any point in the travel path

(d) be of solid or openwork construction that will reject a ball 25 mm (1 in.) in diameter

(e) when made of materials other than metal, conform to 5.11.14.3 and 5.11.14.4

(f) not be power operated

(g) when subjected to a force of 335 N (75 lbf) applied on an area 300 mm (12 in.) square at right angles to and approximately at the center of the door or gate, doors and gates shall not be permanently deformed or be displaced from their guides or tracks

5.11.14.11 Each car door or gate shall be provided with a door or gate electric contact conforming to the following:

(a) it shall remove power from the driving-machine motor and brake when the car door or gate is not in the closed position

(b) it shall be positively opened by a device attached to and operated by the door or gate

(c) it shall be maintained in the open position by the action of gravity or by a restrained compression spring, or both, or by positive mechanical means

(d) it shall not utilize mercury tube switches

5.11.14.11.1 Each type and make of car door or gate electric contact shall be type tested per 5.11.30. The tests shall be done by or under the supervision of a certifying organization.

5.11.14.11.2 Each listed/certified device shall be labeled. It shall be permanently attached to the device, and shall be so located as to be readily visible when the device is installed in its operating position. The label shall include the following data:

(a) the name, trademark, or certifying organization file number by which the organization that manufactured the product can be identified

(b) the certifying organization name or identifying symbol

(c) a distinctive type, model, or style letter or number

(d) rated voltage and current, and whether AC or DC

5.11.14.12 The clear opening of the car door or gate shall be a minimum of 450 mm (18 in.) wide.

5.11.14.13 Car doors or gates are permitted to be sectioned provided each section partially covering the car enclosure entrance conforms to 5.11.14.1 through 5.11.14.14. The lower door section shall be a minimum of 1 100 mm (43 in.) in height.

5.11.14.14 Natural ventilation openings shall be provided in the car enclosures with a total area of not less than 3.5% of the inside car floor area divided equally between the bottom and top of the car enclosure.

5.11.15 Car Frames and Platforms

Car frames and platforms shall conform to 5.11.15.1 through 5.11.15.11.

5.11.15.1 Car Frames and Platforms. Car frames and car platforms shall be metal.

5.11.15.2 Use of Cast Iron. Cast iron shall not be used in the construction of any member of the car frame or platform other than for guide shoes and guide-shoe brackets.

5.11.15.3 Number of Compartments. The car shall not have more than one compartment.

5.11.15.4 Car frames shall be guided on each side by upper and lower guiding members attached to the frame.

5.11.15.5 Guiding members shall be designed to withstand the forces imposed during normal operation of the elevator, emergency stopping, and the application of safeties.

5.11.15.6 All structural components of the car frames and platforms shall have minimum factor of safety of 5.

5.11.15.7 Failure of any guiding member shall not permit the car and car frame to strike any portion of the tower structure. Obstruction detection devices (see 5.11.15.9) shall be permitted to detect when the car is outside the travel path.

5.11.15.8 The car platform shall be provided with a kickboard a minimum of 25 mm (1 in.) and a maximum of 100 mm (4 in.) in height, located on the side used for loading and unloading and shall be marked in yellow.

5.11.15.9 The top and bottom of the car shall be provided with a means to detect an obstruction in the travel path and stop the car by causing the power to be removed from the driving-machine motor and brake. Each obstruction detection device shall

(a) be provided with a switch actuated by the obstruction detection device whose contacts are positively opened mechanically; their opening shall not be solely dependent on springs.

(b) be designed in such a manner that it cannot be reset until the obstruction detection mechanism has been returned to the unapplied position.

(c) be designed to withstand the forces imposed on it.

(d) have a maximum actuation force of 70 N (15 lbf) and a throw not to exceed 100 mm (4 in.). The switch shall actuate upon movement of the obstruction detection device.

(e) detect a ball greater than 100 mm (4 in.) in diameter within the projected area of the car.

(f) not permit restarting of the elevator when an obstruction device resets, after being actuated.

5.11.15.10 Cars shall be provided with an external visual warning device or an audible warning device (or both) that operates while the car is in motion.

5.11.15.10.1 The illumination of the external visual warning device shall be a minimum of 500 lx (46 fc) measured at a point 2.5 m (8 ft) from the horizontal surfaces of the car with a flash frequency between 50 times to 80 times per minute and be visible above and below the car.

5.11.15.10.2 The audible warning device shall have a minimum sound level of 70 dBA at 1 000 mm (39 in.) in the travel path and below the elevator, with a 50% duty cycle and a frequency between 1 kHz and 4 kHz and be audible above and below the car.

5.11.15.10.3 Means shall be provided to assure operation of the visual or audible warning device during primary power loss for a minimum of 30 min. If a battery is used for this purpose, testing, replacement, and inspection procedures shall be provided in the MCP (see 8.6.1.2).

5.11.15.11 Platforms for ladder-guided systems are permitted to have perforations or be of fabricated openwork construction. Openings shall reject a ball 10 mm ($\frac{3}{8}$ in.) in diameter.

5.11.16 Capacity and Loading

5.11.16.1 Capacity and Data Plates. Every car shall be provided with a capacity plate and a data plate permanently and securely attached. The capacity plate shall be located in a conspicuous position inside the car.

5.11.16.2 Information Required on Plates

5.11.16.2.1 Capacity plates shall be marked in a legible and permanent manner with letters and figures not less than 25 mm (1 in.) in height indicating the rated load of the elevator in kilograms or pounds, or both.

5.11.16.2.2 Data plates shall be marked in a legible and permanent manner with letters and figures not less than 3 mm (0.125 in.) in height indicating

(a) the weight of the complete car, including the driving machine and all auxiliary equipment attached to the car

(b) the rated load and speed

(c) the suspension-means data required

(d) the name or trademark of the manufacturer and year manufactured

(e) guiding means lubrication instructions

5.11.16.3 Limitation of Load, Speed, and Platform Area. The rated load shall not exceed 454 kg (1,000 lb). The inside net platform area shall not exceed 1.2 m² (13 ft²). The minimum rated load shall not be less than that based on 3.4 kPa (70 lbf/ft²) of inside net platform area or 113 kg (250 lb), whichever is greater. The rated speed shall not exceed 0.4 m/s (80 ft/min).

5.11.16.4 Overload Detection Means. A means to detect an overload shall be provided and the overload

value determined by the manufacturer's recommendations. A visual or audible signal device shall be provided so that authorized personnel are notified of an overload condition.

5.11.16.5 Speed-Limiting Device. A means shall be provided to limit the descent speed of the car to less than safety tripping speed when the manual brake release system is operated.

5.11.17 Car and Counterweight Safeties

Each car, and where required by 5.11.6 each counterweight, shall be provided with a safety conforming to 5.11.17.1 or 5.11.17.2 and the applicable requirements of 5.11.17.3 through 5.11.17.5.

5.11.17.1 Wire Rope Gripping Safety. The safety shall be operated, without delay, by the breakage of the suspension means or by the action of an internal centrifugal governor when the car exceeds 200% of rated speed or 0.9 m/s (175 ft/min).

5.11.17.1.1 The safety shall act on an independent safety wire rope upon loss of suspension or overspeed (see 5.11.20.2.8).

5.11.17.1.2 Safeties shall be applied mechanically. Electric, hydraulic, or pneumatic devices shall not be used to apply the safeties or to hold such safeties in the retracted position.

5.11.17.1.3 When car safeties are applied, no motion of the car in the down direction shall release the safeties, but such safeties shall be permitted to be released by the motion of the car in the up direction.

5.11.17.1.4 Safeties shall be so designed that, on their application, the forces that provide the stopping action shall be compressive forces and shall not cause permanent deformation of the safety wire rope upon whose dimensional stability the stopping capability of the safeties is dependent.

5.11.17.1.5 The safety shall be located where it is readily accessible and it cannot be struck by any moving object in normal operation or under conditions of overtravel.

5.11.17.1.6 The minimum factors of safety and stresses of safety parts and rope connections shall not be less than 3.5, and the materials used shall have an elongation of not less than 15% in a length of 50 mm (2 in.) when tested in accordance with ASTM E8. Forged, cast, or welded parts shall be stress relieved.

5.11.17.1.7 Springs are permitted in the operation of car or counterweight safeties. Where used, and where partially loaded prior to safety operation, the loading on the spring shall not produce a fibre stress exceeding one-half the elastic limit of the material. During operation of the safety, the fibre stress shall not

exceed 85% of the elastic limit of the material. Helical springs, where used, shall be in compression.

5.11.17.1.8 The factors of safety shall be based upon the maximum stresses developed in the parts during the operation of the safety when stopping rated load from overspeed.

5.11.17.2 Rack-and-Pinion Safety. Where a single rack-and-pinion drive machine is used, the car shall be provided with one or more safeties conforming to 5.11.17.1 or shall operate on one pair of guide members or on one vertical rack conforming to the following.

5.11.17.2.1 Rack-and-pinion machines have safeties consisting of a freely rotating safety pinion, a governor, and a safety device that shall be permitted to form an integral unit mounted on the car. The freely rotating pinion travels on a stationary rack mounted vertically in the hoistway. The rotating pinion drives the governor. When the downward speed of the car reaches the tripping value, the rotating governor actuates the safety device, which, in turn, brings the car to a gradual stop.

5.11.17.2.2 Where multiple rack-and-pinion driving machines are provided, a safety is not required when

(a) each driving machine is independently able to prevent a car that is loaded to 125% of rated load from descending uncontrolled

(b) each driving machine is capable of moving the car to the bottom floor under manual control

(c) the failure of one driving machine is detected and power is removed from the other driving-machine motor and brake

5.11.17.2.3 The stopping distance of the car measured from the time the safety or alternate means actuates to a full stop shall be a minimum of 25 mm (1 in.) and a maximum of 380 mm (15 in.).

5.11.17.3 Safety Marking Plates. Marking plates shall be metal and be securely attached or adjacent to each safety so as to be readily visible, and shall be marked in a legible and permanent manner with letters and figures not less than 3 mm (0.125 in.) in height indicating

(a) the type of safety, based on 5.11.17

(b) the maximum tripping speed in m/s (ft/min) for which the safety is permitted

(c) the maximum weight in kg (lb), that the safety is designed and installed to stop and sustain

(d) the manufacturer's name or trademark

(e) the year of manufacture, and

(f) the force in N (lbf) required to activate the safety if applicable

5.11.17.4 Opening of Driving-Machine Motor and Brake Control Circuits on Safety Application. Safeties

shall be provided with a switch that opens (actuates) causing the power to be removed from the driving-machine motor and brake at the time the safety actuates and shall be of a type that cannot be reset until the safety mechanism has been returned to the unapplied position and conform to 5.11.26.2.3.

5.11.17.5 Application of Safety. A safety device that depends upon the completion or maintenance of an electric circuit for the application of the safety is not permitted. Safeties shall be applied mechanically.

5.11.18 Reserved for Future Use

5.11.19 Reserved for Future Use

5.11.20 Suspension Means and Their Connections

Suspension means shall conform to ASME A17.6, and 5.11.20.1 through 5.11.20.3, as applicable. Access for suspension-means inspection purposes shall be provided.

5.11.20.1 Suspension Means for Counterweighted Traction Elevators. For counterweighted traction elevators, suspension means shall be galvanized and conform to ASME A17.6 — Part 1, and 5.11.20.1.1 through 5.11.20.1.5 for steel wire rope.

5.11.20.1.1 The minimum diameter of any steel wire rope shall be not less than 9.5 mm (0.375 in.).

5.11.20.1.2 The factor of safety of the steel wire rope shall not be less than 7.95.

5.11.20.1.3 The arc of contact of a steel wire rope on a traction sheave and the shape of the grooves shall be sufficient to produce adequate traction under all load conditions.

5.11.20.1.4 No car or counterweight steel wire rope shall be lengthened or repaired by splicing. If one rope of a set is worn or damaged and requires replacement, the entire set of ropes shall be replaced.

5.11.20.1.5 The car or counterweight ends of steel wire ropes shall be fastened by properly attached fittings as recommended by wire-rope manufacturers.

5.11.20.2 Suspension Means for Uncounterweighted Traction Elevators. For uncounterweighted traction elevators, the suspension members shall be galvanized preformed steel wire rope and conform to ASME A17.6 — Part 1, and 5.11.20.2.1 through 5.11.20.2.13 for steel wire rope.

5.11.20.2.1 The minimum diameter of any suspension steel wire rope shall not be less than 8 mm (0.3125 in.).

5.11.20.2.2 The factor of safety of the suspension means shall be not less than 10.

The factor of safety shall be calculated by the following formula:

$$F = \frac{S \times N}{W}$$

where

N = number of runs of suspension members under load

S = manufacturer's rated breaking force in kN (lbf) of one suspension member

W = maximum static load in kN (lbf) imposed on all suspension members with the car and its rated load at any position in the hoistway

5.11.20.2.3 The arc of contact of a steel wire rope on a traction sheave and the shape of the groove shall be sufficient to produce adequate traction under all load conditions.

5.11.20.2.4 No car suspension rope shall be lengthened or repaired by splicing.

5.11.20.2.5 Suspension steel wire rope terminated at the upper end shall be fastened by properly attached fittings as recommended by wire-rope manufacturers or by swage fittings complying with the following:

(a) Use of swage fittings only on regular lay, synthetic core, or IWRC ropes are permitted.

(b) They are swaged in a shop with a press under controlled conditions to guarantee reliable attachment.

(c) Where rope adjustment is required, they may only be used at one end of the rope.

(d) Swages shall be designed and tested in accordance with the design and testing requirements of EN 13411-3:2004.

(e) The swaging company shall be identified on the swage or on the rope data tag.

(f) Swaging shall not be performed in the field.

(g) The manufacturer shall provide verification means to assure the swage is crimped to manufacturer's specification.

5.11.20.2.6 U-bolt type rope clamps or similar devices shall not be used on the load side of suspension rope or safety wire rope fastenings.

5.11.20.2.7 Fastenings shall develop a minimum of at least 80% of the rope manufacturer's rated breaking force.

5.11.20.2.8 Means shall be provided to prevent the fastenings from having any physical contact resulting in wear of the ropes or its fastening.

5.11.20.2.9 Use of a single suspension steel wire rope is permitted provided a galvanized safety steel wire rope is provided of equivalent size and grade as the suspension steel wire rope (see 5.11.20.2.10).

5.11.20.2.10

(a) Suspension members' replacement criteria shall conform to ASME A17.6. Other manufacturers' recommended criteria shall be included in the Maintenance Control Program (see 8.6.1), with sufficient detail to ensure that inspection criterion is provided.

(b) When the steel wire suspension rope is replaced, the safety steel wire rope shall also be replaced.

(c) A readily visible hour meter shall be provided on all suspended elevator cars and the suspension steel wire ropes shall be replaced after 250 h of operation or after 5 yr, whichever occurs first.

5.11.20.2.11 A safety rope shall be provided and used only in the event of loss of primary suspension or overspeed safety actuation and shall

(a) consist of a steel wire rope upon which a safety device (see 5.11.17.1) actuates to stop the car, and

(b) conform to 5.11.20.2, except 5.11.20.2.3.

5.11.20.2.12 Only steel wire ropes in ASME A17.6 are permitted to be used in wind turbine tower elevators.

5.11.20.2.13 Pertinent data located on the suspension means and safety rope shall be provided by a data tag securely attached to the fastenings or adjacent to the controller. The following data shall be provided:

- (a) type of suspension
- (b) the diameter of the rope in millimeters or inches
- (c) the suspension-means manufacturer's minimum breaking force in kN or lbf
- (d) the grade of material used
- (e) construction classification
- (f) for steel wire rope, non-preformed, if applicable
- (g) for steel wire rope, finish coating, if applicable
- (h) name or trademark of the rope manufacturer
- (i) name of person or organization who installed the ropes
- (j) the month and year the ropes were installed
- (k) lubrication information
- (l) swaging company, if applicable

5.11.20.3 Chains Used for Suspension. Reserved for future use.

5.11.21 Counterweights

Counterweights, where provided, shall conform to the following.

5.11.21.1 Counterweight Guides. Counterweights shall be guided to prevent any horizontal movement that would inhibit proper operation or cause counterweight to move from designated travel path and shall not be of sufficient weight to cause undue slackening of the hoisting ropes during acceleration or retardation of the car.

5.11.21.2 Types of Counterweight Construction

5.11.21.2.1 One-piece solid or laminated steel counterweights shall be permitted to be used.

5.11.21.2.2 Where counterweight sections are used, means shall be provided to retain the sections in place if they become broken, whether carried in a frame or not. If tie rods are used, the sections shall be fastened together by a minimum of two tie rods that pass through all weight sections. Tie rods shall be provided with lock-nuts and cotter pins at each end.

5.11.21.2.3 The frame members and their connections shall be designed with a factor of safety of not less than 5 with the elevator at rest and the counterweight at the top of its travel.

5.11.21.2.4 The counterweight frame shall be designed with a factor of safety of not less than 2.5 at bumper or buffer engagement or safety application if provided.

5.11.22 Buffers and Bumpers

Cars and counterweights shall be provided with bumpers conforming to 5.11.22.1 or spring buffers conforming to 5.11.22.2.

5.11.22.1 Bumpers shall conform to the following:

- (a) they shall be located so as to retard the car and counterweight without exceeding allowable design stresses in the car frame and counterweight frame; and
- (b) they shall be made of wood or other suitably resilient material of sufficient strength to withstand without failure the impact of the car with rated load, or the counterweight, descending at overspeed where provided
- (c) the material used shall be of a type that will resist deterioration or be so treated as to resist deterioration.

5.11.22.2 Spring buffers shall conform to the following:

- (a) the stroke of the buffer spring shall be equal to or greater than 38 mm (1.5 in.)
- (b) the buffer shall be capable of supporting, without being compressed solid or to a fixed stop, a static load having a minimum of two times the total weight of the car and its rated load for car buffers and the total weight of the counterweight for counterweight buffers
- (c) the buffer shall be compressed solid or to a fixed stop with a static load of three times the weight of the car and its rated load for car buffers and the counterweight for total weight of the counterweight buffers
- (d) the buffer shall be provided with a marking plate showing its load rating and stroke; markings shall be made in a permanent and legible manner

5.11.23 Car and Counterweight Guidance Systems, Supports, and Fastenings

Means shall be provided to assure hazards due to relative movement between the tower ladder and elevator are provided. Guiding systems shall consist of one of the following:

- (a) wire-rope-guided conforming to 5.11.23.1
- (b) ladder-guided conforming to 5.11.23.2

5.11.23.1 Wire Rope Guidance System for Uncounterweighted Traction Drive Machines

5.11.23.1.1 Guide ropes shall be galvanized steel wire rope conforming to ASME A17.6.

5.11.23.1.2 Guide ropes shall be tensioned with an applied load to maintain a minimum horizontal clearance of 25 mm (1 in.) from the cab enclosure to other structures in the tower at all times. A means shall be provided to indicate the minimum and maximum allowable tension in the guide ropes.

5.11.23.1.3 Guide ropes shall have a minimum factor of safety of 8.

5.11.23.1.4 Guide ropes shall be a minimum of 8 mm (0.3125 in.) in diameter.

5.11.23.1.5 Guide rope fixes shall

- (a) have a spacing no greater than 30 m (98 ft) apart
- (b) be attached at each landing platform
- (c) be capable of resisting the forces imposed without permanent deformation
- (d) maintain alignment of the wire guide rope throughout the life cycle of the elevator
- (e) allow for axial movement

5.11.23.1.6 Fastenings and Connections

(a) Upper terminal guide rope fastenings shall conform to 5.11.20.2.5.

(b) Lower terminal guide rope fastenings shall

- (1) be provided with a fixed termination that retains the applied load with a factor of safety of 3
- (2) have a means to retension the rope
- (3) be permanently anchored

5.11.23.1.7 Wire guide rope systems shall be designed to be permanently installed and extend beyond the travel path of the car such that no equipment on the car shall strike wire guide systems terminal fastenings.

5.11.23.1.8 A minimum of two guide ropes shall be provided.

5.11.23.1.9 Guide ropes shall be replaced according to the replacement criteria of ASME A17.6 and replacement ropes shall be new steel wire rope of the same type and grade.

5.11.23.1.10 Reuse of guide ropes as suspension or safety ropes is prohibited.

5.11.23.1.11 Guide ropes shall be positioned to prevent uncontrolled rotation of the car.

5.11.23.2 Ladder Guidance Systems. Ladder guidance systems shall conform to 5.11.23.2.1 through 5.11.23.2.8.

5.11.23.2.1 Ladder guided systems shall be of steel or aluminum. Steel shall have an elongation not less than 20% in a length of 50 mm (2 in.) and aluminum shall have an elongation not less than 12% in a length of 50 mm (2 in.).

5.11.23.2.2 Ladder guided systems and their brackets, rail clips, fishplates, and their fastenings to the support structure shall provide a minimum factor of safety of 4 for steel and 5 for all other metals for all applicable loads.

5.11.23.2.3 Guide surfaces shall be securely fastened to the ladder, and the ladder guides shall not exceed a design deflection of $L/160$ of span and the combined deflection shall not deflect more than 12 mm (0.5 in.) under normal operation, and shall have their joints well-fitted and strongly secured. Guide surfaces and their joints and fastenings shall withstand without failure the application of the car safety when stopping the car with its rated load.

5.11.23.2.4 Guide surfaces shall extend from the bottom of the travel path to a sufficient height above the top landing to prevent the guide shoes from running off the guide surfaces when the car is at its extreme upper position.

5.11.23.2.5 A means of visually monitoring the travel path of the car shall be provided from the point of manual lowering actuation means.

5.11.23.2.6 Emergency evacuation shall be provided through top and bottom hatches except when the elevator is guided on the nonclimbing side of the ladder and when the door opening is perpendicular to the ladder rungs.

5.11.23.2.7 The car shall maintain 175 mm (7 in.) clearance from the ladder rung.

5.11.23.2.8 A sign with letters 25 mm (1 in.) in height complying with ANSI Z535.2 or CAN/CSA-Z321 shall be posted at each ladder access point saying

CAUTION: Elevator is guided on this ladder; beware of moving equipment.

5.11.24 Driving Machines, Sheaves, and Brakes

Driving machines shall be of the traction, traction climbing, rack-and-pinion, or chain climbing drive type and shall conform to 5.11.24.1, 5.11.24.2, or 5.11.24.3 and the applicable requirements of 5.11.24.4 through 5.11.24.9. The installation of belt-drive, winding drum, and screw drive machines are prohibited.

5.11.24.1 Rack-and-Pinion Driving Machines. Rack-and-pinion machines shall conform to 5.11.24.1.1 through 5.11.24.1.9.

5.11.24.1.1 The rack-and-pinion drive shall consist of one or more power-driven rotating pinions mounted on the car and arranged to travel on a stationary rack mounted on the supporting structure. The drive shall have at least one pinion, one rack, and two backup rollers, which shall act on the same section of rack as the drive pinion. Driving machines utilizing a two-sided rack, where two drive pinions are located so that they are opposite each other and act as backup rollers, shall be deemed to have met this requirement.

5.11.24.1.2 The pinions and racks shall be of steel or of material having equivalent mechanical properties or better with a minimum factor of safety of 8 for the pinion and the rack. They shall be designed to conform to AGMA 218.01, including surface hardening and an assumption of a minimum of 200 000 life cycles.

5.11.24.1.3 All moving parts of the driving machine shall be properly protected with solid or perforated metal that will reject a ball of 13 mm (0.5 in.) diameter and shall be securely fastened.

5.11.24.1.4 The rack and pinion shall be so designed that the separation of the pinion from the rack in all directions in excess of 25% of the tooth depth or 6 mm (0.25 in.), whichever is the lesser, cannot occur. A guard shall be provided to prevent foreign material from lodging between the teeth, and clearance between the moving parts and the guard shall not exceed 5 mm (0.1875 in.).

5.11.24.1.5 Rack sections shall be fastened to the supporting structure with a factor of safety of 5 with dowels at each joint.

5.11.24.1.6 The manufacturer shall provide the measurement for checking tooth wear on pinion and rack. The measuring instruction shall be indicated on a metal plate securely fastened and conspicuously displayed on top of the car with letters not less than 3 mm (0.125 in.) high.

5.11.24.1.7 Each drive unit shall be provided with a driving-machine brake capable of safely stopping and maintaining the weight of the car plus 125% of rated load.

5.11.24.1.8 Each drive unit shall be provided with a centrifugal brake capable of safely lowering the weight of the car plus 125% of rated load.

5.11.24.1.9 Where a multiple drive system is provided, means shall be provided to detect failure of a drive unit and remove power from all motors and brakes.

5.11.24.2 Traction Driving Machines, Sheave and Brakes. Traction machines shall conform to 5.11.24.2.1 through 5.11.24.2.11.

5.11.24.2.1 Driving-machine sheaves shall be integral with or directly attached to driving-machine shafts. Traction sheaves shall be constructed of metal and provided with finished grooves, steel shafts, and metal bearings. Overhead or deflecting sheaves are permitted to be nonmetallic with steel shafts and metal bearings.

5.11.24.2.2 Traction sheaves used with suspension means shall have a pitch diameter of not less than

(a) 20 times the diameter of steel wire rope where used for suspension ropes

(b) 10 times the diameter of steel wire rope where the sheave is an overhead or deflecting sheave when on the unloaded side (trailing) of the suspension rope for uncounterweighted systems

5.11.24.2.3 Where steel wire rope is used and a groove is used to provide traction, sufficient traction shall be provided between the rope and groove to safely stop and hold the car with rated load from rated speed in the down direction.

5.11.24.2.4 In a counterweighted system, if either the car or the counterweight bottoms on its buffers or bumpers, or becomes otherwise immovable

(a) the suspension members shall slip on the drive sheave and not allow the car or counterweight to be raised, or

(b) the driving system shall stall and not allow the car or counterweight to be raised

5.11.24.2.5 A means shall be provided to retain each suspension member in its respective position on all sheaves used in the suspension of the elevator when subjected to any retardation that can cause a slackening of the suspension members.

5.11.24.2.6 Driving-machine components subjected to alternating or reversing stresses shall have a factor of safety of not less than 1.5. This factor of safety shall be the ratio of the endurance limit of the components to the actual alternating or reversing stress to which the components can be subjected under any normal operating condition. The endurance limit shall be based on 107 cycles of stress reversals. The actual stress shall include all designed or anticipated load conditions and stress risers, such as sharp corners, shock loading, surface finish, keyways, material variations, alignment tolerances, etc.

5.11.24.2.7 A fillet shall be provided at any point of change in the diameter of driving-machine shafts and sheave shafts to prevent excessive stress concentrations

in the shafts. Shafts that support sheaves, gears, couplings, and other members, and that transmit torque, shall be provided with tight-fitting keys.

5.11.24.3 Chain Climbing Machines. Reserved for future use.

5.11.24.4 Material and Grooving for Sheaves. Traction sheaves for uncounterweighted traction machines shall be of cast iron or steel and of a pitch diameter not less than 20 times the diameter of the steel wire suspension ropes. The rope grooves shall be machined. Overhead and deflecting sheaves are permitted to be nonmetallic with steel shafts and metal bearings.

5.11.24.4.1 The pitch diameter of not less than 10 times the rope diameter is permitted on the unloaded side (trailing) of the suspension rope for uncounterweighted traction systems.

5.11.24.5 Factor of Safety for Driving Machines and Sheaves. The factor of safety to be used in the design of driving machines and sheaves used with suspension means shall be not less than

(a) 8 for metals having an elongation of at least 14% in a gauge length of 50 mm (2 in.) when tested in accordance with ASTM E8.

(b) 10 for cast iron, or for metals having an elongation of less than 14% in a gauge length of 50 mm (2 in.) when tested in accordance with ASTM E8.

(c) 10 for sheaves of plastic, fiber-reinforced plastic, or combinations thereof. The material used shall ensure that the factor of safety is not less than 8 during the service life of the sheave.

The load to be used in determining the factor of safety shall be the resultant of the maximum tensions in the suspension means leading from the sheave with the car at rest and with the rated load in the car.

5.11.24.6 Bolts Transmitting Torque, and Set Screws. The threaded portions of bolts transmitting torque and set screws located in the shear plane of bolts and screws shall not be used to transmit load. Means shall be provided to ensure that there is no relative motion between rigidly joined components transmitting load.

The factors of safety to be used in the design of fasteners transmitting load in driving machines and sheaves shall be not less than those specified in 5.11.24.5.

5.11.24.7 Friction-Gearing or Clutch Mechanism. Friction-gearing or clutch mechanisms shall not be used for connecting the drum or sheaves to the main driving mechanism.

5.11.24.8 Use of Cast Iron in Gears. Worms and worm gears made of cast iron shall not be used.

5.11.24.9 Braking System of Driving Machines. All elevators shall be provided with a braking system.

5.11.24.9.1 The elevator braking system shall be capable of decelerating the car from its rated speed when it is carrying its rated load in the down direction. The loss of main line power shall not reduce the braking system capacity.

5.11.24.9.2 The driving-machine brake shall be a friction brake applied by a spring or springs, or by gravity, and released electromechanically. The driving-machine brake, on its own, shall be capable of holding the car at rest with its rated load plus 125% overload.

5.11.24.9.3 The driving-machine brake design shall ensure contact of the friction material on the braking surface consistent with good engineering practice. Means shall be provided to protect the braking surfaces from any leaking fluid.

5.11.24.9.4 The brake setting and method of measurement shall be permanently and legibly marked on the driving machine or on the car data tag.

5.11.24.9.5 The driving-machine brake design shall ensure contact of the friction material on the braking surface consistent with good engineering practice. Means shall be provided to protect the braking surfaces from contamination caused by any fluid leak.

5.11.24.9.6 Two means shall be provided to independently remove power from the brake.

5.11.24.9.7 The driving-machine brake shall apply automatically when

(a) the emergency stop switch in the car is in the stop position

(b) a normal stopping means functions

(c) any electrical protective device is activated, or

(d) there is a loss of power to the driving-machine brake

5.11.24.9.8 The brake shall not be permanently connected across the armature or field of a direct-current elevator driving-machine motor.

5.11.24.10 Means for Manual Release of Driving-Machine Brake. Means for manual release of the driving-machine brake shall be provided. The means shall permit car movement in a gradual, controllable manner. Provision shall be made to prevent unintended actuation of the device. The manual release device shall be designed to be hand applied only with continuous effort. The brake shall reapply at its fully adjusted capacity in the absence of the hand applied effort.

5.11.25 Terminal Stopping Devices

5.11.25.1 Final terminal stopping devices shall conform to the following except no down final switch is required for systems with driving machines that do not maintain driving force in the down direction as a result of driving machine remaining powered when

landed at the bottom landing. Final terminal stopping devices shall

- (a) be mechanically operated
- (b) have operating cams of metal
- (c) have switch contacts directly opened mechanically

5.11.25.1.1 Final terminal stopping devices shall be provided and arranged to cause the electric power to be removed automatically from the elevator driving-machine motor and brake after the car has passed a terminal landing. The device shall be set to function as close to the terminal landing as practicable, but so that under normal operating conditions it will not function when the car is stopped by the normal terminal stopping device.

The operation of final terminal stopping devices shall prevent movement of the car by the normal operating devices in both directions of travel.

5.11.25.1.2 Elevators shall have final terminal stopping switches operated by cams and shall be operated by the movement of the car. One of the assemblies (i.e., switch or cam or actuation device) shall be mounted on the car and the other in the travel path. Where the final terminal stopping switch signals are transmitted through wiring in the traveling cable, the design shall be such that any single ground or short circuit shall not render the final terminal stopping device ineffective.

5.11.25.1.3 The normal terminal stopping device and final terminal stopping devices shall not control the same controller devices unless two or more separate and independent controller devices are provided, two of which shall complete both the driving-machine motor and the driving-machine brake circuits in either direction of travel.

The control circuits shall be so designed and installed that a single ground or short circuit shall not prevent both the normal terminal stopping device and final terminal stopping device control circuits from stopping the car.

5.11.25.2 Normal terminal stopping devices conforming to the following shall be provided. Obstruction detection devices (see 5.11.15.9) shall be permitted to function as the normal terminal stopping device.

5.11.25.2.1 Normal terminal stopping devices shall be provided and arranged to slow down and stop the car automatically, at or near the top and bottom terminal landings, with any load up to and including rated load in the car and from any speed attained in normal operation.

5.11.25.2.2 Such devices shall function independently of the operation of the normal stopping means and of the final terminal stopping device, except that the normal terminal stopping device shall be permitted to be used as the normal stopping means.

5.11.25.2.3 The device shall be so designed and installed that it will continue to function until the final terminal stopping device operates.

5.11.25.2.4 Normal terminal stopping devices shall be operated by cams and shall be operated by the movement of the car. One of the assemblies (i.e., switch or cam) shall be mounted on the car and the other in the travel path.

5.11.25.3 Uncounterweighted traction drive elevators shall be provided with a slack rope switch to detect movement of the tail line weight or a slack rope condition and cause power to be removed from the driving machine and brake in the down direction.

5.11.25.3.1 The switches shall have contacts that are positively opened mechanically, their opening shall not be solely dependent on springs, and be designed to actuate with a maximum of 100 mm (4 in.) of vertical rope movement.

5.11.26 Operating Devices and Control Equipment

5.11.26.1 Operation and Operating Devices

5.11.26.1.1 Types of Operating Devices. All operating devices shall be of the enclosed electric type.

5.11.26.1.2 Types of Operation. Only the following types of operations shall be permitted: AUTOMATIC CALL, AUTOMATIC SEND, and MANUAL.

(a) Where the Operation Selection Switch is in the MANUAL position or where no Operation Selection Switch is provided, continuous pressure operation is enabled. Operating devices shall be of the continuous pressure type and attached to the car.

(b) Where the Operation Selection Switch is in the AUTOMATIC position and when operating devices are attached to the car, automatic send operation is enabled. Operating devices shall be of the momentary pressure type.

(c) Where the Operation Selection Switch is in the AUTOMATIC position and when operating devices are not attached to the car, automatic call operation is enabled. Operating devices shall be

- (1) of the momentary pressure type, and
- (2) subject to the requirements of 5.11.12.

5.11.26.1.3 Wireless Operating Devices. Where wireless operating devices are provided, the operating devices shall be of the continuous pressure type.

5.11.26.1.4 All operating devices shall be

- (a) labeled "UP" and "DOWN," respectively, and
- (b) subject to the electrical protective devices required by 5.11.26.2

5.11.26.2 Electrical Protective Devices. When an electrical protective device is activated (operated, opened), it shall cause the electric power to be removed

from the elevator driving-machine motor and brake. Electrical protective devices shall have contacts that are positively opened mechanically, their opening shall not be solely dependent on springs, and be provided as specified in 5.11.26.2.1 through 5.11.26.2.6.

5.11.26.2.1 Emergency Stop Switch. An emergency stop switch shall be provided on wind turbine tower elevators. When open ("STOP" position), this switch shall cause the electric power to be removed from the elevator driving-machine motor and brake.

Emergency stop switches shall

- (a) be of the manually opened and closed type
- (b) have red operating handles or buttons
- (c) be conspicuously and permanently marked "STOP," and shall indicate the "STOP" and "RUN" positions

5.11.26.2.2 Stop Switch on Top of Car. A stop switch, conforming to 5.11.26.2.1, shall be provided on the top of every car where maintenance or inspection is to be performed from the top of the car.

5.11.26.2.3 Car Safety Mechanism Switch. A switch, conforming to 5.11.17.4, shall be required where a car safety or wire rope gripping safety is provided.

5.11.26.2.4 Final Terminal Stopping Devices. Final terminal stopping devices, conforming to 5.11.25, shall be provided for every electric elevator.

5.11.26.2.5 Car Door and Gate Electric Contacts. Car door or gate electric contacts, conforming to 5.11.14.9, shall be provided for all elevators.

5.11.26.2.6 Ladder-Guided Access Cover Switch. Ladder-guided access cover switch(es) shall be provided conforming to 5.11.14.9.3.

5.11.26.3 Contactors and Relays for Use in Critical Operating Circuits. Where electromechanical contactors or relays are provided to fulfill the requirements of 5.11.26.7.3 through 5.11.26.7.6, they shall be considered to be used in critical operating circuits. If contact(s) on these electromechanical contactors or relays are used for monitoring purposes, they shall be prevented from changing state if the contact(s) utilized in a critical operating circuit fail to open in the intended manner. The ability of the monitoring contact(s) to perform this function shall not be solely dependent upon springs.

5.11.26.4 Electrical Equipment and Wiring

5.11.26.4.1 All electrical equipment and wiring shall conform to NFPA 70 or CSA-C22.1, whichever is applicable (see Part 9), except traveling and trailing cables shall have the essential properties to meet all the temperature, strength, and flexibility requirements for the application in accordance with good engineering practice and be certified to a testing organization standard.

5.11.26.4.2 Electrical equipment shall be listed/certified and labeled/marked. CSA B44.1/ASME A17.5 defines the scope and applicable requirements for this listing/certification.

5.11.26.4.3 The devices covered by 5.11.26.2 shall have contacts that are positively opened mechanically; their opening shall not be solely dependent on springs.

5.11.26.4.4 Control equipment shall be tested in accordance with the testing requirements of EN 12016 by exposing it to interference levels at the test values specified for "safety circuits." The interference shall not cause any of the conditions described in 5.11.26.8.1 and 5.11.26.8.2 and shall not cause the car to move while on inspection operation.

(a) The test for voltage dips in Table 6 of EN 12016 shall be permitted to be conducted by either using the times specified in Table 6, or using a voltage reduction of 30% of the nominal input voltage for 0.5 cycles at 60 Hz and a voltage reduction of 60% of nominal input voltage for 5 cycles at 60 Hz.

(b) If enclosure doors or suppression equipment must remain installed to meet the above requirements, warning signs to that effect shall be posted on the control equipment.

NOTE (5.11.26.4.4): The test requirements for voltage dips in 5.11.26.4.4(a) are adjusted for 60 Hz operation.

5.11.26.5 Phase Protection of Motors. Elevators having a polyphase AC power supply shall be provided with means to prevent the starting of the elevator drive motor if a reversal of phase rotation or phase failure of the incoming polyphase AC power will cause the car to operate in the wrong direction.

5.11.26.6 Installation of Capacitors or Other Devices to Make Electrical Protective Devices Ineffective. The installation of capacitors or other devices, the operation or failure of which will cause an unsafe operation of the elevator, is prohibited.

5.11.26.7 Control and Operating Circuits

5.11.26.7.1 If springs are used to actuate switches, contactors, or relays to break the circuit to stop the car at the terminal landings, they shall be of the compression type.

5.11.26.7.2 The completion or maintenance of an electric circuit shall not be used to interrupt the power to the elevator driving-machine motor or brake at the terminal landings nor to stop the car when any of the electrical protective devices operate. Requirement 5.11.26.7.2 does not apply to dynamic braking.

5.11.26.7.3 The occurrence of a single ground or the failure of any single magnetically operated switch, contactor, or relay, or any single solid-state device not a part of a software system shall not permit the car to

move if any electrical protective device is not in the closed position. Use of software systems are permitted, provided that a non-software-controlled means is also used to remove power from the driving-machine motor and brake.

5.11.26.7.4 Methods used to satisfy 5.11.26.7.3 shall be checked prior to each start of the elevator. When a single ground or failure as specified in 5.11.26.7.3 occurs, the car shall not be permitted to restart.

5.11.26.7.5 Elevators employing alternating-current driving motors driven from a direct-current power source through a static inverter shall have two separate means provided to independently inhibit the flow of alternating current through the solid-state devices that connect the direct-current power source to the alternating-current driving motor by an electromechanical relay arranged to

- (a) open each time the car stops, or
- (b) open, at the latest, each time the car reverses direction and it has been verified at each stop that there is no current flow exceeding normal leakage current through the other means

The means used for conformance to 5.11.26.7.5 shall cause power to be removed from the driving-machine brake circuit.

5.11.26.7.6 Where relays are used to satisfy 5.11.26.7.3, after each time the relay is required to open in conformance to 5.11.26.7.4, the car shall not respond to a signal to start unless the relay that inhibits the flow of alternating current through the solid-state devices, as well as the contactors in the brake circuit, are in the de-energized position. After each stop in conformance to 5.11.26.7.5, the car shall not respond to a signal to start if current flow exceeding normal leakage current through the other means is detected.

5.11.26.7.7 The control circuits shall be so designed and installed that the car speed in the down direction with rated load in the car, under normal operating conditions with the power supply on or off, shall not exceed 125% of rated speed.

5.11.26.8 Release and Application of Driving-Machine Brakes

5.11.26.8.1 Driving-machine brakes shall not be electrically released until power has been applied to the driving-machine motor.

5.11.26.8.2 Two devices shall be provided to independently remove power from the brake. If the brake circuit is ungrounded, all power feed lines to the brake shall be opened.

5.11.26.8.3 The driving-machine brake shall apply automatically when

- (a) the operating device of a continuous pressure-operation elevator is in the stop position

- (b) a normal stopping means functions
- (c) any electrical protective device is activated
- (d) there is a loss of power to the driving-machine brake

5.11.27 Emergency Operation and Signaling Devices

Wired or wireless two-way communication between elevator personnel and a location staffed by authorized personnel attended while the tower is occupied shall be provided.

5.11.28 Layout Drawings

Elevator layout drawings shall, in addition to other data, indicate the following:

- (a) the maximum bracket, wire fix, or tie-in spacing
- (b) the estimated maximum vertical forces on application of the safety or other retarding device to the safety wire
- (c) the total static and impact loads imposed on machinery and sheave beams, supports, and floors or foundations
- (d) the impact load due to buffer or bumper engagement at the maximum permissible speed and load
- (e) the total static and dynamic loads from the ropes and tension system
- (f) the horizontal forces imposed on the tower structure
- (g) for wire guided systems, tension loads on the bottom attachment point
- (h) the car dimensions and minimum required through-platform clearances

5.11.29 Welding

All welding shall conform to the following.

5.11.29.1 Qualification of Welders. Where required elsewhere in this Code, welding of parts, except for tack welds later incorporated into finished welds, shall be undertaken

- (a) by welders qualified in accordance with the requirements of Section 4 of ANSI/AWS D1.1, whereby the welders shall be qualified by the manufacturer or contractor; a professional consulting engineer; or a recognized testing laboratory; or
- (b) by a fabricator qualified to the requirements of CSA W47.1, whichever is applicable (see Part 9)

5.11.29.2 Welding Steel. Where required elsewhere in this Code, welding shall conform to either of the following, whichever is applicable (see Part 9):

- (a) the design and procedure requirements of the applicable section of ANSI/AWS D1.1 or ANSI/AWS D1.3, or
- (b) the design and procedure requirements of CSA W59

5.11.29.3 Welding Metals Other Than Steel. Where required elsewhere in this Code, welding of materials

other than steel shall be done in accordance with the latest AWS or CSA requirements applicable to the specific materials used.

5.11.30 Engineering Tests, Type Tests, and Certification

Requirements 8.3.1 through 8.3.3 apply except as modified by the following requirements.

5.11.30.1 Type Tests of Interlocks, Combination Mechanical Locks, and Electric Contacts and Door or Gate Electric Contacts. Locking devices shall conform to 8.3.3, except as follows.

5.11.30.1.1 In 8.3.3.2, change the reference to Part 2 to Section 5.11.

5.11.30.1.2 In 8.3.3.4.1, change the number of required cycles from 960 000 cycles to 25 000 cycles of operation for wind turbine tower elevators.

5.11.30.1.3 In 8.3.3.4.3, change the required number of cycles from 25 000 cycles to 20 000 cycles of operation for wind turbine tower elevators.

5.11.31 Maintenance, Repair, Replacement, and Testing

Maintenance, repair, replacement, and testing shall conform to 8.6.

5.11.32 Acceptance Inspections and Tests

Acceptance inspections and tests shall conform to 8.10.

5.11.33 Periodic Inspections and Witnessing of Tests

Periodic inspections and witnessing of tests shall conform to 8.11.

(13)

SECTION 5.12 OUTSIDE EMERGENCY ELEVATORS

Requirement 5.12 applies to outside emergency elevators. These elevators are not designed to replace or lessen the number or availability of Firefighters' Emergency Operation (FEO) elevators, stairways, or other required means of firefighter or occupant access or egress, nor is this elevator intended for firefighting operations.

NOTE (5.12): See also Part 8 for additional requirements that apply to outside emergency elevators.

5.12.1 Guidance in Use of ASME A17.7/CSA B44.7

5.12.1.1 Design and testing of outside emergency elevators shall conform to the requirements of ASME A17.7/CSA B44.7, *Performance-based safety code for elevators and escalators*, except as modified in 5.12.1.2 through 5.12.1.4.

5.12.1.2 Global Essential Safety Requirement 3.1.6, Locking Landing Doors and Closing LCU (Car) Doors, shall not apply. Movement of the car shall be permitted without locking the landing doors when the risk of not moving from the landing exceeds the risk of moving the car without locking the landing doors.

5.12.1.3 Global Essential Safety Requirement 3.3.5, Gap Between the Landing Doors and LCU (Car) Doors, shall not apply. Means shall be provided to protect users from hazard of falling or crushing when in the gap between the landing door and the car door.

5.12.1.4 Global Essential Safety Requirement 3.5.5, Restrictions on Equipment in Elevator Spaces, shall apply. The car shall not operate or continue to operate when equipment or other obstructions are present in its path, except when the risk of entrapment exceeds the risk of moving the car.

5.12.2 Performing Risk Assessments

The risk assessment team in conformance with ASME A17.7/CSA B44.7, requirement 2.7.2, used to evaluate an outside emergency elevator, shall include a minimum of one member of the fire service experienced in high-rise fire fighting and building evacuation. This person shall represent the viewpoint of emergency personnel who operate these elevators.

5.12.3 Operating Instructions

Comprehensive operating instructions including all pertinent warnings shall be provided

(a) to the fire department or fire service having jurisdiction, and

(b) with the Maintenance Control Program. See 8.6.2.1.

Part 6

Escalators and Moving Walks

SCOPE

Part 6 applies to escalators and moving walks used to transport passengers.

NOTE: See also Part 8 for additional requirements that apply to *escalators and moving walks*.

SECTION 6.1 ESCALATORS

6.1.1 Protection of Floor Openings

- (13) **6.1.1.1 Protection Required.** Floor openings for escalators shall be protected against falls, the passage of flame, heat, and/or smoke in accordance with the provisions of the applicable building code (see Part 9).

6.1.2 Protection of Trusses and Machine Spaces Against Fire

6.1.2.1 Protection Required. The sides and undersides of an escalator truss or group of adjacent trusses in a single wellway shall be enclosed in materials defined as either noncombustible or limited-combustible by the building code or NFPA 101, whichever is applicable (see Part 9). Means provided for adequate ventilation of the driving machine and control spaces, when included in the truss enclosure area, shall be permitted.

6.1.3 Construction Requirements

6.1.3.1 Angle of Inclination. The angle of inclination shall be designed not to exceed 30 deg from the horizontal, but due to field conditions at the site shall be permitted to exceed this maximum by 1 deg. The angle shall be measured at the centerline of the steps.

6.1.3.2 Geometry

6.1.3.2.1 The width of the escalator shall be the width of the step tread. See 6.1.3.5.2 for step width requirements.

6.1.3.2.2 The handrail shall be a minimum of 100 mm (4 in.) horizontally and 25 mm (1 in.) vertically away from adjacent surfaces, except that rounded fillets or beveled sides of the handrail stand are permitted to reduce the 25 mm (1 in.) clearance between the handrail and the point where the handrail stand is connected to the balustrade. The centerline of the handrail shall be not more than 240 mm (9.5 in.), measured horizontally, from the vertical plane through the edge of the exposed step. (See Nonmandatory Appendix I, Figs. I-1 and I-2.)

6.1.3.3 Balustrades. Balustrades shall be installed on each side of the escalator. (See Nonmandatory Appendix I, Fig. I-3.)

6.1.3.3.1 Construction

(a) For

(1) escalators not equipped with dynamic skirt panels, the balustrade on the step side shall have no areas or moldings depressed or raised more than 6.4 mm (0.25 in.) from the parent surface, except as permitted in 6.1.3.3.10

(2) escalators equipped with dynamic skirt panels, the balustrade on the step side shall have no areas or moldings parallel to the direction of travel that are depressed or raised more than 12 mm (0.47 in.) from the parent surface

(3) all escalators, the depressed or raised areas or moldings shall have boundary edges bevelled or rounded

(b) The balustrade shall be totally closed, except

(1) where the handrail enters the newel base (see 6.1.3.4.3).

(2) gaps between interior panels shall be not wider than 5 mm (0.19 in.). The edges shall be rounded or beveled.

(3) where the dynamic skirt panels enter the balustrade [see 6.1.3.3.7(c)].

(c) The width between the balustrade interior panels in the direction of travel shall not be changed.

6.1.3.3.2 Strength. Balustrades shall be designed to resist the simultaneous application of a static lateral distributed force of 585 N/m (40 lbf/ft) applied to the side of the handrail and a vertical distributed force of 730 N/m (50 lbf/ft), applied to the top of the handrail.

6.1.3.3.3 Use of Glass or Plastic. Glass or plastic, if used in balustrades, shall conform to the requirements of the following standards, whichever is applicable (see Part 9):

(a) ANSI Z97.1 or 16 CFR Part 1201; or

(b) one of the following CGSB Standards: CAN/CGSB-12.1, CAN/CGSB-12.11, or CAN/CGSB-12.12; except that there shall be no requirement for the panels to be transparent.

Plastic bonded to basic supporting panels is not required to conform to these requirements.

6.1.3.3.4 Interior Low Deck. The interior low deck, where provided, shall conform to the following (see Nonmandatory Appendix I, Fig. I-1):

(a) The width from the vertical face of the interior panel to the vertical plane of the skirt panel, or dynamic skirt panel cover, where provided, shall not exceed 150 mm (6 in.).

(b) The angle between the surface of the deck and the plane of the nose line of the steps shall be not less than 20 deg nor more than 30 deg.

(c) A horizontal section shall be permitted immediately adjacent to the interior panel. It shall be not greater than 35 mm (1.25 in.).

(d) The deck and the dynamic skirt panel cover, where provided, at the point closest to the step shall withstand a force of 900 N (200 lbf) perpendicular to the line of attachment of the element without detachment or permanent deformation. The force shall be applied to an area of 645 mm² (1 in.²).

6.1.3.3.5 Loaded Gap Between Skirt and Step. The clearance (loaded gap) between the step tread and the adjacent skirt panel shall be not more than 5 mm (0.2 in.) when 110 N (25 lbf) is laterally applied from the step to the adjacent skirt panel. The applied load shall not deviate from 110 N (25 lbf) by more than ±11 N (2.5 lbf). The load shall be distributed over an area not less than 1 940 mm² (3 in.²) and not more than 3 870 mm² (6 in.²).

6.1.3.3.6 Skirt Panels

(a) The height of the skirt above the tread nose line shall be at least 25 mm (1 in.) measured vertically (see Nonmandatory Appendix I, Fig. I-4).

(b) Skirt panels shall not deflect more than 1.6 mm (0.0625 in.) under a force of 667 N (150 lbf).

(c) The exposed surfaces of the skirt panels adjacent to the steps shall be smooth.

6.1.3.3.7 Dynamic Skirt Panels. Dynamic skirt panels, where provided, shall conform to the following:

(a) The height of the dynamic skirt panel above the step tread nose line shall be at least 25 mm (1 in.) measured vertically (see Nonmandatory Appendix I, Fig. I-4).

(b) The exposed surfaces of the dynamic skirt panels adjacent to the step treads shall be smooth and in one plane. Exposed edges shall be rounded or beveled.

(c) Guarding shall be provided at the point where the dynamic skirt panels enter the balustrade. The clearance between the guard and the dynamic skirt panels shall not exceed 3 mm (0.125 in.).

(d) The exposed panels that comprise the dynamic skirt shall overlap or interlock such that no clear-through spaces exist. The distance between exposed edges of dynamic skirt panel elements shall not exceed 4 mm (0.16 in.).

(e) There must be a positive mechanical connection between the dynamic skirt panels and the running gear.

(f) The distance between the dynamic skirt panel and the dynamic skirt panel cover shall not exceed 5 mm (0.20 in.).

6.1.3.3.8 Dynamic Skirt Panel Loaded Gap. The gap clearance (loaded gap) at any point between the step tread and the adjacent dynamic skirt panel shall not exceed 5 mm (0.20 in.) when 110 N (25 lbf) is laterally applied from the step to the adjacent dynamic skirt panel. The applied load shall not deviate from 110 N (25 lbf) by more than ±11 N (2.5 lbf). The load shall be distributed over an area not less than 1 940 mm² (3 in.²) and not more than 3 870 mm² (6 in.²).

6.1.3.3.9 Step/Skirt Performance Index

(ED)

(a) This requirement is not applicable to escalators with dynamic skirt panels. The step/skirt performance index, when the escalator is subjected to the test specified in 8.6.8.15.19, shall be the maximum value of the recorded instantaneous step/skirt index $e^y / (e^y + 1)$, where

(SI Units)

$$e = 2.7183$$

$$y = -3.77 + 2.37 (\mu) + 0.37 (L_g)$$

μ = the sliding coefficient of friction of a polycarbonate test specimen on the skirt panel at the measurement point calculated when subjected to a 110 N normal load. The coefficient of friction shall be measured without addition of any field-applied lubricant.

L_g = the clearance between the step and the adjacent skirt panel when 110 N is applied from the step to skirt panel, mm

The applied load shall not deviate from 110 N by more than ±11 N. The load shall be distributed over a round or square area not less than 1 940 mm² and not more than 3 870 mm².

(Imperial Units)

$$e = 2.7183$$

$$y = -3.77 + 2.37 (\mu) + 9.3 (L_g)$$

μ = the sliding coefficient of friction of a polycarbonate test specimen on the skirt panel at the measurement point calculated when subjected to a 25 lbf normal load. The coefficient of friction shall be measured without addition of any field-applied lubricant.

L_g = the clearance between the step and the adjacent skirt panel when 25 lbf is applied from the step to skirt panel, in.

The applied load shall not deviate from 25 lbf by more than ±2.5 lbf. The load shall be distributed over a round or square area not less than 3 in.² and not more than 6 in.²

(b) The step/skirt performance index polycarbonate test specimen shall conform to the following specifications:

- (1) Material: Polycarbonate without fillers
- (2) Color: Natural, no pigments
- (3) Finish: Glossy (roughness less than $0.8 \mu\text{m}$ ($32 \mu\text{in.}$))
- (4) Area in contact with skirt panel: $2\,900 \pm 325 \text{ mm}^2$ ($4.5 \pm 0.5 \text{ in.}^2$) and at least 0.8 mm (0.03 in.) thick
- (5) Specification: GE Lexan 100 series or equivalent polycarbonate

(c) The escalator step/skirt performance index shall be either of the following:

- (1) ≤ 0.15
- (2) ≤ 0.25 when a skirt deflector device complying with the requirements of 6.1.3.3.10 is provided

6.1.3.3.10 Skirt Deflector Devices. Deflector devices shall be permitted. Where provided, deflector devices shall extend from skirt panels parallel to the escalator path of travel. Means to secure such deflector devices are permitted to be on the exposed surface of the skirt. Any exposed fastener heads shall be of the tamper-resistant type and flush to within 1 mm (0.04 in.).

(a) Rigid elements shall be in conformance with the following conditions:

(1) Horizontal protrusions extending above the step shall be 18 mm (0.75 in.) maximum. Corners or changes in profile shall be rounded or beveled. The exposed surfaces of such elements shall be smooth and permanently treated with a low-friction material.

(2) On the incline, the area of any protrusion shall lie entirely above a line on the skirt panel positioned at least 25 mm (1 in.) vertically above the step nose line. The lower surface shall be beveled not less than 10 deg upward and the upper surface shall be beveled not less than 15 deg downward. (See Fig. 6.1.3.3.10.)

(3) At the upper and lower landing, any protrusion shall lie entirely above a line on the skirt panel positioned at least 50 mm (2 in.) vertically above the step nose line. The lower surface shall be beveled not less than 10 deg upward and the upper surface shall be beveled not less than 15 deg downward. Any rigid elements at the landings shall smoothly blend into the rigid elements along the incline in accordance with the radius of curvature of the transition zone.

(4) When attached to the skirt, rigid elements shall withstand a force of 900 N (200 lbf) perpendicular to the line of attachment of the element without detachment or permanent deformation. The force shall be applied to an area of 645 mm^2 (1 in.²).

(b) Flexible elements shall be in conformance with the following conditions:

(1) The horizontal protrusion extending from the skirt surface above the step shall be 50 mm (2 in.) maximum.

Fig. 6.1.3.3.10 Dimensions

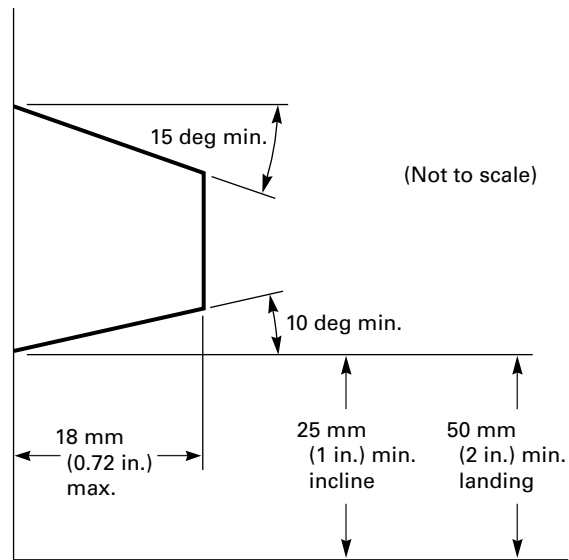

(2) They shall be capable of deflecting to an angle of 10 deg or greater above the horizontal.

(3) Noncontinuous flexible elements shall be allowed to deflect to allow a maximum of 9.5 mm (0.375 in.) interference with any point on the step surface.

(4) Continuous flexible elements shall not deflect such that they can contact the steps.

6.1.3.3.11 Guard at Ceiling Intersection

(a) On high deck balustrades, a solid guard shall be provided in the intersection of the angle of the outside balustrade deck and the ceiling or soffit, under the following conditions:

(1) where the clearance between the outside edge of the deck and the ceiling or soffit is 300 mm (12 in.) or less; or

(2) where the projected intersection of the outside deck and the ceiling or soffit is 600 mm (24 in.) or less from the centerline of the handrail.

(b) On low deck balustrades, a solid guard shall be provided to protect the intersection formed by the top of the handrail and the plain of the ceiling or soffit where the centerline of the handrail is 350 mm (14 in.) or less from the ceiling or soffit.

(c) The vertical edge of the guard shall be a minimum of 350 mm (14 in.) in length.

(d) The escalator side of the vertical face of the guard shall be flush with the face of the wellway.

(e) The exposed edge of the guard shall present a minimum width of 25 mm (1 in.) and a minimum radius of 12 mm (0.5 in.).

(f) Guards are permitted to be of glass or plastic, provided they meet the requirements of 6.1.3.3.3.

See also Nonmandatory Appendix I, Fig. I-5.

6.1.3.3.12 Antislip Devices. On high deck balustrades, antislip devices shall be provided on decks or combinations of decks when the outer edge of the deck is greater than 200 mm (8 in.) from the edge of the handrail, or on adjacent escalators when the unobstructed distance between the edge of the facing handrail is greater than 300 mm (12 in.).

These devices shall consist of raised objects fastened to the decks, no closer than 100 mm (4 in.) to the handrail nor greater than 300 mm (12 in.) from the handrail. They shall be spaced not greater than 2 000 mm (78 in.) apart as measured on a line parallel to the direction of travel and not greater than 300 mm (12 in.) as measured on a horizontal line perpendicular to the direction of travel. The height shall be not less than 50 mm (2 in.). There shall be no sharp corners or edges. See Nonmandatory Appendix I, Fig. I-6.

6.1.3.3.13 Deck Barricades

(a) A barricade to restrict access to the outer deck on low deck exterior balustrades shall be provided at the top and bottom ends of each escalator where the outer deck width exceeds 125 mm (5 in.). On parallel abutting units, this protection shall be provided where the combined outer deck width exceeds 125 mm (5 in.). The barricade shall extend to a height that is nominally 100 mm (4 in.) below the top of the handrail.

(b) When an escalator is not located at the edge of a floor surface, the barricade shall be installed on the outer deck at a point 1 000 mm (40 in.) above the floor where the bottom of the barricade intersects the outer deck.

(c) On parallel adjacent escalators, where the common low deck between adjacent interior panels exceeds 400 mm (16 in.), deck barricades should be spaced evenly up the incline at no greater than 4.6 m (15 ft) measured on a line parallel to the direction of travel.

(d) Barricades made of glass or plastic shall conform to the requirements of 6.1.3.3.3. All exposed barricade attachment fastener heads shall be of the tamper-resistant type.

6.1.3.4 Handrails

6.1.3.4.1 Type Required. Each balustrade shall be provided with a handrail moving in the same direction and at substantially the same speed as the steps. In the case of curved escalators, this shall be substantially the same angular velocity. The speed of the handrail shall not change when a retarding force of 450 N (100 lbf) is applied to the handrail opposite to the direction of travel.

6.1.3.4.2 Extension Beyond Combplates. Each moving handrail shall extend at normal handrail height not less than 300 mm (12 in.) beyond the line of points of the combplate teeth at the upper and lower landings.

6.1.3.4.3 Guards. Hand or finger guards shall be provided at a point where the handrail enters the balustrade.

6.1.3.4.4 Splicing. Splicing of handrails shall be done in such a manner that the joint is free of any pinching effect.

6.1.3.4.5 Vertical Height. The vertical height from step nose to top of handrail shall be not less than 900 mm (35 in.) nor more than 1 000 mm (39 in.). See 6.1.1.1 for floor opening protection adjacent to escalator wellways. (ED)

6.1.3.4.6 Handrail Clearance. The horizontal clearance between either lip of the handrail and the handrail stand shall not exceed 10 mm (0.375 in.). (See Nonmandatory Appendix I, Fig. I-2.)

6.1.3.5 Steps

6.1.3.5.1 Material and Type

(a) Step frames, treads, risers, and dynamic skirt panels, excluding the step's attachments or inserts, shall be metal, except that magnesium alloys shall not be used; or the materials, in their end-use configuration, shall have a flame spread index of 0 to 50 based on the tests conducted in accordance with the requirements of ASTM E84, UL 723, NFPA 255, or CAN/ULC-S102.2, whichever is applicable (see Part 9).

(b) Nonmetallic attachments and inserts (excluding wheels) shall be classified 94 HB or better in accordance with ANSI/UL 94.

(c) Step treads shall be horizontal, and shall afford a secure foothold. The step supporting system shall be so designed so that the back of the step cannot tip upward more than 6 mm (0.25 in.) at any point.

6.1.3.5.2 Dimensions of Steps. The depth of any step tread in the direction of travel shall be not less than 400 mm (15.75 in.), and the rise between treads shall be not more than 220 mm (8.5 in.). The width of a step tread shall be not less than 560 mm (22 in.) nor more than 1 020 mm (40 in.). (See Nonmandatory Appendix I, Fig. I-7.)

6.1.3.5.3 Cleated Step Risers. The step riser shall be provided with vertical cleats, which shall mesh with slots on the adjacent step tread wherever the steps are exposed. (See Nonmandatory Appendix I, Fig. I-8.)

6.1.3.5.4 Clearance Between Steps. The maximum clearance between step treads on the horizontal run shall be 6 mm (0.25 in.). (See Nonmandatory Appendix I, Fig. I-12.)

6.1.3.5.5 Slotting of Step Treads. The tread surface of each step shall be slotted in a direction parallel to the travel of the steps. Each slot shall be not more than 6.5 mm (0.25 in.) wide and not less than 9.5 mm (0.375 in.) deep, and the distance from center to center of adjoining slots shall be not more than 9.5 mm (0.375 in.).

Slots shall be so located on the step tread surface as to form a cleat on each side of the step tread adjacent to the skirt or dynamic skirt panel.

6.1.3.5.6 Step Demarcation. There shall be demarcation lines on the step tread along the back of the step to delineate the division between steps. These lines shall be marked by a yellow strip a minimum of 38 mm (1.5 in.) in width and a maximum of 50 mm (2 in.). [See 6.1.3.5.1(b).]

There shall be demarcation lines on the step tread along the sides of the step. These side lines shall be yellow and at least 13 mm (0.5 in.) wide and shall not exceed 50 mm (2 in.). [See 6.1.3.5.1(b).]

6.1.3.5.7 Step Fatigue Tests. Each step width shall be subjected to the step fatigue test as described in 8.3.11.

6.1.3.5.8 Step Wheels. Where support wheels attached to the steps are not located within the width of the step, provision shall be made to prevent the step from falling into the escalator interior due to a loss of one or more of the support wheel assemblies.

6.1.3.6 Entrance and Egress Ends

6.1.3.6.1 Combplates

(a) There shall be a combplate, to which the combs shall be fastened, at the entrance and at the exit of every escalator.

(b) The comb teeth shall be meshed with and set into the slots in the tread surfaces so that the points of the teeth are always below the upper surface of the treads.

(c) Combplates shall be adjustable vertically. Sections forming the comb teeth shall be readily replaceable.

(d) The comb section, combplate, and landing plate assemblies shall not make contact with the step treads when a weight of 160 kg (350 lb) is applied to any area 200 mm × 300 mm (8 in. × 12 in.) centered on the plates with the 300 mm (12 in.) dimension parallel to the direction of travel.

6.1.3.6.2 Distinction Between Comb and Step.

There shall be a visual contrast between the comb and step, achieved by color, pattern, or texture.

6.1.3.6.3 Adjacent Floor Surfaces. The adjacent floor surfaces at each landing shall be continuous with the top of the landing plate with no abrupt change in elevation of more than 6 mm (0.25 in.).

6.1.3.6.4 Safety Zone. The entry and exit zone shall be kept clear of all obstacles. The width of the zone shall be not less than the width between the centerlines of the handrails plus 200 mm (8 in.). The length of the zone, measured from the end of the newel, shall be not less than twice the distance between the centerlines of the handrails. Space shall be provided to accommodate all traffic in the safety zone.

NOTE: These dimensions are absolute minimums.

6.1.3.6.5 Flat Steps. There shall be a minimum of two and a maximum of four flat steps at the entrance and exit of every escalator. (See 1.3 and 6.1.3.5.2.)

6.1.3.7 Trusses or Girders. The truss or girder shall be designed to safely sustain the running gear in operation. In the event of failure of the track system, it shall retain the running gear within the confines of this truss.

Where tightening devices are operated by means of tension weights, provision shall be made to retain these weights in the truss if they should be released.

6.1.3.8 Step Wheel Tracks. Step wheel tracks shall be designed so as to prevent displacement of the running gear if a step chain breaks.

6.1.3.9 Rated Load

6.1.3.9.1 Structural. For the purpose of structural design, the rated load shall be considered to be not less than the following:

(SI Units)

$$\text{Structural rated load (kg)} = D_1 (W + 203)A/1\,000$$

(Imperial Units)

$$\text{Structural rated load (lb)} = D_2 (W + 8)A/12$$

where

A = length of the horizontal projection of the entire truss measured along its centerline, m (ft)

D_1 = Loading Factor = 270 kg/m²

D_2 = Loading Factor = 55.2 lb/ft²

W = width of the escalator, mm (in.) (see 6.1.3.2)

6.1.3.9.2 Machinery

(a) For the purpose of driving machine and power transmission calculations, the rated load for all single driving machines shall be considered to be not less than the following:

(SI Units)

$$\text{Machinery rated load (kg)} = D_3 (W + 203)B_1/1\,000$$

(Imperial Units)

$$\text{Machinery rated load (lb)} = D_4 (W + 8)B_1/12$$

(b) The rated load per module for two or more modular driving machines shall be considered to be not less than:

(SI Units)

$$\text{Machinery rated load (kg)} = D_3 (W + 203)B_2/1\,000$$

(Imperial Units)

$$\text{Machinery rated load (lb)} = D_4 (W + 8)B_2/12$$

where

B_1 = $\cot \theta \times$ total rise, m (ft)

B_2 = $\cot \theta \times$ rise per module, m (ft)

- D_3 = Loading Factor = 210 kg/m²
 D_4 = Loading Factor = 42.0 lb/ft²
 W = width of the escalator, mm (in.) (see 6.1.3.2)
 θ = the angle of inclination, deg (see 6.1.3.1)

6.1.3.9.3 Brake

(a) For the purpose of brake calculations, the rated load for all single driving machines shall be considered to be not less than the following:

- (1) with escalator stopped

(SI Units)

$$\text{Brake rated load (kg)} = D_5 (W + 203)B_1/1\,000$$

(Imperial Units)

$$\text{Brake rated load (lb)} = D_6 (W + 8)B_1/12$$

- (2) with escalator running

(SI Units)

$$\text{Brake rated load (kg)} = D_3 (W + 203)B_1/1\,000$$

(Imperial Units)

$$\text{Brake rated load (lb)} = D_4 (W + 8)B_1/12$$

(b) The rated load per module for two or more modular driving machines shall be considered to be not less than the following:

- (1) with escalator stopped

(SI Units)

$$\text{Brake rated load (kg)} = D_5 (W + 203)B_2/1\,000$$

(Imperial Units)

$$\text{Brake rated load (lb)} = D_6 (W + 8)B_2/12$$

- (2) with escalator running

(SI Units)

$$\text{Brake rated load (kg)} = D_3 (W + 203)B_2/1\,000$$

(Imperial Units)

$$\text{Brake rated load (lb)} = D_4 (W + 8)B_2/12$$

where

- B_1 = cot θ × total rise, m (ft)
 B_2 = cot θ × rise per module, m (ft)
 D_3 = Loading Factor = 210 kg/m²
 D_4 = Loading Factor = 42.0 lb/ft²
 D_5 = Loading Factor = 360 kg/m²
 D_6 = Loading Factor = 73.7 lb/ft²
 W = width of the escalator, mm (in.) (see 6.1.3.2)
 θ = the angle of inclination, deg (see 6.1.3.1)

6.1.3.9.4 Step. The step shall be designed to support a load of 135 kg (300 lb) on a 150 mm × 250 mm

(6 in. × 10 in.) plate placed on any part of the step with the 250 mm (10 in.) dimension in the direction of step travel.

6.1.3.10 Design Factors of Safety. Factors of safety are based on either single driving-machine design or modular driving-machine design.

The factors of safety shall be at least the following.

6.1.3.10.1 Trusses and all supporting structures, including tracks, shall conform to the AISC Specifications for Design, Fabrication, and Erection of Structural Steel for Buildings, or the CSA Standard CAN/CSA-S16.1, whichever is applicable (see Part 9), based on the maximum static load calculated per 6.1.3.9.1.

6.1.3.10.2 For driving-machine parts based on not less than the loads calculated per 6.1.3.9.2:

(a) where made of steel or bronze, the factor of safety shall be 8

(b) where made of cast iron or other materials, the factor of safety shall be 10

6.1.3.10.3 For power transmission members, the factor of safety shall be 10, based on not less than the loads calculated per 6.1.3.9.2.

6.1.3.10.4 For steps, the factor of safety shall be 5, based on not less than the loads designated in 6.1.3.9.4.

6.1.3.11 Chains. The use of chains with cast iron links shall not be permitted.

6.1.3.12 Headroom. The minimum headroom shall be 2 130 mm (84 in.) measured vertically from the step noseline, landing plates, and landings.

6.1.3.13 Welding. Welding shall conform to 8.8.

6.1.3.14 Non-Escalator-Related Equipment. Components not used directly in connection with the escalator are prohibited to be installed on, in, or through the escalator.

6.1.3.15 Water Accumulation. Permanent provisions shall be made to prevent accumulation of ground-water in the pit. Drains and sump pumps, where provided, shall comply with the applicable plumbing code. (13)

6.1.4 Rated Speed

6.1.4.1 Limits of Speed

6.1.4.1.1 The rated speed shall be not more than 0.5 m/s (100 ft/min), measured along the centerline of the steps in the direction of travel.

The speed attained by an escalator after start-up shall not be intentionally varied, except as permitted by 6.1.4.1.2.

6.1.4.1.2 Variation of the escalator speed after start-up shall be permitted provided the escalator installation conforms to all of the following:

(a) The acceleration and deceleration rates shall not exceed 0.3 m/s^2 (1.0 ft/sec^2).

(b) The rated speed is not exceeded.

(c) The minimum speed shall be not less than 0.05 m/s (10 ft/min).

(d) The speed shall not automatically vary during inspection operation.

(e) Passenger detection means shall be provided at both landings of the escalator such that

(1) detection of any approaching passenger shall cause the escalator to accelerate to or maintain the full escalator speed conforming to 6.1.4.1.2(a) through (d)

(2) detection of any approaching passenger shall occur sufficiently in advance of boarding to cause the escalator to attain full operating speed before a passenger walking at normal speed [1.35 m/s (270 ft/min)] reaches the combplate

(3) passenger detection means shall remain active at the egress landing to detect any passenger approaching against the direction of escalator travel and shall cause the escalator to accelerate to full rated speed and sound the alarm (see 6.1.6.3.1) at the approaching landing before the passenger reaches the combplate

(f) Automatic deceleration shall not occur before a period of time has elapsed since the last passenger detection that is greater than 3 times the amount of time necessary to transfer a passenger between landings.

(g) Means shall be provided to detect failure of the passenger detection means and shall cause the escalator to operate at full rated speed only.

6.1.5 Driving Machine, Motor, and Brake

6.1.5.1 Connection Between Driving Machine and Main Drive Shaft. The driving machine shall be connected to the main drive shaft by toothed gearing, a mechanical coupling, or a chain.

6.1.5.2 Driving Motor. An electric motor shall not drive more than one escalator driving machine. A driving machine shall not operate more than one escalator.

6.1.5.3 Brakes

6.1.5.3.1 Escalator Driving-Machine Brake

(a) Each escalator driving machine shall be provided with an electrically released and mechanically or magnetically applied brake. If the brake is magnetically applied, a ceramic permanent magnet shall be used. There shall be no intentional time delay designed into the application of the brake.

(b) The brake shall be applied automatically if the electrical power supply is interrupted. The brake shall be capable of stopping the down-running escalator with any load up to the brake rated load [see 6.1.3.9.3(a)(2) or (b)(2)]. The brake shall hold the stopped escalator with

any load up to the brake rated load [see 6.1.3.9.3(a)(1) or (b)(1)].

(c) Driving-machine brakes shall stop the down-running escalator steps at an average rate not greater than 0.91 m/s^2 (3 ft/s^2) as measured over the total retardation time. No peak horizontal retardation value exceeding 0.91 m/s^2 (3 ft/s^2) shall have a time duration greater than 0.125 s (see Nonmandatory Appendix I, Fig. I-11). (See also 6.1.6.3.6.)

(d) The escalator brake shall be provided with a data plate that is readily visible, located on the machine brake and when necessary, a duplicate data plate with the certification mark shall be placed adjacent to the machine brake. The data plate shall indicate:

(1)(a) for fixed torque brakes, the range of brake torque that complies with 6.1.5.3.1 and 6.1.6.3.6; or

(1)(b) for variable torque brakes, the minimum brake torque for a loaded escalator and the minimum stopping distance for the unloaded escalator, which complies with 6.1.5.3.1 and 6.1.6.3.6;

(2) the method of measuring the torque, designated "BREAKAWAY" or "DYNAMIC," based on the method used when measuring the torque;

(3) the location where the torque is to be measured, e.g., "MOTOR SHAFT," "MACHINE INPUT SHAFT," "MAIN DRIVE SHAFT";

(4) the type of brake as fixed or variable torque;

(5) the maximum stopping distance with rated load in the down direction that corresponds to the minimum distance between

(a) the comb and the step when the step is positioned to activate any of the safety devices required in 6.1.6.3.6, 6.1.6.3.9, 6.1.6.3.11, 6.1.6.5, or

(b) the activation point of the Dynamic Skirt Panel Obstruction Device (see 6.1.6.3.16) and the entrance of the skirt panel into the balustrade.

(e) Where means other than a continuous shaft, mechanical coupling, or toothed gearing is used to connect the motor to a gear reducer, the escalator driving-machine brake shall be located on the gear reducer or main drive shaft.

6.1.5.3.2 Main Drive Shaft Brake. If the escalator driving-machine brake is separated from the main drive shaft by a chain used to connect the driving machine to the main drive shaft, a mechanically or magnetically applied brake capable of stopping a down-running escalator with brake rated load (see 6.1.3.9.3) shall be provided on the main drive shaft. If the brake is magnetically applied, a ceramic permanent magnet shall be used.

6.1.5.3.3 Escalator driving-machine brakes shall be certified to the requirements of 8.3.1 and 8.3.6.

6.1.6 Operating and Safety Devices

6.1.6.1 General. Operating and safety devices conforming to the requirements of this Section shall be provided. When more than one driving machine per escalator is utilized, actuation of devices covered by this Section shall simultaneously control all driving machines.

6.1.6.1.1 Automatic Operation. Automatic starting by any means, or automatic stopping, except as required in 6.1.6, shall be prohibited.

6.1.6.2 Starting and Inspection Control Switches

6.1.6.2.1 Escalators shall be provided with starting switch(es) conforming to the following:

(a) *Location and Design.* The switch(es) shall be:

(1) located so that the escalator steps are within sight.

(2) key operated, of the continuous-pressure spring-return type, and shall be operated by a cylinder-type lock having not less than a five-pin or five-disk combination.

(3) clearly and permanently marked "DOWN," "RUN," and "UP," in that order, with the key removable only in the "RUN" (spring return) position. The switch(es) shall be rotated clockwise to go from the "DOWN" to "RUN" to "UP" position.

(b) *Operating Requirements.* The operation of the switch(es) shall initiate movement of the escalator. The escalator shall not start (restart) unless all starting switch(es) were first in the "RUN" position.

(c) The starting switch(es) shall be located within reach of an emergency stop button (see 6.1.6.3.1).

(d) The key shall be of Group 2 Security (see 8.1).

6.1.6.2.2 Inspection Control. Each escalator shall be equipped with inspection controls not accessible to the general public during normal operation to provide constant pressure operation during maintenance, repair, or inspection by means of a manually operated control device.

(a) *General Requirements*

(1) Switches for transferring the control of the escalator to inspection operation shall be provided or a switch shall be provided at each landing in a portable control station; the switch(es) shall function as follows:

(a) be through a contact that shall be positively opened mechanically and whose opening shall not depend solely on springs

(b) be manually operated

(c) be labeled "INSPECTION"

(d) have two positions, labeled "INSPECTION" or "INSP" and "NORMAL" or "NORM"

(e) when in the "INSPECTION" position, it shall cause the movement of the escalator to be solely under the control of constant pressure operating devices at that landing or in that portable control station

(f) be arranged so that if more than one inspection transfer switch is in the "INSPECTION" position, then all constant pressure operating devices at all locations shall be inoperative

(g) be protected against accidental contact

(2) Constant pressure operating devices shall

(a) allow movement of the escalator only by constant application of manual pressure

(b) be distinctly recognizable from indications on the device as to the direction of travel controlled

(c) be protected against accidental contact

(d) be located so that the escalator steps are within sight

(3) A stop switch conforming to 6.1.6.3.15 shall be provided adjacent to the constant pressure operating devices.

(4) When portable control stations are used, the cord length shall not exceed 3 000 mm (120 in.) in length.

(b) *Plug-in Portable Control Station.* A plug-in portable control station shall be permitted, provided that

(1) either a transfer switch conforming to 6.1.6.2.2(a)(1) is complied with, or when plugged in, the escalator shall automatically transfer to inspection operation

(2) when the switch, if provided, is in the "INSPECTION" position, or when the control station is plugged in, it shall cause the movement of the escalator to be solely under the control of constant pressure operating devices contained in the portable unit

(3) the plug-in portable control station is stored at the upper landing machinery space

6.1.6.3 Electrical Protective Devices. Electrical protective devices shall be provided in accordance with 6.1.6.3.1 through 6.1.6.3.16.

6.1.6.3.1 Emergency Stop Buttons

(a) *Location.* A red stop button shall be visibly located at the top and the bottom landings on the right side facing the escalator. In jurisdictions not enforcing NBCC, remote stop buttons are prohibited. In jurisdictions enforcing NBCC, if remote buttons are provided, they shall be located within view of the escalator.

(1) On high deck balustrades, they shall be located on the curved newel deck in the upper quadrant, with the centerline of the button at a 45 deg angle from the horizontal.

(2) On low deck balustrades, they shall be located below the handrail height. The centerline of the button shall be located on a radial line 45 deg above the horizontal, such that no part of the button assembly is within 38 mm (1.5 in.) of the bottom of the handrail and the button is no more than 90 mm (3.5 in.) from the bottom of the handrail.

(b) *Cover, Alarm, and Marking.* The buttons shall be covered with a transparent cover that can be readily lifted or pushed aside. When the cover is moved, an

audible warning signal shall be activated. The signal shall have a sound intensity of 80 dBA minimum at the button location. The cover shall be marked "EMERGENCY STOP," "MOVE COVER" or equivalent legend (e.g., "LIFT COVER," "SLIDE COVER,"), and "PUSH BUTTON." "EMERGENCY STOP" shall be in letters not less than 12 mm (0.5 in.) high. Other required wording shall be in letters not less than 4.8 mm (0.188 in.) high. The cover shall be self-resetting.

(c) *Operation.* The operation of either of these buttons shall cause the electric power to be removed from the escalator driving-machine motor and brake. It shall not be possible to start the escalator by these buttons.

6.1.6.3.2 Escalator Speed-Monitoring Device. An escalator speed-monitoring device shall be provided.

(a) The operation of the device shall cause the electric power to be removed from the driving-machine motor and brake should the speed exceed the rated speed by more than 20%.

(b) The device shall be of the manual-reset type.

6.1.6.3.3 Broken Step-Chain Device

(a) A broken step-chain device shall be provided, which shall cause the electric power to be removed from the driving-machine motor and brake

(1) if a step chain breaks

(2) where no automatic chain tension device is provided, if excessive sag occurs in either step chain

(b) The device shall be of the manual-reset type.

6.1.6.3.4 Drive-Chain Device. When the driving machine is connected to the main drive shaft by a chain, a device shall be provided that will cause the application of the brake on the main drive shaft, and will also cause the electric power to be removed from the driving-machine motor and brake if the drive chain between the machine and the main drive shaft becomes disengaged from the sprockets. The device shall be of the manual-reset type.

6.1.6.3.5 Stop Switch in Machinery Spaces. A stop switch conforming to the following requirements shall be provided in each machinery space and other spaces where means of access to the interior space is provided (see 6.1.7.3), except for the machinery space where the mainline disconnect switch is located

(a) when opened ("STOP" position), cause the electric power to be removed from the escalator driving-machine motor and brake

(b) be of the manually opened and closed type

(c) have red operating handles or buttons

(d) be conspicuously and permanently marked "STOP," and shall indicate the "STOP" and "RUN" positions

(e) shall have contacts that are positively opened mechanically and their opening shall not be solely dependent on springs

6.1.6.3.6 Escalator Skirt Obstruction Device. (13)

Means shall be provided to cause the electric power to be removed from the escalator driving-machine motor and brake if an object becomes caught between the step and the skirt as the step approaches the upper or lower combplate. The device shall be located at a point at which the step assumes a flat step position (see 6.1.3.6.5). The escalator shall stop before that object reaches the combplate with any load up to full brake rated load with escalator running [see 6.1.3.9.3(a)(2) and (b)(2)]. The device shall be of the manual reset type or it shall be permitted to automatically reset not more than one time within 24 hr of operation and thereafter require a manual reset before the next restart. Interruption of power during operation should not cause the device to lose the status of the timer nor the count of events.

6.1.6.3.7 Escalator Egress Restriction Device.

Egress restrictors that would prevent the free and continuous exiting of passengers, if used, shall provide a signal to a device on the escalator that shall cause the electric power to be removed from the escalator driving-machine motor and brake when the exit restrictors begin to close.

6.1.6.3.8 Reversal Stop Device. Means shall be provided to cause the electric power to be removed from the driving-machine motor and brake in case of reversal of travel while the escalator is operating in the ascending direction. The device shall be of the manual-reset type.

6.1.6.3.9 Step Uphrust Device. (13) Means shall be provided in the passenger-carrying line of the track system to detect a step forced upward in the lower transition curve at or prior to the point of tangency of the horizontal and curved track. The means shall actuate when the riser end of the step is displaced upward more than 5 mm (0.20 in.) at the lower landing. Actuation of the means shall cause power to be removed from the driving-machine motor and brake. The escalator shall stop, before the detected step reaches the combplate with any load up to brake rated load with escalator running [see 6.1.3.9.3(a)(2) and (b)(2)]. The device shall be of the manual reset type or it shall be permitted to automatically reset not more than one time within 24 hr of operation and thereafter require a manual reset before the next restart. Interruption of power during operation should not cause the device to lose the status of the timer nor the count of events.

6.1.6.3.10 Disconnected Motor Safety Device. If the drive motor is attached to a gear reducer by means other than a continuous shaft, mechanical coupling, or toothed gearing, a device shall be provided that will cause the electric power to be removed from the driving-machine motor and brake (see 6.1.5.3.1), if the motor becomes disconnected from the gear reducer. The device shall be of the manual-reset type.

6.1.6.3.11 Step Level Device. Step level devices shall be located at the top and bottom of the escalator. These devices shall detect downward displacement of 3 mm (0.125 in.) or greater at the riser end at either side of the step. When activated, the device shall cause the escalator to stop before the step enters the combplate. The device shall cause power to be removed from the driving-machine motor and brake. Devices shall be of the manual-reset type.

(13) **6.1.6.3.12 Handrail Entry Device.** A handrail entry device shall be provided at each newel. It shall be operative in the newels in which the handrail enters the balustrade. It shall cause the escalator to stop by removing power from the driving-machine motor and brake. It shall operate in either of two ways:

(a) if an object becomes caught between the handrail and the handrail guard

(b) if an object approaches the area between the handrail and the handrail guard

For those units that rely on an opening of the balustrade to prevent entrapment, all handrail entry devices shall be operative whenever the handrails are operating. The device shall be of the manual reset type or it shall be permitted to automatically reset not more than one time within 24 hr of operation and thereafter require a manual reset before the next restart. Interruption of power during operation should not cause the device to lose the status of the timer nor the count of events.

6.1.6.3.13 Comb-Step Impact Devices. Devices shall be provided that will cause the opening of the power circuit to the escalator driving-machine motor and brake if either

(a) a horizontal force not greater than 1 780 N (400 lbf) in the direction of travel is applied at either side, or not greater than 3 560 N (800 lbf) at the center of the front edge of the comb-plate; or

(b) a resultant vertical force not greater than 670 N (150 lbf) in the upward direction is applied at the center of the front of the combplate.

These devices shall be of the manual-reset type.

6.1.6.3.14 Step Lateral Displacement Device. A device shall be provided on curved escalators to cause the opening of the power circuit to the escalator driving-machine motor and brake, should a step be excessively displaced horizontally due to a failure in the lateral support system. The device shall be of the manual-reset type.

6.1.6.3.15 Stop Switch in Inspection Controls. A stop switch conforming to the following requirements shall be provided when required by 6.1.6.2.2:

(a) when opened (“STOP” position), cause the electric power to be removed from the escalator driving-machine motor and brake

(b) be of the manually opened and closed type

(c) have red operating handles or buttons

(d) be conspicuously and permanently marked “STOP,” and shall indicate the “STOP” and “RUN” positions

(e) shall have contacts that are positively opened mechanically and their opening shall not be solely dependent on springs

6.1.6.3.16 Dynamic Skirt Panel Obstruction Device. Means shall be provided to cause the electric power to be removed from the escalator driving-machine motor and brake if an object becomes caught between the dynamic skirt panel and the dynamic skirt panel cover in the upper or lower transition zone. The device shall be of the manual-reset type. The escalator shall stop before that object reaches the balustrade with any load up to full brake rated load with the escalator running [see 6.1.3.9.3(a)(2) and (b)(2)].

(13) **6.1.6.4 Handrail Speed Monitoring Device.** A handrail speed monitoring device shall be provided that will cause the activation of the alarm required by 6.1.6.3.1(b) without any intentional delay, whenever the speed of either handrail deviates from the step speed by 15% or more. The device shall also cause electric power to be removed from the driving-machine motor and brake when the speed deviation of 15% or more is continuous within a 2 s to 6 s range. The device shall be of the manual reset type or it shall be permitted to automatically reset not more than one time within 24 hr of operation and thereafter require a manual reset before the next restart. Interruption of power during operation should not cause the device to lose the status of the timer nor the count of events.

6.1.6.5 Missing Step and Missing Dynamic Skirt Devices

(a) A device shall be provided to detect a missing step and bring the escalator to a stop, before the gap resulting from the missing step emerges from the comb. The device shall cause power to be removed from the driving-machine motor and brake. The device shall be of the manual-reset type.

(b) For escalators with dynamic skirts, a device shall be provided to detect a missing dynamic skirt panel and bring the escalator to a stop, before the gap resulting from the missing dynamic skirt panel emerges from the balustrade. The device shall cause power to be removed from the driving-machine motor and brake. The device shall be of the manual-reset type.

6.1.6.6 Tandem Operation. Tandem operation escalators shall be electrically interlocked where traffic flow is such that bunching will occur if the escalator carrying passengers away from the intermediate landing stops. The electrical interlocks shall stop the escalator carrying passengers into the common intermediate landing if the escalator carrying passengers away from the landing

stops. These escalators shall also be electrically interlocked to assure that they run in the same direction.

6.1.6.7 Reserved for Future Use

6.1.6.8 Escalator Smoke Detectors. Smoke detectors shall be permitted that shall activate the alarm required by 6.1.6.3.1(b) and, after at least 15 s, shall cause the interruption of power to the driving-machine motor and brake.

6.1.6.9 Signs

6.1.6.9.1 Caution Signs. A caution sign shall be located at the top and bottom landing of each escalator, readily visible to the boarding passengers.

The sign shall include the following wording:

- (a) "Caution"
- (b) "Passengers Only"
- (c) "Hold Handrail"
- (d) "Attend Children"
- (e) "Avoid Sides"

The sign shall be standard for all escalators and shall be identical in format, size, color, wording, and pictorials as shown in Fig. 6.1.6.9.1. The sign shall be durable and have a maximum thickness of 6.4 mm (0.25 in.), with rounded or beveled corners and edges.

- (13) **6.1.6.9.2 Signs or Graphics Relating to Safety.** Signs or graphics relating to safety shall not be permitted on the escalator in such a manner nor adjacent to the escalator in such a manner that obstructs boarding passenger view of the signs required in 6.1.6.9.1, physically obstructs passenger flow at the landings as specified in the safety zone (see 6.1.3.6.4), nor obstructs or reduces passenger access to the handrails. They shall be legible and not be distracting, create passenger flow hazards, or impair function of safety devices.

- (13) **6.1.6.9.3 Additional Signs or Graphics.** Signs or graphics other than those specified in 6.1.6.9.1 and 6.1.6.9.2 shall not be permitted adjacent to the escalator in such a manner that obstructs boarding passenger view of the signs required in 6.1.6.9.1, obstructs or reduces passenger access to the handrails, within the safety zone (see 6.1.3.6.4), nor on the escalator except for signs, graphics, or markings required by this Code, manufacturer's identification, owner's identification, step riser signs or graphics, and handrail signs or graphics that are permitted on the escalator. They shall not be distracting, create passenger flow hazards, or impair function of safety devices.

6.1.6.10 Control and Operating Circuits. The design and installation of the control and operating circuits shall conform to 6.1.6.10.1 through 6.1.6.10.4.

6.1.6.10.1 The occurrence of a single ground or the failure of any single magnetically operated switch,

contactor, or relay; or any single solid-state device; or a software system failure, shall not

- (a) permit the escalator to start
- (b) render ineffective any electrical protective device required by 6.1.6.3
- (c) render ineffective the handrail speed-monitoring device required by 6.1.6.4
- (d) render ineffective the missing step device required by 6.1.6.5
- (e) render ineffective the missing dynamic skirt device required by 6.1.6.5
- (f) permit the escalator to revert to normal operation when on inspection operation (see 6.1.6.2.2)

NOTE [6.1.6.10.1(b) through (e)]: Requirements apply only to the circuits in which the devices are used and not to the devices themselves.

6.1.6.10.2 Methods used to satisfy 6.1.6.10.1 using software systems are permitted, provided that a non-software-controlled means is also used to remove power from the driving-machine motor and brake.

6.1.6.10.3 Methods used in the control and operating circuits to satisfy the requirements of 6.1.6.10.1 shall be checked prior to each start of the escalator. When a single ground or failure as specified in 6.1.6.10.1 occurs, the escalator shall not be permitted to restart.

6.1.6.10.4 Escalators with driving-machine motors employing static control shall conform to the following:

- (a) Two devices shall be provided to remove power from the driving-machine motor. At least one device shall be an electromechanical contactor.
 - (1) The contactor shall be arranged to open each time the escalator stops.
 - (2) The contactor shall cause the removal of power from the driving-machine brake in accordance with 6.1.6.3.4.
- (b) An additional contactor shall be provided to also open the driving-machine brake circuit. This contactor is not required to have contacts in the driving-machine motor circuit.
- (c) The electrical protective devices required by 6.1.6.3 shall control the solid-state device and both contactors.
- (d) After each stop of the escalator, the escalator shall not respond to a signal to start unless both contactors [see 6.1.6.10.4(a) and (b)] are in the de-energized position.

6.1.6.11 Electrically Powered Safety Devices. If the handrail speed monitoring device required by 6.1.6.4, the missing step or missing skirt device, required by 6.1.6.5, or any electrical protective device required by 6.1.6.3, requires electrical power for its functioning

- (a) a loss of electrical power to the device shall cause power to be removed from the escalator driving-machine motor and brake

Fig. 6.1.6.9.1 Caution Sign

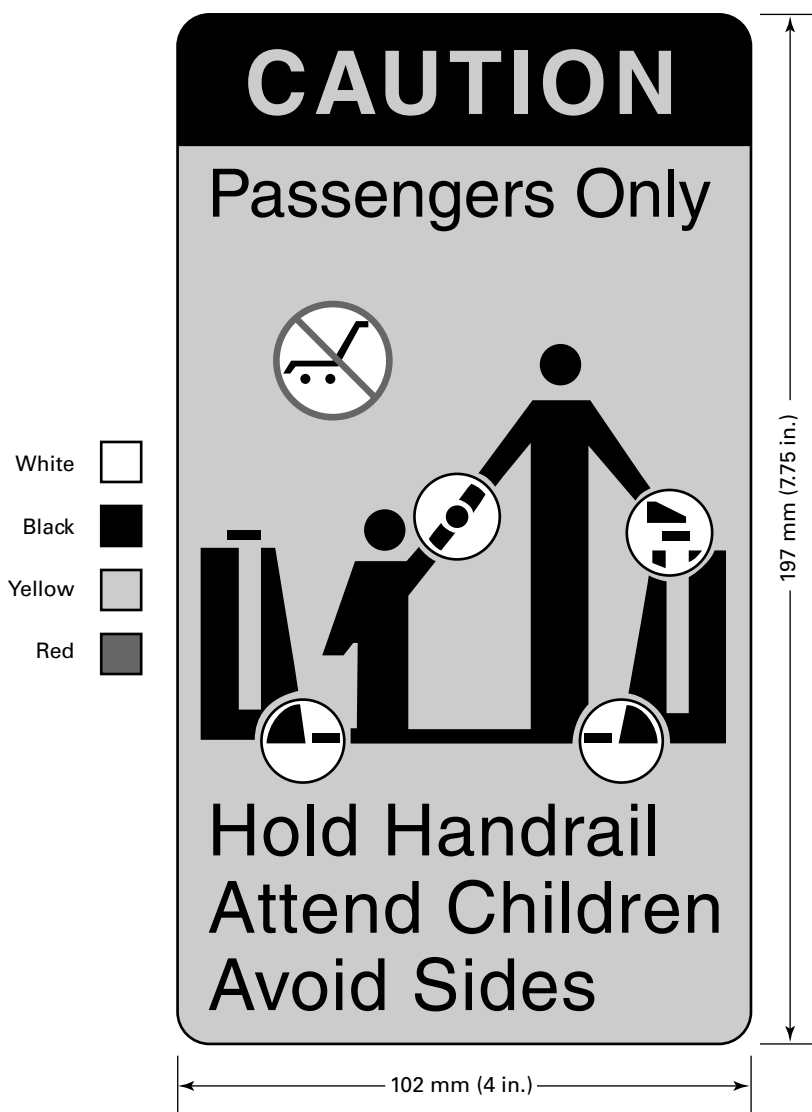

(b) the occurrence of a single ground or the failure of any single magnetically operated switch, contactor, or relay; or any single solid-state device; or a software system failure, shall not render the missing step or missing dynamic skirt devices or handrail speed monitoring device or electrical protective device inoperative

(c) when a single ground or failure as described in 6.1.6.11(b) occurs, the escalator shall not be permitted to restart

6.1.6.12 Installation of Capacitors or Other Devices to Make Electrical Protective Devices Ineffective. The installation of capacitors, or other devices, the operation or failure of which will cause an unsafe operation of the escalator, is prohibited. No permanent device shall be installed, except as provided for in this Code, which

will make any required electrical protective device ineffective. (See also 6.1.6.3.4.)

6.1.6.13 Completion or Maintenance of Circuit. The completion or maintenance of an electric circuit shall not be used to stop the escalator when the emergency stop switch is opened or when any of the electrical protective devices operate. These requirements do not apply to speed control switches (see 6.1.6.3.2, 6.1.6.3.8, and 6.1.6.4).

6.1.6.14 Escalator Manual Reset. Where manual reset is required, interruption of power to the escalator shall not cause a safety device to lose the status of the event upon return of power. The cause of the malfunction shall be indicated in some manner, so that an examination will be made prior to restarting the escalator. The

starting switch shall not be operable until the reset for each activated device is accomplished.

6.1.6.15 Contactors and Relays for Use in Critical Operating Circuits. Where electromechanical contactors or relays are provided to fulfill the requirements of 6.1.6.10.1 through 6.1.6.10.4, they shall be considered to be used in critical operating circuits. If contact(s) on these electromechanical contactors or relays are used for monitoring purposes, they shall be prevented from changing state if the contact(s) utilized in a critical operating circuit fail to open in the intended manner. The monitoring contact(s) shall be positively actuated and shall not be solely dependent upon springs.

6.1.7 Lighting, Access, and Electrical Work

6.1.7.1 Lighting of Machine Room and Truss Interior

6.1.7.1.1 Remote Machine Room. Permanent electric lighting and at least one duplex receptacle rated at not less than 15 A, 120 V shall be provided in every remote machine room.

The illumination shall be not less than 100 lx (10 fc) at the floor level. The lighting control switch shall be located within easy reach of the access to such rooms and so located that it can be operated without passing over or reaching over any part of the machinery.

6.1.7.1.2 Truss Interior. A duplex receptacle rated at not less than 15 A, 120 V, accessibly located, shall be provided under the access plates (see 6.1.7.3) at the top and bottom landings and in any machine areas located in the incline.

6.1.7.2 Lighting of Escalator. Landing floor plates and all exposed step treads shall be illuminated with a lighting intensity of not less than 50 lx (5 fc). The illumination of these surfaces shall be of uniform intensity and not contrast materially with that of the surrounding area.

6.1.7.3 Access to Interior. Reasonable access to the interior of the escalator shall be provided for inspection and maintenance.

6.1.7.3.1 Access plates requiring no more than 310 N (70 lbf) effort to open shall be provided at the top and bottom landing for inspection and maintenance. The plates shall be made of a material that will afford a secure foothold. The use of stone, terrazzo, or concrete as a fill material is prohibited in panels within the confines of the escalator truss.

6.1.7.3.2 Access plates at the top and bottom landings shall be securely fastened by a mechanical means.

6.1.7.3.3 If access doors are provided in the side of the escalator enclosure, they shall be kept closed and locked. The key shall be removed only when in the

locked position. The key shall be of Group 2 Security (see 8.1).

6.1.7.3.4 Where access is provided to a machinery enclosure, a fixed guard shall be provided to prevent accidental contact with the moving steps by a person servicing equipment from within the enclosure. The guard shall be made of material that will reject a 13 mm (0.5 in.) diameter ball and shall extend the full width of the step treads. A guard is not required where the only equipment normally serviced from within the enclosure is within the step band.

6.1.7.4 Electrical Equipment and Wiring

6.1.7.4.1 All electrical equipment and wiring shall conform to NFPA 70 or CSA-C22.1, whichever is applicable (see Part 9). In jurisdictions enforcing CSA-C22.1, power supply-line disconnecting means shall not be opened automatically by a fire alarm system.

6.1.7.4.2 Electrical equipment shall be listed/certified and labeled/marked. CSA B44.1/ASME A17.5 defines the scope and applicable requirements for this listing/certification.

6.1.7.4.3 Control equipment shall be tested in accordance with the testing requirements of EN 12016 by exposing it to interference levels at the test values specified for "safety circuits." The interference shall not cause any of the conditions described in 6.1.6.10.1(a) through (f). If enclosure doors or suppression equipment must remain installed to meet the above requirements, warning signs to that effect shall be posted on the control equipment.

6.1.8 Outdoor Escalators

6.1.8.1 Weatherproofing. Escalators shall be so constructed that exposure to the weather will not interfere with normal operation.

6.1.8.1.1 The escalator equipment and its supports shall be protected from corrosion.

6.1.8.1.2 Electrical equipment shall be provided with a degree of protection of at least Type 4 construction as specified in NEMA 250, and wiring shall be identified for use in wet locations in accordance with NFPA 70 or CSA-C22.1 as applicable (see Part 9).

6.1.8.2 Precipitation. A cover, directly over the horizontal projection of the escalator, shall be provided. The cover shall extend outward from the centerline of the handrail so that a line extended from the edge of the cover to the centerline of the handrail forms an angle of not less than 15 deg from the vertical.

6.1.8.2.1 When the escalator is subjected to blowing snow or freezing rain, heating systems shall be operated to prevent accumulation of snow or ice on the steps, landings, and skirt deflector devices. The heating

systems operation shall be thermostatically controlled and independent of the escalator operation.

- (13) **6.1.8.2.2** Drains suitable for all weather conditions shall be provided to prevent the accumulation of water where groundwater and runoff can collect within the equipment.

6.1.8.3 Slip Resistance. Landing plates and com-plates shall be designed to provide a secure foothold when wet.

SECTION 6.2 MOVING WALKS

6.2.1 Protection of Floor Openings

6.2.1.1 Protection Required. Floor openings for moving walks shall be protected against the passage of flame, heat, and/or smoke in accordance with the provisions of the applicable building code (see Part 9).

6.2.2 Protection of Supports and Machine Spaces Against Fire

6.2.2.1 Protection Required. The sides and undersides of the moving walk truss or group of adjacent trusses in a single wellway shall be enclosed in materials defined as either noncombustible or limited-combustible by the building code or NFPA 101, whichever is applicable (see Part 9). Means provided for adequate ventilation of the driving machine and control spaces, when included in the truss enclosure area, shall be permitted.

6.2.3 Construction Requirements

6.2.3.1 Angle of Inclination. The angle of inclination from the horizontal shall not exceed 3 deg within 900 mm (36 in.) of the entrance and egress ends and shall not exceed 12 deg at any point.

6.2.3.2 Geometry

6.2.3.2.1 The width of the moving walk shall be the width of the exposed tread (see 6.2.3.7).

6.2.3.2.2 The height of the balustrade shall be not less than 900 mm (35 in.) nor more than 1 000 mm (39 in.) from the treadway to the top of handrail, measured perpendicular to the treadway surface.

6.2.3.2.3 The handrail shall be a minimum of 100 mm (4 in.) horizontally and 25 mm (1 in.) vertically away from adjacent surfaces, except that rounded fillets or beveled sides of the handrail stand are permitted to reduce the 25 mm (1 in.) clearance between the handrail and the point where the handrail stand is connected to the balustrade. The centerline of the handrail shall be not more than 240 mm (9.5 in.), measured horizontally, from the vertical plane through the edge of the exposed treadway (see Nonmandatory Appendix I, Fig. I-9).

6.2.3.3 Balustrades. Balustrades shall be installed on each side of the moving walk (see Nonmandatory Appendix I, Fig. I-7).

6.2.3.3.1 Construction

(a) The balustrade on the tread side shall have no areas or moldings depressed or raised more than 6.4 mm (0.25 in.) from the parent surface. Such areas or moldings shall have all boundary edges beveled or rounded.

(b) The balustrade shall be totally closed except:

(1) where the handrail enters the newel base (see 6.2.3.4.3).

(2) gaps between interior panels shall not be wider than 5 mm (0.19 in.). The edges shall be rounded or beveled.

(c) The width between the balustrade interior panels in the direction of travel shall not be changed.

6.2.3.3.2 Strength. Balustrades shall be designed to resist the simultaneous application of a static lateral distributed force of 585 N/m (40 lbf/ft) applied to the side of the handrail and a vertical distributed force of 730 N/m (50 lbf/ft) applied to the top of the handrail.

6.2.3.3.3 Use of Glass or Plastic. Glass or plastic, if used in balustrades, shall conform to the requirements of either of the following standards, whichever is applicable (see Part 9):

(a) ANSI Z97.1 or 16 CFR Part 1201

(b) one of the following CGSB Standards: CAN2-12.1, CAN2-12.11, or CAN2-12.12; except that there shall be no requirement for the panels to be transparent

Plastic bonded to basic supporting panels is not required to conform to these requirements.

6.2.3.3.4 Interior Low Deck. The interior low deck, where provided, shall conform to the following (see Nonmandatory Appendix I, Fig. I-9):

(a) The width from the vertical face of the interior panel to the vertical plane of the skirt panel shall not exceed 150 mm (6 in.).

(b) The angle between the surface of the deck and the plane of the noseline of the treadway shall be not less than 20 deg nor more than 30 deg.

(c) A horizontal section shall be permitted immediately adjacent to the interior panel. It shall be not greater than 35 mm (1.25 in.).

6.2.3.3.5 Skirtless Balustrade. On moving walks where the balustrade covers the edge of the treadway

(a) the clearance between the top surface of the treadway and the underside of the balustrade shall not exceed 6 mm (0.25 in.)

(b) the balustrade shall be vertical and smooth for at least 25 mm (1 in.) including the 6 mm (0.25 in.) clearance above the top of the tread

6.2.3.3.6 Skirt Panels. Where skirt panels are provided

(a) the clearance between each side of the treadway and the adjacent skirt panel shall be not more than 6 mm (0.25 in.)

(b) the height of the skirt above the top of the tread shall be at least 25 mm (1 in.), measured vertically

(c) skirt panels shall not deflect more than 1.6 mm (0.06 in.) under a force of 670 N (150 lbf)

(d) the exposed surface of the skirt panels adjacent to the tread shall be smooth

6.2.3.3.7 Guard at Ceiling Intersections

(a) On high deck balustrades, a solid guard shall be provided in the intersection of the angle of the outside balustrade deck and ceiling or soffit under either of the following conditions:

(1) where the clearance between the outside edge of the deck and the ceiling or soffit is 300 mm (12 in.) or less

(2) where the projected intersection of the outside deck and the ceiling or soffit is 600 mm (24 in.) or less from the centerline of the handrail

(b) On low deck balustrades, a solid guard shall be provided to protect the intersection formed by the top of the handrail and the plane of the ceiling or soffit where the centerline of the handrail is 350 mm (14 in.) or less from the ceiling or soffit.

(c) The vertical edge of the guard shall be a minimum of 350 mm (14 in.) in length.

(d) The moving walk side of the vertical face of the guard shall be flush with the face of the wellway.

(e) The exposed edge of the guard shall present a minimum width of 25 mm (1 in.) and a minimum radius of 12 mm (0.5 in.).

(f) Guards made of glass or plastic shall conform to the requirements of 6.2.3.3.3. See also Nonmandatory Appendix I, Fig. I-5.

6.2.3.3.8 Deck Barricades

(a) A barricade to restrict access to the outer deck on low deck exterior balustrades shall be provided on each moving walk when the exterior deck is greater than 915 mm (36 in.) above the floor in any part of its travel and the exterior deck width exceeds 125 mm (5 in.). On parallel abutting units, this protection shall be provided where the combined outer deck width exceeds 125 mm (5 in.). The barricade shall extend to a height that is nominally 100 mm (4 in.) below the top of the handrail.

(b) The barricades shall be located wherever the exterior deck exceeds the 915 mm (36 in.) height above the floor.

(c) On parallel adjacent moving walks, where the common low deck between adjacent interior panels exceeds 400 mm (16 in.), deck barricades should be spaced evenly along the treadway at not greater than

4.6 m (15 ft) measured on a line parallel to the direction of travel.

(d) Barricades made of glass or plastic shall conform to the requirements of 6.2.3.3.3.

All exposed barricade attachment fastener heads shall be of the tamper-resistant type.

6.2.3.4 Handrails

6.2.3.4.1 Type Required. Each balustrade shall be provided with a handrail moving in the same direction and at substantially the same speed as the treadway. The speed of the handrail shall not change when a retarding force of 450 N (100 lbf) is applied to the handrail opposite to the direction of travel.

6.2.3.4.2 Extension Beyond Combplates. The moving handrail at both the entrance and exit landings shall extend at normal height not less than 300 mm (12 in.) beyond the end of the exposed treadway. The point at which the moving handrail enters or leaves an enclosure shall be not more than 250 mm (10 in.) above the floor line.

6.2.3.4.3 Guards. Hand or finger guards shall be provided at points where the handrails enter the balustrade.

6.2.3.4.4 Splicing. Splicing of handrails shall be done in such a manner that the joint is free of any pinching effect.

6.2.3.4.5 Handrail Clearance. The horizontal clearance between either lip of the handrail and the handrail stand shall not exceed 10 mm (0.375 in.).

6.2.3.5 Pallet-Type Treadway

6.2.3.5.1 Slotting of Treadway. The treadway surface of each pallet shall be slotted in a direction parallel to its travel. Each slot shall be not more than 6.5 mm (0.25 in.) wide at the treadway surface and not less than 9.5 mm (0.375 in.) deep; and the distance from center to center of adjoining slots shall be not more than 9.5 mm (0.375 in.). Sides of the slots shall be permitted to slope for mold draft purposes and shall be permitted to be filleted at the bottom. Slots shall be so located on each side of the pallet to form a cleat adjacent to the skirt panel. (See Nonmandatory Appendix I, Fig. I-10.)

6.2.3.5.2 Intermeshing Pallets. Alternate cleats on adjacent pallets shall intermesh so that there is no continuous transverse gap between adjacent pallets.

6.2.3.5.3 Alignment of Pallet Tread Surfaces. Adjacent ends of pallets shall not vary in elevation more than 1.6 mm (0.06 in.).

6.2.3.5.4 Pallet Fatigue Tests. Each pallet width shall be subjected to the pallet fatigue test as described in 8.3.11.

Table 6.2.3.7 Treadway Width

| Maximum Treadway, Slope at Any Point on Treadway, deg | Maximum Moving Walk Treadway Width, mm (in.) | | |
|--|--|--|--|
| | Maximum Treadway Speed, 0.45 m/s (90 ft/min) | Treadway Speed, Above 0.45 m/s (90 ft/min) to 0.7 m/s (140 ft/min) | Treadway Speed, Above 0.7 m/s (140 ft/min) to 0.9 m/s (180 ft/min) |
| 0 to 4 | Unrestricted | 1 525 (60) | 1 020 (40) |
| Above 4 to 8 | 1 020 (40) | 1 020 (40) | 1 020 (40) |
| Above 8 to 12 | 1 020 (40) | 1 020 (40) | Not permitted |

6.2.3.5.5 Material and Type

(a) Pallet frames and treads, excluding their attachments or inserts, shall be metal, except that magnesium alloys shall not be used; or the materials, in their end-use configuration, shall have a flame spread index of 0 to 50, based on the tests conducted in accordance with the requirements of ASTM E84, UL 723, NFPA 255, or CAN/ULC-S102.2, whichever is applicable (see Part 9).

(b) Nonmetallic attachments and inserts (excluding wheels) shall be classified 94 HB or better, in accordance with ANSI/UL 94.

(c) Pallet treads shall afford a secure foothold.

6.2.3.5.6 Pallet Wheels. Where support wheels are attached to the pallets and are not located within the width of the pallet, provision shall be made to prevent the pallet from falling into the moving walk interior due to a loss of one or more of the support wheel assemblies.

6.2.3.6 Belt-Type Treadway. Belt-type treadways shall conform to 6.2.3.6.1 and 6.2.3.6.2.

6.2.3.6.1 Splices. Splicing of the treadway belt shall be made in such a manner as to result in a continuous unbroken treadway surface of the same characteristics as the balance of the belt.

6.2.3.6.2 Slotting of Treadway. The treadway surface shall be slotted in a direction parallel to its travel for purposes of meshing with combplates at the landings. Each slot shall be not more than 6.4 mm (0.25 in.) wide at the treadway surface and not less than 4.8 mm (0.188 in.) deep, and the distance from center to center of adjoining slots shall be not more than 13 mm (0.50 in.). Sides of slots shall be permitted to slope for mold draft purposes and shall be permitted to be filleted at the bottom. Slots shall be so located on each side of the belt to form a cleat adjacent to the skirt panel.

6.2.3.7 Width. The width of a moving walk (see 6.2.3.2.1) shall be not less than 560 mm (22 in.). The maximum width shall depend both on the maximum slope at the point on the treadway and on the treadway speed. The width shall not exceed the value shown in Table 6.2.3.7.

6.2.3.8 Entrance and Egress Ends**6.2.3.8.1 Combplates**

(a) There shall be a combplate, to which combs shall be fastened, at the entrance and at the exit of every moving walk.

(b) The comb teeth shall be meshed with and set into the slots in the tread surfaces so that the points of the teeth are always below the upper surface of the treads.

(c) Combplates shall be adjustable vertically. Sections forming the comb teeth shall be readily replaceable.

(d) The comb section, combplate, and landing plate assemblies shall not make contact with the pallet or belt treadway surfaces when a weight of 160 kg (350 lb) is applied to any area 200 mm × 300 mm (8 in. × 12 in.) centered on the plates with the 300 mm (12 in.) dimension parallel to the direction of travel.

6.2.3.8.2 Distinction Between Comb and Treadway. There shall be a visual contrast between the comb and tread, achieved by color, pattern, or texture.

6.2.3.8.3 Adjacent Floor Surfaces. The adjacent floor surfaces at each landing shall be continuous with the top of the landing plate, with no abrupt change in elevation of more than 6 mm (0.25 in.).

6.2.3.8.4 Safety Zone. The entry and exit zones shall be kept clear of all obstacles. The width of the zones shall be not less than the width between the centerlines of the handrails plus 200 mm (8 in.). The length of the zones, measured from the end of the newel, shall be not less than twice the distance between the centerlines of the handrails. Space shall be provided to accommodate all traffic in the safety zone.

NOTE: These dimensions are absolute minimums.

6.2.3.8.5 Floor Opening Protection Adjacent to Moving Walk Wellway. Floor openings adjacent to the entire length of the moving walk wellway shall be provided with protection in accordance with the applicable building code (see Part 9).

6.2.3.9 Supporting Structure

6.2.3.9.1 Supports. Supports shall conform to the following:

(a) *Slider-Bed Type.* The carrying portion of the treadway shall be supported for its entire width and

length, except where it passes from a support to a pulley. The surface of the slider bed shall be reasonably smooth. It shall be so constructed that it will not support combustion.

(b) *Roller-Bed Type.* Where the treadway is supported on a series of rollers, the combination of roller spacing, belt tension, and belt stiffness shall be such that the deflection of the treadway surface, midway between rollers, shall not exceed the quantity 0.25 mm (0.094 in.) plus 0.004 times the center-to-center distance of rollers in mm (in.) when measured as follows:

(1) The treadway surface shall be loaded midway between rollers with a 11.3 kg (25 lb) weight, concentrated on a cylindrical foot-piece 50 mm (2 in.) long by 25 mm (1 in.) in diameter, placed with its long axis across the belt. Deflection of this footpiece from its unloaded position shall not exceed the figure obtained above.

(2) The rollers shall be concentric and true running within commercially acceptable tolerances.

(c) *Edge-Supported Belt Type.* When the treadway belt is transversely rigid and is supported by rollers along its edges, the following requirements shall apply:

(1) With the belt tensioned through the take-up system, the permissible slope of a straight line from the top of a treadway rib adjacent to the centerline of the treadway to the top of a treadway rib adjacent to the balustrade, in a plane perpendicular to the path of the treadway, shall not exceed 3% when the treadway is loaded with a 68 kg (150 lb) weight on a 150 mm × 250 mm (6 in. × 10 in.) plate, located on the centerline of the treadway with the 250 mm (10 in.) dimension in the direction of treadway travel.

(2) In order to support the treadway in case of localized overload, supports shall be supplied at intervals not exceeding 1 830 mm (72 in.) along the centerline of the treadway. The supports shall be located at a level not more than 50 mm (2 in.) below the underside of the treadway when it is loaded under test conditions required by 6.2.3.9.1(c)(1).

(d) *Pallet Type.* Pallet wheel tracks shall be so designed and located as to prevent more than 3 mm (0.125 in.) vertical displacement of the treadway should the pallet connection means break.

6.2.3.10 Rated Load

6.2.3.10.1 Structural. For the purpose of structural design, the rated load shall be considered to be not less than the following:

(SI Units)

$$\text{Structural rated load (kg)} = D_7 (W)A/1\ 000$$

(Imperial Units)

$$\text{Structural rated load (lb)} = D_8 (W)A/12$$

where

A = length of the horizontal projection of the entire truss, m (ft)

D_7 = Loading Factor = 490 kg/m²

D_8 = Loading Factor = 100 lb/ft²

W = width of the moving walk, mm (in.) (see 6.2.3.2.1 and 6.2.3.7)

6.2.3.10.2 Machinery

(a) For the purpose of driving machine and power transmission calculations, the rated load for all single driving machines shall be considered to be not less than the following:

(SI Units)

$$\text{Machinery rated load (kg)} = D_9 (W)C_1/1\ 000$$

(Imperial Units)

$$\text{Machinery rated load (lb)} = D_{10} (W)C_1/12$$

(b) The rated load per module for two or more modular driving machines shall be considered to be not less than the following:

(SI Units)

$$\text{Machinery rated load (kg)} = D_9 (W)C_2/1\ 000$$

(Imperial Units)

$$\text{Machinery rated load (lb)} = D_{10} (W)C_2/12$$

where

C_1 = length of exposed treadway, m (ft)

C_2 = length of exposed treadway per module, m (ft)

D_9 = Loading Factor = 370 kg/m²

D_{10} = Loading Factor = 75.0 lb/ft²

W = width of the moving walk, mm (in.) (see 6.2.3.2.1 and 6.2.3.7)

6.2.3.10.3 Brake

(a) For the purpose of brake calculations, the rated load for all single driving machines shall be considered to be not less than the following:

(1) With moving walk stopped

(SI Units)

$$\text{Brake rated load (kg)} = D_7 (W)C_1/1\ 000$$

(Imperial Units)

$$\text{Brake rated load (lb)} = D_8 (W)C_1/12$$

(2) With moving walk running

(SI Units)

$$\text{Brake rated load (kg)} = D_9 (W)C_1/1\ 000$$

(Imperial Units)

$$\text{Brake rated load (lb)} = D_{10} (W) C_1 / 12$$

(b) The rated load per module for two or more modular driving machines shall be considered to be not less than the following:

(1) with moving walk stopped

(SI Units)

$$\text{Brake rated load (kg)} = D_7 (W) C_2 / 1\,000$$

(Imperial Units)

$$\text{Brake rated load (lb)} = D_8 (W) C_2 / 12$$

(2) with moving walk running

(SI Units)

$$\text{Brake rated load (kg)} = D_9 (W) C_2 / 1\,000$$

(Imperial Units)

$$\text{Brake rated load (lb)} = D_{10} (W) C_2 / 12$$

where

C_1 = length of exposed treadway, m (ft)

C_2 = length of exposed treadway per module, m (ft)

D_7 = Loading Factor = 490 kg/m²

D_8 = Loading Factor = 100 lb/ft²

D_9 = Loading Factor = 370 kg/m²

D_{10} = Loading Factor = 75.0 lb/ft²

W = width of moving walk, mm (in.) (see 6.2.3.2.1 and 6.2.3.7)

6.2.3.10.4 Pallet. The pallet shall be designed to support a load of 135 kg (300 lb) for each 0.42 m² (4.5 ft²) of area, or part thereof. The load shall be applied on a 150 mm × 250 mm (6 in. × 10 in.) plate, placed on any part of the pallet with the 250 mm (10 in.) dimension in the direction of pallet travel. If more than one load is required, they shall be located no closer than 910 mm (36 in.) to each other.

6.2.3.11 Design Factors of Safety. Factors of safety are based on either single driving-machine design or modular driving-machine design. The factors of safety shall be at least as specified in 6.2.3.11.1 through 6.2.3.11.5.

6.2.3.11.1 Trusses and all supporting structures, including tracks, shall conform to the AISC Specifications for Design, Fabrication, and Erection of Structural Steel for Buildings, or the CSA Standard CAN/CSA-S16.1, whichever is applicable (see Part 9), based on the maximum static load calculated per 6.2.3.10.1.

Table 6.2.4 Treadway Speed

| Maximum Treadway Slope at Any Point on Treadway, deg | Maximum Treadway Speed, m/s (ft/min) |
|--|--------------------------------------|
| 0 to 8 | 0.9 (180) |
| Above 8 to 12 | 0.7 (140) |

6.2.3.11.2 For driving-machine parts based on not less than the loads calculated per 6.2.3.10.2:

(a) where made of steel or bronze, factor of safety shall be 8

(b) where made of cast iron or other materials, factor of safety shall be 10

6.2.3.11.3 For power transmission members, factor of safety shall be 10, based on not less than the loads calculated per 6.2.3.10.2.

6.2.3.11.4 For pallets, factor of safety shall be 5, based on not less than the loads designated in 6.2.3.10.4.

6.2.3.11.5 For belts, factor of safety shall be 5, based on not less than the loads designated in 6.2.3.10.2.

6.2.3.12 Chains. The use of chains with cast iron links shall not be permitted.

6.2.3.13 Reserved for Future Use

6.2.3.14 V-Belt Drives. The load imposed on V-belt drives, when operating at the machinery rated load, shall not exceed the horsepower rating established by ANSI/RMA IP-20. The loading shall be considered to be uniform and the service to be 24 h per day.

6.2.3.15 Headroom. The minimum headroom shall be 2 130 mm (84 in.) measured vertically from the treadway surface, landing plates, and landings.

6.2.3.16 Welding. Welding shall conform to 8.8.

6.2.3.17 Nonmoving-Walk Related Equipment. Components not used directly in connection with the moving walk are prohibited to be installed on, in, or through the moving walk.

6.2.3.18 Water Accumulation. Permanent provisions shall be made to prevent accumulation of ground water in the pit. Drains and sump pumps, where provided, shall comply with the applicable plumbing code.

6.2.4 Rated Speed

6.2.4.1 Limits of Speed

6.2.4.1.1 The maximum speed of a treadway shall depend on the maximum slope at any point on the treadway. The speed shall not exceed the value determined by Table 6.2.4.

The speed attained by a moving walk after start-up shall not be intentionally varied, except as permitted by 6.2.4.1.2.

6.2.4.1.2 Variation of the moving-walk speed after start-up shall be permitted, provided the moving-walk installation conforms to all of the following:

(a) The acceleration and deceleration rates shall not exceed 0.3 m/s^2 (1.0 ft/sec^2).

(b) The rated speed is not exceeded.

(c) The minimum speed shall be not less than 0.05 m/s (10 ft/min).

(d) The speed shall not automatically vary during inspection operation.

(e) Passenger detection means shall be provided at both landings of the moving walk such that

(1) detection of any approaching passenger shall cause the moving walk to accelerate to or maintain the full moving walk speed conforming to 6.2.4.1.2(a) through (d)

(2) detection of any approaching passenger shall occur sufficiently in advance of boarding to cause the moving walk to attain full operating speed before a passenger walking at normal speed [1.35 m/s (270 ft/min)] reaches the combplate

(3) passenger detection means shall remain active at the egress landing to detect any passenger approaching against the direction of moving walk travel and shall cause the moving walk to accelerate to full rated speed and sound the alarm (see 6.2.6.3.1) at the approaching landing before the passenger reaches the combplate

(f) Automatic deceleration shall not occur before a period of time has elapsed since the last passenger detection that is greater than 3 times the amount of time necessary to transfer a passenger between landings.

(g) Means shall be provided to detect failure of the passenger detection means and shall cause the moving walk to operate at full rated speed only.

6.2.5 Driving Machine, Motor, and Brake

6.2.5.1 Connection Between Driving Machine and Main Drive Shaft. The driving machine shall be connected to the main drive shaft by toothed gearing, a mechanical coupling, or a chain.

6.2.5.2 Driving Motor. An electric motor shall not drive more than one moving walk driving machine. A driving machine shall not operate more than one moving walk.

6.2.5.3 Brakes

6.2.5.3.1 Moving Walk Driving-Machine Brakes

(a) Each moving walk driving machine shall be provided with an electrically released and mechanically or magnetically applied brake. If the brake is magnetically applied, a ceramic permanent magnet shall be used. There shall be no intentional time delay designed into the application of the brake.

(b) The brake shall be applied automatically if the electrical power supply is interrupted. The brake shall

be capable of stopping the down- or horizontal-running moving walk with any load up to the brake rated load [see 6.2.3.10.3(a)(2) or (b)(2)]. The brake shall hold the stopped moving walk with any load up to the brake rated load [see 6.2.3.10.3(a)(1) or (b)(1)].

(c) Driving-machine brakes shall stop the down- or horizontal-running moving walk treadway at an average rate not greater than 0.91 m/s^2 (3 ft/s^2) as measured over the total retardation time. No peak horizontal retardation value exceeding 0.91 m/s^2 (3 ft/s^2) shall have a time duration greater than 0.125 s (see Nonmandatory Appendix I, Fig. I-11).

(d) The moving walk brake shall be provided with a data plate that is readily visible, located on the machine brake and, when necessary, a duplicate data plate with the certification mark shall be placed adjacent to the machine brake. The data plate shall indicate

(1)(a) for fixed torque brakes, the range of brake torque that complies with 6.2.5.3.1, or

(1)(b) for variable torque brakes, the minimum brake torque for a loaded moving walk and the minimum stopping distance for the unloaded moving walk that complies with 6.2.5.3.1

(2) the method of measuring the torque, designated "BREAKAWAY" or "DYNAMIC," based on the method used when measuring the torque

(3) the location where the torque is to be measured, e.g., "MOTOR SHAFT," "MACHINE INPUT SHAFT," "MAIN DRIVE SHAFT"

(4) the type of brake as fixed or variable torque

(e) Where means other than a continuous shaft, mechanical coupling, or toothed gearing is used to connect the motor to a gear reducer, the moving walk driving-machine brake shall be located on the gear reducer, main drive shaft, or a specially attached braking surface attached directly to the treadway.

6.2.5.3.2 Main Drive Shaft Brake. If the moving walk driving-machine brake is connected to the main drive shaft by a chain, and the moving walk, with the drive chain disconnected, is capable of running under gravity with any load up to and including rated load (see 6.2.3.10.2), a mechanically or magnetically applied brake capable of stopping a down-running moving walk with brake rated load (see 6.2.3.10.3) shall be provided on the main drive shaft or specially attached braking surface attached directly to the treadway. If the brake is magnetically applied, a ceramic permanent magnet shall be used.

6.2.6 Operating and Safety Devices

6.2.6.1 General

6.2.6.1.1 Operating and safety devices conforming to 6.2.6 shall be provided. When more than one driving machine per moving walk is utilized, actuation

of devices covered by 6.2.6 shall simultaneously control all driving machines.

6.2.6.1.2 Automatic Operation. Automatic starting by any means, or automatic stopping, except as required in 6.2.6, shall be prohibited.

6.2.6.2 Starting and Inspection Control Switches

6.2.6.2.1 Moving walks shall be provided with starting switch(es) conforming to the following:

(a) *Location and Design.* The switch(es) shall be

(1) located so that the exposed treadway is within sight.

(2) key operated, of the continuous-pressure spring-return type, and shall be operated by a cylinder-type lock having not less than a five-pin or five-disk combination.

(3) clearly and permanently marked "TOWARDS," "RUN," and "AWAY," in that order, with the key removable only in the "RUN" (spring return) position. The switch(es) shall be rotated clockwise to go from the "TOWARDS" to "RUN" to "AWAY" position.

(b) *Operating Requirements.* The operation of the switch(es) shall initiate movement of the moving walk. The moving walk shall not start (restart) unless all starting switch(es) were first in the "RUN" position.

(c) The starting switch(es) shall be located within reach of an emergency stop button (see 6.2.6.3.1).

(d) The key shall be of Group 2 Security (see 8.1).

6.2.6.2.2 Inspection Control. Each moving walk shall be equipped with inspection controls not accessible to the general public during normal operation to provide constant pressure operation during maintenance, repair, or inspection by means of a manually operated control device.

(a) *General Requirements*

(1) Switches for transferring the control of the moving walk to inspection operation shall be provided or a switch shall be provided at each landing in a portable control station; the switch(es) shall function as follows:

(a) be through a contact that shall be positively opened mechanically and whose opening shall not depend solely on springs

(b) be manually operated

(c) be labeled "INSPECTION"

(d) have two positions, labeled "INSPECTION" or "INSP" and "NORMAL" or "NORM"

(e) when in the "INSPECTION" position, it shall cause the movement of the moving walk to be solely under the control of constant pressure operating devices at that landing or in that portable control station

(f) be arranged so that if more than one inspection transfer switch is in the "INSPECTION" position, then all constant pressure operating devices at all locations shall be inoperative

(g) be protected against accidental contact

(2) Constant pressure operating devices shall

(a) allow movement of the moving walk only by constant application of manual pressure

(b) be distinctly recognizable from indications on the device as to the direction of travel controlled

(c) be protected against accidental contact

(d) be located so that the moving walk treadway surface is within sight

(3) A stop switch conforming to 6.2.6.3.12 shall be provided adjacent to the constant pressure operating devices.

(4) When portable control stations are used, the cord length shall not exceed 3 000 mm (120 in.) in length.

(b) *Plug-in Portable Control Station.* A plug-in portable control station shall be permitted provided that

(1) either a transfer switch conforming to 6.2.6.2.2(a)(1)(a), (a)(1)(b), and (a)(1)(c) is complied with, or when plugged in, the moving walk shall automatically transfer to inspection operation

(2) when the switch, if provided, is in the "INSPECTION" position, or when the control station is plugged in, it shall cause the movement of the moving walk to be solely under the control of constant pressure operating devices contained in the portable unit

(3) the plug-in portable control station is stored at the upper landing machinery space

6.2.6.3 Electrical Protective Devices. Electrical protective devices shall be provided in accordance with 6.2.6.3.1 through 6.2.6.3.12.

6.2.6.3.1 Emergency Stop Buttons

(a) *Location.* A red stop button shall be visibly located at the top and the bottom landings on the right side facing the moving walk. In jurisdictions not enforcing NBCC, remote stop buttons are prohibited. In jurisdictions enforcing NBCC, if remote buttons are provided, they shall be located within view of the moving walk.

(1) On high deck balustrades, they shall be located on the curved newel deck in the upper quadrant, with the centerline of the button at a 45 deg angle from the horizontal.

(2) On low deck balustrades, they shall be located below the handrail height. The centerline of the button shall be located on a radial line 45 deg above the horizontal, such that no part of the button assembly is within 38 mm (1.5 in.) of the bottom of the handrail and the button is no more than 90 mm (3.5 in.) from the bottom of the handrail.

(b) *Cover, Alarm, and Marking.* The buttons shall be covered with a transparent cover that can be readily lifted or pushed aside. When the cover is moved, an audible warning signal shall be activated. The signal shall have a sound intensity of 80 dBA minimum at the button location. The cover shall be marked "EMERGENCY STOP," "MOVE COVER" or equivalent legend (e.g., "LIFT COVER," "SLIDE COVER," etc.), and

“PUSH BUTTON.” “EMERGENCY STOP” shall be in letters not less than 13 mm (0.5 in.) high. Other required wording shall be in letters not less than 4.8 mm (0.188 in.) high. The cover shall be self-resetting.

(c) *Operation.* The operation of either of these buttons shall cause the electric power to be removed from the moving walk driving-machine motor and brake. It shall not be possible to start the moving walk by these buttons.

6.2.6.3.2 Moving-Walk Speed-Monitoring Device.

A moving-walk speed-monitoring device shall be provided.

(a) The operation of the device shall cause the electric power to be removed from the driving-machine motor and brake should the speed exceed the rated speed by more than 20%.

(b) The device shall be of the manual-reset type.

6.2.6.3.3 Broken Treadway Device. A broken treadway device shall be provided that shall cause the electric power to be removed from the driving-machine motor and brake if the connecting means between the pallets or the belt breaks. The device shall be of the manual-reset type.

6.2.6.3.4 Drive-Chain Device. When the driving machine is connected to the main drive shaft by a chain, a device shall be provided that will cause the application of the brake on the main drive shaft and also cause the electric power to be removed from the driving-machine motor and brake if the drive chain between the machine and the main drive shaft becomes disengaged from the sprockets. The device shall be of the manual-reset type.

6.2.6.3.5 Stop Switch in Machinery Spaces. A stop switch conforming to the following requirements shall be provided in each machinery space and other spaces where means of access to the interior space is provided (see 6.2.7.3), except for the machinery space where the main line disconnect switch is located:

(a) when opened (“STOP” position), cause the electric power to be removed from the moving walk driving-machine motor and brake

(b) be of the manually opened and closed type

(c) have red operating handles or buttons

(d) be conspicuously and permanently marked “STOP,” and shall indicate the “STOP” and “RUN” positions

(e) shall have contacts that are positively opened mechanically and their opening shall not be solely dependent on springs

6.2.6.3.6 Moving Walk Egress Restriction Device.

Egress restrictors, if used, that would prevent the free and continuous exiting of passengers, shall provide a signal to a device on the moving walk that shall cause the electric power to be removed from the moving walk driving-machine motor and brake when the exit restrictors begin to close.

6.2.6.3.7 Reversal Stop Device. Means shall be provided to cause the electric power to be removed from the driving-machine motor and brake in case of reversal of travel while the moving walk is operating in the ascending direction. The device shall be of the manual-reset type.

6.2.6.3.8 Disconnected Motor Safety Device. If the drive motor is attached to a gear reducer by means other than a continuous shaft, mechanical coupling, or toothed gearing, a device shall be provided that will cause the electric power to be removed from the driving-machine motor and brake (see 6.2.5.3.1) if the motor becomes disconnected from the gear reducer. The device shall be of the manual-reset type.

6.2.6.3.9 Pallet Level Device. Moving walks equipped with pallets with trail wheels shall be provided with pallet level devices located at the top and bottom of the moving walk. These devices shall detect downward displacement of 3 mm (0.125 in.) or greater at either side of the trailing edge of the pallet. When activated, the device shall cause the moving walk to stop before the pallet enters the combplate. The device shall cause the power to be removed from the driving-machine motor and brake. Devices shall be of the manual-reset type.

6.2.6.3.10 Handrail Entry Device. A handrail entry device shall be provided at each newel. It shall be operative in the newels in which the handrail enters the balustrade. It shall cause the moving walk to stop by removing power from the driving-machine motor and brake. It shall operate in either of two ways

(a) if an object becomes caught between the handrail and the handrail guard

(b) if an object approaches the area between the handrail and handrail guard

For those units that rely on an opening of the balustrade to prevent entrapment, all handrail entry devices shall be operative whenever the handrails are operating. The device shall be of the manual reset type or it shall be permitted to automatically reset not more than one time within 24 hr of operation and thereafter require a manual reset before the next restart. Interruption of power during operation should not cause the device to lose the status of the timer nor the count of events.

6.2.6.3.11 Comb-Pallet Impact Devices. Devices shall be provided that will cause the opening of the power circuit to the moving walk driving-machine motor and brake if either

(a) a horizontal force not greater than 1 780 N (400 lbf) in the direction of travel is applied at either side, or not greater than 3 560 N (800 lbf) at the center of the front edge of the comb-plate; or

(b) a resultant vertical force not greater than 670 N (150 lbf) in the upward direction is applied at the center of the front of the combplate.

These devices shall be of the manual-reset type.

6.2.6.3.12 Stop Switch in Inspection Controls. A stop switch conforming to the following requirements shall be provided when required by 6.2.6.2.2:

- (a) when opened ("STOP" position), cause the electric power to be removed from the moving walk driving-machine motor and brake
- (b) be of the manually opened and closed type
- (c) have red operating handles or buttons
- (d) be conspicuously and permanently marked "STOP," and shall indicate the "STOP" and "RUN" positions
- (e) shall have contacts that are positively opened mechanically and their opening shall not be solely dependent on springs

- (13) **6.2.6.4 Handrail Speed Monitoring Device.** A handrail speed monitoring device shall be provided that will cause the activation of the alarm required by 6.2.6.3.1(b) without any intentional delay whenever the speed of either handrail deviates from the treadway speed by 15% or more. The device shall also cause electric power to be removed from the driving-machine motor and brake when the speed deviation of 15% or more is continuous within a 2 s to 6 s range. The device shall be of the manual reset type or it shall be permitted to automatically reset not more than one time within 24 hr of operation and thereafter require a manual reset before the next restart. Interruption of power during operation should not cause the device to lose the status of the timer nor the count of events.

6.2.6.5 Missing Pallet Device. A device shall be provided to detect a missing pallet and bring the moving walk to a stop before the gap resulting from the missing pallet emerges from the comb. The device shall cause power to be removed from the driving-machine motor and brake. The device shall be of the manual-reset type.

6.2.6.6 Tandem Operation. Tandem-operation moving walks shall be electrically interlocked where traffic flow is such that bunching will occur if the moving walk carrying passengers away from the intermediate landing stops.

The electrical interlocks shall stop the moving walk carrying passengers into the common intermediate landing if the moving walk carrying passengers away from the landing stops. These moving walks shall also be electrically interlocked to assure that they run in the same direction.

6.2.6.7 Moving Walk Smoke Detectors. Smoke detectors shall be permitted, which shall activate the alarm required by 6.2.6.3.1(b) and, after at least 15 s, shall cause the interruption of power to the driving-machine motor and brake.

6.2.6.8 Signs

6.2.6.8.1 Caution Signs. A caution sign shall be located at the top and bottom landings of each moving walk, readily visible to the boarding passengers.

The sign shall include the following wording:

- (a) "Caution"
- (b) "Passengers Only"
- (c) "Hold Handrail"
- (d) "Attend Children"
- (e) "Avoid Sides"

The sign shall be standard for all moving walks and shall be identical in format, size, color, wording, and pictorials as shown in Fig. 6.1.6.9.1.

The sign shall be durable and have a maximum thickness of 6.4 mm (0.25 in.) with rounded or beveled corners and edges.

6.2.6.8.2 Signs or Graphics Relating to Safety. (13)

Signs or graphics relating to safety shall not be permitted on the moving walk in such a manner nor adjacent to the moving walk in such a manner that obstructs boarding passenger view of the signs required in 6.2.6.8.1, physically obstructs passenger flow at the landings as specified in the safety zone (see 6.2.3.8.4), nor obstructs or reduces passenger access to the handrails. They shall be legible and not be distracting, create passenger flow hazards, or impair function of safety devices.

6.2.6.8.3 Additional Signs or Graphics. (13) Signs or graphics other than those specified in 6.2.6.8.1 and 6.2.6.8.2 shall not be permitted adjacent to the walk in such a manner that obstructs boarding passenger view of the signs required in 6.2.6.9.1, obstructs or reduces passenger access to the handrails, within the safety zone, nor on the moving walk except for signs, graphics, or markings required by this Code, manufacturer's identification, owner's identification, and handrail signs or graphics that are permitted on the moving walk. They shall not be distracting, create passenger flow hazards, or impair function of safety devices.

6.2.6.9 Control and Operating Circuits. The design and installation of the control and operating circuits shall conform to 6.2.6.9.1 through 6.2.6.9.4.

6.2.6.9.1 The occurrence of a single ground or the failure of any single magnetically operated switch, contactor, or relay; or any single solid-state device; or a software system failure shall not

- (a) permit the moving walk to start
- (b) render ineffective any electrical protective device required by 6.2.6.3
- (c) render ineffective the handrail speed-monitoring device required by 6.2.6.4
- (d) render ineffective the missing-pallet device required by 6.2.6.5
- (e) permit the moving walk to revert to normal operation when on inspection operation (see 6.2.6.2.2)

NOTE [6.2.6.9.1(b) through (d)]: Requirements apply only to the circuits in which the devices are used and not to the devices themselves.

6.2.6.9.2 Methods used to satisfy 6.2.6.9.1 using software systems are permitted, provided that a non-software-controlled means is also used to remove power from the driving-machine motor and brake.

6.2.6.9.3 Methods used in the control and operating circuits to satisfy the requirements of 6.2.6.9.1 shall be checked prior to each start of the moving walk. When a single ground or failure as specified in 6.2.6.9.1 occurs, the moving walk shall not be permitted to restart.

6.2.6.9.4 Moving walks with driving-machine motors employing static control shall conform to the following:

(a) Two devices shall be provided to remove power from the driving-machine motor. At least one device shall be an electromechanical contactor.

(1) The contactor shall be arranged to open each time the moving walk stops.

(2) The contactor shall cause the removal of power from the driving-machine brake in accordance with 6.2.6.3.4.

(b) An additional contactor shall be provided to also open the driving-machine brake circuit. This contactor is not required to have contacts in the driving-machine motor circuit.

(c) The electrical protective devices required by 6.2.6.3 shall control the solid-state device and both contactors.

(d) After each stop of the moving walk, the moving walk shall not respond to a signal to start unless both contactors [see 6.2.6.9.4(a) and (b)] are in the de-energized position.

6.2.6.10 Electrically Powered Safety Devices. If the handrail-speed monitoring device required by 6.2.6.4, the missing pallet device, required by 6.2.6.5, or any electrical protective device required by 6.2.6.3, requires electrical power for its functioning

(a) a loss of electrical power to the device shall cause power to be removed from the moving walk driving-machine motor and brake

(b) the occurrence of a single ground or the failure of any single magnetically operated switch, contactor, or relay; or any single solid-state device; or a software system failure, shall not render the missing pallet device or handrail speed monitoring device or electrical protective device inoperative

(c) when a single ground or failure as described in 6.2.6.10.2 occurs, the moving walk shall not be permitted to restart

6.2.6.11 Installation of Capacitors or Other Devices to Make Electrical Protective Devices Ineffective. The installation of capacitors, or other devices, the operation or failure of which will cause an unsafe operation of the

moving walk, is prohibited. No permanent device shall be installed, except as provided for in this Code, which will make any required electrical protective device ineffective.

6.2.6.12 Completion or Maintenance of Circuit. The completion or maintenance of an electric circuit shall not be used to stop the moving walk when the emergency stop switch is opened or when any of the electrical protective devices operate. These requirements do not apply to electrically assisted braking or speed control switches (see 6.2.6.3.2, 6.2.6.3.7, and 6.2.6.4).

6.2.6.13 Moving Walk Manual Reset. Where manual reset is required, interruption of power to the moving walk shall not cause a safety device to lose the status of the event upon return of power. The cause of the malfunction shall be indicated in some manner, so that an examination will be made prior to restarting the moving walk. The starting switch shall not be operable until the reset for each activated safety device is accomplished.

6.2.6.14 Contactors and Relays for Use in Critical Operating Circuits. Where electromechanical contactors or relays are provided to fulfill the requirements of 6.2.6.9.1 through 6.2.6.9.4, they shall be considered to be used in critical operating circuits. If the contact(s) on these electromechanical contactors or relays is used for monitoring purposes, it shall be prevented from changing state if the contact(s) utilized in a critical operating circuit fails to open in the intended manner. The monitoring contact(s) shall be positively actuated and shall not be solely dependent upon springs.

6.2.7 Lighting, Access, and Electrical Work

6.2.7.1 Lighting of Machine Room and Truss Interior

6.2.7.1.1 Remote Machine Room. Permanent electric lighting and a duplex receptacle rated at not less than 15 A, 120 V shall be provided in every remote machine room.

The illumination shall be not less than 100 lx (10 fc) at the floor level. The lighting control switch shall be located within easy reach of the access to such rooms and so located that it can be operated without passing over or reaching over any part of the machinery.

6.2.7.1.2 Truss Interior. A duplex receptacle rated at not less than 15 A 120 V accessibly located, shall be provided under the access plates (see 6.2.7.3) at both landings and in any machine areas located within the moving walk.

6.2.7.2 Lighting of Treadway. Treadways shall be illuminated with a light intensity of not less than 50 lx (5 fc). The illumination shall be of uniform intensity and should not contrast materially with that of the surrounding area.

6.2.7.3 Access to Interior. Reasonable access to the interior of the moving walk shall be provided for inspection and maintenance.

6.2.7.3.1 Access plates requiring no more than 310 N (70 lbf) of effort to open shall be provided at the top and bottom landings for inspection and maintenance. The plates shall be made of a material that will afford a secure foothold. The use of stone, terrazzo, or concrete as a fill material is prohibited within the confines of the moving walk truss.

6.2.7.3.2 Access plates at the top and bottom landings shall be securely fastened by a mechanical means.

6.2.7.3.3 If access doors are provided in the side of the moving walk enclosure, they shall be kept closed and locked. The key shall be removable only when in the locked position. The key shall be of Group 2 Security (see 8.1).

6.2.7.3.4 Where access is provided to a machinery enclosure, a fixed guard shall be provided to prevent accidental contact with the moving pallets and moving treadways by a person servicing equipment from within the enclosure. The guard shall be made of material that will reject a 13 mm (0.5 in.) diameter ball and shall extend the full width of the pallet treads. A guard is not required where the only equipment normally serviced from within the enclosure is within the pallet band.

6.2.7.4 Electrical Equipment and Wiring

6.2.7.4.1 All electrical equipment and wiring shall conform to NFPA 70 or CSA-C22.1, whichever is applicable (see Part 9). In jurisdictions enforcing CSA-C22.1, power supply-line disconnecting means shall not be opened automatically by a fire alarm system.

6.2.7.4.2 Electrical equipment shall be listed/certified and labeled/marked. CSA-B44.1/ASME A17.5 defines the scope and applicable requirements for this listing/certification.

6.2.7.4.3 Control equipment shall be tested in accordance with the testing requirements of EN 12016

by exposing it to interference levels at the test values specified for "safety circuits." The interference shall not cause any of the conditions described in 6.2.6.9.1(a) through (e). If enclosure doors or suppression equipment must remain installed to meet the above requirements, warning signs to that effect shall be posted on the control equipment.

6.2.8 Outdoor Moving Walks

6.2.8.1 Weatherproofing. Moving walks shall be so constructed that exposure to the weather will not interfere with normal operation.

6.2.8.1.1 The moving walk equipment and its supports shall be protected from corrosion.

6.2.8.1.2 Electrical equipment shall be provided with a degree of protection of at least Type 4 construction as specified in NEMA 250, and wiring shall be identified for use in wet locations in accordance with NFPA 70 or CSA-C22.1 as applicable (see Part 9).

6.2.8.2 Precipitation. A cover, directly over the horizontal projection of the moving walk, shall be provided. The cover shall extend outward from the centerline of the handrail so that a line extended from the edge of the cover to the centerline of the handrail forms an angle of not less than 15 deg from the vertical.

6.2.8.2.1 When the moving walk is subjected to blowing snow or freezing rain, heating systems shall be operated to prevent accumulation of snow or ice on the treadway and landings. The heating systems operation shall be thermostatically controlled and independent of the moving walk operation.

6.2.8.2.2 Drains suitable for all weather conditions shall be provided to prevent the accumulation of water where groundwater and runoff can collect within the equipment. (13)

6.2.8.3 Slip Resistance. Landing plates and comb-plates shall be designed to provide a secure foothold when wet.

Part 7

Dumbwaiters and Material Lifts

SCOPE

Part 7 applies to dumbwaiters and material lifts.

NOTE: See also Part 8 for additional requirements that apply to *dumbwaiters and material lifts*.

Where the term “elevator” is used in a referenced requirement, it shall mean “dumbwaiter” or “material lift.”

SECTION 7.1

POWER AND HAND DUMBWAITERS WITHOUT AUTOMATIC TRANSFER DEVICES

Requirement 7.1 applies to all power and hand dumbwaiters without automatic transfer devices.

7.1.1 Construction of Hoistways and Hoistway Enclosures

The construction of hoistways and hoistway enclosures shall comply with 2.1, except as modified by 7.1.1.1 through 7.1.1.4.

7.1.1.1 Requirement 2.1.1.1 applies, except where dumbwaiters are installed in a private residence. In private residences, fire-resistive construction shall conform to the requirements of the building code.

7.1.1.2 Requirement 2.1.2.1 does not apply. Where a hoistway extends into the top floor of a building, the hoistway or machinery space enclosures, where required, shall be constructed in accordance with the requirements of the building code (see 1.3).

7.1.1.3 Requirement 2.1.3.1 does not apply. If a floor is provided at the top of the hoistway, it shall comply with 7.1.1.4.

7.1.1.4 Requirement 2.1.3.2 does not apply. The floor shall be designed in accordance with other floors in the building. Where the dumbwaiter machine is to be supported by machine room floor, the floor shall be designed in accordance with 2.9.4 and 2.9.5.

7.1.2 Pits

Pits are not required, but shall be permitted. Where a pit is provided, it shall conform to 2.2, except as modified by 7.1.2.1 through 7.1.2.6.

7.1.2.1 Requirement 2.2.1 does not apply. Pits shall be permitted to be provided.

7.1.2.2 Requirement 2.2.4 does not apply. The access door shall be provided with an electric contact, which will cause the interruption of power to the motor and brake when the door is open.

7.1.2.3 Requirement 2.2.5 does not apply. If the level of illumination in the pit, where provided, does not meet the requirements of 2.2.5, then a permanent or portable lighting means complying with 2.2.5.1 shall be provided.

7.1.2.4 Requirement 2.2.6 applies only where pit access is provided by means of a ladder (see 2.2.4.2).

7.1.2.5 Requirement 2.2.7 does not apply.

7.1.2.6 Requirement 2.2.8 does not apply.

7.1.3 Location and Guarding of Counterweights

Requirement 2.3 does not apply to the location and guarding of counterweights, except that the location of counterweight shall comply with 2.3.1.

7.1.4 Vertical Car Clearances and Runbys for Cars and Counterweights

Requirement 2.4 does not apply. Bottom and top car clearances and runbys for cars and counterweights shall conform to 7.1.4.1 through 7.1.4.2.

7.1.4.1 When the car or counterweight reaches its maximum limit of downward travel, no part of the car or counterweight or any equipment attached thereto shall strike any part of the pit or floor beneath the lowest landing or equipment located in the hoistway, except a buffer or bumper.

7.1.4.2 When the car or counterweight reaches its maximum limit of upward travel, no part of the car or counterweight or any equipment attached thereto shall strike any part of the overhead structure or equipment located in the hoistway, except a mechanical stop or buffer.

7.1.4.3 Where a top-of-car operating device is provided, a minimum vertical space shall be provided on the car top when the car reaches its maximum limit of upward travel. The space shall comply with 7.1.4.3.1 and 7.1.4.3.2.

7.1.4.3.1 Horizontal unobstructed area on the car top of not less than 0.370 m² (570 in.²) and measured not less than 500 mm (20 in.) on one side, and

7.1.4.3.2 Vertical height of not less than 1 100 mm (43 in.) measures vertically between the top of the car enclosure and the overhead structure or other obstruction.

7.1.5 Horizontal Car and Counterweight Clearances

Horizontal car and counterweight clearances shall conform to 2.5, except as modified by 7.1.5.1 through 7.1.5.4.

7.1.5.1 Requirement 2.5.1.1 applies for dumbwaiters with rated load over 227 kg (500 lb). For dumbwaiters with a rated load of 227 kg (500 lb) or less, the clearance between the car and hoistway enclosure shall be not less than 13 mm (0.5 in.).

7.1.5.2 Requirement 2.5.1.2 applies for dumbwaiters with a rated load over 227 kg (500 lb). For dumbwaiters with a rated load of 227 kg (500 lb) or less, clearances between the car and counterweight shall be not less than 13 mm (0.5 in.).

7.1.5.3 Requirement 2.5.1.4 applies, except when a counterbalanced car door is provided. The clearance shall be measured between the landing side of the car door sill and the hoistway edge of any landing sill, or the hoistway side of any vertically sliding counterweighted or counterbalanced hoistway door or of any vertically sliding counterbalanced biparting hoistway door sill.

7.1.5.4 Requirement 2.5.1.5 does not apply.

7.1.6 Protection of Spaces Below Hoistway

Requirement 2.6 applies, except as modified by 7.1.6.1 through 7.1.6.3.

7.1.6.1 Car and counterweight safeties shall be provided conforming to 7.2.4.

7.1.6.2 Buffers shall be provided conforming to 7.2.8.1 or 7.2.8.2.

7.1.6.3 Direct-plunger hydraulic dumbwaiters shall conform to 3.6.

7.1.7 Machinery Spaces, Machine Rooms, Control Spaces, and Control Rooms

Machinery spaces, machine rooms, control spaces, and control rooms shall comply with 2.7, except as modified by 7.1.7.1 through 7.1.7.11.

7.1.7.1 Requirement 2.7.1.1 applies only where a separate machinery space is provided.

7.1.7.2 Requirement 2.7.1.2 applies only where a separate machinery space is provided.

7.1.7.3 Dumbwaiter machine rooms shall conform to 2.7.2, or the following:

(a) Guards on dumbwaiter equipment shall prevent accidental contact with moving parts and shall permit visual inspection without complete removal.

(b) Where a dumbwaiter machine is located at the bottom of the hoistway, the control equipment shall be located outside the hoistway or in a cabinet on the inside surface of the access door.

7.1.7.4 Requirement 2.7.3.1 does not apply. A means of access to dumbwaiter machine rooms and overhead machinery spaces shall be provided, from outside the hoistway, for elevator personnel.

7.1.7.5 Requirement 2.7.3.3 applies only where a machine room or control room is provided for machine and control equipment.

7.1.7.6 Access doors and openings shall conform to 2.7.3.4 except as modified by 7.1.7.6.1 and 7.1.7.6.2.

7.1.7.6.1 Requirements 2.7.3.4.3, 2.7.3.4.4, and 2.7.3.4.5 do not apply.

7.1.7.6.2 Requirement 2.7.3.4.6 applies, except the maximum width of an access opening located not more than 1 525 mm (60 in.) above the lowest point of the hoistway, contiguous to and in vertical alignment with a hoistway entrance, shall be the lesser of 1 220 mm (48 in.) or the hoistway entrance width.

Hoistway access openings shall be provided with an electric contact that will cause interruption of power to the motor and brake when the access door is open.

7.1.7.7 Requirement 2.7.3.5 does not apply.

7.1.7.8 Requirement 2.7.4 does not apply.

7.1.7.9 Lighting, temperature, and humidity shall conform to 2.7.9, except 2.7.9.2 does not apply. Where there is a machine room, it shall be provided with natural or mechanical ventilation to avoid overheating of the electrical equipment to ensure normal operation of the dumbwaiter.

7.1.7.10 Requirement 2.7.6 does not apply.

7.1.7.11 Requirement 2.7.8.4 does not apply.

7.1.8 Electrical Equipment, Wiring, Pipes, Ducts, and HVAC in Hoistways and Machine Rooms

Electrical equipment, pipes, and ducts in hoistways, machine rooms, and machinery spaces shall comply with 2.8, except as modified by 7.1.8.1 and 7.1.8.2.

7.1.8.1 Type SF or equivalent wire is not required for the wiring to the hoistway door interlock from the hoistway riser.

7.1.8.2 Requirement 2.8.1 does not apply. Dumbwaiter machine and control equipment shall be permitted to be located in a room or space containing other equipment essential to the operation of the building, provided that all exposed moving parts are guarded.

7.1.8.3 Requirement 2.8.3.3 does not apply. Sprinklers shall be permitted in the hoistway when conforming to NFPA 13 or the NBCC, whichever is applicable (see Part 9). All sprinkler risers and returns shall be located outside the hoistway.

7.1.9 Machinery and Sheave Beams, Supports, and Foundations

Machinery and sheave beams, supports, and foundations shall comply with 2.9, except as modified by 7.1.9.1 and 7.1.9.2.

7.1.9.1 Requirement 2.9.3.1 does not apply.

7.1.9.2 Machines and equipment directly over the hoistway shall be permitted to be hung underneath the supporting beams at the top of the hoistway.

7.1.9.3 Requirement 2.9.3.2 applies to the machine or sheave connections between the machine or sheave and the beams, foundations or floor, and machinery that is hung underneath beams.

7.1.9.4 Requirement 2.9.3.3.1 does not apply. Machines, sheaves, equipment, and hitches shall be permitted to be secured to and supported by the guide rails and structural walls.

7.1.10 Guarding of Equipment

Requirement 2.10 does not apply, except that the guarding of equipment shall comply with 2.10.1. Hand and power dumbwaiter machines and sheaves shall be permitted to be located inside the hoistway enclosure at the top or bottom without intervening enclosures or platforms.

7.1.11 Protection of Hoistway Openings

The protection of hoistway openings shall conform to 2.11, except as modified by 7.1.11.1 through 7.1.11.14.

7.1.11.1 Entrances. Requirement 2.11.1 does not apply. All hoistway-landing openings shall be provided with entrances that shall guard the full height and width of the opening.

7.1.11.1.1 For power dumbwaiters, the doors shall not open to a 25 mm (1 in.) greater width and height than the width and height of the car, unless the car is being removed or installed.

7.1.11.1.2 For hand dumbwaiters, the width of the door openings shall not exceed the width of the car by more than 150 mm (6 in.). The height of the door shall not exceed 1 375 mm (54 in.).

7.1.11.2 Types of Entrances. Requirement 2.11.2 does not apply.

7.1.11.2.1 For power dumbwaiters, entrances shall be one of the following types:

- (a) horizontal slide, single- or multi-section
- (b) swing, single section
- (c) combination horizontal slide and swing
- (d) vertical slide biparting counterbalanced

(e) vertical slide counterweighted, single- or multi-section

7.1.11.2.2 For hand dumbwaiters, entrances shall be one of the following types:

- (a) manually operated vertical slide counterweighted, single- or multi-section
- (b) manually operated vertical slide biparting counterbalanced
- (c) manually operated swing, single-section

7.1.11.3 Closing of Hoistway Doors. Requirement 2.11.3 does not apply.

7.1.11.3.1 For power dumbwaiters, all doors shall be kept closed, except the door at the floor at which the car is being loaded or unloaded.

7.1.11.3.2 For hand dumbwaiters

(a) all doors shall be kept closed, except the door at the floor at which the car is being loaded, unloaded, or operated

(b) each entrance shall have conspicuously displayed on the landing side, above the door opening, in letters not less than 50 mm (2 in.) high, the words: "DANGER — DUMBWAITER — KEEP CLOSED"

(c) all doors shall be equipped with devices to close them automatically when the devices are actuated by heat or smoke

7.1.11.4 Location of Hoistway Door Openings. (13) Requirement 2.11.4 does not apply.

7.1.11.4.1 The bottom of the hoistway-door opening shall be not less than 600 mm (24 in.) above the floor, except for power dumbwaiters' applications conforming to 7.1.12.1.2 or 7.1.12.1.3. (13)

7.1.11.4.2 Horizontally sliding or swinging doors shall be so located that the distance from the hoistway face of the doors to the edge of the hoistway landing sill, measured from the face of the door section nearest to the car, shall not be more than 75 mm (3 in.) for horizontally sliding or single-section swinging doors. (13)

7.1.11.5 Hoistway Access Doors. Access openings shall be permitted to be provided in the hoistway enclosure for maintenance and inspection. Access openings when provided shall conform to 7.1.7.5.

7.1.11.6 Projection of Equipment Beyond Landing Sills. Requirement 2.11.5 does not apply.

7.1.11.7 Opening of Hoistway Doors From Hoistway Side. Requirement 2.11.6 does not apply.

7.1.11.8 Hoistway Door Vision Panels. Hoistway door vision panels (see 2.11.7) are not required. Where provided, they shall comply with 2.11.7.1.2, 2.11.7.1.3, 2.11.7.1.4, and 2.11.7.1.6, and the total area of one or more vision panels in any hoistway door shall not exceed 0.016 m² (25 in.²).

7.1.11.9 Hoistway Door Locking Devices and Power Operation. Requirement 2.11.9 does not apply. Doors shall be provided with door-locking devices conforming to 7.1.12. Where hoistway doors are power operated or are opened or closed by power, they shall conform to 7.1.13.

7.1.11.10 Landings and Landing Sills. Requirement 2.11.10.1 does not apply.

7.1.11.11 Horizontal Slide-Type Entrances. Requirement 2.11.11.1(b) does not apply.

7.1.11.12 Vertical Slide-Type Entrances. Requirements 2.11.12.1, 2.11.12.2, 2.11.12.3, 2.11.12.7, and 2.11.12.8 do not apply.

7.1.11.12.1 Landing sills shall be of metal, securely fastened to the frame or building structure and of sufficient strength to support the rated load of the dumbwaiter, applied vertically over an area of 100 mm × 100 mm (4 in. × 4 in.) at the center of the sill, with no permanent displacement or deformation of the sill.

7.1.11.12.2 Either the panel guide rails or the jambs used to frame the opening shall be securely anchored to a masonry wall, or securely fastened to the building structure or wall-supporting members.

7.1.11.12.3 Panel guide rails, not fastened in conformance with 7.1.11.12.2, shall be securely fastened to the jambs at intervals throughout the frame height, and shall be permitted to be fastened to the building structure where the rails extend past the frame. Rails and their fastenings shall withstand the forces specified in 7.1.11.12.1, and any reactions resulting from the loading and unloading operations, that are capable of being transmitted to the rails.

7.1.11.12.4 Requirement 2.11.12.4.2 applies only where truckable sills are required.

7.1.11.12.5 Requirements 2.11.12.4.3(a) and (b) do not apply. Panels of biparting counterbalanced entrances shall conform to the following:

(a) They shall be provided with means to stop the closing panels when the distance between the closing rigid members of the upper and lower panels is not less than 20 mm (0.8 in.)

(b) A fire-resistive, nonshearing, and noncrushing member of either the meeting or overlapping type shall be provided on the upper panel to close the distance between the rigid door panels when in contact with the stops.

7.1.11.12.6 Requirement 2.11.12.4.4 applies, except that the overlap shall be not less than 13 mm (0.5 in.).

7.1.11.12.7 Requirement 2.11.12.4.6 does not apply. The entrance assembly shall be capable of withstanding a force of 1 110 N (250 lbf) applied on the

landing side at right angles to, and approximately at the center of a panel. This force shall be distributed over an area of approximately 100 mm × 100 mm (4 in. × 4 in.). There shall be no appreciable permanent displacement or deformation of any parts of the entrance assembly resulting from this test.

7.1.11.12.8 Requirement 2.11.12.5.3 does not apply. Guide members shall be designed to withstand the forces specified in 7.1.11.12.7.

7.1.11.12.9 Requirement 2.11.12.6 does not apply to hand-operated dumbwaiters covered in 7.1.11.3.

7.1.11.13 Swing-Type Entrances. For swing-type entrances, 2.11.13 applies, except as modified by 7.1.11.3.1 through 7.1.11.13.3.

7.1.11.13.1 Requirements 2.11.13.1(b) and 2.11.13.3.3 do not apply.

7.1.11.13.2 Requirement 2.11.13.3.5 does not apply. The panels and their assembled accessories shall be capable of withstanding normal attempts to open a closed and locked door by pulling the handle. The panel shall be so designed to withstand a force of 1 110 N (250 lbf) applied on the landing side at right angles to and approximately at the center of the panel. This force shall be distributed over an area of approximately 100 mm × 100 mm (4 in. × 4 in.). There shall be no appreciable permanent displacement or deformation of any parts of the entrance assembly resulting from this force.

7.1.11.13.3 Requirement 2.11.13.3.7 applies, except it shall be in conformance with 7.1.11.13.1.

7.1.11.14 Marking. Marking (see 2.11.15) shall apply, except as modified by 7.1.11.14.1 and 7.1.11.14.2.

7.1.11.14.1 Requirement 2.11.15.1.1(c) does not apply.

7.1.11.14.2 Requirement 2.11.15.1.2(b) applies, except it shall be in conformance with 2.11.11.5.1 and 2.11.11.5.2 or 7.1.11.12.6.

7.1.12 Hoistway Door Locking Devices, Access Switches, and Unlocking Devices

Hoistway door locking devices, access switches, and unlocking devices shall comply with 7.1.12. Requirement 2.12 does not apply, except as referenced in 7.1.12.

7.1.12.1 Hoistway Door Locking Devices for Power Dumbwaiters. Hoistway door locking devices for power dumbwaiters shall comply with 7.1.12.1.1 through 7.1.12.1.3.

7.1.12.1.1 Hoistway door interlocks in conformance with 7.1.12.1.3 are required at all landings, except that hoistway door combination mechanical locks and

electric contacts conforming to 7.1.12.1.2 shall be permitted to be used at the following landings:

- (a) at landings where the bottom of the door opening is 600 mm (24 in.) or more above the floor
- (b) the top terminal landing and the landing located not more than 1 220 mm (48 in.) below the top terminal landing, provided that the dumbwaiter rise does not exceed 4 570 mm (180 in.)
- (c) any landing whose sill is within 1 525 mm (60 in.) of the pit floor, regardless of the dumbwaiter rise

7.1.12.1.2 Hoistway door combination mechanical locks and electric contacts, where provided, shall conform to the following:

- (a) requirement 2.12.3.2
- (b) requirement 2.12.3.3
- (c) requirement 2.12.3.4, except that
 - (1) requirement 2.12.3.4.4 applies to all types of multisection doors
 - (2) requirement 2.12.3.4.5 applies but the force used should be 225 N (50 lbf)
- (d) requirement 2.12.3.5
- (e) requirement 2.12.4
- (f) arranged so that the hoistway door is locked when the car is more than 75 mm (3 in.) from the landing

7.1.12.1.3 Hoistway door interlocks, where provided, shall conform to the following:

- (a) requirement 2.12.2.2
- (b) requirement 2.12.2.3
- (c) requirement 2.12.2.4, except that
 - (1) requirement 2.12.2.4.1 does not apply.
 - (2) requirement 2.12.2.4.6 applies but the force used shall be 225 N (50 lbf)
- (d) requirement 2.12.2.5
- (e) requirement 2.12.2.6
- (f) requirement 2.12.4

7.1.12.2 Hoistway Door Locking Devices for Hand Dumbwaiters. Hoistway doors shall be provided with spring-type latches to hold them in the closed position. Such latches shall be releasable from both the hoistway and landing side, irrespective of the position of the car.

7.1.12.3 Hoistway Door Unlocking Devices.

Hoistway door unlocking devices conforming to 2.12.6.2.1, 2.12.6.2.2, 2.12.6.2.4, and 2.12.6.2.5 shall be provided at the top and bottom terminal landings.

- (13) **7.1.12.4 Hoistway Access Switches.** Hoistway access switches shall be permitted at the top and bottom landing. Requirement 2.12.7 does not apply. Where hoistway access switches are provided, they shall conform to the following requirements:
- (a) Requirement 2.12.7.2 applies.
 - (b) Requirement 2.12.7.3 applies, except 2.12.7.3.2(b) does not apply.

7.1.13 Power Operation of Hoistway Doors and Car Doors or Gates

The power operation, power opening, and power closing of hoistway doors and car doors or gates shall comply with 2.13, except as modified by 7.1.13.1 through 7.1.13.9.

7.1.13.1 Requirement 2.13.2.1.2 does not apply.

7.1.13.2 Requirement 2.13.2.2.3 does not apply.

7.1.13.3 Requirement 2.13.3.1 does not apply.

7.1.13.4 Requirements 2.13.3.2.3 and 2.13.3.2.4 do not apply. A closing means shall not be provided in the car.

7.1.13.5 Requirement 2.13.3.3.2 does not apply.

7.1.13.6 Requirement 2.13.3.4.2 does not apply; sequence operation is not required, however, if provided, it shall conform to 2.13.6.2. Requirement 2.13.3.4.3 does not apply when the only means for controlling the door is by a momentary-pressure switch at the landing within sight of the door, that, when operated, shall cause the doors to stop or to stop and reopen. Requirement 2.13.3.4.4 does not apply.

7.1.13.7 Requirement 2.13.4 also applies to power-operated vertically sliding doors. Requirements 2.13.4.2.3 and 2.13.4.2.4 do not apply.

7.1.13.8 Requirement 2.13.5 applies only to power-operated hoistway doors and car doors or gates where closing is by automatic means. Requirement 2.13.5.4 does not apply.

7.1.13.9 Requirement 2.13.6 does not apply.

7.1.14 Identification

Requirement 2.29 does not apply. When the machinery of more than one dumbwaiter is in the machine room, each driving machine shall be assigned a different number that shall be painted on or securely attached to the driving machine.

**SECTION 7.2
ELECTRIC AND HAND DUMBWAITERS WITHOUT
AUTOMATIC TRANSFER DEVICES**

Requirement 7.2 applies to electric and hand dumbwaiters without automatic transfer devices.

7.2.1 Car Enclosures, Car Doors and Gates, and Car Illumination

Car enclosures and car doors and gates shall comply with 2.14, except as modified by 7.2.1.1 through 7.2.1.3.

7.2.1.1 Car Enclosures

7.2.1.1.1 Requirement 2.14.1.2 does not apply. The enclosure shall be securely fastened to the car platform or the point of suspension.

7.2.1.1.2 Requirement 2.14.1.3 does not apply. The car enclosure walls shall be of solid, grille, or perforate construction. Car enclosure walls shall be of such strength and so designed and supported that when subjected to a leaning or falling rated load on the car, the car enclosure walls will not deflect or deform to the extent that the running clearances are reduced below the minimum specified in 7.1.5. Grilled or perforated portions of the enclosure shall reject a ball 38 mm (1.5 in.) in diameter. Nonmetal cars shall be reinforced with metal from the bottom of the car to the point of suspension. Metal car sections shall be riveted, welded, or bolted together. Cars shall be permitted to be provided with hinged, permanent, or removable shelves. The maximum inside height of the car at any point shall not exceed 1 220 mm (48 in.) (see also 7.2.3). Hinged or removable panels shall not be provided in car tops.

7.2.1.1.3 Requirement 2.14.1.4 does not apply.

7.2.1.1.4 Requirement 2.14.1.5 does not apply.

7.2.1.1.5 Requirement 2.14.1.6 does not apply. Car tops shall be capable of sustaining a load of 3.5 kPa (75 lbf/ft²) without permanent deformation. The resulting deflection under this load shall be limited to prevent damage to any equipment, device, or lighting assemblies fastened to or adjacent to the car enclosure top.

7.2.1.1.6 Requirement 2.14.1.7.1 does not apply.

7.2.1.1.7 Requirement 2.14.1.8 does not apply.

7.2.1.1.8 Requirement 2.14.1.9 does not apply.

7.2.1.1.9 Requirement 2.14.1.10 does not apply.

7.2.1.1.10 Requirement 2.14.2 does not apply. Vision panels are not required. Where provided, the perforated portions shall reject a ball 38 mm (1.5 in.) in diameter. Glass vision panels shall be either laminated or wire glass and shall not exceed 0.016 m² (25 in.²).

7.2.1.1.11 Requirement 2.14.3 does not apply.

7.2.1.2 Car Doors and Gates. Car doors or gates shall be provided at entrances to the car, shall guard the full width of the opening, and shall conform to 7.2.1.2.1 through 7.2.1.2.12.

7.2.1.2.1 Requirement 2.14.4.1 does not apply.

7.2.1.2.2 Requirement 2.14.4.2 does not apply. Each door or gate shall be equipped with a contact that will prevent operation of the driving machine, unless the door or gate panel(s) is in the closed position as defined in 2.12.2.2(c) or 2.12.3.2.

7.2.1.2.3 Requirement 2.14.4.3 does not apply. Car doors shall be of the horizontal or vertical sliding type and of material conforming to 7.2.1.1.2.

7.2.1.2.4 Requirement 2.14.4.4 does not apply. Gates shall be of the horizontally sliding collapsible type or of the vertically sliding type.

(a) Horizontally sliding collapsible gates shall conform to the following:

(1) they shall not be power operated, except as permitted by 2.13.2.1.2

(2) they shall not be used with power-operated vertically sliding hoistway doors

(3) when fully closed (extended position), they shall reject a ball 113 mm (4.5 in.) in diameter

(4) they shall have at least every fourth vertical member guided at the top and every second vertical member guided at the bottom

(5) collapsible gate handles shall be provided with finger guards

(b) Vertically sliding type gates shall conform to the following:

(1) they shall be of the balanced counterweighted type or the biparting counterbalanced type

(2) they shall reject a ball 50 mm (2 in.) in diameter

(3) balanced counterweighted gates shall be permitted to be either single- or multi-section and permitted to slide either up or down to open

(4) they shall be permitted to be either manually or power operated

7.2.1.2.5 Requirement 2.14.4.5 does not apply.

7.2.1.2.6 Requirement 2.14.4.6 applies, except that the forces applied shall be not greater than the weight of the rated load or that specified in 2.14.4.6, whichever is less.

7.2.1.2.7 Requirement 2.14.4.7 does not apply.

7.2.1.2.8 Requirement 2.14.4.9 does not apply. Suspension members of vertically sliding car doors or gates, and of weights used with car doors or gates, shall have a factor of safety of not less than 5.

7.2.1.2.9 Requirement 2.14.4.10 applies, except that they shall conform to 7.1.13 instead of 2.13.

7.2.1.2.10 Requirement 2.14.5 does not apply.

7.2.1.2.11 Requirement 2.14.6 does not apply.

7.2.1.2.12 Where car door or gate horizontal structural members are not fixed to the moveable panel, they shall not be capable of entering into the access door area.

7.2.1.3 Lighting Fixtures. Requirement 2.14.7 does not apply; however, if lighting is provided in the car, it shall conform to 2.14.7.3 and 2.14.7.4.

7.2.2 Car Frames and Platforms

Car frames and platforms shall comply with 2.15, except as modified by 7.2.2.1 through 7.2.2.14.

7.2.2.1 Requirement 2.15.1 does not apply.

7.2.2.2 Requirement 2.15.2 does not apply. Cars shall be guided on each guide rail by upper and lower guiding members.

7.2.2.3 Requirement 2.15.3 applies, except that frames are not required.

7.2.2.4 Requirement 2.15.5 does not apply. The car shall be provided with a platform capable of withstanding the loading conditions for which the dumbwaiter is designed.

7.2.2.5 Requirements 2.15.6.1.2 and 2.15.6.1.3 do not apply. Requirements 2.15.6.1.1 and 2.15.6.1.4 apply only where car frames and car platform frames are used.

7.2.2.6 Requirement 2.15.7.3 does not apply.

7.2.2.7 Requirement 2.15.8 does not apply.

7.2.2.8 Requirement 2.15.9 does not apply. Leveling devices are not required. Guards shall be provided to close any opening to the hoistway above and below the car that occur when leveling or inching devices are operated with the hoistway door(s) in the open position.

7.2.2.8.1 The guards shall

- (a) be located on the entrance side of the car
- (b) extend the full width of the car
- (c) be made of smooth metal plates of not less than 1.5 mm (0.059 in.) thick steel or material of equivalent strength, stiffness, and braced to the car

7.2.2.8.2 The guards shall have a straight vertical face, extending not less than the following:

- (a) for the car platform guard, the maximum length of the car travel in the up direction permitted by the car leveling or inching device as installed, plus 13 mm (0.5 in.)
- (b) for car head guard, the maximum length of the car travel in the down direction permitted by the car leveling or inching device as installed, plus 13 mm (0.5 in.)

7.2.2.9 Requirement 2.15.11 does not apply.

7.2.2.10 Requirement 2.15.12 does not apply.

7.2.2.11 Requirement 2.15.13 does not apply.

7.2.2.12 Requirement 2.15.14 does not apply.

7.2.2.13 Requirement 2.15.15 does not apply.

7.2.2.14 Requirement 2.15.16.1 applies, except that either hinged platform sill electric contact or car door electric contacts shall prevent operation of the car if the sill is not retracted.

7.2.3 Capacity and Loading

Requirement 2.16 does not apply to dumbwaiters.

7.2.3.1 Rated Load and Platform Area. The rated load shall be not less than 221 kg/m³ (13.9 lb/ft³) of the

inside net car volume. The inside net platform area shall be not more than 1 m² (10.75 ft²).

7.2.3.2 Capacity Plate. A metal capacity plate shall be fastened in a conspicuous place in the car and shall indicate the rated load in letters and numerals not less than 6 mm (0.25 in.) high, stamped, etched, or raised on the surface of the plate.

7.2.3.3 Data Plate

7.2.3.3.1 A data plate shall be located on the car crosshead, on the car top, or inside the car. If the information required on the data plate is provided on the capacity plate inside the car (see 7.2.3.2), then a separate data plate is not required on the car top or crosshead.

7.2.3.3.2 The data plate shall indicate

- (a) the weight of the complete car including the car safety and all auxiliary equipment attached to the car
- (b) the rated load and rated speed
- (c) the suspension means (see 7.2.6)
- (d) the manufacturer's name and date of installation

7.2.3.3.3 The letters and numerals on the data plate shall be not less than 3 mm (0.125 in.) high, stamped, etched, or raised on the surface of the plate.

7.2.3.4 "No Riders" Signs. A sign stating "NO RIDERS" shall be located in the car in letters not less than 13 mm (0.5 in.) high.

7.2.4 Car and Counterweight Safeties

Car and counterweight safeties, where provided, shall conform to 2.17, except as modified by 7.2.4.1 through 7.2.4.8.

7.2.4.1 Where Required and Located. Requirement 2.17.1 does not apply. Where required by 7.1.6, the car shall be provided with one or more safety devices identified in 2.17.5. Car safeties shall be attached to the supporting structure of the car.

7.2.4.2 Function and Stopping Distances. Requirement 2.17.3 does not apply. The safety device shall be capable of stopping and sustaining the entire car with its rated load, within the maximum stopping distances as determined in Tables 2.17.3 and 8.2.6.

7.2.4.3 Reserved for Future Use. Requirement 2.17.6 does not apply.

7.2.4.4 Governor-Actuated Safeties and Car Safety Mechanism Switches. Requirement 2.17.7 does not apply. Car and counterweight safeties shall be actuated by speed governors or as a result of breaking or slackening of the suspension means, and shall be permitted to be of the inertia type without governors.

Every car safety shall be provided with a switch, operated by the car safety mechanism. This switch shall conform to 2.18.4, except that the switch does not have

to be on the safety, provided that it is operated by the action of the safety.

7.2.4.5 Limits of Use of Various Types of Safeties.

Requirement 2.17.8 applies, except that Type A safeties shall be permitted to be used regardless of the rated speed.

7.2.4.6 Application of Safeties. The application of safeties shall conform to 2.17.9.1, 2.17.9.2, and 2.17.9.3. The forces providing the stopping action shall conform to 2.17.9.4 or 7.2.4.6.1.

7.2.4.6.1 Where guide-rail sections other than those specified in 2.23.3(a) are used, the application of safety stopping forces shall not cause deformation of the guide-rail section upon whose dimensional stability the stopping capability of the safeties is dependent.

7.2.4.7 Marking Plates for Safeties. Requirement 2.17.14 applies only for governor-operated safeties.

7.2.4.8 Rail Lubricants. Requirement 2.17.16 applies only where safeties are provided.

7.2.5 Speed Governors

Speed governors are not required. Where provided, they shall conform to 2.18, except that the diameter of the governor rope (see 2.18.5.1) shall be permitted to be less than 9.5 mm (0.375 in.), however, it shall be not less than the diameter of the suspension ropes.

7.2.6 Suspension Means

Suspension means shall comply with 2.20, except as modified by 7.2.6.1 through 7.2.6.8.

7.2.6.1 Type of Suspension Means. Requirement 2.20.1 does not apply.

7.2.6.1.1 Power Dumbwaiters

(a) Cars and counterweights for power dumbwaiters, except for dumbwaiters having rack-and-pinion or screw-type driving machines, shall be suspended by one or more iron or steel-wire hoisting ropes or chains.

(b) Wire ropes shall be permitted to have marlin covers.

(c) Chains, where used, shall be roller, block, or multiple-link silent type.

7.2.6.1.2 Hand Dumbwaiters

(a) Dumbwaiters having a rated load exceeding 35 kg (75 lb) shall be suspended by steel wire ropes or chains having a factor of safety of not less than 4.5.

(b) Dumbwaiters having a rated load 35 kg (75 lb) or less shall be permitted to be suspended by manila, braided-cotton, or equivalent ropes having a factor of safety of not less than 6.

7.2.6.2 Rope Data. Requirement 2.20.2 only applies to dumbwaiters suspended by wire or non-wire rope. The information required in 2.20.2.1 shall be located

Table 7.2.6.4 Factors of Safety for Wire Rope and Chains

| Rope or Chain Speed, m/s (ft/min) | Factor of Safety | |
|--------------------------------------|------------------|--------|
| | Ropes | Chains |
| 0.25 (50) | 4.8 | 6.0 |
| 0.50 (100) | 5.2 | 6.5 |
| 0.75 (150) | 5.5 | 6.9 |
| 1.00 (200) | 5.9 | 7.4 |
| 1.25 (250) | 6.2 | 7.8 |
| 1.50 (300) | 6.6 | 8.3 |
| 1.75 (350) | 7.0 | 8.8 |
| 2.00 (400) | 7.3 | 9.1 |
| 2.25 (450) | 7.7 | 9.6 |
| 2.50 (500) | 8.0 | 10.0 |

on the car crosshead, on the car top, or inside the car. Requirement 2.20.2.2(j) does not apply.

7.2.6.3 Chain Data

7.2.6.3.1 The data plate required by 7.2.3.3 shall bear the following chain data:

- (a) number of chains
- (b) type of chains
- (c) standard chain number
- (d) the manufacturer's rated breaking strength per chain in pounds

7.2.6.3.2 A metal data tag shall be securely attached to one of the chain fastenings. This data tag shall bear the following chain data:

- (a) type of chain
- (b) standard chain number
- (c) manufacturer's rated breaking strength
- (d) month and year the chains were installed
- (e) name of the person or firm who installed the chains
- (f) name of the manufacturer of the chains

7.2.6.3.3 A new tag shall be installed at each chain renewal. The material and marking of the chain data tag shall conform to 2.16.3.3, except that the height of the letters and figures shall be not less than 1.6 mm (0.063 in.).

7.2.6.4 Factors of Safety. Requirement 2.20.3 does not apply. The factor of safety, based on the static load, of car and counterweight suspension means shall be not less than the value specified in Table 7.2.6.4 for actual speed of rope or chain corresponding to the rated speed of the dumbwaiter.

7.2.6.5 Number of Ropes or Chains Required. Requirement 2.20.4 does not apply. The number of suspension ropes or chains shall be determined by multiplying the static load (weight of the car plus rated load plus the weight of the hoisting ropes or chains) by the

required factor of safety, and dividing the result by the manufacturer's

(a) rated ultimate strength of one of the ropes of the size and construction to be used

(b) average tensile strength of one of the chains of the size and construction to be used

Where 2:1 roping is used, one-half the static load shall be used in the formula.

7.2.6.6 Suspension-Rope Equalizers. Requirement 2.20.5 does not apply.

7.2.6.7 Splicing and Replacement of Suspension Ropes. Requirement 2.20.8 does not apply.

7.2.6.8 Fastening of Suspension Means

7.2.6.8.1 Requirement 2.20.9.1 does not apply. Fastening of suspension means shall conform to the following:

(a) The car and counterweight ends of suspension wire ropes, or the stationary hitch-ends where multiple roping is used, shall be fastened in such a manner that all portions of the rope, except the portion inside the rope sockets, shall be readily visible. Fastenings shall be by individual tapered babbitted rope sockets conforming to 2.20.9.3 through 2.20.9.6; or by other types of rope fastening, provided that they develop at least 80% of the ultimate breaking strength of the strongest rope to be used in such fastenings.

(b) The fastening of car and counterweight ends of suspension chains shall be such as to develop at least 80% of the rated breaking strength of the strongest chain used in such fastenings.

7.2.6.8.2 Requirement 2.20.9.2 applies only where adjustable shackle rods are provided.

7.2.7 Counterweights

Counterweights shall comply with 2.21, except as modified by 7.2.7.1 through 7.2.7.4.

7.2.7.1 Requirement 2.21.1.1 does not apply. Frames are not required. Counterweights shall be permitted to be solid or sectional in design.

7.2.7.2 Requirement 2.21.1.3 does not apply. Counterweights shall be guided on each guide rail by upper and lower guiding members.

7.2.7.3 Requirement 2.21.1.4 does not apply. The same set of guide rails shall be permitted to be used for both the car and counterweight.

7.2.7.4 Requirement 2.21.2.5 does not apply. Ropes and chains shall be secured to the counterweight or suspension-rope hitch conforming to 7.2.6.

7.2.8 Buffers and Bumpers

Requirements 2.22.1 and 2.22.2 do not apply. Cars and counterweights shall be provided with buffers or

Table 7.2.8.1 Minimum Spring Buffer Strokes

| Rated Speed, m/s (ft/min) | Stroke, mm (in.) |
|------------------------------|---------------------|
| 1.00 or less (200 or less) | 40 (1.5) |
| 1.01–1.25 (201–250) | 65 (2.5) |
| 1.26–1.50 (251–300) | 100 (4.0) |

Table 7.2.8.2 Minimum Oil Buffer Strokes

| Rated Speed, m/s (ft/min) | Stroke, mm (in.) |
|------------------------------|---------------------|
| 1.50 (300) | 70 (2.75) |
| 1.60 (325) | 90 (3.50) |
| 1.75 (350) | 110 (4.25) |
| 2.00 (400) | 160 (6.25) |
| 2.25 (450) | 210 (8.25) |
| 2.50 (500) | 280 (11.00) |
| 2.75 (550) | 350 (13.75) |
| 3.00 (600) | 430 (17.00) |
| 3.50 (700) | 630 (24.75) |
| 4.00 (800) | 845 (33.25) |
| 4.50 (900) | 1 110 (43.75) |
| 5.00 (1,000) | 1 410 (55.50) |

bumpers. Buffers shall be provided where required by 7.1.6.

7.2.8.1 Spring Buffers. Spring buffers shall conform to 2.22.3, except that Table 2.22.3.1 shall substitute for Table 7.2.8.1. Spring buffers, where required by 7.1.6, shall not be used for rated speeds greater than 1.5 m/s (300 ft/min).

7.2.8.2 Oil Buffers. Oil buffers shall conform to 2.22.4, except that Table 2.22.4.1 shall substitute for Table 7.2.8.2.

7.2.9 Car and Counterweight Guide Rails, Guide-Rail Supports and Fastenings

Car and counterweight guide rails, guide-rail supports and fastenings shall comply with 2.23, except as modified by 7.2.9. The same set of guide rails shall be permitted to be used for both the car and counterweight.

7.2.9.1 Guide-Rail Section. Requirements 2.23.3, 2.23.7.2.1(a), (b), and (e), 2.23.9.1.3, 2.23.9.3, and 2.23.10.2 do not apply. Guide rails, supports, joints, fishplates, and fastenings that are not covered by 2.23 shall be permitted to be used, provided that the strengths, stresses, and deflections are consistent with the requirements of 2.23 for the loads to be imposed.

Where guide-rail sections other than those specified in 2.23.3(a) are used, the allowable deflection of the guide rail shall be limited to prevent the safety device from disengaging the rail during the application of the load.

7.2.10 Driving Machines and Sheaves

7.2.10.1 Power Dumbwaiters. Driving machines and sheaves for power dumbwaiters shall conform to 2.24 as modified by 7.2.10.1.1 through 7.2.10.1.3.

7.2.10.1.1 Requirement 2.24.1 does not apply.

7.2.10.1.2 Requirement 2.24.2.2 does not apply. Sheaves and drums shall have a pitch diameter of not less than 30 times the diameter of the rope.

7.2.10.1.3 Requirement 2.24.8 does not apply. The driving machine shall be equipped with a friction brake applied by a spring or springs, or by gravity, and electromechanically or electrohydraulically released. The brake shall be designed to have a capacity sufficient to hold the car at rest with its rated load (also see 7.2.3.1).

7.2.10.2 Hand Dumbwaiters

7.2.10.2.1 Hand driving machines shall be equipped with automatic brakes that will sustain the car and its rated load. When the brake is applied, it shall remain locked in the "ON" position until released by the operator.

7.2.10.2.2 Operation of a hand dumbwaiter shall not cause any part of the operator's body to be in the travel path of the car or counterweight.

7.2.10.3 Types of Driving Machines. Driving machines shall be one of the following types:

- (a) winding-drum
- (b) traction
- (c) rack and pinion, conforming to 4.1.13
- (d) screw-column, conforming to 4.2.15
- (e) belt drive
- (f) chain drive
- (g) hydraulic, conforming to 7.3

7.2.10.4 Belt Drive Machines. Belts used as the driving means between the motor and the machine of power dumbwaiters shall conform to 7.2.10.4.1 and 7.2.10.4.2.

7.2.10.4.1 Where flat belts are used, the rated speed of the dumbwaiter shall be not more than 0.25 m/s (50 ft/min).

7.2.10.4.2 Where multiple V-belts are used, the rated speed of the dumbwaiter shall be not more than 0.75 m/s (150 ft/min).

7.2.11 Terminal Stopping Devices

Terminal stopping devices shall conform to 2.25, except as specified in 7.2.11.1 through 7.2.11.4.

7.2.11.1 Requirement 2.25.2.2.2 does not apply.

7.2.11.2 Requirement 2.25.3.3 does not apply. Final terminal stopping devices shall be provided in the hoistway and shall be directly operated by the movement of the car.

7.2.11.3 Requirement 2.25.3.5 does not apply. Where final terminal stopping switches are located on and operated by the driving machine, they shall comply with 2.25.3.5.

7.2.11.4 Requirement 2.25.4 does not apply.

7.2.12 Operating Devices and Control Equipment (ED)

Operation of power dumbwaiters shall be of the automatic or continuous pressure type. Operating devices and control equipment shall comply with 2.26, except as modified by 7.2.12.1 through 7.2.12.36.

7.2.12.1 Requirement 2.26.1.1 applies to power dumbwaiters only.

7.2.12.2 Requirement 2.26.1.2 does not apply.

7.2.12.3 Requirement 2.26.1.3 does not apply.

7.2.12.4 Requirement 2.26.1.4 does not apply. Top-of-car operating devices are not required. Where provided, they shall conform to 7.2.12.4.1 and 7.2.12.4.2, and the installation shall also comply with 7.2.12.4.3.

7.2.12.4.1 Requirement 2.26.1.4.2 applies. Requirement 2.26.1.4.1(d)(2) applies, except that it shall be subject to the electrical protective devices required by 7.2.12.

7.2.12.4.2 Safeties shall be provided in accordance with 7.2.4.

7.2.12.4.3 A hoistway access switch conforming to 7.1.12.4 shall be provided for access to the top of the car.

7.2.12.5 Requirement 2.26.1.5 does not apply.

7.2.12.6 Requirement 2.26.1.6 applies, except that the devices shall be located at that landing and car platform guards shall conform to 7.2.2.8, and landing sill guards are not required.

7.2.12.7 Requirement 2.26.2.5 does not apply.

7.2.12.8 Requirement 2.26.2.6 does not apply.

7.2.12.9 Requirement 2.26.2.7 does not apply. Where a stop switch in the pit is provided (see 7.1.2), it shall conform in design and operation to 2.26.2.5(a), (b), and (c).

7.2.12.10 In jurisdictions not enforcing NBCC, 2.26.2.8 does not apply. Where a top-of-car operating device is provided, a stop switch conforming in design and operation to 2.26.2.5(a), (b), and (c) shall be provided on the top of the car.

In jurisdictions enforcing NBCC, 2.26.2.8 does not apply, except that for platform areas in excess of 0.5 m² (5.38 ft²), or where a top-of-car operating device is provided, a stop switch conforming in design and operation to 2.26.2.5(a), (b), and (c) shall be provided on the top of the car.

7.2.12.11 Requirement 2.26.2.10 applies only where a speed governor is provided.

7.2.12.12 Requirement 2.26.2.11 applies, except as modified by 7.2.11.2 and 7.2.11.3.

7.2.12.13 Requirement 2.26.2.12 does not apply.

7.2.12.14 Requirement 2.26.2.14 applies, except it shall conform to 7.1.12.1.

7.2.12.15 Requirement 2.26.2.15 does not apply. Car door or gate electric contacts, conforming to 7.2.1.2.2, shall be provided for all dumbwaiters.

(13) **7.2.12.16** Requirement 2.26.2.18 does not apply.

(13) **7.2.12.17** Requirement 2.26.2.20 does not apply.

(13) **7.2.12.18** Requirement 2.26.2.21 does not apply.

(13) **7.2.12.19** Requirement 2.26.2.22 does not apply.

(13) **7.2.12.20** Requirement 2.26.2.23 does not apply.

(13) **7.2.12.21** Requirement 2.26.2.24 does not apply.

(13) **7.2.12.22** Requirement 2.26.2.25 does not apply.

(13) **7.2.12.23** Requirement 2.26.2.26 does not apply.

(13) **7.2.12.24** Requirement 2.26.2.28 does not apply.

(13) **7.2.12.25** Requirement 2.26.2.29 does not apply.

(13) **7.2.12.26** Requirement 2.26.2.30 does not apply.

(13) **7.2.12.27** Requirement 2.26.2.31 does not apply.

(13) **7.2.12.28** Requirement 2.26.2.33 does not apply.

(13) **7.2.12.29** Requirement 2.26.2.34 does not apply.

(13) **7.2.12.30** Requirement 2.26.3 does not apply.

(13) **7.2.12.31** Requirement 2.26.4.3 does not apply. The following switches shall have contacts that are positively opened mechanically; their opening shall not be solely dependent on springs:

(a) stop switch in pit (see 2.26.2.7)

(b) stop switch on top-of-car (see 2.26.2.8)

(c) car safety mechanism switch (see 2.26.2.12)

(d) speed-governor overspeed switch (see 2.26.2.10)

(e) final terminal stopping device (see 7.2.11)

(f) hoistway door locking devices for power dumbwaiters (see 7.1.12.1)

(13) **7.2.12.32** Requirement 2.26.4.4 does not apply.

(13) **7.2.12.33** Requirement 2.26.4.5 does not apply.

(13) **7.2.12.34** Requirement 2.26.5 does not apply.

(13) **7.2.12.35** Requirement 2.26.6 applies. When single-phase AC motors are provided, they shall come to a complete stop before electrically reversing direction.

(13) **7.2.12.36** Requirements 2.26.9.3.1(c), (d), and (e) do not apply.

7.2.12.37 Requirements 2.26.9.3.2 and 2.26.9.4 do not apply. (13)

7.2.12.38 Requirement 2.26.12 does not apply. (13)

7.2.13 Layout Data

The information provided on layout data shall conform to 2.28, except that 2.28.1(c) and (d) do not apply. Requirement 2.28.1(b) applies only where safeties are provided.

7.2.14 Welding for Dumbwaiters

Requirement 8.8 applies, except for tack welds and other nonload-carrying welds.

SECTION 7.3 HYDRAULIC DUMBWAITERS WITHOUT AUTOMATIC TRANSFER DEVICES

Requirement 7.3 applies to hydraulic dumbwaiters without automatic transfer devices.

7.3.1 Car Enclosures, Car Doors and Gates, and Car Illumination

Requirement 7.2.1 applies to hydraulic dumbwaiters.

7.3.2 Car Frames and Platforms

Requirement 7.2.2 applies to hydraulic dumbwaiters.

7.3.3 Capacity and Loading

Requirement 7.2.3 applies to hydraulic dumbwaiters.

7.3.4 Car and Counterweight Safeties

7.3.4.1 Car Safeties. Car safeties, where provided (see 7.1.6), shall conform to 7.2.4, 7.3.4.1.1, and 7.3.4.1.2.

7.3.4.1.1 The safety shall be of a type that can be released only by moving the car in the up direction.

7.3.4.1.2 The switches required by 2.18.4.1 shall, when operated, remove power from the driving machine motor and control valves before or at the time of application of the safety.

7.3.4.2 Counterweight Safeties. Counterweight safeties, where provided (see 7.1.6), shall conform to 7.2.4, provided that safeties are operated as a result of the breaking or slackening of the counterweight suspension ropes, irrespective of the rated speed of the dumbwaiter.

7.3.5 Hydraulic Driving Machines

Jacks shall conform to 3.18; valves, pressure piping, and fittings shall conform to 3.19; and hydraulic machine and tanks shall conform to 3.24.

7.3.6 Rope, Rope Connections, and Sheaves

7.3.6.1 Ropes and Rope Connections. The wire ropes and their connections, where provided, shall conform to 7.2.6.

7.3.6.2 Sheaves. Sheaves, where provided, shall conform to 7.2.10.

7.3.6.3 Welding. Welding shall comply to 7.2.14.

7.3.7 Counterweights

Requirement 7.2.7 applies to hydraulic dumbwaiters where counterweights are provided.

7.3.8 Buffers and Bumpers

7.3.8.1 Car Buffers or Bumpers. Requirements 7.2.8.1 and 7.2.8.2 apply to hydraulic dumbwaiters, except the term “maximum speed in the down direction with rated load” shall substitute for the term “rated speed.”

7.3.8.2 Counterweight Buffers. Requirement 7.2.8 applies to hydraulic dumbwaiters.

Where counterweights are provided for hydraulic dumbwaiters, counterweight bumpers or buffers shall not be provided.

7.3.9 Guide Rails, Guide-Rail Supports, and Fastenings

Requirement 7.2.9 applies to hydraulic dumbwaiters.

7.3.10 Terminal Stopping Devices

Direct-plunger and roped-hydraulic dumbwaiter terminal stopping devices shall conform to the requirements of 3.25.

7.3.11 Operating Devices and Control Equipment

7.3.11.1 Types of Operating Devices. Requirement 7.2.12.1 applies to hydraulic dumbwaiters.

7.3.11.2 Top-of-Car Operating Devices. Requirement 7.2.12.4 applies to hydraulic dumbwaiters.

7.3.11.3 Anticreep Leveling Devices. Each dumbwaiter shall be provided with an anticreep leveling device conforming to 7.3.11.3.1 through 7.3.11.3.4.

7.3.11.3.1 The anticreep leveling device shall maintain the car within 25 mm (1 in.) of the landing irrespective of the position of the hoistway door.

7.3.11.3.2 For electrohydraulic dumbwaiters, the anticreep leveling device shall be required to operate the car only in the up direction.

7.3.11.3.3 For maintained pressure hydraulic dumbwaiters, the anticreep leveling device shall be required to operate the car in both directions.

7.3.11.3.4 The operation of the anticreep leveling device shall be permitted to depend on the availability of the electric power supply provided that

(a) the power supply line disconnecting means required by 7.3.11.7 is kept in the closed position at all

times except during maintenance, repairs, and inspection

(b) the electrical protective devices required by 7.3.11.4.2 shall not cause the power to be removed from the device

7.3.11.4 Electrical Protective Devices. Electrical protective devices conforming to 7.2.12 shall be provided.

7.3.11.4.1 The following devices shall prevent operation of the dumbwaiter by the normal operating device and also the movement of the car in response to the anticreep leveling device: (ED)

(a) stop switches in the pit

(b) stop switches on top of car

(c) slack rope switch when required by 3.18.1.2.5

(d) speed-governor switch when required by 7.2.5

7.3.11.4.2 The following devices, when actuated, shall prevent the operation of the dumbwaiter by the normal operating device, but the anticreep leveling device required by 7.3.11.3 shall remain operative:

(a) broken rope, tape, or chain switches on normal stopping devices when such devices are located in the machine room or overhead space

(b) hoistway door interlocks or hoistway door contacts

(c) car door or gate electric contacts

(d) hinged car platform sill electric contacts

7.3.11.5 Electrical Equipment and Wiring

7.3.11.5.1 All electrical equipment and wiring shall conform to the requirements of NFPA 70 or CSA-C22.1, whichever is applicable (see Part 9).

7.3.11.5.2 Electrical equipment shall be listed/certified and labeled/marked. CSA B44.1/ASME A17.5 defines the scope and applicable requirements for this listing/certification.

7.3.11.6 Installation of Capacitors or Devices to Make Electrical Protective Devices Inoperative. Requirement 2.26.7 applies to hydraulic dumbwaiters.

7.3.11.7 Control and Operating Circuits. Requirements 2.26.9.3.1(a) and (b) and 3.26.6 apply to hydraulic dumbwaiters.

7.3.11.8 Recycling Operation for Multiple or Telescopic Plungers. Requirement 3.26.7 applies to hydraulic dumbwaiters.

7.3.11.9 Pressure Switch. Requirement 3.26.8 applies to hydraulic dumbwaiters.

7.3.12 Layout Data

The information provided on layout data shall conform to 3.28, except as modified in 7.3.12.1 through 7.3.12.3.

7.3.12.1 Requirement 3.28.1(c) applies only where safeties are provided.

7.3.12.2 Requirement 3.28.1(d) does not apply.

7.3.12.3 Requirement 3.28.1(e) does not apply.

SECTION 7.4 MATERIAL LIFTS WITHOUT AUTOMATIC TRANSFER DEVICES

Requirement 7.4 applies to material lifts without automatic transfer devices.

7.4.1 General Requirement

Material lifts shall be operated by authorized personnel only.

7.4.2 Classification

Material lifts without automatic transfer devices are classified as either Type A or Type B Material Lifts.

7.4.2.1 Type A Material Lifts shall be controlled from landing-mounted operated devices only. Car-mounted operating devices shall not be permitted. It is a materials-only device, and riders shall not be permitted.

7.4.2.2 Type B Material Lifts shall be permitted to carry one operator and be provided with in-car mounted operating devices, subject to the following limitations:

(a) Access to and usage of Type B Material Lifts is restricted to authorized personnel.

(b) The rated speed is not to exceed 0.15 m/s (30 ft/min).

(c) There is penetration of only one floor.

(d) Travel does not exceed 5 000 mm (200 in.).

(e) They are operated only by continuous-pressure control devices.

(f) They shall not be accessible to the general public.

(g) The upper limit of travel shall be

(1) level with the penetrated floor; or

(2) level with the top landing where no floor is penetrated.

(h) They are permitted to serve one or more intermediate landings, provided that these landings have doors as required in 7.4.14.

7.4.3 Construction of Hoistways and Hoistway Enclosures

The construction of hoistway enclosures shall conform to 2.1.

Where fire-resistive construction is not required, 2.1 does not apply for Type B Material Lifts. Type B Material Lifts shall conform to the following:

(a) Hoistway and top landing enclosures shall be provided in compliance with Table 7.4.3.

(b) Where openwork construction is permitted, it shall reject a 25 mm (1 in.) diameter ball and shall include toe boards at least 125 mm (5 in.) high.

(c) Enclosures shall not deflect more than 20 mm (0.75 in.) when a concentrated force of 340 N (75 lbf) is applied at the center of any panel.

(d) No section or part of a top landing enclosure shall be lower than the corresponding and adjacent part of the platform enclosure when the platform is at the top landing.

7.4.4 Pits

Pits for Type A Material Lifts and for Type B Material Lifts where the pit depth exceeds 600 mm (24 in.) shall conform to 2.2.

7.4.5 Location and Guarding of Counterweights

Requirement 2.3 applies only when the car rated speed exceeds 0.5 m/s (100 ft/min).

Where the car rated speed is 0.5 m/s (100 ft/min) or less, counterweight guards conforming to 2.3.2 shall not be required provided that the installation conforms to either 7.4.5.1 or 7.4.5.2.

7.4.5.1 A chain loop or equivalent shall be hung from the bottom of the counterweight to the bottom of the car.

7.4.5.2 Lightweight chains, approximately 600 mm (24 in.) in length, shall be attached to the bottom of the counterweight. These chains shall be spaced at 150 mm (6 in.) intervals, except at the point of buffer (or bumper) engagement.

7.4.6 Vertical Clearances and Runbys for Cars and Counterweights

Requirement 2.4 does not apply.

7.4.6.1 For Type A Material Lifts, bottom and top car clearances and runbys for cars and counterweights shall conform to 7.4.6.1.1 through 7.4.6.1.4.

7.4.6.1.1 When the car reaches its maximum limit of downward travel, no part of the car or counterweight or any equipment attached thereto shall strike any part of the pit or floor beneath the lowest landing or equipment located in the hoistway, except a buffer or bumper, and no part of the counterweight or any equipment attached thereto shall strike any part of the overhead structure or equipment located in the hoistway, except a mechanical stop or buffer.

7.4.6.1.2 When the car reaches its maximum limit of upward travel, no part of the car or counterweight or any equipment attached thereto shall strike any part of the overhead structure or equipment located in the hoistway, except a mechanical stop or buffer, and no part of the counterweight or any equipment attached thereto shall strike any part of the pit or floor beneath

Table 7.4.3 Type B Material Lifts

| Item | Minimum Requirements | Requirement Reference |
|---|--|-----------------------|
| Enclosures | | 7.4.3, 7.4.13 |
| Hoistway [Note (1)] | Fully enclosed below top landing | |
| Sides: height construction | Open work | |
| Sides: height Gate: height construction | 2 030 mm (80 in.) Open work | |
| Top landing [Note (1)] | | 7.4.3, 7.4.13 |
| Sides: height construction | 2 030 mm (80 in.) Open work | |
| Gate: height construction | 2 030 mm (80 in.) Open work | |
| Car | | 7.5.1 |
| Sides: height construction | 2 030 mm (80 in.) Open work | |
| Gates | None | |
| Clearances | | 7.4.14 |
| Nonaccess side to car | 20 mm (0.75 in.) min. | 2.5.1.1 |
| Car sill to door sill | 13 mm (0.50 in.) min. 32 mm (1.25 in.) max. | 2.5.1.4 2.5.1.4 |
| Car sill to hoistway | 125 mm (5 in.) max. | 2.5.1.5.1(b) |
| In jurisdictions enforcing NBCC | 190 mm (7.5 in.) max. | 2.5.1.5.1(a) |
| Landing/Car Controls | CPPB with emergency stop | 7.5.12.2 |

NOTE:

(1) Non-fire-resistive construction.

the lowest landing or equipment located in the hoistway, except a mechanical stop or buffer.

7.4.6.1.3 When complete or partial entry into the pit is required for maintenance or inspection and the car is resting on its fully compressed buffer or bumper where the distance from the underside of the car platform to the pit access door sill, when provided, is less than 460 mm (18 in.) or the pit floor is less than 920 mm (36 in.) a nonremovable means shall be provided to mechanically hold the car above the pit floor to provide an area in the pit for maintenance and inspection conforming to the following:

(a) It shall hold the car at a height of not less than 920 mm (36 in.) nor more than 2 030 mm (80 in.) above the pit floor and not less than 460 mm (18 in.) above the bottom landing sill or pit access door sill, as measured from the underside of the car platform.

(b) The means shall be so designed and constructed as to stop and hold the car at governor tripping speed with the rated load in the car.

(c) It shall not cause the stresses and deflections in the car frame and platform members and their connections to exceed the limits specified in 2.15.10 and 2.15.11.

(d) If the means does not automatically activate when the lowest hoistway door or pit access door is opened with the car not at the landing

(1) it shall be capable of being operated without complete bodily entry into the pit.

(2) a sign shall be conspicuously displayed inside the hoistway, that includes a warning that there is an insufficient bottom car clearance, and instructions for operating the device and that the power source be disconnected. The letters shall be not less than 25 mm (1 in.) in height.

(e) A stop switch conforming to 2.26.2.7 shall be provided.

7.4.6.1.4 The minimum vertical distance for the refuge space on top of the car enclosure shall be not less than 1 070 mm (42 in.) between the top of the car enclosure and the overhead structure or other obstruction when the car has reached its maximum upward movement. If a 1 070 mm (42 in.) vertical distance is not available when the car has reached its maximum upward movement, a stopping device shall be provided and shall be functional when the car is under the control of the top-of-car operating device and shall be so located in the hoistway as to maintain the minimum vertical distance of 1 070 mm (42 in.).

7.4.6.2 For Type B Material Lifts, bottom and top car clearances and runbys for cars and counterweights shall conform to 7.4.6.2.1 through 7.4.6.2.3.

7.4.6.2.1 When the platform is at the bottom and does not have a minimum under-platform clearance of 920 mm (36 in.), a nonremovable means shall be provided conforming to 7.4.6.1.3(a) through (e).

7.4.6.2.2 Except as required by 7.4.6.2.3, the minimum overhead clearance when the platform is at the top landing shall be

- (a) 600 mm (24 in.) over the highest anticipated load
- (b) 2 000 mm (79 in.) over the empty platform

7.4.6.2.3 If a platform is equipped with a ceiling it shall be solid and capable of sustaining a load of 360 kg/m^2 (73 lb/ft^2) equally distributed, or 45 kg (100 lb) at any point; and the clearance shall conform to 7.4.6.1.4. A stop switch conforming to 7.5.12.2.7 shall be provided on the top of the car.

7.4.7 Horizontal Car and Counterweight Clearances

Horizontal car and counterweight clearances shall conform to 2.5, except as modified by 7.4.7.1 through 7.4.7.4.

7.4.7.1 Requirement 2.5.1.1 applies, except that for Type A Material Lifts the clearance between the car and hoistway enclosure shall be not less than 13 mm (0.5 in.). For Type B Material Lifts the clearance between the car and the hoistway enclosure shall be not less than 50 mm (2 in.).

7.4.7.2 Requirement 2.5.1.2 applies, except that the clearance between the car and the counterweight, and the counterweight and the hoistway enclosure shall be not less than 13 mm (0.5 in.).

7.4.7.3 Requirements 2.5.1.4 and 2.5.1.5.1 apply, except where a counterbalanced car door is provided, the clearance shall be measured from the landing side of the car door sill rather than the car platform sill.

7.4.7.4 Beveling and Clearance Requirements for Type B Material Lifts

7.4.7.4.1 Where the door is recessed more than 15 mm (0.6 in.) the door frame header shall be beveled (see Nonmandatory Appendix K).

7.4.7.4.2 Any projections on the access side of the hoistway wall that are in excess of 6 mm (0.25 in.) shall be beveled.

7.4.7.4.3 Where beveling is required it shall be at an angle not less than 60 deg from horizontal (see Nonmandatory Appendix K).

7.4.8 Protection of Spaces Below Hoistways

Protection of spaces below the hoistway shall conform to 2.6. Where safeties are required they shall conform to 7.5.4. Where buffers are required they shall conform to 7.5.8.

Type B Material Lifts shall conform to 7.4.8 or the floor shall be designed and constructed to safely support the maximum load that would be applied to it by a free-falling platform that is carrying its rated load.

7.4.9 Machinery Spaces, Machine Rooms, Control Spaces, and Control Rooms

Machinery spaces, machine rooms, control spaces, and control rooms shall conform to 2.7 except as modified in 7.4.9.1 through 7.4.9.5. Requirement 2.7 does not apply to Type B Material Lifts.

7.4.9.1 Requirement 2.7.3.4.6 applies to Type A Material Lifts except the maximum width.

7.4.9.2 Requirement 2.7.4 does not apply to Type A Material Lifts.

7.4.9.3 Requirement 2.7.5 does not apply to Type A Material Lifts except 2.7.5.1 applies only to Type A Material Lifts, where a machine room is provided and full bodily entry is necessary. If maintenance or inspections of the material lift driving-machine brake or an emergency brake, or of material lift motion controllers or motor controllers located in the hoistway, is to be carried out from inside the car or from the car top, a means shall be provided to prevent uncontrolled and unexpected vertical car movement that poses a hazard to maintenance or inspection personnel. If maintenance or inspections of the material lift driving-machine brake or an emergency brake or of material lift motion controllers or motor controllers is to be carried out from the pit, a mechanical device shall be provided to stop the car to create a vertical clearance as required by 7.4.6.1.3. A platform located in the car, on the car, or in the hoistway shall be permitted for access to and maintenance and inspection of equipment in machinery spaces or control spaces in the hoistway and shall comply with 2.7.5.3.1 through 2.7.5.3.4.

7.4.10 Equipment in Hoistways and Machine Rooms

Electrical equipment, wiring, pipes, and ducts in hoistways and machine rooms shall conform to 2.8, except as modified by 7.4.10.1 and 7.4.10.3.

7.4.10.1 Type SF or equivalent wire is not required for the wiring to the hoistway door interlock from the hoistway riser.

7.4.10.2 Requirement 2.8.3.3 does not apply. Standard sprinkler protection conforming to NFPA 13 or the NBCC, whichever is applicable, shall be permitted to be installed in a material lift hoistway when all risers and returns are located outside the hoistway.

7.4.10.3 Requirement 2.8.1 does not apply to Type B Material Lifts.

7.4.11 Machinery and Sheave Beams, Supports, and Foundations

Requirement 2.9 applies to Type A Material Lifts. Type B Material Lifts shall conform to 2.9.1.1, 2.9.2.2, 2.9.3.2, 2.9.3.3, and 2.9.4.

7.4.12 Guarding of Equipment and Standard Railing

Requirement 2.10.1 applies. Requirement 2.10.2 does not apply.

7.4.13 Protection of Hoistway Landing Openings

7.4.13.1 For Type B Material Lifts, where fire-resistive construction is not required, 7.4.13.1.1 through 7.4.13.1.3 shall apply.

7.4.13.1.1 Entrances to the platform shall be equipped with doors or gates with a minimum height of 2 030 mm (80 in.), constructed as required in 7.4.3(b), (c), and (d).

7.4.13.1.2 The clear entrance height to the platform shall be a minimum of 2 030 mm (80 in.).

7.4.13.1.3 Solid gates or doors shall have a vision panel in accordance with 2.11.7.1.

7.4.13.2 For Types A and B Material Lifts where fire-resistive construction is required, the protection of hoistway landing openings shall conform to 2.11, except as modified by 7.4.13.2.1 through 7.4.13.2.11.

7.4.13.2.1 Requirement 2.11.1 does not apply. All hoistway entrances shall guard the full height and width of the openings. Entrance opening size for Type A Material Lifts shall not exceed 2 290 mm (90 in.) in height and 1 220 mm (48 in.) in width and shall not exceed the height and width of the car entrance opening.

7.4.13.2.2 Requirement 2.11.2 does not apply. Only the following types of entrances shall be used with material lifts:

- (a) horizontal slide
- (b) swing single section only with manual load/unload material lifts
- (c) vertical slide biparting counterbalanced
- (d) vertical slide counterweighted single- or multi-section
- (e) center-opening, two-section, horizontally swing only with manual load/unload material lifts, subject to the restrictions of 2.11.2.3.

7.4.13.2.4 Requirement 2.11.4 does not apply.

7.4.13.2.5 Requirement 2.11.6 does not apply. When the car is within the unlocking zone the material lift hoistway doors shall be manually openable from within the car.

7.4.13.2.6 Requirement 2.11.7.1 applies, except that hoistway door vision panels are not required on Type A Material Lifts.

7.4.13.2.7 Requirement 2.11.7.2 does not apply.

7.4.13.2.8 Requirement 2.11.10.1 does not apply. For Type B Material Lifts, see 7.4.7.4.

7.4.13.2.9 Requirement 2.11.10.3 applies, except that car to landing bridging sills shall be permitted to be hinged on the lift and shall be permitted to form the bridge only when the hoistway doors are in the fully opened position.

7.4.13.2.10 Requirement 2.11.12 applies, except the pull straps required by 2.11.12.8 for Type A Material Lifts shall be mounted on the landing side of manually operated, vertically sliding doors.

7.4.13.2.11 Requirement 2.11.13.5 does not apply.

7.4.14 Hoistway Door Locking Devices and Electric Contacts, and Hoistway Access Switches

Hoistway door locking devices, hoistway door and car door or gate electric contacts, and hoistway access switches shall conform to 2.12, except as modified by 7.4.14.1 through 7.4.14.5.

7.4.14.1 Requirement 2.12.1.4 does not apply.

7.4.14.2 Requirement 2.12.2.3 does not apply to Type B Material Lifts. The operation of a Type B Material Lift driving machine when a hoistway door or gate is not in the closed position (see 2.12.2.2) shall be permitted by a car leveling or truck zoning device (see 7.5.12.2.5), or by an anticreep device (see 7.6.8.2). The operation of a Type B Material Lift driving machine when a hoistway door or gate is unlocked, but in the closed position, shall be permitted by a car leveling or truck zoning device, by an anticreep device, or by continuous pressure control devices located inside the car or at a landing when the car is within 75 mm (3 in.) above or below the landing. Hoistway door close contacts (see 7.5.12.2.18) shall be provided when the driving machine is operated with the hoistway door or gate unlocked, but in the closed position. The hoistway door close contacts shall be positively opened by the opening action of the door or gate. They shall be maintained in the open position by the action of gravity or by a restrained compression spring, or by both, or by positive mechanical means. (ED)

7.4.14.3 Requirement 2.12.2.4.3 applies to Type B Material Lifts, except a device to permit operation of the driving machine when the door or gate is closed but before it is locked shall be permitted in accordance to 7.4.14.2.

7.4.14.4 Requirement 2.12.6 applies except that unlocking devices are required at only the lowest and top landings. (13)

7.4.14.5 Requirement 2.12.7 applies only to Type A Material Lifts. (13)

- (13) **7.4.14.6** For Type B Material Lifts, the interlock or mechanical lock and electric contact shall not be readily accessible from inside the platform.

7.4.15 Power Operation of Hoistway Doors and Car Doors and Gates

When provided, power operation, power opening, and power closing of hoistway doors and car doors and gates shall conform to 2.13, except as modified by 7.4.15.1 through 7.4.15.6.

7.4.15.1 Requirement 2.13.3.2.4 does not apply to Type A Material Lifts.

7.4.15.2 *Requirement 2.13.3.3.2.* For Type A Material Lifts, a momentary pressure switch shall be provided at each landing.

7.4.15.3 *Requirement 2.13.3.4.* For Type A material lifts, in nonrestricted areas and restricted areas where the hoistway is accessible to personnel, all requirements of 2.13.3.4, except 2.13.3.4.2, apply. Requirement 2.13.3.4.4 applies, except that for Type A Material Lifts, a momentary pressure button will not be provided in the car.

7.4.15.4 Requirement 2.13.4 does not apply to Type A Material Lifts.

7.4.15.5 Requirement 2.13.6 does not apply to Type A Material Lifts.

7.4.15.6 For Type A Material Lifts, no door operating buttons shall be in the car.

- (13) **7.4.15.7** Requirement 2.14.5.7 does not apply.

7.4.16 Identification of Equipment

Requirement 2.29.1 applies.

SECTION 7.5 ELECTRIC MATERIAL LIFTS WITHOUT AUTOMATIC TRANSFER DEVICES

Requirement 7.5 applies to electric material lifts without automatic transfer devices.

7.5.1 Car Enclosures, Car Doors and Gates, and Car Illumination

Car enclosures and car doors and gates shall conform to 2.14, except as modified by 7.5.1.1 through 7.5.1.3.

7.5.1.1 Car Enclosure

7.5.1.1.1 Requirement 2.14.1 applies, except

(a) for Type A Material Lifts, the enclosure width shall not exceed 1 220 mm (48 in.). The height of the enclosure walls shall not exceed 2 280 mm (90 in.).

(b) for Type B Material Lifts, the platform enclosure on nonaccess sides shall be 2 030 mm (80 in.) high, shall

be permitted to be of openwork construction, and shall be in compliance with 7.4.3(b), (c), and (d).

7.5.1.1.2 Requirement 2.14.1.2 does not apply. The enclosure shall be securely fastened and so supported that it cannot loosen or become displaced in ordinary service, on the application of the car safety, or on buffer engagement.

7.5.1.1.3 Requirement 2.14.1.3 does not apply. The car enclosure shall be of such strength and so designed and supported that when subjected to a leaning or falling rated load on the car, the car enclosure walls will not deflect or deform to the extent that the running clearances are reduced below the minimum specified.

7.5.1.1.4 Requirement 2.14.1.4 does not apply. Where the car enclosure contains multiple compartments, the rated load shall be the sum of the rated loads of the individual compartments.

7.5.1.1.5 Requirement 2.14.1.5 does not apply.

7.5.1.1.6 Requirement 2.14.1.6 applies for Type A Material Lifts and for Type B Material Lifts where a car top is provided.

7.5.1.1.7 Requirement 2.14.1.7.1 does not apply.

7.5.1.1.8 Requirement 2.14.1.8 does not apply. Enclosures that incorporate glass in their construction are prohibited on material lifts.

7.5.1.1.9 Requirement 2.14.1.9 does not apply. Apparatus or equipment not used in connection with the function or use of the material lift shall not be installed inside of any material lift car, except for lift hooks, conveyor tracks, and support beams for freight handling.

7.5.1.1.10 Requirement 2.14.1.10 does not apply.

7.5.1.1.11 Requirement 2.14.2 does not apply.

7.5.1.1.12 Requirement 2.14.3.1 does not apply. Perforated construction shall reject a ball 38 mm (1.5 in.) in diameter.

7.5.1.1.13 Requirement 2.14.3.3 does not apply. If ventilating grilles or louvers are provided in the enclosure, they shall reject a ball 38 mm (1.5 in.) in diameter.

7.5.1.2 Car Doors and Gates

7.5.1.2.1 Requirement 2.14.4.1 applies to Type A Material Lifts. It also applies to Type B Material Lifts where car doors or gates are provided.

7.5.1.2.2 Requirement 2.14.4.2 does not apply. Each door or gate shall be equipped with a contact that will prevent operation of the driving machine, unless the door or gate panel(s) is in the closed position as defined in 2.14.4.11. Operation of the driving machine

when a car door or gate is not in the closed position is permissible under any of the following conditions:

- (a) by an inching, car leveling, or truck zoning device
- (b) when a hoistway access switch is operated

7.5.1.2.3 Requirement 2.14.4.3 does not apply. Car doors shall be of the horizontally or vertically sliding type and shall be of solid, grill, or perforate construction. Perforated portions shall reject a ball 38 mm (1.5 in.) in diameter. Vertically sliding doors shall conform to 2.14.6.2.1 and 2.14.6.2.3. Balanced counterweighted vertically sliding doors shall be permitted to be either single or multiple section.

7.5.1.2.4 Requirement 2.14.4.4 does not apply. Car gates shall be of the horizontally sliding collapsible type or of the vertically sliding type. Horizontally sliding collapsible gates shall conform to 2.14.6.3.1, 2.14.6.3.2, and 2.14.6.3.4. Collapsible-type gates shall be permitted to be arranged to swing inward when in the fully opened (collapsed) position. Vertically sliding gates shall conform to 2.14.6.2.1 and 2.14.6.2.3, and shall be of a design that will reject a ball 50 mm (2 in.) in diameter. Balanced counterweighted gates shall be permitted to be either single or multiple section.

7.5.1.2.5 Requirement 2.14.4.7 does not apply.

7.5.1.2.6 Requirement 2.14.4.8 does not apply. Weights used to close or balance doors or gates shall run in guides or be boxed in. Guides shall be of metal, and the bottom of the guides or boxes shall be so constructed as to retain the weights if the suspension member fails.

7.5.1.2.7 Requirement 2.14.4.10 does not apply. The operation of power-operated and power-opened or power-closed door or gates shall conform to 7.4.15.

7.5.1.2.8 Requirement 2.14.5 does not apply.

7.5.1.2.9 Requirement 2.14.6 does not apply. Gate handles of manually operated collapsible gates shall be provided with finger guards.

7.5.1.3 Car Illumination and Lighting Fixtures. Requirement 2.14.7 does not apply. Cars shall be provided with an electric light or lights providing a minimum of 27 lx (2.5 fc) at the car threshold and conforming to 2.14.7.4.

7.5.2 Car Frames and Platforms

Car frames and platforms shall conform to 2.15, except as modified by 7.5.2.1 through 7.5.2.7.

7.5.2.1 Requirement 2.15.5 does not apply. The platform shall be designed to withstand the forces developed under the loading conditions for which the lift is designed and installed.

7.5.2.2 Requirements 2.15.6.1.2 and 2.15.6.1.3 do not apply.

7.5.2.3 Requirement 2.15.8 does not apply.

7.5.2.4 Requirement 2.15.9.2 applies to Type A Material Lifts and Type B Material Lifts that operate in a leveling or truck zone in accordance to 7.5.12.2.5 only, except the minimum allowance of 1 220 mm (48 in.) in 2.15.9.2(a) does not apply to Type A and Type B Material Lifts and the minimum allowance of 525 mm (21 in.) in 2.15.9.2(b) does not apply to Type B Material Lifts.

7.5.2.5 Requirement 2.15.9.3 does not apply.

7.5.2.6 Requirement 2.15.11 does not apply. For Type B Material Lifts the vertical deflection of the platform when the rated load is in any position on the platform shall not exceed 5 mm per 1 000 mm (0.25 in. per 50 in.) of platform length. The maximum allowable deflection shall be 50 mm (2 in.).

7.5.2.7 For Type B Material Lifts

- (a) platform surfaces shall be skid-resistant
- (b) all materials and freight carried on platforms, including wheeled vehicles, shall be blocked, locked, or otherwise positively located on the platform

7.5.3 Capacity and Loading

Capacity and loading shall conform to 2.16, except as modified by 7.5.3.1 through 7.5.3.4.

7.5.3.1 Requirement 2.16.1 does not apply.

7.5.3.2 Requirement 2.16.2 applies, except that for Type A Material Lifts the class of loading shall not include Industrial Truck Loading: Class C1 and C2.

7.5.3.3 Requirement 2.16.4 does not apply. Type A Material Lifts shall be restricted to handling of material only and shall not be used to carry persons. A sign conforming to 2.16.5 and reading "NO RIDERS PERMITTED" or equivalent verbiage shall be provided.

7.5.3.4 For Type B Material Lifts, 2.16.5 does not apply, except as modified by 7.5.3.4.1 through 7.5.3.4.3.

7.5.3.4.1 The following signs shall be provided:

- (a) at each control station in the hall: MAXIMUM LOAD ____kg (lb) and NO RIDERS EXCEPT ONE OPERATOR OR FREIGHT HANDLER
- (b) at the control station in the lift: NO RIDERS EXCEPT ONE OPERATOR OR FREIGHT HANDLER
- (c) at each entrance or gate: AUTHORIZED PERSONNEL ONLY ON THIS MATERIAL LIFT

7.5.3.4.2 Signs shall comply with 2.16.5.2, except that the height of characters for the signs required by 7.5.3.4(a) shall be not less than 25 mm (1 in.).

7.5.3.4.3 Signs for class of loading shall be provided in the lift and shall comply with 2.16.5.1.1.

7.5.3.5 Requirement 2.16.7 shall not apply. One-piece loads exceeding rated load shall not be carried on material lifts without automated transfer devices.

7.5.4 Car and Counterweight Safeties

Car and counterweight safeties shall conform to 2.17, except as modified by 7.5.4.1 through 7.5.4.4.

7.5.4.1 Requirement 2.17.3 does not apply. The safety device shall be capable of stopping and sustaining the entire car with its rated load from governor tripping speed, within the maximum stopping distances as determined in 8.2.6 and Table 2.17.3.

7.5.4.2 Requirement 2.17.7 applies, except the rated speed shall be modified to read 1 m/s (200 ft/min).

7.5.4.3 Requirement 2.17.8 applies, except that Type A safeties shall be permitted to be used regardless of the rated speed. Safeties actuated by broken or slack suspension ropes are permitted only for material lifts having a rated speed of 0.5 m/s (100 ft/min) or less.

7.5.4.4 Requirement 2.17.9 applies, except as modified by 7.5.4. The application of safeties shall conform to 2.17.9.1, 2.17.9.2, and 2.17.9.3. The forces providing the stopping action shall conform to 2.17.9.4 or 7.5.4.4.1.

7.5.4.4.1 Where guide-rail sections other than those specified in 2.23.3(a) are used, the application of safety stopping forces shall not cause deformation of the guide-rail sections upon whose dimensional stability the stopping capability of the safeties is dependent.

7.5.5 Speed Governors

Speed governors shall conform to 2.18, except as modified by 7.5.5.1 through 7.5.5.3.

7.5.5.1 Requirement 2.18.1 applies, except the rated speed shall be modified to read 1 m/s (200 ft/min).

7.5.5.2 Requirement 2.18.4 applies, except the rated speed shall be modified from 0.75 m/s (150 ft/min) to 1 m/s (200 ft/min).

7.5.5.3 Requirement 2.18.5 applies, except as modified by 7.5.5.3.1.

7.5.5.3.1 When the suspension ropes are less than 9.5 mm (0.375 in.), the diameter of the governor rope shall be permitted to be less than 9.5 mm (0.375 in.), but not less than the diameter of the suspension ropes.

7.5.6 Suspension Ropes and Their Connections

Suspension ropes and their connections shall conform to 2.20, except as modified by 7.5.6.1 through 7.5.6.6.

7.5.6.1 Requirement 2.20.1 does not apply. Cars and counterweights for material lifts shall be suspended by iron or steelwire hoisting ropes or chains. Ropes that have previously been installed and used on another installation shall not be reused. Chains, where used, shall be roller, block, or multiple-link silent type.

7.5.6.2 Chain Data

(a) The crosshead data plate required by 2.20.2.1 shall bear the following chain data:

- (1) number of chains
- (2) type of chain
- (3) standard chain number
- (4) the manufacturer's rated breaking strength per chain in pounds (lb)

(b) A metal data tag shall be securely attached to one of the chain fastenings. A new tag shall be installed at each chain renewal. The material and marking of the chain data tag shall conform to 2.16.3.3, except that the height of the letters and figures shall be not less than 1.5 mm ($\frac{1}{16}$ in.). This data tag shall bear the following chain data:

- (1) type of chain
- (2) standard chain number
- (3) the manufacturer's rated breaking strength per chain in pounds (lb)
- (4) month and year the chains were installed
- (5) name of the person or firm who installed the chains
- (6) name of the manufacturer of the chains

7.5.6.3 Requirement 2.20.3 applies, except as modified by the following:

(a) The applicable safety factor to be applied is that of a freight elevator.

(b) Where chains are provided, the factor of safety shall be equal to 1.25 times the safety factor calculated for wire ropes.

7.5.6.4 Requirement 2.20.4 does not apply. The minimum number of hoisting ropes or chains used shall be two.

7.5.6.5 Requirement 2.20.5 applies, except where only two ropes are provided, single-bar-type equalizers shall be permitted to be used.

7.5.6.6 Requirement 2.20.9 applies. The fastening of car and counterweight ends of suspension chains shall be such as to develop at least 80% of the rated breaking strength of the strongest chain used in such fastenings.

7.5.7 Counterweights

Counterweights for Type A Material Lifts shall conform to 2.21.

7.5.8 Buffers and Bumpers

Buffers and bumpers for Type A Material Lifts shall conform to 2.22, except as modified by 7.5.8.1 through 7.5.8.5.

7.5.8.1 Requirement 2.22.1.1.1. Spring buffers or their equivalent shall be permitted to be used where the rated speed does not exceed 1.5 m/s (300 ft/min).

7.5.8.2 *Requirement 2.22.1.1.2.* Oil buffers or their equivalent shall be used where the rated speed is in excess of 1.5 m/s (300 ft/min).

7.5.8.3 *Requirement 2.22.3.1.* Table 7.9.2.13 shall be used in place of Table 2.22.3.1.

7.5.8.4 *Requirement 2.22.4.1.* Table 7.9.2.14 shall be used in place of Table 2.22.4.1.

7.5.8.5 Solid bumpers are permitted where the rated speed does not exceed 0.25 m/s (50 ft/min).

7.5.9 Car and Counterweight Guide Rails, Guide-Rail Supports, and Fastenings

Car and counterweight guide rails, guide-rail supports, and fastenings shall conform to 2.23, except as modified by 7.5.9.1 and 7.5.9.2.

7.5.9.1 Use of Common Guide Rails. The same set of guide rails shall be permitted to be used for both the car and counterweight.

7.5.9.2 Guide-Rail Sections. Requirements 2.23.3(a), (b)(1), 2.23.9.1, and 2.23.9.3 do not apply. Guide rails, supports, joints, fishplates, and fastenings that are not covered by 2.23 shall be permitted to be used, provided that the strengths, stresses, and deflections are consistent with 2.23 for the loads imposed.

Where guide-rail sections other than those specified in 2.23.3(a) are used

(a) requirements 2.23.7.2.1(a), (b), (e), and 2.23.10.2 do not apply

(b) the allowable deflection of the guide rail shall be limited to prevent the safety device from disengaging the rail during the application of the load

7.5.10 Driving Machine and Sheaves

The driving means shall be one of the following types:

(a) Traction and winding drum machines conforming to 2.24, except as modified by the following:

(1) Requirement 2.24.2.2 does not apply. Sheaves and drums shall have a pitch diameter of not less than 30 times the diameter of the rope.

(b) Chain drive machines conforming to the following:

(1) Friction gearing, clutch mechanisms, or couplings shall not be used for connecting the sprockets to the main drive gear.

(2) The driving machine shall be equipped with electrically released, mechanically applied brakes conforming to 2.24.8. The operation of the brake shall conform to 2.26.8.

(3) The driving machine chains and sprockets shall be of steel with all particulars of design and dimensions meeting ANSI B29.1.

(c) Indirect drive machines conforming to 2.24.9.

(d) Rack and pinion drive machines conforming to 4.1.13. The safeties on rack-and-pinion drive machines shall conform to either 4.1.9 or 7.5.4.

(e) Screw-column drive machines conforming to 4.2.15.

(f) For Type B Material Lifts the following shall apply:

(1) No part of the driving machine shall be located directly above the platform area.

(2) Provision shall be made to allow manual lowering in the event of power failure

7.5.11 Terminal Stopping Devices

7.5.11.1 For Type A Material Lifts, the terminal stopping devices shall conform to 2.25, except as modified by 7.5.11.1.1 through 7.5.11.1.3.

7.5.11.1.1 Requirement 2.25.3.3 does not apply. Final terminal stopping devices shall be provided in the hoistway and shall be directly operated by the movement of the car.

7.5.11.1.2 Requirement 2.25.3.5 does not apply. Where final terminal stopping switches are located on and operated by the driving machine, they shall conform to 2.25.3.5.

7.5.11.1.3 Requirement 2.25.4 does not apply.

7.5.11.2 For Type B Material Lifts the terminal stopping devices shall conform to 7.5.11.2.1 through 7.5.11.2.4.

7.5.11.2.1 A normal terminal stopping device (electrical switch) shall be provided at the top and bottom landings; it shall positively and automatically stop the lift at the landings.

7.5.11.2.2 Mechanical limits shall be provided at the top and bottom end of travel. The top and bottom limit shall be permitted to exceed the normal terminal stopping device by 100 mm (4 in.).

7.5.11.2.3 Where a mechanical limit at the top of travel cannot be provided (because of the design of the hoisting machine), a final terminal stopping device (electrical switch) shall be provided that shall, after an overtravel of 50 mm (2 in.), cause the power to be removed from the hoisting machine automatically and independently of the functioning of the device required in 7.5.11.2.1.

7.5.11.2.4 Normal and final terminal stopping devices shall be operated directly by the movement of the lift, and shall not be accessible from the landings.

7.5.12 Operating Devices and Control Equipment

7.5.12.1 Type A material lift operating devices and control equipment shall conform to 2.26, except as modified by 7.5.12.1.1 through 7.5.12.1.23. (ED)

7.5.12.1.1 Requirement 2.26.1.2 does not apply.

- 7.5.12.1.2** Requirement 2.26.1.3 does not apply. One-piece loads greater than the rated load are not permitted.
- 7.5.12.1.3** Requirement 2.26.1.5 does not apply.
- 7.5.12.1.4** Requirement 2.26.1.6 applies, except that the devices shall be located at the landing.
- 7.5.12.1.5** Requirement 2.26.2.5 does not apply. An emergency stop switch (switches) conforming to 2.26.2.5(a), (b), and (c) shall be provided to stop operation of the material lift, and the door and gate operation (if power operated). The emergency stop switch shall be located in the car adjacent to each entrance in a position that shall be accessible to a person standing at the floor adjacent to the car entrance.
- 7.5.12.1.6** Requirement 2.26.2.6 does not apply.
- 7.5.12.1.7** Requirement 2.26.2.10 applies only where a speed governor is provided.
- 7.5.12.1.8** Requirement 2.26.2.11 does not apply. Final terminal stopping devices conforming to 7.5.11 shall be provided for every electric material lift.
- 7.5.12.1.9** Requirement 2.26.2.13 does not apply.
- 7.5.12.1.10** Requirement 2.26.2.15 does not apply. Car door or gate electric contacts conforming to 7.5.1.2.2 shall be provided.
- 7.5.12.1.11** Requirement 2.26.2.16 does not apply.
- (13) **7.5.12.1.12** Requirement 2.26.2.20 applies, except when a closed door or gate or closed hoistway door prevents the device from encroaching into the hoistway.
- (13) **7.5.12.1.13** Requirement 2.26.2.21 does not apply. A stop switch conforming to 7.5.12.1.5 shall be provided in the car.
- (13) **7.5.12.1.14** Requirement 2.26.3 does not apply.
- (13) **7.5.12.1.15** Requirement 2.26.4.3 does not apply.
- (ED) The following switches shall have contacts that are positively opened mechanically; their opening shall not be solely dependent on springs.
- (a) stop switch in pit (see 2.26.2.7)
 - (b) stop switch on top-of-car (see 2.26.2.8)
 - (c) car safety mechanism switch (see 2.26.2.12)
 - (d) speed-governor overspeed switch (see 2.26.2.10)
 - (e) final terminal stopping device (see 7.5.11)
 - (f) hoistway door locking devices for power material lifts (see 7.4.14)
 - (g) hoistway door close contacts (see 7.5.12.2.18)
- (13) **7.5.12.1.16** Requirement 2.26.4.4 does not apply.
- (13) **7.5.12.1.17** Requirement 2.26.4.5 does not apply.
- (13) **7.5.12.1.18** Requirement 2.26.5 does not apply.
- 7.5.12.1.19** Requirement 2.26.6 applies for poly-phase motors. When single-phase AC motors are provided, they shall come to a complete stop before electrically reversing direction. (13)
- 7.5.12.1.20** Requirements 2.26.9.3.1(c), (d), and (e) do not apply. (13)
- 7.5.12.1.21** Requirements 2.26.9.3.2 and 2.26.9.4 do not apply. When a single ground or failure as specified in 2.26.9.3.1(a) or (b) occurs, the car shall not be permitted to restart. (13)
- 7.5.12.1.22** Requirement 2.26.12 does not apply. (13)
- 7.5.12.1.23** Operating devices that initiate motion of the car shall not be located in the car. (13)
- 7.5.12.2** Type B Material Lift operating devices and control equipment shall conform to 2.26, except as modified by 7.5.12.2.1 through 7.5.12.2.33. (ED)
- 7.5.12.2.1** Requirement 2.26.1.2 does not apply.
- 7.5.12.2.2** Requirement 2.26.1.3 does not apply. One-piece loads greater than the rated load are not permitted.
- 7.5.12.2.3** Requirement 2.26.1.4 does not apply. Where top of car inspection operation is provided 2.26.1.4.2 applies.
- 7.5.12.2.4** Requirement 2.26.1.5 does not apply.
- 7.5.12.2.5 Operation in Leveling or Truck Zone.** Requirement 2.26.1.6 does not apply. Operation of a material lift in a leveling or truck zone at any landing by a car leveling or truck-zoning device, when the hoistway doors, or the car doors or gates, or any combination thereof, are not in the closed position, is permissible, subject to the requirements of 7.6.8.2.5.1 through 7.6.8.2.5.4.
- 7.5.12.2.5.1** Operating devices of manually operated car leveling devices or truck-zoning devices shall be of the continuous-pressure type and located in the car.
- 7.5.12.2.5.2** The material lift leveling zone at any landing shall not extend more than 75 mm (3 in.) above and below any landing. Operation in the leveling zone above any landing shall only be permitted when a car apron conforming to 2.15.9 is provided, except the minimum allowances of 1 220 mm (48 in.) in 2.15.9.2(a) and 525 mm (21 in.) in 2.15.9.2(b) do not apply.
- 7.5.12.2.5.3** The material lift truck zone at any landing shall not extend more than 1 700 mm (67 in.) above the landing. Truck zones shall only be permitted when a car apron conforming to 2.15.9 is provided, except the minimum allowances of 1 220 mm (48 in.) in 2.15.9.2(a) and 525 mm (21 in.) in 2.15.9.2(b) do not apply.
- 7.5.12.2.5.4** Requirement 2.26.1.6.5 shall apply.

- 7.5.12.2.6** Requirement 2.26.2.5 does not apply. Each control station shall be provided with an emergency stop switch (switches) conforming to 2.26.2.5(a), (b), and (c). And it shall cause the power to be removed from the driving machine when operated.
- 7.5.12.2.7** Requirement 2.26.2.6 does not apply.
- 7.5.12.2.8** Requirement 2.26.2.8 applies only where a car top is provided.
- 7.5.12.2.9** Requirement 2.26.2.10 applies only where a speed governor is provided.
- 7.5.12.2.10** Requirement 2.26.2.11 does not apply. Final terminal stopping devices conforming to 7.5.11 shall be provided for every electric material lift.
- 7.5.12.2.11** Requirement 2.26.2.12 does not apply.
- 7.5.12.2.12** Requirement 2.26.2.13 does not apply.
- 7.5.12.2.13** Requirement 2.26.2.15 does not apply. Car door or gate electric contacts conforming to 7.5.1.2.2 shall be provided.
- 7.5.12.2.14** Requirement 2.26.2.16 does not apply.
- (13) **7.5.12.2.15** Requirement 2.26.2.20 applies, except when a closed door or gate or closed hoistway door prevents the device from encroaching into the hoistway.
- (13) **7.5.12.2.16** Requirement 2.26.2.21 does not apply. A stop switch conforming to 7.5.12.2.6 shall be provided in the car.
- (13) **7.5.12.2.17** Requirement 2.26.2.24 does not apply.
- (13) **7.5.12.2.18 Hoistway Door Close Contacts.** Hoistway door close contacts, conforming to 7.4.14.2, shall be provided for all Type B Material Lifts that can operate with hoistway doors or gates closed but not locked within 75 mm (3 in.) above or below a landing and are provided with interlocks. These contacts are electrical protective devices.
- (13) **7.5.12.2.19** Requirement 2.26.3 does not apply.
- (13) **7.5.12.2.20** Requirement 2.26.4.3 does not apply. The following switches shall have contacts that are positively opened mechanically; their opening shall not be solely dependent on springs:
- (a) stop switch in pit (see 2.26.2.7)
 - (b) stop switch on top-of-car (see 2.26.2.8)
 - (c) car safety mechanism switch (see 2.26.2.12)
 - (d) speed-governor overspeed switch (see 2.26.2.10)
 - (e) final terminal stopping device (see 7.5.11)
 - (f) hoistway door locking devices for power material lifts (see 7.4.14)
- 7.5.12.2.21** Requirement 2.26.4.4 does not apply. (13)
- 7.5.12.2.22** Requirement 2.26.4.5 does not apply. (13)
- 7.5.12.2.23** Requirement 2.26.5 does not apply. (13)
- 7.5.12.2.24** Requirement 2.26.6 applies for poly-phase motors. When single-phase AC motors are provided, they shall come to a complete stop before electrically reversing direction. (13)
- 7.5.12.2.25** Requirements 2.26.9.3.1(c), (d), and (e) do not apply. (13)
- 7.5.12.2.26** Requirements 2.26.9.3.2 and 2.26.9.4 do not apply. When a single ground or failure as specified in 2.26.9.3.1(a) or (b) occurs, the car shall not be permitted to restart. (13)
- 7.5.12.2.27** Requirement 2.26.11 does not apply. (13)
- 7.5.12.2.28** Requirement 2.26.12 does not apply. (13)
- 7.5.12.2.29** All operating devices shall be of the continuous-pressure type (CPPB in Table 7.4.3). (13)
- 7.5.12.2.30** A control station located at a landing shall be in the vicinity of, and in full view of, the material lift entrance. (13)
- 7.5.12.2.31** Controls and equipment shall be protected against unauthorized use. (13)
- 7.5.12.2.32** The center of the car control station shall be located at a vertical height between 1 500 mm (59 in.) and 1 700 mm (66 in.) from the platform surface and horizontally at least 1 000 mm (39 in.) from the car sill. In the case of front and rear entrances with a car depth of less than 2 000 mm (79 in.), the car control station shall be located horizontally at the center of the side enclosure. (13)
- 7.5.12.2.33** No landing control devices, except emergency stop switch(es), shall override a car control device that is in operation. Means shall be provided within the car that shall render inoperative landing control devices. (13)
- 7.5.13 Layout Data**
- Layouts shall conform to 2.28.
- 7.5.14 Welding**
- Requirement 8.8 applies, except for tack welding and other nonload-carrying welds.

SECTION 7.6 HYDRAULIC MATERIAL LIFTS WITHOUT AUTOMATIC TRANSFER DEVICES

Requirement 7.6 applies to hydraulic material lifts without automatic transfer devices.

7.6.1 Hoistways, Hoistway Enclosures, and Related Construction

Hoistways, hoistway enclosures, and related construction shall conform to 3.1 through 3.13 and 3.29, except as modified by 7.4.3 through 7.4.16.

7.6.2 Mechanical Equipment

Mechanical equipment shall conform to 7.5.

7.6.3 Hydraulic Driving Machines

Driving machines shall conform to 3.18, except as modified by 7.6.3.1.

7.6.3.1 Requirement 3.23.2 applies, except as modified in 7.6.3.1.1 and 7.6.3.1.2.

7.6.3.1.1 Roped-hydraulic elevators shall be suspended with not less than two wire ropes or chains in conformance with 2.15.13 and 7.5.6.

7.6.3.1.2 Sheaves used to transfer load from the driving machine to the car frame through wire ropes or chain shall conform to 7.5.10.

7.6.4 Valves, Pressure Pippings, and Fittings

Valves, pressure piping, and fittings shall conform to 3.19, except as modified by 7.6.4.1 and 7.6.4.2.

7.6.4.1 Where cylinders are equipped with an overspeed valve in conformance with 3.19.4.7, the requirement of 3.19.3.3.1(a) does not apply.

7.6.4.2 For Type B Material Lifts, 3.19.4.4 does not apply.

7.6.5 Counterweight Ropes, Rope Connections, and Sheaves

Counterweight ropes, rope connections, and sheaves shall conform to 3.20, except as modified by 7.6.5.1 and 7.6.5.2.

7.6.5.1 Requirement 3.20 does not apply. Ropes and rope connections shall conform to 7.5.6.

7.6.5.2 Requirement 3.21.2 does not apply. Sheaves for counterweights shall conform to 7.5.10.

7.6.6 Hydraulic Machines and Tanks

Hydraulic machines and tanks shall conform to 3.24.

For Type B Material Lifts, the machines and tanks shall be enclosed and access shall be through a panel or door, that shall normally be locked.

7.6.7 Terminal Stopping Device

Terminal stopping devices shall conform to 7.5.11.

7.6.8 Operating Devices and Control Equipment

7.6.8.1 Operating Devices and Control Equipment. (ED) Operating devices and control equipment shall conform to 2.26 as specified by 7.5.12, except as modified by the following:

(a) Requirements 7.5.12.1.5 through 7.5.12.1.13 and 7.5.12.2.5 through 7.5.12.2.16 for electrical protective devices apply as specified in 7.6.8.3.

(b) Requirements 2.26.6, 7.5.12.1.19, and 7.5.12.2.22 do not apply.

(c) Requirement 2.26.8 does not apply.

(d) Requirements 2.26.9.1, 2.26.9.2, 2.26.9.5, 2.26.9.6, and 2.26.9.7 do not apply.

(e) Requirement 2.26.10 does not apply.

The words "driving machine motor and brake" in 2.26 and 7.5.12 shall be replaced with "hydraulic machine."

7.6.8.2 Anticreep Operation. Each hydraulic Type A Material Lift shall be provided with anticreep operation in conformance with 3.26.3. Each hydraulic Type B Material Lift shall be provided with an anticreep operation to correct automatically a change in car level below any landing. It shall conform to 7.6.8.2.1 through 7.6.8.2.5.

7.6.8.2.1 The anticreep leveling zone shall not extend more than 75 mm (3 in.) below any landing.

7.6.8.2.2 The anticreep device shall maintain the car within 25 mm (1 in.) of the landing.

7.6.8.2.3 The anticreep device shall be required to operate the car only in the up direction.

7.6.8.2.4 When operation dependant on the availability of electric power is provided, 3.26.3.1.4 shall apply.

7.6.8.2.5 Only the following, when activated, shall prevent operation of the anticreep device:

(a) all electrical protective devices except those listed in 7.6.8.3

(b) recycling operation (3.26.7)

(c) inspection transfer switch [2.26.1.4.1(b)]

(d) low oil protection means (7.6.8.5)

(e) oil tank temperature shutdown devices

7.6.8.3 Electrical Protective Devices. (ED) When in the open position, all electrical protective devices shall prevent operation by all operating means except the following devices shall not prevent operation of the anticreep device:

(a) emergency stop switch, 7.5.12.2.5

(b) hoistway door interlocks or hoistway door contacts, 2.26.2.14

(c) car door or gate electric contacts (7.5.12.2.12)

(d) hinged car platform sill electric contacts (2.26.2.20)

(e) hoistway door close contacts (7.5.12.2.18)

7.6.8.4 Requirements 3.26.5 through 3.26.8 apply to all hydraulic material lifts. Requirements 3.26.9 and 3.26.10 shall apply to Type A hydraulic Material Lifts only.

7.6.8.5 Low Oil Protection. A means shall be provided to render normal control of a Type B hydraulic Material Lift inoperative if for any reason the liquid level in the tank falls below the permissible minimum. Suitable means include, but are not limited to, the following:

- (a) direct sensing of liquid level
- (b) a pump-run timer

Actuation of the means shall prevent the hydraulic pump from running, preventing further upward motion. Continuous pressure operation shall continue to function in the downward direction. The means shall require local manual reset before returning the car to service.

7.6.9 Layout Data

Layout data shall conform to 7.5.13 and 3.28.1(g), (h), and (j).

SECTION 7.7 AUTOMATIC TRANSFER DEVICES

7.7.1 General

A flashing light and an audible signal shall be actuated on the start of the door opening prior to transfer. Where used in nonrestricted areas, the automatic transfer device shall be so designed that the kinetic energy of the load during discharge shall not exceed 40 J (30 ft-lbf) and the speed shall not exceed 0.5 m/s (1.5 ft/s). The automatic transfer device shall stop the load at the completion of a discharge operation.

7.7.2 Clearances

Where the transfer of load is in a nonrestricted area, there shall be a clearance of not less than 1 220 mm (48 in.) between the end of the transferred load and any fixed obstruction in line with the end of the load. Where the automatic transfer device is designed to carry out multiple cart transfers, the 1 220 mm (48 in.) clearance space shall be measured from the leading edge of the first cart to be ejected, once the multiple transfer operation has been completed.

7.7.3 Guarding

In nonrestricted areas, discharge shall not take place unless the area is clear or a protective device or suitable guarding is provided. Guarding shall be by one of the following methods:

- (a) railings or suitable barriers to prevent persons from entering the path of the transferring load.
- (b) mechanical or electrical devices designed to prevent or stop transfer if a person or object is in the path of the transferring load.

(c) providing a table or a raised section not less than 460 mm (18 in.) above the floor and of such dimensions that the load does not overhang the table or raised section. The distance between the car platform sill and the nearest edge of the table shall not exceed 150 mm (6 in.).

7.7.4 Floor Level

Where the automatic transfer device transfers the load directly on the landing floor, the maximum variation in over all floor level within the emerging single or multiple loads tracking area shall not exceed 6 mm (0.25 in.).

SECTION 7.8 POWER DUMBWAITERS WITH AUTOMATIC TRANSFER DEVICES

7.8.1 Requirements

Power dumbwaiters with automatic transfer devices shall conform to 7.1 through 7.3, except as modified in 7.8.1.1 through 7.8.1.4.

7.8.1.1 Requirement 7.1.12.1.3 does not apply. All hoistway doors shall be equipped with interlocks conforming to 7.1.12.1.2.

7.8.1.2 *Requirement 7.2.2.4.* The transfer device on the floor of the dumbwaiter shall be permitted to serve as a platform. Open areas in the floor shall be covered with solid flooring, grille, or perforated metal, and openings in such material shall reject a ball 50 mm (2 in.) in diameter.

7.8.1.3 *Requirement 7.2.1.* Where the placement of the load is controlled and secured in transit, 7.2.1 does not apply. Where a car enclosure is provided, 7.2.1 applies.

7.8.1.4 *Requirement 7.2.1.1.2.* The effective inside height of the car above or below the transfer device shall not exceed 1 220 mm (48 in.).

7.8.2 Safety Devices

Where the gross load (i.e., car, transfer device, rated load, gates, operating devices, etc.) exceeds 700 kg (1,500 lb), or the rated speed is greater than or equal to 1 m/s (200 ft/min), car safeties conforming to 2.17 shall be provided and comply with 7.9.2.7, 7.9.2.8, and 7.9.2.9.

7.8.3 Emergency Stop Switch

An emergency stop switch (switches) conforming to 2.26.2.5(a), (b), and (c) shall be provided to stop operation of the dumbwaiter and stop the door operation and transfer device operation. A stop switch shall be located in the car adjacent to each entrance in a position that is accessible to a person standing at the floor adjacent to the car entrance.

7.8.4 Structural Capacity Load

Dumbwaiters with automatic transfer devices that have a net inside platform area of 0.35 m² (3.75 ft²) or more shall be rated for a lifting load of not less than 135 kg (300 lb).

SECTION 7.9 ELECTRIC MATERIAL LIFTS WITH AUTOMATIC TRANSFER DEVICES

Requirement 7.9 applies to electric material lifts with automatic transfer devices.

7.9.1 Hoistways, Hoistway Enclosures, and Related Construction

Hoistways, hoistway enclosures, and related construction shall conform to 2.1 through 2.13, and 2.29, except as modified by 7.9.1.1 through 7.9.1.10.

7.9.1.1 *Requirement 2.1.1.1.* Cutouts are permitted in doors for the accommodation of the automatic transfer device. Cutouts shall be of minimum area to accommodate the transfer mechanism, and if not substantially filled with a fire-resistive automatic transfer device when the hoistway doors are in the fully closed position, the cutout area shall be covered by a shield that will automatically seal the cutout area and maintain the fire-protection rating of the hoistway entrance assembly.

7.9.1.2 *Requirements 2.5.1.4 and 2.5.1.5.1.* Where a counterbalanced car door is provided, the clearance between the landing side of the car door sill and the hoistway edge of any landing sill shall be not more than 125 mm (5 in.).

7.9.1.3 Requirement 2.11.1 does not apply. All hoistway landing openings shall be provided with doors that shall guard the full height and width of the openings.

7.9.1.4 *Requirement 2.11.2.2.* Only the following types of entrances shall be used with material lifts with automatic transfer devices:

- (a) power-operated horizontal slide, single- or multi-section
- (b) power-operated vertical slide, biparting counterbalanced
- (c) power-operated vertical slide, counterweighted, single- or multi-section

7.9.1.5 *Requirement 2.11.5.* The automatic transfer mechanism or stationary track shall not project into a hoistway beyond the line of the landing sill unless solid type guide shoes are provided on the car.

7.9.1.6 *Requirement 2.11.7.* Hoistway door vision panels are not required on material lifts with automatic transfer devices.

7.9.1.7 *Requirement 2.12.3.1.* In restricted areas only and when access to the hoistway doors is blocked by a permanently floor-mounted automatic transfer device, the hoistway doors shall close and lock before the car has traveled not more than 455 mm (18 in.) away from the landing.

7.9.1.8 *Requirement 2.12.6.1.* Hoistway door unlocking devices are required at only the top and bottom terminal landings.

7.9.1.9 *Requirement 2.13.3.4*

(a) In nonrestricted areas, all the requirements of 2.13.3.4 shall apply, except for 2.13.3.4.2 and 2.13.3.4.4.

(b) In restricted areas, 2.13.3.4 does not apply where the hoistway entrance is blocked by a permanently floor-mounted automatic transfer device. In restricted areas, where the hoistway entrance is accessible to personnel, 2.13.3.4 shall apply, except 2.13.3.4.2 and 2.13.3.4.4, which do not apply.

7.9.1.10 Requirement 2.13.4.2.4 does not apply.

7.9.2 Machinery and Equipment

The machinery and equipment shall conform to 2.14 through 2.28, 8.8, and 8.9, except as modified by 7.9.2.1 through 7.9.2.20.

7.9.2.1 *Requirement 2.14.1.5.* Top emergency exits are not required.

7.9.2.2 *Requirement 2.14.3.1.* Grille or perforated construction shall be permitted to be used for the full height and top of car enclosure. The car enclosure shall be the same height as the hoistway entrance. The 1 825 mm (72 in.) minimum height limitation shall not apply.

7.9.2.3 *Requirement 2.14.6.2.* When car doors or gates are provided and where the car entrance height exceeds 1 825 mm (72 in.), the doors or gates shall extend from the car floor to a height of not less than 1 825 mm (72 in.). Where the car entrance height is 1 825 mm (72 in.) or less, the car doors or gates shall extend to the full height of the car entrance.

7.9.2.4 *Requirement 2.15.5.* The transfer device on the floor of the material lift shall be permitted to serve as a platform. Open areas in the platform shall be covered with solid flooring, grille, or perforated metal. Also, any openings in such material shall reject a ball 50 mm (2 in.) in diameter.

7.9.2.5 *Requirement 2.16.2.* The rated load of the material lifts shall be based on the weight of the maximum load to be handled or on 240 kg/m² (50 lb/ft²) of inside net platform area, whichever is greater.

7.9.2.6 *Requirement 2.16.4.* Material lifts with transfer devices located in nonrestrictive areas that are not obscured (see 7.11) shall carry materials only and shall

Table 7.9.2.13 Minimum Spring Buffer Strokes

| Rated Speed, m/s (ft/min) | Stroke, mm (in.) |
|------------------------------|---------------------|
| 1.00 or less (200 or less) | 40 (1.5) |
| 1.01–1.25 (201–250) | 65 (2.5) |
| 1.26–1.50 (251–300) | 100 (4.0) |

Table 7.9.2.14 Minimum Oil Buffer Strokes

| Rated Speed, m/s (ft/min) | Stroke, mm (in.) |
|------------------------------|---------------------|
| 1.50 (300) | 70 (2.75) |
| 1.60 (325) | 90 (3.50) |
| 1.75 (350) | 110 (4.25) |
| 2.00 (400) | 160 (6.25) |
| 2.25 (450) | 210 (8.25) |
| 2.50 (500) | 280 (11.00) |
| 2.75 (550) | 350 (13.75) |
| 3.00 (600) | 430 (17.00) |
| 3.50 (700) | 630 (24.75) |
| 4.00 (800) | 845 (33.25) |
| 4.50 (900) | 1 110 (43.75) |
| 5.00 (1,000) | 1 410 (55.50) |

not carry persons. Signs conforming to 2.16.5 and reading “NO PERSONS PERMITTED” or an equivalent warning shall be provided within the car enclosure and on the landing side of each entrance door.

7.9.2.7 *Requirement 2.17.4.* Counterweight safeties, where required for material lifts with automatic transfer devices, shall conform to the requirements for car safeties, except as modified by 7.9.2.6, 7.9.2.9, and 7.9.2.10.

7.9.2.8 *Requirement 2.17.7.* The rated speed shall be modified to read 1 m/s (200 ft/min).

7.9.2.9 *Requirement 2.17.8.1.* Type A safeties are permitted for material lifts having a rated speed of 1 m/s (200 ft/min) or less. Safeties actuated by broken or slack suspension ropes are permitted for material lifts having a rated speed of 0.50 m/s (100 ft/min) or less.

7.9.2.10 *Requirement 2.18.1.* The rated speed shall be modified to read 1 m/s (200 ft/min).

7.9.2.11 Requirement 2.19 does not apply.

7.9.2.12 *Requirement 2.22.1.1.* Spring buffers or their equivalent shall be permitted to be used where the rated speed does not exceed 1.5 m/s (300 ft/min).

7.9.2.13 *Requirement 2.22.3.1.* Table 7.9.2.13 shall be used in place of Table 2.22.3.1.

7.9.2.14 *Requirement 2.22.4.1.* Table 7.9.2.14 shall be used in place of 2.22.4.1.

7.9.2.15 *Requirement 2.26.1.* Car-mounted operating devices shall not be permitted unless required for maintenance. Where furnished for such purposes, operating devices shall consist of key-operated switches or be mounted behind a key-locked cabinet. The key shall be Group 1 Security (see 8.1).

7.9.2.16 Requirement 2.26.1.4 does not apply, except where the gross weight (i.e., car, transfer device, rated load, operating devices, etc.) exceeds 680 kg (1,500 lb) a top of car operating device conforming to 2.26.1.4.2 shall be provided.

7.9.2.17 Requirement 2.26.1.5 does not apply.

7.9.2.18 *Requirement 2.26.2.5.* An emergency stop switch (switches) conforming to 2.26.2.5 shall be provided to stop operation of the material lifts, the door operation, and automatic transfer device operation. The emergency stop switch shall be located in the car adjacent to each entrance in a position that shall be accessible to a person standing at the floor adjacent to the car entrance. If a permanently mounted automatic transfer device, located at the landing, blocks the entrance to the car, an emergency stop switch shall be located at that landing in a position accessible to a person standing near that landing in addition to the emergency stop switch in the car.

7.9.2.19 Requirement 2.27 does not apply.

7.9.2.20 Requirement 8.8 applies, except for tack welds and other nonload-carrying welds.

SECTION 7.10 HYDRAULIC MATERIAL LIFTS WITH AUTOMATIC TRANSFER DEVICES

Hydraulic material lifts shall conform to 3.1, 3.18 through 3.20, 3.23 through 3.26, and 3.28, except as modified by 7.9.1, 7.9.2, and 7.11.

SECTION 7.11 MATERIAL LIFTS WITH OBSCURED TRANSFER DEVICES

Any material lift that contains an automatic transfer device not readily visible to the public (e.g., material lifts handling self-propelled carts or with the automatic transfer device mounted fully below the floor with slot operation) shall conform to the requirements of Part 2 or Part 3 of this Code, and shall be classified as a passenger elevator or a freight elevator permitted to carry passengers. Such elevators are permitted to have dual control systems, one for material handling and the other for public use. The material handling system shall be locked out of operation when the material lift is in public use. When operating as a material lift, the operation shall conform to 7.9.

Part 8

General Requirements

SCOPE

Part 8 contains general requirements for *new and existing equipment*.

NOTE: Requirements 8.1, 8.6, 8.7, 8.9, 8.10, and 8.11 apply to both new and existing installations.

SECTION 8.1 SECURITY

8.1.1 General

Key(s) used to access or operate elevator, escalator, moving walk, dumbwaiter, and material lift equipment shall conform to the following:

(a) Keys used to open any other lock in the building shall not access or operate the devices classified as Security Group 1, 2, 3, or 4.

(b) The same key shall be permitted to access or operate all of the devices within only one assigned group (see 8.1.2, 8.1.3, 8.1.4, or 8.1.5), and not those in any other group except as indicated in 8.1.1(c).

(c) The keys for Group 1 devices shall also be permitted to operate Group 2, 3, and 4 devices. The keys for Group 2 devices shall be permitted to operate Group 3 and 4 devices.

(d) Keys shall be kept on the premises in a location readily accessible to the personnel in the assigned group, but not where they are accessible to the general public.

(e) Elevator personnel shall have access to all assigned groups.

(ED) 8.1.2 Group 1: Restricted

Group 1 covers access or operation of equipment restricted to elevator personnel, except as noted.

NOTE: See the following:

- (a) Requirement 2.2.4.4(e), pit access doors.
- (b) Requirement 2.7.3.4.6, access openings in machinery space floor, etc.
- (c) Requirement 2.7.3.4.7(c), hoistway access doors.
- (d) Requirement 2.7.5.1.4, equipment access panels.
- (e) Requirement 2.7.6.3.2(b), motor controller cabinet door(s) or panel(s).
- (f) Requirement 2.7.6.4.3(b), access to the means to move the car from outside the hoistway.
- (g) Requirement 2.7.6.4.3(d), access to removable means to move the car from outside the hoistway.
- (h) Requirement 2.7.6.5.2(b), inspection and test panel enclosure.
- (i) Requirement 3.19.4.4, access to a manual lowering valve.
- (j) Requirement 3.19.4.5, access to pressure gauge fittings.

(k) Requirement 2.11.1.2(h), emergency access doors. (Shall also be made available to emergency personnel during an emergency.)

(l) Requirement 2.12.6.2.4, hoistway door unlocking device. (Shall also be made available to emergency personnel during an emergency.)

(m) Requirement 2.12.7.2.2, hoistway access switch.

(n) Requirement 2.12.7.3.1, hoistway access enabling switch or its locked cover.

(o) Requirement 2.26.1.4.3(b), in-car inspection operation transfer switch.

(p) Requirement 2.26.2.21, in-car stop switch or its locked cover.

(q) Requirement 4.2.5.2, screw machine controllers located away from hoistway, machine room, or machinery space.

(r) Requirement 4.2.5.5, screw machine access panels.

(s) Requirement 5.1.10.1(b), inclined elevator hoistway access switch.

(t) Requirement 5.1.11.1.2(d), inclined elevator uphill end emergency exit.

(u) Requirement 5.7.8.3, hoistway door unlocking device.

(v) Requirement 7.1.12.4, power and hand dumbwaiters without automatic transfer devices hoistway access switch.

(w) Requirement 7.9.2.15, electric material lifts with automatic transfer devices car-mounted operating devices.

8.1.3 Group 2: Authorized Personnel

Group 2 covers access or operation of equipment by authorized and elevator personnel.

NOTE: See the following:

(a) Requirement 2.7.3.4.2, machine room and control room access doors.

(b) Requirements 2.7.3.4.3 and 2.7.3.4.4, machinery spaces and control spaces as specified.

(c) Requirement 2.11.1.4, access openings for cleaning of car and hoistway enclosures.

(d) Requirement 2.14.2.6(b), access openings for cleaning of car and hoistway enclosure.

(e) Requirement 2.14.7.2.1(b), car light control switch or its locked cover.

(f) Requirement 3.19.4.1, access to manually operated shutoff valve.

(g) Requirement 5.6.1.25.2(b), rooftop elevator keyed operation switch.

(h) Requirement 6.1.6.2.1(d), escalator starting switch.

(i) Requirement 6.1.7.3.3, escalator side access door to interior.

(j) Requirement 6.2.6.2.1(d), moving walk starting switch.

(k) Requirement 6.2.7.3.3, moving walk side access door to interior.

8.1.4 Group 3: Emergency Operation

Group 3 covers access or operation of equipment by emergency, authorized, and elevator personnel.

NOTE: See the following:

(a) Requirements 2.27.2.4.1 and 2.27.8, emergency or standby power access selector switch.

(b) Requirements 2.27.3.1.1 and 2.27.8, Phase I emergency recall operation switch.

(c) Requirements 2.27.3.3 and 2.27.8, Phase II emergency in-car operation switch.

(d) Side emergency exit doors on existing equipment.

8.1.5 Group 4: Other

Group 4 covers access or operation of equipment not classified as Group 1, 2, or 3.

NOTE: See the following:

(a) Requirement 5.3.1.18.3, private residence elevator key-operated switch for exterior operation.

(b) Requirement 5.3.1.18.3, private residence inclined elevator keyed operation switch.

SECTION 8.2 DESIGN DATA AND FORMULAS

Requirement 8.2 contains certain design data, formulas, and charts for the designer. It is not intended to limit design. More detailed design and calculation methods shall be permitted to be used, provided that the stresses and deflections required by other sections of this Code are not exceeded.

8.2.1 Minimum Rated Load for Passenger Elevators

The following formulas shall be used for determining the minimum rated load of passenger elevators (see also 2.16.1).

8.2.1.1 For an elevator having an inside net platform area of not more than 4.65 m² (50 ft²)

(SI Units)

$$W = 35A^2 + 325A$$

(Imperial Units)

$$W = 0.667A^2 + 66.7A$$

8.2.1.2 For an elevator having an inside net platform area of more than 4.65 m² (50 ft²)

(SI Units)

$$W = 2.45A^2 + 610A - 620$$

(Imperial Units)

$$W = 0.0467A^2 + 125A - 1,367$$

where

A = inside net platform area, m² (ft²) as specified in Fig. 8.2.1.2

W = minimum rated load, kg (lb)

Figure 8.2.1.2 gives the minimum rated loads for various inside net platform areas.

8.2.2 Electric Elevator Car Frame and Platform Stresses and Deflections

8.2.2.1 General Requirements. The stresses and deflections in side-post-type car frame and platform

members shall be based on the data and formulas listed in 8.2.2.

All stresses and their resultant deflections, not only those based on the data and formulas listed in this Section, shall be considered when side-post-type car frames are located off the platform centerline by more than one-eighth of the distance from the front to the back of the platform.

For cars with corner-post, underslung-type, or other special car frame and platform construction, the formulas and specified methods of calculation of loads and the resulting stresses and deflections do not generally apply and shall be modified to suit the specific conditions and requirements in each case.

The maximum allowable stresses and deflections of members of all car frames and platforms shall be not more than those permitted by 2.15.10 and 2.15.11.

8.2.2.1.1 Formula Symbols. The symbols used in the formulas in 8.2.2 shall have the following meaning:

A = net area of section, m² (in.²)

B = inside clear width of car, mm (in.)

C = net weight of complete elevator car, kg (lb)

D = distance between guide rails, mm (in.)

E = modulus of elasticity of material used, MPa (psi)

G = load supported by crosshead with the maximum load for the class of loading in car at rest at top terminal landing, kg (lb)

H = vertical center distance between upper and lower guide shoes (or rollers), mm (in.)

I = moment of inertia of member, gross section, mm⁴ (in.⁴)

K = turning moment as determined by class of loading, N·mm (lbf·in.)

L = free length of uprights (distance from lowest fastening in crosshead to top fastening in plank), mm (in.)

R = least radius of gyration of section, mm (in.)

W = rated load, kg (lb)

Z = combined section moduli of plank members, gross section, mm³ (in.³)

Z_U = section modulus of one upright, gross section, mm³ (in.³)

8.2.2.2 Car Frame Crosshead. The stresses in the car frame crosshead shall be based on the total load supported by the crosshead with the car and the maximum load for the class of loading in the car when at rest at the top terminal landing.

8.2.2.3 Car Frame Plank (Normal). The stresses in the car frame plank when the stringers are supported directly on the plank members shall be based on the sum of five-eighths of the platform weight uniformly distributed plus the concentrated loads due to the tension in the compensation means and the traveling cables

Fig. 8.2.1.2 Minimum Rated Load for Passenger Elevators

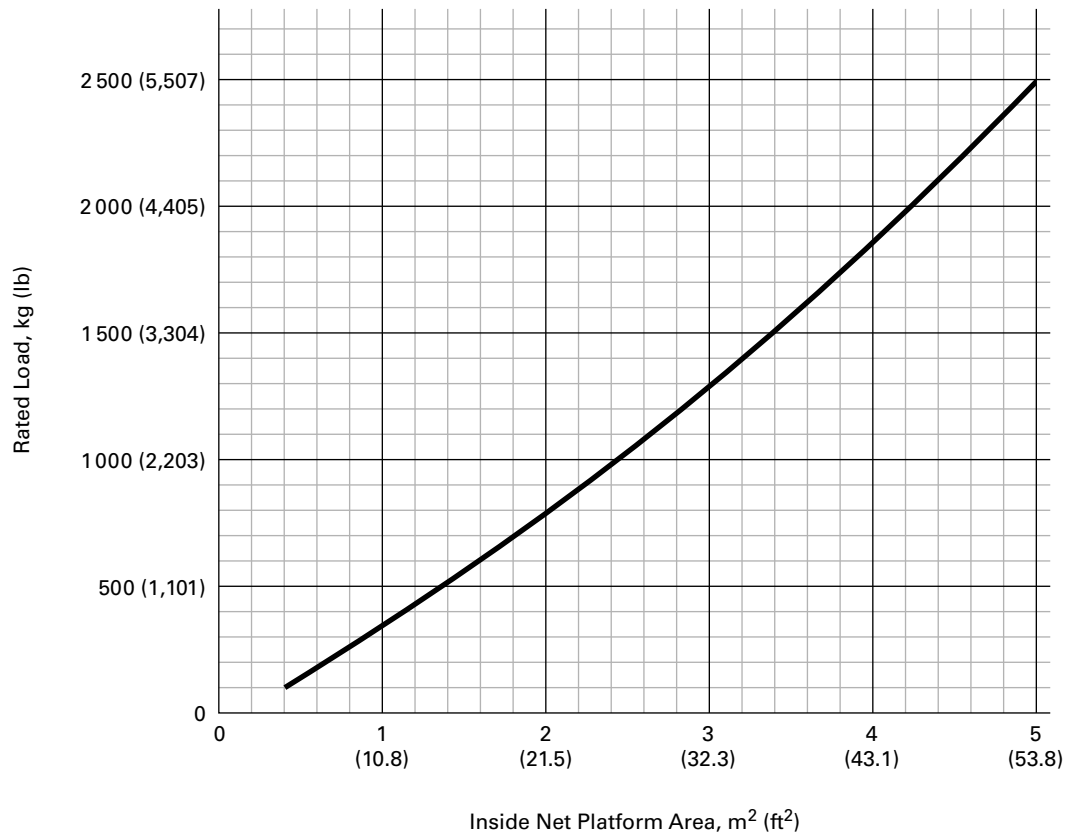
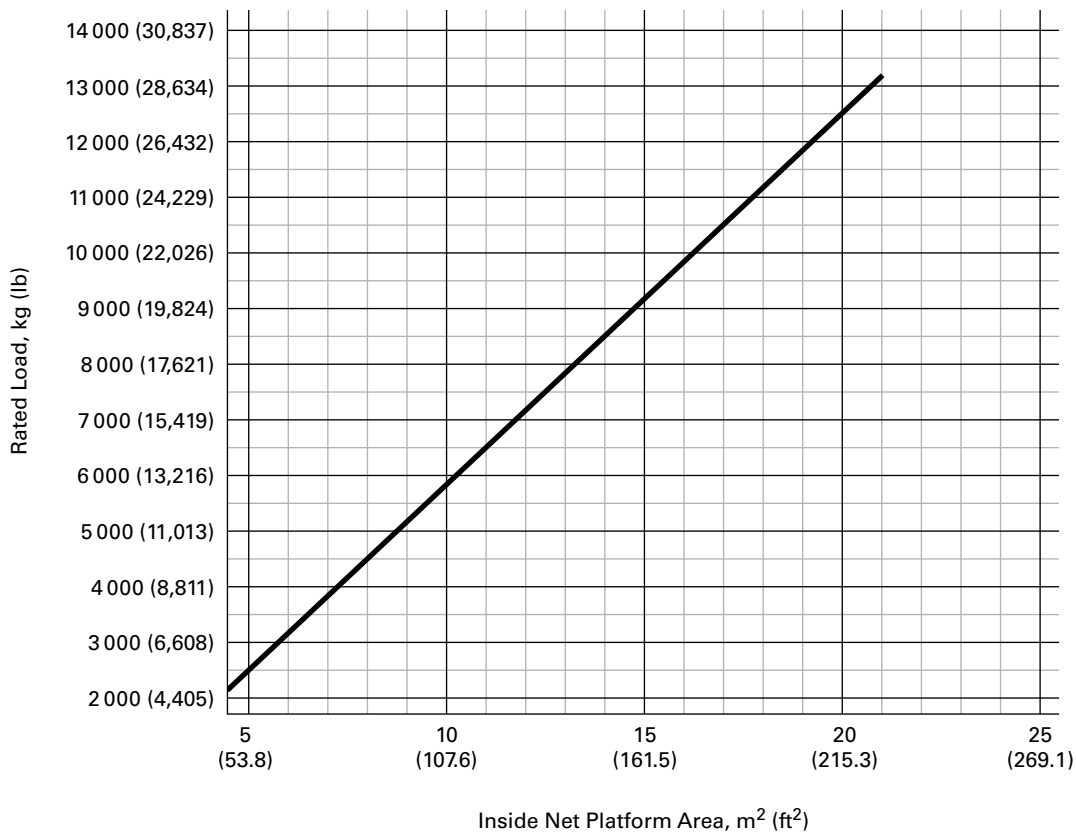

Fig. 8.2.1.2 Minimum Rated Load for Passenger Elevators (Cont'd)



with car at top of its travel plus the loading specified in 8.2.2.3(a) or (b).

(a) For passenger and Class A freight loading, five-eighths of the rated load uniformly distributed.

(b) For Classes B and C freight loading, the loading as specified in 8.2.2.6.

8.2.2.4 Car Frame Plank (Buffer Engagement). In calculating the stress resulting from oil-buffer engagement, one-half the sum of the weight of the car and its rated load shall be considered as being concentrated at each end of the plank with the buffer force applied at the middle. The buffer force shall be considered to be that required to produce gravity retardation with rated load in the car.

The following formula shall be used to determine the stress resulting from buffer engagement:

(SI Units)

$$\text{Stress (MPa)} = 9.807 \frac{D(C+W)}{2Z}$$

(Imperial Units)

$$\text{Stress (psi)} = \frac{D(C+W)}{2Z}$$

Where more than one oil buffer is used, the formula shall be modified to suit the location of the buffers.

NOTE (see 8.2.2.4): Symbols used in the preceding formula are defined in 8.2.2.1.1.

8.2.2.5 Car Frame Uprights (Stiles). The total stress in each car frame upright due to tension and bending, and the slenderness ratio of each upright and its moment of inertia, shall be determined in accordance with the following formulas.

(ED) 8.2.2.5.1 Stress Due to Bending and Tension

(SI Units)

$$\text{Total stress (MPa)} = \frac{KL}{4HZ_u} + \frac{9.807G}{2A}$$

(Imperial Units)

$$\text{Total stress (psi)} = \frac{KL}{4HZ_u} + \frac{G}{2A}$$

Where $KL/4HZ_u$ is the bending stress in each upright in the plane of the frame due to live load W on the platform for the class of loading A, B, or C for which the elevator is to be used (see 2.16.2.2); $G/2A$ is the tensile strength in each upright, and K is determined by the following formulas [see Fig. 8.2.2.5.1]:

(a) For Class A freight loading or passenger loading

(SI Units)

$$K = 9.807 \left(\frac{WB}{8} \right)$$

(Imperial Units)

$$K = \frac{WB}{8}$$

(b) For Class B freight loading

(SI Units)

$$K = 9.807 W \left(\frac{B}{2} - 1.219 \right) \text{ or } K = 9.807 \left(\frac{WB}{8} \right)$$

whichever is greater.

(Imperial Units)

$$K = W \left(\frac{B}{2} - 48 \right) \text{ or } K = \frac{WB}{8}$$

whichever is greater.

(c) For Class C freight loading

(SI Units)

$$K = 9.807 \left(\frac{WB}{4} \right)$$

(Imperial Units)

$$K = \frac{WB}{4}$$

NOTE (8.2.2.5.1): Symbols used in the preceding formulas are defined in 8.2.2.1.1.

8.2.2.5.2 Slenderness Ratio. The slenderness ratio L/R for uprights subject to compressions other than those resulting from safety and buffer action shall not exceed 120. Where the upper side-brace connections on passenger elevator car frame uprights are located at a point less than two-thirds of L from the bottom, (top fastening

Fig. 8.2.2.5.1 Turning Moment Based on Class of Loading

(ED)

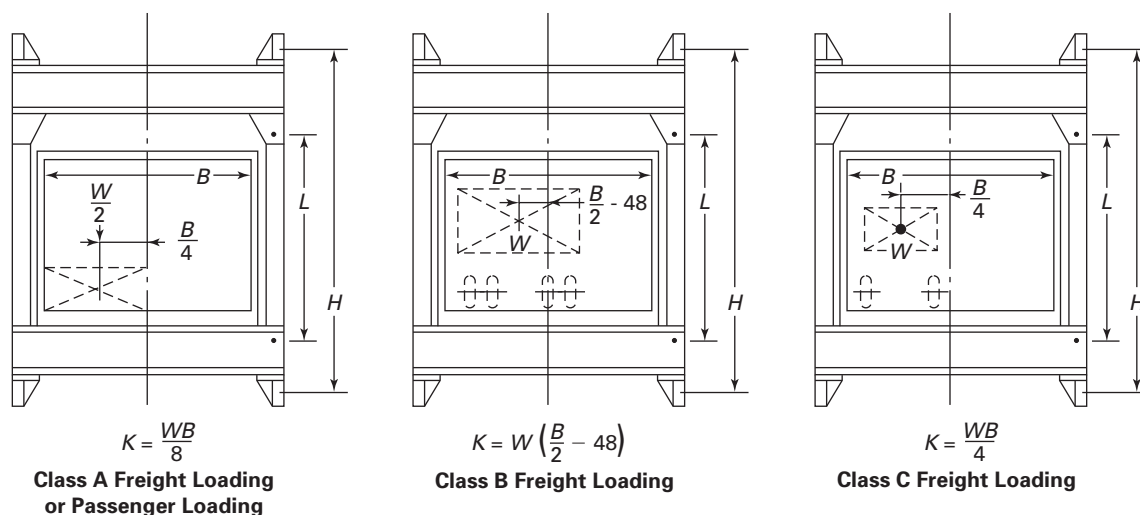

GENERAL NOTE: See 8.2.2.5.1 for formulas in SI Units.

in car frame plank) a slenderness ratio of L/R not exceeding 160 is permissible ($L/R \leq 160$).

NOTE (8.2.2.5.2): Symbols used in the above formulas are defined in 8.2.2.1.1.

8.2.2.5.3 Moment of Inertia. The moment of inertia of each upright shall be not less than determined by the following formula:

(SI Units)

$$I = \frac{KL^3}{457.2EH}$$

(Imperial Units)

$$I = \frac{KL^3}{18EH}$$

NOTE (8.2.2.5.3): Symbols used in the preceding formula are defined in 8.2.2.1.1.

8.2.2.6 Freight Elevator Platform. The calculation for stresses in the platform members of freight elevators shall be based on the following concentrated loads assumed to occupy the position that will produce the maximum stress:

(a) for Class A Loading, 25% of the rated load

(b) for Class B Loading, 75% of the rated load or 15 400 kg (34,000 lb), whichever is less, divided into two equal parts 1 525 mm (60 in.) apart

(c) for Class C1 Loading, with a load rating of 9 000 kg (20,000 lb) or less, 80% of the rated load divided into two equal parts, 765 mm (30 in.) apart

(d) for Class C2 Loading, with a load rating of 9 000 kg (20,000 lb) or less, 80% of the rated load or of the loaded truck weight, whichever is greater, divided into two equal parts, 765 mm (30 in.) apart

(e) for Class C1 or C2 Loading, with a rated load in excess of 9 000 kg (20,000 lb), 80% of the 9 000 kg (20,000 lb) or of the maximum loaded truck weight, whichever is greater, divided into two equal parts, 765 mm (30 in.) apart

(f) for Class C3 Loading, determined on the basis of the actual loading conditions but not less than that required for Class A loading

8.2.2.7 Hoisting Rope Hitch Plates and Shapes. The stresses in hoisting rope hitch plates and shapes shall be based on the total applied rope load with the car and its rated load at rest at the top terminal landing.

8.2.3 Impact on Buffer Supports

8.2.3.1 Buffer Reaction and Impact for Oil Buffer Supports. The following formulas give the buffer reaction and the impact on the car and counterweight oil buffer supports resulting from buffer engagement [see 2.1.2.3(a) or 3.22.1.2.1]:

(a) Buffer Reaction

(SI Units)

$$R = W \left(9.807 + \frac{v^2}{25} \right)$$

(Imperial Units)

$$R = W \left(1 + \frac{v^2}{64.45} \right)$$

(b) Impact

$$P = 2R$$

8.2.3.2 Buffer Reaction and Impact for Spring Buffer Supports. The following formulas give the buffer reaction and the impact on the supports of car and counterweight spring buffers that do not fully compress under the conditions outlined in 2.1.2.3(a):

(a) *Buffer reaction*

(SI Units)

$$R = 2W \left(9.807 + \frac{V^2}{2S} \right)$$

(Imperial Units)

$$R = 2W \left(1 + \frac{V^2}{64.4S} \right)$$

(b) *Impact*

$$P = R$$

where

- P = impact, N (lbf)
- R = buffer reaction, N (lbf)
- S = buffer stroke, m (ft)
- V = speed at impact (for electric), m/s (ft/s); operating speed in the down direction (for hydraulic), m/s (ft/s)
- W = weight of car plus rated load or weight of counterweight, kg (lb)

8.2.4 Gravity Stopping Distances

The following formula gives the value of the stopping distance based on gravity retardation from any initial velocity (see 2.4.6, 2.4.8, 2.4.9, and 2.22.4.1):

(SI Units)

$$S = 51V^2$$

(Imperial Units)

$$S = \frac{V^2}{19,320}$$

where

- S = free fall (gravity stopping distance), mm (in.)
- V = initial velocity, m/s (ft/min)

Figure 8.2.4 shows the gravity stopping distances from various initial velocities.

8.2.5 Governor Tripping Speeds

Figure 8.2.5 gives the maximum governor tripping speeds for various rated speeds (see 2.18.2.1).

8.2.6 Stopping Distances for Car and Counterweight Safeties

The following formulas shall be used to determine the maximum and minimum stopping distances for Type B car and counterweight safeties (see 2.17.3):

(SI Units)

$$S = \frac{V^2}{6.870} + 0.2560$$

$$S' = \frac{V^2}{19.63}$$

(Imperial Units)

$$S = \frac{V^2}{81,144} + 0.84$$

$$S' = \frac{V^2}{231,840}$$

where

- S = maximum stopping distance, m (ft)
- S' = minimum stopping distance, m (ft)
- V = governor tripping speed, m/s (ft/min)

Figure 8.2.6 shows the maximum and minimum stopping distances from various governor tripping speeds.

8.2.7 Factors of Safety for Suspension Wire Ropes for Power Elevators

Figure 8.2.7 shows the minimum factors of safety for suspension wire ropes of power elevators for various rope speeds (see 2.20.3).

8.2.8 Hydraulic Jack and Piping

8.2.8.1 Plunger Design. Plungers shall be designed and constructed in accordance with one of the following formulas (8.2.8.1.1 through 8.2.8.1.4).

8.2.8.1.1 Plungers Not Subject to Eccentric Loading

(a) Where slenderness ratio of plunger is less than 120

(SI Units)

$$\frac{W}{A} = 9.377 \times 10^7 - 3.344 \times 10^3 (L/R)^2$$

(Imperial Units)

$$\frac{W}{A} = 13,600 - 0.485 (L/R)^2$$

(b) Where slenderness ratio of plunger is greater than 120

(SI Units)

$$\frac{W}{A} = \frac{6.550 \times 10^{11}}{(L/R)^2}$$

(Imperial Units)

$$\frac{W}{A} = \frac{95,000,000}{(L/R)^2}$$

Fig. 8.2.4 Gravity Stopping Distances

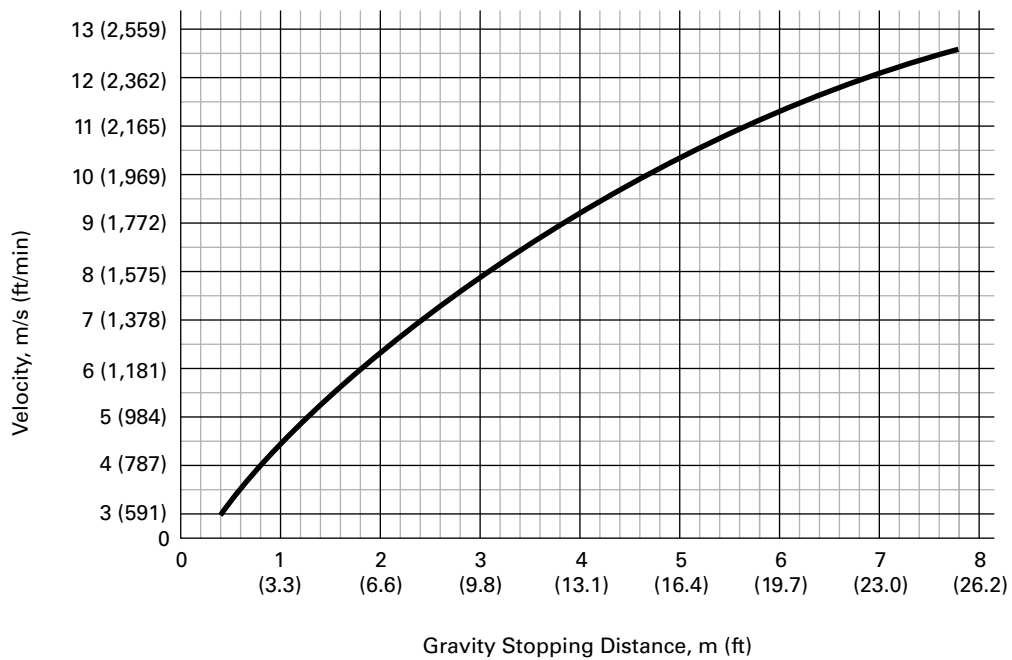
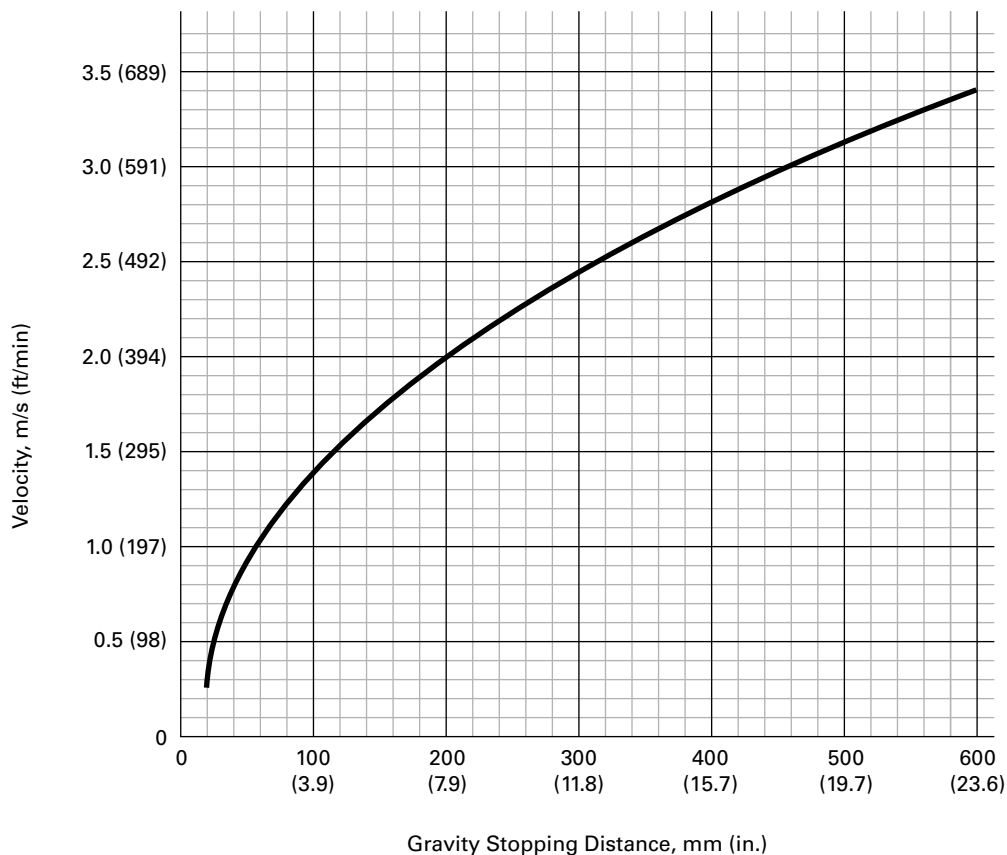

Fig. 8.2.5 Maximum Governor Tripping Speeds

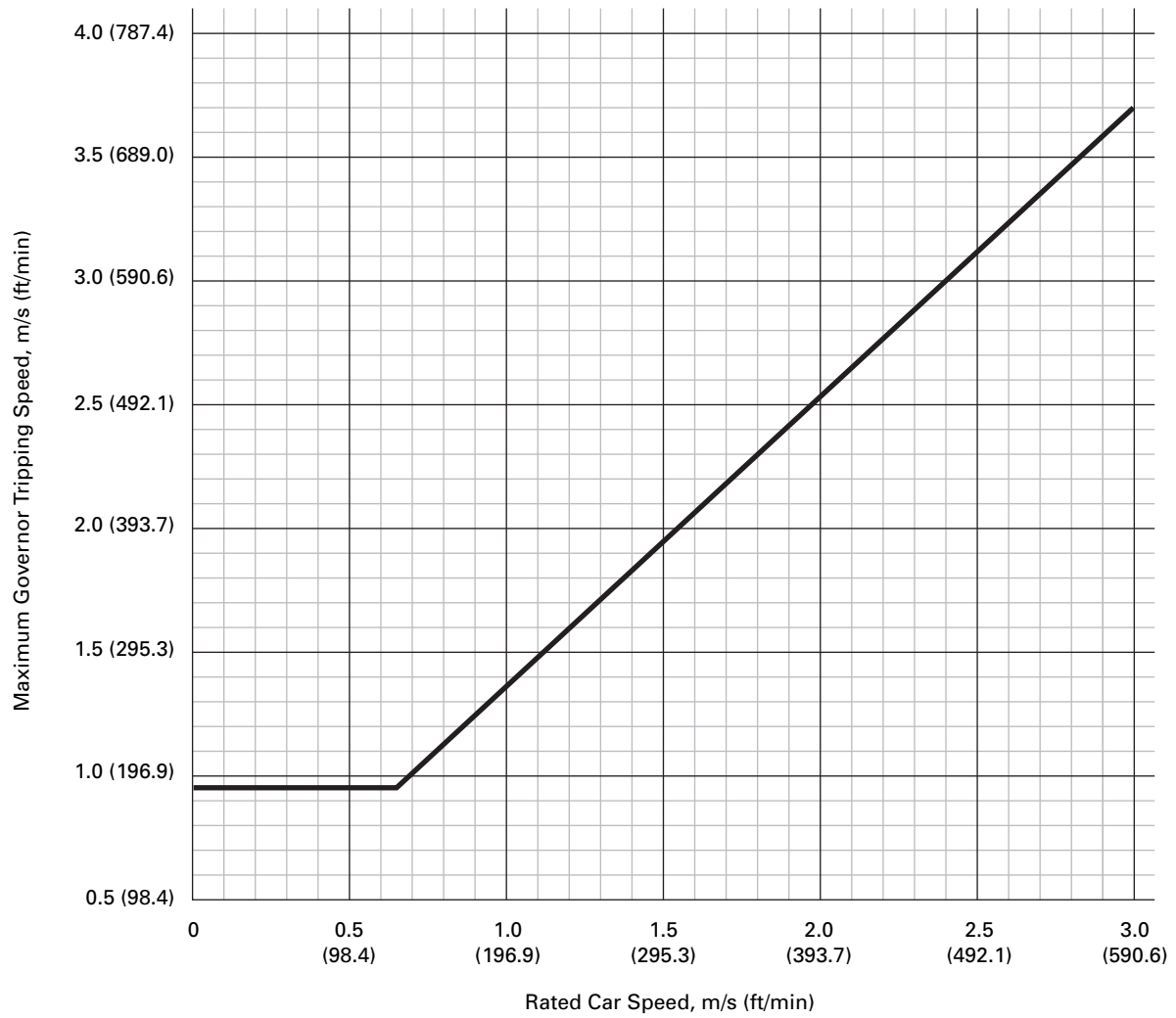

Fig. 8.2.5 Maximum Governor Tripping Speeds (Cont'd)

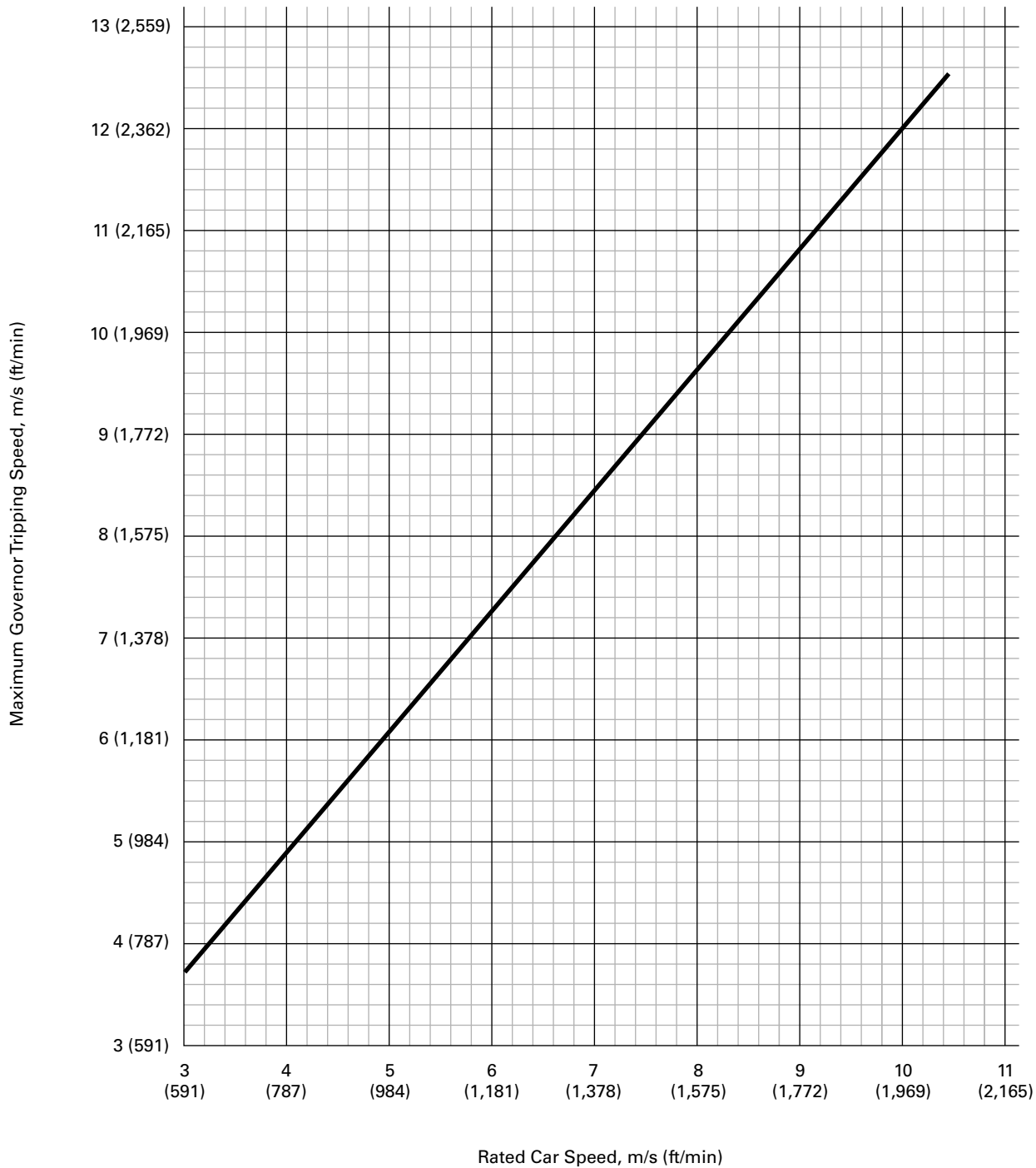

Fig. 8.2.6 Stopping Distances for Type B Car and Counterweight Safeties

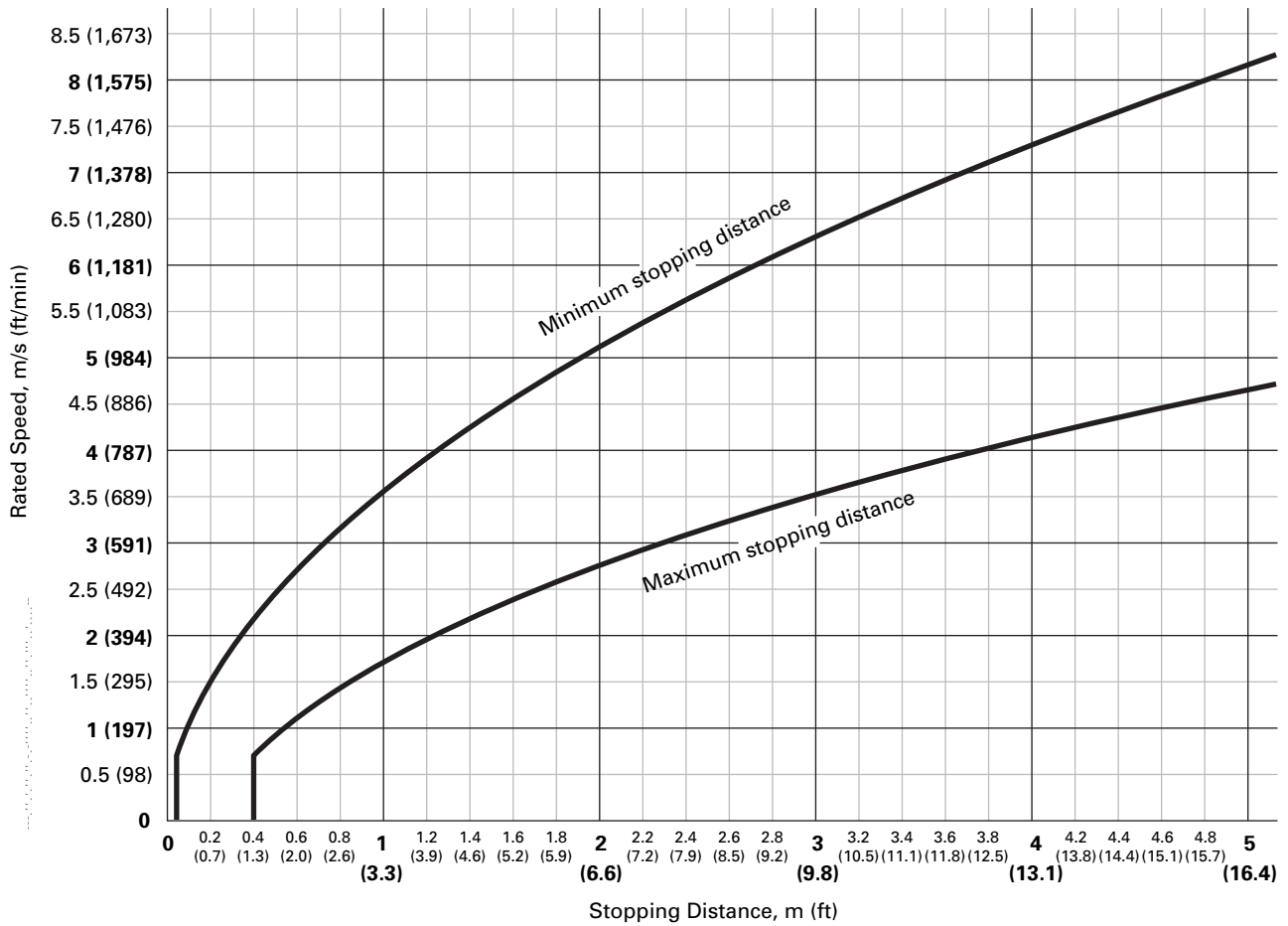

Fig. 8.2.6 Stopping Distances for Type B Car and Counterweight Safeties (Cont'd)

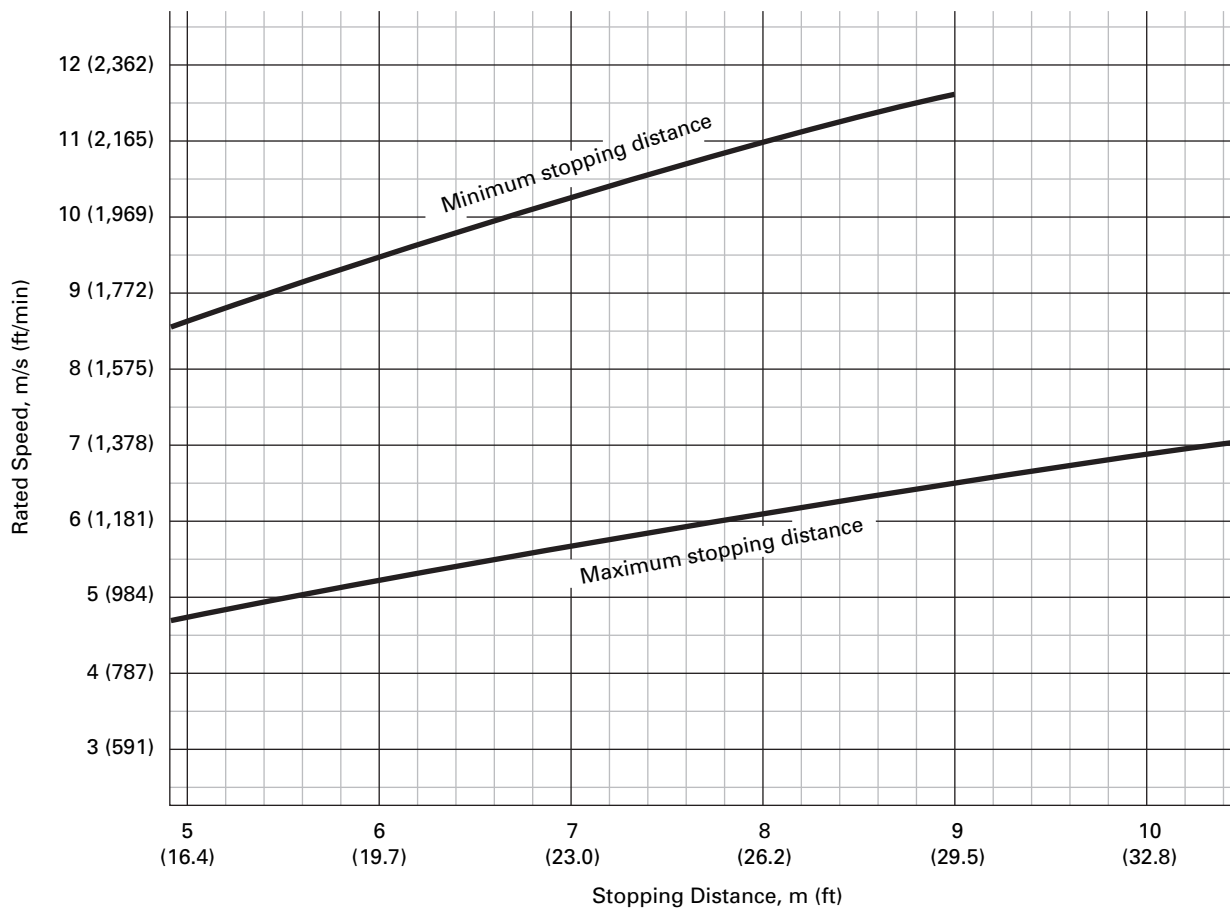

Fig. 8.2.6 Stopping Distances for Type B Car and Counterweight Safeties (Cont'd)

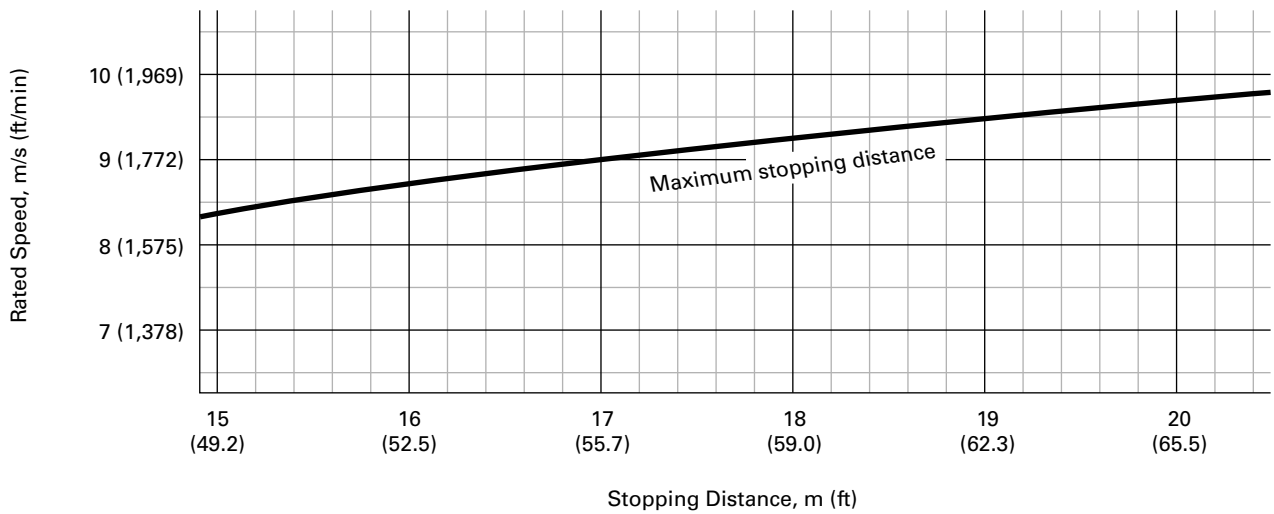
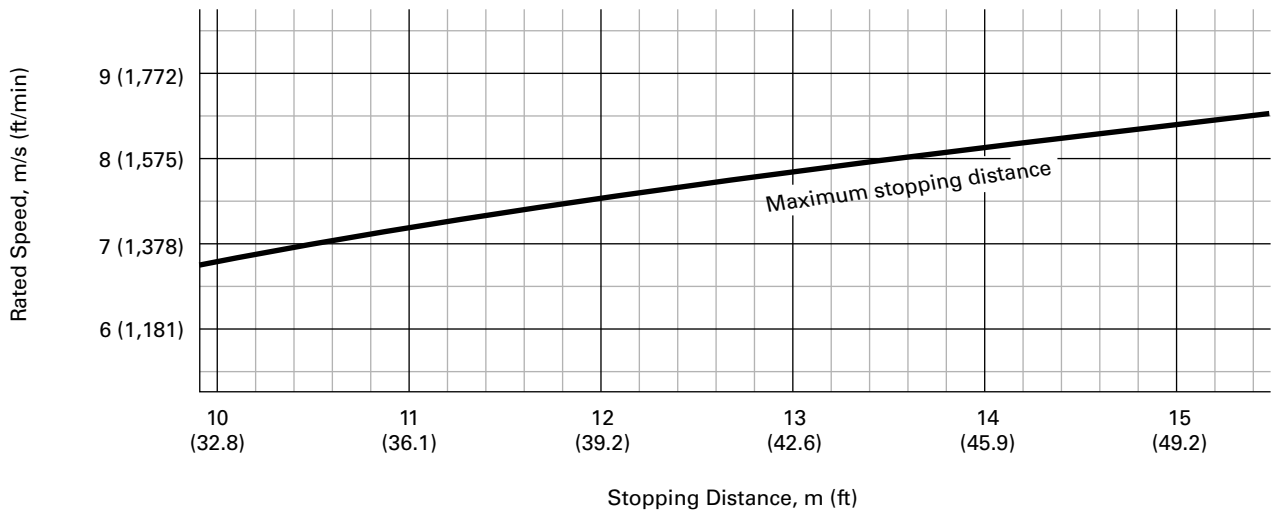
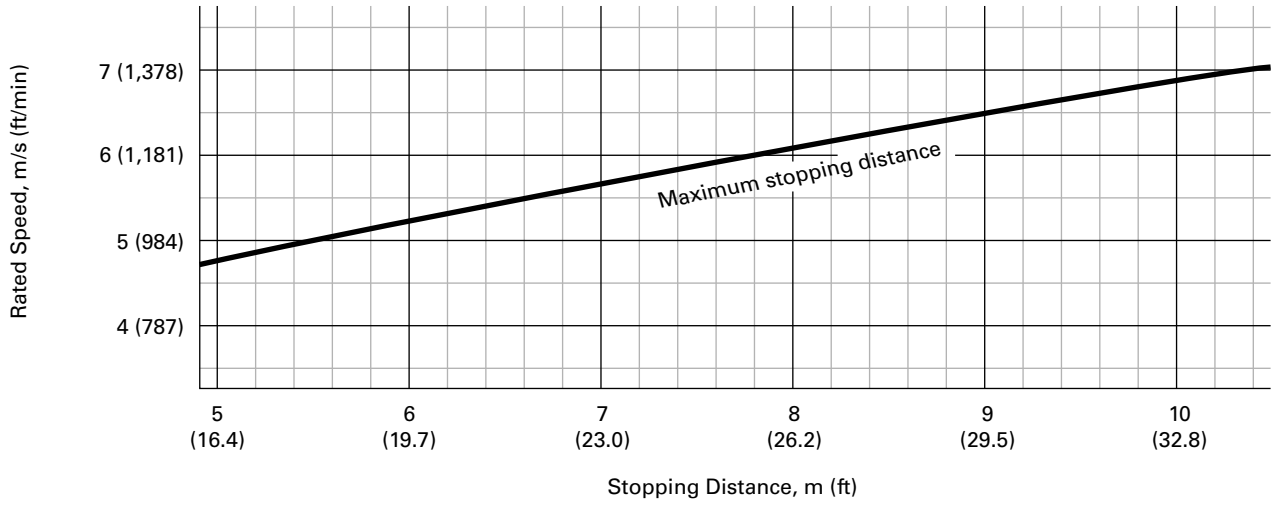
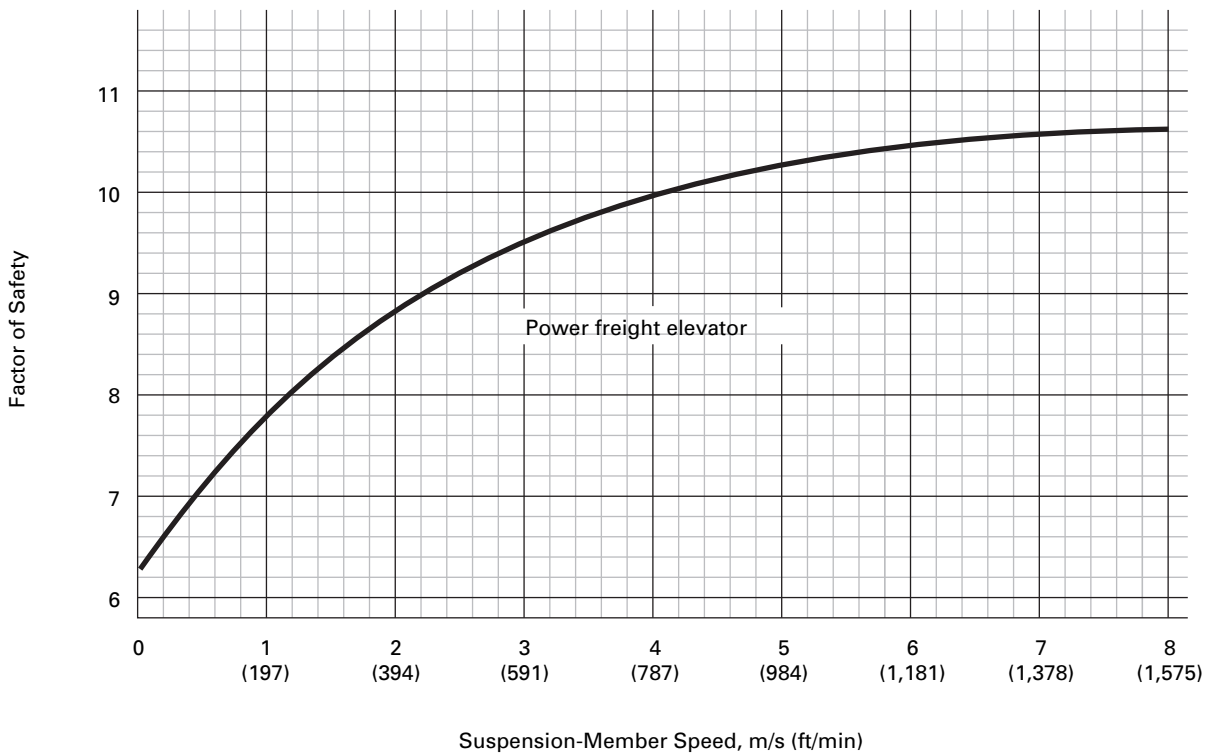
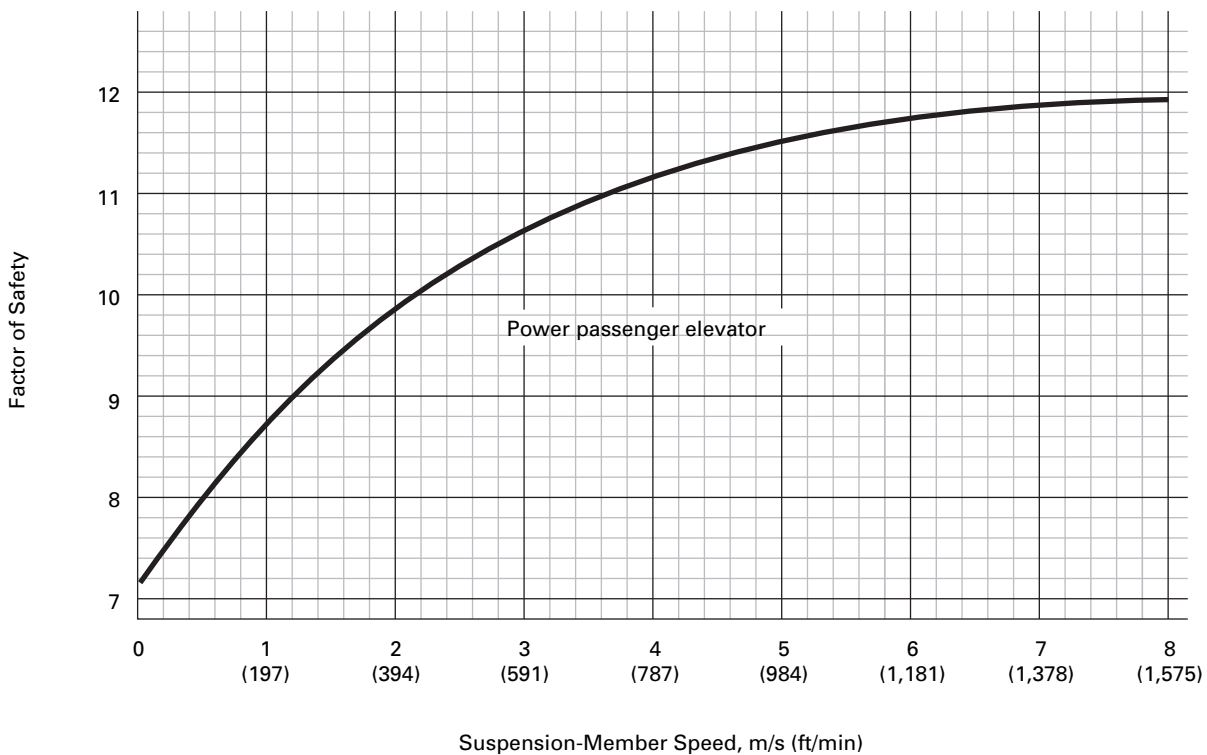

Fig. 8.2.7 Minimum Factors of Safety of Suspension Members of Power Passenger and Freight Elevators



Formulas are for steel where

A = net sectional area of plunger (area of metal), m^2 (in.^2)

L = maximum free length of plunger, mm (in.). Where a plunger-follower guide conforming to 3.18.2.7 is used, L shall be taken as one-half the amount that the free length would be if no follower guide were provided.

R = radius of gyration of plunger section, mm (in.)

W = allowable gross weight to be sustained by plunger, N (lbf). Where a counterweight is provided, the weight of the counterweight plus the unbalanced weight of the counterweight ropes shall be permitted to be deducted in determining W . In determining W , one-half of the weight of the plunger shall be included except where a plunger-follower guide conforming to 3.18.2.7 is used, in which case, three-fourths of the plunger weight shall be included.

W/A = fiber stress, kPa (psi)

NOTE [8.2.8.1.1(a) and (b)]: Figure 8.2.8.1.1 has been calculated from the formulas given in 8.2.8.1.1 for the more usual pipe sizes and pipe schedules and indicate allowable gross loads directly.

(c) Plungers having a free length of 7.6 m (25 ft) or less shall be permitted to be accepted without further examination for strength and elastic stability, provided all of the following conditions exist:

(1) the working pressure is 2 070 kPa (300 psi) or less

(2) the plunger is 100 mm (4 in.) nominal pipe size or larger

(3) pipe not lighter than schedule 40 is used, and not more than 1.6 mm (0.063 in.) of metal has been removed from the wall thickness in machining

(d) *Plungers With Varying Cross Section.* For plungers with varying cross section, the stress shall be calculated for a factor of safety of at least 3 using accepted methods for elastic stability.

8.2.8.1.2 Plungers Subject to Eccentric Loading.

For plungers subject to bending, the stresses due to bending as determined by the following formulas shall be subtracted from the stresses W/A as determined by the applicable formula in 8.2.8.1.1.

(SI Units)

$$S = \left(\frac{W_b e}{Z} \right)$$

(Imperial Units)

$$S = \frac{W_b e}{Z}$$

where

e = eccentricity of W_b , mm (in.)

S = stress due to bending, MPa (psi)

W_b = maximum eccentric load, N (lbf). Where any or all of this load is caused by moving wheel loads imposed on the edge of the platform, the total of such loads shall be doubled for impact (see 8.2.2.6).

Z = section modulus of plunger section, mm^3 (in.^3)

8.2.8.1.3 Plungers Subjected to External Pressure.

For plungers subjected to external pressure, the working pressure shall be not more than that indicated by the following formulas.

(a) Where the ratio of t/D is less than 0.023:

(SI Units)

$$p = 2\,296 \left[1 - \sqrt{1 - 1\,600 \left(\frac{t}{D} \right)^2} \right]$$

(Imperial Units)

$$p = 333 \left[1 - \sqrt{1 - 1\,600 \left(\frac{t}{D} \right)^2} \right]$$

(b) Where the ratio of t/D is greater than 0.023:

(SI Units)

$$p = 199\,200 \frac{t}{D} - 3\,185$$

(Imperial Units)

$$p = 28\,890 \frac{t}{D} - 462$$

where

D = external finished diameter, mm (in.)

p = working pressure, kPa (psi)

t = finished wall thickness, mm (in.)

8.2.8.1.4 Telescoping Plungers. Telescoping plungers shall have each plunger section internally guided. If more than two movable sections are used, plunger follower guides shall be provided for each plunger section. In the formulas in 8.2.8.1.1(a) and 8.2.8.1.1(b), the values of A and R shall be for the smallest plunger section. When plunger follower guides are used, the value of L shall be the maximum free length of the smallest section in millimeters (inches). When plunger follower guides are not used, the value of L shall be taken as 1.4 times the maximum free length of the smallest plunger section.

8.2.8.2 Cylinder Design. Cylinders shall be designed and constructed in accordance with the following formula:

$$t = \frac{pd}{2S} + C$$

Fig. 8.2.8.1.1 Allowable Gross Loads

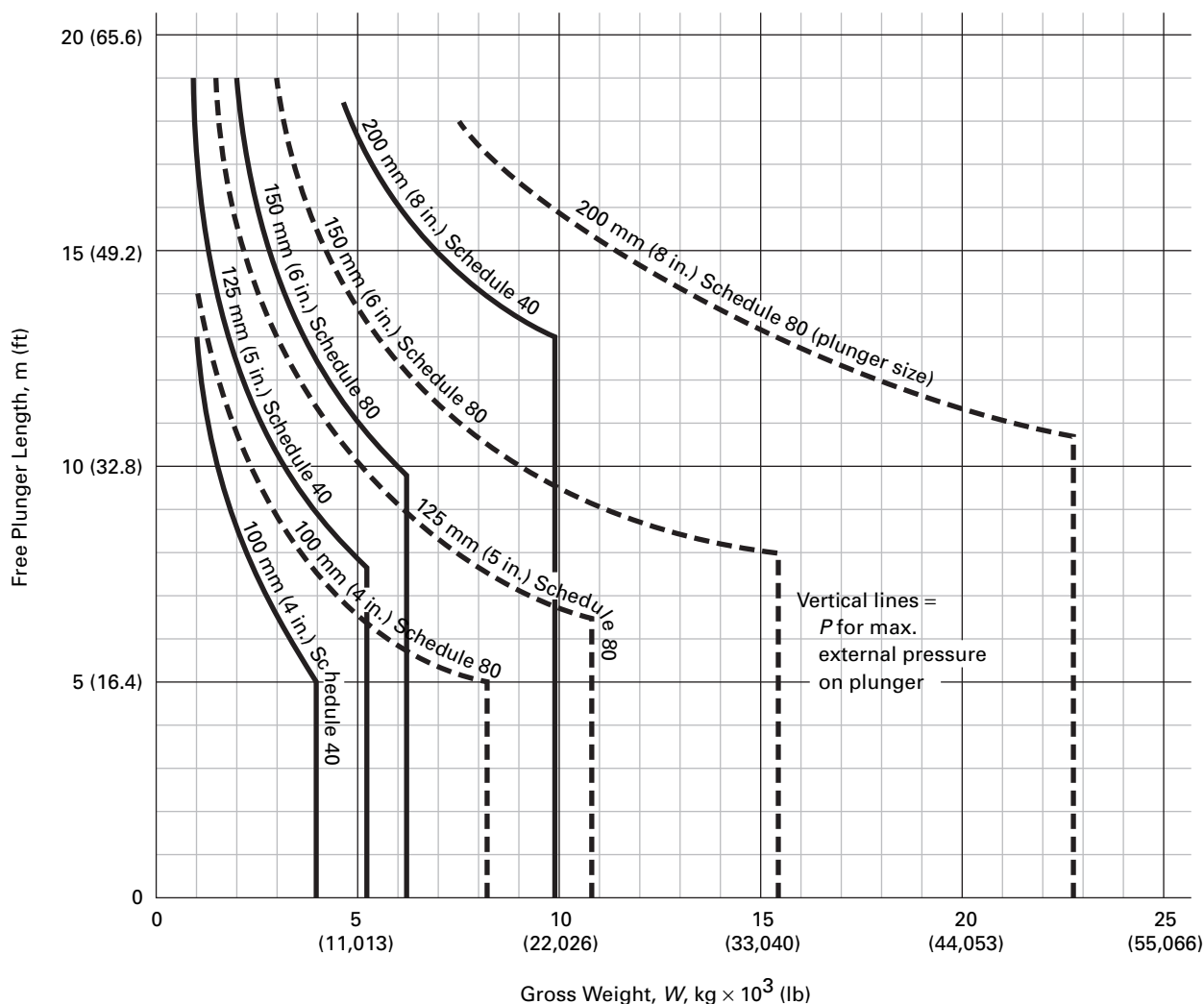

GENERAL NOTES:

- (a) Curves are based upon the removal of not more than 1.5 mm (0.0625 in.) from the wall thickness in machining.
- (b) Curves stop at 18 m (59 ft) for convenience only. For plunger sizes or lengths not shown on this chart, see the applicable formula in 8.2.8.1.1.

where

- C = depth of the thread or groove, mm (in.)
- d = internal diameter, mm (in.)
- p = working pressure, kPa (psi)
- S = allowable stress, kPa (psi) (see 8.2.8.5.2)
- t = minimum thickness of wall, mm (in.)

8.2.8.3 Cylinder and Plunger Heads. Heads of cylinders and heads of plungers subject to fluid pressure shall be designed and constructed in accordance with one of the following applicable formulas:

(a) Flat unreinforced heads

$$t = d \sqrt{\frac{p}{4S}}$$

(b) Dished seamless hemispherical heads, concave to pressure

$$t = \frac{5pr}{6S}$$

(c) Dished seamless ellipsoidal heads, concave to pressure (ellipsoidal heads in which one-half of the minor axis equals one-quarter the inside diameter of skirt),

$$t = \frac{5pD}{6S}$$

where

D = inside diameter of skirt, mm (in.)

Fig. 8.2.8.1.1 Allowable Gross Loads (Cont'd)

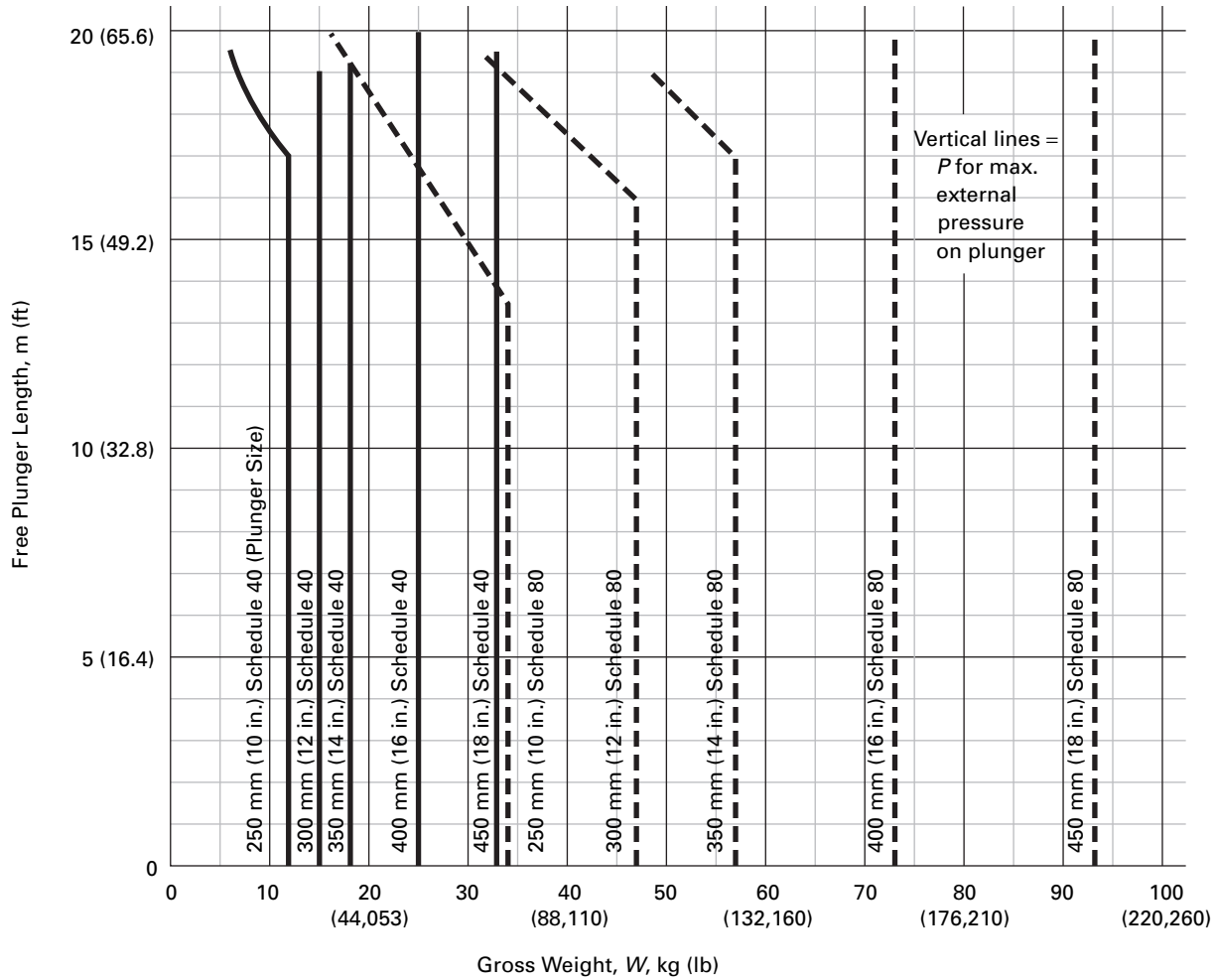

GENERAL NOTES:

- (a) Curves are based upon the removal of not more than 1.5 mm (0.0625 in.) from the wall thickness in machining.
- (b) Curves stop at 18 m (59 ft) for convenience only. For plunger sizes or lengths not shown on this chart, see the applicable formula in 8.2.8.1.1.

- d = diameter of head between supporting edges, mm (in.)
- p = working pressure, kPa (psi)
- r = radius to which head is dished, measured on concave side (not greater than d), mm (in.)
- S = allowable stress, kPa (psi) (see 8.2.8.5.2)
- t = minimum thickness of head, mm (in.)

8.2.8.4 Wall Thickness of Pressure Piping. The minimum wall thickness of pipe shall be 1.65 mm plus C or as determined by the following:

$$t = \frac{pD}{2eS} + C$$

or

$$\left(t - C = \frac{pD}{2eS} \right)$$

where

- C = 1.3 mm (0.05 in.) for threaded pipe up to 9.5 mm ($\frac{3}{8}$ in.) pipe size, the depth of the thread in millimeters for threaded pipe over 9.5 mm ($\frac{3}{8}$ in.) pipe size, the depth of groove in millimeters for grooved pipe, or 0.000 for other pipe or unreduced thickness
- D = the outside diameter of pipe, mm (in.)
- e = the joint efficiency: 1 for seamless pipe; 0.85 for electric resistance welded pipe
- p = the maximum working pressure, kPa (psi)
- t = the minimum wall thickness, mm (in.)
- S = the allowable stress, based on a factor of safety in accordance with 8.2.8.5.2, kPa (psi)

Steel pipes and fittings used for gauge ports need not comply with this formula, but shall be a minimum of

Schedule 80 pipe and maximum length of 75 mm (3 in.), except as permitted by 3.19.2.4.

8.2.8.5 Factor of Safety

8.2.8.5.1 Except as required in 3.19.3.3.1(b), the minimum factor of safety for components subject to fluid pressure shall be as follows:

$$F = \frac{5.04}{E - 2.8} + 2.7$$

where

E = percent elongation in 50 mm (2 in.) gauge length as per ASTM Standard E8 expressed as a whole number (e.g., 20% = 20 and 5% = 5). The minimum allowable E shall be 5.

F = minimum factor of safety based on 0.2% proof stress yield point. The minimum allowable F shall be 3.

8.2.8.5.2 The allowable stress to be used in 8.2.8.2 through 8.2.8.4 shall be determined as follows:

$$S = \frac{Y.P.}{F}$$

where

F = minimum factor of safety based on 0.2% proof stress yield point as determined in 8.2.8.5.1

S = allowable stress kPa (psi)

$Y.P.$ = yield point, based on 0.2% proof stress yield point, kPa (psi)

8.2.8.6 Plunger Gripper Application Pressure. The maximum pressure to be applied by the plunger gripper to avoid local buckling should be calculated as follows for steel:

(SI Units)

$$P_{\max} = 2.9 \times 10^5 \left(\frac{t}{D} \right)^3$$

(Imperial Units)

$$P_{\max} = 4.2 \times 10^7 \left(\frac{t}{D} \right)^3$$

where

D = outside diameter of plunger, mm (in.)

P_{\max} = maximum pressure, MPa (psi)

t = minimum wall thickness, mm (in.)

8.2.9 Hydraulic Elevator Car Frame and Platform Stresses and Deflections

8.2.9.1 General Requirements. The stresses and deflections in side-post-type car frame and platform members shall be based on the data and formulas listed in 8.2.9.

All stresses and their resultant deflections, not only those based on the data and formulas in this Section, shall be considered when side-post-type car frames are located off the platform center line by more than one-eighth of the distance from the front to the back of the platform.

For cars and corner-post, sub-post, or other special car frame and platform construction, the formulas and specified methods of calculation of loads and the resulting stresses and deflections do not generally apply and shall be modified to suit the specific conditions and requirements in each case.

The maximum allowable stresses and deflections of members of all car frames and platforms shall be not more than those permitted by 3.15.2.

8.2.9.1.1 Maximum Stresses in Car Frame Uprights. The maximum stresses in car frame uprights that are normally subject to compression shall be such that the quantity $[(f_a / F_a) + (f_b / F_b)]$ does not exceed unity

where

F_a = allowable axial compressive unit stress [not exceeding $117\,200 - 3.344 (L/R)^2$ in SI units and $17,000 - 0.485 (L/R)^2$ in Imperial units]

f_a = actual axial compressive unit stress based on gross section

F_b = allowable bending unit stress [113 MPa (16,500 psi), if area basis is gross section or 138 MPa (20,000 psi) if area basis is net section]

f_b = actual bending unit stress

L = free length of uprights (distance from lowest fastening in crosshead to top fastening in plank), mm (in.)

R = least radius of gyration of section, mm (in.)

8.2.9.1.2 Car Frame Crosshead. The stresses in the car frame crosshead shall be based on the total load, if any, supported by the crosshead.

The crosshead members(s) and connection between the crosshead and upright (stile) shall be designed to resist the bending moment, shear and axial forces transferred between the upright and the crosshead.

8.2.9.1.3 Car Frame Plank. The bending stresses in the car frame planks due to the normal loading shall be based on the following loads:

(a) concentrated load(s) located at their point of application equal to the total maximum static load on all the driving members lifting the car divided by the number of lifting members [see Fig. 8.2.9.1.3, sketch (a)]

(b) five-eighths of the platform weight uniformly distributed over the length of the planks when the platform members are supported directly by the plank members [see Fig. 8.2.9.1.3, sketch (b)]

Fig. 8.2.9.1.3 Load Distribution

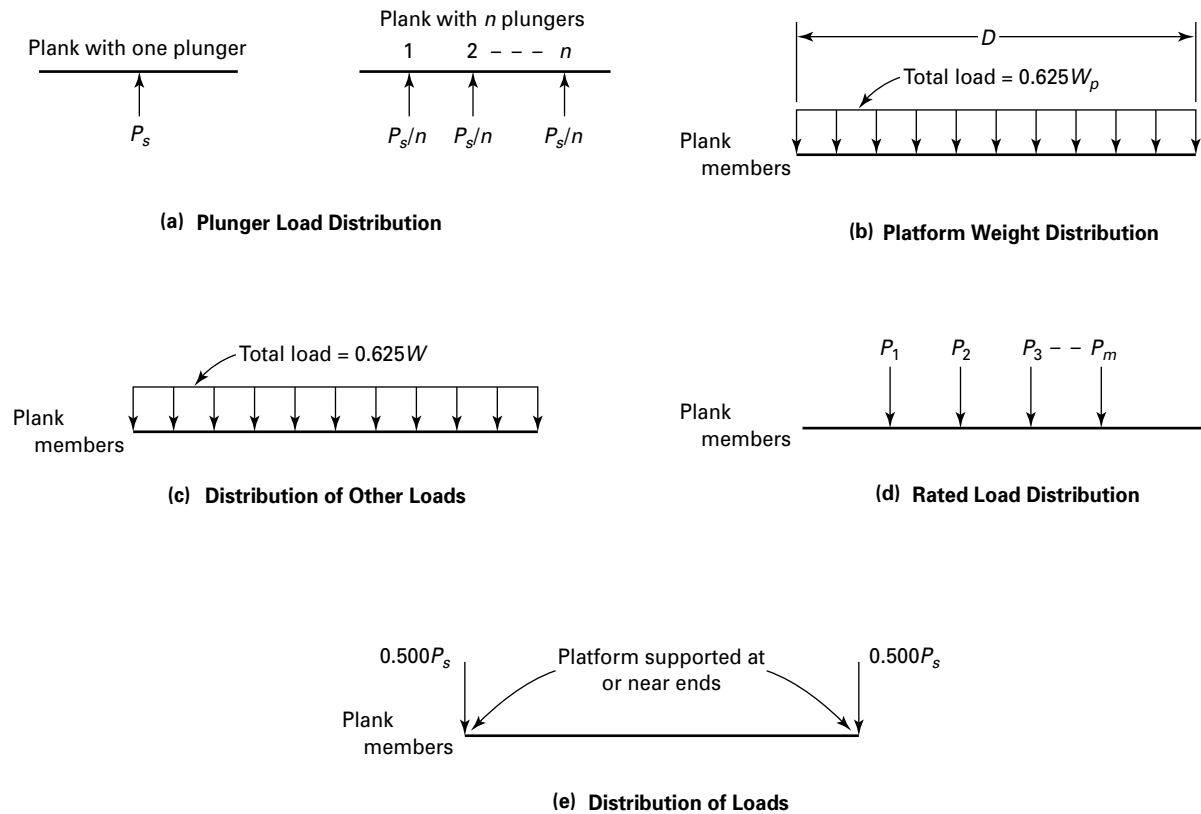

D = distance between guide rails, m (in.)
 W = rated load, kg (lb) (passenger or Class A freight)
 W_p = platform weight, kg (lb)
 P_1, P_2, P_3, P_m = balance of loads acting on the plank members located at their respective points of application. Such loads typically include the weights of cab and doors, carframe members and guide shoes, traveling cables, electrical devices, door devices, and the balance of load distributions of the platform weight and rated load not distributed to the plank members.
 P_s = total maximum static load on all the driving members, kg (lb)

GENERAL NOTES:

- (a) 1 mm = 1 in./25.4 (1 in. = 25.4 mm);
- (b) 1 kg = 1 lb/0.454 (1 lb = 0.454 kg).

(c) the duty load distribution is as follows:

(1) for passenger and Class A freight loading, five-eighths of the rated load uniformly distributed over the length of the planks when the platform members are supported directly by the plank members [see Fig. 8.2.9.1.3, sketch (c)]

(2) for Classes B and C freight loading, the loading in conformance with 8.2.2.6

(d) the balance of loads shall be taken as acting at their respective point(s) of application [see Fig. 8.2.9.1.3, sketch (d)]

(e) where the platform members are only supported directly by the planks at or adjacent to the ends of the planks, 8.2.9.1.3(b) and 8.2.9.1.3(c)(1) do not apply, and concentrated loads equal to one-half of the total maximum static load on all the driving members shall be applied at each end of the planks [see Fig. 8.2.9.1.3, sketch (e)]

8.2.9.1.4 Car Frame Uprights (Stiles). The stresses in each car frame upright due to compression and bending and the slenderness ratio of each upright and its

moment of inertia shall be determined in accordance with the following formulas:

(a) *Stresses Due to Bending*

$$f_b = \frac{KL}{4HZ_u}$$

where

f_b = the bending stress in each upright in the plane of the frame due to the live load W on the platform for the class of loading A, B, or C for which the elevator is to be used (see 2.16.2.2 and 3.16)

K = turning moment in N·m (lbf-in.) as determined by the class of loading (see Fig. 8.2.2.5.1) by the following formulas

(1) For Class A freight loading or passenger loading

(SI Units)

$$K = 9.807 \left(\frac{WB}{8} \right)$$

(Imperial Units)

$$K = \frac{WB}{8}$$

(2) For Class B freight loading

(SI Units)

$$K = 9.807 W \left(\frac{B}{2} - 1.219 \right) \text{ or } K = 9.807 \left(\frac{WB}{8} \right)$$

whichever is greater

(Imperial Units)

$$K = W \left(\frac{B}{2} - 48 \right) \text{ or } K = \frac{WB}{8}$$

whichever is greater.

(3) For Class C freight loading

(SI Units)

$$K = 9.807 \left(\frac{WB}{4} \right)$$

(Imperial Units)

$$K = \frac{WB}{4}$$

NOTE [8.2.9.1.4(a)]: Symbols used in the above formulas are defined in 8.2.2.1.1.

(b) *Stresses Due to Compression*

f_a = compressive stress in each upright

(c) *Slenderness Ratio*. The slenderness ratio L/R for uprights subject to compressions other than those

resulting from buffer or safety action shall not exceed 120. Where the upper side-brace connections on passenger elevator car frame uprights are located at a point less than two-thirds of L from the bottom (top fastening in car frame plank), a slenderness ratio of L/R not exceeding 160 is permissible.

(d) *Moment of Inertia*. The moment of inertia of each upright shall be not less than determined by the following formula:

(SI Units)

$$I = \frac{KL^3}{457.2EH}$$

(Imperial Units)

$$I = \frac{KL^3}{18EH}$$

NOTE [8.2.9.1.4(d)]: Symbols used in the above formula are defined in 8.2.2.1.1.

8.2.10 Minimum Oil Buffer Strokes: Inclined Elevators

The following formula shall be used to determine the minimum stroke of oil buffers used for inclined elevators (see 5.1.17.4):

(SI Units)

$$S_{\min} = 269.5v^2 \cos \theta$$

(Imperial Units)

$$S_{\min} = \frac{v^2 \cos \theta}{3,652}$$

where

S_{\min} = minimum oil buffer stroke, mm (in.)

v = rated car speed, m/s (ft/min)

θ = angle of inclination from horizontal (degrees)

8.2.11 Stopping Distances for Car and Counterweight Safeties for Inclined Elevators

The following formulas shall be used to determine the maximum and minimum stopping distances for Type B car and counterweight safeties used on inclined elevators (see 5.1.14.2):

(SI Units)

$$S_{\min} = 203.77v_g^2 \cos \theta$$

$$S_{\max} = 1.43S_{\min} + 254$$

(Imperial Units)

$$S_{\min} = \frac{v_g^2 \cos \theta}{4,830}$$

$$S_{\max} = 1.43S_{\min} + 10$$

where

- S_{\min} = minimum stopping distance, mm (in.)
 S_{\max} = maximum stopping distance, mm (in.)
 v_g = governor tripping speed, m/s (ft/min)
 θ = angle of inclination from horizontal (degrees)

8.2.12 Material Lifts With Automatic Transfer Devices, Design Data, and Formulas

The design data and formulas in 8.2 as they apply to freight elevators shall apply to material lifts with automatic transfer devices. Where vehicle loading is used, Class B loading shall apply.

SECTION 8.3 ENGINEERING TESTS, TYPE TESTS, AND CERTIFICATION

Requirement 8.3 covers:

- (a) type of tests and certification of
- (1) car and counterweight oil buffers, as required in 2.22.4.7 (see also 8.3.1 and 8.3.2)
 - (2) hoistway door interlocks, hoistway door combination mechanical locks, electric contacts, and hoistway-door electric contacts, as required in 2.12.4 (see also 8.3.1 and 8.3.3)
 - (3) car door or gate electric contacts, and car door interlocks as required in 2.14.4.2 (see 8.3.1 and 8.3.3)
 - (4) entrance fire tests as required by 2.11 (see 8.3.4)
 - (5) hydraulic control valves as required in 3.19.4.6 (see 8.3.1 and 8.3.5)
 - (6) escalator brakes, as required in 6.1.5.3 (see 8.3.1 and 8.3.6)
- (b) engineering tests of
- (1) car enclosure wall materials, as required in 2.14.2.1.1(b) (see 8.3.1 and 8.3.7)
 - (2) test method for evaluating room, fire growth, contribution of textile wall covering, as required in 8.7.2.14 (see 8.3.7 and 8.3.8)
 - (3) hydraulic overspeed valves, as required in 3.19.4.7 (see 8.3.9)
 - (4) safety nut and speed-limiting device of screw column elevators, as required in 4.2.11.2 (see 8.3.1 and 8.3.10)
 - (5) escalator steps, as required in 6.1.3.5.7 and moving walk pallets, as required by 6.2.3.5.4 (see 8.3.1 and 8.3.11)
 - (6) suspension member, as required in 2.20.11 (see 8.3.12)

8.3.1 General Requirements for Tests and Certification

8.3.1.1 General

- (a) Type Tests (see 1.3) shall be carried out when required.
- (b) Engineering Tests (see 1.3) shall be carried out when required.

(c) The tests shall be permitted to be made by laboratories other than the certifying organization or manufacturers, but the responsibility shall remain with the original certifying organization.

8.3.1.2 Application for Certification

8.3.1.2.1 The application for engineering or type tests shall be made by the component manufacturer, equipment manufacturer, installer, or importer.

8.3.1.2.2 The application shall include

- (a) the manufacturer's name and the equipment or component designation or model
- (b) two sets of assembly and detail drawings showing details as specified in 8.3
- (c) a description of the elevator component or equipment, and its field of application, along with calculated performance features

8.3.1.3 Certification and Test Records

8.3.1.3.1 A certificate shall be issued for a component or equipment that has been successfully tested. (ED)
 The certificate shall include

- (a) the name of applicant (see 8.3.1.2.1)
- (b) the name of the manufacturer
- (c) the manufacturer's designation of the type or model tested
- (d) the certifying organization's label/mark and the method of affixing the label/mark to each component or each piece of equipment subsequently manufactured, where required
- (e) the method of testing, the test report, and a list of the instruments used (Note: this may be attached to the certificate)
- (f) the conditions for use of the certificate and label/mark
- (g) a statement to the effect that the component or equipment tested has met the specified test requirements
- (h) any other information required in ASME A17.1/CSA B44
- (i) the edition of the Code under which the component was tested and certified

8.3.1.3.2 The certificate shall be valid until recalled by the certifying organization or until the applicable requirements in ASME A17.1/CSA B44 are changed unless otherwise stated (see 8.3.1.4). (ED)

8.3.1.3.3 The drawings and other documents submitted by the applicant (see 8.3.1.2), together with the original test records, data, performance curves, and certificate shall be filed, as a permanent record for future reference.

8.3.1.3.4 The applicant shall be permitted to examine and copy the test records upon request.

8.3.1.4 Changes to Listed/Certified Components or Equipment

8.3.1.4.1 Where any change is made in the design of the component or equipment after certification, including changes resulting from the revisions in applicable code requirements, revised drawings showing such changes shall be filed with the original or other certifying organization. The certifying organization shall issue to the applicant a revised certificate, based upon the previous test results or any new tests that are needed, depending on the nature of the changes.

8.3.1.4.2 Changes in the design that do not affect the performance of the component or equipment shall be permitted to be made without the approval of the certifying organization. The certifying organization shall be apprised in writing of the change.

8.3.1.5 Testing Instruments. The precision of the instruments shall allow measurements to be made, unless otherwise specified, within the following tolerances:

- (a) $\pm 1\%$ — masses, forces, distances, time, speeds, and hydraulic pressure
- (b) $\pm 2\%$ — accelerations, retardations, and flow rating
- (c) $\pm 5\%$ — voltages and currents
- (d) $\pm 10\%$ — temperatures

8.3.2 Type Tests of Car and Counterweight Oil Buffers

8.3.2.1 Application for Certification

8.3.2.1.1 The application required in 8.3.1.2 shall include information on the expected maximum impact speed, maximum and minimum total loads, and complete data for the oil porting in relation to the effective buffer stroke.

8.3.2.1.2 The drawings required in 8.3.1.2.2(b) shall show

- (a) the exact construction of the buffer
- (b) all dimensions of each part
- (c) all pertinent information concerning materials, clearances, and tolerances
- (d) the data as marked on the buffer marking plate required by 2.22.4.11

8.3.2.2 Test Sample. Tests shall be made on a buffer of each type or design to be installed. Each buffer shall conform to the documents submitted and have the following oil portings:

- (a) the porting having the range of the maximum loads for which the buffer is designed
- (b) the porting having the range of the minimum loads for which the buffer is designed

8.3.2.3 Testing Equipment. The testing equipment shall be of such design as to perform the tests specified herein and to determine that the buffer conforms to all

the requirements of 2.22 for oil buffers and shall also conform to 8.3.2.3.1 through 8.3.2.3.3.

8.3.2.3.1 Calibration of Test Weight. The required drop test load shall be accurate to within $\pm 1\%$.

8.3.2.3.2 Guiding of Test Weight. The test weight shall be so guided as to ensure that when dropped onto the buffer, its travel shall be substantially vertical.

8.3.2.3.3 Test Instruments. The instruments used to measure the test results shall conform to the following requirements:

- (a) The instruments shall be of the recording type.
- (b) The instruments shall provide data, for the plotting of the buffer performance curves showing time intervals, travel of test weight, velocity of test weight, and retardation of test weight during the buffer stroke, that shall be accurate to within the following tolerances:
 - (1) The timing device shall record time in increments of not more than $\frac{1}{60}$ s during the entire buffer stroke.
 - (2) Time increments and total time shall be recorded with an error of less than $\pm 0.5\%$.
 - (3) The position of the test weight at each time interval shall be recorded with an error of less than $\pm 0.1\%$.
 - (4) Time, travel, velocity, and retardation shall be determined by means of a device that will provide the accuracy specified.

8.3.2.4 Installation of Buffer and Preparations for Tests

8.3.2.4.1 Foundation and Location of Buffer. A buffer of the spring-return type shall be placed on a foundation designed to withstand without appreciable deformation the forces resulting from the buffer compression on the drop tests. The buffer shall be installed in a vertical position and located centrally with relation to the drop-test weight.

8.3.2.4.2 Securing of Buffer. The buffer shall be secured by bolts in accordance with the manufacturer's drawings or by equivalent means to:

- (a) the foundation for buffers of the spring-return type
- (b) the underside of the center of the test drop-weight for buffers of the gravity-return type

The centerline of the buffer, when secured in place, shall be vertical to within 0.25 mm (0.01 in.) in the stroke of the buffer.

8.3.2.4.3 Special Adjustments. The buffer test shall be on a production model or a buffer identical to the model to be produced. Modifications or special adjustments for the purpose of meeting the test requirements are prohibited.

8.3.2.4.4 Filling Buffer With Oil. The buffer, after being installed, shall be filled with oil to a level at or

between the manufacturer's gauge line or lines. The oil shall conform to 2.22.4.9 and the data specified on the buffer marking plate.

After filling with oil, the procedure outlined below shall be followed to ensure that a constant oil level has been established.

(a) The buffer shall be fully compressed at slow speed, and shall then be allowed to return to its fully extended position and remain there for at least 10 min. The oil level shall then be checked.

(b) If the oil level as previously determined has changed, due to the elimination of entrapped air or due to the retention of air under pressure within the buffer, the change in level shall be noted and the procedure repeated until a constant oil level is obtained when the buffer is in its extended position.

(c) If the oil level tends to remain above the level to which it was filled, the air vents, if provided, should be checked for obstructions.

(d) When a constant oil level has been established, the level shall be adjusted to the manufacturer's lowest gauge line, and the exact level noted and recorded before making the drop tests hereinafter specified.

8.3.2.5 Buffer Tests. Each oil buffer with oil portings as submitted shall be subjected to tests for retardation, strength, oil leakage, plunger return, and lateral plunger movement, as hereinafter specified.

8.3.2.5.1 Retardation Tests. The following drop tests shall be made for each buffer porting specified in 8.3.2.2, from a height such that the striking velocity of the falling weight will be equal to 115% of the rated car speed for which the buffer is designed:

(a) three drop tests with a total test weight equal to the manufacturer's rated maximum load for which the porting is designed [see 8.3.2.2(a)]

(b) one drop test with a total test weight equal to the manufacturer's rated minimum load for which the porting is designed [see 2.7.2.2]

Following each drop test, the buffer shall be held in its fully compressed position for a period of 5 min, and shall then be allowed to return free to its fully extended position and stand for 30 min to permit return of the oil to the reservoir and to permit escape of any air entrained in the oil.

On each of these tests, the average retardation of the test weight, during the stroke of the buffer, shall not exceed 9.81 m/s^2 (32.2 ft/s^2), and any retardation peak having a duration of more than 0.04 s shall not exceed 24.5 m/s^2 (80.5 ft/s^2).

On completion of the drop tests, no part of the buffer shall show any permanent deformation or injury.

8.3.2.5.2 Strength Tests

(a) Two drop tests shall be made as follows:

(1) One drop test shall be made with the porting as specified in 8.3.2.2(a), with a total test weight equal

to 120% of the manufacturer's rated maximum load, from a height such that the maximum velocity attained by the falling weight during the buffer compression shall be equal to 125% of the rated car speed for which the buffer is rated. In this test, the retardation shall be noted and shall be permitted to exceed the values specified in 8.3.2.5.1.

Immediately following this test, the buffer shall be examined externally for visible deformation or injury. If no damage is apparent, the buffer shall then be fully compressed at low speed and then released to determine if it will return freely to its extended position.

(2) After the buffer has been examined externally and has returned freely to its extended position, a second drop test shall be made from the same height and with the same load as specified in 8.3.2.5.1(a). During this test, the retardation shall not exceed the corresponding retardation developed in the test specified in 8.3.2.5.1(a) by more than 5%.

(b) If for given stroke of buffer having more than one porting, the construction of the buffer varies for the different portings, then a strength test similar to that specified in 8.3.2.5.2(a)(1) shall also be made for the porting having the range at minimum loads for which the porting is designed as specified in 8.3.2.2(b).

Following each drop test, the buffer shall be held in its fully compressed position for a period of 5 min, and shall then be allowed to freely return to its fully extended position and stand for 30 min to permit return of the oil to the reservoir and to permit the escape of any air entrained in the oil.

8.3.2.5.3 Oil Leakage Tests. Tests for oil leakage shall be made concurrently with the retardation tests specified in 8.3.2.5.1, and the drop test specified in 8.3.2.5.2(a)(2), to determine the loss of oil during these tests. The oil level shall be noted after the buffer has returned to its fully extended position following each drop test, and after the time interval specified in 8.3.2.5.1.

The drop in oil level, as indicated by these measurements, shall show no loss of oil exceeding 5 mm/m (0.06 in./ft) of buffer stroke, but in no case shall the loss be such as to lower the oil level below the bottom of the plunger or below the highest metering orifice, whichever is higher.

Where the volume of oil above the porting is small when the buffer is filled to its normal working level, the laboratory shall be permitted to make additional tests for oil leakage.

8.3.2.5.4 Plunger Return Test. During the drop tests specified in 8.3.2.5.1 and 8.3.2.5.2, the time required for the buffer plunger to return to its fully extended position, measured from the instant the test weight is raised clear of the buffer until the plunger has returned to its fully extended position, shall be noted. This time shall be not more than 90 s.

Should the plunger fail to return to its fully extended position, or should the time required for it to return to its fully extended position exceed the time specified, the manufacturer shall either submit a duplicate buffer or install a new pressure cylinder and piston, following which the plunger-return test shall be repeated. Should the buffer again fail to meet the plunger-return test requirements, it shall be rejected.

Buffers of the spring-return type shall be tested for plunger return with a 20 kg (45 lb) test weight resting on top of the plunger during the test. The plunger shall be depressed 50 mm (2 in.) and when released, the plunger, while supporting the test weight, shall return to its fully extended position within 30 s.

8.3.2.5.5 Tests for Lateral Movement. The following tests shall be made for lateral movement.

(a) *Spring-Return-Type Buffers.* The lateral movement at the top of the fully extended plunger shall be accurately measured, the upper end of the plunger being manually moved from its extreme right to its extreme left position. One-half of the total movement measured shall be considered as being the true lateral movement at the top of the plunger and shall not exceed 5 mm/m (0.06 in./ft) of buffer stroke.

(b) *Gravity-Return-Type Buffers.* A similar test for lateral movement shall be made. The measurement shall be taken at the lower end of the buffer cylinder when the buffer plunger is fully extended and braced to prevent lateral movement. One-half of the total movement measured shall not exceed 5 mm/m (0.06 in./ft) of buffer stroke.

8.3.2.6 Certification

8.3.2.6.1 After the buffer has been subjected to all of the specified tests, and all test records and data indicate that it conforms to 2.22, and to the requirements of 8.3.2, the laboratory shall issue a test report and a certificate to the manufacturer.

8.3.2.6.2 The certificate shall conform to 8.3.1.3.1 and shall include the following:

- (a) the maximum impact speed
- (b) the maximum total load
- (c) the minimum total load
- (d) specification of the fluid
- (e) a statement to the effect that the buffer having the particular stroke and portings tested has met the requirements of 2.22 and 8.3.2 for the maximum and minimum loads as stated in the certificate

8.3.2.6.3 When the test results are not satisfactory with the minimum and maximum total loads appearing in the application, the laboratory shall be permitted to, in agreement with the applicant, establish the acceptable limits.

8.3.3 Type Tests of Interlocks, Combination Mechanical Locks and Electric Contacts, and Door or Gate Electric Contacts

8.3.3.1 General. This Section specifies the type test of hoistway door interlocks, car door interlocks, combination mechanical locks and electric contacts, and hoistway door and car door or gate electric contacts.

8.3.3.2 Examination Before Test. Prior to testing, the certifying organization shall examine each device submitted to ascertain that it conforms to the applicable requirements in Part 2.

8.3.3.3 General Requirements

8.3.3.3.1 Connections for and Test of Electrical Parts. During the tests specified by 8.3.3.4.1, 8.3.3.4.3, and 8.3.3.4.4, the devices shall have their electrical parts connected in a noninductive electrical circuit having a constant resistance and in which a current of twice the rated current at rated voltage is flowing. The electric circuit shall be closed, but shall not be broken at the contact within the device on each cycle of operation during the tests.

8.3.3.3.2 Retesting of Electric Contacts Previously Tested. If the electric contact of a device submitted for test has already been tested as part of another device, and has successfully met the test requirements (see 8.3.3), the electrical tests of the contact need not be repeated.

8.3.3.3.3 Tests of Retiring Cams or Equivalent Devices. Tests of retiring cams or equivalent devices used to operate interlocks shall not be required.

8.3.3.3.4 Tests of Hoistway Door (Runway Door) Combination Mechanical Locks and Electric Contacts.

The testing equipment shall actuate the mechanical locking members of hoistway door (runway door) combination mechanical locks and electric contacts to unlock at each cycle of operation during the tests specified by 8.3.3.4.1, 8.3.3.4.3, and 8.3.3.4.4.

8.3.3.4 Required Tests and Procedure. Each device submitted shall be subjected to and shall successfully pass the following tests.

8.3.3.4.1 Endurance Test. The device, lubricated in accordance with the manufacturer's instructions, shall complete 960 000 cycles of operation without failure of any kind, without excessive wearing or loosening of parts, or without undue burning or pitting of the contacts (see 8.3.3.3.1). For private residence elevators the number of cycles shall be reduced to 25 000.

8.3.3.4.2 Current Interruption Test. After completion of the test specified by 8.3.3.4.1, the device used therein shall satisfactorily complete the following additional tests, to check that the ability to break a live circuit is adequate.

The tests shall be carried out with the locking device located in accordance with the manufacturer's drawings. If several positions are indicated, the test shall be made in the position that the laboratory judges to be the most unfavorable.

The sample tested shall be provided with covers and electrical wiring in accordance with the manufacturer's drawings.

(a) AC rated locking devices shall have their electrical parts connected to an inductive circuit with a power factor of 0.7 ± 0.05 in which a current of 11 times the rated current, at 110% of rated voltage, is flowing. The AC locking devices shall open and close 50 times, at normal speed, and at intervals of 5 s to 10 s, with the contact remaining closed for at least 0.5 s.

(b) DC rated locking devices shall have their electrical parts connected to an inductive circuit in which the current reaches 95% of the steady state value of 110% of the rated current in 0.3 s maximum, at 110% of rated voltage. The DC locking devices shall open and close 20 times, at normal speed, and at intervals of 5 s to 10 s, with the contact remaining closed for at least 0.5 s.

(c) The test results are considered satisfactory if no evidence of insulation breakdown due to arcing or tracking occurs and if no deterioration occurs that could adversely affect safety.

8.3.3.4.3 Test Without Lubricant. After completion of the test specified by 8.3.3.4.2, the device used therein shall be used for this test.

The device, except self-lubricating bearings and bearings of a type not requiring frequent replenishment of lubricant, shall then be taken apart and freed of lubricant by washing in nonflammable liquids having cleansing characteristics.

After reassembling, the device shall, without other than the usual initial adjustment (i.e., without adjustment especially made to meet the conditions of the particular test) and without further attention, complete 25 000 cycles or 20 000 cycles for private residence elevator of operation without failure of any kind, without excessive wearing or loosening of parts, and without undue burning or pitting of contacts.

8.3.3.4.4 Test in Moist Atmosphere. After completion of the test specified by 8.3.3.4.3, the device used therein shall be used for this test.

The device shall be subjected continuously, in an unventilated enclosure, to an atmosphere saturated with a range of 3.5% to 5% solution of sodium chloride for 72 consecutive hours. During this period, it shall be operated for only 10 consecutive cycles at the end of each of the first two 24 h periods and shall be allowed to stand exposed to the air for 24 h, and shall not fail in a manner that creates an unsafe condition.

The device shall again be lubricated and shall, without adjustment and without further attention, complete

15 000 cycles or 10 000 cycles for private residence elevator of operation without failure of any kind.

8.3.3.4.5 Misalignment Test

(a) *All Types of Doors.* The device shall operate effectively when the car cam or other equivalent operating device used in making the test has been displaced horizontally from its normal position (the position in which it was when the device was installed) successively as follows:

(1) in a direction perpendicular to the plane of the door opening

(a) backward 6 mm (0.25 in.)

(b) forward 6 mm (0.25 in.)

(2) in a direction parallel to the plane of the door opening

(a) to the right 6 mm (0.25 in.)

(b) to the left 6 mm (0.25 in.)

(b) *Horizontally Sliding Doors.* The device shall operate effectively

(1) when the bottom of the door has been displaced horizontally from its normal position in a direction perpendicular to the plane of the door opening

(a) backward 6 mm (0.25 in.)

(b) forward 6 mm (0.25 in.)

(2) when the top of the door has been displaced horizontally from its normal position in a direction perpendicular to the plane of the door opening

(a) backward 3 mm (0.125 in.)

(b) forward 3 mm (0.125 in.)

(c) *Swinging Doors.* The device shall operate effectively when the strike edge of the door has been displaced

(1) perpendicular to the plane of the door opening

(a) forward 3 mm (0.125 in.)

(b) backward 3 mm (0.125 in.)

(2) parallel to the plane of the door opening

(a) 3 mm (0.125 in.) to the right

(b) 3 mm (0.125 in.) to the left

(c) 3 mm (0.125 in.) up

(d) 3 mm (0.125 in.) down

(d) *Vertically Sliding Doors.* The device shall operate effectively when the door has been displaced

(1) perpendicular to the plane of the door opening

(a) forward 3 mm (0.125 in.)

(b) backward 3 mm (0.125 in.)

(2) parallel to the plane of the door opening:

(a) 3 mm (0.125 in.) to the right

(b) 3 mm (0.125 in.) to the left

8.3.3.4.6 Insulation Test. The insulation of the electrical parts shall withstand a test with a root-mean square (effective) voltage of twice the rated voltage plus 1 000 V, 60 Hz, applied for 1 min.

8.3.3.4.7 Force and Movement Test. When testing devices of a type that are released by retiring cam (see

2.12.2.5), measurements shall be made of the force required to release the device and of the movement of the element engaged by the cam, with the device mounted in its normal position as specified by the manufacturer, before and after the test specified by 8.3.3.4.1.

The force and movement recorded in each test shall be, respectively

(a) the maximum force, measured in a horizontal plane, that must be applied to that member of the device that is directly actuated by the cam to release the door-locking member of the device from locking engagement

(b) the distance, projected on a horizontal plane, that the member of the device directly actuated by the cam travels from its position when the lock is fully engaged to its position when the locking member is released from engagement

The force and movement markings required by 2.12.4.3(f) shall be not less than the average of these recorded values.

8.3.3.4.8 Static Test. After completion of the endurance test in 8.3.3.4.1, a type test shall be made consisting of a static force applied over a period of 300 s with the force increasing incrementally. The force shall be applied in the opening direction of the door and at a location as near to the locking element as possible, but not to exceed 300 mm (12 in.). The force shall be 1 000 N (225 lbf) in the case of a locking device intended for use with sliding doors, and 3 000 N (675 lbf) or 670 N (150 lbf) for private residence elevator applied at right angles to the panel evenly distributed over an area 5 cm² (0.78 in.²) in round or square section in the case of a locking device intended for use with swinging doors.

8.3.3.4.9 Examination of Electrical Spacings. The electrical spacings shall comply with CSA B44.1/ASME A17.5, Section 16.

8.3.3.4.10 Examination of Operation. Verify that there is at least 7 mm (0.28 in.) engagement of the locking elements before the hoistway door interlock contact closes.

8.3.3.4.11 Testing of Bridging Means. The electrical contact bridging means shall be tested to verify conformance to 2.12.2.4.1.

8.3.4 Entrance Fire Type Tests

8.3.4.1 Test of Entrance Assemblies, Horizontally Sliding and Swinging Types and Vertically Sliding Types

8.3.4.1.1 In jurisdictions enforcing the NBCC, the fire protection rating of entrances and doors shall be determined in accordance with the requirements specified in the NBCC. Requirement 8.3.4.1.2 does not apply.

8.3.4.1.2 In jurisdictions not enforcing the NBCC, test of elevator horizontal slide-type and swinging entrance assemblies and tests of elevator and

dumbwaiter vertical slide-type entrance assemblies shall be conducted in accordance with UL 10B, or NFPA 252.

Test entrance assemblies shall be constructed in accordance with 2.11.

8.3.5 Type Tests for Hydraulic Control Valves

8.3.5.1 Application for Certification. The application required in 8.3.1.2 shall include information regarding

- (a) the component rated pressure
- (b) the flow rating
- (c) the fluid specification
- (d) the operating temperature range of fluid
- (e) the coil voltage and current

8.3.5.2 Test Sample. Tests shall be conducted on a representative sample in the sequence as stated in 8.3.5.3.

8.3.5.3 Test Procedure

8.3.5.3.1 Endurance Test. Test samples shall be subject to 100 000 operating cycles (100 000 up and 100 000 down) at the component rated pressure and within the fluid specifications and temperature range stipulated by the manufacturer. Each operating cycle shall be not less than 5 s nor more than 24 s.

8.3.5.3.2 Seat Leakage

(a) The hydraulic pressure shall be maintained at 1.5 times the component rated pressure for a period sufficient to establish the rate of leakage, but not less than 1 h nor more than 24 h. The test shall be started at the maximum stipulated fluid temperature for which the valve is designed. The fluid temperature shall be permitted to gradually decrease during the test to 20°C (68°F).

(b) The test shall be repeated using a pressure of 750 kPa (110 psi).

(c) Total leakage from output to input during either test shall not exceed the flow rate of the valve divided by one million.

8.3.5.3.3 External Leakage. The hydraulic pressure shall be maintained at twice the component rated pressure for a period of 10 min to establish the rate of leakage. The rate of leakage shall not exceed 10% of the rated flow of the valve.

8.3.5.3.4 Valve Body Strength Test. For elongations greater than or equal to 10%, the pressure chambers of the valve shall be subjected to a hydraulic pressure five times the component rated pressure.

For elongations of less than 10%, the test value shall be 1.5 times the value indicated by 8.2.8.5 multiplied by the component rated pressure.

To test the strength, this hydraulic pressure shall be maintained for a period of 5 min. During the test, the valve body shall not rupture.

NOTES (8.3.5.3.4):

- (1) In order to obtain and maintain the test pressure, it is permissible to substitute alternate sealing material; and to tighten bolts during the test.
- (2) It is not expected that the valve will be able to perform its function during or after the valve body strength test.

8.3.5.3.5 Electrical Test. Valves shall be tested to the electrical requirements of CSA C22.2 No. 139, Clause 6.

8.3.6 Escalator Brake Type Test

8.3.6.1 General. Where required by 6.1.5.3.3, escalators shall be subjected to such tests as are necessary to certify that

- (a) the escalator brakes can be adjusted to conform to 6.1.5.3
- (b) the relationship that exists between the range of brake settings and stopping distances complies with 6.1.5.3.1

8.3.6.2 Measuring the Stopping Distances. The stopping distance shall be measured by the movement of a step along its path of travel after a stop has been initiated.

8.3.6.3 Location of Tests. The tests shall be permitted to be made in the manufacturer's plant or on an escalator installation.

8.3.6.4 Extension of Type Test. Provided that design loads of the brake are not exceeded, it is permissible to simulate on the test escalator, by means of alternative loads, a number of heights and widths, for the purpose of certification of an escalator type (design), provided that those escalators for the additional widths and heights utilize the same motor and machine.

8.3.7 Vertical Burn Engineering Test

In jurisdictions not enforcing the NBCC, napped, tufted, woven, looped, and similar materials [see 2.14.2.1.2(b)] shall be subjected to the engineering tests specified in 8.3.7.1 through 8.3.7.6.

8.3.7.1 Conditioning. Specimens shall be conditioned to $21^{\circ}\text{C} \pm 2^{\circ}\text{C}$ ($70^{\circ}\text{F} \pm 5^{\circ}\text{F}$) and at $50\% \pm 5\%$ relative humidity until moisture equilibrium is reached, or for 24 h. Only one specimen at a time shall be removed from the conditioning environment immediately before subjecting it to the flame.

8.3.7.2 Specimen Configuration. Materials shall be tested either as a section cut from a fabricated part as installed in the car or as a specimen simulating a cut section, such as a specimen cut from a flat sheet of the material or a model of the fabricated part. The specimen shall be cut from any location in a fabricated part; however, fabricated units, such as sandwich panels, shall not be separated for test. The specimen shall be no thicker than the minimum thickness to be qualified for

use in the car. In the case of fabrics, both the warp and fill direction of the weave shall be tested to determine the most critical flammability conditions. The specimen shall be mounted in a metal frame so that the two long edges and the upper edge are held securely. The exposed area of the specimen shall be at least 51 mm (2 in.) wide and 305 mm (12 in.) long, unless the actual size used in the car is smaller. The edge to which the burner flame is applied must not consist of the finished or protected edge of the specimen but shall be representative of the actual cross section of the material or part installed in the car.

8.3.7.3 Apparatus. Except as provided in 8.3.7.4, tests shall be conducted in a draft-free cabinet in accordance with FED-STD 191A, Method 5903.1, or other approved equivalent methods. Specimens that are too large for the cabinet shall be tested under similar draft-free conditions.

8.3.7.4 Test. A minimum of three specimens shall be tested and the results averaged. For fabric, the direction of weave corresponding to the most critical flammability conditions shall be parallel to the longest dimension. Each specimen shall be supported vertically. The specimen shall be exposed to a Bunsen or Tirrill burner with a nominal 9.5 mm (0.375 in.) I.D. tube adjusted to give a flame of 38 mm (1.5 in.) in height. The minimum flame temperature measured by a calibrated thermocouple pyrometer in the center of the flame shall be 840°C ($1,545^{\circ}\text{F}$). The lower edge of the specimen must be 19 mm (0.75 in.) above the top edge of the burner.

The flame shall be applied to the centerline of the lower edge of the specimen. The flame shall be applied for 12 s and then removed. Flame time, burn length, and flaming time of drippings, if any, shall be recorded. The burn length determined in accordance with 8.3.7.5 shall be measured to the nearest 2.5 mm (0.1 in.).

8.3.7.5 Burn Length. Burn length is the distance from the original edge to the farthest evidence of damage to the test specimen due to flame impingement, including areas of partial or complete consumption, charring, or embrittlement, but not including areas sooted, stained, warped, or discolored, and not areas where material has shrunk or melted away from the heat source.

8.3.7.6 Acceptance Criteria

- (a) The average burn length shall not exceed 203 mm (8 in.).
- (b) The average flame time after removal of the flame source shall not exceed 15 s.
- (c) Drippings from the test specimen shall not continue to flame for more than 5 s.

8.3.8 Test Method for Evaluating Room Fire Growth Contribution of Textile Wall Covering

Textile wall covering shall be tested and meet the acceptance criteria of the NFPA 265, Fire Test for Evaluating Room Fire Growth Contribution of Textile Wall Covering, when tested using the product mounting system, including adhesive, of actual use.

8.3.9 Engineering Tests for Hydraulic Overspeed Valves

8.3.9.1 General. The overspeed valve test shall be based on the marking required by 3.19.4.7.2 and specifications provided by the valve manufacturer.

8.3.9.2 Test Samples. Tests shall be conducted on a representative sample of the overspeed valve.

8.3.9.3 Test Procedure

8.3.9.3.1 Endurance Test. The test sample shall be subjected to 1 000 closing cycles at the component rated pressure, maximum flow rate, and within the fluid specifications and temperature range stipulated by the manufacturer. Additionally, the sample shall be subjected to 100 operating cycles at the minimum flow rate and pressure, to ensure range coverage.

8.3.9.3.2 Seat Leakage Test. The hydraulic pressure shall be maintained at 1.5 times the component rated pressure for a period sufficient to establish the rate of leakage, but not less than 1 h and not more than 24 h. Total leakage of the valve from input to output during the test period shall not exceed the flow rate of the valve divided by one million.

8.3.9.3.3 Valve Body Strength Test. For elongations greater than or equal to 10%, the valve shall be subjected to a hydraulic pressure 7.5 times the component rated pressure. For elongations of less than 10%, the test valve shall be 2.25 times the value indicated by 8.2.8.5 multiplied by the component rated pressure. The strength test for this hydraulic pressure shall be maintained for a period of 5 min. During the test, the valve body shall not rupture.

NOTES:

- (1) In order to obtain and maintain the test pressure, it is permissible to substitute alternate sealing material; and tighten bolts during the test.
- (2) It is not expected that the valve will be able to perform its function during or after the valve body strength test.

8.3.10 Engineering Tests: Safety Nut and Speed Limiting Devices of Screw-Column Elevators

8.3.10.1 General. This Section specifies the engineering tests of safety nuts and speed-limiting devices that are permitted as alternate safety devices on screw-column elevators driven by alternating current squirrel cage motors and having a down speed of not more than 0.38 m/s (75 ft/min).

8.3.10.2 Test of Safety Nut. The test shall be made in either the manufacturer's plant, in a testing laboratory, or in the field by suspending the elevator car with rated load a distance above the safety nut of at least 13 mm (0.5 in.) and allowing it to drop (free-fall) until the entire load rests on the safety nut. The test shall be witnessed by, and the test results certified by, a testing laboratory or registered professional engineer. After the test, the screw column, screw supports, safety nut, guide rails, and car frame shall be inspected to determine that there has been no damage. A test on a given capacity elevator shall be accepted for all similarly designed elevators by that manufacturer for the same or lesser capacity (rated load).

8.3.10.3 Test of Speed Limiting Device. The test shall be made either in the manufacturer's plant, in a testing laboratory, or in the field by suspending the elevator car with rated load a distance of at least 4 572 mm (15 ft) above the lower limit of normal travel and allowing it to drop (free-fall) until the descent is controlled by the speed-limiting device. The elevator car shall be allowed to continue its descent until brought to rest by the car buffer or bumper. The test shall be instrumented so that a graph of velocity versus distance can be plotted. The test shall be witnessed by, and the test results certified by, a testing laboratory or a registered professional engineer. After the test, the screw column, screw-column supports, speed-limiting device, guide rails, car buffer or bumper, and car frame shall be inspected to determine that there has been no damage. A test on a given capacity elevator shall be accepted for all similarly designed elevators by that manufacturer for the same or lesser capacity (rated load).

8.3.11 Step and Pallet Fatigue Engineering Test

Step fatigue tests required in 6.1.3.5.7 and pallet fatigue tests required by 6.2.3.5.4 shall be performed as indicated in 8.3.11.1 through 8.3.11.6.

8.3.11.1 The test shall be made at either the manufacturer's facility or at a testing laboratory.

8.3.11.2 Escalator steps shall be mounted in an arrangement that duplicates the conditions on the escalator incline and their attachment to the step chain. Moving walk pallets shall be mounted in an arrangement that duplicates the condition of a horizontal moving walk and their attachment to the pallet chain.

8.3.11.3 The steps shall be subjected to a load varying from 450 N (100 lbf) to 3 000 N (650 lbf) at a frequency of 10 Hz \pm 5 for 5 000 000 cycles. An undisturbed harmonic force flow shall be achieved.

8.3.11.4 The load shall be applied normal to the tread surface to a plate 25 mm (1 in.) thick, 200 mm (8 in.) wide, and 300 mm (12 in.) long, located at the

center of the step or pallet, with the 300 mm (12 in.) dimension in the direction of step travel.

8.3.11.5 The step or pallet shall have no fractures or permanent tread surface deflection exceeding 4 mm (0.16 in.) following the completion of the test. The deflection of 4 mm (0.16 in.) does not include any set or wear in the supporting wheels.

8.3.11.6 This test is to be performed on each step or pallet width.

8.3.12 Suspension-Member Tests

Suspension-member tests required in 2.20.11 shall be performed as required by 8.3.12.1 through 8.3.12.3. Test results shall be documented as required by 8.3.12.4.

8.3.12.1 General Requirements. A test shall be required on each combination of suspension member, driving sheave design, and materials of construction. The test shall be conducted with the contact-surface geometry of the test specimens that results in the highest surface-pressure condition between the suspension member and driving sheave. A test on a given suspension member at its maximum allowable load shall be accepted for all similarly designed combinations by that manufacturer for any lesser load carried per suspension member. The suspension members and driving sheave combination shall be tested under the conditions for which they were designed.

8.3.12.2 Inspection Speed Test. One or more suspension member(s), loaded in tension to the maximum capacity to be qualified, shall be applied to its (their) driving sheave. The suspension member(s) shall be prevented from moving. The driving sheave shall be rotated at a speed no less than that corresponding to the maximum inspection speed of the elevator to which the suspension means is to be applied.

8.3.12.2.1 Acceptance Criteria. As a result of the test required by 8.3.12.2, no suspension member shall part before a minimum of 4 min.

8.3.12.3 Test Under Emergency-Stop Conditions. One or more suspension member(s), loaded in tension to the maximum capacity to be qualified, shall be applied to its (their) driving sheave. The suspension member(s) shall be run at a speed corresponding to the maximum speed for which the suspension means is to be applied with respect to its (their) drive sheave. The drive sheave shall be subjected to three successive emergency stops, each causing the suspension members to slip traction over the driving sheave [see 8.3.12.4(g)]. The tests shall be so arranged that slippage occurs over substantially the same portion of the suspension means during successive tests. The duration of the slip shall correspond to that attained by the elevator counterweight and car with

rated load initially moving at rated speed, and decelerating, on their own, to a complete stop. It shall be permitted to conduct this test on an installed elevator or in a suitable testing facility.

8.3.12.3.1 Acceptance Criteria. As a result of the test required by 8.3.12.3, suspension member(s) shall not sustain damage that would require replacement according to the criteria of ASME A17.6, Sections 1.10, 2.9, and 3.7, as applicable.

8.3.12.4 Documentation of Test Results. For the tests required in 8.3.12.2 and 8.3.12.3, the testing facilities, test procedure, and test results shall be documented in engineering reports. The following information shall be provided in each engineering report:

- (a) date(s) of the test
- (b) name and address of location where tests were conducted
- (c) name, position, and organization of the person(s) conducting, supervising, or witnessing the tests
- (d) description of apparatus and equipment used to perform the tests
- (e) description of instrumentation used to measure or record data
- (f) definition and description of the suspension member(s) and the driving sheave to which it (they) is (are) being applied, including part number, type designation, or other identification
- (g) the values of the loads and speeds for which the suspension members and their sheaves are to be qualified
- (h) the sheave rotation speed for Test 8.3.12.2
- (i) description of the test procedure and pass/fail criteria
- (j) observations noted during the test
- (k) test results and test data
- (l) conclusions indicating compliance with the acceptance criteria

SECTION 8.4 ELEVATOR SEISMIC REQUIREMENTS

(a) Section 8.4 applies to all electric elevators with counterweights, and direct-acting or roped-hydraulic elevators where applicable, where such elevators are installed in buildings assigned to one of the following:

- (1) Seismic Design Category C with Component Importance Factor, I_p , of 1.5 as defined by IBC (see 1.3, building code)
- (2) Seismic Design Category D or greater as defined by IBC (see 1.3, building code)
- (3) Design Spectral Response Acceleration for a 0.2 s time period [$S_a(0.2)$] greater than 0.12 and building designated as *post-disaster building* or $I_E F_a S_a(0.2)$ is equal to or greater than 0.35 as defined by NBCC-2010 (see 1.3, building code)

(4) Seismic Performance Category C with Seismic Hazard Exposure Group II or higher as defined by earlier model building codes (see Note)

(5) Seismic Risk Zone 2 or greater as defined by earlier building codes (see Note)

NOTE: For example, SBC 1982; SBC 1994; etc.

(b) The appropriate Elevator Component Seismic Force Level is determined by the applicable building code (see Guide for Elevator Seismic Design Part 1 and Part 2, Sample Calculations 1a–g)

(1) where the applicable building code references Seismic Design Categories or Design Spectral Response Acceleration [$S_d(0.2)$], force levels as referenced by 8.4.14 shall be used (see 1.3, building code)

(2) where the applicable building code makes reference to ground motion parameters (such as A_v or Z_v), 8.4.13 shall be used

(3) where the applicable building code makes reference to Seismic Risk Zones, or Seismic Risk Zones and component force level equations, force levels for the appropriate zone, as listed throughout Section 8.4, or the calculated component force level shall be used, whichever is greater

(c) The elevator seismic requirements contained in 8.4 shall be in addition to the requirements in the other parts of the Code unless otherwise specified.

8.4.1 Horizontal Car and Counterweight Clearances

8.4.1.1 Between Car and Counterweight and Counterweight Screen. The following clearances shall supersede those specified in 2.5.1.2.

8.4.1.1.1 The clearance between the car and the counterweight assembly shall be not less than 50 mm (2 in.), except that where the counterweight is enclosed by double U-brackets or where single U-brackets are provided and are located within the space between the car and its counterweight, the clearance shall be not less than 100 mm (4 in.).

8.4.1.1.2 The clearance between the counterweight assembly and the hoistway enclosure or separator beams shall be not less than 50 mm (2 in.).

8.4.1.1.3 The running clearance between the counterweight assembly and the nearest obstruction, including counterweight screens, shall be not less than 25 mm (1 in.).

8.4.2 Machinery and Sheave Beams, Supports, and Foundations

(13) **8.4.2.1 Securing Beams and Supports.** Overhead beams and supports including hitch-plate blocking beams shall be anchored to prevent overturning and displacement as a result of seismic forces acting simultaneously, as specified in 8.4.13 or 8.4.14, or equal to

(a) W_p horizontally and $\frac{1}{2} W_p$ vertically (zone 3 or greater)

(b) $\frac{1}{2} W_p$ horizontally and $\frac{1}{4} W_p$ vertically (zone 2)

where

W_p = component operating weight as defined by 8.4.15

8.4.2.2 Fastenings to Building Structure. Fastening devices including bolts used to secure machines, control panels, motor-generator units, machine beams, support beams, and sheaves, including compensating sheave assemblies, to the building structure shall conform to 8.4.2.3. Requirement 2.9.3.1.2 shall not apply (see Guide for Elevator Seismic Design, Part 2, Sample Calculation 2).

8.4.2.3 Connections (13)

8.4.2.3.1 Connections (for guide-rail brackets, see 8.4.8.4) used to attach equipment to the supporting structure, that are not subject to impact loads, shall be designed to withstand seismic component force levels acting simultaneously, as defined in 8.4.13 or 8.4.14, or equal to either of the following:

(a) W_p horizontally and $\frac{1}{2} W_p$ vertically (zone 3 or greater)

(b) $\frac{1}{2} W_p$ horizontally and $\frac{1}{4} W_p$ vertically (zone 2)

8.4.2.3.2 Connections subject to impact loads shall be designed to withstand forces double those required for connections not subject to impact loads. (13)

8.4.2.3.3 Maximum combined stresses in connections due to the specified seismic forces shall conform to the following applicable standards (see also 8.4.14.1.4): (13)

(a) ANSI/AISC 360-05 or CAN/CSA-S16.1-09 for threaded fasteners

(b) Section 8.8 for welded connections

(c) ACI 318-08 or CSA A23.3-04 for fastening to concrete

(d) ANSI/AF&PA National Design Specification for Wood Construction (2005) or CSA Standard O86-01 Wood Design Manual

NOTE: Connections includes all the mechanical and/or structural components used to transmit shear forces, bending moments, and axial forces developed in the structure at the connection point.

8.4.2.3.4 For areas not utilizing seismic zones, the Nonstructural Component Anchorage, as defined by IBC/ASCE 7, shall be in conformance with the requirements of the governing building code. (13)

8.4.3 Guarding of Equipment

8.4.3.1 Retainers for Suspension Members

8.4.3.1.1 Retainers for suspension members shall be provided on deflecting and secondary sheaves, driving-machine sheaves and drums, compensating sheaves, governor sheaves, governor tension sheaves, and suspension sheaves on cars and counterweights to inhibit the displacement of suspension members, except as specified in 8.4.3.1.4.

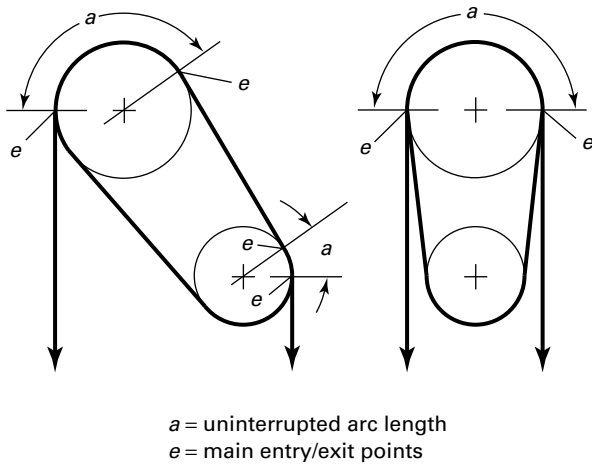
Fig. 8.4.3.1.3 Arc of Contact

8.4.3.1.2 The retainer shall be continuous over not less than two-thirds of the arc of contact between the suspension members and its sheave or drum and shall be so located that not more than one-sixth of the arc of contact is exposed at each end of the retainer.

8.4.3.1.3 For double-wrap traction applications, the arc of contact for drums and secondary sheaves shall be that length of arc that is uninterrupted by the entry/exit of the suspension members leading to/from the car or counterweight (see Fig. 8.4.3.1.3).

8.4.3.1.4 Restraints for suspension members shall be permitted to be used in lieu of continuous guards, provided they conform to the following:

(a) Where the arc of contact is 30 deg or less and one suspension-member restraint, located at the midpoint of the arc of contact, is provided.

(b) Where the arc of contact exceeds 30 deg and restraints are provided at intervals not exceeding 30 deg of arc along the arc of contact and a restraint is located at each end of the arc of contact.

8.4.3.2 Guarding of Snag Points. Snag points created by rail brackets, rail clip bolts, fishplates, vanes, and similar devices shall be provided with guards to prevent snagging of the following:

(a) the counterweight end of compensating means where located 760 mm (30 in.) or less from a counterweight rail bracket

(b) compensating chains where any portion of their loop below the mid-point of the elevator travel is located 915 mm (36 in.) or less horizontally from a snag point

(c) governor ropes where located 500 mm (20 in.) or less from a snag point

(d) suspension members where located 300 mm (12 in.) or less from a snag point

(e) traveling cables where any portion of their loop below the mid-point of the elevator travel is located 915 mm (36 in.) or less horizontally from a snag point

8.4.4 Car Enclosures, Car Doors and Gates, and Car Illumination

8.4.4.1 Top Emergency Exits

8.4.4.1.1 The requirements specified in 2.14.1.5 shall apply except that the emergency exit shall be so arranged that it can be opened from within the car by means of a keyed spring-return cylinder-type lock having not less than a five-pin or five-disk combination and opened from the top of the car without the use of a key.

The key required to open the emergency exit lock shall be kept on the premises in a location readily accessible to authorized persons, but not where it is available to the public. No other key to the building shall unlock the emergency exit lock except that where hoistway access switches conforming to 2.12.7 are provided, the key used to operate the access switches shall be permitted to also unlock the top emergency exit. This key shall be Group 1 Security (see 8.1).

8.4.4.1.2 The top emergency exit shall be provided with a car door electric contact conforming to 2.14.1.5.1(f) and so located as to be inaccessible from the inside of the car. The opening of the electrical contact shall limit the car speed to not more than 0.75 m/s (150 ft/min).

8.4.5 Guiding Members and Position Restraints

8.4.5.1 Location. Upper and lower position restraints attached to the car frame shall be provided. The distance between the upper and lower position restraints shall be not less than the height of the car frame. Separate position restraints are not required where such restraints are an integral part of the guiding member.

8.4.5.2 Design

8.4.5.2.1 Position restraints and their attachments to car frames shall be designed to withstand a seismic force acting horizontally on the weight of the car plus 40% of its rated capacity as defined in 8.4.13 or 8.4.14 (with W_p = car weight + 40% capacity), or equal to

(a) $\frac{1}{2} W_p$ (zone 3 or greater)

(b) $\frac{1}{4} W_p$ (zone 2)

8.4.5.2.2 When the car is centrally located between its guide rails and the platform is level, the clearance between each running face of the guide rail and the position restraint shall not exceed 5 mm (0.187 in.) and the depth of engagement with the rail shall be not less than the dimension of the side running face of the rail.

(13) 8.4.6 Compensating Rope Sheave Assembly

Where compensating ropes are used with a tension sheave assembly, means shall be provided to prevent the tension sheave assembly from being dislocated from its normal operating position when subjected to seismic forces acting simultaneously as specified in 8.4.13 or 8.4.14, or equal to either of the following:

(a) W_p horizontally and $\frac{1}{2} W_p$ vertically (zone 3 or greater)

(b) $\frac{1}{2} W_p$ horizontally and $\frac{1}{4} W_p$ vertically (zone 2)

Compensating rope sheaves shall be provided with a compensating rope sheaves switch or switches conforming to 2.26.2.3.

8.4.7 Counterweights**8.4.7.1 Design**

(13) 8.4.7.1.1 The counterweight frame and its weight sections shall be so designed and arranged as to limit the guide-rail force at the lower position restraint to not more than two-thirds of the total seismic force due to the weight or effective weight of the counterweight assembly when it is subjected to a component seismic force level as defined by 8.4.13 or 8.4.14, or a horizontal seismic force equal to

(a) $\frac{1}{2} W_p$ (zone 3 or greater)

(b) $\frac{1}{4} W_p$ (zone 2)

8.4.7.1.2 For counterweight assemblies with weight sections that occupy two-thirds or more of the frame height, 8.4.8.9 applies and Figs. 8.4.8.2-1 through 8.4.8.2-7 shall be permitted to be used in sizing the guide-rail system.

(13) 8.4.7.1.3 The clearance between the counterweight frame and the face of the counterweight guide rail measured at a point one-half the vertical distance between the upper and lower guiding members shall not exceed 13 mm (0.5 in.).

8.4.7.2 Guiding Members and Position Restraints

8.4.7.2.1 Upper and lower position restraints attached to the counterweight frame shall be provided. The distance between the upper and lower position restraints shall be not less than the height of the counterweight frame. Separate position restraints are not required where such restraints are an integral part of guiding member.

(13) 8.4.7.2.2 Position restraints and their attachments to counterweight frames shall be designed to withstand a seismic component force level as defined by 8.4.13 or 8.4.14, or a seismic force acting horizontally upon the counterweight assembly equal to

(a) $\frac{1}{2} W_p$ (zone 3 or greater)

(b) $\frac{1}{4} W_p$ (zone 2)

8.4.7.2.3 When the counterweight is centrally located between its guide rails, the clearance between

each running face of the guide rail and the position restraint shall not exceed 5 mm (0.187 in.) and the depth of engagement with the rail shall be not less than the dimension of the side running face of the rail.

8.4.8 Car and Counterweight Guide-Rail Systems

8.4.8.1 General. The car and counterweight guide-rail systems shall meet the requirements of 8.4.8 or the applicable requirements of 2.23 (excluding 2.23.4.3 and Table 2.23.4.3.3), whichever are more stringent.

8.4.8.1.1 Elevator Guide-Rail Load Distribution. (13)

The load distribution to the guide rails due to the inertial effects of the car and counterweight on their respective guide rails shall be determined as follows:

(a) *Conventional Standard Designs.* The seismic forces shall be assumed to be distributed one-third to the top guiding members and two-thirds to the bottom guiding members of cars and counterweights.

(b) *Non-Standard Designs.* Where the design of the car, or counterweight, employs either special construction or location and quantity of guiding members, the formulas and methods of calculation of the load distribution, and resulting stresses and deflections, do not generally apply and shall be modified to suit the specific conditions and requirements in each case.

8.4.8.2 Seismic Load Application**8.4.8.2.1 (13)**

(a) For jurisdictions enforcing seismic zones or an equivalent ground motion parameter (see 8.4.13), W_p shall not exceed the maximums specified in Figs. 8.4.8.2-1 through 8.4.8.2-7 for the size of rail and the bracket spacing used.

(b) For jurisdictions enforcing IBC/NBCC, the permissible horizontal seismic force, F_p , based on W_p , per pair of guide rails shall not exceed the maximums specified in Figs. 8.4.8.2-1 through 8.4.8.2-7 for the size of rail and the bracket spacing used (see 8.4.12.1 and Guide for Elevator Seismic Design Part 2, Sample Calculation 3).

8.4.8.2.2 (ED) Where the ratio of the distance between the upper and lower car or counterweight position restraints to the distance between adjacent brackets is 0.65 or less, an adjusted weight shall be used to determine the required rail size for the bracket spacing used. The adjusted weight shall be determined by multiplying the actual weight by a load factor Q obtained from Fig. 8.4.8.2-8 as follows:

$$W_a = QW$$

where

Q = load factor (see Fig. 8.4.8.2-8)

W = actual weight of the counterweight or of the car plus 40% of its rated capacity, N (lb)

W_a = adjusted weight, N (lb)

Fig. 8.4.8.2-1 12 kg/m (8 lb/ft) Guide-Rail Bracket Spacing

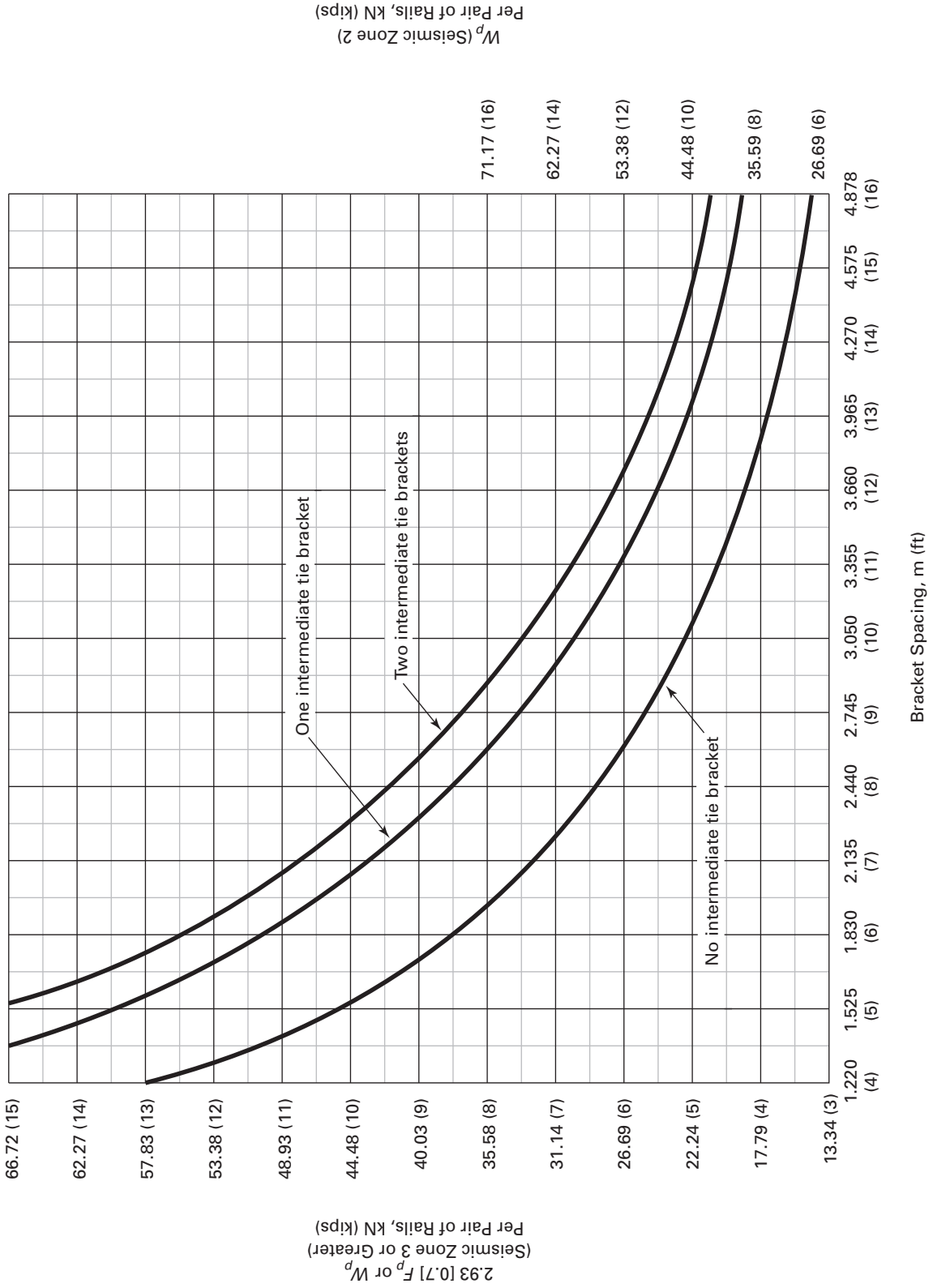

(13)

Fig. 8.4.8.2-2 16.5 kg/m (11 lb/ft) Guide-Rail Bracket Spacing

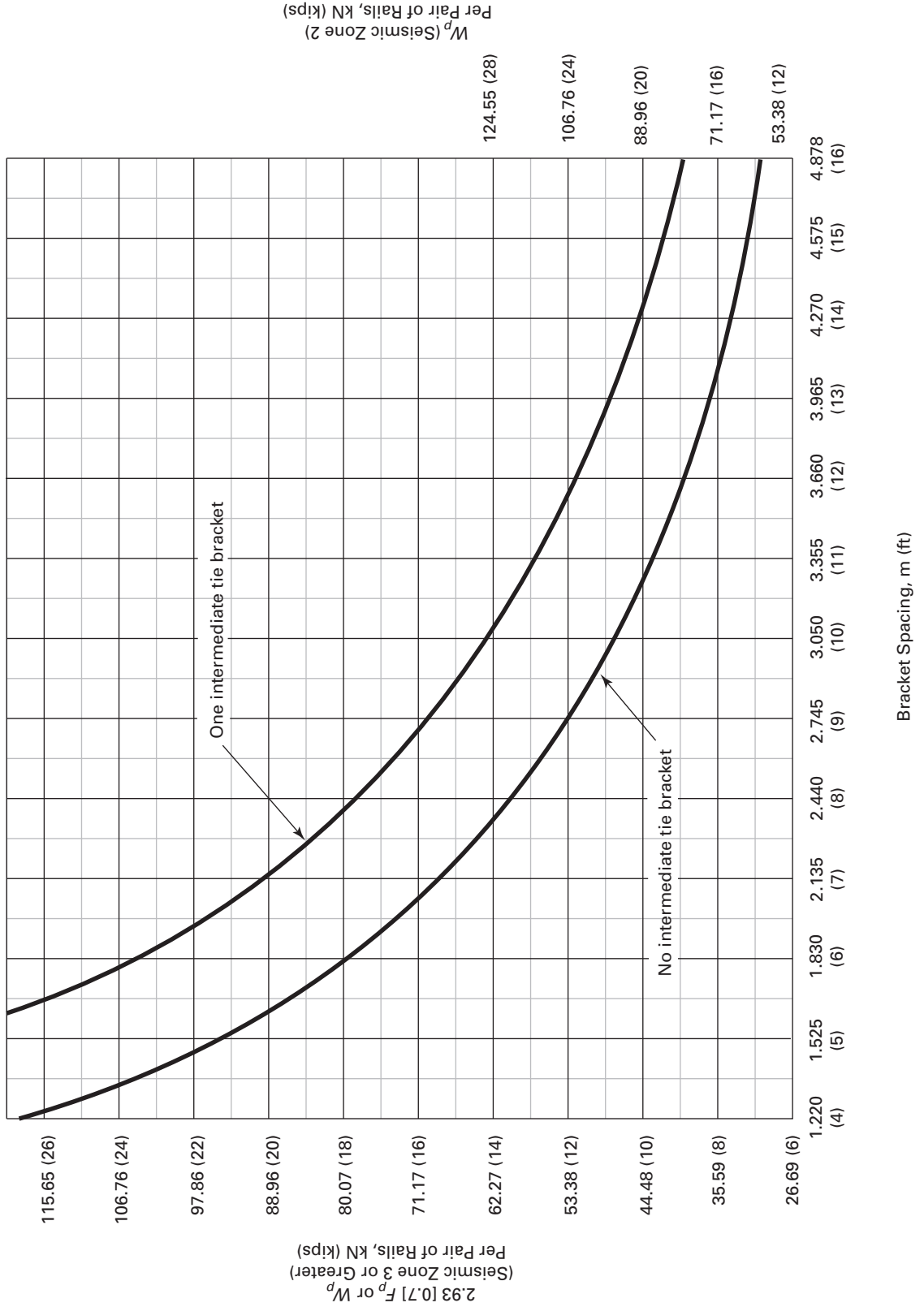

(13)

Fig. 8.4.8.2-3 18 kg/m (12 lb/ft) Guide-Rail Bracket Spacing

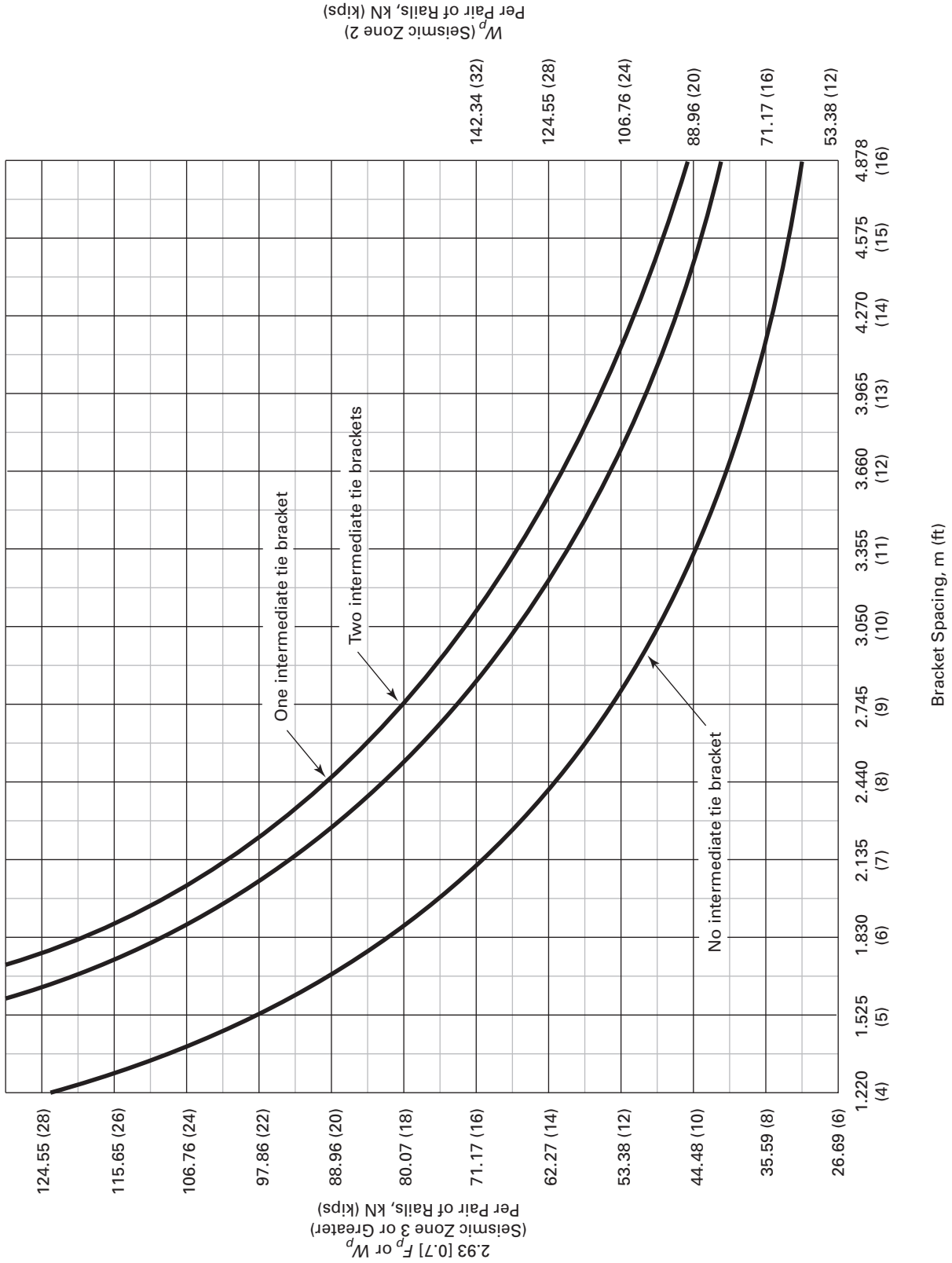

(13)

Fig. 8.4.8.2-4 22.5 kg/m (15 lb/ft) Guide-Rail Bracket Spacing

(13)

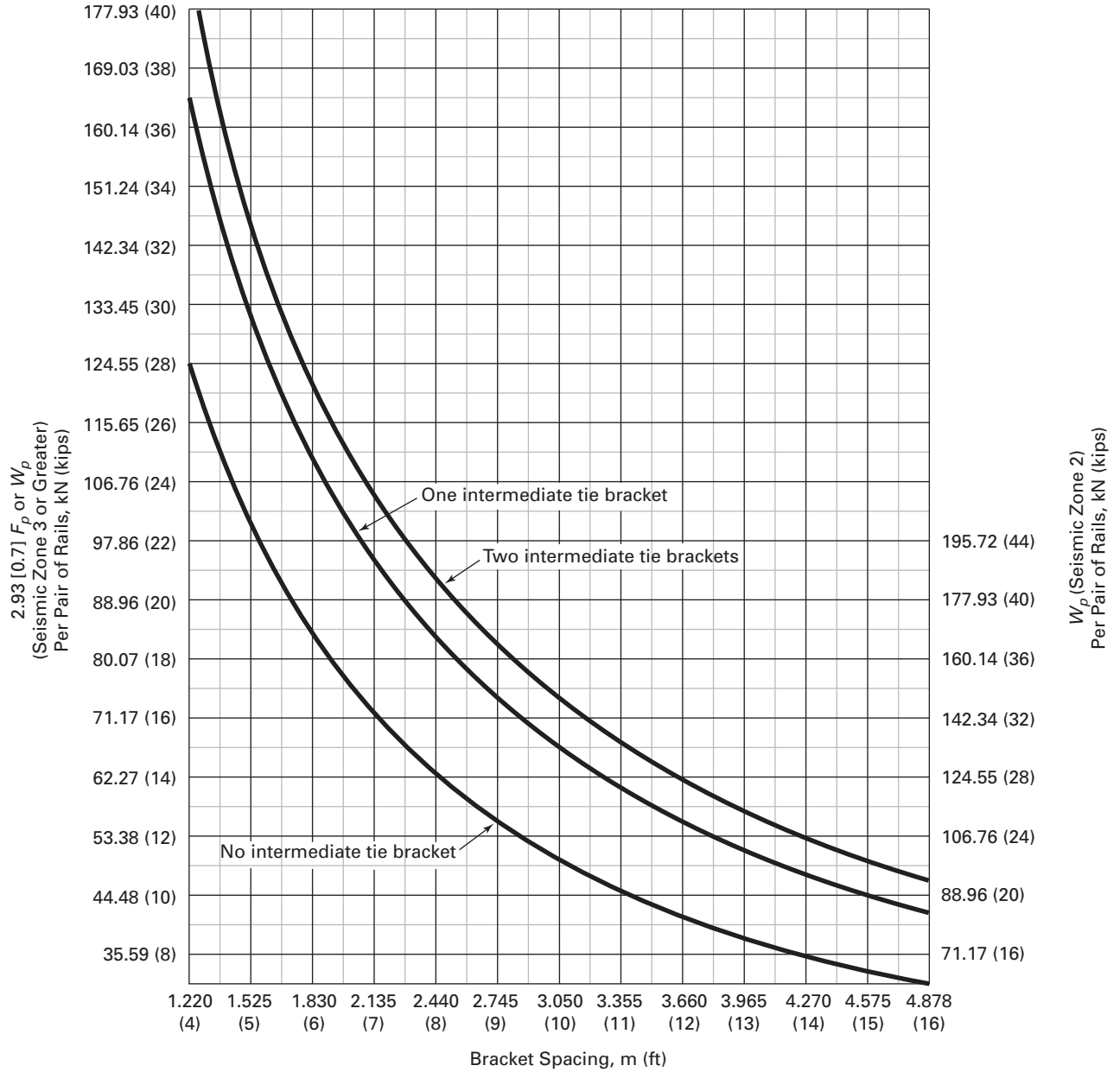
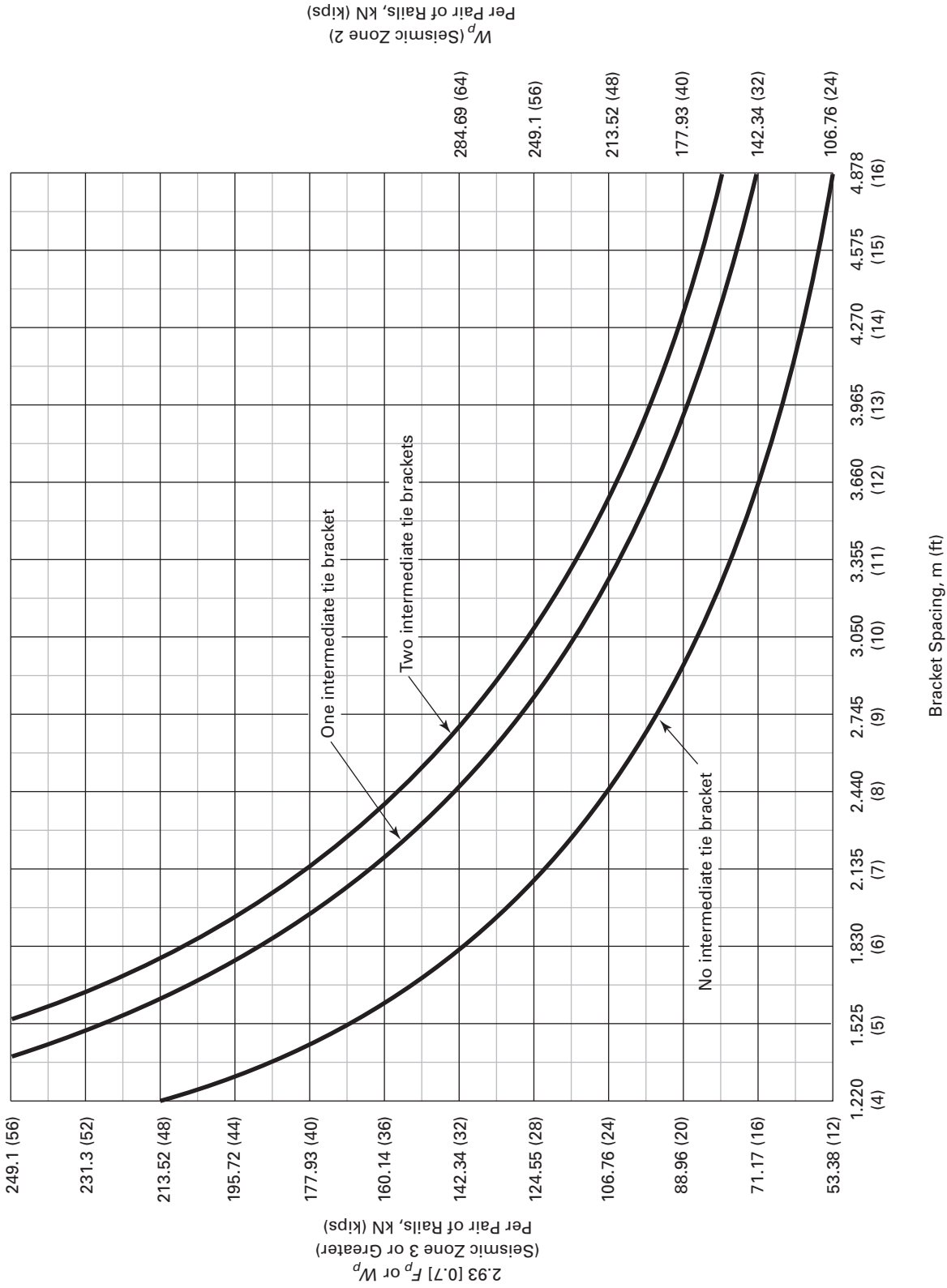

Fig. 8.4.8.2-5 27.5 kg/m (18.5 lb/ft) Guide-Rail Bracket Spacing



(13)

Fig. 8.4.8.2-6 33.5 kg/m (22.5 lb/ft) Guide-Rail Bracket Spacing

(13)

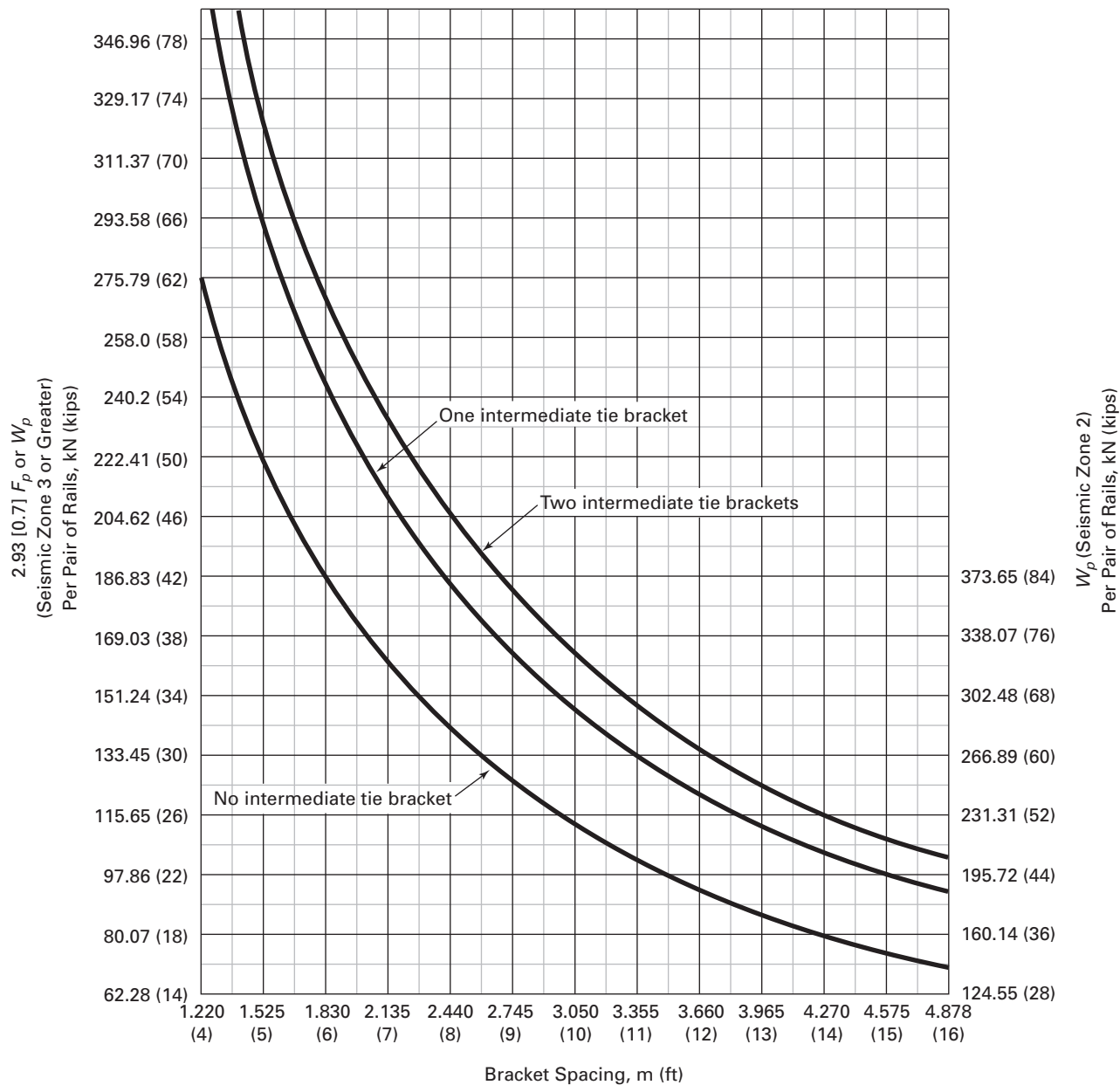

(13)

Fig. 8.4.8.2-7 44.5 kg/m (30 lb/ft) Guide-Rail Bracket Spacing

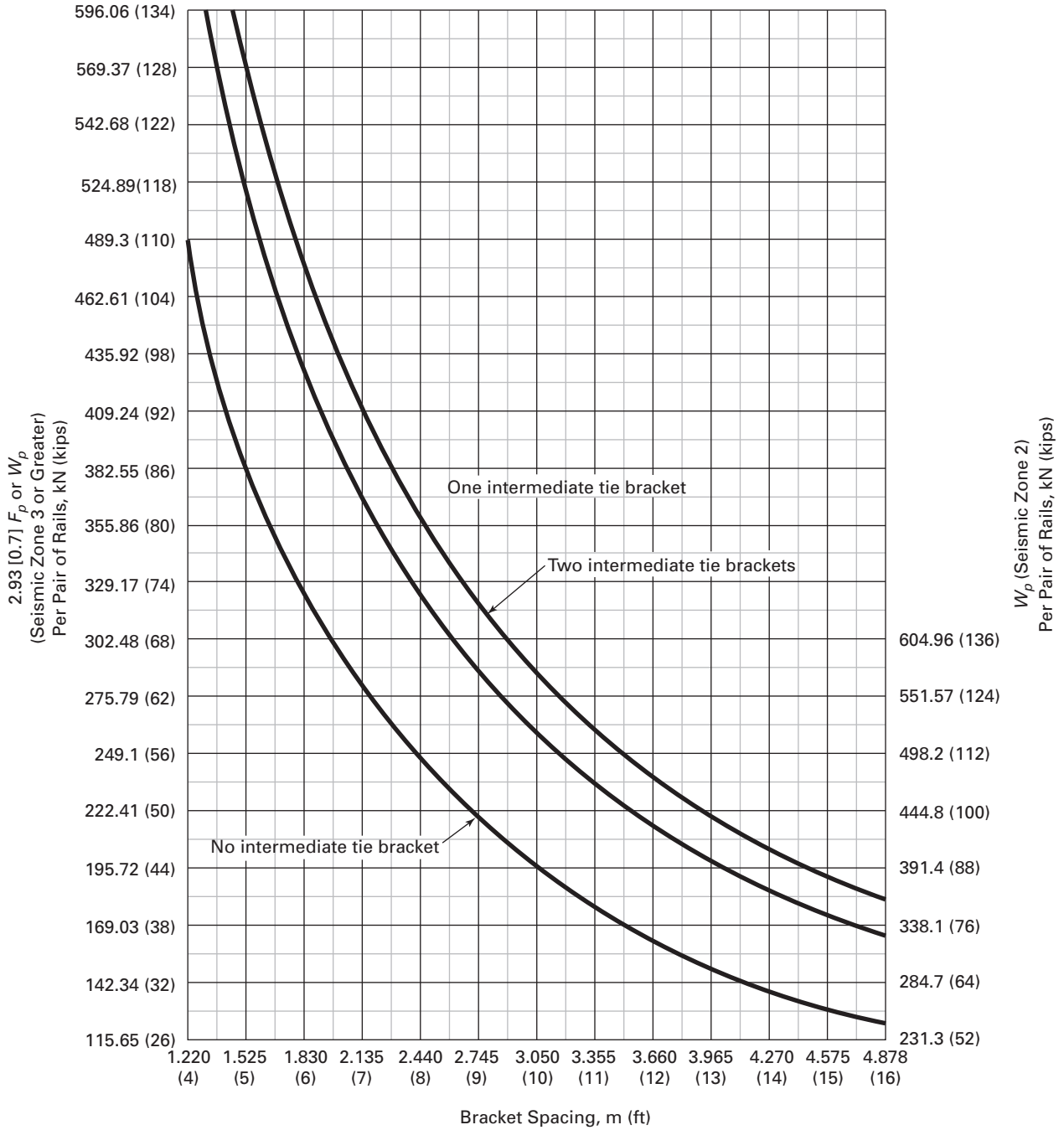
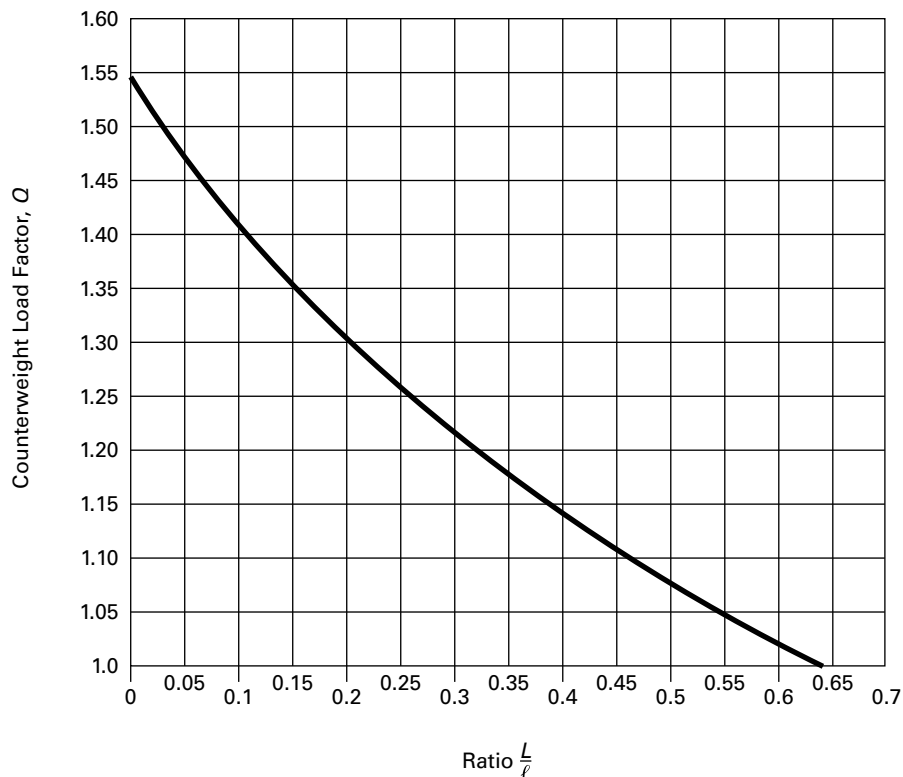

Fig. 8.4.8.2-8 Car and Counterweight Load Factor



L = distance between upper and lower counterweight position restraints, mm (in.)

ℓ = distance between guide brackets, mm (in.)

W = actual weight of counterweight, kg (lb)

W_a = adjusted weight of counterweight, kg (lb)

For ratios of $L/\ell < 0.65$, the adjusted counterweight $W_a = QW$ is to be used in determining bracket spacing and the number of intermediate tie brackets required.

EXAMPLE (Per 15 lb Guide Rail):

(SI Units)

For ratio $L/\ell = 0.15$, and actual weight of counterweight = 3 630 kg

$$Q = 1.35$$

$$W_a = 1.35 (3,630) = 4 900 \text{ kg}$$

From Fig. 8.4.8.2-4 zone 3 or greater

Required bracket spacing = 3 200 mm (no tie bracket)

or = up to 4 215 mm (one tie bracket)

or = up to 4 675 mm (two tie brackets)

(Imperial Units)

For ratio $L/\ell = 0.15$, and actual weight of counterweight = 8,000 lb

$$Q = 1.35$$

$$W_a = 1.35 (8,000) = 10 800 \text{ lb}$$

From Fig. 8.4.8.2-4 zone 3 or greater

Required bracket spacing = 10 ft 6 in. (no tie bracket)

or = up to 13 ft 10 in. (one tie bracket)

or = up to 15 ft 4 in. (two tie brackets)

8.4.8.2.3 Where the guide rail is reinforced or a rail of larger size is used, the bracket spacing shall be permitted to exceed the values specified in Figs. 8.4.8.2-1 through 8.4.8.2-7 for a given car weight plus 40% of its rated capacity, or counterweight, provided the variation conforms to 8.4.12.

EXAMPLES:

- (1) *SI Units.* 5 543 kg counterweight, or car weight plus 40% rated capacity, at a bracket spacing of 4.88 m requires for zone 3 or greater:
 - (a) a 27.5 kg/m rail without reinforcement; or
 - (b) a 22.5 kg/m rail with reinforcement having a combined moment of inertia of $3.33 \text{ E} + 06 \text{ mm}^4$ and a combined section modulus of $5.26 \text{ E} + 04 \text{ mm}^3$ about an axis parallel to the base (axis $x-x$).
- (2) *Imperial Units.* 12,000 lb counterweight, or car weight plus 40% rated capacity, at a bracket spacing of 16 ft requires for zone 3 or greater:
 - (a) an 18.5 lb rail without reinforcement; or
 - (b) a 15 lb rail with reinforcement having a combined moment of inertia of 8 in.^4 and a combined section modulus of 3.21 in.^3 about an axis parallel to the base (axis $x-x$).

8.4.8.2.4 For counterweight systems, intermediate tie brackets conforming to 8.4.8.7 and approximately equally spaced between main brackets shall be provided between guide rails as required by Figs. 8.4.8.2-1 through 8.4.8.2-7. Intermediate tie brackets are not required to be fastened to the building structure.

8.4.8.2.5 The total weight of the counterweight assembly shall not exceed the maximum specified in Table 2.23.4.3.1 for a given rail size.

(13) 8.4.8.2.6 Rail Forces

- (a) The horizontal seismic forces used to determine guide-rail stresses and deflections are
 - (1) For jurisdictions enforcing seismic zones
 - (a) $\frac{1}{2} W_p$ (zone 3 or greater); or
 - (b) $\frac{1}{4} W_p$ (zone 2)
 - (2) For jurisdictions enforcing IBC/NBCC
 - (a) F_p when calculating deflection
 - (b) $0.7F_p$ when calculating stress
- (b) For installations where the guide rails bear the vertical loads imposed by machines, sheaves, or hitches, the following vertical loads will be considered acting simultaneously in addition to those above:
 - (1) For jurisdictions enforcing seismic zones
 - (a) $\frac{1}{4} W_p$ (zone 3 or greater); or
 - (b) $\frac{1}{8} W_p$ (zone 2)
 - (2) For jurisdictions enforcing IBC/NBCC
 - (a) F_v when calculating deflection
 - (b) $0.7F_v$ when calculating stress

where W_p is defined in 8.4.15(b), F_p and F_v are defined in 8.4.14.

NOTE: The forces above are the result of both any equipment attached to the rail and the tensions developed in the suspension ropes by the car and counterweight.

8.4.8.3 Guide-Rail Stress (13)

8.4.8.3.1 For jurisdictions enforcing seismic zones, stresses in a guide rail, or in a rail and its reinforcement, due to seismic loads specified in 8.4.8.2.6, shall not exceed 88% of the minimum yield stress of the material or materials used.

8.4.8.3.2 For jurisdictions enforcing IBC/NBCC, stresses in the guide rail, or in a rail and its reinforcements, due to seismic loads specified in 8.4.8.2.6, shall not exceed 60% of the minimum yield stress of the material or materials used.

8.4.8.4 Brackets, Fastenings, and Supports (13)

8.4.8.4.1 Guide-rail brackets and their fastenings and supports, such as building beams and walls, shall be capable of withstanding the forces imposed by the seismic loads specified in 8.4.8.2.6, with a total deflection at the point of support not to exceed 6 mm (0.25 in.).

8.4.8.4.2 In jurisdictions enforcing IBC/NBCC, the Nonstructural Component Anchorage shall be in conformance with the requirements of the governing building code.

8.4.8.5 Type and Strength of Rail Joints. Metal guide rails shall be joined together by fishplates as specified in 8.4.8.6 and shall be designed to withstand the forces specified in 2.23.5.1 and 8.4.8.3 without exceeding the stress and deflection limitations.

8.4.8.6 Design and Construction Rail Joints

8.4.8.6.1 The joints of metal guide rails shall conform to the following requirements:

- (a) The ends of the rails shall be accurately machined with a tongue and matching groove centrally located in the web.
- (b) The backs of the rail flanges shall be accurately machined, in relation to the rail guiding surfaces, to a uniform distance front to back of the rails to form a flat surface for the fishplates.
- (c) The ends of each rail shall be bolted to the fishplates with not less than four bolts.
- (d) The width of the fishplate shall be not less than the width of the back of the rail.
- (e) The section modulus and the moment of inertia of the fishplate shall be not less than that of the rail.
- (f) The diameter of the bolts for each size of guide rails shall be not less than specified in Table 2.23.7.2.1.
- (g) The diameter of bolt holes shall not exceed the diameter of the bolts by more than 2 mm (0.08 in.) for guide rails nor 3 mm (0.125 in.) for fishplates.
- (h) The threaded portion of the bolts shall not occur in the shear plane of the guide-rail fishplate assembly.

8.4.8.6.2 Joints of different design and construction to those specified shall be permitted to be used,

provided they are equivalent in strength and will adequately maintain the accuracy of the rail alignment.

- (13) **8.4.8.7 Design and Strength of Brackets and Supports.** Guide-rail brackets including intermediate tie brackets, where provided, shall be designed to withstand the forces imposed by the seismic loads specified in 8.4.8.2.6. The stresses and deflections shall not exceed those specified in Table 8.4.8.7.

NOTE (8.4.8.7): Since the specific designs of the rail brackets, their reinforcements where provided, and the method of attachment to the building structure will vary between designs, the maximum stresses and deflections shall be analyzed to suit the specific design.

- (ED) **8.4.8.8 Type of Fastenings.** Guide rails shall be secured to their brackets by clips, welds, or bolts. Bolts used for fastening shall be of such strength as to withstand the forces specified in 2.23.5.2 and 2.23.9.1, plus 8.4.8.4 and 8.4.8.7.

Welding, where used, shall conform to 8.8.

- (ED) **8.4.8.9 Information on Elevator Layouts.** The following information regarding horizontal seismic forces imposed on the guide-rail brackets by the position restraints of the car or counterweight is required on elevator layout drawings. The forces are to be determined as specified in 8.4.8.9.1 and 8.4.8.9.2 (see Fig. 8.4.8.9).

- (13) **8.4.8.9.1** Force normal to the $x-x$ axis of the guide rail:

(a) Where $L \geq \ell$ (see Table 8.4.8.7):

$$F_{x-x} = \frac{W_p}{3} \quad (\text{Zone } \geq 3)$$

$$F_{x-x} = \frac{W_p}{6} \quad (\text{Zone } 2)$$

$$F_{x-x} = \frac{2F_p}{3} \quad (\text{IBC/NBCC Jurisdictions})$$

(b) Where $L < \ell$ (see Table 8.4.8.7):

$$F_{x-x} = \left(\frac{W_p}{2}\right) \left(1 - \frac{L}{3\ell}\right) \quad (\text{Zone } \geq 3)$$

$$F_{x-x} = \left(\frac{W_p}{4}\right) \left(1 - \frac{L}{3\ell}\right) \quad (\text{Zone } 2)$$

$$F_{x-x} = F_p \left(1 - \frac{L}{3\ell}\right) \quad (\text{IBC/NBCC Jurisdictions})$$

- (13) **8.4.8.9.2** Where normal to the $y-y$ axis:

(a) Where $L \geq \ell$ (see Table 8.4.8.7):

$$F_{y-y} = \frac{W_p}{6} \quad (\text{Zone } \geq 3)$$

$$F_{y-y} = \frac{W_p}{12} \quad (\text{Zone } 2)$$

$$F_{y-y} = \frac{F_p}{3} \quad (\text{IBC/NBCC Jurisdictions})$$

(b) Where $L < \ell$ (see Table 8.4.8.7):

$$F_{y-y} = \left(\frac{W_p}{4}\right) \left(1 - \frac{L}{3\ell}\right) \quad (\text{Zone } \geq 3)$$

$$F_{y-y} = \left(\frac{W_p}{8}\right) \left(1 - \frac{L}{3\ell}\right) \quad (\text{Zone } 2)$$

$$F_{y-y} = \left(\frac{F_p}{2}\right) \left(1 - \frac{L}{3\ell}\right) \quad (\text{IBC/NBCC Jurisdictions})$$

where

F_{x-x}, F_{y-y} = seismic force, N (lbf)

W_p = total weight of car plus 40% of its rated load, or the total weight of the counterweight, N (lb)

F_p = seismic component force as defined in 8.4.14

NOTE: For SI units — N = kg * 9.807

8.4.8.9.3 Where an expansion joint is located within the elevator installation, the location and maximum design displacement shall be indicated on the layout drawings.

8.4.9 Driving Machines and Sheaves

8.4.9.1 Seismic Requirements for Driving Machine (13)

and Sheaves. All integral parts of driving machines together with their supports shall be capable of withstanding the inertia effect of their masses without permanent deformation when subjected to seismic forces acting separately as defined in 8.4.13 or 8.4.14, or equal to

(a) W_p horizontally and $\frac{1}{2} W_p$ vertically (zone 3 or greater)

(b) $\frac{1}{2} W_p$ horizontally and $\frac{1}{4} W_p$ vertically (zone 2)

8.4.10 Emergency Operation and Signaling Devices

8.4.10.1 Operation of Elevators Under Earthquake (13)

Emergency Conditions. Earthquake emergency operation shall be provided and conform to 8.4.10. Earthquake emergency operation is not required for risk zone 2, or $F_p \leq 0.25 W_p$ with $z/h = 1$ (for IBC/ASCE 7) or $h_x/h_n = 1$ (for NBCC) (see 8.4.14.2), provided the car and counterweight guide-rail systems, guiding members, and position restraints conform to the requirements and force levels for zone 3 or greater in 8.4.5, 8.4.7, and 8.4.8 where

W_p = component operating weight as defined by 8.4.15

8.4.10.1.1 Earthquake Equipment (See Also (13) Fig. 8.4.10.1.1)

(a) All traction elevators operating at a rated speed of 0.75 m/s (150 ft/min) or more and having counterweights located in the same hoistway shall be provided with the following:

(1) For seismic zone 3 or greater, or $F_p > 0.25 W_p$ with $z/h = 1$ (for IBC/ASCE 7) or $h_x/h_n = 1$ (for NBCC): a minimum of one seismic switch per building

Table 8.4.8.7 Stresses and Deflections of Guide-Rail Brackets and Supports

| Guide-Rail Bracket | L | Bracket Type | Vertical Location | Typical Figure | Bracket Moment of Inertia, mm ⁴ (in. ⁴) | Bracket Design Load, P [Notes (1) and (2), and (3)] | | Allowable [Notes (6) and (7)] | |
|----------------------------------|---|---|------------------------|--------------------------|--|---|---|---------------------------------|--|
| | | | | | | N (lb) | Stress, MPa (psi) | Deflection, mm (in.) [Note (4)] | |
| Main (car and counterweight) | ≥ Rail span ℓ | Any | Building supports | ... | ... | $\left(\frac{W_p}{3}\right)$ | Guide-Rail Brackets: No permanent deformation | 6 (0.25) | |
| | | | | | | $CB \left(\frac{2F_p}{3}\right)$ [Note (3)] | | | |
| | < Rail span ℓ | $\left(\frac{W_p}{2}\right) \left(1 - \frac{L}{3\ell}\right)$ [Notes (1) and (2)] | Fastenings: 8.4.2.3.3. | Supports: N/A [Note (5)] | | | | | |
| ... | $\left(CB\right) \left(F_p\right) \left(1 - \frac{L}{3\ell}\right)$ [Notes (1) and (3)] | | | | | | | | |
| Intermediate tie (counterweight) | ... | Double "U" bracket | Mid-span | | l _d | $\left(\frac{W_p}{6}\right)$ | ... | ... | |
| | | | 1/3 span | | | | | | |
| Intermediate tie (counterweight) | ... | Single "U" bracket | Mid-span | | 2l _d | $CB \left(\frac{F_p}{3}\right)$ | ... | ... | |
| | | | 1/3 span | | | | | | |

- F_p = seismic component force, N (lb)
- l_d = moment of inertia of single "U" intermediate, tie bracket, mm⁴ (in.⁴), in a double "U" bracket arrangement
- L = vertical distance between the upper and lower position restraints required by 8.4.5.1 and 8.4.7.2, mm (in.)
- ℓ = distance (rail span) between adjacent main guide-rail brackets, mm (in.)
- W = maximum weight of car with 40% rated capacity or counterweight, kg (lb)
- P = horizontal seismic load, N (lb)

(13)

Table 8.4.8.7 Stresses and Deflections of Guide-Rail Brackets and Supports (Cont'd)

(13)

NOTES:

- (1) For hydraulic elevator main bracket design load (car) add $\frac{1}{4}$ the weight of the plunger (zone 3 or greater).
- (2) For zone 2, multiply design load "p" by 0.5.
- (3) $CB = 0.7$ for purposes of stress calculations.
 $CB = 1.0$ for purposes of deflection calculations.
- (4) This limitation includes the combined deflections of the guide-rail bracket, fastenings, and building supports.
- (5) The design of supports beyond deflection is the responsibility of the Structural Engineer of Record.
- (6) The maximum combined stresses in any structural component due to all causes shall be based on sound engineering practice, and shall not exceed the allowable values specified in ANSI/AISC 360, Chapter H (Design of Members for Combined Forces and Torsion), for individual components.
- (7) For jurisdictions enforcing seismic zones, allowable stresses may be increased by $\frac{1}{3}$. For jurisdictions enforcing the IBC or NBCC 2005 or later editions, no $\frac{1}{3}$ increase is allowed.

Fig. 8.4.8.9 Guide-Rail Axes

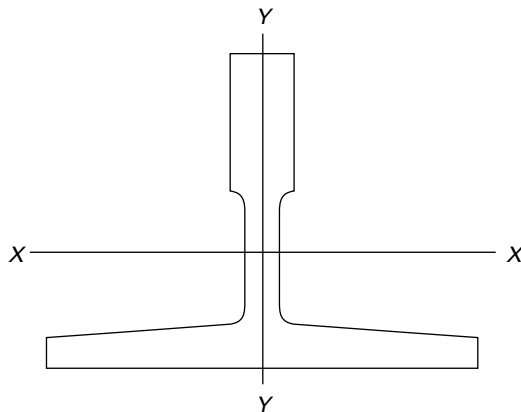

(2) For all elevators covered by Section 8.4

(a) a displacement switch for each elevator

(b) an identified momentary reset button or switch for each elevator, located in the control panel in the elevator machine room [see 8.4.10.1.3(i)]

(b) For attendant-operated elevators and automatic elevators on designated attendant service, a signal system consisting of both visual and audible types activated by either the seismic switch or the displacement switch shall be provided to alert the attendant that the car is under earthquake emergency control and that the attendant is to return the car to the nearest available floor. The audible signal required by 2.27.3.1.6(h) shall be permitted to be used for this purpose in lieu of a separate audible signal.

8.4.10.1.2 Equipment Specifications

(a) Earthquake protective devices shall be of the fail-safe type.

(b) Seismic switch shall activate upon excitation in a vertical direction of not more than 0.15 times gravity acceleration, 9.81 m/s^2 (32.2 ft/s^2). The frequency response of the switch shall be 1 Hz to 10 Hz.

Where the seismic switch is used exclusively to control the elevators, it shall be located in the elevator machine room and, where possible, shall be mounted adjacent to a vertical load-bearing building structural member.

(c) A displacement switch shall be activated by the derailment of the counterweight at any point in the hoistway to provide information to the control system that the counterweight has left its guides.

(d) Earthquake protective devices with exposed live electrical parts in the hoistway shall operate at not more than 24 V root mean square alternating current or 24 V direct current above or below ground potential and shall not be capable of supplying more than 0.5 A when short-circuited.

8.4.10.1.3 Elevator Operation (See Fig. 8.4.10.1.3)

(a) Upon activation of a seismic switch, all elevators with traction machines, counterweights, and selective, collective, or group automatic operation that are in motion shall proceed to the nearest available floor, open their doors, and shut down; except that where Phase II Emergency In-Car Operation is in effect, door operation shall conform to 2.27.3.3.

(b) When the counterweight displacement switch is activated, the elevator, if in motion, shall initiate an emergency stop and then proceed away from the counterweight at a speed of not more than 0.75 m/s (150 ft/min) to the nearest available floor, open the doors, and shut down; except that where Phase II Emergency In-Car Operation is in effect, door operation shall conform to 2.27.3.3.

(c) Elevators with power-operated doors, upon reaching a landing shall cause their doors to open and remain open; except that where Phase II Emergency In-Car Operation is in effect, door operation shall conform to 2.27.3.3.

(d) Upon activation of an earthquake protective device, an elevator standing at a floor with its doors open shall remain at the floor. If its doors are closed, it shall open its doors. Where Phase II Emergency In-Car Operation is in effect, door operation shall conform to 2.27.3.3.

(e) An elevator not in operation when an earthquake protective device is activated shall remain at the landing.

(f) An elevator shall be permitted to be operated at a speed of not more than 0.75 m/s (150 ft/min), provided the counterweight displacement switch is of the continuously monitoring type and is not activated.

(g) Continuous activation of a displacement switch shall

(1) prevent operation of the car, except from the inspection station located on top of the car

(2) prevent operation of the car by means of the emergency service key described in 2.27.3.1 and 2.27.3.3, hospital emergency service key, and other similar types of operation

(h) Elevators stopped by an earthquake protective device with a volatile-type memory shall remain idle in the event of a power failure. Subsequent restoration of power shall not cancel the status of the earthquake protective devices nor the slow speed status of the elevator system if such existed prior to the loss of power.

(i) An elevator shall be permitted to be returned to normal service by means of the momentary reset button or switch [see 8.4.10.1.1(a)(2)], provided the displacement switch is not activated.

(j) Electrical protective devices required by 2.26.2 shall not be rendered inoperative nor bypassed by earthquake protective devices

8.4.10.1.4 Maintenance of Equipment. Earthquake protective devices shall be arranged to be checked for

Fig. 8.4.10.1.1 Earthquake Elevator Equipment Requirements Diagrammatic Representation

(13)

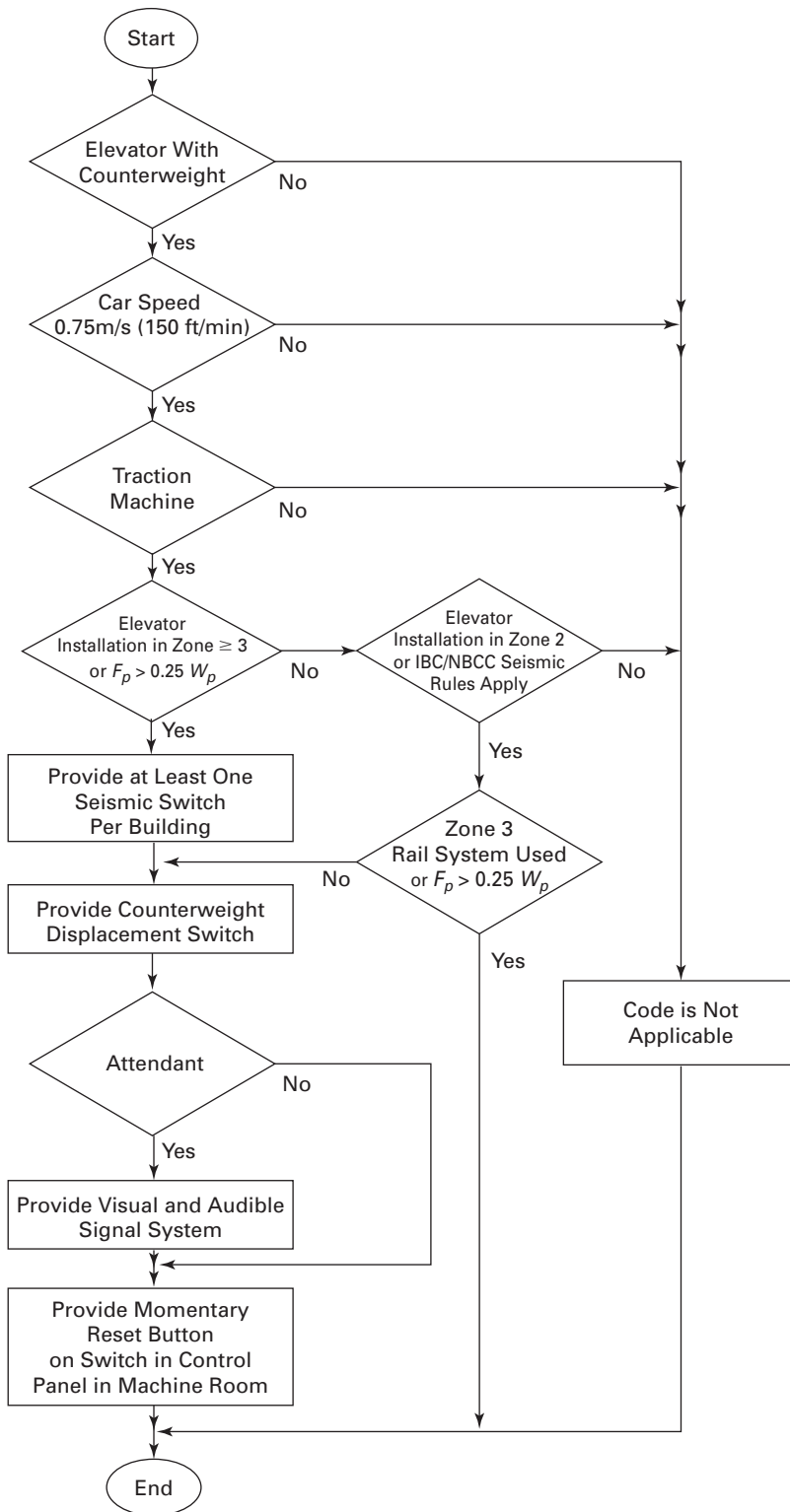
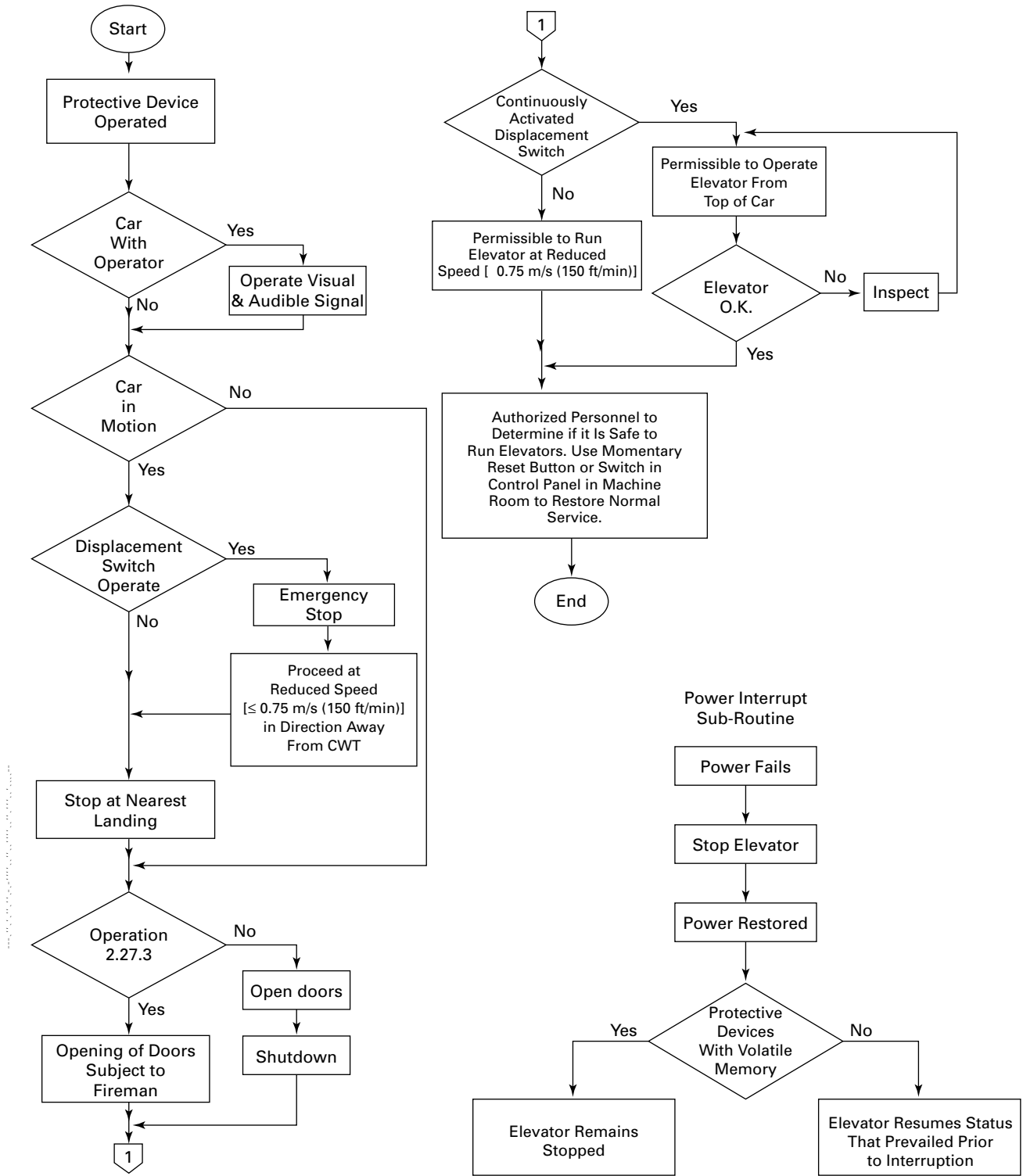

Fig. 8.4.10.1.3 Earthquake Emergency Operation Diagrammatic Representation



satisfactory operation and shall be calibrated at intervals specified by the manufacturer.

8.4.11 Hydraulic Elevators

Requirement 8.4.11 applies to all direct-acting hydraulic elevators and roped-hydraulic elevators.

For roped-hydraulic elevators other than those defined by Section 1.3 (Definitions), the requirements, formulas, and specified methods of calculation of loads and the resulting stresses and deflections do not generally apply and shall be modified to suit the specific conditions and requirements in each case.

8.4.11.1 Horizontal Car and Counterweight Clearances. Where hydraulic elevators are provided with counterweights, clearances shall conform to 8.4.1.

8.4.11.2 Beams, Supports, and Floors

- (13) **8.4.11.2.1 Securing Beams and Supports.** Overhead beams for attaching hitch plates shall be anchored to prevent overturning and displacement as a result of seismic forces acting simultaneously as specified in 8.4.13 or 8.4.14, or equal to

(a) W_p horizontally and $\frac{1}{2} W_p$ vertically (zone 3 or greater)

(b) $\frac{1}{2} W_p$ horizontally and $\frac{1}{4} W_p$ vertically (zone 2)

8.4.11.2.2 Floors. Fastening means in compliance with 8.4.2.3 shall be provided to prevent hydraulic machines, control panels, and storage tanks from being overturned or displaced.

8.4.11.3 Guarding of Equipment

- (ED) **8.4.11.3.1 Rope Retainers.** Rope retainers provided on traveling sheaves and deflecting sheaves, in accordance with 3.18.1.2.4, shall comply with 8.4.3.1.2 through 8.4.3.1.4.

8.4.11.4 Car Enclosures, Car Doors and Gates, and Car Illumination. Requirement 8.4.4 does not apply to hydraulic elevators.

8.4.11.5 Guiding Members and Position Restraints. Guiding members and position restraints shall conform to 8.4.5 and 8.4.11.5.1.

8.4.11.5.1 Traveling Sheave Position Restraints Location. Position restraints attached to the traveling sheave shall be provided for roped-hydraulic elevators. Separate position restraints are not required where such restraints are an integral part of the guiding means.

- (13) **8.4.11.5.2 Design.** Position restraints and their attachments to the traveling sheave shall be designed to withstand a seismic force acting in a horizontal direction as defined in 8.4.13 or 8.4.14, or equal to

(a) W_p (zone 3 or greater)

(b) $\frac{1}{4} W_p$ (zone 2)

on $\frac{1}{2}$ the weight of the driving member of the hydraulic jack plus the weight of the traveling sheave and its attachments.

8.4.11.6 Car and Counterweight Safeties. Requirement 8.4.6 does not apply to hydraulic elevators.

8.4.11.7 Counterweights. Where counterweights are provided, they shall conform to 8.4.7.

8.4.11.8 Guide Rails, Guide-Rail Supports, and Fastenings. Guide rails, guide-rail supports, and their fastenings shall conform to the following, whichever is more restrictive:

(a) Where car safeties are provided, 3.17.2 shall apply.

(b) Seismic load application

(1) Requirement 8.4.8 shall apply.

(2) The load on the car side of direct-plunger hydraulic elevators shall be as determined by 8.4.8.3(a) and (b).

(3) Requirement 8.4.8.9 shall not apply.

8.4.11.9 Hydraulic Jacks. The attachment of above ground hydraulic jacks to the building structure shall be capable of withstanding the inertia effect of their masses without permanent deformation when subjected to seismic forces as defined in 8.4.13 or 8.4.14, or separate acting forces equal to

(a) W_p horizontally and $\frac{1}{2} W_p$ vertically (zone 3 or greater)

(b) $\frac{1}{2} W_p$ horizontally and $\frac{1}{4} W_p$ vertically (zone 2)

8.4.11.10 Emergency Operation and Signaling Devices. Requirement 8.4.10 does not apply to hydraulic elevators.

8.4.11.11 Machine Rooms and Machinery Spaces. Where buildings are designed with expansion joints, the machine room and the hoistway shall be located on the same side of an expansion joint.

8.4.11.12 Overspeed Valve and Plunger Gripper. (13) Hydraulic elevators not provided with car safeties complying with 3.17.2 shall be provided with

(a) an overspeed valve(s) conforming to 3.19.4.7, or

(b) a plunger gripper(s) conforming to 3.17.3, except as modified by 8.4.11.2(b)(1) and (2).

(1) Requirement 3.17.3.2 applies as modified. The primary actuation means shall be mechanical or hydraulic. Electrical means are permitted as a secondary actuation means.

(2) The plunger gripper shall be capable of withstanding inertia effects of the elevator masses without operational failure when subjected to seismic forces acting separately, as defined in 8.4.13 or 8.4.14, or equal to

(a) for zone 3 or greater, or $F_p > 0.25W_p$ with $z/h = 1$ (or $h_x/h_n = 1$)

(1) W_{plgr} horizontally

(2) $\frac{1}{2} (W_{plgr} + W_p)$ vertically

Table 8.4.11.13 Pipe Support Spacing

| Nominal Pipe Size, in. | Maximum Spacing Between Supports, mm (in.) |
|------------------------|--|
| 1.0 | 1 525 (60) |
| 1.5 | 2 300 (90) |
| 2.0 | 2 600 (102) |
| 2.5 | 2 750 (108) |
| 3.0 | 3 000 (120) |
| 4.0 | 3 500 (138) |

(b) for zone 2 or $F_p \leq 0.25W_p$ with $z/h = 1$ or $h_x/h_n = 1$

- (1) $\frac{1}{2}W_{plgr}$ horizontally
- (2) $\frac{1}{4}(W_{plgr} + W_p)$ vertically

where W_{plgr} = weight of plunger

8.4.11.13 Piping Supports. Piping supports to restrain transverse motion shall be provided near changes in direction and particularly near valves and joints and shall comply with 8.4.2.3.

Horizontal spans shall be supported at intervals not to exceed those specified in Table 8.4.11.13.

(a) Spacing is based on a natural frequency limit of 20 Hz. The pipe is presumed to have oil in it and, for an added margin of safety, the oil is assumed to weigh 900 kg/m³ (56 lb/ft³) at 15.6°C (60°F).

(b) Maximum combined bending and shear stress is limited to 71.8 kPa (1,500 psi).

(c) Maximum sag at the center of the span is limited to 2.5 mm (0.1 in.).

(d) For pipe sizes other than shown, the maximum spacing between supports shall be determined by the following formula:

(SI Units)

$$\ell = 0.01163 \left(\frac{EI}{9.807W} \right)^{1/4}$$

(Imperial Units)

$$\ell = 0.192 \left(\frac{EI}{W} \right)^{1/4}$$

where

E = modulus of elasticity for steel [$2\,068 \times 10^6$ MPa (30×10^6 psi)]

I = moment of inertia or pipe, mm⁴ (in.⁴)

ℓ = maximum spacing between supports, m (ft)

W = weight per foot of pipe with oil at 15.6°C (60°F), kg/m (lb/ft)

$$0.192 = \text{constant} = \left[\frac{\pi}{40} \left(\frac{32.2}{144} \right)^{1/2} \right]^{1/2}$$

8.4.11.14 Support of Tanks. Means shall be provided to prevent the tank from being overturned or displaced. Such means shall comply with 8.4.2.3.

8.4.11.15 Information on Elevator Layouts. The following information is required on elevator layout drawings. The horizontal seismic forces imposed on the guide-rail brackets by the position restraints of the traveling sheave and the position restraints of the car or the counterweight (where provided) shall be determined as shown in 8.4.11.15.1 and 8.4.11.15.2. (ED)

8.4.11.15.1 Force normal to (x - x) axis of the guide rail (see 8.4.8.9): (13)

(a) Where $L \geq \ell$ (see Table 8.4.8.7):

$$F_{x-x} = \frac{W_p}{3} + \frac{W_{plgr}}{4} \quad (\text{Zone } \geq 3)$$

$$F_{x-x} = \frac{W_p}{6} + \frac{W_{plgr}}{8} \quad (\text{Zone } 2)$$

$$F_{x-x} = \frac{2F_p}{3} + \frac{F_{plgr}}{2} \quad (\text{IBC/NBCC Jurisdictions})$$

(b) Where $L < \ell$ (see Table 8.4.8.7):

$$F_{x-x} = \left(\frac{W_p}{2} \right) \left(1 - \frac{L}{3\ell} \right) + \frac{W_{plgr}}{4} \quad (\text{Zone } \geq 3)$$

$$F_{x-x} = \left(\frac{W_p}{4} \right) \left(1 - \frac{L}{3\ell} \right) + \frac{W_{plgr}}{8} \quad (\text{Zone } 2)$$

$$F_{x-x} = F_p \left(1 - \frac{L}{3\ell} \right) + \frac{F_{plgr}}{2} \quad (\text{IBC/NBCC Jurisdictions})$$

8.4.11.15.2 Force normal to (y - y) axis of the guide rail (see 8.4.8.9): (13)

(a) Where $L \geq \ell$ (see Table 8.4.8.7):

$$F_{y-y} = \frac{W_p}{6} + \frac{W_{plgr}}{8} \quad (\text{Zone } \geq 3)$$

$$F_{y-y} = \frac{W_p}{12} + \frac{W_{plgr}}{16} \quad (\text{Zone } 2)$$

$$F_{y-y} = \frac{2F_p}{3} + \frac{F_{plgr}}{4} \quad (\text{IBC/NBCC Jurisdictions})$$

(b) Where $L < \ell$ (see Table 8.4.8.7):

$$F_{y-y} = \left[\left(\frac{W_p}{4} \right) \left(1 - \frac{L}{3\ell} \right) + \frac{W_{plgr}}{8} \right] \quad (\text{Zone } \geq 3)$$

$$F_{y-y} = \left[\left(\frac{W_p}{8} \right) \left(1 - \frac{L}{3\ell} \right) + \frac{W_{plgr}}{16} \right] \quad (\text{Zone } 2)$$

$$F_{y-y} = \left[\left(\frac{F_p}{2} \right) \left(1 - \frac{L}{3\ell} \right) + \frac{F_{plgr}}{4} \right] \quad (\text{IBC/NBCC Jurisdictions})$$

where

F_{x-x} , F_{y-y} = seismic force, N (lbf)

F_p = seismic component force as defined by 8.4.14

F_{plgr} = seismic component force as defined by 8.4.14 substituting W_{plgr} for W_p

(1) For car and counterweight lower position restraints:

- W_p = total weight of car plus 40% of rated capacity, or the total weight of the counterweight, N (lb)
- W_{plgr} = plunger weight, N (lb) (for direct-acting hydraulic elevators), or
- = 0 (for elevators provided with counterweights and roped-hydraulic elevators), based on the in-ground hydraulics. For other designs, the load distribution might be different.

(2) For traveling sheave position restraints where guided on rails separate from car:

- W_p = 1.5 × (weight of traveling sheave plus guide attachments), N (lb)
- W_{plgr} = plunger weight, N (lb) (for roped-hydraulic elevators)

8.4.12 Design Data and Formulas for Elevators

8.4.12.1 Maximum Weight Per Pair of Guide Rails.

The following formulas shall be used to determine the maximum allowable weight per pair of guide rails.

(13) 8.4.12.1.1 Force Normal to (x-x) Axis of Rail (See 8.4.8.9)

(a) No intermediate tie brackets (car and counterweight rails):

(1) Traction elevators, roped-hydraulic elevators, or hydraulic elevator counterweight rails (where provided)

(SI Units)

$$W_p = 4\,948.2 \frac{Z_x}{\ell} \quad (\text{Zone } \geq 3)$$

$$W_p = 9\,896.4 \frac{Z_x}{\ell} \quad (\text{Zone } 2)$$

$$2.93[0.7]F_p = 4\,948.2 \frac{Z_x}{\ell} \quad (\text{IBC/NBCC Jurisdictions})$$

(Imperial Units)

$$W_p = 717,671 \frac{Z_x}{\ell} \quad (\text{Zone } \geq 3)$$

$$W_p = 1,435,342 \frac{Z_x}{\ell} \quad (\text{Zone } 2)$$

$$2.93[0.7]F_p = 717,671 \frac{Z_x}{\ell} \quad (\text{IBC/NBCC Jurisdictions})$$

(2) Direct-acting hydraulic elevators (car guide rails only) or separately guided traveling sheaves

(SI Units)

$$W_p' = 1\,649.4 \frac{Z_x}{\ell} \quad (\text{Seismic Zone Jurisdictions})$$

$$2.93[0.7]F_p' = 1\,649.4 \frac{Z_x}{\ell} \quad (\text{IBC/NBCC Jurisdictions})$$

(Imperial Units)

$$W_p' = 239,224 \frac{Z_x}{\ell} \quad (\text{Seismic Zone Jurisdictions})$$

$$2.93[0.7]F_p' = (239,224) \frac{Z_x}{\ell} \quad (\text{IBC/NBCC Jurisdictions})$$

where

$$W_p' = \frac{W_p}{3} + \frac{W_{plgr}}{4} \quad (\text{Zone } \geq 3)$$

$$W_p' = \frac{W_p}{6} + \frac{W_{plgr}}{8} \quad (\text{Zone } 2)$$

$$F_p' = \left(\frac{2F_p}{3}\right) + \frac{F_{plgr}}{2} \quad (\text{IBC/NBCC Jurisdictions})$$

(b) One intermediate tie bracket located midway between main counterweighted guide-rail brackets:

(SI Units)

$$W_p = 6\,563.8 \frac{Z_x}{\ell} \quad (\text{Zone } \geq 3)$$

$$W_p = 13\,127.5 \frac{Z_x}{\ell} \quad (\text{Zone } 2)$$

$$2.93[0.7]F_p = 6\,563.8 \frac{Z_x}{\ell} \quad (\text{IBC/NBCC Jurisdictions})$$

(Imperial Units)

$$W_p = 951,991 \frac{Z_x}{\ell} \quad (\text{Zone } \geq 3)$$

$$W_p = 1,903,982 \frac{Z_x}{\ell} \quad (\text{Zone } 2)$$

$$2.93[0.7]F_p = 951,991 \frac{Z_x}{\ell} \quad (\text{IBC/NBCC Jurisdictions})$$

(c) Two intermediate tie brackets approximately equally spaced between main counterweighted guide-rail brackets:

(SI Units)

$$W_p = 7\,263.6 \frac{Z_x}{\ell} \quad (\text{Zone } \geq 3)$$

$$W_p = 14\,527.2 \frac{Z_x}{\ell} \quad (\text{Zone } 2)$$

$$2.93[0.7]F_p = 7\,263.6 \frac{Z_x}{\ell} \quad (\text{IBC/NBCC Jurisdictions})$$

(Imperial Units)

$$W_p = 1,053,495 \frac{Z_x}{\ell} \quad (\text{Zone } \geq 3)$$

$$W_p = 2,106,990 \frac{Z_x}{\ell} \quad (\text{Zone } 2)$$

$$2.93[0.7]F_p = 1,053,495 \frac{Z_p}{\ell}$$

(IBC/NBCC Jurisdictions)

where

$$W_p' = \frac{W}{3} + \frac{W_{plgr}}{4} \quad (\text{Zone } \geq 3)$$

$$W_p' = \frac{W}{6} + \frac{W_{plgr}}{8} \quad (\text{Zone } 2)$$

$$F_p' = \left(\frac{2F_p}{3}\right) + \frac{F_{plgr}}{2}$$

(IBC/NBCC Jurisdictions)

(13) 8.4.12.1.2 Force Normal to (y-y) Axis of Rail (See 8.4.8.9)

(a) No intermediate tie brackets (car and counterweight rails):

(1) Traction elevators, roped-hydraulic elevators, or hydraulic elevator counterweight rails (where provided):

(SI Units)

$$W_p = 9\,896.4 \frac{Z_y}{\ell} \quad (\text{Zone } \geq 3)$$

$$W_p = 19\,792.8 \frac{Z_y}{\ell} \quad (\text{Zone } 2)$$

$$2.93[0.7]F_p = 9\,896.4 \frac{Z_y}{\ell}$$

(IBC/NBCC Jurisdictions)

(Imperial Units)

$$W_p = 1,435,342 \frac{Z_y}{\ell} \quad (\text{Zone } \geq 3)$$

$$W_p = 2,870,684 \frac{Z_y}{\ell} \quad (\text{Zone } 2)$$

$$2.93[0.7]F_p = 1,435,342 \frac{Z_y}{\ell}$$

(IBC/NBCC Jurisdictions)

(2) Direct-acting hydraulic elevators (car guide rails only) or separately guided traveling sheaves:

(SI Units)

$$W_p' = 3\,298.8 \frac{Z_y}{\ell}$$

(Seismic Zone Jurisdictions)

$$2.93[0.7]F_p = 3\,298.8 \frac{Z_y}{\ell}$$

(IBC/NBCC Jurisdictions)

(Imperial Units)

$$W_p' = 478,448 \frac{Z_y}{\ell}$$

$$2.93[0.7]F_p = 478,488 \frac{Z_y}{\ell}$$

(IBC/NBCC Jurisdictions)

(b) One intermediate tie bracket located midway between main counterweighted guide-rail brackets

(SI Units)

$$W_p = 13\,127.5 \frac{Z_y}{\ell} \quad (\text{Zone } \geq 3)$$

$$W_p = 26\,255.1 \frac{Z_y}{\ell} \quad (\text{Zone } 2)$$

$$2.93[0.7]F_p = 13\,127.5 \frac{Z_y}{\ell}$$

(IBC/NBCC Jurisdictions)

(Imperial Units)

$$W_p = 1,903,982 \frac{Z_y}{\ell} \quad (\text{Zone } \geq 3)$$

$$W_p = 3,807,962 \frac{Z_y}{\ell} \quad (\text{Zone } 2)$$

$$2.93[0.7]F_p = 1,903,982 \frac{Z_y}{\ell}$$

(IBC/NBCC Jurisdictions)

(c) Two intermediate tie brackets approximately equally spaced between main counterweighted guide-rail brackets

(SI Units)

$$W_p = 14\,527.2 \frac{Z_y}{\ell} \quad (\text{Zone } \geq 3)$$

$$W_p = 29\,054.4 \frac{Z_y}{\ell} \quad (\text{Zone } 2)$$

$$2.93[0.7]F_p = 14\,527.2 \frac{Z_y}{\ell}$$

(IBC/NBCC Jurisdictions)

(Imperial Units)

$$W_p = 2,106,990 \frac{Z_y}{\ell} \quad (\text{Zone } \geq 3)$$

$$W_p = 4,213,963 \frac{Z_y}{\ell} \quad (\text{Zone } 2)$$

$$2.93[0.7]F_p = 2,106,990 \frac{Z_y}{\ell}$$

(IBC/NBCC Jurisdictions)

where

ℓ = distance between main car or counterweight guide-rail brackets, mm (in.)

- W_p = component operating weight as defined by 8.4.15
- W_p' = maximum weight per pair of guide rails (hydraulic direct-acting elevators and separately guided traveling sheaves), N (lb)
- W_{plgr} = weight of hydraulic plunger, N (lb)
- Z_x = elastic section modulus of rail about (x - x) axis, mm^3 (in.^3)
- Z_y = elastic section modulus of rail about (y - y) axis, mm^3 (in.^3)

8.4.12.2 Required Moment of Inertia of Guide Rails.

The following formulas shall be used to determine the minimum allowable moment of inertia of guide rails.

(13) **8.4.12.2.1 Force Normal to (x - x) Axis of Rail (See 8.4.8.9)**

(a) Traction elevators, roped-hydraulic elevators, or hydraulic elevator counterweight rails (where provided)

$$I_x = \left(\frac{W_p \ell^3}{249 \Delta E} \right) \quad (\text{Zone } \geq 3)$$

$$I_x = \left(\frac{W_p \ell^3}{498 \Delta E} \right) \quad (\text{Zone } 2)$$

$$I_x = \left(\frac{2F_p \ell^3}{249 \Delta E} \right) \quad (\text{IBC/NBCC Jurisdictions})$$

(b) Direct-acting hydraulic elevators (car guide rails only) or separately guided traveling sheaves

$$I_x = \left[\frac{\ell^3}{\Delta E} \left(\frac{W_p}{249} + \frac{W_{plgr}}{267} \right) \right] \quad (\text{Zone } \geq 3)$$

$$I_x = \left[\frac{\ell^3}{\Delta E} \left(\frac{W_p}{498} + \frac{W_{plgr}}{534} \right) \right] \quad (\text{Zone } 2)$$

$$I_x = \left[\frac{\ell^3}{\Delta E} \left(\frac{2F_p}{249} + \frac{2F_{plgr}}{267} \right) \right] \quad (\text{IBC/NBCC Jurisdictions})$$

(13) **8.4.12.2.2 Force Normal to (y - y) Axis of Rail (See 8.4.8.9)**

(a) Traction elevators, roped-hydraulic elevators, or hydraulic elevator counterweight rails (where provided)

$$I_y = \left(\frac{W_p \ell^3}{498 \Delta E} \right) \quad (\text{Zone } \geq 3)$$

$$I_y = \left(\frac{W_p \ell^3}{996 \Delta E} \right) \quad (\text{Zone } 2)$$

$$I_y = \left(\frac{2F_p \ell^3}{498 \Delta E} \right) \quad (\text{IBC/NBCC Jurisdictions})$$

(b) Direct-acting hydraulic elevators (car guide rails only) or separately guided traveling sheaves

$$I_x = \left[\frac{\ell^3}{\Delta E} \left(\frac{W_p}{498} + \frac{W_{plgr}}{534} \right) \right] \quad (\text{Zone } \geq 3)$$

$$I_x = \left[\frac{\ell^3}{\Delta E} \left(\frac{W_p}{996} + \frac{W_{plgr}}{1,068} \right) \right] \quad (\text{Zone } 2)$$

Table 8.4.12.2.2 Maximum Allowable Deflection

| Rail Size, kg (lb) | Δ , Max., mm (in.) |
|--------------------|---------------------------|
| 12.0 (8.0) | 20 (0.75) |
| 16.5 (11.0) | 25 (1.00) |
| 18.0 (12.0) | 32 (1.25) |
| 22.5 (15.0) | 38 (1.50) |
| 27.5 (18.5) | 38 (1.50) |
| 33.5 (22.5) | 38 (1.50) |
| 45.0 (30.0) | 45 (1.75) |

$$I_x = \left[\frac{\ell^3}{\Delta E} \left(\frac{2F_p}{498} + \frac{F_{plgr}}{267} \right) \right] \quad (\text{IBC/NBCC Jurisdictions})$$

where

- ℓ = distance between main car and counterweight guide-rail brackets, mm (in.)
- E = modulus of elasticity for steel = 2.068 × 10⁵ MPa (30 × 10⁶ psi)
- I_x = moment of inertia of rail about (x - x) axis, mm^4 (in.^4)
- I_y = moment of inertia of rail about (y - y) axis, mm^4 (in.^4)
- W_p = component operating weight as defined by 8.4.15
- W_{plgr} = weight of hydraulic plunger, kg (lb)
- Δ = maximum allowable deflection at center of rail span, mm (in.), based on Table 8.4.12.2.2.

8.4.13 Component Force Levels Based on Ground Motion Parameters (13)

For 8.4(b)(2), the component force level shall be the greater of that dictated by either of the following:

- (a) the applicable building code's non-structural component requirements
- (b) the appropriate seismic zone as determined in 8.4.13.1 or 8.4.13.2

When the applicable building code does not reference component vertical force levels, the appropriate seismic zone vertical force level shall be used when a vertical force level is specified.

8.4.13.1 In United States jurisdictions with building codes not referencing seismic zones and prior to IBC (13)

| Zone(s) | Affected Peak Velocity Acceleration, A_v |
|---------|--|
| 0 and 1 | $A_v < 0.10$ |
| 2 | $0.10 \leq A_v < 0.20$ |
| 3 and 4 | $0.20 \leq A_v$ |

- (13) **8.4.13.2** In Canadian jurisdictions enforcing building codes prior to NBCC-2005, the following values of Z_v (velocity-related seismic zone) will determine the applicable seismic zone:

| Zone(s) | Velocity-Related Seismic Zone, Z_v |
|----------|--------------------------------------|
| 2 | $2 \leq Z_v < 4$ |
| ≥ 3 | $Z_v \geq 4$ |

NOTE: For Z_v values, see "Design Data for Selected Locations in Canada," in NBCC-1995, Appendix C.

(13) **8.4.14 Elevator Seismic Design Force**

8.4.14.1 Component Seismic Force Level (Strength Design). The seismic force shall be computed per requirements of IBC/ASCE 7, or NBCC-2005 or later editions, in accordance with the applicable building code.

(a) For IBC/ASCE 7

F_p = Component Seismic Force Level (horizontal, Strength Design Level) =

$$\frac{0.4 a_p S_{DS}}{\left(\frac{R_p}{I_p}\right)} \left[1 + 2 \left(\frac{z}{h} \right) \right] W_p$$

F_p is not required to be taken as greater than

$$F = 1.6 S_{DS} I_p W_p$$

and F_p shall not be taken as less than

$$F_p = 0.3 S_{DS} I_p W_p$$

where

F_p = Component Seismic Force Level (horizontal, Strength Design Level)

S_{DS} = 5% damped design spectral response acceleration for short periods (i.e., 0.2 s)

a_p = component amplification factor = 1.00

I_p = component importance factor = 1.00 or 1.50

W_p = component operating weight as defined in 8.4.15

R_p = component response modification factor = 2.5

z = height in structure of point of attachment of component with respect to the defined building base provided by the building structural engineer. For items at or below the base, z shall be taken as 0. The value of z/h need not exceed 1.0. (See Definitions, Section 1.3 for base, building and Guide for Elevator Seismic Design, Part 1)

h = average roof height of structure with respect to the defined building base, provided by the building structural engineer

NOTES:

- (1) For isolated components refer to ASCE 7-10, Table 13.6-1.

- (2) F_p shall be multiplied by a factor of 0.7 for stress calculations in order to convert from Strength Design (IBC/ASCE 7) to Allowable Stress Design (ASME A17.1). This factor is already included in the load combinations 8.4.14.1.3.

(b) For NBCC-2005 or later editions

F_p = Component Seismic Force Level (horizontal, Strength Design Level) = $0.3 F_a S_a(0.2) I_E S_p W_p$

where:

F_p = Component Seismic Force Level (horizontal, Strength Design Level)

F_a = Acceleration-based site coefficient, defined in NBCC-2010, Table 4.1.8.4.B, based on $S_a(0.2)$ and Site Class, A through F

$S_a(0.2)$ = 5% damped spectral response acceleration value, expressed as a ratio to gravitational acceleration, for a period of 0.2 s, defined in NBCC-2010, sentence 4.1.8.4(1)

I_E = Importance factor for the building, defined in NBCC-2010, Article 4.1.8.5

S_p = $C_p A_r A_x / R_p$ (where S_p may range between 0.7 and 4.0) with

C_p = component factor as listed in NBCC-2010, Table 4.1.8.18

A_r = component force amplification factor from NBCC-2010, Table 4.1.8.18

A_x = height factor $(1 + 2 h_x/h_n)$ with

h_x = height in structure of point of attachment of component with respect to the defined building base provided by the building structural engineer. For items at or below the base, z shall be taken as 0. (See Definitions, Section 1.3 for base, building and Guide for Elevator Seismic Design, Part 1)

h_n = average roof height of structure with respect to the defined building base, provided by the building structural engineer. The value of h_x/h_n need not exceed 1.0.

R_p = component response modification factor from NBCC-2010, Table 4.1.8.18

W_p = component operating weight as defined by 8.4.15

NOTES:

- (1) For isolated components, refer to NBCC-2010, Table 4.1.8.18.
- (2) F_p shall be multiplied by a factor of 0.7 for stress calculations in order to convert from Strength Design (NBCC-2010) to Allowable Stress Design (ASME A17.1). This factor is already included in the load combinations 8.4.14.1.3.
- (3) Elevator equipment subject only to inertial accelerations of its own mass are considered rigid components when referencing NBCC-2010, Table 4.1.8.18 for variables C_p , A_r , and R_p . Elevator equipment subjected to accelerations and decelerations and

subject to external forces independent of the mass of the component itself are considered machinery.

8.4.14.1.1 Components and Vertical Load Bearing Guide Rails. The seismic design force, F_p , shall be applied at the component's center of gravity. In addition, the component shall be designed for concurrent vertical seismic force F_v equal to

$$(a) \pm 0.2 S_{DS} W_p \quad (\text{for IBC/ASCE 7})$$

$$(b) \pm 0.2 \left[\frac{2}{3} F_a S_a(0.2) \right] W_p \quad (\text{for NBCC})$$

NOTES:

- (1) Guide rail mounted machinery would be an example of vertical loads imposed on the guide rail in addition to the horizontal inertial loads (see 8.4.8.2.6 and 8.4.14.1.1).
- (2) F_v shall be multiplied by a factor of 0.7 for stress calculations in order to convert from Strength Design (NBCC-2010) to Allowable Stress Design (ASME A17.1). This factor is already included in the load combinations 8.4.14.1.3.

8.4.14.1.2 Load Combinations Using Allowable Stress Design. Components and portions thereof shall resist the most critical effects resulting from the following combinations of loads:

For IBC/ASCE 7/NBCC

$$(a) (D + 0.7E), \text{ or}$$

$$(b) (0.6D + 0.7E)$$

whichever is more stringent

where

D = dead load

E = earthquake load = $F_p + F_v$

8.4.14.1.3 Stress Increases. Increases in allowable stresses shall not be used.

(13) 8.4.15 Component Operating Weight (W_p)

The component operating weight, W_p , shall be one of the following:

(a) for support or restraint of specific components, the component operating weight [N (lb)] will be used (i.e., counterweight, controller, etc.)

(b) For support or restraint of an elevator, the component operating weight [N (lb)] will include car weight plus 40% capacity (i.e., guide rails)

8.4.16 Machine Rooms and Machinery Spaces

Where all electric elevator equipment cannot be located on one side of an expansion joint, the maximum displacement across the expansion joint as provided by the building design shall not impair the function of the elevator.

SECTION 8.5 ESCALATOR AND MOVING WALK SAFETY REQUIREMENT FOR SEISMIC RISK ZONE 2 OR GREATER

Requirement 8.5 applies to all escalators and moving walks, where installed in buildings that are designed and built to the requirements of, and located in, seismic

risk zone 2 or greater as defined by the building code (see 1.3).

Where the applicable building code does not make reference to seismic risk zones, the ground motion parameters shown in 8.4.13 shall be used.

The escalator and moving walk safety requirements contained in 8.5 shall be in addition to the requirements in the other parts of the Code unless otherwise specified.

8.5.1 Balustrade Construction

Balustrades shall be designed to resist a lateral load of 730 N/m (50 lbf/ft) applied to the top of the handrail. In balustrades where glass is part of the structural system the design shall include provision for the application of 0.5 gravity in both principle directions and the required lateral load to verify that the glass does not exceed the material deflection limit or stress limit.

8.5.2 Truss Members

All members of escalators and moving walk trusses together with their supports shall be capable of withstanding the inertia effect of their masses without permanent deformation when subjected to seismic forces active separately in vertical and horizontal directions.

8.5.2.1 Lateral forces shall be applied in horizontal directions that result in the most critical loadings as calculated in conformance with the AISC Specifications for Design, Fabrication and Erection of Structural Steel for Buildings. The most critical loading shall be based on the total dead load of the escalator including cladding plus 25% of the rated load in accordance with 6.1.3.9. The horizontal seismic force shall be considered to be not less than:

$$F_p = ZIC_p(W_p + W_r)$$

where

C_p = horizontal force factor

F_p = total horizontal force

I = importance factor

W_p = dead load including cladding

W_r = 25% of the rated load calculated per 6.1.3.9

Z = seismic zone factor

8.5.2.1.1 The seismic zone shall be taken from the NHRP maps.

NOTE: When local building codes are more stringent, higher values may be applicable:

(a) For zone 2, $Z = 0.25$.

(b) For zone 3 or 4, $Z = 0.5$.

Where the applicable building code does not make reference to seismic risk zones, the ground motion parameters shown in 8.4.13 shall be used.

8.5.2.1.2 The escalator or moving walk is considered a nonbuilding structure component. The value of I shall be considered to be 1.0 unless the building is

specified as an essential facility in which case a value of 1.25 shall be used.

8.5.2.1.3 The value of C_p shall be 0.75 when any portion of an escalator is located above grade and 0.50 when an escalator is located below grade.

NOTE: When more than six stories above grade other values of C_p may apply and should be determined based upon the fundamental period of the building.

8.5.2.2 Vertical forces shall be split equally between the two end supports. The total vertical force shall be $(1 \pm 0.25) \times (W_p + W_r)$ for zone 2 and $(1 \pm 0.50) \times (W_p + W_r)$ for zone 3 or greater. W_p and W_r are defined in 8.5.2.1.

8.5.2.3 Truss Calculations. The members in the truss shall be calculated by the Allowable Stress Method of the AISC Specification for Design, Fabrication, and Erection of Structural Steel for Buildings. The allowable stress as stipulated by the various sections is required to be used in lieu of yield stress. (See AISC example D1 for tension, E2 for compression, and F4 for shear stress. There are multiple rules for bending depending on type of section; therefore, examples are not listed.) Truss analysis, whether verified by computer or hand calculations, shall consider axial stresses of either compression or tension, combined axial compressive and bending stress, and combined axial tension and bending stress. There is no requirement for the escalator truss to be considered as a structural member of the building.

8.5.3 Supporting Connections Between the Truss and the Building

8.5.3.1 The end supports shall provide lateral restraint for forces in both principle horizontal directions imposed by seismic forces on the truss. Vertical restraint is not required since per formula downward force will be $0.50 (W_p + W_r)$ or greater (see 8.5.2.1). Calculations shall be permitted to be based on either rigid or flexible restraints. Where suitable flexible restraints are used, forces resulting from movement of building structure members are not considered as being applied to the truss.

8.5.3.2 The design connections shall account for maximum design story drift.

8.5.3.2.1 Where seismic restraint is provided at one end, the design shall account for the forces developed by building movement in a manner that restricts transfer of these forces to the truss. All other supports shall be free to slide in the longitudinal direction. Where seismic restraint, that allows some degree of longitudinal and transverse motion, is provided at both ends, additional means shall be provided to prevent the upper end of the truss from slipping off the building support. All other supports shall be free to slide in the longitudinal

direction sufficiently to accommodate the remainder of the design story drift.

8.5.3.2.2 At the sliding end or ends, the width or widths of the beam seat shall be capable of accommodating, without damage, at least 1.5 times story drift as obtained by either of the following:

(a) through engineering calculations

(b) by using the maximum code allowed story drift per the FEMA 450 Table 4.5-1 for Allowable Story Drifts.

NOTE (8.5.3.2.2): This table allows story drifts of $0.025 h_{sx}$ where h_{sx} is the building story height.

8.5.4 Earthquake Protective Devices

Earthquake protective devices shall be of the fail-safe type.

A minimum of one seismic switch shall be provided in every building in which an escalator or moving walk is installed.

(a) The seismic switch shall conform to 8.4.10.1.2(b).

(b) Activation of the seismic switch(es) shall remove power from the escalator driving machine motor and brake.

(c) Where a seismic switch(es) is used exclusively to control the escalator or moving walk, it shall be located in a machine room, machinery space, and where possible shall be mounted adjacent to a vertical load-bearing member. Should no vertical load-bearing member be in close proximity, it shall be permitted to locate the seismic switch at the nearest accessible vertical load-bearing member at approximately the same horizontal level as the upper machinery space or machine room.

SECTION 8.6 MAINTENANCE, REPAIR, REPLACEMENT, AND TESTING

(13)

Requirement 8.6 applies to maintenance, repairs, replacements, and testing. Maintenance, repair, and replacement shall be performed to provide compliance with the Code applicable at the time of installation or alteration.

NOTES:

(1) See 8.7 for alteration requirements.

(2) See "General" in Preface for assignment of responsibilities.

8.6.1 General Requirements

8.6.1.1 Maintenance, Repair, and Replacement

8.6.1.1.1 Equipment covered within the scope of this Code shall be maintained in accordance with 8.6.

8.6.1.1.2 Maintenance, repairs, replacements, and tests shall conform to 8.6 and the applicable

(a) Code at the time of the installation; and

(b) Code requirements at the time of any alteration; and

(c) ASME A17.3 if adopted by the authority having jurisdiction

- (13) **8.6.1.1.3** It is not the intent of 8.6 to require changes to the equipment to meet the design, equipment nameplate(s), or performance standard other than those specified in 8.6.1.1.2, unless specifically stated in 8.6 (see 8.6.3.2, 8.6.5.8, 8.6.8.3 and 8.6.8.4.3).

8.6.1.2 General Maintenance Requirements

- (13) **8.6.1.2.1** A written Maintenance Control Program shall be in place to maintain the equipment in compliance with the requirements of 8.6. The MCP shall specify examinations, tests, cleaning, lubrication, and adjustments to applicable components at regular intervals (see definition for *maintenance*) and shall comply with the following.

(a) "A Maintenance Control Program for each unit (see 8.6.1.1.1) shall be provided by the person(s) and/or firm maintaining the equipment and shall be viewable on-site by elevator personnel at all times from time of acceptance inspection and test or from the time of equipment installation or alteration (see 8.10.1.5)."

(b) The MCP shall include, but not be limited to, the Code required maintenance tasks, maintenance procedures, and examination and tests listed with the associated requirement (see 8.6.4 through 8.6.11). Where maintenance tasks, maintenance procedures, or examinations or tests have been revised in 8.6, the MCP shall be updated.

(c) The MCP shall reference On-Site Equipment Documentation (see 8.6.1.2.2) needed to fulfill 8.6.1.2.1(b) and On-Site Maintenance Records (see 8.6.1.4.1) that record the completion of all associated maintenance tasks specified in 8.6.1.4.1(a).

(d) Where the MCP is maintained remotely from the machine room, machinery space, control room, or control space (see 8.11.1.8), instructions for on-site locating or viewing the MCP either in hard copy or in electronic format shall be posted on the controller or at the means necessary for test (see 2.7.6.4). The instructions shall be permanently legible with characters a minimum of 3 mm (0.125 in.) in height.

(e) The specified scheduled maintenance intervals (see 1.3) shall, as applicable, be based on

- (1) equipment age, condition, and accumulated wear
- (2) design and inherent quality of the equipment
- (3) usage
- (4) environmental conditions
- (5) improved technology
- (6) the manufacturer's recommendations and original equipment certification for any SIL rated devices or circuits (see 8.6.3.12 and 8.7.1.9)
- (7) the manufacturer's recommendations based on any ASME A17.7/CSA B44.7 approved components or functions

(f) Procedures for tests; periodic inspections; maintenance; replacements; adjustments; and repairs for traction-loss detection means, broken-suspension-member detection means, residual-strength detection means, and related circuits shall be incorporated into and made part of the Maintenance Control Program. [See 2.20.8.1, 2.20.8.2, 2.20.8.3, 8.6.11.10, 8.10.2.2.2(cc)(3)(c)(2), 8.10.2.2.2(ss), and 8.6.4.19.12.]

8.6.1.2.2 On-Site Documentation. The following documents specified in 8.6.1.2.2(a), (b), and (c) shall be written and permanently kept on-site in the machine room, machinery space, control room, control space, or in the means necessary for test (2.7.6.4) in hard copy for each unit for elevator personnel. (13)

The documentation specified in 8.6.1.2.2(d) shall be on-site and available to the specified personnel.

(a) Up-to-date wiring diagrams detailing circuits of all electrical protective devices (see 2.26.2) and critical operating circuits (see 2.26.3).

(b) Procedures for inspections and tests not described in ASME A17.2 and procedures or methods required for elevator personnel to perform maintenance, repairs, replacements, and adjustments, as follows:

(1) all procedures specifically identified in the Code as required to be written (e.g., 8.6.4.20.8, check out procedure for leveling; 8.6.5.16.5, check out procedure for overspeed valve; and 8.6.8.15.7, check out procedure for reversal stop switch, etc.)

(2) unique maintenance procedures or methods required for inspection, tests, and replacement of SIL rated E/E/PES electrical protective devices and circuits. See 2.26.4.3.2, 2.26.9.3.2(b), 2.26.9.5.1(b), and 2.26.9.6.1(b)

(3) unique maintenance procedures or methods required for inspection, tests, and replacement of equipment applied under alternative arrangements (see 1.2.2.1) shall be provided by the manufacturer or installer

(4) unique maintenance procedures or unique methods required for inspection and test of equipment specified in an ASME A17.7/CSA B44.7, Code Compliance Document (CCD)

(c) Written checkout procedures

(1) to demonstrate E/E/PES function as intended (see 8.6.4.19.10)

(2) for elevator leveling speed with open doors (see 8.6.4.20.8)

(3) for hydraulic elevator overspeed valve (see 8.6.5.16.5)

(4) for escalator reversal stopping device (see 8.6.8.15.7)

(5) for escalator handrail retarding force (see 8.6.8.15.13)

(d) Written procedures for the following:

(1) evacuation procedures for elevators by authorized persons and emergency personnel shall be available on-site (see 8.6.11.5.2 and ASME A17.4)

(2) the procedure for cleaning of a car and hoistway transparent enclosures by authorized persons (see 8.6.11.4.2)

8.6.1.3 Maintenance Personnel. Maintenance, repairs, replacements, and tests shall be performed only by elevator personnel (see 1.3).

- (13) **8.6.1.4 Maintenance Records.** Maintenance records shall document compliance with 8.6. Instructions for locating the maintenance records of each unit, for viewing on-site, shall be posted on the controller or at the means necessary for test (see 2.7.6.4). The provided instructions shall be permanently legible with characters a minimum of 3 mm (0.125 in.) in height. These records shall be retained for the most recent 5 yr or from the date of installation or adoption of this Code edition, whichever is less or as specified by the authority having jurisdiction. Existing maintenance records up to 5 yr shall be retained.

8.6.1.4.1 On-Site Maintenance Records

(a) *Maintenance Control Program Records*

(1) A record that shall include the maintenance tasks listed with the associated requirements of 8.6 identified in the Maintenance Control Program (8.6.1.2.1), other tests (see 8.6.1.2.2), examinations and adjustments, and the specified scheduled intervals shall be maintained.

(2) The specified scheduled maintenance intervals (see 1.3) shall, as applicable, be based on the criteria given in 8.6.1.2.1(e).

(3) MCP records shall be viewable on-site by elevator personnel in either hard copy or electronic format acceptable to the authority having jurisdiction and shall include but not limited to the following:

- (a) site name and address
- (b) service provider name
- (c) conveyance identification (I.D.) and type
- (d) date of record
- (e) a description of the maintenance task, interval, and associated requirements of 8.6

(f) indication of completion of maintenance task

NOTE [8.6.1.4.1(a)]: Recommended format for documenting Maintenance Control Program records can be found in Nonmandatory Appendix Y. This is only an example format. A specific maintenance control program that includes all maintenance needs is required for each unit.

(b) *Repair and Replacement Records.* The following repairs and replacements shall be recorded and shall be kept on-site for viewing by elevator personnel in either hard copy or electronic format. Instructions for locating the records of each unit for immediate viewing shall be posted on the controller or at the means necessary for test (see 2.7.6.4). The provided instructions shall be permanently legible with characters a minimum of 3 mm (0.125 in.) in height. The record shall include an explanation of the repair or replacement, date, and name of

person(s) and/or firm performing the task. The record of repairs and replacements shall be retained by the owner of the equipment for the most recent 5 yr or from the date of installation or adoption of this Code edition, whichever is less or as specified by the authority having jurisdiction and shall be a permanent record for the installation. These records may be kept remotely from the site.

(1) Repairs (8.6.2.1 through 8.6.2.5) including repairs of components and devices listed in 8.6.4, 8.6.5, 8.6.6, 8.6.7, 8.6.8, 8.6.9, and 8.6.10.

(2) Replacements (8.6.3.1 through 8.6.3.11 except 8.6.3.7 and 8.6.3.10) including replacements of components and devices listed in 8.6.4, 8.6.5, 8.6.6, 8.6.7, 8.6.8, 8.6.9, and 8.6.10.

(c) *Other Records.* The following written records shall be kept on-site for each unit. Instructions for locating the records of each unit for immediate viewing shall be posted on the controller or at the means necessary for test (see 2.7.6.4). The provided instructions shall be permanently legible with characters a minimum of 3 mm (0.125 in.) in height. These records shall be retained for the most recent 5 yr from of the date of installation or adoption of this Code edition, whichever is less or as specified by the authority having jurisdiction. The record shall include the date and name of person(s) and/or firm performing the task.

(1) A record of oil usage (8.6.5.7).

(2) A record of findings for firefighters' service operation required by 8.6.11.1 with identification of the person(s) that performed the operation.

(3) Periodic tests (see 8.6.1.7) shall be documented or recorded in accordance with 8.6.1.7.2.

(4) Written record to document compliance with replacement criteria specified in ASME A17.6 requirement 1.10.1.1(c).

(d) *Permanent Record.* A permanent record of the results of all acceptance tests as required by 8.10.1.1.4 and 8.10.1.1.5 shall be kept with the on-site records.

Test tags, complying with 2.16.3.3 for marking plates (except lettering shall be 1.6 mm [0.0625 in.]), permanently attached to or adjacent to the controller, shall meet this requirement.

NOTE: This requirement does not apply to equipment installed under ASME A17.1-2010 and earlier editions.

8.6.1.4.2 Call Backs (Trouble Calls). A record of call backs shall be maintained and shall include the description of reported trouble, dates, time, and corrective action(s) taken that are reported by any means to elevator personnel. These records shall be made available to elevator personnel when performing corrective action. For elevator personnel other than personnel performing the corrective action, records will be available upon request. Instructions on how to report any need for corrective action (trouble calls) to the responsible party shall be posted on the controller or at the means

necessary for test (see 2.7.6.4). The instructions shall be permanently legible with characters a minimum of 3 mm (0.125 in.) in height.

8.6.1.5 Code Data Plate

8.6.1.5.1 The Code data plate shall comply with 8.9.

8.6.1.6 General Maintenance Methods and Procedures

8.6.1.6.1 Making Safety Devices Inoperative or Ineffective. No person shall at any time make inoperative or ineffective any device on which safety of users is dependent, including any electrical protective device, except where necessary during tests, inspections (see 8.10 and 8.11), maintenance, repair, and replacement, provided that the installation is first removed from normal operation.

Such devices shall be restored to their normal operating condition in conformity with the applicable requirements prior to returning the equipment to service (see 2.26.7 and 8.6.1.6).

8.6.1.6.2 Lubrication. All parts of the machinery and equipment requiring lubrication shall be lubricated with lubricants equivalent to the type and grade recommended by the manufacturer.

Alternative lubricants shall be permitted when intended lubrication effects are achieved.

All excess lubricant shall be cleaned from the equipment. Containers used to catch leakage shall not be allowed to overflow.

(13) 8.6.1.6.3 Controllers and Wiring

(a) The interiors of controllers and their components shall be cleaned when necessary to minimize the accumulation of foreign matter that can interfere with the operation of the equipment.

(b) Temporary wiring and insulators or blocks in the armatures or poles of magnetically operated switches, contactors, or relays on equipment in service are prohibited.

(c) When jumpers are used during maintenance, repairs, or testing, all jumpers shall be removed and the equipment tested prior to returning it to service. Jumpers shall not be stored in machine rooms, control rooms, hoistways, machinery spaces, control spaces, escalator/moving walk wellways, or pits (see also 8.6.1.6.1).

NOTE [8.6.1.6.3(c)]: See "Elevator Industry Field Employees' Safety Handbook" for recommended minimum jumper control procedures.

(d) Control and operating circuits and devices shall be maintained in compliance with applicable Code requirements (see 8.6.1.1.2).

(e) Substitution of any wire or current-carrying device for the correct fuse or circuit breaker in an elevator circuit shall not be permitted.

8.6.1.6.4 Painting. Care shall be used in the painting of the equipment to make certain that it does not interfere with the proper functioning of any component. Painted components shall be tested for proper operation upon completion of painting.

8.6.1.6.5 Fire Extinguishers. In jurisdictions not enforcing NBCC, Class "ABC" fire extinguishers shall be provided in elevator electrical machine rooms, control rooms, and control spaces outside the hoistway intended for full bodily entry, and walk-in machinery and control rooms for escalators and moving walks; and they shall be located convenient to the access door.

8.6.1.6.6 Workmanship. Care should be taken during operations such as torquing, drilling, cutting, and welding to ensure that no component of the assembly is damaged or weakened. Rotating parts shall be properly aligned.

8.6.1.6.7 Signs and Data Plates. Required signs and data plates that are damaged or missing shall be repaired or replaced.

8.6.1.7 Periodic Tests. The frequency of periodic tests shall be established by the authority having jurisdiction as required by 8.11.1.3.

NOTE: Recommended intervals for periodic tests can be found in Nonmandatory Appendix N.

8.6.1.7.1 Periodic tests shall be witnessed by an inspector employed by the authority having jurisdiction or by a person authorized by the authority having jurisdiction. The inspector shall conform to the requirements in 8.11.1.1.

8.6.1.7.2 Periodic Test Record. A periodic test record for all periodic tests containing the applicable Code requirement(s) and date(s) performed, and the name of the person or firm performing the test, shall be installed to be readily visible and adjacent to or securely attached to the controller of each unit in the form of a metal tag or other format designated by and acceptable to the authority having jurisdiction. If any of the alternative test methods contained in 8.6.4.20 were performed, then the test tag must indicate alternative testing was utilized for the applicable requirement. (13)

8.6.1.7.3 No person shall at any time make any required safety device or electrical protective device ineffective, except where necessary during tests. Such devices shall be restored to their normal operating condition in conformity with the applicable requirements prior to returning the equipment to service (see 2.26.7).

8.6.1.7.4 All references to "Items" and "Parts" are to Items in ASME A17.2.

8.6.2 Repairs

See 8.6.2.1 through 8.6.2.5 for general requirements for repairs.

8.6.2.1 Repair Parts. Repairs shall be made with parts of at least equivalent material, strength, and design (see 8.6.3.1).

8.6.2.2 Welding and Design. Welding and design of welding shall conform to 8.7.1.4 and 8.7.1.5.

8.6.2.3 Repair of Speed Governors. Where a repair is made to a speed governor that affects the tripping linkage or speed adjustment mechanism, the governor shall be checked in conformance with 8.6.4.19.2.

Where a repair is made to the governor jaws or associated parts that affect the pull-through force, the governor pull-through force shall be checked in conformance with 8.6.4.19.2(b). A test tag shall be attached, indicating the date the pull-through test was performed.

8.6.2.4 Repair of Releasing Carrier. When a repair is made to a releasing carrier, the governor rope pull-out and pull-through forces shall be verified in conformance with 8.11.2.3.2(b).

8.6.2.5 Repair of Suspension and Compensating Means and Governor Ropes. Suspension and compensating members and governor ropes shall not be lengthened or repaired by splicing (see 8.7.2.21).

- (13) **8.6.2.6 Repairs Involving SIL Rated Device(s).** SIL rated device(s) used to satisfy 2.26.4.3.2, 2.26.8.2, 2.26.9.3.2(b), 2.26.9.5.1(b), and 2.26.9.6.1(b) shall
- (a) not be repaired in the field
 - (b) be permitted to be repaired in accordance with the provisions for repair where included in the listing/certification
 - (c) not be affected by other repair(s) such that the listing/certification is invalidated

8.6.3 Replacements

8.6.3.1 Replacement Parts. Replacements shall be made with parts of at least equivalent material, strength, and design.

8.6.3.2 Replacement Suspension Means. Suspension means, compensation means, and governor ropes shall be replaced when they no longer conform to the requirements of ASME A17.6. Replacement of suspension means, compensation means, and governor ropes shall conform to the requirements of ASME A17.6 as stated in 8.6.3.2.1 through 8.6.3.2.3.

8.6.3.2.1 For steel wire rope, ASME A17.6, Section 1.10 shall apply.

NOTE (8.6.3.2.1): See Nonmandatory Appendix T for inspection and replacement of steel wire ropes.

8.6.3.2.2 For aramid fiber ropes, ASME A17.6, Section 2.9 shall apply.

8.6.3.2.3 For noncircular elastomeric-coated steel suspension members, ASME A17.6, Section 3.7 shall apply.

8.6.3.3 Replacement of Suspension-Means Fastenings and Hitch Plates. Replacement of suspension-means fastenings and hitch plates shall conform to the requirements in 8.6.3.3.1 through 8.6.3.3.5.

8.6.3.3.1 When the suspension-means fastenings are replaced with an alternate means that conforms to 2.20.9, load-carrying ropes shall be in line with the shackle rod.

8.6.3.3.2 Existing hitch plates that do not permit the load-carrying ropes to remain in line with the shackle rods shall have the replacement fastening staggered in the direction of travel of the elevator and counterweight, or the hitch plates shall be replaced.

8.6.3.3.3 Replacement hitch plates shall conform to 2.15.13 and shall provide proper alignment of load-carrying ropes and shackle rods.

8.6.3.3.4 Replacement fastenings shall be permitted to be installed on the car only, the counterweight only, at either of the dead-end hitches, or at both attachment points.

8.6.3.3.5 Rope fastenings at the drum connection of winding-drum machines shall comply with 8.6.4.10.2.

8.6.3.4 Replacement of Governor or Safety Rope

8.6.3.4.1 Governor ropes shall be of the same size, material, and construction as the rope specified by the governor manufacturer, except that a rope of the same size but of different material or construction shall be permitted to be installed in conformance with 8.7.2.19.

8.6.3.4.2 The replaced governor ropes shall comply with 2.18.5.

8.6.3.4.3 After a governor rope is replaced, the governor pull-through force shall be checked as specified in 8.11.2.3.2(b).

8.6.3.4.4 A test tag indicating the date when the pull-through test was performed shall be attached.

8.6.3.4.5 The safety rope shall comply with 2.17.12.4 and 2.17.12.5.

8.6.3.4.6 A new rope data tag conforming to 2.18.5.3 shall be installed at each rope replacement, and the date of the rope replacement shall be recorded in the maintenance records [8.6.1.4.1(b)(2)]. (ED)

8.6.3.5 Belts and Chains. If one belt or chain of a set is worn or stretched beyond that specified in the manufacturer's recommendation, or is damaged so as to require replacement, the entire set shall be replaced. (ED)
Sprockets and toothed sheaves shall also be replaced if worn beyond that specified in the manufacturer's recommendations.

8.6.3.6 Replacement of Speed Governor. When a speed governor is replaced, it shall conform to 2.18. When a releasing carrier is provided, it shall conform to 2.17.15. The governor rope shall be of the type and size specified by the governor manufacturer.

The governor shall be checked in conformance with 8.11.2.3.2. Drum-operated safeties that require continuous tension in the governor rope to achieve full safety application shall be checked as specified in 8.11.2.3.1 and 8.7.2.19.

8.6.3.7 Listed/Certified Devices

8.6.3.7.1 Where a listed/certified device is replaced, the replacement shall be subject to the applicable engineering or type test as specified in 8.3, or the requirements of CSA B44.1/ASME A17.5. Hoistway door interlocks, hoistway door combination mechanical lock and electric contact, and door or gate electric contact, shall conform to the type tests specified in 2.12.4.1. The device shall be labeled by the certifying organization (see 8.6.1.1). In jurisdictions not enforcing NBCC, door panels, frames, and entrances hardware shall be provided with the instructions required by 2.11.18.

8.6.3.7.2 Where a component in a listed/certified device is replaced, the replacement component shall be subject to the requirements of the applicable edition of CSA B44.1/ASME A17.5 and/or the engineering or type test in 8.3. Hoistway door interlocks, hoistway door combination mechanical lock and electric contact, and door or gate electric contact, shall conform to the type tests specified in 2.12.4.1. The component shall be included in the original manufacturer's listed/certified device documentation or as a listed/certified replacement component (see 8.6.1.1).

Each replacement component shall be plainly marked for identification in accordance with the certifying organization's procedures. In jurisdictions not enforcing NBCC, door panels, frames, and entrances hardware shall be provided with the instructions required by 2.11.18.

NOTE (8.6.3.7): Devices that may fall under this requirement are included but not limited to hoistway door locking devices and electric contacts, car door contacts and interlocks, hydraulic control valves, escalator steps, fire doors, and electrical equipment.

8.6.3.8 Replacement of Door Reopening Device.

Where a reopening device for power-operated car doors or gates is replaced, the following requirements shall apply:

- (a) The door closing force shall comply with the Code in effect at the time of the installation or alteration.
- (b) The kinetic energy shall comply with the Code in effect at the time of the installation or alteration.
- (c) When firefighters' emergency operation is provided, door reopening devices and door closing on Phase I and Phase II shall comply with the requirements

applicable at the time of installation of the firefighters' emergency operation.

8.6.3.9 Replacement of Releasing Carrier. Where a replacement is made to a releasing carrier, the governor rope pull-out and pull-through forces shall be verified in conformance with 8.11.2.3.2(b).

8.6.3.10 Replacement of Hydraulic Jack, Plunger, Cylinder, Tanks, and Anticreep Leveling Device

8.6.3.10.1 A hydraulic jack replacement shall be classified as an alteration and shall comply with 8.7.3.23.1.

8.6.3.10.2 A plunger replacement shall be classified as an alteration and shall comply with 8.7.3.23.2.

8.6.3.10.3 A cylinder replacement shall be classified as an alteration and shall comply with 8.7.3.23.3.

8.6.3.10.4 A tank replacement shall be classified as an alteration and shall comply with 8.7.3.29.

8.6.3.10.5 An anticreep leveling device replacement shall be classified as an alteration and shall comply with 8.7.3.31.3.

8.6.3.11 Replacement of Valves and Piping. Where any valves, pipings, or fittings are replaced, replacements shall conform to 3.19 with the exception of 3.19.4.6. Replacement control valves must conform to the Code under which it was installed.

8.6.3.12 Runby and Clearances After Reropeing or Shortening. The minimum car and counterweight clearances specified in 2.4.6 and 2.4.9 shall be maintained when new suspension means are installed or when existing suspension means are shortened.

The minimum clearances shall be maintained by any of the methods described in 8.6.3.12.1 through 8.6.3.12.3 (see 8.6.4.11).

8.6.3.12.1 Limit the length that the suspension means are shortened.

8.6.3.12.2 Provide blocking at the car or counterweight strike plate. The blocking shall be of sufficient strength and secured in place to withstand the reactions of buffer engagement as specified in 8.2.3. If wood blocks are used to directly engage the buffer, a steel plate shall be fastened to the engaging surface or shall be located between that block and the next block to distribute the load upon buffer engagements.

8.6.3.12.3 Provide blocking under the car or counterweight buffer or both of sufficient strength and secured in place to withstand the reactions of buffer engagement as described in 8.2.3.

8.6.3.12.4 Provide the month and year the suspension means were first shortened. Appropriate data shall be recorded on the data tag (see 2.20.2.2.2).

- (13) **8.6.3.13 Replacement of Demarcation Lights.** Fluorescent lighting fixtures shall be permitted to be replaced by any type light source, except incandescent sources, and shall comply with all other applicable step demarcation lighting requirements under which the escalator was installed or altered.

(13) **8.6.3.14 Replacements Involving SIL Rated Device(s) (see 1.3)**

(a) A SIL rated device (see 1.3) used to satisfy 2.26.4.3.2, 2.26.8.2, 2.26.9.3.2(b), 2.26.9.5.1(b), or 2.26.9.6.1(b) shall not be affected by other replacement(s) such that the listing/certification is invalidated.

(b) Where a SIL rated device (see 1.3) used to satisfy 2.26.4.3.2, 2.26.8.2, 2.26.9.3.2(b), 2.26.9.5.1(b), or 2.26.9.6.1(b) is replaced, it shall be considered a replacement only when the replacement device is the original manufacturer's listed/certified SIL rated device or the original manufacturer's listed/certified SIL rated replacement device; otherwise, it shall be considered an alteration [see 8.7.1.9(d)].

(c) Where a non-SIL rated device used to satisfy 2.26.4.3.1, 2.26.8.2, 2.26.9.32(a), 2.26.9.5.1(a), or 2.26.9.6.1(a) is replaced with a SIL rated device, it shall be considered an alteration [see 8.7.1.9(c)].

8.6.4 Maintenance and Testing of Electric Elevators

The maintenance and testing of electric elevators shall conform to 8.6.1 through 8.6.4.

8.6.4.1 Suspension and Compensating Means

8.6.4.1.1 Suspension and compensating means shall be kept sufficiently clean so that they can be visually inspected.

8.6.4.1.2 Steel wire ropes shall be lightly lubricated. Precautions shall be taken in lubricating suspension steel wire ropes to prevent the loss of traction. Lubrication shall be in accordance with instructions on the rope data tag [see 2.20.2.2(n)], if provided.

- (13) **8.6.4.1.3** Equal tension shall be maintained between individual suspension members in each set. Suspension members are considered to be equally tensioned when the smallest tension measured is within 10% of the highest tension measured. When suspension member tension is checked or adjusted, an antirotation device conforming to the requirements of 2.20.9.8 shall be permitted.

8.6.4.2 Governor Wire Ropes

8.6.4.2.1 The ropes shall be kept clean.

8.6.4.2.2 Governor wire ropes shall not be lubricated after installation. If lubricants have been applied to governor ropes, they shall be replaced, or the lubricant removed, and the governor and safety shall be tested as specified in 8.6.4.19.2(b) and 8.6.4.18.2.

8.6.4.3 Lubrication of Guide Rails

8.6.4.3.1 The lubrication of guide rails shall be in accordance with the requirements on the crosshead data plate (see 2.17.16), where provided.

8.6.4.3.2 Where a data plate is not provided, the lubrication of guide rails shall conform to the following: (ED)

(a) Guide rails, except those of elevators equipped with roller or other types of guiding members not requiring lubrication, shall be kept lubricated.

(b) Where sliding-type safeties are used, the guide-rail lubricants, or prelubricated or impregnated guide shoe gibs, where used, shall be of a type recommended by the manufacturer of the safety (see 8.6.1.6.2 and 2.17.16).

8.6.4.3.3 If lubricants other than those recommended by the manufacturer are used, a safety test conforming to 8.6.4.20.1 shall be made to demonstrate that the safety will function as required by 2.17.3. (ED)

8.6.4.3.4 Rails shall be kept clean and free of lint and dirt accumulation and excessive lubricant. Means shall be provided at the base of the rails to collect excess lubricant.

8.6.4.3.5 Rust-preventive compounds such as paint, mixtures of graphite and oil, and similar coatings shall not be applied to the guiding surfaces, unless recommended by the manufacturer of the safety. Once applied, the safety shall be checked as specified in 8.6.4.20.1. (ED)

8.6.4.4 Oil Buffers

8.6.4.4.1 The oil level shall be maintained at the level indicated by the manufacturer. The grade of oil to be used shall be as indicated on the buffer marking plate, where required (see 2.22.4.10 and 2.22.4.11).

8.6.4.4.2 Buffer plungers shall be kept clean and shall not be coated or painted with a substance that will interfere with their operation.

8.6.4.4.3 Buffer oil shall not be stored in the pit or hoistway or on top of the car.

8.6.4.5 Safety Mechanisms

8.6.4.5.1 Safety mechanisms shall be kept lubricated and free of rust, corrosion, and dirt that can interfere with the operation of the safety.

8.6.4.5.2 The required clearance between the safety jaws and the rail shall be maintained.

8.6.4.6 Brakes

8.6.4.6.1 The driving-machine brake shall be maintained to ensure proper operations, including, but not limited to the following:

- (a) residual pads (antimagnetic pads)
- (b) lining and running clearances
- (c) pins and levers

- (d) springs
- (e) sleeves and guide bushings
- (f) discs and drums
- (g) brake coil and plunger

- (13) **8.6.4.6.2** If any part of the driving-machine brake is changed or adjusted that can affect the holding capacity or decelerating capacity of the brake when required (see 2.24.8.3), it shall be adjusted and checked by means that will verify its proper function and holding capacity. A test complying with 8.6.4.20.4 shall be performed.

8.6.4.6.3 If any part of the emergency brake is changed or adjusted that can affect the holding capacity or decelerating capacity of the emergency brake when required (see 2.19.3), it shall be adjusted and checked by means that will verify its proper function and holding capacity.

8.6.4.7 Cleaning of Hoistways and Pits

8.6.4.7.1 Hoistways and pits shall be kept free of dirt and rubbish and shall not be used for storage purposes.

8.6.4.7.2 Landing blocks and pipe stands shall be permitted to be stored in the pit, provided that they do not interfere with the operation of the elevator and do not present a hazard for persons working in the pit.

8.6.4.7.3 Pit access doors shall be kept closed and locked.

8.6.4.7.4 Water and oil shall not be allowed to accumulate on pit floors.

8.6.4.8 Machinery Spaces, Machine Rooms, Control Spaces, and Control Rooms

8.6.4.8.1 Floors and machinery and control spaces shall be kept free of water, dirt, rubbish, oil, and grease.

8.6.4.8.2 Articles or materials not necessary for the maintenance or operation of the elevator shall not be stored in machinery spaces, machine rooms, control spaces, and control rooms.

8.6.4.8.3 Flammable liquids having a flashpoint of less than 44°C (110°F) shall not be kept in such rooms or spaces.

8.6.4.8.4 Access doors shall be kept closed and locked.

8.6.4.8.5 Machinery spaces and control spaces located in the hoistway shall not be used for storage purposes (see also 8.6.4.7.1).

8.6.4.9 Cleaning of Top of Cars. The tops of cars shall be kept free of oil, water, dirt, and rubbish, and shall not be used for storing lubricants, spare parts, tools, or other items.

8.6.4.10 Refastening or Resocketing of Car-Hoisting Ropes on Winding-Drum Machines

8.6.4.10.1 General. The hoisting ropes of elevators having winding-drum driving-machines with 1:1 roping, if of the babbitted rope socket type, shall be resocketed, or for other type of fastenings, replaced or moved on the rope to a point above the existing fastening at the car ends at intervals no longer than

- (a) 1 year, for machines located over the hoistway.
- (b) 2 years, for machines located below or at the side of the hoistway.

(c) where auxiliary rope-fastening devices conforming to 2.20.10 are installed, refastening at the periods specified is not required, provided that, where such devices are installed, all hoisting ropes shall be refastened on the failure or indication of failure of any rope fastening.

(d) where the elevator is equipped with a drum counterweight, the fastenings shall be examined for fatigue or damage at the socket. Where fatigue or damage is detected, the ropes shall be refastened in conformance with 8.6.4.10.2.

8.6.4.10.2 Procedure

(a) In resocketing babbitted rope sockets or replacing other types of fastenings, a sufficient length shall be cut from the end of the rope to remove damaged or fatigued portions. The fastenings shall conform to 2.20.9. Where the drum ends of the ropes extend beyond their clamps or sockets, means shall be provided to prevent the rope ends from coming out of the inside of the drum and to prevent interference with other parts of the machine.

(b) The suspension wire ropes shall conform to 2.20.7.

8.6.4.10.3 Tags. A legible metal tag shall be securely attached to one of the wire rope fastenings after each resocketing or changing to other types of fastenings and shall bear the following information:

- (a) the name of the person or firm who performed the resocketing or changing of other types of fastenings and
- (b) the date on which the rope was resocketed or other types of fastening changed

The material and marking of the tags shall conform to 2.16.3.3, except that the height of the letters and figures shall be not less than 1.5 mm (0.0625 in.).

8.6.4.11 Runby

8.6.4.11.1 The car and counterweight runby shall be permitted to be reduced (see 2.4.2), provided the car or counterweight does not strike the buffer, the top car clearances are not reduced below that required at the time of installation or alteration, and the final terminal-stopping device is still operational (see also 8.6.3.3.3).

8.6.4.11.2 Where spring-return oil buffers are provided and compression was permitted with the car at the terminals (see 2.4.2 and 2.22.4.8), the buffer compression shall not exceed 25% of the buffer stroke.

(13)

8.6.4.12 Governors

8.6.4.12.1 Governors shall be examined to ensure that all seals are intact and manually operated to determine that all moving parts, including the rope-grip jaws and switches, operate freely.

8.6.4.12.2 Governors, governor ropes, and all sheaves shall be free from contaminants or obstructions, or both, that interfere with operation or function, including the accumulation of rope lubricant or materials, or both, in the grooves of governors or sheaves.

8.6.4.13 Door Systems

(13) **8.6.4.13.1 General.** All landing and car-door or gate mechanical and electrical components shall be maintained to ensure safe and proper operation including but not limited to, the following:

(a) hoistway door interlocks or mechanical locks and electric contacts

(b) car door electric contacts or car door interlocks, where required

(c) door reopening devices

(d) vision panels and grilles, where required

(e) hoistway door unlocking devices and escutcheons

(f) hangers, tracks, door rollers, up-thrusts, and door safety retainers, where required

(g) astragals and resilient members, door space guards, and sight guards, where required

(h) sills and bottom guides, fastenings, condition, and engagement

(i) clutches, engaging vanes, retiring cams, and engaging rollers

(j) interconnecting means

(k) door closers, where required

(l) means to restrict hoistway or car door opening and expiration date for the alternate power source, where required

8.6.4.13.2 Kinetic Energy and Force Limitation for Automatic Closing, Horizontal Sliding Car and Hoistway Doors or Gates. Where a power-operated horizontally sliding door is closed by momentary pressure or by automatic means, the closing kinetic energy and closing force shall be maintained to conform to 2.13.4 and 2.13.5.

8.6.4.14 Hoistway Access Switches. Hoistway access switches, where provided, shall be maintained.

8.6.4.15 Car Emergency System. Emergency operation of signaling devices (see 2.27), lighting (see 2.14.7), communication (see 2.27.1.1.2, 2.27.1.1.3, and 2.27.1.2) and ventilation (see 2.14.2.3), shall be maintained.

8.6.4.16 Stopping Accuracy. The elevator shall be maintained to provide a stopping accuracy at the landings during normal operation as appropriate for the type of control, in accordance with applicable Code requirements.

8.6.4.17 Ascending Car Overspeed and Unintended Car Movement Protection. Devices for ascending car overspeed and unintended car movement protection shall be maintained (see 2.19).

8.6.4.18 Compensation Sheaves and Switches

8.6.4.18.1 Suspension and compensation means shall be maintained to prevent the compensation sheave from reaching the upper or lower limit of travel and to prevent unintended actuation of compensation sheave switch(es) during normal operation.

8.6.4.19 Periodic Test Requirements — Category 1

NOTE: For test frequency, see 8.11.1.3.

8.6.4.19.1 Oil Buffers. Car and counterweight buffers shall be tested to determine conformance with the applicable plunger return requirements (Item 5.9.2.1).

8.6.4.19.2 Safeties

(a) *Examinations.* All working parts of car and counterweight safeties shall be examined to determine that they are in satisfactory operating condition and that they conform to the applicable requirements of 8.7.2.14 through 8.7.2.28 (see 2.17.10 and 2.17.11). Check the level of the oil in the oil buffer and the operation of the buffer compression-switch on Type C safeties.

(b) *Tests.* Safeties shall be subjected to the following tests with no load in the car:

(1) Type A, B, or C governor-operated safeties shall be operated by manually tripping the governor with the car operating at the slowest operating speed in the down direction.

In this test, the safety shall bring the car to rest promptly.

In the case of Type B safeties, the stopping distance is not required to conform to 2.17.3.

In the case of Type C safeties, full oil buffer compression is not required.

In the case of Type A, B, or C safeties employing rollers or dogs for application of the safety, the rollers or dogs are not required to operate their full travel (Item 2.29.2.1).

(2) Governor-operated wood guide-rail safeties shall be tested by manually tripping the governor with the car at rest and moving the car in the down direction until it is brought to rest by the safety and the hoisting ropes slip on traction sheaves or become slack on winding drum sheaves [Item 2.29.2(d)].

(3) Type A and wood guide-rail safeties without governors which are operated as a result of the breaking or slackening of the hoisting ropes shall be tested by obtaining the necessary slack rope to cause it to function (Item 2.29.2.1).

8.6.4.19.3 Governors. Governors shall be operated manually to determine that all parts, including

(ED)

those which impart the governor pull-through tension to the governor rope, operate freely [Item 2.13.2.1(a)].

- (13) **8.6.4.19.4 Slack-Rope Devices and Stop Motion Switch on Winding Drum Machines.** Slack-rope devices on winding drum machines shall be operated manually and tested to determine conformance with the applicable requirements. The final terminal stopping device and the machine final (stop motion switch) shall be examined and tested by disabling the normal stopping device, normal terminal stopping device, and final terminal stopping device located in the hoistway and operating the unit to verify proper operation (Item 2.20).

- (ED) **8.6.4.19.5 Normal and Final Terminal Stopping Devices.** Normal and final terminal stopping devices shall be examined and tested to determine conformance with the applicable requirements (2.25) (Items 2.20, 2.28.2.1, 3.5.2.1, and 3.6.2.1).

- (13) **8.6.4.19.6 Firefighters' Emergency Operation.** Firefighters' Emergency Operation (Phase I and II) shall be tested to determine conformance with the applicable requirements. Phase I recall shall be tested by individually activating fire alarm initiating device inputs to the elevator control, the three-position key switch at the designated landing and, where provided, the two-position switch at the building fire control station (Part 6).

8.6.4.19.7 Standby or Emergency Power Operation. Operation of elevators equipped with standby or emergency power shall be tested to determine conformance with the applicable requirements (Item 1.17.2.1). Tests shall be performed with no load in the car.

8.6.4.19.8 Power Operation of Door System. The closing forces and speed of power-operated hoistway door systems shall be tested to determine conformance with the applicable requirements (Item 1.8.1). For elevators required to comply with 2.13.4.2.4, the time in the door Code zone distance shall be measured and compared with the time specified on the data plate.

8.6.4.19.9 Broken Rope, Tape, or Chain Switch. Where a rope, tape, or chain is used to connect the motion of the car to the machine room normal limit, the switch that senses failure of this connection shall be tested for compliance with 2.26.2.6 (Item 3.26.1.1).

- (13) **8.6.4.19.10 Functional Safety of SIL Rated Device(s).** Verify SIL rated device(s) used to satisfy 2.26.4.3.2, 2.26.8.2, 2.26.9.3.2(b), 2.26.9.5.1(b), and 2.26.9.6.1(b) are as identified on wiring diagrams (8.6.1.6.3) with part identification, SIL, and certification identification information. The person or firm installing the equipment shall provide a written checkout procedure and demonstrate that SIL rated devices, safety

functions (see Table 2.26.4.3.2), and related circuits operate as intended.

- 8.6.4.19.11 Ascending Car Overspeed Protection and Unintended Car Movement Devices** (13)

(a) *Examinations.* All working parts of ascending car overspeed protection and unintended car movement devices shall be examined to determine that they are in satisfactory operating condition and that they conform to the applicable requirements of 2.19.1.2(a) and 2.19.2.2(a).

(b) *Tests.* Ascending car overspeed protection shall be subjected to tests with no load in the car at the slowest operating speed in the up direction.

(c) *Tests.* Unintended car movement shall be subjected to tests with no load in the car at the slowest operating speed in the up direction.

- 8.6.4.19.12 Traction-Loss Detection Means.** (ED)

Where provided, conformance with the traction-loss detection means specified in 2.20.8.1 shall be demonstrated by

(a) causing relative motion between the drive sheave and the suspension means either by bottoming the car or counterweight [see 8.6.4.20.10(b)], or

(b) an alternative test provided in the Maintenance Control Program [see 8.6.1.2.1(f)]

8.6.4.19.13 Broken-Suspension-Member and Residual-Strength Detection Means. Where provided, testing of broken-suspension and residual-strength detection means shall comply with the following:

(a) The broken-suspension-member detection means shall be tested by simulating a slack suspension member or a loss of a suspension member as appropriate (see 2.20.8.2).

(b) Suspension-member residual-strength detection means shall be tested to simulate a reduction of residual strength to 2.20.8.3.

- 8.6.4.19.14 Occupant Evacuation Operation.** (13)

Occupant Evacuation Operation shall be tested to determine conformance with the applicable requirements. Deficiencies shall be corrected. A record of findings shall be available to the building owner and the authority having jurisdiction.

8.6.4.19.15 Emergency Communications. (13) Emergency communications shall be tested to determine conformance with the applicable requirements (Item 1.6).

8.6.4.19.16 Means to Restrict Hoistway or Car Door Opening. (13) Means to restrict hoistway or car door opening shall be tested to determine conformance with the applicable requirements (Item 1.18).

- 8.6.4.20 Periodic Test Requirements — Category 5**

NOTE: For test frequency, see 8.11.1.3.

8.6.4.20.1 Car and Counterweight Safeties. (13) Types A, B, and C car and counterweight safeties shall be tested

in accordance with 8.6.4.20.1(a) or subject to approval by the authority having jurisdiction with 8.6.4.20.1(b).

(a) *Rated Load and Rated Speed Test.* Car safeties, except those operating on wood guide rails, and their governors, shall be tested with rated load in the car. Counterweight safety tests shall be made with no load in the car. Tests shall be made by tripping the governor by hand at the rated speed. The following operational conditions shall be checked (Item 2.29.2):

(1) Type B safeties shall stop the car with the rated load within the required range of stopping distances for which the governor is tripped (Item 2.29.2) and the level of the platform checked for conformance to 2.17.9.2.

(2) For Type A safeties and Type A safety parts of Type C safeties, there shall be sufficient travel of the safety rollers or dogs remaining after the test to bring the car and its rated load to rest on safety application at governor tripping speed. The level of the platform shall be checked for conformance to 2.17.9.2.

(b) *Alternative Test Method for Car Safeties.* The alternative test methods shall comply with 8.6.11.10 and the following:

(1) The testing of safeties with any load in the car, centered on each quarter of the platform symmetrically with relation to the centerlines of the platform from no load up to rated load, and at not less than rated speed shall be permitted provided that

(a) when the alternative test is performed, the test shall stop the car and verify that the safeties will be capable of stopping an overspeeding car in accordance with the requirements of Section 2.17 applicable to the specific classification of safeties, and

(b) when applied, the method shall verify that the safeties perform or are capable of performing in compliance with 8.6.4.20.1(a) and the platform shall not be out of level more than 30 mm/m (0.36 in./ft) in any direction.

(2) A test tag as required in 8.6.1.7.2 shall be provided.

8.6.4.20.2 Governors

(a) The tripping speed of the governor and the speed at which the governor overspeed switch, where provided, operates shall be tested to determine conformance with the applicable requirements and the adjustable means shall be sealed (Item 2.13.2.1).

(b) The governor rope pull-through and pull-out forces shall be tested to determine conformance with the applicable requirements, and the adjustment means shall be sealed (Item 2.13.2.1).

(c) After these tests in jurisdictions enforcing NBCC, a metal tag indicating the date of the governor tests, together with the name of the person or firm that performed the tests, shall be attached to the governor in a permanent manner.

8.6.4.20.3 Oil Buffers

(a) Car oil buffers shall be tested to determine conformance with the applicable requirements by

(1) running the car onto the buffer with rated load at rated speed, or

(2) subject to approval by the authority having jurisdiction

(a) running the car with any load, from no load up to rated load onto the buffer at rated speed when the requirements of 8.6.11.10 are complied with, provided that when applied the method verifies that the buffer performs or is capable of performing in compliance with 8.6.4.20.3(a), except as specified in 8.6.4.20.3(b) and (c) (Item 5.9.2.1). Counterweight oil buffers shall be tested by running the counterweight onto its buffer at rated speed with no load in the car, except as specified in 8.6.4.20.3(b) and (c) (Item 5.9.2.1), or

(b) running the car onto the buffer with any load, from no load up to rated load, and at less than rated speed, when the requirements of 8.6.11.10 are complied with, provided that when applied, the method verifies that the buffer performs or is capable of performing in compliance with 8.6.4.20.3(a)

(b) For reduced stroke buffers, this test shall be made at the reduced striking speed permitted (Item 5.9.2.1).

(c) This test is not required where a Type C safety is used (see 8.6.4.20.1).

(d) In making these tests, the normal and emergency terminal stopping devices shall be made temporarily inoperative. The final terminal stopping devices shall remain operative and be temporarily relocated, if necessary, to permit compression of the buffer during the test.

(e) After completion of the test, a metal tag, indicating the date of the test, together with the name of the person or firm who performed the test, shall be attached to the buffer [Item 5.3.2(b)].

(f) Counterweight oil buffers shall be tested by running the counterweight onto its buffer at rated speed with no load in the car, except as specified in 8.6.4.20.3(b) and (c) (Item 5.9.2.1), or at reduced speed if the requirements of 8.6.11.10 are met.

(g) A test tag as required in 8.6.1.7.2 shall be provided.

8.6.4.20.4 Driving-Machine Brake(s). For passenger elevators and all freight elevators, the driving-machine brake shall be tested for compliance with applicable requirements, in accordance with 8.6.4.20.4(a), or subject to approval by the authority having jurisdiction with 8.6.4.20.4(b). (13) (ED)

For elevators installed under ASME A17.1-2000/CSA B44-00 and later editions, have the brake setting verified in accordance with the data on the brake marking plate.

Upon completion of the test, the means of adjusting the holding capacity shall be sealed to prevent changing the adjustment without breaking the seal. The seal shall bear or otherwise attach the identification of the person

Table 8.6.4.20.4 Brake Test Loads

| Class of Service | Not Permitted to Carry Passengers | Permitted to Carry Passengers |
|--------------------------|---|--|
| Passenger | Not applicable | 125% rated load |
| Freight | Rated load | 125% rated load |
| One Piece Load by 2.16.7 | Rated load or one piece load, whichever is greater | 125% rated load or one piece load, whichever is greater |

or firm that installed it. (See also 8.6.1.7.2, Periodic Test Tags.)

(a) Test with load per Table 8.6.4.20.4. Place the load as shown in Table 8.6.4.20.4 in the car. The driving-machine brake, on its own, shall hold the car with this load. With no load in the car the driving-machine brake shall hold the empty car at rest, and shall decelerate an empty car traveling in the up direction from governor tripping speed. The driving-machine brake on freight elevators of Class C-2 loading, when loaded to their maximum design load, shall hold the elevator car at rest (Item 2.17.2.1).

(b) *Alternative Test Method for Driving-Machine Brakes.* The alternative test methods shall comply with 8.6.11.10 and the following:

(1) Any method of verifying conformity of the driving-machine brake with the applicable Code requirements (see 2.24.8.3 and Table 8.6.4.20.4) shall be permitted, including the testing method of the brakes with or without any load in the car, provided that when applied the method verifies that the brake performs or is capable of performing in compliance with 8.6.4.20.4(a).

(2) A test tag as required in 8.6.1.7.2 shall be provided.

(13) 8.6.4.20.5 Reserved for Future Use

8.6.4.20.6 Emergency Terminal Stopping and Speed-Limiting Devices. Emergency terminal speed-limiting devices, where provided, shall be tested for conformance with applicable requirements (2.25.4; and Item 5.3.2.1). For static control elevators, emergency terminal stopping devices, when provided, shall be tested for conformance with applicable requirements (2.25.4) (Item 2.28.2.1).

(13) 8.6.4.20.7 Power Opening of Doors. Determine that power opening of car and hoistway doors only occurs as permitted by the applicable requirements (Item 1.10.2).

8.6.4.20.8 Leveling Zone and Leveling Speed. Check that the leveling zone does not exceed the maximum allowable distance. Check that the leveling speed does not exceed 0.75 m/s (150 ft/min). For static control elevators, the person or firm installing or maintaining the equipment shall provide a written checkout procedure and demonstrate that the leveling speed with the doors open is limited to a maximum of 0.75 m/s

(150 ft/min) and that the speed-limiting (or speed monitor) means is independent of the normal means of controlling this speed [Item 1.10.2(b)].

8.6.4.20.9 Inner Landing Zone. For static control elevators, check that the zone in which the car can move with the doors open is not more than 75 mm (3 in.) above or below the landing (Item 1.10.2.1).

8.6.4.20.10 Braking System, Traction, and Traction Limits. Traction and traction limits on traction elevators shall be verified for compliance with 2.24.2.3 in accordance with 8.6.4.20.10(a) or subject to approval by the authority having jurisdiction, with 8.6.4.20.10(b).

(a) *Dynamic Stopping Test.* Traction elevators shall be tested to ensure that

(1) during an emergency stop initiated by any of the electrical protective device(s) listed in 2.26.2 (except 2.26.2.13) (except buffer switches for oil buffers used with Type C car safeties) at the rated speed in the down direction, with passenger elevators and freight elevators permitted to carry passengers carrying 125% of their rated load, or with freight elevators carrying their rated load, cars shall safely stop and hold the load (see 2.24.2.3.1, 2.24.2.3.2 and 2.24.2.3.3); and

(2) if either the car or the counterweight bottoms on its buffers or becomes otherwise immovable, one of the following shall occur (see 2.24.2.3.4):

(a) the suspension means shall lose traction with respect to the drive sheave and not allow the car or counterweight to be raised; or

(b) the driving system shall stall and not allow the car or counterweight to be raised.

(3) With a load in the car in accordance with Table 8.6.4.20.4, the braking system and traction relation shall be tested to show the system can safely stop and hold the car, and where required by 2.16.2.2.4(c) shall re-level the car.

(b) *Alternative Test Method for Braking System, Traction, and Traction Limits.* Alternative test methods shall comply with 8.6.11.10 and the following:

(1) Other methods for verifying traction for compliance with 2.24.2.3, and traction limits in compliance with 2.24.2.3.4, shall be permitted provided the test method complies with the following:

(a) When applied, the method shall verify that the elevator traction system performs, or is capable of performing, in compliance with the performance requirements of 8.6.4.20.10(a).

(b) The braking system and traction relation shall be tested to show the system can safely stop and hold the car, and where required by 2.16.2.2.4(c), shall re-level the car without load in the car.

(2) A test tag as required in 8.6.1.7.2 shall be provided.

8.6.4.20.11 Emergency Brake. For passenger elevators and all freight elevators, the emergency brake shall be tested for compliance with 2.19.3.2.

8.6.4.21 Drive Sheaves With Nonmetallic Groove Surfaces and Steel Wire Ropes. Where steel wire ropes have worn through a nonmetallic drive-sheave groove surface and have not damaged the supporting sheave surface beneath the nonmetallic sheave groove surface, the groove surfaces shall be replaced and the steel wire ropes shall be inspected for conformance to the criteria of ASME A17.6, Section 1.10, and replaced, if necessary. Where the sheave-supporting surfaces have been damaged, the drive sheave shall also be replaced or repaired and the groove surfaces shall be replaced.

(13) **8.6.4.22 Maintenance of Seismic Devices**

8.6.4.22.1 A seismic switch, where provided, shall be maintained in accordance with the manufacturer's recommendations.

8.6.4.22.2 The counterweight displacement switch components, where provided, shall be

(a) maintained in accordance with the manufacturer's recommendations

(b) properly aligned and tensioned and kept free of dirt, debris, and other contaminants that may interfere with proper operation

8.6.5 Maintenance and Testing of Hydraulic Elevators

The maintenance and testing of hydraulic elevators shall conform to 8.6.1 through 8.6.3, and the applicable requirements of 8.6.4 and 8.6.5.

8.6.5.1 Pressure Tanks

8.6.5.1.1 Cleaning. Pressure tanks shall be thoroughly cleaned internally at least every 3 years and prior to the inspection and test required by 8.6.5.15.

8.6.5.1.2 Level. The liquid level in pressure tanks should be maintained at about two-thirds of the capacity of the tank.

8.6.5.2 Piston Rods. Piston rods of roped-hydraulic elevators shall be thoroughly cleaned prior to the test required by 8.6.5.15.

8.6.5.3 Water-Hydraulic Plungers. Plungers of water-hydraulic elevators shall be thoroughly cleaned to remove any buildup of rust and scale prior to the test required by 8.6.5.15.

8.6.5.4 Tank Levels. The level of oil in the oil tanks shall be checked and, where necessary, adjusted to comply with the prescribed minimum and maximum level.

8.6.5.5 Gland Packings and Seals

8.6.5.5.1 Examination and Maintenance. Where pressure piping, valves, and cylinders use packing glands or seals, they shall be examined and maintained to prevent excessive loss of fluid. When a cylinder packing or seal or a pressure-piping seal is replaced, the integrity of the entire hydraulic system shall be verified by operating it at relief-valve pressure for not less than 15 sec.

8.6.5.5.2 Collection of Oil Leakage. Oil leakage collected from each cylinder head seals or packing gland shall not exceed 19 L (5 gal) before removal. The container shall be covered and shall not be permitted to overflow.

8.6.5.6 Flexible Hoses and Fittings. Flexible hose and fittings assemblies installed between the check valve or control valve and the cylinder, and that are not equipped with an overspeed valve conforming to 3.19.4.7, shall be replaced not more than 6 years beyond the installation date. Existing hose assemblies that do not indicate an installation or replacement date shall be replaced. Replacements shall conform to 3.19.3.3.1(a) through (e) and 3.19.3.3.2.

8.6.5.7 Record of Oil Usage. For systems where the part of cylinder and/or piping is not exposed for visible examination, a written record shall be kept of the quantity of hydraulic fluid added to the system and emptied from leakage collection containers and pans. The written record shall be kept in the machine room. When the quantity of hydraulic fluid loss cannot be accounted for, the test specified in 8.6.5.14.1 and 8.6.5.14.2 shall be made.

8.6.5.8 Safety Bulkhead. Hydraulic cylinders installed below ground shall conform to 3.18.3.4, or the elevator shall conform to 8.6.5.8(a) or 8.6.5.8(b):

(a) the elevator shall be provided with car safeties conforming to 3.17.1 and guide rails, guide-rail supports, and fastenings conforming to 3.23.1; or

(b) the elevator shall be provided with a plunger gripper conforming to 3.17.3. The plunger gripper shall grip the plunger when the applicable maximum governor tripping speed in Table 2.18.2.1 is achieved.

8.6.5.9 Relief-Valve Setting. The relief-valve adjustment shall be examined to ensure that the seal is intact. If the relief-valve seal is not intact, tests shall be conducted in accordance with 8.6.5.14.1. (ED)

8.6.5.10 Runby and Clearances After Reropeing or Shortening. The minimum car and counterweight clearances and runby shall be maintained in compliance with the applicable code when replacement suspension

ropes are installed or when existing suspension ropes are shortened.

8.6.5.11 Cylinder Corrosion Protection and Monitoring

8.6.5.11.1 Corrosion Protection Monitoring.

Where monitored cylinder corrosion protection is required, the monitoring means shall be examined and maintained.

8.6.5.11.2 Corrosion Protection Loss. If the monitoring means detects that loss of corrosion protection has occurred, the means of corrosion protection shall be repaired or replaced.

8.6.5.12 Anticreep and Low Oil Protection. The anticreep function and low oil protection shall be maintained to operate in compliance with the applicable code.

- (13) **8.6.5.13 Overspeed Valve Setting.** Overspeed valves shall be calibrated and maintained in accordance with the manufacturer's recommendations including replacement of the valve seals or entire valves at intervals specified. All elevators provided with field adjustable overspeed valves shall have the adjustment means examined to ensure the seal is intact. If the overspeed adjustment seal is not intact, compliance with 8.6.5.16.5 shall be verified and a new seal shall be installed.

8.6.5.14 Periodic Test Requirements — Category 1

NOTE: For test frequency, see 8.11.1.3.

- (13) **8.6.5.14.1 Relief Valve Verification of Setting and System Pressure Test.** The relief valve setting shall be tested to determine that it will bypass the full output of the pump before the pressure exceeds 150% of the working pressure. Once this is established, test the entire system to ensure that it will withstand this pressure. It shall be resealed if the relief valve setting is altered or if the seal is broken (Item 2.31).

8.6.5.14.2 Hydraulic Cylinders and Pressure Piping. This test shall be performed after the relief valve setting and system pressure test in 8.6.5.14.1.

(a) Cylinders and pressure piping that are exposed shall be visually examined.

(b) Cylinders and pressure piping that are not exposed shall be tested for leakage, which cannot be accounted for by the visual examination in 8.6.5.14.2(a) (Item 2.36.2).

The duration of the test shall be for a minimum of 15 min (Item 2.36.2).

8.6.5.14.3 Additional Tests. The following tests shall also be performed:

- (a) Normal Terminal Stopping Devices (8.6.4.19.5) (Item 3.5.2)
 (b) Governors (8.6.4.19.3) (Item 2.13.2.2)
 (c) Safeties (8.6.4.19.2) (Item 5.8.2)

(d) Oil Buffers (8.6.4.19.1)
 (e) Firefighters' Emergency Operation (8.6.4.19.6) (Items 6.3 and 6.4)

(f) Standby or Emergency Power Operation (8.6.4.19.7) (Item 1.17.2.2)

NOTE: Absorption of regenerated power (2.26.10) does not apply to hydraulic elevators.

(g) Power Operations of Door System (8.6.4.19.8) (Items 4.6 and 4.7)

(h) Emergency Terminal Speed-Limiting Device and Emergency Terminal Stopping Device (3.25.2) (Item 3.6.2.2)

(i) Low Oil Protection Operation (3.26.9) (Item 2.39.2)

8.6.5.14.4 Flexible Hose and Fitting Assemblies.

Flexible hose and fitting assemblies shall be tested at the relief valve setting pressure for a minimum of 30 s. Any signs of leakage, slippage of hose fittings, damage to outer hose covering sufficient to expose reinforcement, or bulging, or distortions of the hose body is cause for replacement.

CAUTION: If the motor protection or motor overloads trip during this test, DO NOT change the adjustment or jumper the overloads. Damage to the motor can result from running the motor without adequate overload protection.

8.6.5.14.5 Pressure Switch. The pressure switch and its related circuits shall be tested for conformance with applicable requirements (3.26.8) (Item 2.37).

8.6.5.14.6 Power Operation of Door System. The closing forces and speed of power-operated hoistway door systems shall be tested to determine conformance with the applicable requirements (Item 1.8.2). For elevators required to comply with 2.13.4.2.4, the time in the door Code zone distance shall be measured and compared with the time specified on the data plate.

8.6.5.14.7 Slack-Rope Device. The slack-rope device shall be tested on a roped hydraulic elevator by causing a slack-rope condition to occur and verify that it will remove power in compliance with 3.18.1.2.5 (Item 3.31.2). (ED)

8.6.5.15 Periodic Test Requirements — Category 3

NOTE: For test frequency, see 8.11.1.3.

8.6.5.15.1 Unexposed Portions of Pistons. Piston rods of roped water-hydraulic elevators shall be exposed, thoroughly cleaned, and examined for wear or corrosion. The piston rods shall be replaced if at any place the diameter is less than the root diameter of the threads (Item 5.11).

8.6.5.15.2 Pressure Vessels. Pressure vessels shall be checked to determine conformance with the applicable requirements, thoroughly cleaned, internally examined, and then subjected to a hydrostatic test at 150% of the working pressure for 1 min (3.24.4) (Item 2.33).

8.6.5.16 Periodic Test Requirements — Category 5

NOTE: For test frequency, see 8.11.1.3.

8.6.5.16.1 Governors, safeties, and oil buffers, where provided, shall be inspected and tested as specified in 8.6.4.20.1, 8.6.4.20.2, and 8.6.4.20.3 at intervals specified by the authority having jurisdiction. Where activation is allowed or required both by overspeed and slack rope, the safety shall have both means of activation tested.

8.6.5.16.2 Coated ropes shall be required to have a magnetic flux test capable of detecting broken wires, in addition to a visual examination.

8.6.5.16.3 Wire rope fastenings shall be examined in accordance with Item 3.23 of A17.2. Fastenings on roped-hydraulic elevators utilizing pistons that are hidden by cylinder head seals shall also be examined, even if it is temporarily necessary to support the car by other means and disassemble the cylinder head.

8.6.5.16.4 A plunger gripper, where provided, shall be examined and tested per 8.10.3.2.5(n).

8.6.5.16.5 Overspeed valves, where provided, shall be inspected and tested to verify that they will stop the car, traveling down with rated load, within the specified limits of 3.19.4.7.5(a) using a written procedure supplied by the valve manufacturer or the person or firm maintaining the equipment. If the seal has been altered or broken, the overspeed valve shall be resealed after successful test (Item 5.15.2).

8.6.5.16.6 Freight elevators of Class C2 loading shall sustain and level the elevator car with the maximum load shown on the freight elevator loading sign (Item 2.17.2.2).

- (13) **8.6.5.17 Plunger Gripper.** Plunger grippers, where provided, shall be maintained in accordance with the manufacturer's recommendations.

8.6.6 Maintenance and Testing of Elevators With Other Types of Driving Machines

8.6.6.1 Rack-and-Pinion Elevators. The maintenance of rack-and-pinion elevators shall conform to 8.6.1 through 8.6.3 and the applicable requirements of 8.6. Where the car and/or counterweight safeties are sealed to prevent field adjustment and examination, they shall be returned to the manufacturer for replacement of components and calibration at the interval recommended by the manufacturer. A data plate shall be installed to show the date that the next maintenance/calibration is due.

- (13) **8.6.6.1.1 Rack-and-Pinion Elevator Periodic Test.** Rack-and-pinion elevators shall be subject to the applicable periodic tests specified in 8.6.4.19 and 8.6.4.20. The test requirements shall apply to the corresponding requirements of 4.1. Any additional requirements for this equipment shall also be checked during these tests.

8.6.6.2 Screw-Column Elevators. The maintenance of screw-column elevators shall conform to 8.6.1 through 8.6.3 and the applicable requirements of 8.6.

8.6.6.2.1 Screw-Column Elevator Periodic Test. Screw-column elevators shall be subject to the applicable periodic tests specified in 8.6.4.19, 8.6.4.20, and 8.6.5.14 through 8.6.5.16. The test requirements shall apply to the corresponding requirements of 4.2. Any additional requirements for this equipment shall also be checked during these tests.

8.6.6.3 Hand Elevators. The maintenance of hand elevators shall conform to 8.6.1 through 8.6.3 and the applicable requirements of 8.6.

8.6.6.3.1 Hand Elevator Periodic Test. Hand elevators shall be subject to the applicable periodic tests specified in 8.6.4.19 and 8.6.4.20. The test requirements shall apply to the corresponding requirements in 4.3. Any additional requirements for this equipment shall also be checked during these tests. The driving-machine brake required by 4.3.19.2 shall be tested with both empty car and rated load in the car.

8.6.7 Maintenance and Testing of Special Application Elevators

8.6.7.1 Inclined Elevators. The maintenance of inclined elevators shall conform to 8.6.1 through 8.6.3 and the applicable requirements of 8.6.

8.6.7.1.1 Periodic Test. Inclined elevators shall be subject to the applicable periodic tests specified in 8.6.4.19, 8.6.4.20, and 8.6.5.14 through 8.6.5.16. The test requirements shall apply to the corresponding requirements in 5.1. Any additional requirements for this equipment shall also be checked during these tests.

8.6.7.2 Limited-Use/Limited-Application Elevators. The maintenance of limited-use/limited-application elevators shall conform to 8.6.1 through 8.6.3 and the applicable requirements of 8.6.

8.6.7.2.1 Periodic Test. Limited-use/limited-applications elevators shall be subject to the applicable periodic tests specified in 8.6.4.19, 8.6.4.20, and 8.6.5.14 through 8.6.5.16. The test requirements shall apply to the corresponding requirements of 5.2. Any additional requirements for this equipment shall also be checked during these tests.

8.6.7.3 Private Residence Elevators. The maintenance of private residence elevators shall conform to 8.6.1 through 8.6.3 and the applicable requirements of 8.6.

8.6.7.3.1 Periodic Test. Private residence elevators and lifts should be subject to the periodic tests specified in 8.6.4.19, 8.6.4.20, and 8.6.5.14 through 8.6.5.16. The test requirements shall apply to the corresponding requirements in 5.3. Any additional requirements for this equipment should also be checked during these tests.

8.6.7.4 Private Residence Inclined Elevators. The maintenance of private residence inclined elevators shall conform to 8.6.1 through 8.6.3 and the applicable requirements of 8.6.

8.6.7.4.1 Periodic Test. Private residence inclined elevators and lifts should be subject to the periodic tests specified in 8.6.4.19, 8.6.4.20, and 8.6.5.14 through 8.6.5.16. The test requirements shall apply to the corresponding requirements in 5.4. Any additional requirements for this equipment should also be checked during these tests.

8.6.7.5 Power Sidewalk Elevators. The maintenance of power sidewalk elevators shall conform to 8.6.1 through 8.6.3 and the applicable requirements of 8.6.

8.6.7.5.1 Periodic Test. Sidewalk elevators shall be subject to the applicable periodic tests specified in 8.6.4.19, 8.6.4.20, and 8.6.5.14 through 8.6.5.16. The test requirements shall apply to the corresponding requirements in 5.5. Any additional requirements for this equipment shall also be checked during these tests.

8.6.7.6 Rooftop Elevators. The maintenance of rooftop elevators shall conform to 8.6.1 through 8.6.3 and the applicable requirements of 8.6.

8.6.7.6.1 Periodic Test. Rooftop elevators shall be subject to the applicable periodic tests specified in 8.6.4.19, 8.6.4.20, and 8.6.5.14 through 8.6.5.16. The test requirements shall apply to the corresponding requirements of 5.6. Any additional requirements for this equipment shall also be checked during these tests.

8.6.7.7 Special Purpose Personnel Elevators. Except in jurisdictions enforcing NBCC, maintenance of special purpose personnel elevators shall conform to 8.6.1 through 8.6.3 and the applicable requirements of 8.6 (see Section 5.7).

8.6.7.7.1 Periodic Test. Special purpose personnel elevators shall be subject to the applicable tests specified in 8.6.4.19, 8.6.4.20, and 8.6.5.14 through 8.6.5.16. The test requirements shall apply to the corresponding requirements in 5.7. Any additional requirements for this equipment shall also be checked during these tests.

8.6.7.8 Shipboard Elevators. The maintenance of shipboard elevators shall conform to 8.6.1 through 8.6.3 and the applicable requirements of 8.6.

8.6.7.8.1 Periodic Test. Shipboard elevators shall be subject to the applicable periodic tests specified in 8.6.4.19, 8.6.4.20, and 8.6.5.14 through 8.6.5.16. The test requirements shall apply to the corresponding requirements of 5.8. Any additional requirements for this equipment shall also be checked during these tests.

8.6.7.9 Mine Elevators. Except in jurisdictions enforcing NBCC, maintenance of mine elevators shall conform to 8.6.7.9.1 through 8.6.7.9.5. (ED)

8.6.7.9.1 Rails on mine elevators shall be kept free of rust and scale, that will prevent proper operation of the car (or counterweight) safety device.

8.6.7.9.2 Oil buffers that are installed on elevators where water can accumulate in the pit shall be checked every 60 days for accumulation of water.

8.6.7.9.3 The mine elevator hoistway shall be maintained to minimize the entry of water and formation of ice, that would interfere with the operation of the elevator.

8.6.7.9.4 Suspension, Compensating, and Governor Ropes. When elevator suspension, compensating, or governor ropes show deterioration caused by corrosion, the replacement wire ropes shall be constructed of electrogalvanized or other types of corrosion resistant material suitable for the environment and application. The installation shall conform to 8.7.2.21 for suspension ropes and 8.7.2.19 for governor ropes.

Where emergency replacement of wire ropes is required, noncorrosion resistant wire ropes shall be permitted to be installed for temporary use. These emergency replacement noncorrosion resistant wire ropes shall be replaced by corrosion resistant wire ropes within one year of installation.

8.6.7.9.5 Periodic Test. Mine elevators shall be subject to the applicable periodic tests specified in 8.6.4.19, 8.6.4.20, and 8.6.5.14 through 8.6.5.16. The test requirements shall apply to the corresponding requirements of 5.9. Any additional requirements for this equipment shall also be checked during these tests.

8.6.7.10 Elevators Used for Construction. The maintenance of elevators used for construction shall conform to 8.6.1 through 8.6.3 and the applicable requirements of 8.6.

8.6.7.10.1 Periodic Test Requirements — Category 1. For electric elevators, test as specified in 8.6.4.19.1 through 8.6.4.19.5. For hydraulic elevators, test as specified in 8.6.5.14.1, 8.6.5.14.2, 8.6.5.14.3(a) through (d), and 8.6.5.14.4.

Where permanent doors have been installed, test as specified in 8.6.4.19.8.

8.6.7.10.2 Periodic Test Requirements — Category 3. For hydraulic elevators, test as specified in 8.6.5.15.

8.6.7.10.3 Periodic Test Requirements — Category 5. For electric elevators, test as specified in 8.6.4.20.1 through 8.6.4.20.4, and 8.6.4.20.6. For hydraulic elevators, test as specified in 8.6.5.16.

- (13) **8.6.7.11 Wind Turbine Tower Elevator.** The maintenance of wind turbine tower elevators shall conform to the applicable requirements of 8.6.7.11.1 through 8.6.7.11.3.

8.6.7.11.1 Periodic Test Requirements. Wire rope gripping safeties with slack rope actuation, or wire rope gripping safeties with an internal centrifugal governor, shall be tested with rated load in the car. Tests for governor-operated safeties shall be made by manually tripping the governor at the rated speed. The overspeed switch on the governor shall be made ineffective during the test.

8.6.7.11.2 Wind Turbine Tower Elevators. The maintenance of wind turbine tower elevators shall conform to 8.6.1 through 8.6.3 and the applicable requirements of 8.6.

8.6.7.11.3 Car and Counterweight Safeties. Types A, B, and C car safeties except those operating on wood guide rails, and their governors, wire rope gripping safeties with slack rope actuation, or wire rope gripping safeties with an internal centrifugal governor shall be tested with rated load in the car. Counterweight safety tests shall be made with no load in the car. Tests for governor operated safeties shall be made by manually tripping the governor at the rated speed. The overspeed switch on the governor shall be made ineffective during the test. Type A safeties and wire rope gripping safeties without governors that are operated as a result of the breaking or slackening of the hoisting ropes shall be tested by obtaining the necessary slack rope to cause it to function (Item 2.29.2.1) and hold the car with rated load. The following operational conditions shall be checked (Item 2.29.2.1).

- (13) **8.6.7.12 Outside Emergency Elevators.** The maintenance, repair, and replacement of outside emergency elevators shall conform to 8.6.1 through 8.6.3 and ASME A17.7/CSA B44.7, Requirement 2.12.2.

8.6.7.12.1 Periodic Test Requirements — Category 1. Outside emergency elevators shall be subject to applicable periodic tests specified in 8.6.4.19.1 through 8.6.4.19.5, 8.6.4.19.7, 8.6.4.19.8, 8.6.4.19.10, and ASME A17.7/CSA B44.7, Requirement 2.12.3. Outside emergency elevators are not required to be powered by electric driving-machine motors.

8.6.7.12.2 Periodic Test Requirements — Category 5. Outside emergency elevators shall be subject to applicable periodic tests specified in 8.6.4.20.1 through 8.6.4.20.11 and ASME A17.7/CSA B44.7, requirement 2.12.3. Outside emergency elevators are not required to be powered by electric driving-machine motors.

8.6.8 Maintenance and Testing of Escalators and Moving Walks

The maintenance of escalators shall conform to 8.6.1 through 8.6.3 and 8.6.8.

8.6.8.1 Handrails. Handrails shall operate at the speed specified in the applicable codes. The handrail speed monitoring device, when provided, shall cause electric power to be removed from the driving-machine motor and brake when the speed of either handrail deviates from the step speed by 15% or more and continuously within a 2 s to 6 s range. Cracked or damaged handrails that present a pinching effect shall be repaired or replaced. Splicing of handrails shall be done in such a manner that the joint is free of pinching effect.

8.6.8.2 Step-to-Skirt Clearance. Clearances shall be maintained in compliance with the applicable codes. Alternatively, the clearance on either side of the steps and between the steps and the adjacent skirt guard shall not exceed 4 mm (0.16 in.) and the sum of the clearances on both sides shall not exceed 7 mm (0.28 in.).

NOTE: The allowable clearances are applicable as follows:

(a) ASME A17.1-1955 through A17.1d-1970; not more than 4.8 mm (0.1875 in.) with a total of both sides not more than 6.4 mm (0.25 in.), except where skirt obstruction devices are installed at the lower entrance for escalators installed under the ASME A17.1-1965 through A17.1d-1970.

(b) ASME A17.1-1971 through A17.1-1979 editions: not more than 9.5 mm (0.375 in.) on each side.

(c) ASME A17.1-1980 through A17.1c-1999 and ASME A17.3: not more than 4.8 mm (0.1875 in.) on each side.

(d) For equipment installed under ASME A17.1d-2000 and later editions, the clearance (loaded gap) not more than 5 mm (0.2 in.) when 110 N (25 lbf) force is laterally applied from the step to the adjacent skirt panel. See 6.1.3.3.5.

NOTE (on CSA B44 Requirements): The allowable clearances are applicable as follows:

(a) B44-1960 through B44S3-1982 — not more than 4.8 mm (0.1875 in.) on each side. Sum of both sides not more than 6.4 mm (0.25 in.).

(b) B44-1985 through B44S2-1998 — Not more than 5 mm (0.197 in.) on each side. Sum of both sides not more than 6 mm (0.236 in.).

(c) For equipment installed under CSA B44-00 — not more than 4 mm (0.157 in.) on each side. Sum of both sides not more than 7 mm (0.28 in.).

(d) For equipment installed under CSA B44-00 Update 1 and later editions — clearance (loaded gap) shall be not more than 5 mm (0.2 in.) when 110 N (25 lbf) force is laterally applied from the step to the adjacent skirt panel. See 6.1.3.3.5.

8.6.8.3 Step/Skirt Performance Index

8.6.8.3.1 The step/skirt performance index, when the escalator is subjected to the test specified in 8.6.8.15.19, shall be the maximum value of the recorded instantaneous step/skirt index $e^y/(e^y + 1)$, where

(SI Units)

$$e = 2.7183$$

$$y = -3.77 + 2.37 (\mu) + 0.37 (L_g)$$

μ = the sliding coefficient of friction of a polycarbonate test specimen on the skirt panel at the measurement point calculated when subjected to a 110 N normal load. The coefficient of friction shall be measured without addition of any field-applied lubricant.

L_g = the clearance between the step and the adjacent skirt panel when 110 N is applied from the step to skirt panel, mm

The applied load shall not deviate from 110 N by more than ± 11 N. The load shall be distributed over a round or square area not less than 1 940 mm² and not more than 3 870 mm².

(Imperial Units)

$$e = 2.7183$$

$$y = -3.77 + 2.37 (\mu) + 9.3 (L_g)$$

μ = the sliding coefficient of friction of a polycarbonate test specimen on the skirt panel at the measurement point calculated when subjected to a 25 lbf normal load. The coefficient of friction shall be measured without addition of any field-applied lubricant.

L_g = the clearance between the step and the adjacent skirt panel when 25 lbf is applied from the step to skirt panel, in.

The applied load shall not deviate from 25 lbf by more than ± 2.5 lbf. The load shall be distributed over a round or square area not less than 3 in.² and not more than 6 in.²

8.6.8.3.2 The step/skirt performance index polycarbonate test specimen shall conform to the following specifications:

- (a) Material: Polycarbonate without fillers
- (b) Color: Natural, no pigments
- (c) Finish: Glossy (roughness less than 0.8 μ m (32 μ in.))
- (d) Area in contact with skirt panel: 2 900 \pm 325 mm² (4.5 \pm 0.5 in.²) and at least 0.8 mm (0.03 in.) thick
- (e) Specification: GE Lexan 100 series or equivalent polycarbonate

8.6.8.3.3 The escalator step/skirt performance index shall be one of the following, whichever is applicable:

- (a) ≤ 0.15
- (b) ≤ 0.25 for escalators installed under ASME A17.1a-2002/CSA B44-00 Update 1 and later editions and when a skirt deflector device complying with the requirements of 6.1.3.3.7 is provided
- (c) ≤ 0.4 for escalators installed under ASME A17.1-2000/CSA B44-00 and earlier editions and a skirt deflector device is provided

8.6.8.4 Combplates

8.6.8.4.1 Combs with any broken teeth shall be repaired or replaced. Where two adjacent teeth are missing, the escalator shall be removed from operation.

8.6.8.4.2 Combs shall be adjusted and maintained in mesh with the slots in the step surface so that the points of the teeth are always below the upper surface of the treads.

8.6.8.4.3 For units installed under A17.1b-1992 and later editions of the Code, comb-step impact devices shall be adjusted to operate in compliance with the forces specified in 6.1.6.3.13.

8.6.8.5 Escalator Skirt Panels and Skirt Obstruction Devices (13)

(a) Damaged skirt or dynamic skirt panels shall be replaced or repaired and the installation shall conform to 8.6.8.2 and 8.6.8.3.3.

(b) The skirt obstruction devices shall be checked for proper adjustment and operation.

8.6.8.6 Steps

8.6.8.6.1 Steps with broken treads shall be repaired or replaced.

8.6.8.6.2 Steps with dented or damaged risers shall be repaired or replaced.

8.6.8.6.3 Steps that are worn or damaged and that do not provide proper engagement with the combplates shall be repaired or replaced.

8.6.8.6.4 The width or depth of the slots in the tread surface of steps that do not meet the applicable Code requirements shall be repaired or replaced.

8.6.8.7 Rollers, Tracks, and Chains. Rollers, tracks, and chains shall be examined, repaired, or replaced when necessary to ensure required clearances.

8.6.8.8 Signs. Caution signs shall be provided in compliance with 6.1.6.9. Damaged or missing signs shall be replaced. Additional signs, if provided, shall comply with 6.1.6.9.

8.6.8.9 Guards at Ceiling Intersections. Damaged or missing guards shall be repaired or replaced in compliance with 6.1.3.3.11.

8.6.8.10 Antislid Devices. Damaged or missing antislid devices shall be repaired or replaced.

8.6.8.11 Handrail Guards. Damaged or missing hand or finger guards shall be repaired or replaced.

8.6.8.12 Brakes. Brakes shall be maintained in compliance with the applicable requirements of 8.6.4.6, and adjusted to the torque shown on the data plate, where provided.

8.6.8.13 Cleaning. The interiors of escalators and their components shall be cleaned to prevent an accumulation of oil, grease, lint, dirt, and refuse. The frequency of the cleaning will depend on service and conditions, but an examination to determine if cleaning is necessary shall be required at least once a year.

8.6.8.14 Entrance and Egress Ends. Escalator landing plates shall be properly secured in place. Landing plates shall be kept free of tripping hazards and maintained to provide a secure foothold. All required entrance and exit safety zones shall be kept free from obstructions.

8.6.8.15 Periodic Test Requirements — Category 1

NOTE: For test frequency, see 8.11.1.3.

8.6.8.15.1 Machine Space. The machine space access, lighting, receptacles, operation, and conditions shall be examined (Items 8.1 and 10.1).

All escalator components shall be cleaned and examined. These components shall include, but not be limited to

- (a) oil drip pans
- (b) upper and lower stations
- (c) steps and rollers
- (d) step frames, risers, and treads
- (e) tracks
- (f) truss components

8.6.8.15.2 Stop Switch. The machine space stop switches shall be tested (Items 8.2 and 10.2).

8.6.8.15.3 Controller and Wiring. Controller and wiring shall be examined (Items 8.3 and 10.3).

8.6.8.15.4 Drive Machine and Brake. The drive machine and brakes shall be examined and tested, including test of the brake torque (Items 8.4 and 10.4).

8.6.8.15.5 Speed Governor. The mechanical speed governor, if required, shall be tested by manually operating the trip mechanism (Items 8.5 and 10.5).

8.6.8.15.6 Broken Drive-Chain Device. Operation of the broken drive-chain device, on the drive chain, shall be tested by manually operating the actuating mechanism (Items 8.6 and 10.6).

8.6.8.15.7 Reversal Stop Switch. The reversal stop switch (to prevent reversal when operating in the ascending direction) shall be tested by manually operating it to determine that it functions properly (Items 8.7 and 10.7).

If the device cannot be manually operated, the person or firm maintaining the equipment shall provide a written checkout procedure and demonstrate the device complies with the requirements of the Code.

8.6.8.15.8 Broken Step-Chain or Treadway Device. The broken or slack step-chain or treadway device shall be tested by manual operation (Items 8.8 and 10.8).

8.6.8.15.9 Step Upthrust Device. The operation of the step upthrust device shall be tested by manually displacing the step, causing the device to operate (Items 7.9 and 8.9).

8.6.8.15.10 Missing Step or Pallet Device. The missing step or pallet device shall be tested by removing a step or pallet and verifying that the device will properly function (Items 8.10 and 10.10).

8.6.8.15.11 Step or Pallet Level Device. The step, or pallet level device shall be tested by simulating an out of level step or pallet and verifying that the device functions properly (Items 8.11 and 10.11).

8.6.8.15.12 Steps, Pallet, Step or Pallet Chain, and Trusses. The steps, pallet, step or pallet chain, and trusses shall be visually examined for structural defects, mechanical condition, and buildup of combustible materials (Items 8.12 and 10.12).

8.6.8.15.13 Handrail Safety Systems. The handrail operating system shall be visually examined for condition. The handrail entry device, and the stopped handrail or handrail speed monitoring device, shall be tested by disconnecting of handrail motion sensor (Items 8.13 and 10.13).

The person or firm maintaining the equipment shall provide a written checkout procedure and demonstrate that the handrail speed does not change when a retarding force, up to the maximum required by code, is applied opposite to the direction of travel (Items 7.3 and 9.3).

8.6.8.15.14 For outdoor escalators and moving walks that require heaters, test the heaters for condition and operation (Items 8.3 and 10.3).

8.6.8.15.15 Permissible Stretch in Escalator Chains. Escalators shall have periodic examination of the clearance between successive steps to detect wear or stretch of the step chains. The clearance shall not exceed 6 mm (0.25 in.) (Item 7.9).

8.6.8.15.16 Disconnected Motor Safety Device. Operation of the device shall be tested and verified (see 6.1.6.3.10 or 6.2.6.3.8) (Item 8.6 or 10.6).

8.6.8.15.17 Response to Smoke Detectors (6.1.6.8 or 6.2.6.7) (Items 8.15 and 10.15)

8.6.8.15.18 Comb-Step or Comb-Pallet Impact Device. For escalator or moving walks required to comply with Rules 805.1u, 805.3n, 905.1r, or 905.3k in A17.1d-2000 or earlier editions, or requirements 6.1.6.3.13 or 6.2.6.3.11, the comb-step/pallet-impact devices shall be tested in both the vertical and horizontal directions by placing a vertical and horizontal force on the combplate to cause operation of the device. The vertical and horizontal tests shall be independent of each other. The horizontal force shall be applied at the front

edge center and both sides; the force shall be applied in the direction of travel into the combplate. The vertical force shall be applied at the front edge center. Both the vertical and horizontal forces required to operate the device shall be recorded (6.1.6.3.13 and 6.2.6.3.11; Items 7.7.2 and 9.7.2).

See 8.6.9.2.3 for horizontal forces required.

8.6.8.15.19 Step/Skirt Performance Index

(a) The escalator skirt shall not be cleaned, lubricated, or otherwise modified in preparation for testing. The escalator instantaneous step/skirt index measurements [6.1.3.3.9(a)] shall be recorded at intervals no larger than 150 mm (6 in.) from each side of two distinct steps along the inclined portion of the escalator, where the steps are fully extended. Test steps shall be separated by a minimum of 8 steps.

(b) A load of 110 N (25 lbf) shall be laterally applied from the step to the adjacent skirt panel. The applied load shall not deviate from 110 N (25 lbf) by more than ± 11 N (2.5 lbf). The load shall be distributed over a round or square area not less than 1 940 mm² (3 in.²) and not more than 3 870 mm² (6 in.²).

(c) No vertical load exceeding 220 N (50 lbf) shall be applied to the test step and adjacent steps.

(d) The coefficient of friction shall be measured with the test specimen conforming to the requirements of 8.6.8.3.2 sliding in the direction of the step motion under a 110 N (25 lbf) normal force at the operating speed of the escalator and shall be measured with devices having sensitivity better than ± 2.2 N (0.5 lbf). The direction of step motion shall be the direction of normal operation. If the escalator is operated in both directions, the down direction shall be used for the test.

(e) For both the coefficient of friction measurement and the loaded gap measurements, the center of the applied load shall be between 25 mm (1 in.) and 100 mm (4 in.) below the nose line of the steps. The center of the applied load shall be not more than 250 mm (10 in.) from the nose of the step. See Fig. 8.6.8.15.19(e).

(f) The step/skirt performance index shall conform to the requirements in 8.6.8.3 or A17.3, Requirement 5.1.11 (Item 7.17).

8.6.8.15.20 Clearance Between Step and Skirt (Loaded Gap). Escalators installed under ASME A17.1d-2000 shall be tested as follows (Item 7.17):

(a) Loaded gap measurements shall be taken at intervals not exceeding 300 mm (12 in.) in transition region (6.1.3.6.5) and before the steps are fully extended. These measurements shall be made independently on each side of the escalator.

(b) The applied load shall not deviate from 110 N (25 lbf) by more than ± 11 N (2.5 lbf) (6.1.3.3.5). The load shall be distributed over a round or square area no less than 1 940 mm² (3 in.²) and no more than 3 870 mm² (6 in.²).

Fig. 8.6.8.15.19(e)

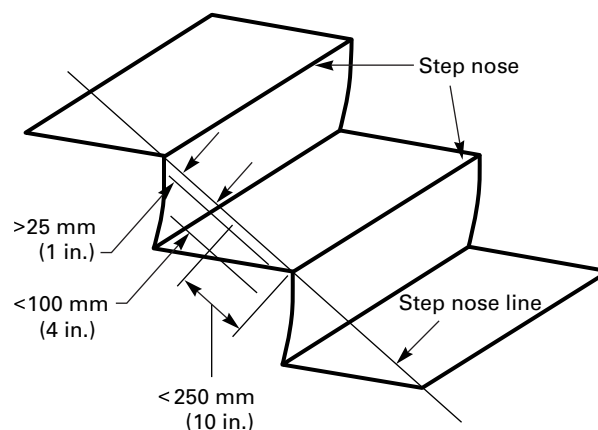

(c) For the loaded gap measurements, the center of the applied load shall be between 25 mm (1 in.) and 100 mm (4 in.) below the nose line of the steps. The center of the applied load shall be not more than 250 mm (10 in.) from the nose of the step. See Fig. 8.6.8.15.19(e).

8.6.8.15.21 Inspection control devices shall be tested and inspected to determine conformance with the requirements of 6.1.6.2.2 for escalators and 6.2.6.2.2 for moving walks.

8.6.8.15.22 Step Lateral Displacement Device (6.1.6.3.14). For curved escalators, manually test the device.

8.6.8.15.23 Seismic Risk Zones 2 or Greater. Verify that operation of the seismic switch complies with requirements of 8.5.4 (Items 7.20.2 and 9.20.2).

8.6.8.15.24 Maintenance of Seismic Devices. A seismic switch, where provided, shall be maintained in accordance with the manufacturer's recommendations. (13)

8.6.9 Maintenance of Moving Walks

The maintenance of moving walks shall conform to 8.6.1 through 8.6.3 and 8.6.9.

8.6.9.1 Handrails. Handrails shall operate at the speed specified in applicable codes. The handrail speed monitoring device, when provided, shall cause electric power to be removed from the driving-machine motor and brake when the speed of either handrail deviates from the treadway by 15% or more and continuously within a 2 s to 6 s range. Cracked or damaged handrails that present a pinching effect shall be repaired or replaced. Splicing of handrails shall be done in such a manner that the joint is free of pinching effect.

8.6.9.2 Combplates

8.6.9.2.1 Combs with any broken teeth shall be repaired or replaced.

8.6.9.2.2 Combs shall be adjusted and maintained in mesh with the slots in the treadway surface so that the points of the teeth are always below the upper surface of the treads.

8.6.9.2.3 For units installed under A17.1b-1992 and later editions of the Code, comb-pallet impact devices shall be adjusted to operate in compliance with the forces specified in 6.2.6.3.11.

8.6.9.3 Pallets

8.6.9.3.1 Pallets with broken treads shall be repaired or replaced.

8.6.9.3.2 Intermeshing moving walk pallets that are damaged at the mesh shall be repaired or replaced.

8.6.9.3.3 Pallets that are worn or damaged and that do not provide proper engagement with the combplates shall be repaired or replaced.

8.6.9.3.4 The width or depth of the slots in the tread surface of pallets that do not meet the applicable Code requirements shall be repaired or replaced.

8.6.9.4 Rollers, Tracks, and Chains. Rollers, tracks, and chains shall be examined, repaired, or replaced when necessary to ensure required clearances.

8.6.9.5 Belt-Type Treadway. Belt-type treadways that are damaged or worn in such a manner that the treadway does not provide a continuous unbroken treadway surface or proper engagement with the combplates shall be repaired or replaced.

8.6.9.6 Signs. Caution signs shall be provided in compliance with 6.2.6.8. Damaged or missing signs shall be replaced. Additional signs, if provided, shall comply with 6.2.6.8.

8.6.9.7 Guards at Ceiling Intersections. Damaged or missing guards shall be repaired or replaced in compliance with 6.2.3.3.7.

8.6.9.8 Antislid e Devices. Damaged or missing antislid e devices shall be repaired or replaced.

8.6.9.9 Handrail Guards. Damaged or missing hand or finger guards shall be repaired or replaced.

8.6.9.10 Brakes. Brakes shall be maintained in compliance with the applicable requirements of 8.6.4.6, and adjusted to the torque shown on the data plate, where provided.

8.6.9.11 Cleaning. The interiors of moving walks, and their components shall be cleaned to prevent an accumulation of oil, grease, lint, dirt, and refuse. The frequency of the cleaning will depend on service and conditions, but an examination to determine if cleaning is necessary shall be required at least once a year.

8.6.9.12 Entrance and Egress Ends. Moving walk landing plates shall be properly secured in place. Landing plates shall be kept free of tripping hazards and maintained to provide a secure foothold. All required entrance and exit safety zones shall be kept free from obstructions.

8.6.9.13 Clearances. The clearance between each side of the treadway and the adjacent skirt panels, when provided, shall be maintained in compliance with 6.2.3.3.6. The clearance between the top surface of the treadway and the underside of the balustrade shall be maintained in compliance with 6.2.3.3.5 for skirtless balustrades.

8.6.10 Maintenance and Testing of Dumbwaiters and Material Lifts

8.6.10.1 Material Lifts and Dumbwaiters Without Automatic Transfer Devices. The maintenance of material lifts and dumbwaiters without automatic transfer devices shall conform to 8.6.1 through 8.6.3 and the applicable requirements of 8.6.

8.6.10.1.1 Periodic Test. Dumbwaiters shall be subject to the applicable periodic tests specified in 8.6.4.19 and 8.6.5.14. The test requirements shall apply to the corresponding requirements in Part 7. Any additional requirements for this equipment shall also be checked during these tests.

On winding drum machines, the slack-rope devices required by 2.26.2.1 shall be permitted to be tested as specified in Item 2.18. The driving-machine brake shall be tested to determine conformance with 7.2.10 (Item 2.18).

8.6.10.2 Material Lifts and Dumbwaiters With Automatic Transfer Devices. The maintenance of material lifts and dumbwaiters with automatic transfer devices shall conform to 8.6.1 through 8.6.3 and the applicable requirements of 8.6.

8.6.10.2.1 Periodic Test. Material lifts and dumbwaiters with automatic transfer devices shall be subject to the applicable periodic tests specified in 8.6.4.19 and 8.6.5.14. The test requirements shall apply to the corresponding requirements in Part 7. Any additional requirements for this equipment shall also be checked during these tests.

8.6.11 Special Provisions

8.6.11.1 Firefighters' Emergency Operation. All elevators provided with firefighters' emergency operation shall be subjected monthly, by authorized personnel, to Phase I recall by use of the key switch, and a minimum of one-floor operation on Phase II, except in jurisdictions enforcing the NBCC. Deficiencies shall be corrected. A record of findings shall be available to elevator personnel and the authority having jurisdiction.

8.6.11.2 Two-Way Communications Means. The two-way communications means shall be checked annually by authorized personnel in accordance with the following:

(a) Two-way communications means shall be checked to verify that two-way communications is established; or

(b) All elevators installed under ASME A17.1a-2002/CSA B44-00 Update 1 and later editions shall have the two-way communications means checked by pressing the "HELP" button in the car to verify that the visual indicator [2.27.1.1.3(c)] is functional and that the answering authorized personnel can receive the building location and elevator number [2.27.1.1.3(d)]; and

(c) Where communications from the building into the elevator is provided, check the two-way communications means to each car.

8.6.11.3 Access Keys. Keys required for access, operation, inspection, maintenance, repair, and emergency access shall be made available only to personnel in the assigned security level, in accordance with 8.1.

8.6.11.4 Cleaning of a Car and Hoistway Transparent Enclosure

8.6.11.4.1 The cleaning of the exterior of transparent car enclosures or transparent hoistway enclosures from inside the hoistway shall be performed only by authorized personnel (see 1.3) trained in compliance with the procedures specified in 8.6.11.4.2 and 8.6.11.4.3.

8.6.11.4.2 A written cleaning procedure shall be made and kept on the premises where the elevator is located and shall be available to the authority having jurisdiction.

8.6.11.4.3 The procedure shall identify the hazards and detail the safety precautions to be utilized.

8.6.11.4.4 All personnel assigned to cleaning shall be given a copy of these procedures and all necessary training to assure that they understand and comply with the procedures.

8.6.11.4.5 A record of authorized personnel trained as specified in 8.6.11.4.4 shall be kept on the premises where the elevator is located and shall be available to the authority having jurisdiction.

8.6.11.5 Emergency Evacuation Procedures for Elevators

8.6.11.5.1 The evacuation of passengers from stalled elevators shall be performed only by authorized, elevator and emergency personnel (see 1.3) in compliance with the procedures specified in 8.6.11.5.2 through 8.6.11.5.6.

8.6.11.5.2 A written emergency evacuation procedure shall be made and kept on the premises where an elevator is located.

8.6.11.5.3 The procedure shall identify the hazards. The procedure shall also detail the safety precautions utilized in evacuating passengers from a stalled elevator.

8.6.11.5.4 All authorized personnel who are assigned to assist in evacuating passengers from a stalled elevator, and all persons who use special purpose personnel elevators and wind turbine tower elevators, shall be given a copy of these procedures and all necessary training to assure that they understand and comply with the procedures. (13)

8.6.11.5.5 These procedures shall be available to authorized elevator and emergency personnel.

8.6.11.5.6 A record of authorized personnel trained, and all persons who use special purpose personnel elevators, as specified in 8.6.11.5.4, shall be kept on the premises where the elevator is located and shall be available to the authority having jurisdiction.

NOTE (8.6.11.5): See ASME A17.4, *Guide for Emergency Personnel*.

8.6.11.6 Escalators and Moving Walks Startup and Procedures (13)

8.6.11.6.1 (13)

(a) Escalators and moving walks shall be started only by authorized personnel (see 1.3) trained in compliance with the procedures specified in 8.6.11.5.2 through 8.6.11.5.5.

(b) Stopped escalators shall not be used as a means of access or egress by non-authorized personnel and shall be properly barricaded if accessible to the general public to prevent such use.

NOTE: Proper barricades are described in the Elevator Industry Field Employee Safety Handbook — Escalator/Moving Walk Barricades.

8.6.11.6.2 The following procedure shall be utilized when starting an escalator or moving walk:

(a) Prior to starting the unit, observe the steps or pallets and both landing areas to ensure no persons are on the unit or about to board. Run the unit away from the landing.

(b) Verify correct operation of the starting switch.

(c) Verify correct operation of the stop buttons.

(d) Verify correct operation of each stop button cover alarm, if furnished.

(e) Visually examine the steps or treadway for damaged or missing components; combplates for broken or missing teeth; skirt or dynamic skirt panels and balustrades for damage.

(f) Verify that both handrails travel at substantially the same speed as the steps or the treadway, are free from damage or pinch points, and that entry guards are in place.

(g) Visually verify that all steps, pallets, or the treadway is properly positioned.

(h) Verify that ceiling intersection guards, anti-slide devices, deck barricades, and caution signs are securely in place.

(i) Verify that demarcation lighting is illuminated, if furnished.

(j) Check for uniform lighting on steps/tread not contrasting with surrounding areas.

(k) Verify that the safety zone is clear of obstacles and that the landing area and adjacent floor area are free from foreign matter and slipping or tripping hazards.

(l) Check for any unusual noise or vibration during operation.

If any of these conditions is unsatisfactory in 8.6.11.6.2(a) through (l), the unit shall be placed out of service. Barricade the landing areas and notify the responsible party of the problem.

8.6.11.6.3 Escalators and moving walks subject to 24-h operation shall be checked daily by authorized personnel.

8.6.11.6.4 A record of authorized personnel trained as specified in 8.6.11.6.2 shall be kept on the premises where the escalator(s) or moving walk(s) or both is located and shall be available to the authority having jurisdiction.

8.6.11.7 Operating Instructions for Means Specified in 2.7.5.1.1 or 2.7.5.2.1. A written procedure for operating the means shall be posted in a permanent manner in plain view at an appropriate location on or adjacent to the means (see 2.7.5.1.1 or 2.7.5.2.1). The posting shall conform to ANSI Z535.4 or CAN/CSA Z321, whichever is applicable (see Part 9).

8.6.11.8 Egress and Reentry Procedure From Working Areas in 2.7.5.1.3 or 2.7.5.2.3. A written procedure to outline the method for egress and reentry shall be posted in a permanent manner in plain view at an appropriate location at the egress/reentry point (see 2.7.5.1.3 or 2.7.5.2.3). The posting shall conform to ANSI Z535.4 or CAN/CSA Z321, whichever is applicable (see Part 9).

8.6.11.9 Operating Instructions for Retractable Platforms. A written procedure to outline the method for the use of retractable platforms shall be posted in a permanent manner in plain view at an appropriate location on or adjacent to the retractable platform (see 2.7.5.3.1). The posting shall conform to ANSI Z535.4 or CAN/CSA Z321, whichever is applicable (see Part 9).

(13) **8.6.11.10 Category 5 Tests Without Load Via Alternative Test Methodologies**

8.6.11.10.1 Where Permitted. Alternative test methods without load are permitted for Category 5 testing subject to approval by the authority having jurisdiction of

- (a) car and counterweight safeties per 8.6.4.20.1
- (b) oil buffers per 8.6.4.20.3

- (c) driving-machine brakes per 8.6.4.20.4, and
- (d) braking system, traction, and traction limits per 8.6.4.20.10

NOTE: See 8.10, Note (2).

8.6.11.10.2 Alternative Test Method and Tools

- (a) An alternative test method shall be
 - (1) based on sound engineering principles
 - (2) validated and documented via engineering tests
- (b) The method, measuring devices, and tools shall be capable of producing reliable and consistent measurements, suitable for the intended measurement. The monitoring and calibration of the measuring devices or tools shall be in accordance with the provider's guidelines.

8.6.11.10.3 Alternative Test Method Procedure.

The alternative test method shall

- (a) include requirements to obtain and verify car and counterweight masses if necessary for the test
- (b) have a procedure document that
 - (1) defines the permissible equipment range and limitations regarding use
 - (2) establishes monitoring and calibration criteria for tools or measuring devices as appropriate
 - (3) defines the test set-up procedure
 - (4) provides instructions on how to interpret results and correlate the results to pass-fail criteria
- (c) describe how to correlate no load test results with previously acquired full load and no load results
- (d) be included in the maintenance control program [see 8.6.1.2.1(a)]
- (e) include the information required by 8.6.1.2.1(f) where applicable, and
- (f) require a report conforming to 8.6.11.10.4

8.6.11.10.4 Alternative Test Method Report. The alternative test method report shall

- (a) identify the alternative test tool (make/model) used to perform the test
- (b) identify the company performing the tests, names of personnel conducting and witnessing the tests, and testing dates
- (c) contain all required printouts or record of tests required to demonstrate compliance to the testing requirement that were gathered during an acceptance test
- (d) identify which results from the baseline test are to be used for future compliance evaluation
- (e) record the car and counterweight masses that were obtained per 8.6.11.10.3(a) during the acceptance test and during any subsequent Category 5 test if required by test method
- (f) contain all subsequent Category 5 results with pass-fail conclusions regarding Code compliance
- (g) remain on site or shall be available to elevator personnel and the authority having jurisdiction

- (13) **8.6.11.11 Examination After Shutdown Due to Traction Loss.** Where the traction-loss detection means has been actuated [see 2.20.8.1 and 8.6.1.2.1(g)], the elevator shall not be returned to service until a physical examination of the drive sheave and suspension means has been conducted. The elevator shall not be moved until all passengers are out of the elevator and the elevator is posted out-of-service. In addition to the suspension-means evaluation criteria in 8.11.2.1.3(cc), any suspension-means or drive-sheave condition that would adversely affect the traction capability of the system (see 2.24.2.3) shall be corrected before returning the elevator to service.

NOTE: See lockout/tagout procedures in *Elevator Industry Field Employees' Safety Handbook* for procedure for removing the elevator from service.

- (13) **8.6.11.12 Examination After Safety Application.** After any safety application on a traction elevator has occurred, whether due to testing or during normal service, the driving-machine sheave, all other sheaves, where furnished, and retainers and suspension members shall be examined throughout their complete length to ensure that all suspension members are properly seated in their respective sheaves, and that no damage has occurred to sheaves, suspension members, or retainers. The elevator shall not be returned to service until this physical examination has been conducted and any repairs made, if necessary.
- (13) **8.6.11.13 Occupant Evacuation Operation.** All elevators provided with Occupant Evacuation Operation shall be subjected, by authorized personnel, to a check of the operation in conjunction with the fire alarm system testing in accordance with the requirements of NFPA 72. Deficiencies shall be corrected. A record of findings shall be available to elevator personnel and the authority having jurisdiction.
- (13) **8.6.11.14 Examination After Shutdown Due to Broken-Suspension-Member Detection Means.** After any application of the broken-suspension-member detection means, whether due to testing or during normal service, the driving-machine sheave, all other sheaves, where furnished, and retainers and suspension members shall be examined throughout their complete length to ensure that all suspension members are properly seated in their respective sheaves, and that no damage has occurred to sheaves, suspension members, or retainers. The elevator shall not be returned to service until this physical examination has been conducted and any repairs made, if necessary. Where a single suspension member has been damaged or broken, the entire suspension means shall be replaced in accordance with 8.6.3.2.

SECTION 8.7 ALTERATIONS

Requirement 8.7 applies to alterations.

NOTES:

- (1) See Nonmandatory Appendix L for an index of the requirements for alterations.
- (2) See 8.6 for maintenance, repair, and replacement requirements.

8.7.1 General Requirements

8.7.1.1 Applicability of Alteration Requirements.

When any alteration is performed, regardless of any other requirements of 8.7, the installation, as a minimum, shall conform to the following applicable Code requirements:

- (a) the Code at the time of installation
- (b) the Code requirements for the alteration at the time of any alteration
- (c) ASME A17.3 if adopted by the authority having jurisdiction

8.7.1.2 Items Not Covered in 8.7. Where an alteration not specifically covered in 8.7 is made, it shall not diminish the level of safety below that which existed prior to the alteration. See also 1.2.

8.7.1.3 Testing. Where alterations are made, acceptance inspections and tests shall be conducted as required by 8.10.2.3 for electric elevators, 8.10.3.3 for hydraulic elevators, or 8.10.4.2 for escalators and moving walks.

8.7.1.4 Welding. Welding of parts on which the support of the car, counterweight, escalator, or moving walk depends, including driving machines, escalator, or moving walks, trusses, girders, and tracks, shall conform to 8.8 and 8.7.1.5.

8.7.1.5 Design. Design shall be verified by a licensed professional engineer for welding, repair, cutting, or splicing of members upon which the support of the car, counterweight, escalator, or moving walks, trusses, girders, and tracks depends.

8.7.1.6 Temporary Wiring. During alterations, temporary wiring shall be permitted. The electrical protective devices of cars in normal operation shall not be rendered inoperative or ineffective.

8.7.1.7 Repairs and Replacements. Repairs and replacements shall conform to 8.6.2 and 8.6.3. (13)

8.7.1.8 Code Data Plate. A data plate shall be provided as required by 8.6.1.5. In jurisdictions enforcing NBCC, the data plate required by 8.9.1 shall include the code and edition in effect at the time of alteration and the requirements in 8.7 that were applicable to the alteration.

(13) 8.7.1.9 Alterations Involving SIL Rated Device(s) (See 1.3)

(a) A SIL rated device(s) used to satisfy 2.26.4.3.2, 2.26.8.2, 2.26.9.3.2(b), 2.26.9.5.1(b), or 2.26.9.6.1(b) shall not be

(1) modified such that the modification invalidates the listing/certification or

(2) affected by other alteration(s) such that the listing/certification is invalidated

(b) Where a SIL rated device (see 1.3) used to satisfy 2.26.4.3.2, 2.26.8.2, 2.26.9.3.2(b), 2.26.9.5.1(b), or 2.26.9.6.1(b) is replaced with a non-SIL rated device, the replacement shall meet the applicable requirements of 2.26.4.3.1, 2.26.8.2, 2.26.9.3.2(a), 2.26.9.5.1(a), and 2.26.9.6.1(a).

(c) Where a non-SIL rated device used to satisfy 2.26.4.3.1, 2.26.8.2, 2.26.9.3.2(a), 2.26.9.5.1(a), or 2.26.9.6.1(a) is replaced with a SIL rated device, the replacement shall meet the applicable requirements of 2.26.4.3.2, 2.26.8.2, 2.26.9.3.2(b), 2.26.9.5.1(b), and 2.26.9.6.1(b).

(d) Where a SIL rated device used to satisfy 2.26.4.3.2, 2.26.8.2, 2.26.9.3.2(b), 2.26.9.5.1(b), or 2.26.9.6.1(b) is replaced with a SIL rated device that is not the original manufacturer's listed/certified SIL rated device or the original manufacturer's listed/certified SIL rated replacement device, the replacement shall meet the applicable requirements of 2.26.4.3.2, 2.26.8.2, 2.26.9.3.2(b), 2.26.9.5.1(b), and 2.26.9.6.1(b).

(e) An up-to-date Maintenance Control Program (8.6.1.2.1) and wiring diagrams (8.6.1.6.3) shall be provided where they are affected by an alteration involving a SIL rated device (see 1.3).

8.7.2 Alterations to Electric Elevators**8.7.2.1 Hoistway Enclosures**

8.7.2.1.1 Hoistway Enclosure Walls. Where alterations are made to any portion of a hoistway enclosure wall, that portion which is altered shall conform to the following:

(a) Requirement 2.1.1.

(b) Requirement 2.1.5.

(c) Requirement 2.1.6.

(d) Requirement 2.5.

(e) Requirement 2.7.3.4.6.

(f) Requirement 2.8.

(g) Requirement 8.7.2.10, where the portion of the wall that is altered includes an entrance assembly.

(h) Where a hoistway is altered so as to create a single blind hoistway, entrances and emergency doors shall be provided as required by 2.11.1.

8.7.2.1.2 Addition of Elevator to Existing Hoistway. Where an elevator is added to an existing hoistway, the number of elevators in that multiple hoistway shall be in accordance with the requirements

of the building code. The horizontal clearances for the added elevator and the clearances between the added car and adjacent cars shall conform to 2.5.

8.7.2.1.3 Construction at Top of Hoistway. Any alteration to the construction at the top of the hoistway shall conform to 2.1.2.1 and 2.1.3. See also 8.7.2.4.

8.7.2.1.4 Construction at Bottom of Hoistway. Any alteration to the construction at the bottom of the hoistway shall conform to 2.1.2.2, 2.1.2.3, and 2.2. See also 8.7.2.4.

8.7.2.1.5 Control of Smoke and Hot Gases. Alterations to a hoistway that affect the means used to prevent the accumulation of smoke and hot gases in case of fire shall conform to 2.1.4.

8.7.2.2 Pits. Alterations made to the pit shall conform to 2.2 and 2.1.2.3. See also 8.7.2.4.

8.7.2.3 Location and Guarding of Counterweights. Where new counterweights are installed or where counterweights are relocated, their location, guarding, and clearances shall conform to 2.3 and 2.5.1.2. The installation shall also conform to 2.6.

8.7.2.4 Vertical Car and Counterweight Clearances and Runbys. No alteration shall reduce any clearance or runby below that required by 2.4. Existing clearances shall be permitted to be maintained, except as required by 8.7.2.17.1, 8.7.2.17.2, and 8.7.2.25.2.

8.7.2.5 Horizontal Car and Counterweight Clearances. No alteration shall reduce any clearance below that required by 2.5. Existing clearances shall be permitted to be maintained, except as required by 8.7.2.17.2.

8.7.2.6 Protection of Spaces Below Hoistways. Where alterations are made to an elevator or the building such that any space below the hoistway is not permanently secured against access, the affected installation shall conform to 2.6.

8.7.2.7 Machinery Spaces, Machine Rooms, Control Spaces, and Control Rooms

8.7.2.7.1 Enclosures. Where an alteration consists of the construction of new machinery spaces, machine rooms, control spaces, or control rooms, it shall conform to 2.7. Electrical equipment clearances shall conform to NFPA 70 or CSA-C22.1, whichever is applicable. Where alterations are made to any portion of machinery spaces, machine rooms, control spaces, or control rooms, that portion which is altered shall conform to 2.7.

8.7.2.7.2 Means of Access. Any alteration that affects the safe and convenient means of access to a machine room, machinery space, control space, or control room shall conform to 2.7.3.1, 2.7.3.2, and 2.7.3.3 to the extent existing conditions permit. (13)

8.7.2.7.3 Access Doors and Openings. Where an alteration is made to any access door or opening, it shall conform to 2.7.3.4. Where an alteration is made to an access door in an overhead machinery space, a stop switch shall be provided conforming to 2.7.3.5.

8.7.2.7.4 Headroom. No alteration shall reduce the headroom below that required by 2.7.4, or the existing headroom, whichever is less.

8.7.2.7.5 Windows and Skylights. Alterations made to windows and skylights shall conform to 2.1.5.

8.7.2.7.6 Lighting. No alteration shall be made that diminishes the lighting of a machine room or machinery space below that required by 2.7.9.1.

8.7.2.7.7 Ventilation. No alteration shall be made that diminishes the ventilation of a machine room or machinery space below that required by 2.7.9.2.

8.7.2.8 Electrical Equipment, Wiring, Pipes, and Ducts in Hoistways and Machine Rooms. The installation of any new, or the alteration of existing, electrical equipment, wiring, raceways, cables, pipes, or ducts shall conform to the applicable requirements of 2.8.

8.7.2.9 Machinery and Sheave Beams, Supports, and Foundations. Where new machinery and sheave beams, supports, foundations, or supporting floors are installed, relocated, or where alterations increase the original building design reactions by more than 5%, they shall conform to 2.9, and the adequacy of the affected building structure to support the loads shall be verified by a licensed professional engineer.

8.7.2.10 Entrances and Hoistway Openings

8.7.2.10.1 General Requirements

(a) Where all new hoistway entrances are installed, they shall conform to 2.11, 2.12, 2.13, and 2.29.2.

(b) Where one or more, but not all, new hoistway entrances are installed, they shall conform to 2.11.2 through 2.11.8 and 8.7.2.10.5. The entire installation shall also conform to 2.11.6, 2.12, 2.13, and 2.29.2.

(c) Where an alteration is made to any hoistway entrance, it shall conform to 2.11.3, 2.11.5, 2.11.7, 2.11.8, and 8.7.2.10.5. The entire installation shall also conform to 2.12, 2.13, and 2.29.2.

(d) Where an emergency door is added or altered, it shall conform to 2.11.1 and 8.7.2.10.5.

(e) Where access openings for cleaning are installed, they shall conform to 2.11.1.4 and 8.7.2.10.5.

8.7.2.10.2 Horizontal Slide-Type Entrances. In addition to the requirements of 8.7.2.10.1, where any new horizontal slide-type entrance is installed, it shall conform to 2.11.11.

New components that are installed as part of an alteration to an entrance shall conform as follows:

(a) Landing sills shall conform to 2.11.10.1, 2.11.11.1, and 2.11.11.6.

(b) Hanger tracks and track supports shall conform to 2.11.11.2.

(c) Entrance frames shall conform to 2.11.11.3. An applied frame shall be permitted to be fastened to an existing frame, provided that the combination of the new and existing frames conforms to 2.11.11.3, 2.11.11.5.1, 2.11.11.5.2, and 2.11.11.5.3.

(d) Hangers shall conform to 2.11.11.4.

(e) Panels shall comply with 2.11.11.5, 2.11.11.6, and 2.11.11.7, except that the overlap required by 2.11.11.5.1 shall be not less than 13 mm (0.5 in.).

(f) Door safety retainers shall conform to 2.11.11.8.

8.7.2.10.3 Vertical Slide-Type Entrances. In addition to the requirements of 8.7.2.10.1, where any new vertical slide-type entrance is installed, it shall conform to 2.11.12.

New components that are installed as part of an alteration to an entrance shall conform as follows:

(a) Landing sills shall conform to 2.11.10.3 and 2.11.12.1.

(b) Entrance frames shall conform to 2.11.12.2.

(c) Rails shall conform to 2.11.12.3.

(d) Panels shall conform to 2.11.12.3 through 2.11.12.6, and 2.11.12.8.

(e) Guides shall conform to 2.11.12.5.

(f) Sill guards shall conform to 2.11.12.7.

(g) Pull straps shall conform to 2.11.12.8.

8.7.2.10.4 Swing-Type Entrances. In addition to the requirements of 8.7.2.10.1, where any new swing-type entrance is installed, it shall conform to 2.11.13.

New components that are installed as part of an alteration to an entrance shall conform as follows:

(a) Landing sills shall conform to 2.11.10.1, 2.11.10.3, and 2.11.13.1.

(b) Entrance frames shall conform to 2.11.13.2 and 2.11.13.4.

(c) Panels shall conform to 2.11.13.3, 2.11.13.4, and 2.11.13.5.

(d) Hinges shall conform to 2.11.13.4.

8.7.2.10.5 Marking of Entrance Assemblies

(a) In jurisdictions enforcing the NBCC the following shall apply:

(1) When an entrance or door panel is altered, it shall have the fire protection rating not less than that of the existing entrance assembly

(2) it shall be labeled in accordance with NBCC

(b) In jurisdictions not enforcing NBCC the following shall apply:

(1) In fire-resistive construction, new hoistway entrances or door panels shall conform to 2.11.14 through 2.11.18, except for the following:

(a) existing metal frames

(b) existing tracks, sills, and sill supports

(c) applied frames

8.7.2.11 Hoistway Door Locking Devices, Access Switches, and Parking Devices

8.7.2.11.1 Interlocks. Where the alteration consists of the installation of hoistway door interlocks, the installation shall conform to 2.12.1, 2.12.2, 2.12.4 through 2.12.7, and 2.24.8.3.

8.7.2.11.2 Mechanical Locks and Electric Contacts. Where the alteration consists of the installation of hoistway-door combination mechanical locks and electric contacts, the installation shall conform to 2.12.1, 2.12.3, 2.12.4, 2.12.6, and 2.24.8.

8.7.2.11.3 Parking Devices. Where an alternation is performed to an elevator operated from within the car only, an elevator parking device shall be provided conforming to the following requirements:

(a) At every elevator landing that is equipped with an unlocking device, if

(1) the doors are not automatically unlocked when the car is within the unlocking zone

(2) the doors are not operable from the landing by a door open button or floor button

(b) Parking devices shall be permitted to be provided at other landings.

(c) Parking devices shall be located at a height not greater than 2 108 mm (83 in.) above the floor.

(d) Parking devices shall conform to the following requirements:

(1) they shall be mechanically or electrically operated

(2) they shall be designed and installed so that friction or sticking or the breaking of any spring used in the device will not permit opening or unlocking a door when the car is outside the landing zone of that floor

(3) springs, where used, shall be of the restrained compression type, which will prevent separation of the parts in case the spring breaks

8.7.2.11.4 Access Switches and Unlocking Devices. Where the alteration consists of the installation of hoistway access switches and/or hoistway-door unlocking devices, the installation shall conform to

(a) requirements 2.12.6 and 2.24.8.3 for unlocking devices

(b) requirements 2.12.7, 2.24.8, and 2.26.1.4 for access switches

(ED) **8.7.2.11.5 Restricted Opening of Hoistway Doors or Car Doors of Passenger Elevators.** Where a device that restricts the opening of hoistway doors or car doors is altered or installed, the device shall conform to 2.14.5.7.

(13) **8.7.2.12 Power Operation of Hoistway Doors.** Where the alteration consists of the addition of, or alteration to, power opening or power closing of hoistway doors, the installation shall conform to 8.7.2.10.1, 8.7.2.10.2, 8.7.2.10.3, and 8.7.2.10.5. All new equipment and wiring

shall conform to 8.7.2.8 and 2.26.4.2. All modified equipment and wiring shall conform to 8.7.2.8.

8.7.2.13 Door Reopening Device. Where a reopening device for power-operated car doors or gates is added or is part of an alteration to the door system, the following requirements shall apply:

(a) requirement 2.13.4

(b) requirement 2.13.5

(c) when firefighters' emergency operation is provided, door reopening devices and door closing on Phase I and Phase II shall comply with the requirements applicable at the time of installation of the firefighters' emergency operation.

8.7.2.14 Car Enclosures, Car Doors and Gates, and Car Illumination

8.7.2.14.1 Where an alteration consists of the installation of a new car, the installation shall conform to 2.14, 2.15, and 2.17 (see also 8.7.2.15.1).

8.7.2.14.2 The following requirements shall be conformed to where alterations are made to existing cars:

(a) Car enclosures shall conform to 2.14.1.2.

(b) Where an alteration is made to a top emergency exit, or where a new one is installed, it shall conform to 2.14.1.5.

(c) Where an alteration consists of the installation of glass in an elevator car, it shall conform to 2.14.1.8.

(d) Any equipment added to an elevator car shall conform to 2.14.1.9.

(e) All side emergency exits shall be permanently fixed in the closed position. The corresponding side emergency exit on an adjacent car shall also be fixed in the closed position.

(f) Any alteration to passenger car ventilation shall conform to 2.14.2.3.

(g) Any alteration to car illumination or lighting fixtures shall conform to 2.14.7.

(h) Where partitions are installed in elevator cars for the purpose of reducing the inside net platform areas for passenger use, they shall conform to 2.16.1.2. Where conditions do not permit symmetrical loading, guide rails, car frames, and platforms shall be capable of sustaining the resulting stresses and deflections.

(i) Where an alteration consists of the installation of a car door or gate on an existing elevator car, the installation shall conform to 2.14.4, 2.14.5, and 2.14.6.

8.7.2.14.3 In jurisdictions not enforcing the NBCC, where any alteration is made to the car enclosure, other than as specified in 8.7.2.14.2, the installation shall conform to the following:

(a) Where an existing metal enclosure is retained and new material, other than metal, is installed, the car enclosure shall conform to the 2.14.2.1.1.

(b) Where an existing enclosure other than as specified in 8.7.2.14.3(a) is retained and new material is installed, the new material and adhesive shall conform to the following requirements, based on the tests conducted in accordance with the requirements of ASTM E84, ANSI/UL 723, or CAN/ULC-S102:

- (1) flame spread rating of 0 to 75
- (2) smoke development of 0 to 450

If the material or combination of materials installed exceeds 6.4 mm (0.25 in.) in thickness, the car enclosure shall conform to 2.14.2.1.1.

(c) Napped, tufted, woven, looped, and similar materials shall conform to 2.14.2.1.1 or 8.7.2.14.3(b), 8.3.7, and 8.3.8. Adhesives shall conform to 8.7.2.14.3(b).

(d) Floor covering, underlayment, and its adhesive shall have a critical radiant flux of not less than 0.45 W/cm² as measured by ASTM E648.

(e) Handrails, operating devices, ventilating devices, signal fixtures, audio and visual communications devices, and their housings are not required to conform to 8.7.2.14.3(a) through (d).

- (13) **8.7.2.14.4** In jurisdictions enforcing the NBCC, where any alteration is made to the car enclosure, car doors, or car gates, other than as specified in 8.7.2.14.2, the installation shall conform to 2.14.2.1.2, 2.14.2.1.3, and 2.14.2.1.4, except that existing car enclosure materials exposed to the hoistway are not required to conform to the flame spread ratings. The existing flame spread rating shall not be diminished.

8.7.2.15 Car Frames and Platforms

8.7.2.15.1 Alterations to Car Frames and Platforms. Where alterations are made to a car frame or platform, the frame and platform shall conform to 2.15. Where roller or similar-type guide shoes are installed, that allow a definite limited movement of the car with respect to the guide rails, the clearance between the safety jaws and rails of the car shall be such that the safety jaws cannot touch the rails when the car frame is pressed against the rail faces with sufficient force to take up all movement of the roller guides.

8.7.2.15.2 Increase or Decrease in Deadweight of Car. Where an alteration results in an increase or decrease in the deadweight of the car that is sufficient to increase or decrease the sum of the deadweight and rated load, as originally installed, by more than 5%, the installation shall conform to the following requirements:

- (a) requirement 2.15, except the car platform guard (apron) shall conform to 2.15.9 only to the extent the existing pit shall permit, but in no case less than the leveling or truck zone plus 75 mm (3 in.)
- (b) requirement 2.16
- (c) requirement 2.17
- (d) requirement 2.18
- (e) requirement 2.20

(f) requirement 2.21, except as covered by 8.7.2.22.2
(g) requirement 2.22, except for 2.22.4.7, provided that conformance with

- (1) requirement 2.22.4.10 is established otherwise
- (2) requirement 2.22.4.5(b) can be established by other means such as adding a buffer switch conforming to 2.26.2.22
- (h) requirement 2.23
- (i) requirement 2.24, except 2.24.1
- (j) requirement 8.7.2.9

8.7.2.16 Capacity, Loading, and Classification

8.7.2.16.1 Change in Type of Service. Where an alteration consists of a change in type of service from freight to passenger or passenger to freight, the installation shall conform to:

- (a) requirements 2.11.1 through 2.11.3, and 2.11.5 through 2.11.8
- (b) requirements 2.12 and 2.13
- (c) requirement 2.22, except 2.22.4.5(b), 2.22.4.7, 2.22.4.10, and 2.22.4.11
- (d) requirements 2.14 and 2.15, except the car platform guard (apron) shall conform to 2.15.9 only to the extent the existing pit shall permit, but in no case less than the leveling or truck zone, plus 75 mm (3 in.)
- (e) requirement 2.17, except that where gradual wedge-clamp and drum-operated flexible guide-clamp safeties are reused, the stopping distances shall conform to the requirements of the Code at the time of installation [see ASME A17.2, Table 2.29.2(c)]
- (f) requirement 2.18, except that the pitch diameters of speed governor sheaves and governor tension sheaves are not required to conform to 2.18.7
- (g) requirements 2.16, 2.20, 2.24 through 2.27, except 2.24.1
- (h) requirement 2.19

8.7.2.16.2 Change in Class of Loading. Where the class of loading of a freight elevator is changed, it shall conform to 2.16.2 (see also 8.7.2.16.4). Where the freight loading class of a passenger elevator is changed, it shall conform to 2.16.1.3. (13)

8.7.2.16.3 Carrying of Passengers on Freight Elevators. Where the alteration consists of a change in type of service from a freight elevator to a freight elevator permitted to carry passengers, the elevator shall conform to 2.16.4.

8.7.2.16.4 Increase in Rated Load. Where an alteration involves an increase in the rated load, the installation shall conform to the following:

- (a) Car doors or gates shall be provided at all car entrances. Where new car doors or gates are installed, they shall conform to 2.14.4, 2.14.5, and 2.14.6.
- (b) Requirement 2.15, except the car platform guard (apron) shall conform to 2.15.9 only to the extent the

existing pit shall permit, but in no case less than the leveling or truck zone, plus 75 mm (3 in.).

- (c) Requirement 2.16.
- (d) Requirement 2.17.
- (e) Requirement 2.18, except that the pitch diameters of existing governor sheaves are not required to conform to 2.18.7.
- (f) Requirement 2.19.
- (g) Requirement 2.20.
- (h) Requirement 2.21, except as covered by 8.7.2.22.2.
- (i) Requirement 2.22, except 2.22.4.5(b), 2.22.4.7, 2.22.4.10, and 2.22.4.11.
- (j) Requirement 2.23.
- (k) Requirement 2.24.
- (l) Requirements 2.26.1.4 and 2.26.1.5.
- (m) Requirement 2.26.5.
- (n) Requirement 8.7.2.9.

8.7.2.17 Change in Rise or Rated Speed

- (13) **8.7.2.17.1 Increase or Decrease in Rise.** Where an alteration involves an increase or decrease in the rise, the following requirements shall be conformed to:

(a) The terminal stopping devices shall be relocated to conform to 2.25.

(b) Where the increase in rise is less than 4 570 mm (180 in.), an existing winding-drum machine shall be permitted to be retained, provided the drum is of sufficient dimensions to serve the increased rise with not less than one full turn of wire rope remaining on the winding drum when the car or counterweight has reached its extreme limits of travel.

(c) The bottom and top clearances and runbys for cars and counterweights shall conform to 2.4, except as follows:

(1) Where the increase in rise is at the upper end of the hoistway, the existing bottom car clearance and car and counterweight runby are not required to conform to 2.4. However, if existing clearances are less than as required by 2.4, they shall not be decreased by the change in rise.

(2) Where the increase in rise is at the lower end of the hoistway, the existing overhead car and counterweight clearances are not required to conform to 2.4. However, if existing clearances are less than as required by 2.4, they shall not be decreased by the change in rise.

(3) Where the decrease in rise is at the lowest end of the rise, the installation shall conform to 2.2.4, 2.2.5, 2.2.6, and 2.21.4.

(d) Where the increase in rise creates a single blind hoistway section greater than 11 m (36 ft) from sill to sill, the alteration shall comply with 2.11.1.2 and 2.11.1.3.

8.7.2.17.2 Increase in Rated Speed

(a) Increase in the rated speed of a winding-drum machine is prohibited, except as permitted in 8.7.2.17.2(c).

(b) Where the alteration involves an increase in the rated speed, except as specified in 8.7.2.17.2(c), the following requirements shall be conformed to:

(1) The bottom runbys and the top clearances for cars and counterweights shall conform to 2.4.2 through 2.4.11.

(2) Horizontal clearances shall conform to 2.5.

(3) The car and counterweight buffers shall conform to 2.22, except that existing buffers, where retained, are not required to conform to 2.22.4.5(b), 2.22.4.7, 2.22.4.10, and 2.22.4.11.

(4) Car doors or gates shall be provided at all car entrances. Where new car doors or gates are installed, they shall conform to 2.14.

(5) The car safety, the counterweight safety (where provided), and the governor shall conform to 2.17 and 2.18, except that the pitch diameters of speed governor sheaves and governor tension sheaves are not required to conform to 2.18.7. Where the new rated speed is greater than 3.5 m/s (700 ft/min), compensating rope tie-down shall be provided in compliance with 2.21.4.2.

(6) The capacity and loading shall conform to 2.16.

(7) The driving machine and sheaves shall conform to 2.24.

(8) The terminal stopping devices shall conform to 2.25.

(9) The operating devices and control equipment shall conform to 2.26, except that 2.26.4.1 through 2.26.4.3 shall apply only to the electrical wiring and equipment altered. Requirement 2.26.4.4 does not apply.

(10) Suspension ropes and rope connection shall conform to 2.20.

(11) Car overspeed protection and unintended car movement protection shall conform to 2.19.

(c) Where the increase in rated speed does not exceed 10% and does not exceed 0.20 m/s (40 ft/min), and is a result of a power supply change, and the new motor speed cannot match the existing motor speed, the installation is not required to conform to 8.7.2.17.2(b), except that the new rated speed shall not

(1) exceed 0.75 m/s (150 ft/min) for Type A safeties

(2) exceed 1 m/s (200 ft/min) when spring buffers are provided

Governors shall be adjusted to conform to 2.18.2.1 and 2.18.2.2 (see also 8.7.2.27.3).

8.7.2.17.3 Decrease in Rated Speed. Conformance with the following requirements shall be required when the alteration involves a decrease in the rated speed.

(a) Where the bottom runbys and the top clearances for cars and counterweights are less than as required by 2.4, they shall not be decreased by the speed reduction.

(b) The tripping speed of the car speed governor and the counterweight speed governor, where provided, shall be adjusted to conform to 2.18.2 for the new rated car speed.

(c) The capacity and loading shall conform to 2.16.

(d) Capacity and data plates shall conform to 2.16.3, except the information required by 2.16.3.2.2(d) shall include the name of the company doing the alteration and the year of the alteration.

(e) New electrical equipment and wiring shall conform to 2.26.4.1, 2.26.4.2, and 2.26.4.3.

8.7.2.18 Car and Counterweight Safeties

8.7.2.18.1 Where the alteration consists of the installation of new car safeties, the car safeties, car speed governor, and car guide rails shall conform to 2.17, 2.18, and 2.23, except as noted in 8.7.2.19.

8.7.2.18.2 Where the alteration consists of the installation of new counterweight safeties, the counterweight safeties, counterweight speed governor, and counterweight guide rails shall conform to 2.17, 2.18, and 2.23, except as noted in 8.7.2.19.

8.7.2.18.3 Where any alterations are made to existing car or counterweight safeties, the affected safeties, governors, and guide rails shall conform to 2.17.1 through 2.17.9, 2.17.15, 2.18, and 2.23, except as noted in 8.7.2.19.

8.7.2.18.4 Where existing rail reactions are not increased by the installation of new safeties, the existing hoistway construction for bracket support need not be modified.

8.7.2.19 Speed Governors and Governor Ropes.

Where any alteration is made to a speed governor, or where a new governor is installed, it shall conform to 2.18. Where there is a releasing carrier, it shall conform to 2.17.15.

Governor ropes of a different material, or construction than originally specified by the governor manufacturer shall be permitted, provided that

(a) there is conformance with 2.18.6 and 2.18.7, except that the pitch diameters of existing governor sheaves and tension sheaves are not required to conform to 2.18.7

(b) a test is made of the car or counterweight safety and speed governor with the new rope to demonstrate that the safety will function as required by 2.17.3

8.7.2.20 Ascending Car Overspeed and Unintended Car Movement Protection. The requirements of 2.19 shall be conformed to where a device for protection against ascending car overspeed and unintended car movement is altered or installed.

8.7.2.21 Suspension Means and Their Connections

8.7.2.21.1 Change in Suspension Members.

Where the material, grade, number, or size of suspension members is changed, the new suspension members and their fastenings shall conform to 2.20. When existing sheaves are retained using suspension members different from those originally specified, the original elevator

manufacturer or a licensed professional engineer shall certify the sheave material to be satisfactory for the revised application.

8.7.2.21.2 Addition of Suspension-Member Equalizers. Where suspension-member equalizers are installed, they shall conform to 2.20.5.

8.7.2.21.3 Addition of Auxiliary Suspension-Member-Fastening Devices. Where auxiliary suspension-member-fastening devices are installed, they shall conform to 2.20.

8.7.2.21.4 Exception for Suspension-Means Monitoring and Protection. Elevators installed to editions prior to A17.1-2007, including A17.1a-2008, are exempt from all of the requirements of 2.20.8 and 2.20.11 provided that there is no change to the type of suspension means and that there is no alteration to the means themselves. If a traction-loss detection means is provided, it shall comply with 2.20.8.1. If a broken-suspension-means detection means is provided, it shall comply with 2.20.8.2.

8.7.2.22 Counterweights

8.7.2.22.1 Where alterations are made to any part of a counterweight assembly, except guiding members, the installation shall conform to 2.21, except as specified by 8.7.2.22.2. See also 8.7.2.3.

8.7.2.22.2 Rod-type counterweights shall be permitted to be retained, provided they are equipped with a minimum of two suspension rods and two tie rods. The two suspension rods shall conform to 2.21.2.1 and 2.21.2.3 and shall be provided with locknuts and cotter pins at each end. The tie rods shall conform to 2.21.1.2. Means shall be provided on each side of the counterweight to maintain the distance between the top and bottom guide weights in the event the counterweight lands on the buffer.

8.7.2.22.3 Where roller or similar-type guide shoes are installed, that allow a definite limited movement of the counterweight with respect to the guide rails, the clearance between the safety jaws and rails of the counterweight shall be such that the safety jaws cannot touch the rails when the counterweight frame is pressed against the rail faces with sufficient force to take up all movement of the roller guides.

8.7.2.23 Car and Counterweight Buffers and Bumpers. Where alterations are made to car and counterweight buffers or bumpers, they shall conform to 2.22. The buffers are not required to conform to 2.22.4.7 if

(a) the buffer's load rating and properties defining method of absorbing and dissipating energy has not been altered

(b) the load rating of the buffer can be established by other means such as using original design data, original type testing data, marking plate, etc.

(c) the conformance with 2.22.4.5(b) can be established by other means such as adding a buffer switch conforming to 2.26.2.22

8.7.2.24 Guide Rails, Supports, and Fastenings.

Where alterations are made to car and counterweight guide rails, guide-rail supports, or guide-rail fastenings, or where the stresses have been increased by more than 5%, the installation shall conform to 2.23. Guide rails, supports, fastenings, and joints of different design and construction than those provided for in 2.23 shall be permitted to be retained provided they are in accordance with sound engineering practice and will adequately maintain the accuracy of the rail alignment.

8.7.2.25 Driving Machines and Sheaves

8.7.2.25.1 Alterations to Driving Machines and Sheaves

(a) Where a driving machine is installed as part of an alteration, the installation shall conform to 2.7.2, 2.9, 2.10.1, 2.19, 2.20, 2.24, and 2.26.8. Requirement 2.7.2 applies to the extent existing installations permit.

(b) Where alterations are made to driving machine components, the affected components shall conform to 2.24.2 through 2.24.9 and 2.26.8.

(c) Where an alteration consists of a change in the driving-machine sheave, the suspension ropes and their connections shall conform to 2.20. The sheave shall conform to 2.24.2, 2.24.3, and 2.24.4.

(13) 8.7.2.25.2 Change in Location of Driving Machine

(a) Where the location of the driving machine is changed, the installation shall conform to 2.7.2, 2.7.6.3.1, 2.7.6.3.3, 2.7.6.4, 2.7.8, 2.7.9, 2.8, 2.9, 2.10, 2.19, 2.20, 2.24.1, 2.24.2.3, 2.28, and 2.29.1.

(b) Where the location of the driving machine is changed with an increase or decrease in rise, the installation shall conform to 8.7.2.25.2(a) and 8.7.2.17.1.

8.7.2.26 Terminal Stopping Devices. Where an alteration is made to any terminal stopping device, the installation shall conform to 2.25.

8.7.2.27 Operating Devices and Control Equipment

(13) 8.7.2.27.1 Inspection Operation and Inspection Operation with Open Door Circuits

(a) Where there is an alteration to or addition of any type of inspection operation [see 2.26.1.4.1(a)], the alteration shall conform to the applicable requirements in 2.26.1.4.

(b) Where there is an alteration to or addition of car door bypass or hoistway door bypass switches, the alteration shall conform to 2.26.1.5.

8.7.2.27.2 Car Leveling or Truck Zoning Devices.

Where there is an alteration to or addition of a car leveling device, or a truck zoning device, it shall conform to 2.26.1.6.

8.7.2.27.3 Change in Power Supply. Where an alteration consists of a change in power supply at the mainline terminals of the elevator motion controller or motor controller, involving one of the following, whichever is applicable:

(a) change in voltage, frequency, or number of phases

(b) change from direct to alternating current or vice versa

(c) change to a combination of direct and alternating current

Electrical equipment shall conform to 2.26.1.1, 2.26.1.2, 2.26.1.3, 2.26.1.4, 2.26.1.6, 2.26.2, 2.26.6, 2.26.7, 2.26.9, and 2.26.10. All new and modified equipment and wiring shall conform to 2.26.4.1, 2.26.4.2, and 2.26.4.3.

Brakes shall conform to 2.24.8 and 2.26.8.

Winding-drum machines shall be provided with final terminal stopping devices conforming to 2.25.3.5 [see also 8.7.2.17.2(b)].

8.7.2.27.4 Controllers

(13)

(a) Where a motion controller is installed, without any change in the type of motion control, and without replacing the existing operation control, the installation shall conform to the following:

(1) Requirements 2.7.2, 8.7.2.7.2, and 2.7.9 for the newly installed equipment

(2) Requirement 8.7.2.8 and 2.26.4.2 for the newly installed equipment

(3) Requirement 2.19, except 2.19.2.2(a)(1) to 2.19.2.2(a)(3) is not required if the Code at the time of the original installation was prior to ASME A17.1-2000

(4) Requirement 2.26.9 for the newly installed equipment

(5) Requirement 2.29

(b) Where an operation controller is installed, and the type of operation control, if automatic remains automatic, or, if non-automatic remains continuous pressure, car switch, or other type of operation where the movement or stopping of the car is under the manual control of the operator (non-automatic), and the existing motion control equipment is retained, the installation shall conform to the following:

(1) Requirements 2.7.2, 8.7.2.7.2, and 2.7.9 for the newly installed equipment

(2) Requirement 8.7.2.8 and 2.26.4.2 for the newly installed equipment

(3) Requirement 2.26.9.3.1(d) and (e), 2.26.9.3.2, and 2.26.9.4 for the newly installed equipment

(4) Requirement 2.29

NOTE: Where the installation of an operation control alters emergency operation and signaling devices, the requirements of 8.7.2.28 apply.

(c) Where both a motion controller and an operation controller are installed without any change in the type of motion control as described in 8.7.2.27.4(a) and without any change in the type of operation control as

described in 8.7.2.27.4(b), the installation shall conform to the following:

- (1) Requirements 2.7.2, 8.7.2.7.2, and 2.7.9 for the newly installed equipment
- (2) Requirement 8.7.2.8 and 2.26.4.2 for the newly installed equipment
- (3) Requirement 2.19
- (4) terminal stopping devices shall conform to 2.25
- (5) the newly installed operating devices and control equipment shall conform to 2.26.1.2, 2.26.1.4, 2.26.1.5, 2.26.1.6, 2.26.2 through 2.26.9, and 2.26.11
- (6) Requirement 2.27.2 applies when emergency power is provided
- (7) in jurisdictions not enforcing NBCC, 2.27.3 through 2.27.9 apply
 - (a) when travel is 8 m (25 ft) or more above or below the designated landing; or
 - (b) on installations when Firefighters' Emergency Operation was required or provided at the time of installation
- (8) in jurisdictions enforcing NBCC, 2.27.3 through 2.27.9 apply only if Firefighters' Emergency Operation was required or provided at the time of installation
- (9) Requirement 2.29
- (d) Where a controller for the operation of hoistway doors, car doors, or car gates is installed, see 8.7.2.12.
- (e) Where a controller for the elevator operation on emergency or standby power systems or Firefighters' Emergency Operation is installed, see 8.7.2.28.

(13) 8.7.2.27.5 Change in Type of Motion Control.

Where there is a change in the type of motion control (the method of controlling acceleration, speed, retardation, and stopping), the installation shall conform to the following:

- (a) Requirements 2.7.2, 8.7.2.7.2, and 2.7.9 for the newly installed equipment
- (b) all new and modified electrical equipment and wiring to 8.7.2.8.
- (c) The protection of the hoistway landing openings shall conform to
 - (1) Requirement 2.11.1, except
 - (a) existing entrance openings less than 2 030 mm (79.9 in.) in height or 800 mm (31.5 in.) in width are permitted to be retained
 - (b) Requirement 2.11.1.4
 - (2) Requirements 2.11.2 through 2.11.10,
 - (3) Requirements 2.11.11.6 through 2.11.11.8, and 2.11.11.10
 - (4) Requirement 2.11.12.8
- (d) Requirement 2.12, except
 - (1) a minimum engagement of 6 mm (0.24 in.) is permitted in 2.12.2.4.3 and
 - (2) Requirement 2.12.4, where existing door locking devices are being retained
- (e) Requirement 2.13

(f) Car enclosures and car doors or gates shall conform to 2.14, except that where existing car enclosures and/or car doors or gates are retained, conformance with the following requirements is not required:

- (1) Requirements 2.14.1.3, 2.14.1.5.1, 2.14.1.6.2, 2.14.1.8, and 2.14.1.9
 - (2) Requirement 2.14.2.1, and 2.14.2.3 through 2.14.2.5
 - (3) Requirements 2.14.2.6(d) and 2.14.2.6(f)
 - (4) Requirement 2.14.3
 - (5) Requirements 2.14.4.2.5 if existing interlocks or contacts are retained, 2.14.4.3 and 2.14.4.6
 - (6) Requirement 2.14.5.1 and 2.14.5.6 through 2.14.5.8
 - (7) Requirement 2.14.6.2.2 except 2.14.5 shall be as amended in (6)
 - (8) Requirements 2.14.7.1.3, 2.14.7.1.4, and 2.14.7.2 through 2.14.7.4
 - (g) Where conformance to 2.14.1.7.1 is not possible due to existing overhead conditions, an alternative solution, acceptable to the authority having jurisdiction, providing equivalency to 2.14.1.7.1 shall be permitted.
 - (h) The car safety, the counterweight safety (where provided), and the governor shall conform to 2.17 and 2.18, except that
 - (1) where the safety factors required by 2.17.12.1 cannot be ascertained, rated load testing shall be accepted as demonstration of compliance, and
 - (2) the pitch diameter of speed governor sheaves and governor tension sheaves are not required to conform to 2.18.7.4.
 - (i) The capacity and loading shall conform to 2.16.8.
 - (j) Car overspeed protection and unintended movement protection shall conform to 2.19.
 - (k) The terminal stopping devices shall conform to 2.25.
 - (l) The operating devices and control equipment shall conform to 2.26. The requirements of 2.26.4.2, 2.26.4.3, and 2.26.4.4 shall not apply to electrical equipment unchanged by the alteration.
 - (m) In jurisdictions not enforcing NBCC, emergency operation and signaling devices shall be provided and shall conform to 2.27.
- In jurisdictions enforcing NBCC, the following shall be complied with:
- (1) car emergency signaling devices complying with 2.27.1, and
 - (2) emergency operation and signaling devices conforming to 2.27.2 through 2.27.9 where required by NBCC, or a prior edition of CSA B44.
- (n) Equipment and floors shall be identified as required by 2.29.

8.7.2.27.6 Change in Type of Operation Control. (13)

Where there is a change in the type of operation control, from continuous pressure, car switch, or other type of

operation where the movement or stopping of the car is under the manual control of the operator, to any form of automatic operation, or vice versa, the installation shall conform to the following:

- (a) Pits to 2.2, except; 2.2.2.1, 2.2.2.2, and 2.2.2.5
- (b) Counterweight guarding to 2.3
- (c) Vertical clearances and runbys as required by 8.7.2.4
- (d) Horizontal car and counterweight clearances as required by 8.7.2.5
- (e) Requirements 2.7.2, 8.7.2.7.2, 2.7.5, 2.7.6, and 2.7.9 for the newly installed equipment
- (f) All new and modified electrical equipment and wiring to 8.7.2.8
- (g) The protection of the hoistway landing openings shall conform to 2.11.1 through 2.11.13, 2.12, and 2.13
- (h) Car enclosures and car doors or gates shall conform to 2.14, except that where existing car enclosures and/or car doors or gates are retained, conformance with the following requirements is not required:
 - (1) Requirement 2.14.1.3, except that with the specified force the required running clearances referenced in 2.14.1.3 are achieved, and 2.14.1.8
 - (2) Requirements 2.14.2.1, 2.14.2.3, and 2.14.2.4
 - (3) Requirements 2.14.4.3 and 2.14.4.6 except that with the specified force, the door or gate will not deflect beyond the line of the car sill
- (i) Where conformance to 2.14.1.7.1 is not possible due to existing overhead conditions, an alternative solution, acceptable to the authority having jurisdiction, providing equivalency to 2.14.1.7.1 shall be permitted
- (j) The car safety, the counterweight safety (where provided), and the governor shall conform to 2.17 and 2.18, except that the pitch diameter of speed governor sheaves and governor tension sheaves are not required to conform to 2.18.7.
- (k) The capacity and loading shall conform to 2.16.
- (l) Ascending car overspeed and unintended car movement protection shall conform to 2.19.
- (m) The terminal stopping devices shall conform to 2.25.
- (n) The operating devices and control equipment shall conform to 2.26. The requirements of 2.26.4.2, 2.26.4.3, and 2.26.4.4 shall not apply to electrical equipment unchanged by the alteration.
- (o) Emergency operation and signaling devices shall be provided and shall conform to 2.27.
- (p) Equipment and floors shall be identified as required by 2.29

(13) **8.7.2.27.7 In-Car Stop Switch.** On passenger elevators equipped with nonperforated car enclosures, the emergency stop switch, including all markings, shall be permitted to be removed and replaced by an in-car stop switch conforming to the following:

- (a) it is either key operated or behind a locked cover, and located in or adjacent to the car operating panel.

The key shall be Group 1 Security (see 8.1). The switch shall be clearly and permanently marked "STOP" and shall indicate the "STOP" and "RUN" positions. When opened ("STOP" position), this switch shall cause the electric power to be removed from the elevator driving-machine motor and brake.

- (b) The device shall meet the requirements of 2.26.4.3.

8.7.2.27.8 Electrical Protective Devices. Where there is an alteration to or addition of an electrical protective device, it shall conform to 2.26.2 for that device.

8.7.2.27.9 Door Monitoring System. Where there is an alteration to or addition of a system to monitor and prevent automatic operation of the elevator with faulty door contact circuits on power-operated car doors that are mechanically coupled with the landing doors while the car is in the landing zone, the alteration shall conform to the requirements in 2.26.5. (13)

8.7.2.28 Emergency Operations and Signaling Devices (13)

(a) Where an alteration is made to car emergency signaling devices, the alteration shall conform to 2.27.1.

(b) Where an alteration is made to, or consists of the addition of, an emergency or standby power system, the installation shall conform to the requirements of 2.27.2.

(c) Where an alteration is made to, or consists of the addition of, Firefighters' Emergency Operation, the elevator and all elevators in the same group automatic operation shall conform to 2.27.3 through 2.27.8.

(d) Where the alteration consists of the addition of an elevator to a group, all elevators in that group shall conform to 2.27.

(e) Where any of the alterations (a) through (d) above occur, all new equipment and wiring shall conform to 8.7.2.8 and 2.26.4.2, and all modified equipment and wiring shall conform to 8.7.2.8. Equipment and floors shall be identified as required by 2.29.

8.7.3 Alterations to Hydraulic Elevators

8.7.3.1 Hoistway Enclosures. Alterations to hoistway enclosures shall conform to 8.7.2.1.

8.7.3.2 Pits. Alterations made to the pit shall conform to 2.1.2.3 and 2.2. See also 8.7.3.4.

8.7.3.3 Location and Guarding of Counterweights. Where new counterweights are installed, they shall conform to 2.3 and 2.5.1.2. The installation shall also conform to 3.5.

8.7.3.4 Vertical Car and Counterweight Clearances and Runbys. No alteration shall reduce any clearance or runby below that required by 3.4. Existing clearances shall be permitted to be maintained, except as required by 8.7.3.22.1, 8.7.3.22.2, and 8.7.3.23.5.

8.7.3.5 Horizontal Car and Counterweight Clearances. No alteration shall reduce any clearance below that required by 2.5. Existing clearances shall be permitted to be maintained, except as required by 8.7.3.22.1, 8.7.3.22.2, and 8.7.3.23.5.

8.7.3.6 Protection of Spaces Below Hoistways.

Where alterations are made to an elevator or the building, such that any space below the hoistway is not permanently secured against access, the affected installation shall conform to 3.6.

(13) **8.7.3.7 Machine Rooms, Machinery Spaces, Control Spaces, and Control Rooms.** Alterations to a machine room, machinery space, control space, or control room shall conform to 8.7.2.7.2 through 8.7.2.7.7. Where an alteration consists of the construction of a new machine room, machinery space, control space, or control room enclosure, it shall conform to 2.7 and 3.7. Electrical equipment clearances shall conform to the requirements of NFPA 70 or CSA-C22.1, whichever is applicable (see Part 9). Where alterations are made to any portion of a machine room, machinery space, control space, or control room, the portion that is altered shall conform to 2.7 and 3.7.

8.7.3.8 Electrical Wiring, Pipes, and Ducts in Hoistways and Machine Rooms. The installation of any new, or the alteration of existing, electrical equipment, wiring, raceways, cables, pipes, or ducts shall conform to the applicable requirements of 2.8.

8.7.3.9 Machinery and Sheave Beams, Supports and Foundations. Where new machinery and sheave beams, supports, foundations, or supporting floors are installed, or where alterations increase the original building design reactions by more than 5%, they shall conform to 2.9, and the adequacy of the affected building structure to support the loads shall be verified by a licensed professional engineer.

8.7.3.10 Hoistway Entrances and Openings. Alterations to hoistway entrances shall conform to 8.7.2.10, except that emergency doors meeting the requirements of 2.11.1 are only required to be installed in the blind portion of the hoistway where required by 8.7.2.10 and

(a) for all elevators where car or counterweight safeties are used

(b) for elevators where safeties are not used, emergency doors are not required on elevators where a manually operated valve is provided that will permit lowering the car at a reduced speed in case of power failure or similar emergency

8.7.3.11 Hoistway Door Locking Devices. Alterations to hoistway door locking devices, access switches, parking devices, and unlocking devices shall conform to 8.7.2.11, except that conformance with 2.24.8 is not required.

8.7.3.12 Power Operation of Hoistway Doors. Where the alteration consists of the addition of, or alteration to, power opening or power closing of hoistway doors, the installation shall conform to 8.7.2.10.1, 8.7.2.10.2, 8.7.2.10.3, 8.7.2.10.5, and 8.7.3.10. (13)

All new equipment and wiring shall conform to 8.7.3.8 and 2.26.4.2.

All modified equipment and wiring shall conform to 8.7.3.8.

8.7.3.13 Car Enclosures and Door Reopening Devices (13)

8.7.3.13.1 Where alterations are made to car enclosures, they shall conform to 8.7.2.14.

8.7.3.13.2 Where a reopening device for power-operated car doors or gates is altered or added, it shall conform to 8.7.2.13.

8.7.3.14 Car Frames and Platforms. Where alterations are made to a car frame or platform, the frame and platform shall conform to 3.15.

If safeties are used and if roller or similar-type guide shoes are installed, that allow a definite limited movement of the car with respect to the guide rails, the clearance between the safety jaws and rails of the car shall be such that the safety jaws cannot touch the rails when the car frame is pressed against the rail faces with sufficient force to take up all movement of the roller guides.

8.7.3.15 Safeties

8.7.3.15.1 Where the alteration consists of the installation of car safeties, the car safeties and car guide rails shall conform to 3.17.1, 3.23, and 3.28.

8.7.3.15.2 Where the alteration consists of the installation of counterweight safeties, the counterweight safeties and counterweight guide rails shall conform to 3.17.2, 3.23, and 3.28.

8.7.3.15.3 Where any alterations are made to existing car or counterweight safeties, the affected safeties and guide rails shall conform to 3.17, 3.23, and 3.28, except for cross-referenced 2.17.10 through 2.17.14, 2.17.16, and 2.21.4.2.

8.7.3.16 Governors and Governor Ropes. Where alterations are made to governors or where they are added, they shall conform to 8.7.2.19.

8.7.3.17 Change in Type of Service. Where an alteration consists of a change in type of service from freight to passenger or passenger to freight, the installation shall conform to

(a) Requirements 2.11.1, 2.11.2, 2.11.3, and 2.11.5 through 2.11.8, except that emergency doors meeting the requirements of 2.11.1 are only required to be installed in the blind portion of the hoistway

(1) for all elevators where car or counterweight safeties are used

(2) for elevators where safeties are not used, emergency doors are not required on elevators where a manually operated valve is provided that will permit lowering the car at a reduced speed in case of power failure or similar emergency

(b) Requirements 2.12 and 2.13

(c) Requirements 2.22 and 3.22.2, except 2.22.4.5(b), 2.22.4.7, 2.22.4.10, and 2.22.4.11

(d) Requirements 3.14, 3.15, 3.17, 3.21, and 3.23

(e) Requirement 2.18, where governors are provided, except that the pitch diameters of existing governor sheaves and tension sheaves are not required to conform to 2.18.7

(f) Requirements 3.16, 3.18, 3.19, 3.20, 3.24, 3.25, 3.26, and 3.27

- (13) **8.7.3.18 Change in Class of Loading.** Where the class of loading of a freight elevator is changed, it shall conform to 2.16.2 as modified by 3.16. Where the freight loading class of a passenger elevator is changed, it shall conform to 2.16.1.3 as modified by 3.16.

8.7.3.19 Carrying of Passengers on Freight Elevators. Where the alteration consists of a change in type of service from a freight elevator to a freight elevator permitted to carry passengers, the elevator shall conform to 3.16.4.

8.7.3.20 Increase in Rated Load. Where an alteration involves an increase in the rated load, the installation shall conform to 2.26.1.4, 2.26.1.5, 2.26.5, 3.14 through 3.17, 3.20, and 3.21 through 3.23 (see also 8.7.3.23.4).

8.7.3.21 Increase in Deadweight of Car. Where an alteration results in an increase in the deadweight of the car that is sufficient to increase the sum of the deadweight and rated load, as originally installed, by more than 5%, the installation shall conform to 3.14 through 3.17, 3.20, and 3.21 through 3.23 (see also 8.7.3.23.4).

8.7.3.22 Change in Rise or Rated Speed

8.7.3.22.1 Increase or Decrease in Rise. Where an alteration involves an increase or decrease in the rise without any change in the location of the driving machine, it shall conform to the following:

(a) The terminal stopping devices shall be relocated to conform to 3.25.

(b) Where the increase in rise is at the lower end of the hoistway, bottom car and counterweight clearances and runbys shall conform to 3.4.1, 3.4.2, and 3.4.3, and existing top car and counterweight clearances and runbys that are less than as required by 3.4 shall not be decreased.

(c) Where the increase in rise is at the upper end of the hoistway, top car and counterweight clearances, runbys, and refuge spaces shall conform to 3.4, and existing bottom car and counterweight clearances and

runbys that are less than as required by 3.4 shall not be decreased.

(d) The plunger shall conform to 3.18.2.

(e) Where the decrease is at the lower end of the rise, the installation shall conform to 2.2.4, 2.2.5, and 2.2.6.

8.7.3.22.2 Increase in Rated Speed. Where an alteration increases the rated speed, the installation shall conform to the following:

(a) Requirement 2.5.

(b) Requirement 3.4.

(c) Requirements 3.21 and 3.22.2, except that existing buffers, where retained, are not required to conform to referenced 2.22.4.5(b), 2.22.4.7, 2.22.4.10, and 2.22.4.11.

(d) Car doors or gates shall be provided at all car entrances. Where new car doors or gates are installed, they shall conform to the applicable requirements of 3.14.

(e) Car and counterweight safeties and governors, where provided, shall conform to 3.17, except that the pitch diameters of existing governor sheaves and tension sheaves are not required to conform to 2.18.7.

(f) Requirement 3.16.

(g) Requirement 3.25.

(h) Requirements 3.26.1 through 3.26.6.

(i) Requirement 3.20.

8.7.3.22.3 Decrease in Rated Speed. When the alteration involves a decrease in the rated speed, it shall conform to the following:

(a) If the bottom runbys and the top clearances for cars and counterweights are less than as required by 3.4, they shall not be decreased by the speed reduction.

(b) The tripping speed of the car speed governor and the counterweight speed governor, where provided, shall be adjusted to conform to 2.18.2 for the new rated car speed.

(c) The capacity and loading shall conform to 3.16.

(d) Capacity and data plates shall conform to 3.16.3(b), except the information required by 2.16.3.2.2(d) shall include the name of the company doing the alteration and the year of the alteration.

(e) New electrical equipment and wiring shall conform to 2.26.4.1 and 2.26.4.2.

8.7.3.23 Hydraulic Equipment

8.7.3.23.1 Hydraulic Jack. Where a hydraulic jack is installed, altered, or replaced, it shall conform to 3.18.

8.7.3.23.2 Plungers. Where a new plunger is installed or an existing plunger is altered, it shall conform to 3.18.1.2 and 3.18.2.

8.7.3.23.3 Cylinders. Where a cylinder is installed, replaced, altered, or sleeved, it shall conform to 3.18.3. If the plunger is not equipped with a stop ring conforming to 3.18.4.1, the installation shall also conform to 3.18.1.2 and 3.18.2.

8.7.3.23.4 Increase in Working Pressure. Where an alteration increases the working pressure by more than 5%, the installation shall conform to 3.18, 3.19, and 3.24.1 through 3.24.4. Requirements 3.18.3.8 and 3.19.4.6 do not apply to existing equipment.

8.7.3.23.5 Change in Location of Hydraulic Jack. Where location of the hydraulic jack is changed, the installation shall conform to Part 3.

8.7.3.23.6 Relocation of Hydraulic Machine (Power Unit). Where the hydraulic machine is relocated so that the top of the cylinder is above the top of the storage tank, the installation shall conform to 3.26.8.

8.7.3.23.7 Plunger Gripper. Where the alteration consists of the addition of a plunger gripper, the following conditions must be met:

- (a) the plunger gripper must comply with 3.17.3
- (b) Requirement 3.1.1(b) shall apply
- (c) when buffers are compressed solid or to a fixed stop in accordance with 3.22.1, the plunger gripper shall not strike the car structure

8.7.3.24 Valves, Pressure Piping, and Fittings. Where an existing control valve is replaced with a valve of a different type, it shall conform to 3.19. Where relief or check valves or the supply piping or fittings are replaced as part of an alteration, the components replaced shall conform to the applicable requirements of 3.19. Where electrically operated control valves are installed in place of existing mechanically operated control valves, for rated speeds of more than 0.5 m/s (100 ft/min), existing terminal stopping devices consisting of an automatic stop valve independent of the normal control valve and operated by the movement of the car as it approaches the terminals, where provided, shall be permitted to be retained.

8.7.3.25 Suspension Ropes and Their Connections

8.7.3.25.1 Change in Ropes. Where the material, grade, number, or diameter of ropes is changed, the new ropes and their fastenings shall conform to 3.20. When existing sheaves are retained using ropes different from those originally specified, the original elevator manufacturer or a licensed professional engineer shall certify the sheave material to be satisfactory for the revised application.

8.7.3.25.2 Addition of Rope Equalizers. Where rope equalizers are installed, they shall conform to 2.20.5.

8.7.3.26 Counterweights. Where alterations are made to counterweights, they shall conform to 8.7.2.22 and 3.21. Where counterweights are added to a previously uncounterweighted elevator, it shall conform to 3.4, 3.6, 3.14, 3.15, 3.17.2, 3.18, 3.20, and 3.21. See also 8.7.3.3.

8.7.3.27 Car Buffers and Bumpers. Where alterations are made to car buffers or bumpers, the installation shall conform to 3.21 and 3.22.2. Existing buffers are not required to conform to 2.22.4.5(b), 2.22.4.7, 2.22.4.10, and 2.22.4.11.

8.7.3.28 Guide Rails, Supports, and Fastenings. Where alterations are made to car and counterweight guide rails, guide-rail supports, or guide-rail fastenings, or where the stresses have been increased by more than 5%, the installation shall conform to 3.23 and 3.28.

8.7.3.29 Tanks. Where a tank is installed as part of an alteration or altered, the tank shall conform to 3.24.

8.7.3.30 Terminal Stopping Devices. Where an alteration is made to any terminal stopping device, the installation shall conform to 3.25.

8.7.3.31 Operating Devices and Control Equipment

8.7.3.31.1 Top-of-Car Operating Devices. Where there is an alteration to, or addition of, a top-of-car operating device, it shall conform to 3.26.2.

8.7.3.31.2 Car Leveling or Truck Zoning Devices. Where there is an alteration to, or addition of, a car leveling device or a truck zoning device, it shall conform to 3.26.3.2.

8.7.3.31.3 Anticreep Leveling Device. Where there is an alteration of an anticreep leveling device, it shall conform to 3.26.3.1.

8.7.3.31.4 Change in Power Supply. Where an alteration consists of a change in power supply at the mainline terminals of the elevator motion controller or motor controller involving

- (a) change in voltage, frequency, or number of phases;
- (b) change from direct current to alternating current, or vice versa; or
- (c) change to a combination of direct or alternating current.

Electrical equipment shall conform to 3.26.1, 3.26.4, 3.26.5, and 3.26.6 (not including 2.26.4.4).

8.7.3.31.5 Controllers

(a) Where a motion controller is installed, without any change in the type of motion control, and without replacing the existing operation control, the installation shall conform to the following:

- (1) Requirements 2.7.2, 8.7.2.7.2, and 2.7.9 for the newly installed equipment
- (2) Requirements 8.7.2.8 and 2.26.4.2 for the newly installed equipment
- (3) Requirement 2.26.9 for the newly installed equipment
- (4) Requirement 2.29

(b) Where an operation controller is installed, and the type of operation control, if automatic remains automatic, or, if non-automatic remains continuous pressure,

(13)

car switch, or other type of operation where the movement or stopping of the car is under the control of the operator (non-automatic), and the existing motion control equipment is retained, the installation shall conform to the following:

- (1) Requirements 2.7.2, 8.7.2.7.2, and 2.7.9 for the newly installed equipment
- (2) Requirements 8.7.2.8 and 2.26.4.2 for the newly installed equipment
- (3) Requirements 2.26.9.3 and 2.26.9.4 for the newly installed equipment
- (4) Requirement 2.29

NOTE: Where the installation of an operation control alters emergency operation and signaling devices the requirements of 8.7.3.31.8 apply.

(c) Where both a motion controller and an operation controller are installed without any change in the type of motion control as described in 8.7.3.31.5(a) and without any change in the type of operation control as described in 8.7.3.31.5(b), the installation shall conform to the following:

- (1) Requirements 2.7.2, 8.7.2.7.2, and 2.7.9 for the newly installed equipment
- (2) Requirements 8.7.2.8 and 2.26.4.2 for the newly installed equipment
- (3) Terminal stopping devices shall conform to 3.25.
- (4) The newly installed operating devices and control equipment shall conform to 3.26. Requirements of 2.26.1.1, 2.26.1.3, and 2.26.12 do not apply.
- (5) Requirement 2.27.2 applies when emergency power is provided.
- (6) In jurisdictions not enforcing NBCC, 3.27.1 through 3.27.4, and 2.27.3 through 2.27.9 apply
 - (a) when travel is 8 m (25 ft) or more above or below the designated landing; or
 - (b) on installations when Firefighters' Emergency Operation was required or provided at the time of installation.
- (7) In jurisdictions enforcing NBCC, 3.27.1 through 3.27.4, and 2.27.3 through 2.27.9 apply only if Firefighters' Emergency Operation was required or provided at the time of installation.
- (8) Requirement 2.29

(d) Where a controller for the operation of hoistway doors, car doors, or car gates is installed, see 8.7.3.12.

(e) Where a controller for the elevator operation on emergency or standby power systems or Firefighters' Emergency Operation is installed, see 8.7.3.28.

(13) 8.7.3.31.6 Change in Type of Motion Control.

Where there is a change in the type of motion control (the method of controlling acceleration, speed, retardation, and stopping), the installation shall conform to the following:

(a) Requirements 2.7.2, 8.7.2.7.2, and 2.7.9 for the newly installed equipment.

(b) All new and modified electrical equipment and wiring to 8.7.3.8.

(c) The protection of the hoistway landing openings shall conform to

(1) Requirement 2.11.1, as modified by 3.11.1, except

(a) existing entrance openings less than 2 030 mm (80 in.) in height or 800 mm (31.5 in.) in width are permitted to be retained,

(b) Requirement 2.11.1.4

(2) Requirements 2.11.2 through 2.11.8, and 2.11.10

(3) Requirements 2.11.11.6 through 2.11.11.8, and 2.11.11.10

(4) Requirement 2.11.12.8

(d) Requirement 3.12.1, except;

(1) a minimum engagement of 6 mm (0.24 in.) is permitted in 2.12.2.4.3, and

(2) Requirement 2.12.4, where existing door locking devices are being retained.

(e) Requirement 3.13

(f) Car enclosures and car doors or gates shall conform to 3.14, except that where existing car enclosures and/or car doors or gates are retained, conformance with the following requirements is not required:

(1) Requirements 2.14.1.3, 2.14.1.5.1, 2.14.1.6.2, 2.14.1.8, and 2.14.1.9,

(2) Requirements 2.14.2.1, 2.14.2.3 through 2.14.2.5

(3) Requirements 2.14.2.6(d) and 2.14.2.6(f)

(4) Requirement 2.14.3

(5) Requirement 2.14.4.2.5 if existing interlocks or contacts are retained, 2.14.4.3, and 2.14.4.6

(6) Requirement 2.14.5.1, and 2.14.5.6 through 2.14.5.8

(7) Requirement 2.14.6.2.2, except 2.14.5 shall be as amended in (6)

(8) Requirements 2.14.7.1.3, 2.14.7.1.4, and 2.14.7.2 through 2.14.7.4

(g) Where conformance to 2.14.1.7.1 is not possible due to existing overhead conditions, an alternative solution, acceptable to the authority having jurisdiction, providing equivalency to 2.14.1.7.1 shall be permitted.

(h) The car safety (where provided), the counterweight safety (where provided), shall conform to 3.17 and the governor (where provided) shall conform to 2.18, except that

(1) where the safety factors required by 2.17.12.1 cannot be ascertained, rated load testing shall be accepted as demonstration of compliance, and

(2) the pitch diameter of speed governor sheaves and governor tension sheaves are not required to conform to 2.18.7.4.

(i) The capacity and loading shall conform to 3.16.

(j) The terminal stopping devices shall conform to 3.25.

(k) The operating devices and control equipment shall conform to 3.26. Requirements of 2.26.4.2 and 2.26.4.4

shall not apply to electrical equipment unchanged by the alteration.

(l) In jurisdictions not enforcing NBCC, emergency operation and signaling devices shall conform to 3.27. In jurisdictions enforcing NBCC, the following shall be complied with:

(1) car emergency signaling devices complying with 2.27.1, and

(2) emergency operation and signaling devices conforming to 3.27 where required by NBCC, or a prior edition of CSA B44.

(m) Requirement 2.29

(13) 8.7.3.31.7 Change in Type of Operation Control.

Where there is a change in the type of operation control, from continuous pressure, car switch, or other type of operation where the movement or stopping of the car is under the manual control of the operator, to any form of automatic operation, the installation shall conform to the following:

(a) Pits to 2.2, except; 2.2.2.1, 2.2.2.2, and 2.2.2.5.

(b) Counterweight guarding to 2.3.

(c) Vertical clearances and runbys to 8.7.3.4.

(d) Horizontal car and counterweight clearances to 8.7.3.5.

(e) Requirements 2.7.2, 8.7.2.7.2, 2.7.5, 2.7.6, and 2.7.9 for the newly installed equipment.

(f) All new and modified electrical equipment and wiring to 8.7.3.8.

(g) The protection of the hoistway landing openings shall conform to 2.11.1 through 2.11.13 as modified by 3.11.1, and conform to 3.12.1 and 3.13.

(h) Car enclosures and car doors or gates shall conform to 3.14, except that where existing car enclosures and/or car doors or gates are retained, conformance with the following requirements is not required:

(1) Requirements 2.14.1.3, except that with the specified force the required running clearances referenced in 2.14.1.3 are achieved, and 2.14.1.8

(2) Requirements 2.14.2.1, 2.14.2.3, and 2.14.2.4

(3) Requirements 2.14.4.3 and 2.14.4.6 to the extent that with the specified force, the door or gate will not deflect beyond the line of the car sill

(i) Where conformance to 2.14.1.7.1 is not possible due to existing overhead conditions, an alternative solution, acceptable to the authority having jurisdiction, providing equivalency to 2.14.1.7.1 shall be permitted.

(j) The capacity and loading shall conform to 3.16.

(k) The terminal stopping devices shall conform to 3.25.

(l) The operating devices and control equipment shall conform to 3.26. The requirements of 2.26.4.2, 2.26.4.3, and 2.26.4.4 shall not apply to electrical equipment unchanged by the alteration.

(m) Emergency operation and signaling devices shall be provided and shall conform to 3.27.

(n) Equipment and floors shall be identified as required by 2.29.

8.7.3.31.8 Emergency Operation and Signaling Devices (13)

(a) Where an alteration is made to car emergency signaling devices, the installation shall conform to 2.27.1.

(b) Where an alteration is made to, or consists of the addition of, an emergency or standby power system, the installation shall conform to the requirements of 2.27.2.

(c) Where an alteration is made to, or consists of the addition of, Firefighters' Emergency Operation, the elevator and all elevators in the same group, automatic operation shall conform to 3.27, except 2.27.1 and 2.27.2.

(d) Where the alteration consists of the addition of an elevator to a group, all elevators in that group shall conform to 3.27.

(e) Where any of the alterations of (a) through (c) above occur, all new equipment and wiring shall conform to 8.7.3.8 and 2.26.4.2, and all modified equipment and wiring shall conform to 8.7.3.8. Equipment and floors shall be identified as required by 2.29.

8.7.3.31.9 Auxiliary Power Lowering Operation.

Where auxiliary power lowering operation is installed or altered, it shall conform to 3.26.10.

8.7.3.31.10 In-Car Stop Switch. On passenger elevators equipped with nonperforated car enclosures, the emergency stop switch, including all markings, shall be permitted to be removed and replaced by an in-car stop switch conforming to the following: (13)

(a) It is either key operated or behind a locked cover, and located in or adjacent to the car operating panel. The key shall be Group 1 Security (see 8.1). The switch shall be clearly and permanently marked "STOP" and shall indicate the "STOP" and "RUN" positions. When opened ("STOP" position), this switch shall cause the electric power to be removed from the elevator hydraulic machine.

(b) The device shall meet the requirements of 2.26.4.3.

(c) The device shall meet the requirements of 3.26.4.2

8.7.3.31.11 Electrical Protective Devices. Where there is an alteration to or addition of an electrical protection device, it shall conform to 3.26.4 for that device.

8.7.3.31.12 Change of Hydraulic Pump Motor Starter. Where there is a change to the hydraulic pump motor starter, and the starter solely controls the motion of the car in the up direction without the use of valves, the installation shall conform to 3.26.6.4 and 3.26.5. The new and modified equipment and wiring shall conform to (13)

(a) Requirement 2.8.2.1

(b) Requirement 2.26.4.1

(c) Requirement 2.26.4.2

8.7.4 Alterations to Elevators With Other Types of Driving Machines

8.7.4.1 Rack and Pinion Elevators. Where any alteration is made to a rack-and-pinion elevator, the entire installation shall comply with 4.1.

8.7.4.2 Screw-Column Elevators. Where any alteration is made to a screw-column elevator, the entire installation shall comply with 4.2.

8.7.4.3 Hand Elevators

8.7.4.3.1 Hoistway Enclosures and Machinery Space. Where an alteration is made to any portion of a hoistway enclosure or machinery space, the altered portion shall conform to 4.3.1 and 4.3.4.

8.7.4.3.2 Top Car and Counterweight Clearances. No alteration shall reduce any clearances or runby below that required by 4.3.3 or below the minimum clearances as originally installed.

8.7.4.3.3 Hoistway Entrances. Where new entrances are installed, the new entrances shall conform to 4.3.6, 4.3.7, and 4.3.8.

8.7.4.3.4 Car Enclosures. Where an alteration is made to a car enclosure, it shall conform to 4.3.9 and 4.3.11.

8.7.4.3.5 Car Frame and Platform. Where an alteration is made to a car frame or platform, the frame or platform shall conform to 4.3.11, 4.3.12, 4.3.13, and 4.3.16.

8.7.4.3.6 Capacity and Loading. No alteration shall reduce the rated load below that required by 4.3.14.1 and 4.3.14.2. Where the alteration involves an increase in rated load, the driving machine sheave shall comply with 4.3.19.1, 4.3.19.2, and 4.3.16.

8.7.4.3.7 Increase in Rise. Where the alteration involves an increase in the total rise to exceed 4 600 mm (15 ft), it shall conform to 4.3.3.1, 4.3.3.2, 4.3.15, and 4.3.16.

8.7.4.3.8 Guide Rails and Fastenings. Where an alteration involves the installation of guide rails, the guide rails and fastenings shall comply with 4.3.18.1, 4.3.18.2, and 4.3.18.3.

8.7.4.3.9 Overhead Beams and Supports. Where the alteration involves a change in the arrangement of or load on the overhead beams and sheaves, the new arrangement shall conform to 4.3.5.1 and 4.3.5.2, except that wood shall be permitted to be retained if it is structurally sound.

8.7.4.3.10 Power Attachments. No alteration shall implement the use of a power other than hand power.

8.7.5 Alterations to Special Application Elevators

8.7.5.1 Inclined Elevators. Where any alteration is made to an inclined elevator, the entire installation shall comply with 5.1.

8.7.5.2 Limited-Use/Limited-Application Elevators. Reserved.

8.7.5.3 Private Residence Elevators

8.7.5.3.1 When a building code occupancy classification of a private residence is changed in which a private residence elevator is located, the elevator shall comply with the applicable requirements in Parts 2, 3, 4, or Section 5.2.

8.7.5.4 Private Residence Inclined Elevators

8.7.5.4.1 When a building code occupancy classification of a private residence is changed in which a private residence inclined elevator is located, the elevator shall comply with the applicable requirements in Parts 2, 3, 4, or Section 5.1.

8.7.5.5 Power Sidewalk Elevators

8.7.5.5.1 Changes in Electrical Wiring or Electrical Equipment. Where electrical wiring or equipment is installed as part of an alteration, it shall conform to 5.5.1.8.

8.7.5.5.2 Sidewalk Door. Where a sidewalk door is installed as part of an alteration, it shall conform to 5.5.1.11.2, 5.5.1.11.3, and 5.5.1.11.4.

8.7.5.5.3 Change in Car Enclosure, Car Doors, and Gates. Where the car enclosure, car door, or car gate is installed as part of an alteration, it shall conform to 5.5.1.14.

8.7.5.5.4 Bow Irons and Stanchions. Where the bow iron and stanchion is installed as part of an alteration, it shall conform to 5.5.1.15.2.

8.7.5.5.5 Increase in Rated Load. Where the alteration consists of an increase in rated load, the bottom and top clearances and runbys shall conform to 5.5.1.16, 5.5.1.18, 5.5.1.21, and 5.5.1.25.4.

8.7.5.5.6 Increase in Rated Speed. Where the alteration consists of an increase in rated speed, the capacity and loading shall conform to 5.5.1.15, 5.5.1.16, 5.5.1.19, and 5.5.1.22.

8.7.5.5.7 Existing Driving Machine. Where the driving machine is installed as part of an alteration, it shall conform to 5.5.1.8, 5.5.1.9, 5.5.1.23, and 5.5.1.25.

8.7.5.5.8 Change in Type of Operating Devices and/or Control Equipment. Where the alteration consists of a change in the existing type of operation or control equipment, or both, the new operating devices and control equipment shall conform to 5.5.1.8 and 5.5.1.25.

8.7.5.6 Rooftop Elevators. Where any alteration is made to a rooftop elevator, the entire installation shall comply with 5.6.

8.7.5.7 Special Purpose Personnel Elevators. Where any alteration is made to a special purpose personnel elevator, the entire installation shall comply with 5.7.

8.7.5.8 Shipboard Elevators. Where any alteration is made to a shipboard elevator, the entire installation shall comply with 5.8.

8.7.5.9 Mine Elevators

8.7.5.9.1 General Requirements. Where any alteration is made to a mine elevator, the alteration shall conform to the requirements of 8.7.1 and 8.7.2, except as modified by 5.9.

8.7.5.9.2 Ascending Car Overspeed and Unintended Car Movement Protection. Ascending car overspeed and unintended car movement protection shall be provided and shall conform to 2.19.

8.7.5.9.3 Car Top Protection. The car top access panel size requirements in 5.9.14.1(b) do not apply where the existing car top is retained. The dimensions of the existing car top access panel shall not be reduced by the alteration.

- (13) **8.7.5.10 Outside Emergency Elevators.** Where an alteration is made to an outside emergency elevator, the alteration shall conform to the requirements of 8.7.1 and ASME A17.7/CSA B44.7, requirement 2.12.2.

8.7.6 Alterations to Escalators and Moving Walks

8.7.6.1 Escalators

8.7.6.1.1 General Requirements. A change in component parts that are interchangeable in form, fit, and function is not considered an alteration and need not comply with the requirements in this Section. See 8.6.3.1.

The addition of a component or a device that was not part of the original design is an alteration and must conform to the requirements of 8.7.6.1 for that device or component.

When multiple driving machines per escalator are utilized, operating and safety devices required by 8.7.6.1 shall simultaneously control all driving machines.

The requirements of 6.1.3.6.5 do not apply to existing escalators that were not required to comply with this requirement at the time of the original installation.

8.7.6.1.2 Relocation of Escalator. Where an escalator is relocated, it shall comply with 6.1. The requirements of 6.1.7.4.2 do not apply to electrical equipment unchanged by the relocation. The requirements of 6.1.3.6.5 do not apply to existing escalators that were not required to comply with this requirement at the time of the original installation.

8.7.6.1.3 Protection of Floor Openings. Any alteration to the floor openings in escalators shall comply with 6.1.1.1.

8.7.6.1.4 Protection of Trusses and Machinery Spaces Against Fire. Any alteration to the sides and/or undersides of escalator trusses and machinery spaces shall conform to 6.1.2.1.

8.7.6.1.5 Construction Requirements

(a) *Angle of Inclination.* No alteration of an escalator shall change the angle of inclination, as originally designed, by more than 1 deg.

(b) *Geometry.* Any alteration to the geometry of the escalator components shall conform to 6.1.3.2.

(c) *Balustrades.* Any alteration to the balustrades shall conform to 6.1.3.3 for the altered components.

(d) *Skirt Deflector Devices.* Any alteration or addition of skirt deflector devices shall conform to 6.1.3.3.10

NOTE [8.7.6.1.5(c)]: The balustrade does not include the handrail.

NOTE [8.7.6.1.5(d)]: The vertical dimensions on existing skirt panels may not allow full compliance. See 1.2.

8.7.6.1.6 Handrails. Any alteration to the handrails or handrail system shall require conformance with 6.1.3.2.2, 6.1.3.4.1 through 6.1.3.4.4, 6.1.3.4.6, 6.1.6.3.12, and 6.1.6.4.

8.7.6.1.7 Step System

(a) Any alteration to the step system shall require conformance with 6.1.3.3.5, 6.1.3.5 [except as specified in 8.7.6.1.7(b)], 6.1.3.6, 6.1.3.8, 6.1.3.9.4, 6.1.3.10.4, 6.1.3.11, 6.1.6.3.3, 6.1.6.3.9, 6.1.6.3.11, 6.1.6.3.14, and 6.1.6.5.

(b) Steps having a width less than 560 mm (22 in.) shall not be reduced in width by the alteration.

8.7.6.1.8 Combplates. Any alteration of the combplates shall require conformance with 6.1.6.3.13.

8.7.6.1.9 Trusses and Girders. Any alterations or welding, cutting, and splicing of the truss or girder shall conform to 8.7.1.4. Alterations shall result in the escalator's conforming to 6.1.3.7, 6.1.3.9.1, and 6.1.3.10.1.

The installation of a new escalator into an existing truss shall conform to all of the requirements of 6.1.

8.7.6.1.10 Step Wheel Tracks. Any alteration to the tracks shall result in the escalator's conforming with 6.1.3.8, 6.1.3.9.4, 6.1.3.10.1, and 8.7.1.4.

8.7.6.1.11 Rated Load and Speed. Any alteration that increases the rated load or rated speed or both shall result in the escalator's conforming with 6.1.

8.7.6.1.12 Driving Machine, Motor, and Brake

(a) *Driving Machine.* An alteration to the driving machine shall result in the escalator's conforming to 6.1.3.9.2, 6.1.3.10.3, 6.1.4.1, 6.1.5.1, 6.1.5.2, 6.1.5.3.1, 6.1.5.3.2, 6.1.6.3.4, and 6.1.6.3.8.

(b) *Driving Motor.* An alteration to the drive motor shall result in the escalator's conforming to 6.1.3.9.2,

6.1.3.10.3, 6.1.4.1, 6.1.5.2, 6.1.5.3.1, 6.1.5.3.2, 6.1.6.3.2, 6.1.6.3.8, and 6.1.6.3.10.

(c) *Machine Brake*. An alteration to the machine brake shall result in the escalator's conforming to 6.1.3.9.3, 6.1.3.10.2, and 6.1.5.3.1.

8.7.6.1.13 Operating and Safety Devices. Any alteration to or addition of operating and or safety devices shall conform to 6.1.6 for that device.

8.7.6.1.14 Lighting, Access, and Electrical Work. An alteration to or addition of lighting, access, or electrical work shall conform with the specific requirements within 6.1.7 for that change.

8.7.6.1.15 Entrance and Egress. Any alteration to the entrance or egress end shall comply with 6.1.3.6.1 through 6.1.3.6.4.

8.7.6.1.16 Controller. Where a controller is installed as part of an alteration, it shall conform to 6.1.6.10 through 6.1.6.15, and 6.1.7.4.

(13) **8.7.6.1.17 Variable Frequency Drive Motor Control.** Where the alteration consists of the addition of, or alteration to, a variable frequency drive motor control, the installation shall conform to 6.1.6.3.2 and 6.1.6.10.3.

8.7.6.2 Moving Walks

8.7.6.2.1 General Requirements. A change in component parts that are interchangeable in form, fit, and function is not considered an alteration and need not comply with the requirements in this Section. See 8.6.3.1.

The addition of a component or a device that was not part of the original design is an alteration and must conform to the requirements of 8.7.6.2 for that device or component.

When multiple driving machines per moving walk are utilized, operating and safety devices required by 8.7.6.2 shall simultaneously control all driving machines.

8.7.6.2.2 Relocation of Moving Walk. Where a moving walk is relocated, it shall comply with 6.2.

8.7.6.2.3 Protection of Floor Openings. Any alteration to the floor openings for moving walks shall comply with 6.2.1.1.

8.7.6.2.4 Protection of Trusses and Machinery Spaces Against Fire. Any alteration to the sides or undersides, or both, of moving walk trusses and machinery spaces shall conform to 6.2.2.1.

8.7.6.2.5 Construction Requirements

(a) *Angle of Inclination*. Alteration of a moving walk that increases the angle of inclination shall require conformance with 6.2.

(b) *Geometry*. Any alteration to the geometry of the moving walk components shall require conformance with 6.2.3.2.

(c) *Balustrades*. Any alteration to the balustrades shall require conformance with 6.2.3.3.

NOTE [8.7.6.2.5(c)]: The balustrade does not include the handrail.

8.7.6.2.6 Handrails. An alteration to the handrails or handrail system shall require conformance with 6.2.3.2.3, 6.2.3.4, 6.2.6.3.10, and 6.2.6.4.

8.7.6.2.7 Treadway System

(a) An alteration to the treadway system shall require conformance with 6.2.3.2.3, 6.2.3.3.5, 6.2.3.3.6, 6.2.3.5, 6.2.3.6 [except as specified in 8.7.6.2.7(b)], 6.2.3.8, 6.2.3.9, 6.2.3.10.4, 6.2.3.11.4, 6.2.3.11.5, 6.2.3.12, 6.2.6.3.3, 6.2.6.5, and 6.2.6.3.9.

(b) The minimum width of the moving walk shall be permitted to be less than that required by 6.2.3.7. The existing width, if less than required by 6.2.3.7, shall not be decreased by the alteration.

8.7.6.2.8 Complates. An alteration of the complates shall require conformance with 6.2.3.8 and 6.2.6.3.11.

8.7.6.2.9 Trusses and Girders. Any alterations or welding, cutting, and splicing of the truss or girder shall conform to 8.7.1.4. Alterations shall result in the moving walk's conforming to 6.2.3.9, 6.2.3.10.1, and 6.2.3.11.1. The installation of a new moving walk into an existing truss shall conform to all of the requirements of 6.2.

8.7.6.2.10 Track System. Any alteration to the tracks shall result in the moving walk's conforming to 6.2.3.9, 6.2.3.10, 6.2.3.11.1, and 8.7.1.4.

8.7.6.2.11 Rated Load and Speed. Any alteration that increases the rated load or rated speed or both shall result in the moving walk's conforming to 6.2.

8.7.6.2.12 Driving Machine, Motor, and Brake

(a) *Driving Machine*. An alteration to the driving machine shall result in the moving walk's conforming to 6.2.3.10.2, 6.2.3.11.2, 6.2.3.11.3, 6.2.3.14, 6.2.3.15, 6.2.4, 6.2.5.1, 6.2.5.3.1, 6.2.5.3.2, 6.2.6.3.4, and 6.2.6.3.8.

(b) *Drive Motor*. An alteration to the drive motor shall result in the moving walk's conforming to 6.2.3.10.2, 6.2.3.11.2, 6.2.3.11.3, 6.2.4, 6.2.5.2, 6.2.5.3.1, 6.2.6.3.2, 6.2.6.3.7, and 6.2.6.3.8.

(c) *Machine Brake*. An alteration to the machine brake shall result in the moving walk's conforming to 6.2.3.10.3, 6.2.3.11.2, 6.2.3.12.3, 6.2.5.3.1, and 6.2.5.3.2.

8.7.6.2.13 Operating and Safety Devices. An alteration to or addition of operating and/or safety devices shall conform with the specific requirements within 6.2.6 for that device.

8.7.6.2.14 Lighting, Access, and Electrical Work. An alteration to or addition of lighting, access, or electrical work shall conform with the specific requirements within 6.2.7 for that change.

8.7.6.2.15 Controller. Where a controller is installed as part of an alteration, it shall conform to 6.2.6.9 through 6.2.6.14, and 6.2.7.4.

- (13) **8.7.6.2.16 Variable Frequency Drive Motor Control.** Where the alteration consists of the addition of, or alteration to, a variable frequency drive motor control, the installation shall conform to 6.2.6.3.2 and 6.2.6.9.3.

8.7.7 Alterations to Dumbwaiters and Material Lifts

8.7.7.1 Dumbwaiters and Material Lifts Without Automatic Transfer Devices

8.7.7.1.1 General. When any alteration is made to a dumbwaiter or material lift, all work performed as part of the alteration shall comply with 7.1 through 7.6.

8.7.7.1.2 Increase in Rated Load. Where an alteration involves an increase in the rated load, the installation shall conform to either of the following:

- (a) Requirement 7.2, except 7.2.1 for hand and electric dumbwaiters
- (b) Requirement 7.3, except 7.3.4.1 for hydraulic dumbwaiters

8.7.7.2 Addition of Automatic Transfer Device.

Where an automatic transfer device is installed on an existing elevator or dumbwaiter, the resultant combination of material lift or dumbwaiter with automatic transfer device shall conform to Part 7.

8.7.7.3 Material Lifts and Dumbwaiters With Automatic Transfer Devices

8.7.7.3.1 Where any alteration is made to a material lift or dumbwaiter with an automatic transfer device, the entire installation shall comply with 7.7 through 7.10.

8.7.7.3.2 Where an automatic transfer device is removed from a material lift and is not replaced, the installation shall conform to 7.4, Material Lift Without Transfer Device.

8.7.7.3.3 Where a material lift is altered to be an elevator, it shall comply with Part 2 or Part 3.

8.7.7.3.4 Where a material lift or dumbwaiter with an automatic transfer device is altered to a dumbwaiter, it shall comply with 7.1 through 7.3.

SECTION 8.8 WELDING

8.8.1 Qualification of Welders

Where required elsewhere in this Code, welding of parts, except for tack welds later incorporated into finished welds, shall be undertaken

(a) by welders qualified in accordance with the requirements of Section 4 of ANSI/AWS D1.1, whereby the welders shall be qualified by the manufacturer or

contractor; a professional consulting engineer; or a recognized testing laboratory; or

(b) by a fabricator qualified to the requirements of CSA W47.1, whichever is applicable (see Part 9).

8.8.2 Welding Steel

Where required elsewhere in this Code, welding shall conform to either of the following, whichever is applicable (see Part 9):

(a) the design and procedure requirements of the applicable section of ANSI/AWS D1.1 or ANSI/AWS D1.3

(b) the design and procedure requirements of CSA W59

8.8.3 Welding Metals Other Than Steel

Where required elsewhere in this Code, welding of materials other than steel shall be done in accordance with the latest AWS or CSA requirements applicable to the specific materials used.

SECTION 8.9 CODE DATA PLATE

Requirement 8.9 contains requirements for all new and existing equipment within the Scope of this Code.

8.9.1 Required Information

(13)

An individual data plate shall be provided and maintained for each unit (see 1.1.1). The data plate shall indicate the Code to be used for inspections and tests (see 8.10.1.2). The data plate shall indicate the Code and edition in effect at the time of installation. The data plate shall also indicate the Code in effect at the time of any alteration and indicate the applicable requirements of 8.7. Where the installation or alteration contains SIL rated devices, the following wording, "Installation contains SIL rated devices," shall be included on the data plate or on an additional plate located adjacent to the Code Data Plate.

8.9.2 Location

The data plate shall be in plain view, securely attached to each main line disconnect or controller. It shall also be permitted to locate the data plate in the controller as long as it is in plain view with the controller door open. An additional data plate shall be installed in the vicinity of one of the starting switches on the exterior of escalators and moving walks.

8.9.3 Material and Construction

The data plate shall be of such material and construction that the letters and figures stamped, etched, cast, or otherwise applied to the face shall remain permanently and readily legible. The height of the letters and figures shall be not less than 3.2 mm (0.125 in.).

All data plates not located in the controller shall be provided with either

(a) a durable means to prevent common contaminants (such as paint, adhesives, oil, and grease) from adhering to the data plate parent surface and permit the removal of these contaminants, without obscuring the Code-required data, or

(b) letters and figures that are raised or depressed a minimum of 0.8 mm (0.03125 in.) from the plate surface face, and have a minimum character-stroke width of 0.5 mm (0.02 in.)

If the plates are exposed to weathering or a chemical atmosphere, then a durable means shall be provided to protect the information from deterioration while permitting the information to be easily read.

(13)

SECTION 8.10 ACCEPTANCE INSPECTIONS AND TESTS

Requirement 8.10 covers acceptance inspections and tests of new or altered installations.

NOTES (8.10):

- (1) Compliance with certain requirements is verifiable through review of design documents, engineering, or type tests.
- (2) Category 5 tests utilizing alternative test methods require a comparison against baseline measures made during acceptance inspection tests. See 8.6.11.10 if alternative test methods are contemplated on future Category 5 tests.

8.10.1 General Requirements for Acceptance Inspections and Tests

8.10.1.1 Persons Authorized to Make Acceptance Inspections and Tests

8.10.1.1.1 The acceptance inspection shall be made by an inspector employed by the authority having jurisdiction, or by a person authorized by the authority having jurisdiction.

8.10.1.1.2 The person installing or altering the equipment shall perform all of the tests required by 8.10.2 through 8.10.5 in the presence of the inspector specified in 8.10.1.1.1.

(13)

8.10.1.1.3 The inspector shall meet the qualification requirements of ASME QEI-1. Inspectors and inspection supervisors shall be certified by an independent, accredited, certifying organization as specified in 8.10.1.2 (see 1.3).

(13)

8.10.1.1.4 Acceptance Test Tags. A metal tag with the applicable Code requirement(s) and date(s) performed, and the name of the person or firm performing the test and the inspector witnessing the test, including their inspector's ID number and certifying organization, shall be installed to be readily visible and shall be permanently attached to the controller of each unit.

8.10.1.1.5 Acceptance Test Records. A permanent test record showing the test dates, the requirement number for each test, the name of the person or firm performing the test, the inspector's name that witnessed the tests, their inspector's ID number and certifying organization, shall be made a permanent part of the maintenance records (8.6.1.4.1). The test record shall document all applicable acceptance tests shown in Nonmandatory Appendix X (Tables X-1 through X-4). (13)

8.10.1.2 Accreditation of Certifying Organizations. (13)

All organizations that certify elevator inspectors and inspection supervisors shall be accredited by an accrediting body (see 1.3) in accordance with ANSI/ISO/IEC 17024, or equivalent, and ASME QEI-1.

8.10.1.3 Applicability of Inspection and Test Requirements. Inspections and tests required by 8.10.2 through 8.10.5 are to determine that the equipment conforms with the following applicable requirements: (13)

- (a) the Code at the time of installation
- (b) the Code effective as applicable to and for each alteration
- (c) the ASME A17.3 Code if adopted by the authority having jurisdiction

NOTES (8.10.1.3):

- (1) The ASME A17.2 *Guide for Inspection of Elevators, Escalators, and Moving Walks* (see Preface, ASME Elevator Publications) is a guide for inspections and tests.
- (2) References to "Items" of the *Guide for Inspection of Elevators, Escalators, and Moving Walks* and to the requirements of this Code are indicated in parentheses as a convenient reference to the applicable testing procedures and requirements. It is important to understand that suggested test and inspection methodologies represent an approach but are neither exclusive nor comprehensive.

8.10.1.4 Making Safety Devices Inoperative or Ineffective. No person shall at any time make any required safety device or electrical protective device inoperative or ineffective, except where necessary during tests and inspections. Such devices shall be restored to their normal operating condition in conformity with the applicable requirements prior to returning the equipment to service (see 2.26.7). (13)

8.10.1.5 Unique or Product-Specific Procedures or Methods. Where unique or product-specific procedures or methods are required to maintain, repair, replace, inspect, or test equipment, such procedures or methods shall be provided by the manufacturer or installer [see 8.6.1.2.2(b)]. (13)

8.10.1.6 Maintenance Control Program. The Maintenance Control Program complying with 8.6.1.2.1 shall be available at the time of inspection. On-site equipment documentation complying with 8.6.1.2.2 shall be available at the time of inspection. (13)

8.10.2 Acceptance Inspection and Tests of Electric Elevators

8.10.2.1 Inspection and Tests Required. New installations shall be inspected and tested as required by 8.10.2.2 before being placed in service.

Altered installations shall be inspected as specified in 8.10.2.3.1. Altered installations shall be tested as specified in 8.10.2.3.2 before being placed back in service.

8.10.2.2 Inspection and Test Requirements for New Installations

(13) 8.10.2.2.1 Inside Car

- (ED)
- (a) Door Reopening Device (2.13.5) (Item 1.1)
 - (b) Stop Switches (Item 1.2)
 - (1) emergency stop switch (2.26.2.5)
 - (2) in-car stop switch (2.26.2.21)
 - (c) Operating Control Devices (Item 1.3)
 - (1) operating devices (2.26.1.1, 2.26.1.2, and 2.26.1.6)
 - (2) in-car inspection (2.26.1.4.3)
 - (3) inspection operation with open door circuits (2.26.1.5)
 - (d) Car Floor and Landing Sill (Item 1.4)
 - (1) car floor (2.15.5)
 - (2) clearance (2.5.1.4 and 2.5.1.5)
 - (3) landing sill guard, illumination, and hinging (2.11.10)
 - (4) car hinged sills (2.15.16)
 - (e) Car Lighting (2.14.7) (Item 1.5)
 - (1) normal illumination (2.14.7)
 - (2) auxiliary lighting system (2.14.7.1.3)
 - (f) Car Emergency Signal (2.27.1 and 2.11.1.3) (Item 1.6)
 - (g) Car Door or Gate (Item 1.7)
 - (1) closed position (2.14.4.11)
 - (2) contact or interlock (2.14.4.2, 2.26.2.15, 2.26.2.28)
 - (3) car landing door clearances (2.14.4.5)
 - (4) car door guides (2.14.4.6)
 - (5) passenger car door (2.14.5)
 - (6) freight car door or gate (2.14.6)
 - (h) Door Closing Force Test (2.13.4) (Item 1.8)
 - (i) Power Closing of Doors or Gates (2.13.3) (Item 1.9): Test Closing Time Per Data Plate (2.13.4.2.4)
 - (j) Power Opening of Doors or Gates (Item 1.10)
 - (1) *Power Opening of Doors* (2.13.2). Determine that power opening of car and hoistway doors only occurs when the car is at rest at the landing, or in the landing zone, except in the case of static control, check that the power shall not be applied until the car is within 300 mm (12 in.) of the landing.
 - (2) *Leveling Zone and Leveling Speed* (2.16.1.6.3). Check that the leveling zone does not exceed the maximum allowable distance. Check that the leveling speed does not exceed 0.75 m/s (150 ft/min). In addition, for static control elevators, the person or firm installing the

equipment shall provide a written checkout procedure and demonstrate that the leveling speed with the doors open is limited to a maximum of 0.75 m/s (150 ft/min) and that the speed limiting (or speed monitor) means is independent of the normal means of controlling this speed (2.26.1.6.6).

(3) *Inner Landing Zone* (2.26.1.6.7). For static control elevators, check that the zone in which the car can move with the doors open is not more than 75 mm (3 in.) above or below the landing [Item 1.10.2(c)].

- (k) Car Vision Panels and Glass Car Doors (Item 1.11)
 - (1) vision panel (2.14.2.5)
 - (2) glass doors (2.14.5.9)
 - (3) access panels (2.14.2.6)
- (l) car Enclosure (Item 1.12)
 - (1) enclosure and lining materials (2.14.2.1 and 2.14.3.1)
 - (2) equipment prohibited inside car (2.14.1.9)
 - (3) classes of loading (2.16.2.2)
 - (4) passengers on freight elevators (2.16.4)
 - (5) identification in cars (2.29.1)
- (m) Emergency Exit (Items 1.13 and 1.20)
 - (1) car top (2.14.1.5)
 - (2) car side (2.14.1.10)
- (n) Ventilation (2.14.2.3 and 2.14.3.3) (Item 1.14)
- (o) Signs and Operating Device Symbols (2.26.12) (Item 1.15)
 - (p) Rated Load, Platform Area, and Data Plate (Item 1.16)
 - (1) rated load and platform area (2.16.1 and 2.16.2)
 - (2) capacity and data plates (2.16.3)
 - (3) signs in freight elevators (2.16.5 and 2.16.7)
 - (q) *Emergency or Standby Power Operation* (Item 1.17). Operation of elevators equipped with emergency or standby power shall be inspected and tested for conformance with the applicable requirements (2.16.8 and 2.27.2). Passenger elevators and freight elevators permitted to carry passengers shall be tested with 125% of rated load. Other freight elevators shall be tested with rated load. In addition, freight elevators with Class C2 loading shall be tested to ensure that the overload can be maintained during loading and unloading.
- (r) Means to Restrict Car Door Opening (2.14.5.7) (Item 1.18)
 - (s) Car Ride (2.23, 2.23.6, and 2.15.2) (Item 1.19)
 - (t) Door Monitoring Systems (2.26.5)
 - (u) Stopping Accuracy (2.26.11)
 - (v) Machinery Space/Control Space (8.10.2.2.2)
 - (w) Working Areas in the Car (2.7.5.1)
 - (1) means to prevent unexpected movement (2.7.5.1.1)
 - (2) Unexpected Car Movement Device (2.26.2.34)
 - (3) operating instructions for Unexpected Car Movement Device (8.6.10.6)

(4) operating instructions for egress and reentry procedure (8.6.10.7)

(x) Equipment Access Panel Electrical Device (2.26.2.35)

(13) 8.10.2.2.2 Machine Room/Spaces, Control Room/
(ED) Spaces

NOTE: A machinery space outside the hoistway containing an electric driving machine and a motor controller is a machine room (2.7).

(a) Location of Rooms/Spaces (2.7.6.1 and 2.7.6.2)

(b) Location of Equipment (2.7.6.3)

(c) Equipment Exposure to Weather (2.7.6.6)

(d) Means of Access (Item 2.1)

(1) access (2.7.3.1 through 2.7.3.4)

(2) door fire-protection rating (2.7.1.1)

(e) Headroom (2.7.4) (Item 2.2)

(f) Means Necessary for Tests (2.7.6.4)

(g) Inspection and Test Panel (2.7.6.5)

(h) Lighting and Receptacles (Item 2.3)

(1) lighting (2.7.9.1)

(2) receptacles (NFPA 70 or CSA-C22.1, as applicable)

(i) Enclosure of Machine Room/Spaces, Control Room/Spaces (Item 2.4)

(1) floors (2.1.3 and 2.7.1.3)

(2) enclosure (2.7.1 and 2.8.1)

(j) Housekeeping (2.8.1) (Item 2.5)

(k) Ventilation and Heating (2.7.9.2) (Item 2.6)

(l) Fire Extinguisher (8.6.1.6.5) (Item 2.7)

(m) Pipes, Wiring, and Ducts (2.8) (Item 2.8)

(n) Guarding of Exposed Auxiliary Equipment (2.10.1) (Item 2.9)

(o) Numbering of Elevators, Machines, and Disconnect Switches [2.29.1(a) through (f)] (Item 2.10)

(p) Maintenance Path and Maintenance Clearance (2.7.2)

(q) Stop Switch (2.7.3.5 and 2.26.2.24)

(r) Disconnecting Means and Control (2.26.4.1 and NFPA 70 or CSA-C22.1, as applicable) (Item 2.11)

(s) Controller Wiring, Fuses, Grounding, etc. (Item 2.12)

(1) wiring (2.26.4.1)

(2) fuses (2.26.4.1)

(3) grounding (2.26.1 and NFPA 70 or CSA-C22.1, as applicable)

(4) phase-protection (2.26.6)

(5) certification (2.26.4.2)

(6) clearances (NFPA 70 or CSA-C22.1, as applicable)

(7) capacitors or devices (2.26.7)

(t) Control Circuits, Including Static Control (Item 2.15).

The person or firm installing the elevator shall demonstrate or document conformance with the following:

(1) general (2.26.9.1, 2.26.9.2, and 2.26.9.8)

(2) redundancy and its checking (2.26.9.3 and 2.26.9.4)

(3) static control without motor generator sets (2.26.9.5 and 2.26.9.6)

(4) installation of Capacitors or Other Devices to Make Electrical Protective Devices Ineffective (2.26.6)

(u) Machinery Supports and Fastenings (2.9.1 and 2.9.3) (Item 2.16)

(v) *Braking System*. For passenger elevators and all freight elevators, the brake shall be tested for compliance with applicable requirements. Place the load as shown in Table 8.6.4.20.4 in the car and run it to the lowest landing by normal operating means. The driving machine shall safely lower, stop, and hold the car with this load. Freight elevators of Class C2 loading shall sustain and level the elevator car (2.16.6) (Item 2.17). The means of adjusting the holding capacity of the brake shall be sealed to prevent changing the adjustment without breaking the seal. The seal shall bear or otherwise attach the identification of the person or firm that installed it (see also 8.6.1.7.2, Periodic Test Tags).

(1) braking system (2.24.8.2.2)

(2) electromechanical brake (2.24.8.3)

(3) marking plate (2.24.8.5)

(w) Drive Machines (2.24.1, 2.24.4, 2.24.5, and 2.24.9) (Item 2.18)

(x) Gears, Bearings, and Flexible Connections (2.24.6, 2.24.7, and 2.24.10) (Item 2.19)

(y) Winding Drum Machine (Item 2.20)

(1) where permitted (2.24.1)

(2) drum diameter (2.24.2.1 and 2.24.2.2)

(3) slack-rope device shall be tested by creating slack rope (2.26.2.1)

(4) spare rope turns (2.20.7)

(5) securing of ropes to drums (2.20.6)

(6) final terminal stopping devices (2.25.3.5)

(z) Belt- or Chain-Drive Machine (2.24.9) (Item 2.21)

(aa) Motor Generator (2.26.9.7) (Item 2.22)

(bb) Absorption of Regenerated Power (2.26.10) (Item 2.23)

(cc) Traction Sheaves (Item 2.25)

(1) diameter (2.24.2.1, 2.24.2.2, and 2.24.2.4)

(2) grooves (2.24.2.1)

(3) traction limits (2.20.8.1, 2.24.2.3, and 2.16.6) shall be verified

(a) During an emergency stop initiated by any of the electrical protective devices listed in 2.26.2 (except 2.26.2.13), at the rated speed in the down direction, with passenger elevators and freight elevators permitted to carry passengers carrying 125% of their rated load, or with freight elevators carrying their rated load, there shall be sufficient traction to safely stop and hold the load.

(b) Traction shall slip, or the driving machine shall stall, if either the car or the counterweight bottoms on its buffer.

(c) Conformance with the traction-loss detection means specified in 2.20.8.1 shall be demonstrated by

(1) causing relative motion between the drive sheave and suspension means either by bottoming the car or counterweight [see 8.10.2.2.2(cc)(3)(b)], or

(2) an alternative test provided in the Maintenance Control Program [see 8.6.1.2.1(f)] or by the installer and acceptable to the authority having jurisdiction

NOTE [8.10.2.2.2(cc)(3)(b) and 8.10.2.2.2(cc)(3)(c)]: Demonstration need not involve an actual loss of traction, for example, where the method of protection used to meet 2.20.8.1 prevents a loss of traction.

(dd) Secondary and Deflector Sheaves (2.24.2) (Item 2.26)

(ee) Rope Fastenings (2.9.3.3, 2.20.5, and 2.20.9) (Item 2.27)

(ff) *Terminal Stopping Devices (Item 2.28)*. The following tests are performed with an empty car in the up direction and the car loaded with rated load or 125% of rated load in the down direction (see 2.16.8).

(1) Test normal terminal stopping device for conformance with 2.25.2 by making inoperative the normal stopping means. The final terminal stopping device and the emergency terminal speed-limiting device shall remain operative.

(2) Test emergency terminal speed-limiting device for conformance with 2.25.4.1.

(3) For static control elevators, see 2.25.4.2. [See also 8.10.2.2.3(g) and (h).]

(gg) Operating Devices

(1) inspection operation (2.26.1.4.4)

(2) inspection operation with open door circuits (2.26.1.5)

(3) additional operation devices (2.26.1.3)

(hh) Governor, Overspeed Switch, and Seal (Item 2.13)

(1) The tripping speed of the governor and the speed at which the governor overspeed switch operates shall be tested to determine conformance with 2.18.2 and 2.18.4.

(2) The governor rope pull-through and pull-out forces shall be tested to determine conformance with 2.17.15 and 2.18.6. If adjustments are made to the governor it shall be sealed immediately following the test.

(3) The adjustable means shall be sealed (2.18.3).

(4) A marking plate conforming to 2.18.9 shall be attached at the governor.

(5) Access and securing of car, if applicable (2.7.6.3.4)

(ii) Car and Counterweight Safeties (Item 2.29)

(1) General Requirements for Types A, B, and C Safeties. The following requirements apply to the acceptance tests of Types A, B, and C safeties (Item 2.29):

(a) Car safeties shall be tested with rated load in the car. In making the test of car safeties, the load shall be

centered on each quarter of the platform symmetrically with respect to the centerlines of the platform. Counterweight safeties, where provided, shall be tested with no load in the car.

(b) The car speed at which the governor trips shall be determined by means of a tachometer or other device designed to measure car speed and, if necessary, the governor shall be replaced or adjusted to conform to 2.18.2.

(c) If adjustments to the tripping speed are made, the governor shall be sealed immediately following the test. Governors shall be sealed, as required by 2.18.3.

(d) The operation of the governor overspeed and the car safety-mechanism switch shall be tested to determine conformance with 2.18.4 and 2.17.7.

(e) After the safety has stopped the car, the level of the car platform shall be checked to determine conformance with 2.17.9.2.

(f) A metal tag with the rule number, test date, and name of the person/firm performing the test shall be attached to the releasing carrier or where the governor rope attaches to the safety.

(2) Type A Governor-Operated Safeties

(a) Type A governor-operated safeties shall be tested by operating the car at its rated speed in the down direction and manually tripping the governor jaws. A test shall also be made of the inertia application of the safety to determine conformance with 2.17.8.1, by attaching the proper weight to the return run of the governor rope. The manufacturer shall inform the person making the test of the weight necessary to be added to the governor rope when making the inertia application test. This weight shall be that necessary to reproduce inertia operation of the safety at not more than $\frac{1}{10}$ gravity. The inertia application test shall be made with the car stationary, and the weight, when released, shall move the safety parts into contact with the rails. See Nonmandatory Appendix M, Fig. M-1, for location of weight to be attached to the governor rope when making the inertia test. Inertia application of the safety on the Type A auxiliary safety plank of Type C safeties is not required.

(b) If means other than inertia application of the safety is provided, such means shall be tested in an appropriate manner to ensure that the safety will apply without appreciable delay under free-fall condition and that the safety application is independent of the location of the break in the hoisting ropes.

(3) *Type A Safeties Without Governors*. Type A safeties without governors that are operated only as a result of the breaking or slackening of the suspension ropes shall be tested by obtaining the necessary slack rope to cause it to function.

(4) Types B and C Safeties

(a) Types B and C safeties shall be subjected to an overspeed test, with the suspension ropes attached,

by gradually increasing the speed of the car until the governor causes application of the safety.

Safeties of elevators equipped with AC driving-machine motors, where the car with its rated load does not cause sufficient overspeed when the machine brake is released to trip the governor jaws, shall be tested by operating the car at its rated speed in the down direction and tripping governor jaws by hand; see 8.10.2.2.2(hh) for test of governor tripping speed.

(b) The overspeed switch on the governor shall be inoperative during the overspeed test. In order to ensure that the safety will retard the car with the minimum assistance from the elevator driving machine and minimize the development of slack rope and fallback of the counterweight, the switch on the car operated by the car safety mechanism shall, for the duration of the test, be temporarily adjusted to open as close as possible to the position at which the car safety mechanism is in the fully applied position.

(c) The stopping distances for Type B safeties shall conform to 2.17.3, and shall be determined by measuring the length of the marks made by the safety jaws or wedges on both sides of each car guide rail, deducting the length of the safety jaw or wedge used, and taking the average of the four readings.

(d) For Type B safeties, the movement of the governor rope to operate the safety mechanism shall be tested to determine conformance with 2.17.11.

(e) For Type C safeties, the stopping distance shall be equal to the stroke of the buffer located between the lower member of the car frame and the auxiliary safety plank, and shall conform to 2.17.8.2. After the safety has stopped the car, the level of the auxiliary safety plank shall be checked to determine conformance with 2.17.8.2.6.

(f) For Type C safeties, the buffer compression switch and oil level devices shall be tested to determine conformance with 2.17.8.2.7 and 2.17.8.2.8.

(jj) Ascending Car Overspeed, and Unintended Car Motion Protection

(1) *Ascending Car Overspeed Protection.* The means to prevent ascending car overspeed shall be inspected and tested with no load in the car to verify conformance with 2.19.1.2.

(2) *Unintended Car Motion.* The means to prevent unintended car motion shall be inspected and tested to verify conformance with 2.19.2.2.

(kk) *Speed.* The speed of the car shall be verified with and without rated load, in both directions (2.16.3.2).

(ll) Code Data Plate (8.9) (Item 2.14)

(mm) Emergency Brake (2.19.3)

(nn) Wiring Diagrams [8.6.1.2.2(a)]

(oo) *AC Drives From a DC Source (Item 2.24).* The person or firm that installed the AC drive from a DC source shall demonstrate compliance with 2.26.9.6 (Item 2.24.3).

(pp) Emergency Brake (2.19.3.2)

(qq) Rope Retainers or Restraints for Seismic Risk Zones (Item 2.42)

(rr) Seismic and Displacement Switches Operation and Door Operation (Item 2.42)

(ss) Testing of Broken-Suspension and Residual-Strength Detection Means

(1) The broken-suspension-member detection means shall be tested by simulating a slack suspension member or a loss of a suspension member as appropriate (2.20.8.2).

(2) Suspension-member residual-strength detection means shall be tested to simulate a reduction of residual strength to 2.20.8.3.

8.10.2.2.3 Top-of-Car

(a) Top-of-Car Stop Switch (2.26.2.8) (Item 3.1)

(b) Car Top Light and Outlet (2.14.7.1.4) (Item 3.2)

(c) Top-of-Car Operating Device and Equipment (Item 3.3)

(1) top-of-car inspection operation (2.26.1.4.2)

(2) equipment on car top (2.14.1.7)

(3) inspection operation with open door circuits (2.26.1.5)

(d) Top-of-Car Clearance and Refuge Space (Item 3.4)

(1) top-of-car clearance (2.4.6 through 2.4.8, and 2.4.10)

(2) refuge space and marking (2.4.12)

(3) guard rails (2.14.1.7.1)

(e) Top Counterweight Clearance (2.4.9) (Item 3.24)

(f) Car, Overhead, and Deflector Sheaves (2.24.2) (Item 3.25)

(g) *Normal Terminal Stopping Devices (Item 3.5).* Verify location and type of switches (2.25.2). [See also 8.10.2.2.2(ff).]

(h) *Final Terminal Stopping Devices (Item 3.6).* Verify location and type of switches for conformance with 2.25.3 and 2.26.4.3.

(i) *Broken Rope, Chain, or Tape Switch (Item 3.26).* Verify for conformance with 2.25.2.3.2, 2.26.2.6, and 2.26.4.3.

(j) Car Leveling Devices (2.26.1.6) (Item 3.7)

(k) Data Plate (2.16.3.3 and 2.20.2) (Item 3.27)

(l) Top Emergency Exit (2.14.1.5 and 2.26.2.18) (Item 3.8)

(m) Counterweight and Counterweight Buffer (2.21 and 2.22) (Item 3.28)

(n) *Counterweight Safeties (Item 3.29).* Visually inspect counterweight safeties, including marking plate (2.17.4).

(o) Identification [2.29.1(g) and 2.29.2] (Item 3.9)

(p) Hoistway Construction (2.1) (Item 3.10)

(q) Hoistway Smoke Control (2.1.4) (Item 3.11)

(r) Pipes, Wiring, and Ducts (2.8) (Item 3.12)

(s) Windows, Projections, Recesses, and Setbacks (2.1.5, 2.1.6, and 2.11.10.1) (Item 3.12)

(t) Hoistway Clearances (2.4 and 2.5) (Item 3.12)

(u) Multiple Hoistways (2.1.1.4) (Item 3.15)

- (v) Traveling Cables and Junction Boxes (2.8.2 and NFPA 70 or CSA-C22.1, as applicable) (Item 3.16)
- (w) Door and Gate Equipment (Item 3.17)
 - (1) hoistway doors (2.11, 2.12, and 2.13)
 - (2) emergency doors (2.11.1.2)
 - (3) hoistway door fire-protection rating marking or labels (2.1.1.1.3 and 2.11.15.1)
 - (4) door safety retainers, location, and function (2.11.11.8)
 - (5) door closed position (2.12.2.2 and 2.12.3.2)
 - (6) hoistway Door Hanger (2.11.11.5.8 and 2.11.12.4.8)
 - (7) hoistway Door Locking Device (2.12.2.3, 2.12.2.5, 2.12.3.3, 2.12.3.5, 2.26.2.14, and 2.26.4.3)
- (x) Car Frame, Counterweight Guides and Stiles (2.15) (Item 3.18)
- (y) Guide Rails and Equipment (2.23) (Item 3.19)
 - (1) rail section (2.23.3)
 - (2) bracket spacing (2.23.4)
 - (3) surfaces and lubrication (2.23.6 and 2.17.16)
 - (4) joints and fish plates (2.23.7)
 - (5) bracket supports (2.23.9)
 - (6) fastenings (2.23.10)
- (z) *Governor Rope* (Item 3.20). Verify governor rope data tag complies with 2.18.5. Verify the governor rope is as specified on the speed governor marking plate (2.18.9). Verify clearance complies with 2.18.5 and 2.18.9(c).
 - (aa) Governor Releasing Carrier (2.17.15) (Item 3.21)
 - (bb) Wire Rope Fastening and Hitch Plate (Item 3.22)
 - (1) fastenings (2.20.9)
 - (2) car and counterweight hitch plate (2.17.13)
 - (3) overhead hitch plate (2.9.3.4)
 - (4) equalizers (2.20.5)
 - (cc) *Suspension Rope* (Item 3.23). Verify number and diameter and data tag (2.20.2 and 2.20.4)
 - (dd) Compensating Means (2.21.4) (Item 3.34)
 - (ee) Machinery Space/Control Space (8.10.2.2.2)
 - (ff) Working Areas on the Car Top (2.7.5.1)
 - (1) means to prevent unexpected movement (2.7.5.1.1)
 - (2) Unexpected Car Movement Device (2.26.2.34)
 - (3) operating instructions for Unexpected Car Movement Device (8.6.10.6)
 - (4) operating instructions for egress and reentry procedure (8.6.10.7)
 - (gg) Equipment Exposure to Weather (2.7.6.6)
 - (hh) Machinery Supports and Fastenings (2.9.1 and 2.9.3)
 - (ii) Guarding of Equipment (2.10.1)
 - (jj) For seismic risk zones, horizontal clearance for car and counterweight, snag-point clearance, and rail fastening
 - (kk) For seismic risk zones, snag guards, location of compensating ropes/chains, and traveling cables

8.10.2.2.4 Outside Hoistway

- (a) Car Platform Guard (Item 4.1)
 - (1) apron (2.15.9)
 - (2) car head guards (2.15.9.4)
- (b) Hoistway Doors (2.11) (Item 4.2)
 - (1) test of closed biparting doors (2.11.12.4.3 and 2.11.12.4.7)
 - (2) hoistway door (2.11) [see also 8.10.2.2.3(w)]
- (c) Vision Panels (2.11.7) (Item 4.3)
- (d) Hoistway Door Locking Devices (2.12.2.3, 2.12.2.5, 2.12.3.3, 2.12.3.5, 2.12.4.3, 2.26.2.14, and 2.26.4.3) [see also 8.10.2.2.3(w)] (Item 4.4)
- (e) access to Hoistway (Item 4.5)
 - (1) access for maintenance (2.12.6 and 2.12.7)
 - (2) access for emergency (2.12.6)
- (f) Power Closing of Hoistway Doors (2.13.1, 2.13.3, and 2.13.4) [See also 8.10.2.2.1(i)] (Item 4.6)
- (g) Sequence Operation (2.13.6 and 2.13.3.4) (Item 4.7)
- (h) Hoistway Enclosure (2.1.1) (Item 4.8)
- (i) Emergency and access hoistway openings (Item 4.10)
 - (1) blind hoistway emergency door (2.11.1.2 and 2.11.1.3)
 - (2) access openings for cleaning (2.11.1.4)
- (j) Separate Counterweight Hoistway (2.3.3) (Item 4.11)
- (k) Standby or Emergency Power Selection Switch (Item 4.12) (2.27.2 and 8.1). [See also 8.10.2.2.1(q)]
- (l) Location of Equipment (2.7.6.3)
- (m) Means Necessary for Tests (2.7.6.4)
- (n) Inspection and Test Panel (2.7.6.5), Inspection Operation (2.26.1.4.1), and Inspection Operation With Open Door Circuits (2.26.1.5)
- (o) Equipment Exposure to Weather (2.7.6.6)

8.10.2.2.5 Pit

- (a) General (Item 5.1)
 - (1) pit floor (2.2.2.2)
 - (2) drains, sumps and pumps (2.2.2.3, 2.2.2.4, and 2.2.2.5)
 - (3) guards between pits (2.3.2 and 2.2.3)
 - (4) counterweight guards (2.3.2)
 - (5) access to pit (2.2.4)
 - (6) access to underside of car (2.2.8)
 - (7) illumination (2.2.5)
 - (8) stop switch (2.2.6 and 2.26.2.7)
 - (9) pit depth (2.2.7)
 - (10) wiring, pipes, and ducts (2.8)
- (b) Bottom Clearance and Runby (Item 5.2)
 - (1) car bottom clearances (2.4.1)
 - (2) refuge space and marking (2.4.1.3, 2.4.1.4, and 2.4.1.6)
 - (3) car and counterweight runbys (2.4.2 and 2.4.4.)
 - (4) warning signs [2.4.4(b)]
 - (5) horizontal pit clearances (2.5.1.2 and 2.5.1.6)

(c) *Car and Counterweight Buffer (Item 5.9).* Marking plates shall be checked in accordance with 2.22.3.3 or 2.22.4.11 for proper application. No test shall be required on spring-type buffers. The following tests on oil-type buffers shall be performed (Item 5.9).

(1) The level of the oil shall be checked to determine that it is within the maximum and minimum allowable limits (see 2.22.4.6).

(2) Car and counterweight buffers shall be tested to determine conformance with the plunger return requirements of 2.22.4.5.

(3) The car oil buffer shall be tested by running the car with its rated load onto the buffer at rated speed, except as specified in 8.10.2.2.5(c)(4). The counterweight oil buffer shall be tested by running the counterweight onto its buffer at rated speed with no load in the car, except as specified in 8.10.2.2.5(c)(4).

(4) For reduced stroke buffers conforming to 2.22.4.1.2, these tests shall be made at the reduced striking speed.

(5) This acceptance test of the oil buffer is also required where Type C safety is used to assure adequate structure and pit bumper contact.

(6) In making these tests, the normal and emergency terminal stopping devices shall be made temporarily inoperative. The final terminal stopping devices shall remain operative and be temporarily relocated, if necessary, to permit full compression of the buffer during the test.

(d) *Final Terminal Stopping Devices (Item 5.3).* Verify location, operation, and type of switches for conformance with 2.25.3 and 2.26.4.3.

(e) *Normal Terminal Stopping Devices (Item 5.4).* Verify location, operation, and type of switches for conformance with 2.25.2 [see 8.10.2.2.2(ff)].

(f) *Traveling Cables (Item 5.6)* (2.8.2 and NFPA 70 or CSA-C22.1, as applicable)

(g) *Governor-Rope Tension Devices (2.18.7)* (Item 5.6)

(h) *Compensating Chains, Ropes, Rope Retainers, and Sheaves [Items 5.10 and 5.16.3(a)]*

(1) fastenings (2.21.4)

(2) sheave switches (2.26.2.3 and 2.26.4.3)

(3) tie-down (2.21.4.2)

(i) *Car Frame and Platform (Item 5.7)*

(1) frame (2.15.4 through 2.15.7, and 2.15.9)

(2) fire protection (2.15.8)

(j) *Car Safeties and Guiding Members (Item 5.8)*

(1) rope movement (2.17.11)

(2) marking plate (2.17.14)

(3) car guiding members (2.15.2)

(4) running clearances (2.17.10)

(k) *Machinery Space/Control Space (8.10.2.2.2)*

(l) *Working Areas in the Pit (2.7.5.2)*

(1) means to prevent unexpected movement [2.7.5.2.1(a) or (b)]

(2) Unexpected Car Movement Device (2.26.2.34)

(3) operating instructions for Unexpected Car Movement Device (8.6.10.6)

(4) operating instructions for egress and reentry procedure (8.6.10.7)

(m) *Equipment Exposure to Weather (2.7.6.6)*

(n) *Machinery Supports and Fastenings (2.9.1 and 2.9.3)*

(o) *Guarding of Exposed Auxiliary Equipment (2.10.1)*

(p) *Pit Inspection Operation (2.26.1.4.4)*

(q) *Snag guards for governor rope and traveling cables in seismic risk zones (Item 5.16.3)*

(r) *Verify information shown on layout drawing [Item 5.16.3(d)]*

8.10.2.2.6 Firefighters' Emergency Operation. Verify conformance with 2.27.3 through 2.27.8.

8.10.2.2.7 Working Platforms

(a) *Working Platforms (2.7.5.3 and 2.7.5.4)*

(1) operating instructions (8.6.10.8)

(b) *Retractable Stops (2.7.5.5)*

(1) retractable stop electrical device (2.26.2.37)

(c) *Inspection Operation (2.26.1.4.4)*

8.10.2.2.8 Functional Safety of SIL Rated (13) Device(s). Where an installation or alteration contains SIL rated devices, verify the Code Data Plate is marked

(see 8.9) and that SIL rated devices used to satisfy 2.26.4.3.2, 2.26.8.2, 2.26.9.3.2(b), 2.26.9.5.1(b), and 2.26.9.6.1(b) are identifiable on wiring diagrams (see 8.6.1.6.3) with part identification, certification identification information, and an SIL equal to or greater than the values indicated for the devices in Table 2.26.4.3.2, and 2.26.8.2 and 2.26.9, as applicable. The person or firm installing the equipment shall provide a written checkout procedure and demonstrate that SIL rated devices, safety functions (see Table 2.26.4.3.2), and related circuits operate as intended.

8.10.2.2.9 Occupant Evacuation Operation. Verify (13) conformance with 2.27.10.

8.10.2.3 Inspection and Test Requirements for Altered Installations

8.10.2.3.1 Alterations shall be inspected for compliance with the applicable requirements specified in 8.7. Check code data plate for compliance with 8.7.1.8.

8.10.2.3.2 Tests shall be performed when the following alterations are made:

(a) Where the alteration consists of the addition of power operation to the door system (see 8.7.2.12), tests shall be performed as specified in 8.10.2.2.1(h), (i), (j), and (t); 8.10.2.2.3(c)(3); 8.10.2.2.3(j) and (w); 8.10.2.2.4(b), and (d) through (g); and 8.10.2.2.6.

(b) Where alterations have been made to the car or counterweight guide rails, guide-rail supports, or guide-rail fastenings, or where the stresses have been increased

by more than 5% (8.7.2.24), tests shall be performed as specified in 8.10.2.2.1(s); 8.10.2.2.2(ii) and (jj); and 8.10.2.2.3(t), (x), and (y).

(c) Where alterations have been made to car or counterweight oil buffers (8.7.2.23), tests shall be performed as specified in 8.10.2.2.5(b) and (c).

(d) Where an alteration results in the increase in deadweight of the car that is sufficient to increase the sum of the deadweight and the rated load, as originally installed, by more than 5% (see 8.7.2.15.2), tests shall be performed as specified in 8.10.2.2.1(p) and (q); 8.10.2.2.2(v), (w), (x), (z), (aa), (bb), (cc)(3), (ff), (ii), (jj), and (kk); 8.10.2.2.3(k) and (x); and 8.10.2.2.5(c) and (i).

(e) Where the alteration consists of the installation of new car or counterweight safeties, or where alterations are made to existing safeties (see 8.7.2.18), tests shall be performed as specified in 8.10.2.2.2(hh) and (ii); 8.10.2.2.3(n), (y), and (aa); and 8.10.2.2.5(j).

(f) Where any alteration is made to a speed governor (see 8.7.2.19), tests shall be performed as specified in 8.10.2.2.2(hh), (ii)(1), (ii)(2), and (ii)(4); and 8.10.2.2.3(aa).

(g) Where an alteration involves an increase in the rated load (see 8.7.2.16.4), tests shall be performed as specified in 8.10.2.2.1(p), and (q); 8.10.2.2.2(v) through (bb), (cc)(3), (ff), (ii), (jj), and (kk); 8.10.2.2.3(k) and (x); and 8.10.2.2.5(c) and (i).

(h) Where alterations are made to a driving machine brake (see 8.7.2.25), tests shall be performed as specified in 8.10.2.2.2(v) and (cc)(3).

(i) Where the location of the driving machine has been changed (8.7.2.25.2), for alterations as described in 8.7.2.25.2(a), tests shall be performed as specified in 8.10.2.2.2(i), (n), (u), and (cc)(3). For alterations as described in 8.7.2.25.2(b), tests shall be performed as specified in 8.10.2.2.

(j) Where an alteration increases the rated speed (8.7.2.17.2), travel (8.7.2.17.1), rated load (8.7.2.4), type of service (8.7.2.16.1), class of loading (8.7.2.16.2), or from freight to passenger (8.7.2.16.3), tests shall be performed as specified in 8.10.2.2.1(c), (p), (q), and (s); 8.10.2.2.2(s), (t), (v), (aa), (bb), (cc), (dd), (ff), (hh), (ii), (jj), and (kk); 8.10.2.2.3(d), (e), (g), (h), (i), (k), (m), (n), and (cc); 8.10.2.2.4(e); and 8.10.2.2.5(b) through (e) and (j).

(k) Where an alteration is made to any terminal stopping device (8.7.2.26), tests shall be performed as specified in 8.10.2.2.2(ff); 8.10.2.2.3(g) and (h); and 8.10.2.2.5(c)(4), (d), and (e).

(l) Where an alteration is made to a standby or emergency power system (see 8.7.2.28), tests shall be performed as specified in 8.10.2.2.1(q) and 8.10.2.2.4(k).

(m) Where an alteration is made to firefighters' service operation (see 8.7.2.28), tests shall be conducted as specified in 8.10.2.2.6.

(n) Where an alteration increases or decreases the rise (see 8.7.2.17.1), tests shall be performed as specified in 8.10.2.2.2(ee) and (ff); 8.10.2.2.3(d) through (h), (t), (w),

and (y); 8.10.2.2.4(b), (c), (e) through (h), and (j); and 8.10.2.2.5(a), (b), (d), (e), (g), and (h).

(o) Where an alteration is made such that a hoistway entrance is added (see 8.7.2.10.1), tests shall be performed as specified in 8.10.2.2.1(a), (c)(3), (h), (i), (j), (r), and (t); 8.10.2.2.2(gg)(2); 8.10.2.2.3(c)(3), (o), and (w); 8.10.2.2.4(b) through (g), and (j); and 8.10.2.2.6.

(p) Where an alteration is made such that there is a change in class of loading (see 8.7.2.16.2), tests shall be performed as specified in 8.10.2.2.1(p); 8.10.2.2.2(v), (w), (cc), (ii), and (jj); and 8.10.2.2.5(i)(1).

(q) Where an alteration is made that results in a freight elevator being permitted to carry passengers (see 8.7.2.16.3), tests shall be performed as specified in 8.10.2.2.1(a), (g), (i), (j), (l), (p), and (q); and 8.10.2.2.2(v), (bb), (ff), (ii), (jj)(2), and (kk).

(r) Where an alteration is made that results in a new drive machine (see 8.7.2.25.1), tests shall be performed as specified in 8.10.2.2.2(o), (u) through (z), (cc), (dd), (jj), and (kk); and 8.10.2.2.1(q).

(s) Where a controller is installed as part of an alteration without any change to the type of operation or control (see 8.7.2.27.4), tests shall be performed as specified in 8.10.2.2.1(c), (j), (l)(5), (q), and (t); 8.10.2.2.2(r), (s), (t), (v), (aa), (bb), (ff), (gg), (jj), and (kk); 8.10.2.2.6; and 8.10.2.2.3(o).

(t) Where an alteration is made that results in a change in the type of motion or operation control (8.7.2.27.5 and 8.7.2.27.6), tests shall be performed as specified in 8.10.2.2.2(s) and (t). All electrical protective devices shall be tested for proper operation.

(u) Where an alteration is made that results in a new replacement of a hoistway door, car door, or car gate controller without any change to the operation or control [see 8.7.2.27.4(b)], tests shall be performed as specified in 8.10.2.2.1(i) and (j); and 8.10.2.2.2(s)(1), (s)(2), (s)(3), and (s)(5).

8.10.3 Acceptance Inspection and Tests of Hydraulic Elevators

8.10.3.1 Inspection and Tests Required. New installations shall be inspected and tested as required by 8.10.3.2 before being placed in service.

Altered installations shall be inspected as specified in 8.10.3.3.1. Altered installations shall be tested as specified in 8.10.3.3.2 before being placed back in service.

8.10.3.2 Inspection and Test Requirements for New Installations

8.10.3.2.1 Inside Car

- (a) Door Reopening Device [8.10.2.2.1(a)] (Item 1.1)
- (b) Stop Switches [3.26.4 and 8.10.2.2.1(b)] (Item 1.2)
- (c) Operating Control Devices [3.26.1 through 3.26.3, and 8.10.2.2.1(c)] (Item 1.3)
- (d) Car Floor and Landing Sill [3.5, 3.11, 3.15, and 8.10.2.2.1(d)] (Item 1.4)

- (e) Car Lighting [3.14 and 8.10.2.2.1(e)] (Item 1.5)
- (f) Car Emergency Signal [3.27 and 8.10.2.2.1(f)] (Item 1.6)
- (g) Car Door or Gate [3.11 through 3.14, and 8.10.2.2.1(g)] (Item 1.7)
- (h) Door Closing Force [3.13, 3.14, and 8.10.2.2.1(h)] (Item 1.8)
- (i) Power Closing of Doors or Gates [3.13 and 8.10.2.2.1(i)] (Item 1.9)
- (j) Power Opening of Doors or Gates [3.13, 3.26.3, and 8.10.2.2.1(j)] (Item 1.10)
- (k) Car Vision Panels and Glass Car Doors [3.14 and 8.10.2.2.1(k)] (Item 1.11)
- (l) Car Enclosure [3.14, 8.9, and 8.10.2.2.1(l)] (Item 1.12)
- (m) Emergency Exit [3.14 and 8.10.2.2.1(m)] (Items 1.13 and 1.20)
- (n) Ventilation [3.14 and 8.10.2.2.1(n)] (Item 1.14)
- (o) Signs and Operating Device Symbols [3.4 and 8.10.2.2.1(o)] (Item 1.15)
- (p) Rated Load, Platform Area, and Data Plate [3.16 and 8.10.2.2.1(p)] (Item 1.16)
- (q) Emergency and Auxiliary Power
 - (1) standby or emergency power [3.27 and 8.10.2.2.1(q)]. Passenger elevators and freight elevators shall be tested with rated load. Freight elevators with Class C2 loading shall be tested to ensure that the overload can be maintained during loading and unloading.
 - (2) auxiliary power lowering (3.26.10)
- (r) Restricted Opening of Car or Hoistway Doors [3.12 and 8.10.2.2.1(r)] (Item 1.18)
- (s) Car Ride (3.15, 3.23, and 8.10.2.2.1(s)) (Item 1.19)
- (t) Door Monitoring Systems [3.26.1 and 8.10.2.2.1(t)]
- (u) Stopping Accuracy (3.26.1)
- (v) Machinery Space/Control Space (8.10.3.2.2)
- (w) Working Areas in the Car (3.7 and 2.7.5.1)
 - (1) means to prevent unexpected movement (2.7.5.1.1)
 - (2) Unexpected Car Movement Device (2.26.2.34)
 - (3) operating instructions for Unexpected Car Movement Device (8.6.10.6)
 - (4) operating instructions for egress and reentry procedure (8.6.10.7)
- (x) Equipment Access Panel Electrical Device (3.26.1 and 2.26.2.35)

(ED) 8.10.3.2.2 Machine Room/Spaces, Control Room/Spaces

NOTE: A machinery space outside the hoistway containing a hydraulic machine and a motor controller is a machine room (3.7).

- (a) Location of Rooms/Spaces (3.7.1)
- (b) Location of Equipment (3.7.1)
- (c) Equipment Exposure to Weather (3.7.1)
- (d) Means of Access [3.7.1 and 8.10.2.2.2(d)] (Item 2.1)
- (e) Headroom [3.7.1 and 8.10.2.2.2(e)] (Item 2.2)

- (f) Means Necessary for Tests (3.7.1)
- (g) Inspection and Test Panel (3.7.1)
- (h) Lighting and Receptacles [3.7.1, 3.8, and 8.10.2.2.2(h)] (Item 2.3)
- (i) Enclosure of Machine Room/Spaces, Control Room/Spaces [3.1, 3.7.1, and 8.10.2.2.2(i)] (Item 2.4)
- (j) Housekeeping [3.8 and 8.10.2.2.2(j)] (Item 2.5)
- (k) Ventilation and Heating [3.7.1 and 8.10.2.2.2(k)] (Item 2.6)
- (l) Fire Extinguisher (8.6.1.6.5) (Item 2.7)
- (m) Pipes, Wiring, and Ducts (3.8) (Item 2.8)
- (n) Guarding of Exposed Auxiliary Equipment [3.10 and 8.10.2.2.2(n)] (Item 2.9)
 - (o) Numbering of Elevators, Machines, and Disconnect Switches [3.29 and 8.10.2.2.2(o)] (Item 2.10)
- (p) Maintenance Path and Maintenance Clearance (3.7.1)
 - (q) Stop Switch (3.7.1 and 3.26.1)
 - (r) Disconnecting Means and Control (Item 2.11)
 - (1) general (2.26.4.1, 2.26.4.5, and 3.26.1, and NFPA 70 or CSA-C22.1, as applicable)
 - (2) closed position (3.26.3.1.4)
 - (3) auxiliary contacts (NFPA 70 or CSA-C22.1, as applicable)
 - (s) Controller Wiring, Fuses, Grounding, etc. (Item 2.12)
 - (1) wiring (2.26.4.1 and 3.26.1)
 - (2) certification (2.26.4.2 and 3.26.1)
 - (3) capacitors or devices (2.26.7 and 3.26.1)
 - (4) control and operating circuits (2.26.9 and 3.26.1)
 - (5) clearances (NFPA 70 or CSA-C22.1, as applicable)
 - (6) phase protection (3.26.5)
 - (7) low oil protection (3.26.9)
 - (8) grounding (2.26 and NFPA 70 or CSA-C22.1, as applicable)
 - (9) fuses (2.26.4.1)
 - (t) *Hydraulic Machine (Power Unit)* (3.24.1) (Item 2.30). The working pressure shall be checked and the pressure on the data plate verified (3.24.1.1).
- (u) *Relief Valves* (Item 2.31). The relief valve shall be tested to determine conformance with 3.19.4.2.
- (v) Control Valve (Item 2.32)
 - (1) electric requirements (3.19.7)
 - (2) certification (3.19.4.6)
 - (3) data plate (3.19.4.6.2)
 - (4) check valve (3.19.4.3)
 - (5) manual lowering valve (3.19.4.4)
 - (6) pressure gauge fitting (3.19.4.5)
- (w) Tanks (Item 2.33)
 - (1) capacity (3.24.2.1)
 - (2) minimum level indication (3.24.2.2)
 - (3) atmospheric storage and discharge tanks (3.24.3)

(x) Flexible Hydraulic Hose and Fitting Assemblies (3.19.3.3) (Item 2.34)

(y) *Supply Lines and Shutoff Valves* (Item 2.35). Data from the pipe, fitting, and valve manufacturers shall be provided to verify that the pressured rating of all components complies with pressure rating requirements (Item 2.18.3).

- (1) component ratings (3.19.1.2)
- (2) component markings (3.19.1.4)
- (3) visual inspection of field welding (3.19.6)
- (4) pressure piping (3.19.2)
- (5) below-ground installations (3.19.5)
- (6) connections and fittings (3.19.3)

(z) *Hydraulic Cylinders* (Item 2.36). For plunger stops [Item 3.4.3(a)], verify that a stop ring has been provided as required by 3.18.4.1.

(aa) *Pressure Switch* (Item 2.37). Where cylinders are installed with the top of the cylinder above the top of the tank, a test shall be made to determine conformance to 3.26.8.

(bb) *Recycling Operation* (3.26.7). Where recycling operation is provided for multiple or telescoping plungers, tests shall be made for conformance with 3.26.7.

(cc) *Static Control Elevator*. The person or firm installing a static control elevator shall demonstrate conformance with 3.25.2.4.4.

(dd) Code Data Plate (8.9)

(ee) Operating Devices [8.10.2.2.2(gg)]

(1) Inspection Operation (2.26.1.4.4)

(2) Inspection Operation With Open Door Circuits (2.26.1.5, 3.26.1, and 3.26.2)

(ff) Governor, Overspeed Switch, and Seal (3.17.1) (Item 2.13)

(1) access and securing of car, if applicable (2.7.6.3.4)

(gg) Wiring Diagrams [8.6.1.2.2(a)]

(hh) *Freight Elevators*. Freight elevators of Class C2 loading shall sustain and level the elevator car with the maximum load shown on the freight elevator loading sign (3.16.2) (Item 2.17).

(ii) Location of machine room/space and hoistway related to expansion joint (Item 2.42.3.2)

(ED) 8.10.3.2.3 Top-of-Car

(a) Top-of-Car Stop Switch [3.26.4 and 8.10.2.2.3(a)] (Item 3.1)

(b) Car Top Light and Outlet [3.14 and 8.10.2.2.3(b)] (Item 3.2)

(c) Top-of-Car Operating Device [8.10.2.2.3(c)] (Item 3.3)

- (1) operation (3.26.2)
 - (2) operation with open door circuits (2.26.1.5)
- (d) Top-of-Car Clearance, Refuge Space (Item 3.4)

- (1) top car clearance (3.4.4)
- (2) car top minimum runby (3.4.2.2)
- (3) top-of-car equipment (3.4.5)

(4) vertical clearance of underslung car frames (3.4.8)

(5) refuge space (3.4.7)

(e) Normal Terminal Stopping Devices (3.25.1) (Item 2.28)

(f) Terminal Speed Reducing Devices (3.25.2) (Item 3.6)

(g) Car Leveling and Anticreep Devices (Item 3.7)

(1) *Anticreep Operation*. A test of the anticreep leveling device shall be made to determine conformance to 3.26.3.1.

(2) leveling or truck zone operation (3.26.3.2)

(h) Crosshead Data Plate [3.16 and 8.10.2.2.3(k)] (Item 3.27)

(i) Top Emergency Exit [3.14 and 8.10.2.2.3(l)] (Item 3.8)

(j) Identification [8.10.2.2.3(o)]

(k) Hoistway Construction (3.1) (Item 3.10)

(l) Hoistway Smoke Control [3.1 and 8.10.2.2.3(q)] (Item 3.11)

(m) Pipes, Wiring, and Ducts (3.8)

(n) Windows, Projections, Recesses, and Setbacks [3.1 and 8.10.2.2.3(s)] (Item 3.13)

(o) Hoistway Clearances (3.5) (Item 3.14)

(p) Multiple Hoistways [3.1 and 8.10.2.2.3(u)] (Item 3.15)

(q) Traveling Cables and Junction Boxes [3.8 and 8.10.2.2.3(v)] (Item 3.16)

(r) *Door and Gate Equipment*. Use procedure in 8.10.2.2.3(w). (3.11, 3.12, and 3.13) (Item 3.17)

(s) Car Frame and Stiles (3.15) (Item 3.18)

(t) Guide Rails, Fastenings, and Equipment (3.23) (Item 3.19)

(1) rail Section (3.23)

(2) bracket Spacing

(3) surfaces and Lubrication

(4) joints and Fish Plates

(5) bracket Supports

(6) fastenings

(7) guides

(u) *Governor, Safety, Ropes, and Counterweights* (Item 3.20). Use procedures in 8.10.2.2.2(hh) and (ii); and 8.10.2.2.3(m), (n), (z) through (cc); car and counterweight safeties (3.17.1 and 3.17.2).

(v) Governor Rope Releasing Carrier [3.17.1 and 8.10.2.2.3(aa)] (Item 3.21)

(w) Governor Rope [3.17.1 and 8.10.2.2.3(z)] (Item 3.20)

(x) Wire Rope Fastening and Hitch Plate [3.17.1 and 8.10.2.2.3(bb)] (Item 3.22)

(y) Suspension Rope (3.17.1, 3.18.1.2, 3.20, and 3.24.5) (Item 3.23)

(z) Slack Rope Device (3.17.1.1, 3.18.1.2.5, and 3.22.1.2) (Item 3.31)

(aa) Traveling Sheave (3.18.1.2.6 and 3.22.1.2) (Item 3.32)

(bb) Counterweight Ropes, Connections, and Sheaves (3.20 and 3.21) (Item 3.22)

(cc) *Car Speed* [3.28.1(k)]. The speed of the car shall be verified with rated load and with no load, in both directions. (Item 3.30)

(dd) *Inertia Tests*. Conduct inertia tests for Type A safeties. See Nonmandatory Appendix M.

(ee) Machinery Space/Control Space (8.10.3.2.2)

(ff) Working Areas on the Car Top (3.7.1)

(1) means to prevent unexpected movement (2.7.5.1.1)

(2) Unexpected Car Movement Device (2.26.2.34)

(3) operating instructions for Unexpected Car Movement Device (8.6.10.6)

(4) operating instructions for egress and reentry procedure (8.6.10.7)

(gg) Equipment Exposure to Weather (3.7.1)

(hh) Machinery Supports and Fastenings (2.9.1 and 2.9.3)

(ii) Guarding of Equipment (2.10.1)

(jj) Broken Rope, Chain, or Tape Switch (Item 3.26)

8.10.3.2.4 Outside Hoistway

(a) Car Platform Guard [8.10.2.2.4(a)] (Item 4.1)

(b) Hoistway Doors (8.10.2.2.4) (Item 4.2)

(c) Vision Panels (3.11) (Item 4.3)

(d) Hoistway Door Locking Devices [3.12 and 8.10.2.2.4(d)] (Item 4.4)

(e) Access to Hoistway [3.12 and 8.10.2.2.4(e)] (Item 4.5)

(f) Power Closing of Hoistway Doors [3.13 and 8.10.2.2.4(f)] (Item 4.6)

(g) Sequence Operation [3.13 and 8.10.2.2.4(g)] (Item 4.7)

(h) Hoistway Enclosure [3.1 and 8.10.2.2.4(h)] (Item 4.8)

(i) Emergency Doors in Blind Hoistways [3.11 and 8.10.2.2.4(i)] (Item 4.10)

(1) blind hoistway emergency door

(2) access openings for cleaning

(j) Standby or Emergency Power Selection Switch [3.26.10 and 8.10.2.2.4(k)] (Item 4.12)

(k) Location of Equipment (3.7.1)

(l) Means Necessary for Tests (2.7.6.4, 3.7.1.8, 3.7.1.9, and 3.7.1.10)

(m) Inspection and Test Panel (3.7.1 and 2.7.6.5), Inspection Operation (2.26.1.4.1), and Inspection Operation With Open Door Circuits (2.26.1.5)

(n) Equipment Exposure to Weather (3.7.1)

8.10.3.2.5 Pit

(a) Pit Access, Lighting, Stop Switch, and Condition [3.2 and 8.10.2.2.5(a)(1) through (a)(8) and (a)(10)] (Item 5.1)

(b) Bottom Clearance, Runby, and Minimum Refuge Space (Item 5.2)

(1) bottom car clearance (3.4.1)

(2) minimum bottom car runby (3.4.2)

(3) maximum bottom car runby (3.4.3)

(c) Plunger and Cylinder (Item 5.11)

(1) hydraulic jack connections

(a) direct-acting elevators (3.18.1.1); and

(b) roped-hydraulic elevators (3.18.1.2)

(2) plunger

(a) plunger connections (3.18.2.3)

(b) plunger guides (3.18.2.7)

(3) cylinders

(a) clearance bottom of cylinder (3.18.3.3)

(b) collection of oil (3.18.3.7)

(c) corrosion protection: the person or firm installing monitored cathodic protection shall demonstrate conformance with 3.18.3.8.3(c)

(d) means for release of air or gas (3.18.3.9)

(4) welding visual inspection (3.18.5)

(d) Car Buffer (3.6.3, 3.6.4, and 3.22.1) (Item 5.12)

(e) Normal Terminal Stopping Devices (3.25.1) (Item 5.4)

(f) Traveling Cables (3.8; and NFPA 70, Article 620 or CSA-C22.1, Section 38, as applicable) (Item 5.6)

(g) Car Frame and Platform (3.15) (Item 5.7)

(h) Guiding Members (3.15 and 3.23) (Item 5.13)

(i) Supply Piping (Items 5.14 and 5.16)

(1) components and valves (3.19.1 and 3.19.4)

(2) field welding visual inspection (3.19.6)

(3) pressure piping (3.19.2)

(j) Car Safety (Item 5.8)

(k) Governor rope tension device (Item 5.6)

(l) Counterweight

(1) top clearance and bottom runby (3.4.6 and 3.22.2)

(2) guards (3.3)

(3) design (3.21)

(m) Protection of spaces below hoistway (3.6)

(n) A plunger gripper, where provided, shall be inspected and tested at rated load at not less than operating speed in the down direction. The means for the actuation of the gripper shall be verified by overspeeding the car or by alternative means. Where multiple means of actuation are provided, each means shall be individually tested. The date of this test shall be permanently marked on the marking plate [see 3.17.3.8(e)].

(o) *Overspeed Valve and Seal*. Overspeed valves, where provided, shall be inspected and tested to verify that they will stop the car, traveling down with rated load within the specified limits of 3.19.4.7.5(a), using a written procedure supplied by the valve manufacturer or installer (Item 5.25.3.2).

(p) Machinery Space/Control Space (8.10.3.2.2)

- (q) Working Areas in the Pit (3.7.1 and 2.7.5.2)
 - (1) means to prevent unexpected movement [2.7.5.2.1(a) or (b)]
 - (2) Unexpected Car Movement Device (2.26.2.34)
 - (3) operating instructions for Unexpected Car Movement Device (8.6.10.6)
 - (4) operating instructions for egress and re-entry procedure (8.6.10.7)
- (r) Equipment Exposed to Weather (3.7.1)
- (s) Machinery Supports and Fastenings (2.9.1 and 2.9.3)
- (t) Guarding of Equipment (2.10.1)
- (u) Pit Inspection Operation (3.26.2)

8.10.3.2.6 Firefighters' Emergency Operation (3.27). Verify conformance with 2.27.3 through 2.27.8 and 3.27.

8.10.3.2.7 Working Platforms

- (a) Working Platforms (3.7.1, 2.7.5.3, and 2.7.5.4)
 - (1) operating instructions (8.6.10.8)
- (b) Retractable Stops (3.7.1 and 2.7.5.5)
 - (1) retractable stop electrical device (2.26.2.37)
- (c) Inspection Operation (3.26.2)

8.10.3.3 Inspection and Test Requirements for Altered Installations

8.10.3.3.1 Alterations shall be inspected for compliance with the applicable requirements specified in 8.7. Check code data plate for compliance with 8.7.1.8.

(ED) 8.10.3.3.2 Tests shall be performed when the following alterations are made:

- (a) Where the alteration consists of the addition of power operation to the door system (8.7.3.12), tests shall be performed as specified in 8.10.3.2.1(a), (h), (i), (j), and (t); 8.10.2.2.3(g); 8.10.3.2.3(r); 8.10.2.2.4(b), (d) through (g); and 8.10.2.2.6.
- (b) Where alterations have been made to the car or counterweight guide rails, guide-rail supports, or guide-rail fastenings, or where the stresses have been increased by more than 5% (8.7.3.28), tests shall be performed as specified in 8.10.3.2.1(s), 8.10.2.2.2(ii), if safeties are provided, 8.10.3.2.3(o), (s), and (t).
- (c) Where alterations have been made to oil buffers (8.7.3.27), tests shall be performed as specified in 8.10.3.2.5(b), (d), and (l)(1).
- (d) Where an alteration results in an increase in the deadweight of the car that is sufficient to increase the sum of the deadweight and the rated load, as originally installed, by more than 5% (8.7.3.21), tests shall be performed as specified in 8.10.3.2.3(u) and 8.10.2.2.2(ii) if safeties are provided; 8.10.2.2.5(c) if oil buffers are provided; and 8.10.3.2.1(q), 8.10.3.2.2(m), (n), (q), and (r), 8.10.3.2.3(h) and (cc).
- (e) Where the alteration consists of the installation of new car or counterweight safeties, or where alterations

are made to existing safeties (8.7.3.15), tests shall be performed as specified in 8.10.3.2.3(u) and 8.10.2.3.2(e).

(f) Where any alteration is made to a speed governor (8.7.3.16), tests shall be performed as specified by 8.10.2.3.2(f) and 8.10.3.2.3(u).

(g) Where an alteration involves an increase in the rated load (8.7.3.20), tests shall be performed as specified in 8.10.2.2.2(ii); and 8.10.3.2.3(u) if safeties are provided; and 8.10.2.2.5(c) if oil buffers are provided, and as specified in 8.10.3.2.1(p), (q)(1), 8.10.3.2.2(m), (n), (r), and 8.10.3.2.3(h) and (cc).

(h) Where an alteration consists of an increase in the working pressure by more than 5% (8.7.3.23.4), it shall be inspected as specified in 8.10.3.2.2(m), (n) through (t) and 8.10.3.2.5(c) and (i).

(i) Where the location of the hydraulic jack has been changed (8.7.3.23.5), tests shall be performed as specified 8.10.3.2.

(j) Where an alteration increases the rated speed (8.7.3.22.2), increases the rated load (8.7.3.20), increases the weight of the car (8.7.3.21), changes travel (8.7.3.22.1), changes the type of service (8.7.3.17), changes the class of loading (8.7.3.18), or changes from freight to passenger (8.7.3.19), tests shall be performed as specified in 8.10.3.2.1(a), (c), (g) through (k), (q), (r), (s), and (t); 8.10.3.2.2(m), (n), (x), and (y); 8.10.3.2.3(c) through (h), (o), (u), (y), and (cc); and 8.10.3.2.5(b), (d), and (l).

(k) Where an alteration is made to any terminal stopping device (see 8.7.3.30), tests shall be performed as specified in 8.10.3.2.3(e) and (f), and 8.10.3.2.5(e).

(l) Where an alteration is made to a standby or emergency power system [see 8.7.3.31.8(b)], tests shall be performed as specified in 8.10.3.2.1(q) and 8.10.3.2.4(j).

(m) Where an alteration is made to firefighters' service operation [8.7.3.31.8(c)], tests shall be conducted as specified in 8.10.3.2.6.

(n) Where an alteration is made to the plunger or cylinder (8.7.3.23), tests shall be performed as specified in 8.10.3.2.2(m), (n), (o), (r), and (s), 8.10.3.2.3(d) and (cc); and 8.10.3.2.5(b) and (c).

(o) Where an existing control valve is replaced with a valve of a different type, or where relief or check valves or the supply piping and fittings are replaced (8.7.3.24), tests shall be performed as specified in 8.10.3.2.2(t), (u), (v), and (y); and 8.10.3.2.3(cc).

(p) Where an alteration consists of a change in operation control (8.7.3.31.7), tests shall be performed as specified in 8.10.3.2.1(a), (b), (c), (e) through (j), (l), (q), (s), and (t); 8.10.3.2.2(j), (l), (t), (u), (x), and (y); 8.10.3.2.3(a), (c), (e), (f), (g), (j), and (cc); 8.10.3.2.4(b) through (g), (j), and (k); 8.10.3.2.5(a) and (e); and 8.10.3.2.6.

(q) Where an alteration is made that results in a new hoistway door, car door, or car gate controller without any change to the operation or control [8.7.3.31.5(b)], tests shall be performed as specified in 8.10.2.2.2(j) and 8.10.3.2.2(s)(1), (s)(2), (s)(3), and (s)(5).

(r) Where an alteration is made that results in a change in the type of motion control (8.7.2.27.5), tests shall be performed as specified in 8.10.3.2.1(l); 8.10.3.2.2(j), (l), (m), (t), and (u); and 8.10.3.2.3(j). All electrical protective devices shall be tested for proper operation.

(s) Where an alteration is made and results in a replacement of a new controller without any change to the type of operation control or motion (8.7.3.31.5), tests shall be performed as specified in 8.10.2.2.1(l)(5), and 8.10.2.2.2(q), (s), (t)(1), (t)(2), (t)(4), and (ll); and 8.10.2.2.1(t), and 8.10.2.2.3(o). All electrical protective devices shall be tested for proper operation.

8.10.4 Acceptance Inspection and Tests of Escalators and Moving Walks

8.10.4.1 Inspection and Test Requirements for New Installations. New installations shall be inspected and tested as required by 8.10.4.1 before being placed in service.

(ED) 8.10.4.1.1 External Inspection and Tests

(a) General Fire Protection Requirements (Items 7.1 and 9.1)

(1) The protection of floor and wall openings shall be inspected to determine conformance with 6.1.1 for escalators or 6.2.1 for moving walks.

(2) The protection of the trusses and machine space shall be inspected to determine conformance with 6.1.2 or 6.2.2.

(b) Geometry (Items 7.2 and 9.2)

- (1) angle of inclination (6.1.3.1 or 6.2.3.1)
- (2) width and clearances (6.1.3.2 or 6.2.3.2)
- (3) interior low deck (6.1.3.3.4 or 6.2.3.3.4)

(c) Handrails (Items 7.3 and 9.3)

(1) *Speed* (6.1.3.4.1 or 6.2.3.4.1). Running tests shall be performed, in each direction, to determine conformance with 6.1.3.4.1 or 6.2.3.4.1.

- (2) extension (6.1.3.4.2 or 6.2.3.4.2)
- (3) guards (6.1.3.4.3 or 6.2.3.4.3)
- (4) splice (6.1.3.4.4 or 6.2.3.4.4)
- (5) height (6.1.3.4.5)
- (6) clearance (6.1.3.4.6 or 6.2.3.4.5)

(7) the person or firm installing the equipment shall provide a written checkout procedure and demonstrate that the handrail speed does not change when a retarding force, up to the maximum required by code, is applied opposite to the direction of travel (6.1.3.4.1 or 6.2.3.4.1)

(d) Entrance and Egress (Items 7.4 and 9.4)

- (1) head room (6.1.3.12 or 6.2.3.16)
- (2) egress and Safety Zone (6.1.3.6.4, 6.2.3.8.4, and 6.2.6.3.6)

(3) combplates [6.1.3.6.1(a) or 6.2.3.8.1(a)]

(e) Lighting (Items 7.5 and 9.5) (6.1.7.2 or 6.2.7.2)

(f) Caution Signs (6.1.6.2, 6.1.6.9, or 6.2.6.8) (Items 7.6 and 9.6)

(g) Combplates (6.1.3.6 and 6.2.3.8.1) (Items 7.7 and 9.7)

- (1) design
- (2) adjustment
- (3) replacement

(h) Deck Barricade (Items 7.8 and 9.8)

- (1) antislid e Devices (6.1.3.3.10)
- (2) deck Barricades (6.1.3.3.11 or 6.2.3.3.8)

(i) Steps, Step Upthrust Device, and Treadway (Items 7.9 and 9.9)

- (1) steps
 - (a) material and type (6.1.3.5.1)
 - (b) dimensions (6.1.3.5.2)
 - (c) clearance between steps (6.1.3.5.4)
 - (d) slotting of treads (6.1.3.5.4)
 - (e) slotting of risers (6.1.3.5.3)
 - (f) design load (6.1.3.9.4)
 - (g) flat steps (6.1.3.6.5)
 - (h) step upthrust device

(2) treadways

- (a) belt type (6.2.3.6)
- (b) pallet type (6.2.3.5)

(j) Operating and Safety Devices (Items 7.10 and 9.10)

- (1) starting switches (6.1.6.2 or 6.2.6.2).
- (2) emergency stop buttons (6.1.6.3.1 or 6.2.6.3.1).
- (3) automatic start and stopping (6.1.6.1.1 or 6.2.6.1.1).

(4) *Tandem Operation* (6.1.6.6 or 6.2.6.6). When interlocked tandem operation is required, verify that an escalator or moving walk carrying passengers to an intermediate landing will stop when the escalator or moving walk carrying passengers away from that landing stops. Also, verify that the units are interlocked to run in the same direction.

(k) Handrail Entry Device (6.1.6.3.12 or 6.2.6.3.10) (Items 8.13 and 10.13)

(l) Egress Restriction Device (6.1.6.3.7 or 6.2.6.3.6) (Items 7.13 and 9.13)

(m) *Speed* (Items 7.14 and 9.14). The rated speed shall be tested to determine conformance with 6.1.4.1 for escalators and 6.2.4 for moving walks.

(n) Balustrades (Items 7.15 and 9.15)

- (1) construction (6.1.3.3.1 or 6.2.3.3.1)
- (2) glass or plastic (6.1.3.3.3 or 6.2.3.3.3)
- (3) change in width [6.1.3.3.1(c) or 6.2.3.3.1(d)]

(o) Ceiling Intersection Guards (6.1.3.3.11 or 6.2.3.3.7) (Items 7.16 and 9.16)

(p) Skirt Panels (Items 7.17 and 9.17)

- (1) clearance between skirt and steps [6.1.3.3.5 or 6.2.3.3.5(a), and 6.2.3.3.6(a)]
- (2) height above step [6.1.3.3.6(a) or 6.2.3.3.5(b), and 6.2.3.3.6(b)]
- (3) deflection [6.1.3.3.6(b) or 6.2.3.3.6(c)]

- (4) smoothness [6.1.3.3.6(c) or 6.2.3.3.6(d)]
- (5) Clearance Between Step and Skirt (Loaded Gap)
- (a) Loaded gap measurements shall be taken at intervals not exceeding 300 mm (12 in.) in the transition region (6.1.3.6.5) and before the steps are fully extended. These measurements shall be made independently on each side of the escalator.
- (b) The applied load shall not deviate from 110 N (25 lbf) (6.1.3.3.5) by more than ± 11 N (2.5 lbf). The load shall be distributed over a round or square area no less than 1 940 mm² (3 in.²) and no more than 3 870 mm² (6 in.²).
- (c) For the loaded gap measurements, the center of the applied load shall be between 25 mm (1 in.) and 100 mm (4 in.) below the nose line of the steps. The center of the applied load shall be not more than 250 mm (10 in.) from the nose of the step. See Fig. 8.6.8.15.19(e).
- (q) Outdoor Protection (6.1.8.1, 6.1.8.2, 6.1.8.3, or 6.2.8.1, 6.2.8.2, and 6.2.8.3) (Items 7.18 and 9.18)
- (r) Escalator and Moving Walk Well Guards (Floor Opening Protection) (6.1.3.6.6) (Items 7.4 and 9.4)
- (s) Verification of Documentation for Type Tests, Certification, and Markings
- (1) escalator brake test (6.1.5.3.3) (Items 8.4 and 10.4)
- (2) step and pallet fatigue test (6.1.3.5.7 or 6.2.3.5.4) (Items 7.9 and 9.9)
- (t) Step/Skirt Performance Index
- (1) The escalator skirt shall not be cleaned, lubricated, or otherwise modified in preparation for testing. The escalator instantaneous step/skirt index measurements [6.1.3.3.9(a)] shall be recorded at intervals no larger than 150 mm (6 in.) from each side of two distinct steps along the inclined portion of the escalator, where the steps are fully extended. Test steps shall be separated by a minimum of eight steps.
- (2) A load of 110 N (25 lbf) shall be laterally applied from the step to the adjacent skirt panel. The applied load shall not deviate from 110 N (25 lbf) by more than ± 11 N (2.5 lbf). The load shall be distributed over a round or square area no less than 1 940 mm² (3 in.²) and no more than 3 870 mm² (6 in.²).
- (3) No vertical load exceeding 220 N (50 lbf) shall be applied to the test step and adjacent steps.
- (4) The coefficient of friction shall be measured with the test specimen conforming to the requirements of 6.1.3.3.9(b) sliding in the direction of the step motion under a 110 N (25 lbf) normal force at the operating speed of the escalator and shall be measured with devices having sensitivity better than ± 2.2 N (0.5 lbf). The direction of step motion shall be the direction of normal operation. If the escalator is operated in both directions, the down direction shall be used for the test.
- (5) For both the coefficient of friction measurement and the loaded gap measurements, the center of the applied load shall be between 25 mm (1 in.) and 100 mm

(4 in.) below the nose line of the steps. The center of the applied load shall be not more than 250 mm (10 in.) from the nose of the step. See Fig. 8.6.8.15.19(e).

(6) Verify that the step/skirt performance index conforms to the requirements in 6.1.3.3.9 (Item 1.17.2) and in jurisdictions not enforcing NBCC (8.6.8.3).

8.10.4.1.2 Internal Inspection and Tests

(13)

- (a) Machine Space (Items 8.1 and 10.1)
- (1) access (6.1.7.3 or 6.2.7.3)
- (2) lighting (6.1.7.1.1 or 6.2.7.1.1)
- (3) receptacle (6.1.7.1.2 or 6.2.7.1.2) [NFPA 70 Section 620-21(b)]
- (4) guards (6.1.7.3.4 or 6.2.7.3.4)
- (5) Verify that the connection and restraints between the truss and the building structure comply with seismic risk zone requirements (Items 8.16 and 10.17).
- (b) Stop Switch. The machine space stop switches shall be tested for conformance to 6.1.6.3.5 or 6.2.6.3.5 (Items 8.2 and 10.2).
- (c) Controller and Wiring. Controller and wiring shall be inspected (Items 8.3 and 10.3).
- (1) wiring (6.1.7.4 or 6.2.7.4)
- (2) control. The person or firm installing the escalator or moving walk shall provide a manufacturer's written procedure and demonstrate compliance with redundancy and software checking of control and operating circuits (6.1.6.10 and 6.2.6.9). Where there are no test or check requirements, the written checklist shall state "No test or check required." The documentation shall state the reason no test or check is required.
- The following shall be documented or demonstrated:
- (a) general (6.1.6.13 and 6.2.6.12)
- (b) redundancy and its checking (6.1.6.10.1, 6.1.6.10.2, 6.2.6.9.1, and 6.2.6.9.2)
- (c) static control (6.1.6.10.3 and 6.2.6.9.3), where applicable
- (d) electrically powered safety devices (6.1.6.11 and 6.2.6.10), where applicable
- (e) installation of capacitors or other devices to make electrical protective devices ineffective (6.1.6.12 and 6.2.6.11)
- (f) contactor and relays for use in critical operating circuits (6.1.6.15 and 6.2.6.14), where applicable
- (d) Drive Machine and Brake. The drive machine and brakes shall be inspected and tested including test of the brake torque (6.1.5.3 and 6.2.5.3) (Items 8.4 and 10.4).
- (1) connection of machine and drive shaft (6.1.5.1 and 6.1.5.3.2 or 6.2.5.1 and 6.2.5.3.2)
- (2) drive motor (6.1.5.2 or 6.2.5.2)
- (3) brake type (6.1.5.3 or 6.2.5.3)
- (a) Verify that the brake torque complies with the value shown on the data plate or in the special instructions [see 6.1.5.3.1(d) for escalators and 6.2.5.3.1(d) for moving walks].

(b) Minimum no load stopping distance for moving walks and escalators with variable torque brakes.

(4) brake data plate [6.1.5.3.1(d)]

(5) main driveshaft brake (6.1.5.3.2)

(6) escalator brake certification (6.1.5.3.3)

(e) *Speed Governor*. The mechanical speed governor, if required, shall be tested by manually operating the trip mechanism. Check the tripping speed for compliance with 6.1.6.3.2 or 6.2.6.3.2. The means of adjustment shall be sealed and a tag indicating the date of the governor test, together with the name of the person or firm that performed the test, shall be attached to the governor in a permanent manner (6.1.6.3.2 and 6.2.6.3.2) (Items 8.5 and 10.5).

(f) *Broken Drive Chain Device*. Operation of the broken drive chain device, on the drive chain, shall be tested by manually operating the actuating mechanism (6.1.6.3.4, 6.1.5.3.2, 6.2.6.3.4, 6.2.5.3.2, 6.1.6.3.10, and 6.2.6.3.8) (Items 8.6 and 10.6).

(g) *Reversal Stop Switch*. The reversal stop switch (to prevent reversal when operating in the ascending direction) shall be tested by manually operating it to determine that it functions properly (6.1.6.3.8 or 6.2.6.3.7 and 6.2.6.3.8) (Items 8.7 and 10.7).

If the device cannot be manually operated, the person or firm installing the equipment shall provide a written check-out procedure and demonstrate the device complies with 6.1.6.3.8 or 6.2.6.3.7.

(h) *Broken Step Chain or Treadway Device*. The broken or slack step chain or treadway device shall be inspected and tested by manual operation (6.1.6.3.3 and 6.2.6.3.3) (Items 8.8 and 10.8).

(i) *Step Upthrust Device*. The operation of the step upthrust device shall be tested by manually causing the device to operate (6.1.6.3.9) (Item 8.9).

(j) *Missing Step or Pallet Device*. The missing step or pallet device shall be tested by removing a step or pallet and verifying that the device will properly function (6.1.6.5 or 6.2.6.5) (Items 8.10 and 10.10).

(k) *Step or Pallet Level Device*. The step or pallet level device shall be tested by simulating an out of level step or pallet and verifying that the device functions properly (6.1.6.3.11 or 6.2.6.3.9) (Items 8.11 and 10.11).

(l) *Steps, Pallet, Step or Pallet Chain, and Trusses*. The steps, pallet, step or pallet chain, trusses, tracks, and supports shall be visually inspected. Verify that the tracking system will prevent displacement of the step and pallets if the chain breaks (Items 8.12 and 10.12).

(1) steps and pallets (6.1.3.5 and 6.2.3.5)

(2) trusses and tracks

(a) trusses (6.1.3.7)

(b) tracks (6.1.3.8)

(c) welding (6.1.3.13)

(3) supports

(a) slider bed [6.2.3.9.1(a)]

(b) roller bed [6.2.3.9.1(b)]

(m) *Handrail Speed Monitor*. The handrails operating mechanism shall be visually inspected for condition and the handrail speed monitor device shall be tested (6.1.6.4 or 6.2.6.4) (Items 7.12, 8.13, 9.12, and 10.13).

(n) *Disconnected Motor Safety Device*. Operation of the device shall be checked and verified that it is of the manual reset type (6.1.6.3.10 or 6.2.6.3.8) (Item 8.6 or 10.6).

(o) *Heaters*. For outdoor escalators and moving walks that require heaters, test the heaters for condition and operation (6.1.8.2 and 6.2.8.2) (Items 8.3 and 10.3).

(p) Code Data Plate (8.9) (Items 8.14 and 10.14)

(q) *Comb-Step or Comb-Pallet Impact Device*. The comb-step or comb-pallet impact devices shall be tested in both the vertical and horizontal directions by placing a vertical and horizontal force on the comb-step or comb-pallet to cause operation of the device. The vertical and horizontal tests shall be independent of each other. The horizontal force shall be applied at the front edge center and both sides in the direction of travel. The vertical force shall be applied at the front edge center. Both the vertical and horizontal forces required to operate the device shall be recorded (6.1.6.3.13 and 6.2.6.3.11) (Items 7.7 and 9.7).

(r) Where a step lateral displacement device is required it shall be tested for conformance to 6.1.6.3.14.

(s) Operating and safety devices shall be tested and inspected to determine conformance with 6.1.6 for escalators and 6.2.6 for moving walks.

(t) *Skirt Obstruction Devices (Item 7.11)*. The skirt switches shall be tested for conformance with 6.1.6.1(h) and 6.1.6.3.6.

(u) Inspection control devices shall be tested and inspected to determine conformance with the requirements of 6.1.6.2.2 for escalators and 6.2.6.2.2 for moving walks.

(v) *Response to Smoke Detectors (Items 8.15 and 10.15)*. Where provided, smoke detector shutdown shall be tested for conformance with 6.1.6.8 and 6.2.6.7.

(w) Verify that the balustrades are installed as shown on the manufacturer's drawing for seismic requirements [Item 7.20.3(a)].

(x) Verify the installation, location, and function of the seismic switch [Items 7.20.3(a), and 9.20.3 (b) and (c)].

8.10.4.2 Inspection and Test Requirements for Altered Installations. Altered installations shall be inspected as specified in 8.10.4.2.1. Altered installations shall be tested as specified in 8.10.4.2.2 before being placed back in service.

8.10.4.2.1 Alterations shall be inspected for compliance with the applicable requirements specified in 8.7.

NOTE: For code data plate, see 8.7.1.7.

8.10.4.2.2 Tests shall be performed when the following alterations are made:

(a) Where alterations involve a change in the angle of inclination or geometry of balustrades, they shall be inspected for conformance with 8.7.6.1.5 for escalators and 8.7.6.2.5 for moving walks and tested as specified in 8.10.4.1.1(c)(1), 8.10.4.1.1(m), and 8.10.4.1.1(n) (Items 7.2 and 7.15, or 9.2 and 9.15).

(b) Where the handrails have been altered, they shall be inspected for conformance with 8.7.6.1.6 for escalators and 8.7.6.2.6 for moving walks, and tested as specified in 8.10.4.1.1(c)(1) and 8.10.4.1.1(m) (Items 7.3 and 8.13, or 9.3 and 10.13).

(c) Where the step system or treadway system has been altered, it shall be inspected for conformance with 8.7.6.1.7 for escalators and 8.7.6.2.7 for moving walks, and tested as specified in 8.10.4.1.1(g), (i)(2), and (p), and 8.10.4.1.2(h) through (l) and (r) (Items 7.9 and 8.12, or 9.9 and 10.12).

(d) Where alterations involve the trusses, girders, or supporting structures, they shall be inspected and tested for conformance with 8.7.6.1.9 for escalators and 8.7.6.2.9 for moving walks, and tested as specified in 8.10.4.1.2(l) (Items 8.12 or 10.12).

(e) Where the step wheel tracks or track system is altered, they shall be inspected and tested for conformance with 8.7.6.1.10 for escalators and 8.7.6.2.10 for moving walks, and tested as specified in 8.10.4.1.2(l) (Items 7.9 and 8.13, or 9.9 and 10.12).

(f) Where alterations involve changes in the rated load and/or speed, they shall be inspected and tested for conformance with 8.7.6.1, and tested as specified in 8.10.4.1.1 and 8.10.4.1.2 (Items 7.1 through 8.15 and 9.1 through 10.15).

(g) Where the driving machine motor or brake is altered, it shall be inspected and tested for conformance with 8.7.6.1.12 for escalators and 8.7.6.2.12 for moving walks and tested as specified in 8.10.4.1.1(m) and (s), 8.10.4.1.2(d) and (n) (Items 7.14, 8.4, 8.6, 9.14, 10.4, and 10.6).

(h) Where the operating, safety, or electrical protective devices are altered or added, they shall be inspected and tested for conformance with 8.7.6.1.13 for escalators and 8.7.6.2.13 for moving walks, and tested as specified in 8.10.4.1.1(j) through (k), (m), and 8.10.4.1.2(c), (e) through (k), (m), (q), (r) (Items 7.7, 7.9, 7.10, 7.11, 7.12, 7.13, 8.2, 8.5, 8.7, 8.8, 8.9, 8.10, 8.11, 8.13, 8.14 or 9.7, 9.10, 9.12, 9.13, 10.2, 10.5, 10.6, 10.7, 10.8, 10.10, 10.11, 10.13, and 10.15).

(i) When an alteration consists of the alteration of a controller, it shall be inspected and tested for conformance to 8.7.6.1.16 for escalators and 8.7.6.2.15 for moving walks, and tested as specified in 8.10.4.1.1(j) through (k), and (m), and 8.10.4.1.2(a) through (k), (m), (n), (q) through (t). All required (8.6.1.1.2) operating and safety devices in 6.1.6 or 6.2.6 shall be tested.

8.10.5 Acceptance Inspection and Tests of Other Equipment

8.10.5.1 Sidewalk Elevator. Sidewalk elevators shall be subject to the applicable acceptance inspections and tests specified in 8.10.1 through 8.10.3. The inspection and test requirements shall apply to the corresponding requirements in 5.5. Any additional requirements for this equipment shall also be checked during these inspections and tests.

8.10.5.2 Private Residence Elevators. Private residence elevators shall be subject to acceptance inspections and tests specified in 8.10.1 through 8.10.3. The inspection and test requirements shall apply to the corresponding requirements in 5.3 and 5.4. Any additional requirements for this equipment should also be checked during these inspections and tests.

Before an inclined elevator is put into service, a test of the car safety shall be made with rated load in the car. Governor operation of instantaneous-type safeties shall be tested at rated speed by manually tripping the governor. Where speed governors are located on the car or chassis, testing shall be performed by obtaining sufficient slack rope to cause the safety to function.

8.10.5.3 Hand Elevators. Hand elevators shall be subject to the applicable acceptance inspections and tests specified in 8.10.1 and 8.10.2.

The inspection and test requirements shall apply to the corresponding requirements in 4.3. Any additional requirements for this equipment shall also be checked during these inspections and tests.

The driving-machine brake required by 4.3.19.2 shall be tested with both empty car and rated load in the car.

8.10.5.4 Dumbwaiters. Dumbwaiters shall be subject to acceptance inspection and testing in conformance with 7.1, 7.2, and 7.3. Items to be inspected shall be as specified in 8.10.1 through 8.10.3 unless not required in 7.1, 7.2, and 7.3. Inspections of dumbwaiter shall take place from outside the hoistway. Inspection from the car top of dumbwaiters with automatic transfer devices shall be permitted only when top-of-car operating devices and car safeties are provided and the dumbwaiter has a rated load sufficient for the inspector and any tools and adequate horizontal and vertical clearance.

8.10.5.5 Material Lifts and Dumbwaiters With Automatic Transfer Devices. Material lifts shall be subject to acceptance inspection and testing in conformance with 7.4 through 7.10. Items to be inspected shall be as specified in 8.10.1 through 8.10.3, unless not required in 7.4 through 7.10. Inspections of material lifts shall take place from outside the hoistway, and from within

(a) the machine room where a machine room is provided in conformance with 2.7.

(b) the pit where a pit is provided in conformance with 2.2 or devices required in 7.4.6.1(c) or 7.4.6.2(a) are provided.

(c) from the car top where top runby space conforming with 2.4, 7.4.6.1(d), 7.4.6.2(b), or 7.4.6.2(c), top-of-car operating device conforming with 2.26.1.4, and car safeties conforming with 2.17 or 7.5.4 are provided. Alterations shall be inspected for compliance with the applicable requirements specified in 8.7.7.3.

Inspection from the car top of material lifts with automatic transfer devices shall only be permitted when top-of-car operating devices and car safeties are provided and the material lift has a rated load sufficient for the inspector and any tools and adequate horizontal and vertical clearance.

Inspection from the car top of a dumbwaiter with an automatic transfer device is only permitted when top-of-car operating devices and car safeties conforming to 7.2.12.4 are provided.

8.10.5.6 Special Purpose Personnel Elevators. Special purpose personnel elevators shall be subject to the applicable acceptance inspections and tests specified in 8.10.1 through 8.10.3.

The inspection and test requirements shall apply to the corresponding requirements in 5.7. Any additional requirements for this equipment shall also be checked during these inspections and tests.

8.10.5.7 Inclined Elevators. Inclined elevators shall be subject to the applicable acceptance inspections and tests specified in 8.10.1 through 8.10.3. The inspection and test requirements shall apply to the corresponding requirements in 5.1. Any additional requirements for this equipment shall also be checked during these inspections and tests.

8.10.5.8 Shipboard Elevators. Shipboard elevators shall be subject to the applicable acceptance inspections and tests specified in 8.10.1 through 8.10.3. The inspection and test requirements shall apply to the corresponding requirements of 5.8. Any additional requirements for this equipment shall also be checked during these inspections and tests.

8.10.5.9 Screw-Column Elevators. Screw-column elevators shall be subject to the applicable acceptance inspections and tests specified in 8.10.1 through 8.10.3.

The inspection and test requirements shall apply to the corresponding requirements of 4.2. Any additional requirements for this equipment shall also be checked during these inspections and tests.

8.10.5.10 Elevators Used for Construction. Elevators used for construction shall be subject to the applicable acceptance inspections and tests specified in 8.10.1 through 8.10.3.

The inspection and test requirements shall apply to the corresponding test requirements of 5.10. Any additional

requirements for this equipment shall also be checked during these inspections and tests.

8.10.5.11 Rooftop Elevators. Rooftop elevators shall be subject to the applicable acceptance inspections and tests specified in 8.10.1 through 8.10.3.

The inspection and test requirements shall apply to the corresponding requirements of 5.6. Any additional requirements for this equipment shall also be checked during these inspections and tests.

8.10.5.12 Rack-and-Pinion Elevators. Rack-and-pinion elevators shall be subject to the acceptance inspections and tests specified in 8.10.1 through 8.10.3. The inspection and test requirements shall apply to the corresponding requirements of 4.1. Any additional requirements for this equipment shall also be checked during these inspections and tests.

8.10.5.13 Limited-Use/Limited-Application Elevators. Limited-use/limited-applications elevators shall be subject to the applicable acceptance inspections and tests specified in 8.10.1 through 8.10.3.

The inspection and test requirements shall apply to the corresponding requirements of 5.2. Any additional requirements for this equipment shall also be checked during these inspections and tests.

8.10.5.14 Wind Turbine Tower Elevators. Wind turbine tower elevators shall be subject to the applicable acceptance inspections and tests specified in 8.10.1, 8.10.2, and the applicable requirements of 8.10.5. (13)

The inspection and test requirements shall apply to the corresponding requirements of 5.11. Any additional requirements for this equipment shall also be checked during these inspections and tests.

8.10.5.14.1 Wire Rope Gripping Safeties

(a) Wire rope gripping safeties with an internal centrifugal governor shall be tested by obtaining the necessary slack rope to cause it to function and hold the car with rated load (Item 2.29.3).

(b) Wire rope gripping safeties with an internal centrifugal governor, which are operated as a result of overspeed of the car, shall be subjected to an overspeed test with the suspension rope(s) attached by gradually increasing the speed of the car until the governor causes application of the safety (Item 2.29.3).

8.10.5.14.2 Test the overload detection means for conformance with 5.11.16.4 by adding load until the means trips. The car shall not be permitted to electrically operate in either direction.

8.10.5.15 Outside Emergency Elevators. Outside emergency elevators shall be subject to the applicable acceptance inspections and tests specified in 8.10.1 and ASME A17.7/CSA B44.7, Requirement 2.12.3. (13)

SECTION 8.11 PERIODIC INSPECTIONS AND WITNESSING OF TESTS

Requirement 8.11 covers periodic inspections and tests of existing installations.

NOTES:

- (1) Compliance with certain requirements is verifiable through review of design documents, engineering, or type tests.
- (2) See General in Preface for assignment of responsibilities.

8.11.1 General Requirements for Periodic Inspections and Witnessing of Tests

- (13) **8.11.1.1 Persons Authorized to Make Periodic Inspections and Witness Tests.** The inspector shall meet the qualification requirements of ASME QEI-1. Inspectors and inspection supervisors shall be certified by an independent, accredited, certifying organization as specified in 8.10.1.2 (see 1.3).

8.11.1.1.1 Periodic Inspections

(a) Periodic inspections shall be made by an inspector employed by the authority having jurisdiction or by a person authorized by the authority having jurisdiction.

(b) The inspector shall submit a signed written report to the authority having jurisdiction containing the following information:

- (1) date of inspection(s)
- (2) components or systems that have not been inspected
- (3) Code deficiencies noted during the inspection and a statement as to corrective action taken, if any

- (13) **8.11.1.1.2 Periodic Tests**

(a) Periodic tests as required in 8.6 shall be performed by elevator personnel that are qualified to perform such tests. These tests shall be witnessed by an inspector (see 8.11.1.1) employed by the authority having jurisdiction, or by persons authorized by the authority having jurisdiction.

(b) The inspector shall submit a signed written report to the authority having jurisdiction containing the following information:

- (1) date of inspection(s)
- (2) type of test(s) performed
- (3) detailed results of the test(s) including but not limited to, speed, governor trip speed, safety slide distance, relief valve setting, escalator/moving walk brake torque setting, etc.
- (4) Code deficiencies noted during the test
- (5) statement as to any corrective action taken

8.11.1.2 Applicability of Inspection Requirements.

Inspections required by 8.11.2 through 8.11.5 are to determine that the existing equipment conforms with the following applicable Code requirements:

- (a) the Code at the time of installation

(b) the Code effective as applicable to and for each alteration

(c) the ASME A17.3 Code, if adopted by the authority having jurisdiction

NOTES (8.11.1.2):

- (1) The ASME A17.2 *Guide for Inspection of Elevators, Escalators, and Moving Walks* (see Preface, ASME Elevator Publications) is a guide for inspections.
- (2) References to "Items" of the ASME A17.2 *Guide for Inspection of Elevators, Escalators, and Moving Walks* and to the requirements of this Code are indicated in parentheses as a convenient reference to the applicable inspection procedures and requirements. It is important to understand that suggested test and inspection methodologies represent an approach but are neither exclusive nor comprehensive.

8.11.1.3 Periodic Inspection and Test Frequency.

The frequency of periodic inspections and tests shall be established by the authority having jurisdiction.

NOTE: Recommended intervals for periodic inspections and tests can be found in Nonmandatory Appendix N.

8.11.1.4 Installation Placed Out of Service. Periodic inspections and tests shall not be required when an installation is placed "out of service":

- (a) as defined by the authority having jurisdiction; or
- (b) when an installation whose power feed lines have been disconnected from the mainline disconnect switch; and

(1) an electric elevator, dumbwaiter, or material lift whose suspension ropes have been removed, whose car and counterweight rest at the bottom of the hoistway, and whose hoistway doors have been permanently barricaded or sealed in the closed position on the hoistway side;

(2) a hydraulic elevator, dumbwaiter, or material lift whose car rests at the bottom of the hoistway; when provided with suspension ropes and counterweight, the suspension ropes have been removed and the counterweight rests at the bottom of the hoistway; whose pressure piping has been disassembled and a section removed from the premises and whose hoistway doors are permanently barricaded or sealed in the closed position on the hoistway side; or

(3) an escalator or moving walk whose entrances have been permanently barricaded.

8.11.1.5 Making Safety Devices Ineffective. No person shall at any time make any required safety device or electrical protective device ineffective, except where necessary during tests and inspections. Such devices shall be restored to their normal operating condition in conformity with the applicable requirements prior to returning the equipment to service (see 2.26.7).

8.11.1.7 Unique or Product-Specific Procedures or Methods. Where unique or product-specific procedures or methods are required to maintain, repair, replace, inspect, or test equipment, such procedures or methods

shall be provided by the manufacturer or installer. These procedures and any unique devices required by the procedures for inspection and testing shall be accessible on site to elevator personnel [see also 8.6.1.2.2(b)].

- (13) **8.11.1.8 Maintenance Control Program.** The Maintenance Control Program complying with 8.6.1.2.1 shall be available. On-site equipment documentation complying with 8.6.1.2.2 and maintenance records complying with 8.6.1.4 shall be available.

8.11.2 Periodic Inspection of Electric Elevators

All references to “Items” are to Items in ASME A17.2, Guide for Inspection of Elevators, Escalators, and Moving Walks.

8.11.2.1 Periodic Inspection Requirements. Inspectors shall include the following when identifying components or systems, or both, that shall be inspected.

NOTES:

- (1) For inspection frequency, see 8.11.1.3.
 (2) QEI certified inspectors and inspector supervisors have the knowledge and experience to recognize potential Code deficiencies and to focus their inspections where necessary.

(13) **8.11.2.1.1 Inside Car**

- (a) Door Reopening Device (Item 1.1)
- (b) Stop Switches (Item 1.2)
- (c) Operating Control Devices (Item 1.3)
- (d) Car Floor and Landing Sill (Item 1.3)
- (e) Car Lighting (Item 1.5)
- (f) Car Emergency Signal (Item 1.6)
- (g) Car Door or Gate (Item 1.7)
- (h) Door Closing Force (Item 1.8)
- (i) Power Closing of Doors or Gates (Item 1.9)
- (j) Power Opening of Doors or Gates (Item 1.10)
- (k) Car Vision Panels and Glass Car Doors (Item 1.11)
- (l) Car Enclosure (Item 1.12)
- (m) Emergency Exit (Items 1.13 and 1.20)
- (n) Ventilation (Item 1.14)
- (o) Signs and Operating Device Symbols (Item 1.15)
- (p) Rated Load, Platform Area, and Data Plate (Item 1.16)
- (q) Standby or Emergency Power Operation (Item 1.17)
- (r) Means to restrict hoistway or car doors opening and expiration date for the alternate power source (2.14.5.7) (Item 1.18)
- (s) Car Ride (Item 1.19)
- (t) Door Monitoring Systems (2.26.5)
- (u) Stopping Accuracy (2.26.11)
- (v) Machinery Space/Control Space (8.11.2.1.2)
- (w) Working Areas in the Car (2.7.5.1)
 - (1) means to prevent unexpected movement (2.7.5.1.1)
 - (2) Unexpected Car Movement Device (2.26.2.34)
 - (3) operating instructions for Unexpected Car Movement Device (8.6.10.6)

(4) operating instructions for egress and reentry procedure (8.6.10.7)

(x) Equipment Access Panel Electrical Device (2.26.2.35)

8.11.2.1.2 Machine Room/Spaces, Control Room/ Spaces (ED)

- (a) Equipment Exposure to Weather (2.7.6.6)
- (b) Means of Access (Item 2.1)
- (c) Headroom (Item 2.2)
- (d) Means Necessary for Tests (2.7.6.4)
- (e) Inspection and Test Panel (2.7.6.5)
- (f) Lighting and Receptacles (Item 2.3)
- (g) Enclosure of Machine Room/Spaces, Control Room/Spaces (Item 2.4)
- (h) Housekeeping (Item 2.5)
- (i) Ventilation (Item 2.6)
- (j) Fire Extinguisher (Item 2.7)
- (k) Pipes, Wiring, and Ducts (Item 2.8)
- (l) Guarding of Equipment (Item 2.9)
- (m) Numbering of Elevators, Machines, and Disconnect Switches (Item 2.10)
- (n) Maintenance Path and Maintenance Clearance (2.7.2)
 - (o) Stop Switch (2.7.3.5 and 2.26.2.24)
 - (p) Disconnecting Means and Control (Item 2.11)
 - (q) Controller Wiring, Fuses, Grounding, etc. (Item 2.12)
 - (r) Static Control (Item 2.15)
 - (s) Machinery Supports and Fastenings (Item 2.16)
 - (t) Drive Machine Brake (Item 2.17)
 - (u) Traction Drive Machines (Item 2.18)
 - (v) Gears, Bearings, and Flexible Connections (Item 2.19)
 - (w) Winding Drum Machine (Item 2.20)
 - (x) Belt- or Chain-Drive Machine (Item 2.21)
 - (y) Motor Generator (Item 2.22)
 - (z) Absorption of Regenerated Power (Item 2.23)
 - (aa) Traction Sheaves (Item 2.25)
 - (bb) Secondary and Deflector Sheaves (Item 2.26)
 - (cc) Rope Fastenings (Item 2.27)
 - (dd) Terminal Stopping Devices (Item 2.28)
 - (ee) Operating Devices
 - (ff) Governor, Overspeed Switch, and Seal (Item 2.13)
 - (gg) Car and Counterweight Safeties (Item 2.29)
 - (hh) Code Data Plate (8.6.1.3) (Item 2.14)
 - (ii) Emergency Brake (2.19.3)
 - (jj) AC Drives From a DC Source (Item 2.24)
 - (kk) Slack Rope Devices (Item 2.20)
 - (ll) Wiring Diagrams [8.6.1.2.2(a)]
 - (mm) Rope Retainers or Restraints for Seismic Risk Zones (Item 2.42)
 - (nn) Seismic and Displacement Switches (Item 2.42)

8.11.2.1.3 Top-of-Car

- (a) Top-of-Car Stop Switch (Item 3.1).

- (b) Car Top Light and Outlet (Item 3.2).
- (c) Top-of-Car Operating Device and Working Platforms (Item 3.3).
- (d) Top-of-Car Clearance and Refuge Space (Item 3.4).
- (e) Top Counterweight Clearance (Item 3.24).
- (f) Car, Overhead, and Deflector Sheaves (Item 3.25).
- (g) Normal Terminal Stopping Devices (Item 3.5).
- (h) Final Terminal Stopping Devices (Item 3.6).
- (i) Broken Rope, Chain, or Tape Switch (Item 3.26).
- (j) Car Leveling Devices (Item 3.7).
- (k) Crosshead Data Plate (Item 3.27).
- (l) Top Emergency Exit [Items 3.8 and 3.34.1(j)].
- (m) Counterweight and Counterweight Buffer (Item 3.28).
- (n) Counterweight Safeties (Item 3.29).
- (o) Floor and Emergency Identification Numbering (Item 3.9).
- (p) Hoistway Construction (Item 3.10).
- (q) Hoistway Smoke Control (Item 3.11).
- (r) Pipes, Wiring, and Ducts (Item 3.12).
- (s) Windows, Projections, Recesses, and Setbacks (Item 3.13).
- (t) Hoistway Clearance [Items 3.14 and 3.34.1(a) and (f)].
- (u) Multiple Hoistways (Item 3.15).
- (v) Traveling Cables and Junction Boxes (Item 3.16).
- (w) Door and Gate Equipment (Item 3.17).
- (x) Car Frame and Stiles (Item 3.18).
- (y) Guide Rails Fastening and Equipment (Item 3.19).
- (z) *Governor Rope* (Item 3.20). Governor ropes shall be inspected and replaced as specified in ASME A17.6, Part 1.
 - (aa) Governor Releasing Carrier (Item 3.21).
 - (bb) Fastenings and Hitch Plate (Item 3.22).
 - (cc) Suspension means (Item 3.23) shall be inspected and replaced as specified in ASME A17.6.
 - (dd) Compensation Means (Item 3.34).
 - (ee) Machinery Space/Control Space (8.11.2.1.2).
 - (ff) Working Areas on the Car Top (2.7.5.1)
 - (1) means to prevent unexpected movement (2.7.5.1.1)
 - (2) Unexpected Car Movement Device (2.26.2.34)
 - (3) operating instructions for Unexpected Car Movement Device (8.6.10.6)
 - (4) operating instructions for egress and reentry procedure (8.6.10.7)
 - (gg) Equipment Exposure to Weather (2.7.6.6).
 - (hh) Machinery Supports and Fastenings (2.9.1 and 2.9.3).
 - (ii) Guarding of Exposed Auxiliary Equipment (2.10.1).
 - (jj) Anchoring of beams and supports in seismic risk zone 2 or greater [Item 3.34.1(b)].
 - (kk) Rope retainers and snag guards in seismic risk zone 2 or greater [Items 3.34.1(c) and (d)].

(ll) Position restraints in seismic risk zone 2 or greater [Item 3.34.1(e) and (g)].

(mm) Car and counterweight guide rails system in seismic risk zone 2 or greater [Item 3.34.1(h)].

(nn) For seismic risk zones 2 or greater, horizontal clearance for car and counterweight, snag-point clearance, and rail fastening.

(oo) Seismic risk zone 2 or greater rope retainers/restraints and snag guards (Item 5.16.1).

(pp) Seismic risk zone 2 or greater rope retainer and snag guard for compensating ropes or chains and compensating tension sheave fastening.

(qq) Sheaves with nonmetallic groove surfaces (see 8.6.4.18) (Item 3.34).

8.11.2.1.4 Outside Hoistway

- (a) Car Platform Guard (Item 4.1)
- (b) Hoistway Doors (Item 4.2)
- (c) Vision Panels (Item 4.3)
- (d) Hoistway Door Locking Devices (Item 4.4)
- (e) Access to Hoistway (Item 4.5)
- (f) Power Closing of Hoistway Doors (Item 4.6)
- (g) Sequence Operation (Item 4.7)
- (h) Hoistway Enclosure (Item 4.8)
- (i) Elevator Parking Devices (Item 4.9)
- (j) Emergency and Access Hoistway Openings (Item 4.10)
- (k) Separate Counterweight Hoistway (Item 4.11)
- (l) Standby Power Selection Switch (Item 4.12)
- (m) Means Necessary for Tests (2.7.6.4)
- (n) Inspection and Test Panel (2.7.6.5), Inspection Operation (2.26.1.4.1), and Inspection Operation With Open Door Circuits (2.26.1.5)
- (o) Equipment Exposure to Weather (2.7.6.6)

8.11.2.1.5 Pit

- (a) Pit Access, Lighting, Stop Switch, and Condition (Item 5.1)
- (b) Bottom Clearance and Runby (Item 5.2)
- (c) Car and Counterweight Buffer (Item 5.9)
- (d) Final Terminal Stopping Devices (Item 5.3)
- (e) Normal Terminal Stopping Devices (Item 5.4)
- (f) Traveling Cables (Item 5.5)
- (g) Governor-Rope Tension Devices (Item 5.6)
- (h) Compensating Chains, Ropes, and Sheaves (Item 5.10)
- (i) Car Frame and Platform (Item 5.7)
- (j) Car Safeties and Guiding Members (Item 5.8)
- (k) Machinery Space/Control Space (8.11.2.1.2)
- (l) Working Areas in the Pit (2.7.5.2)
 - (1) means to prevent unexpected movement [2.7.5.2.1(a) or (b)]
 - (2) Unexpected Car Movement Device (2.26.2.34)
 - (3) operating instructions for Unexpected Car Movement Device (8.6.10.6)

(4) operating instructions for egress and reentry procedure (8.6.10.7)

(m) Equipment Exposure to Weather (2.7.6.6)

(n) Machinery Supports and Fastenings (2.9.1 and 2.9.3)

(o) Guarding of Exposed Auxiliary Equipment (2.10.1)

(p) Pit Inspection Operation (2.26.1.4.4)

8.11.2.1.6 Firefighters' Emergency

8.11.2.1.7 Working Platforms

(a) Working Platforms (2.7.5.3 and 2.7.5.4)

(1) operating instructions (8.6.10.8)

(b) Retractable Stops (2.7.5.5)

(1) retractable stop electrical device (2.26.2.37)

(c) Inspection Operation (2.26.1.4.4)

- (13) **8.11.2.1.8 Braking System.** For passenger elevators and all freight elevators, verify that seal on the means of adjusting the holding capacity of the driving-machine brake has not been broken and that it bears or otherwise attaches the identification of the person or firm that installed it (see 8.6.4.20.4).

8.11.3 Periodic Inspection of Hydraulic Elevators

All references to "Items" are to Items in ASME A17.2, Guide for Inspection of Elevators, Escalators, and Moving Walks.

8.11.3.1 Periodic Inspection Requirements. Inspectors shall include the following when identifying components or systems, or both, that shall be inspected.

NOTES:

- (1) For inspection frequency, see 8.11.1.3.
 (2) QEI certified inspectors and inspector supervisors have the knowledge and experience to recognize potential Code deficiencies and to focus their inspections where necessary.

8.11.3.1.1 Inside the Car

(a) Door Reopening Device (Item 1.1)

(b) Stop Switches (Item 1.2)

(c) Operating Control Devices (Item 1.3)

(d) Sill and Car Floor (Item 1.4)

(e) Car Lighting and Receptacles (Item 1.5)

(f) Car Emergency Signal (Item 1.6)

(g) Car Door or Gate (Item 1.7)

(h) Door Closing Force (Item 1.8)

(i) Power Closing of Doors or Gates (Item 1.9)

(j) Power Opening of Doors or Gates (Item 1.10)

(k) Car Vision Panels and Glass Car Doors (Item 1.11)

(l) Car Enclosure (Item 1.12)

(m) Emergency Exit (Items 1.13 and 1.20)

(n) Ventilation (Item 1.14)

(o) Signs and Operating Device Symbols (Item 1.15)

(p) Rated Load, Platform Area, and Data Plate (Item 1.16)

(q) Standby Power Operation (Item 1.17)

(r) Restricted Opening of Car or Hoistway Doors (Item 1.18)

(s) Car Ride (Item 1.19)

(t) Door Monitoring System

(u) Stopping Accuracy

(v) Machinery Space/Control Space (8.11.3.1.2)

(w) Working Areas in the Car (3.7 and 2.7.5.1)

(1) means to prevent unexpected movement (2.7.5.1.1)

(2) Unexpected Car Movement Device (2.26.2.34)

(3) operating instructions for Unexpected Car Movement Device (8.6.10.6)

(4) operating instructions for egress and reentry procedure (8.6.10.7)

(x) Equipment Access Panel Electrical Device (3.26.1 and 2.26.2.35)

8.11.3.1.2 Machine Room/Spaces, Control Room/ Spaces (ED)

(a) Equipment Exposure to Weather (3.7.1)

(b) Means of Access (Item 2.1)

(c) Headroom (Item 2.2)

(d) Means Necessary for Tests (3.7.1)

(e) Inspection and Test Panel (3.7.1)

(f) Lighting and Receptacles (Item 2.3)

(g) Enclosure of Machine Room/Spaces, Control Room/Spaces (Item 2.4)

(h) Housekeeping (Item 2.5)

(i) Ventilation and Heating (Item 2.6)

(j) Fire Extinguisher (Item 2.7)

(k) Pipes, Wiring, and Ducts (Item 2.8)

(l) Guarding of Equipment (Item 2.9)

(m) Numbering of Elevators, Machines, and Disconnect Switches (Item 2.10)

(n) Maintenance Path and Maintenance Clearance (3.7.1)

(o) Stop Switch (3.7.1 and 3.26.1)

(p) Disconnecting Means and Control (Item 2.11)

(q) Controller Wiring, Fuses, Grounding, etc. (Item 2.12)

(r) Hydraulic Power Unit (Items 2.30 and 2.42.1.2)

(s) Relief Valves (Item 2.31)

(t) Control Valve (Item 2.32)

(u) Tanks (Item 2.33)

(v) Flexible Hydraulic Hose and Fitting Assemblies (Item 2.34)

(w) Supply Line and Shutoff Valve (Item 2.35)

(x) Hydraulic Cylinders and Hydraulic Fluid Loss Record (8.6.5.7) (Item 2.36)

(y) Pressure Switch (Item 2.37)

(z) Recycling Operation [8.10.3.2.2(u)]

(aa) Code Data Plate (8.6.1.3) (Item 2.14)

(bb) Governor, Overspeed Switch and Seal (Item 2.13)

(cc) Wiring Diagrams [8.6.1.2.2(a)]

8.11.3.1.3 Top-of-Car

- (a) Top-Of-Car Stop Switch (Item 3.1)
- (b) Car Top Light and Outlet (Item 3.2)
- (c) Top-Of-Car Operating Device (Item 3.3)
- (d) Top-Of-Car Clearance and Refuge Space (Item 3.4)
- (e) Normal Terminal Stopping Device (Item 3.5)
- (f) Terminal Speed Reducing Devices (Item 3.6)
- (g) Car Leveling and Anticreep Devices (Item 3.7)
- (h) Speed Test (Item 3.30)
- (i) Top Emergency Exit (Item 3.8)
- (j) Floor and Emergency Identification Numbering (Item 3.9)
- (k) Hoistway Construction (Item 3.10)
- (l) Hoistway Smoke Control (Item 3.11)
- (m) Pipes, Wiring, and Ducts (Item 3.12)
- (n) Windows, Projections, Recesses, and Setbacks (Item 3.13)
- (o) Hoistway Clearances (Item 3.14)
- (p) Multiple Hoistways (Item 3.15)
- (q) Traveling Cables and Junction Boxes (Item 3.16)
- (r) Door and Gate Equipment (Item 3.17)
- (s) Car Frame and Stiles (Item 3.18)
- (t) Guide Rails Fastening and Equipment (Item 3.19)
- (u) Governor Rope (Item 3.20)
- (v) Governor Releasing Carrier (Item 3.21)
- (w) Wire Rope Fastening and Hitch Plate (Item 3.22)
- (x) Suspension Rope (Item 3.23)

NOTE: Suspension rope shall be inspected and replaced according to the criteria in 8.11.2.1.3(cc).

- (y) Slack Rope Device (Item 3.31)
- (z) Traveling Sheave (Item 3.32)
- (aa) Counterweight and Counterweight Buffer (Item 3.28)
- (bb) Crosshead Data Plate (Item 3.27)
- (cc) Machinery Space/Control Space (8.11.3.1.2)
- (dd) Working Areas on the Car Top (3.7.1)
 - (1) means to prevent unexpected movement (2.7.5.1.1)
 - (2) Unexpected Car Movement Device (2.26.2.34)
 - (3) operating instructions for Unexpected Car Movement Device (8.6.10.6)
 - (4) operating instructions for egress and reentry procedure (8.6.10.7)
- (ee) Equipment Exposure to Weather (3.7.1)
- (ff) Machinery Supports and Fastenings (2.9.1 and 2.9.3)
 - (gg) Guarding of Equipment (2.10.1)
 - (hh) Broken Rope, Chain, or Tape Switch (Item 3.26)

8.11.3.1.4 Outside the Hoistway

- (a) Car Platform Guard (Item 4.1)
- (b) Hoistway Doors (Item 4.2)
- (c) Vision Panels (Item 4.3)
- (d) Hoistway Door Locking Device (Item 4.4)
- (e) Access to Hoistway (Item 4.5)

- (f) Power Closing of Hoistway Doors (Item 4.6)
- (g) Sequence Operation (Item 4.7)
- (h) Hoistway Enclosure (Item 4.8)
- (i) Elevator Parking Device (Item 4.9)
- (j) Emergency Doors in Blind Hoistways (Item 4.10)
- (k) Standby or Emergency Power Selection Switch (Item 4.12)
- (l) Means Necessary for Tests (2.7.6.4, 3.7.1.8, 3.7.1.9, and 3.7.1.10)
- (m) Inspection and Test Panel (3.7.1 and 2.7.6.5), Inspection Operation (2.26.1.4.1), and Inspection Operation With Open Door Circuits (2.26.1.5)
- (n) Equipment Exposure to Weather (3.7.1)

8.11.3.1.5 Pit

- (a) Pit Access, Lighting, Stop Switch, and Condition (Item 5.1)
- (b) Bottom Clearance, Runby, and Minimum Refuge Space (Item 5.2)
- (c) Plunger and Cylinder (Item 5.11)
- (d) Car Buffer (Item 5.12)
- (e) Normal Terminal Stopping Devices (Item 5.4)
- (f) Traveling Cables (Item 5.5)
- (g) Car Frame and Platform (Item 5.7)
- (h) Car Safeties and Guiding Members (Item 5.8)
- (i) Supply Piping (Item 5.14)
- (j) Governor Rope Tension Device (Item 5.6)
- (k) Machinery Space/Control Space (8.11.3.1.2)
- (l) Working Areas in the Pit (3.7.1 and 2.7.5.2)
 - (1) means to prevent unexpected movement [2.7.5.2.1(a) or (b)]
 - (2) Unexpected Car Movement Device (2.26.2.34)
 - (3) operating instructions for Unexpected Car Movement Device (8.6.10.6)
 - (4) operating instructions for egress and re-entry procedure (8.6.10.7)
- (m) Equipment Exposure to Weather (3.7.1)
- (n) Machinery Supports and Fastenings (2.9.1 and 2.9.3)
 - (o) Guarding of Equipment (2.10.1)
 - (p) Pit Inspection Operation (3.26.2)
 - (q) For seismic risk zones, overspeed valve and pipe supports (Item 5.15.2.2)

8.11.3.1.6 Firefighters' Service. See Items 6.3 and 6.4.

8.11.3.1.7 Working Platforms

- (a) Working Platforms (3.7.1, 2.7.5.3, and 2.7.5.4)
 - (1) operating instructions (8.6.10.8)
- (b) Retractable Stops (3.7.1 and 2.7.5.5)
 - (1) retractable stop electrical device (2.26.2.37)
- (c) Inspection Operation (3.26.2)

8.11.4 Periodic Inspection of Escalators and Moving Walks

All references to “Items” are to Items in ASME A17.2, Guide for Inspection of Elevators, Escalators, and Moving Walks.

8.11.4.1 Periodic Inspection and Test Requirements. Inspectors shall include the following when identifying components or systems, or both, that shall be inspected:

NOTES:

- (1) For inspection frequency, see 8.11.1.3.
- (2) QEI certified inspectors and inspector supervisors have the knowledge and experience to recognize potential Code deficiencies and to focus their inspections where necessary.
 - (a) General Fire Protection (Items 7.1 and 9.1)
 - (b) Geometry (Items 7.2 and 9.2)
 - (c) Handrails (Items 7.3 and 9.3)
 - (d) Entrance and Egress (Items 7.4 and 9.4)
 - (e) Lighting (Items 7.5 and 9.5)
 - (f) Caution Signs (Items 7.6 and 9.6)
 - (g) Combplate (Items 7.7 and 9.7)
 - (h) Deck Barricade Guard and Antislid e Devices (Items 7.8 and 9.8)
 - (i) Steps and Treadway (Items 7.9 and 9.9)
 - (j) Operating Devices (Items 7.10 and 9.10)
 - (k) Skirt Obstruction Devices (Item 7.11)
 - (l) Handrail Entry Device (Items 8.13 and 10.13)
 - (m) Egress Restriction Device (Items 7.13 and 9.13)
 - (n) Speed (Items 7.14 and 9.14)
 - (o) Balustrades (Items 7.15 and 9.15)
 - (p) Ceiling Intersection Guards (Items 7.16 and 9.16)
 - (q) Skirt Panels (Items 7.17 and 9.17)
 - (r) Outdoor Protection (Items 7.18 and 9.18)
 - (s) Machine Space Access, Lighting, Receptacle, and Condition (for remote machine rooms only) (Items 2.1 and 4.1)
 - (t) Additional Stop Switch(es) (Items 2.2 and 4.2)
 - (u) Controller and Wiring (Items 2.3 and 4.3)
 - (v) Code Data Plate (2.23.2) (Items 8.14 and 10.14)

8.11.5 Periodic Inspection of Other Equipment

For recommended inspection frequency (see 8.11.1.3).

8.11.5.1 Sidewalk Elevator. Sidewalk elevators shall be subject to the applicable, periodic inspections specified in 8.11.2 and 8.11.3. The inspection requirements shall apply to the corresponding requirements in 5.5. Any additional requirements for this equipment shall also be checked during these inspections.

8.11.5.2 Private Residence Elevators. Private residence elevators should be subject to the periodic inspections specified in 8.11.2 and 8.11.3.

The inspection requirements shall apply to the corresponding requirements in 5.3 and 5.4. Any additional

requirements for this equipment should also be checked during these inspections.

8.11.5.3 Hand Elevators. Hand elevators shall be subject to the applicable, periodic inspections specified in 8.11.2.

The inspection requirements shall apply to the corresponding requirements in 4.3. Any additional requirements for this equipment shall also be checked during these inspections.

8.11.5.4 Dumbwaiters. Dumbwaiters shall be subject to the applicable periodic inspections specified in 8.11.2 and 8.11.3.

The inspection requirements shall apply to the corresponding requirements in Part 7. Any additional requirements for this equipment shall also be checked during these inspections.

8.11.5.5 Material Lifts and Dumbwaiters With Automatic Transfer Devices. Material lifts and dumbwaiters with automatic transfer devices shall be subject to the applicable periodic inspections specified in 8.11.2 and 8.11.3. The inspection requirements shall apply to the corresponding requirements in Part 7. Any additional requirements for this equipment shall also be checked during these inspections.

The inspection requirement shall apply to the corresponding requirements in Part 7. Any additional requirements for this equipment shall also be checked during these inspections.

8.11.5.6 Special Purpose Personnel Elevators. Special purpose personnel elevators shall be subject to the applicable inspections specified in 8.11.2 and 8.11.3.

The inspection requirements shall apply to the corresponding requirements in 5.7. Any additional requirements for this equipment shall also be checked during these inspections.

8.11.5.7 Inclined Elevators. Inclined elevators shall be subject to the applicable periodic inspections specified in 8.11.2 and 8.11.3.

The inspection requirements shall apply to the corresponding requirements in 5.1. Any additional requirements for this equipment shall also be checked during these inspections.

8.11.5.8 Shipboard Elevators. Shipboard elevators shall be subject to the applicable periodic inspections specified in 8.11.2 and 8.11.3.

The inspection requirements shall apply to the corresponding requirements of 5.8. Any additional requirements for this equipment shall also be checked during these inspections.

8.11.5.9 Screw-Column Elevators. Screw-column elevators shall be subject to the applicable periodic inspections specified in 8.11.2 and 8.11.3.

The inspection requirements shall apply to the corresponding requirements of 4.2. Any additional requirements for this equipment shall also be checked during these inspections.

8.11.5.10 Rooftop Elevators. Rooftop elevators shall be subject to the applicable periodic inspections specified in 8.11.2 and 8.11.3.

The inspection requirements shall apply to the corresponding requirements of 5.6. Any additional requirements for this equipment shall also be checked during these inspections.

8.11.5.11 Rack-and-Pinion Elevators. Rack-and-pinion elevators shall be subject to the applicable periodic inspections specified in 8.11.2 and 8.11.3.

The inspection requirements shall apply to the corresponding requirements of 4.1. Any additional requirements for this equipment shall also be checked during these inspections.

8.11.5.12 Limited-Use/Limited-Application Elevators. Limited-use/limited-applications elevators shall be subject to the applicable periodic inspections specified in 8.11.2 and 8.11.3.

The inspection requirements shall apply to the corresponding requirements of 5.2. Any additional requirements for this equipment shall also be checked during these inspections.

8.11.5.13 Elevators Used for Construction

8.11.5.13.1 Inspection Requirements. Inspections shall include the items specified in 8.11.2.1 for electric elevators and 8.11.3.1 for hydraulic elevators, except that

the requirements of 5.10 shall apply where they are different from those in Part 2 and Part 3.

8.11.5.14 Wind Turbine Tower Elevators. Wind turbine tower elevators shall be subject to the applicable periodic inspections specified in 8.11.1, 8.11.2, and the applicable requirements of 8.11.5. (13)

The inspection requirements shall apply to the corresponding requirements of 5.11. Any additional requirements for this equipment shall also be checked during these inspections.

8.11.5.14.1 Wire rope gripping safeties shall be tested with rated load in the car. Tests for governor-operated safeties shall be made by manually tripping the governor at the rated speed. The overspeed switch on the governor shall be made ineffective during the test. All other types of safeties shall be tested in accordance with 8.6.4.19.2 or 8.6.4.20.1.

8.11.5.14.2 Test the overload detection means for conformance with 5.11.16.4 by adding load until the means trips and indication is observed. The car shall not be permitted to electrically operate in either direction.

8.11.5.15 Outside Emergency Elevators. Outside emergency elevators shall be subject to the applicable periodic inspections specified in 8.11.1 and ASME A17.7/CSA B44.7, Requirement 2.12.3. (13)

SECTION 8.12 FLOOD RESISTANCES

8.12.1 Flood-Resistant Design and Construction

Where required by the building code, elevators shall comply with SEI/ASCE 24.

Part 9

Reference Codes, Standards, and Specifications

This Part covers the codes, standards, and specifications incorporated in this Code by reference and the specific editions that are applicable (see 9.1). This Part also lists the names and addresses of the organizations from which these documents may be procured (see 9.2).

Only that portion of the code, standard, or specification as specified by the requirements in this Code is applicable.

Section 9.1 Reference Documents

(13)

| Designation | Standard | Publisher | Applicable to |
|---|--|-----------|---------------|
| 16 CFR Part 1201-03 | Architectural Glazing Standards and Related Materials | US GPO | US |
| 30 CFR 75.1106 | Code Federal Regulations | US GPO | US |
| ADAAG | Americans With Disability Act Accessibility Guidelines | US ATBCB | US |
| AGMA 218.01 | Rating the Pitting Resistance and Bending Strength of Spur and Helical Involute Gear Teeth | AGMA | US |
| AISC Book No. S326, 1978 | Specification for Design, Fabrication, and Erection of Structural Steel for Buildings | AISC | US |
| American Plywood Design Specification A3.3.1 (April 1978) | . . . | APA | US, Canada |
| ANSI A10.4 (latest edition) | Safety Requirements for Personnel Hoists | ANSI | US |
| ANSI A10.5 (latest edition) | Safety Requirements for Material Hoists | ANSI | US |
| ANSI A12.1-1973 | Safety Requirements for Floor and Wall Openings, Railings and Toe Boards | ANSI | US |
| ANSI A14.3-2002 | Safety Requirements for Fixed Ladders | ANSI | US, Canada |
| ANSI A58.1 (latest edition) | Building Code Requirements for Minimum Design Loads in Buildings and Other Structures | ANSI | US |
| ANSI/SIA A92 (latest edition) | Aerial Platforms | SIA | US |
| ANSI Z35.1-1972 | Specifications for Accident Prevention Signs | ANSI | US |
| ANSI Z97.1-1994 | Performance Specifications and Methods of Test for Safety Glazing Material Used in Buildings | ANSI | US |
| ANSI Z535.2 (latest edition) | Environment & Facility Safety Signs | ANSI | US, Canada |
| ANSI Z535.4 (latest edition) | Product Safety Signs and Labels | ANSI | US, Canada |
| ANSI/ACI 318-83 | Building Code Requirements for Reinforced Concrete | ACI | US |
| ANSI/AISC 360-05 | Specification for Structural Steel Buildings | AISC | US |
| ANSI/AF&PA NDS-2005 | National Design Specifications for Wood Construction | ANSI | US |
| ANSI/AWS D1.1 (latest edition) | Structural Welding Code-Steel | AWS | US, Canada |
| ANSI/AWS D1.3 (latest edition) | Structural Welding Code-Sheet Steel | AWS | US, Canada |
| ANSI/BHMA A156.19-2007 | Power Assist and Low Energy Power Operated Doors | BHMA | Canada |
| ANSI/ISO/IEC 17024 | Conformity assessment — General requirements for bodies operating certification of persons | ANSI | US, Canada |
| ANSI/RMA IP-20-1977 | Specifications for Drives Using Classical Multiple V-belts (A, B, C, D, E Cross Sections) | RMA | US |
| ANSI/SAE SP-68 | . . . | SAE | US |

(13)

Section 9.1 Reference Documents (Cont'd)

| Designation | Standard | Publisher | Applicable to |
|---------------------------------------|--|-----------|---------------|
| ANSI/UL 94 (latest edition) | Test of Flammability of Plastic Materials for Parts in Devices and Appliances | UL | US, Canada |
| ANSI/UL 268 (latest edition) | Smoke Detectors for Fire Protective Signaling Systems | UL | US |
| ANSI/UL 723 (latest edition) | Surface Burning Characteristics of Building Materials, Test for | UL | US, Canada |
| ANSI/Vol. Prod. Std. PS-1-74 | Construction and Industrial Plywood | APA | US |
| ASME A17.2 (latest edition) | Guide for Inspection of Elevators, Escalators, and Moving Walks | ASME | US |
| ASME A17.3 (latest edition) | Safety Code for Existing Elevators and Escalators | ASME | US |
| ASME A17.4 (latest edition) | Guide for Emergency Personnel | ASME | US |
| ASME A17.6 | Standard for Elevator Suspension, Compensation, and Governor Systems | ASME | US, Canada |
| ASME A17.7/CSA B44.7 (latest edition) | Performance-Based Safety Code for Elevators and Escalators | ASME, CSA | US, Canada |
| ASME A18.1 (latest edition) | Safety Standard for Platform Lifts and Stairway Chairlifts | ASME | US |
| ASME A90.1 (latest edition) | Safety Standards for Manlifts | ASME | US |
| ASME A120.1 (latest edition) | Safety Requirements for Powered Platforms for Building Maintenance | ASME | US |
| ASME B1.1 (latest edition) | Unified Inch Screw Threads | ASME | US, Canada |
| ASME B1.13M (latest edition) | Metric Screw Threads | ASME | US, Canada |
| ASME B1.20.1 (latest edition) | Pipe Threads, General Purpose (Inch) | ASME | US, Canada |
| ASME B1.20.3 (latest edition) | Dryseal Pipe Threads (Inch) | ASME | US, Canada |
| ASME B1.20.4-1976 (R1982) | Dryseal Pipe Threads (Metric Translation of B1.20.3) | ASME | US, Canada |
| ASME B20.1 (latest edition) | Safety Standards for Conveyors and Related Equipment | ASME | US |
| ASME B29.1-1975 | Precision Power Transmission Roller Chains, Attachments, and Sprockets | ASME | US, Canada |
| ASME B29.2M-1982 (R1987) | Inverted Tooth (Silent) Chains and Sprockets | ASME | US, Canada |
| ASME B29.8-2002 | Leaf Chains, Clevises, and Sheaves | ASME | US, Canada |
| ASME B29.15-1973 (R1987) | Heavy Duty Roller Type Conveyor Chains and Sprocket Teeth | ASME | US, Canada |
| ASME B29.100-2002 | Precision Power Transmission, Double-Pitch Power Transmission, and Double-Pitch Conveyor Roller Chains, Attachments, and Sprockets | ASME | US, Canada |

Section 9.1 Reference Documents (Cont'd)**(13)**

| Designation | Standard | Publisher | Applicable to |
|---|--|-----------|---------------|
| ASME B31.1 (latest edition) | Power Piping | ASME | US, Canada |
| ASME QEI-1 (latest edition) | Standard for the Qualification of Elevator Inspectors | ASME | US |
| ASME Y14.38 (latest edition) | Abbreviations and Acronyms | ASME | US |
| ASME Boiler and Pressure Vessel Code Section VIII (latest edition) | . . . | ASME | US, Canada |
| ASME Guide SI-1 (latest edition) | Orientation and Guide for Use of SI (Metric Units) | ASME | US |
| ASTM A27-84a | Specifications for Mild and Medium-Strength Carbon Steel Castings for General Applications | ASTM | US, Canada |
| ASTM A36-84a | Specifications for Structural Steel | ASTM | US, Canada |
| ASTM A53 (latest edition) | Standard Specification for Pipe, Steel, Black and Hot-Dipped, Zinc Coated, Welded and Seamless | ASTM | US, Canada |
| ASTM A106 (latest edition) | Standard Specification for Seamless Carbon Rule 303.1a Steel Pipe for High-Temperature Service | ASTM | US, Canada |
| ASTM A283-84a | Specifications for Low and Intermediate Tensile Strength Threaded Standard Fasteners | ASTM | US, Canada |
| ASTM A283/A283M-03 (2007) | Standard Specification for Low and Intermediate Tensile Strength Carbon Steel Plates | BHMA | Canada |
| ASTM A307-10 | Standard Specification for Carbon Steel Bolts and Studs, 60 000 PSI Tensile Strength | ASTM | US, Canada |
| ASTM A307-84a | Specifications for Low and Intermediate Tensile Strength Carbon Steel Plate of Structural Quality | ASTM | US, Canada |
| ASTM A502-83a | Specifications for Steel Structural Rivets | ASTM | US, Canada |
| ASTM A668-85 | Specifications for Carbon Allow Steel Forgings for General Industrial Use | ASTM | US, Canada |
| ASTM D97-85 | Standard Test for Pour Point of Petroleum Oils | ASTM | US, Canada |
| ASTM D198-84 | Static Tests of Timbers in Structural Sizes | ASTM | US, Canada |
| ASTM D245-81 (1986) | Establishing Structural Grades and Related Allowable Properties for Visually Graded Lumber | ASTM | US, Canada |
| ASTM D648 | Standard Test Method for Deflection Temperature of Plastics Under Flexural Load in the Edgewise Position | ASTM | US, Canada |
| ASTM D2270-79 | Calculating Viscosity Index from Kinematic Viscosity | ASTM | US, Canada |
| ASTM E8 (latest edition) | Standard Test Methods for Tension Testing of Metallic Materials | ASTM | US, Canada |
| ASTM E84 (latest edition) | Standard Test Method for Surface Burning Characteristics of Building Materials | ASTM | US, Canada |
| ASTM E380 (latest edition) | Metric Practice Guide | ASTM | US |

(13)

Section 9.1 Reference Documents (Cont'd)

| Designation | Standard | Publisher | Applicable to |
|--|---|-----------|---------------|
| ASTM E648-86 | Standard Test Method for Critical Radiant Flux of Floor Covering Systems Using a Radiant Heat Energy Source | ASTM | US |
| CABO One and Two Family Dwelling Code | . . . | ICC | US |
| CAN4-S104 (latest edition) | Fire Tests of Door Assemblies | CSA | Canada |
| CAN/CGSB-12.1-M90 (same as CAN2-12.1) | Glass, Safety, Tempered or Laminated | CGSB | Canada |
| CAN/CGSB-12.11 (latest edition) | Wired Safety Glass | CGSB | Canada |
| CAN/CGSB-12.12 (latest edition) | Plastic Safety Glazing Sheets | CGSB | Canada |
| CAN/CSA B311 (latest edition) | Safety Code for Manlifts | CSA | Canada |
| CAN/CSA B354.1 (latest edition) | Portable Elevating Work Platforms | CSA | Canada |
| CAN/CSA-B72-M87 (R1998) (same as CSA-B72) | Installation Code for Lighting Protection Systems | CSA | Canada |
| CAN/CSA G40.21-1972 | Structural Quality Steels | CSA | Canada |
| CAN/CSA-S16.1-94 | Limit States Design of Steel Structures | CSA | Canada |
| CAN/CSA-T515-97 (same as CAN3-T515-M85) | Requirements for Handset Telephones Intended for Use by the Hard of Hearing | CSA | Canada |
| CAN/CSA-Z185-M87 (R1997) (same as CSA-Z185) | Safety Code for Personnel Hoists | CSA | Canada |
| CAN/CSA-Z256-M87 (R1995) (same as CSA-Z256) | Safety Code for Material Hoists | CSA | Canada |
| CAN/CSA-Z271-98 (same as CSA-Z271) | Safety Code for Suspended Elevating Platforms | CSA | Canada |
| CAN/CSA-Z321 (latest edition) | Signs and Symbols for the Workplace | CSA | US, Canada |
| CAN/ULC-S102.2 (latest edition) | Standard Method of Test for Surface Burning Characteristics of Flooring, Floor Covering, and Miscellaneous Materials and Assemblies | ULC | Canada |
| CEI IEC 61508 Parts 1 through 7 (first edition — 1998) | Functional Safety of Electrical/Electronic/Programmable Electronic Safety-Related Systems | ANSI | US, Canada |
| CSA A23.3-M84 (same as CAN3-A23.3) | Design of Concrete Structures for Buildings | CSA | Canada |
| CSA-B44.1/ASME A17.5 (latest edition) | Standard for Elevator and Escalator Electrical Equipment | ASME | US, Canada |
| CSA B167-96 | Safety Standard for Maintenance and Inspection of Overhead Cranes, Gantry Cranes, Monorails, Hoists, and Trolleys | CSA | Canada |

Section 9.1 Reference Documents (Cont'd)

(13)

| Designation | Standard | Publisher | Applicable to |
|---|--|-----------|---------------|
| CSA B354 (latest edition) | Work Platform Standards | CSA | Canada |
| CSA B355-00 | Lifts for Persons With Physical Disabilities | CSA | Canada |
| CSA B613-00 | Private Residence Lifts for Persons With Physical Disabilities | CSA | Canada |
| CSA C22.1 (latest edition) | Canadian Electrical Code, Part I, Safety Std. for Electrical Installations | CSA | Canada |
| CSA C22.2 No. 139-1982 (R1992) | Electrically Operated Valves | CSA | US, Canada |
| CSA C22.2 No. 141-M1985 (R1992) | Unit Equipment for Emergency Lighting | CSA | US, Canada |
| CSA O86-01 | Engineering Design in Wood | CSA | US, Canada |
| CSA O86.1-94 | Engineering Design in Wood (Limit States Design) | CSA | Canada |
| CSA O151-M1978 (same as CAN/CSA-O151-M78) | Canadian Softwood Plywood | CSA | Canada |
| CSA W47.1-1992 (R1998) | Certification of Companies for Fusion Welding of Steel Structures | CSA | Canada |
| CSA W59-M1989 | Welded Steel Construction (Metal Arc Welding) (Metric Version) | CSA | US, Canada |
| CSA Z150-98 | Safety Code on Mobile Cranes | CSA | Canada |
| CSA Z248-1975 | Code for Tower Cranes | CSA | Canada |
| EN 12016: 1998 | Electromagnetic Compatibility-Product Family Standard for Lifts, Escalator and Passenger Conveyors Immunity | BSI | US, Canada |
| FED-STD 191A Rev.5 (Dec-28-1989) | Federal Standard for Textile Test Methods | GSA | US |
| FEMA 450 | NEHRP Recommended Provisions and Commentary for Seismic Regulations for New Buildings and Other Structures, 2003 Edition | FEMA | US |
| IBC (latest edition) | International Building Code | ICC | US |
| ICC/ANSI A117.1 (latest edition) | Accessible and Usable Buildings and Facilities | ICC | US |
| IEEE 45 (latest edition) | Recommended Practices for Electric Installations on Shipboard | IEEE | US, Canada |
| ISO 22200:2009 | Electromagnetic Compatibility — Product Family Standard for Lifts, Escalators and Moving Walks — Immunity | ANSI | US, Canada |
| ISO/TS 14798-2000 | Risk Assessment | ANSI | US, Canada |
| MIL-DTL-83420M Spec | ... | ... | ... |
| Mineral Resources 30 CFR Parts 1-199 | Code of Federal Regulations MSHA | US GPO | US |
| NBCC (latest edition, except where specified in the Code) | National Building Code of Canada | NRCC | Canada |

(13)

Section 9.1 Reference Documents (Cont'd)

| Designation | Standard | Publisher | Applicable to |
|----------------------------------|--|-----------|---------------|
| NEHRP | National Earthquake Hazards Reduction Program Recommended Provisions for Seismic Regulations for New Buildings | FEMA | US, Canada |
| NEMA 4-250 (latest edition) | Enclosures for Electrical Equipment (1000 Volts Maximum) | . . . | US |
| NFCC (latest edition) | National Fire Code of Canada | NRC | Canada |
| NFPA 13 (latest edition) | Installation of Sprinkler Systems | NFPA | US |
| NFPA 70 (latest edition) | National Electrical Code | NFPA | US |
| NFPA 72 (latest edition) | National Fire Alarm Code | NFPA | US |
| NFPA 80-1986 | Fire Doors and Windows | NFPA | US, Canada |
| NFPA 99 (latest edition) | Standard for Health Care Facilities | NFPA | US |
| NFPA 101 (latest edition) | Life Safety Code | NFPA | US |
| NFPA 105 (latest edition) | Recommended Practice for the Installation of Smoke Control Door Assemblies | NFPA | US, Canada |
| NFPA 252 (latest edition) | Fire Tests of Door Assemblies | NFPA | US |
| NFPA 255 (latest edition) | Fire Test for Evaluating Room Fire Growth Contribution of Textile Wall Covering | NFPA | US, Canada |
| NFPA 265 | Fire Test for Evaluating Room Fire Growth Contributions of Textile Wall Coverings | NFPA | US, Canada |
| NFPA 780 (latest edition) | Lightning Protection Code | NFPA | US |
| NFPA 1971-2000 | Standard on Protective Ensemble for Structural Fire Fighting | NFPA | US |
| NFPA 5000 (latest edition) | Building Construction and Safety Code | NFPA | US |
| SAE J514-1992 | Hydraulic Tube Fittings | SAE | US, Canada |
| SAE J517-1991 | Hydraulic Hoses | SAE | US, Canada |
| SEI/ASCE 24 | Flood Resistance Design and Construction | ASCE | US |
| SOLAS | International Convention for Safety of Life at Sea, Regulation 3, 1974 Amendment | . . . | US |
| UL 10B (latest edition) | Fire Test of Door Assemblies | UL | US |
| UL 104 (latest edition) | Standard for Elevator Door Locking Devices and Contacts | UL | US |
| UL 268 (3 rd edition) | UL Standard for Safety Smoke Detectors for Fire Protective Signaling Systems, Third Edition | UL | US |

Section 9.1 Reference Documents (Cont'd)**(13)**

| Designation | Standard | Publisher | Applicable to |
|--------------------------|---|------------------|----------------------|
| UL 924 | Standard for Safety Emergency Lighting and Power Equipment | UL | US, Canada |
| UL 1037 (latest edition) | Standard for Antitheft Alarms and Devices | UL | US |
| UL 1784 (latest edition) | Standard for Safety for Air Leakage Tests for Door Assemblies | UL | US |
| ... | Elevator Industry Field Employees' Safety Handbook | Elevator World | US, Canada |

(13)

Section 9.2 Procurement Information

| Organization | Address and Phone Number | Organization | Address and Phone Number |
|--------------|---|--------------|---|
| ACI | American Concrete Institute 38800 Country Club Drive Farmington Hills, MI 48331 Telephone: (248) 848-3700 http://www.aci-int.org | AWS | American Welding Society 550 NW LeJeune Road Miami, FL 33126 Telephone: (800) 443-9353 http://www.aws.org |
| AGMA | American Gear Manufacturers Association 500 Montgomery Street Alexandria, VA 22314-1581 Telephone: (703) 684-0211 http://www.agma.org | BHMA | Builders Hardware Manufacturers' Association 355 Lexington Avenue, 15th Floor New York, NY 10017 Telephone: (212) 297-2122 http://www.buildershardware.com |
| AISC | American Institute of Steel Construction, Inc. One East Wacker Drive Chicago, IL 60601-1802 Telephone: (312) 670-2400 http://www.aisc.org | BSI | British Standards Institution 389 Chiswick High Road London, W4 4AL England Telephone: 0181 966 7000 http://www.bsi-global.com |
| ANSI | American National Standards Institute, Inc. 25 West 43rd Street New York, NY 10036 Telephone: (212) 642-4900 http://www.ansi.org | CSA | Canadian Standards Association 5060 Spectrum Way Mississauga, Ontario L4W 5N6, Canada Telephone: (416) 747-4044 (800) 463-6727 http://www.csa.ca |
| APA | American Plywood Association P.O. Box 11700 Tacoma, WA 98411-0700 Telephone: (253) 565-6600 http://www.apawood.org | DOC | U.S. Department of Commerce Commodity Standards Division Available from Superintendent of Documents Government Printing Office Washington, DC 20402 Telephone: (202) 512-1800 (866) 512-1800 http://www.gpo.gov |
| ASCE | American Society of Civil Engineers 1801 Alexander Bell Drive Reston, VA 20191-4400 Telephone: (800) 548-2723 http://www.asce.org | FEMA | Federal Emergency Management Agency Publication Distribution Facility P. O. Box 2012 Jessup, MD 20794 Telephone: (800) 480-2520 http://www.fema.gov |
| ASME | The American Society of Mechanical Engineers Two Park Avenue New York, NY 10016 Telephone: (212) 591-8500 http://www.asme.org ASME Order Department 22 Law Drive Box 2300 Fairfield, NJ 07007-2300 Telephone: (201) 882-1167 (800) 843-2763 | GSA | General Services Administration Federal Supply Service 470 East L'Enfant Plaza, SW Washington, DC 20406 Telephone: (202) 619-8925 http://www.gsa.gov |
| ASTM | American Society for Testing and Materials 100 Barr Harbor Drive P.O. Box C700 West Conshohocken, PA 19428-2959 Telephone: (610) 832-9585 http://www.astm.org | ICC | International Code Council 5203 Leesburg Pike Suite 600 Falls Church, VA 22041 Telephone: (703) 931-4533 http://www.iccsafe.org |

Section 9.2 Procurement Information (Cont'd)

(13)

| Organization | Address and Phone Number | Organization | Address and Phone Number |
|---------------------|--|---------------------|---|
| IEEE | Institute of Electrical and Electronics Engineers, Inc. 445 Hoes Lane P.O. Box 1331 Piscataway, NJ 08854-1331 Telephone: (732) 981-0060 (800) 678-4333 http://www.ieee.org | SAE | Society of Automotive Engineers 400 Commonwealth Drive Warrendale, PA 15096-0001 Telephone: (724) 776-4841 http://www.sae.org |
| NEMA | National Electrical Manufacturers Association 1300 North 17th Street Rosslyn, VA 22209 Telephone: (703) 841-3200 Fax: (703) 841-3200 http://www.nema.org | SIA | Scaffold Industry Association, Inc. 20335 Ventura Blvd., Suite 310 Woodland Hills, CA 91364 Telephone: (818) 610-0320 http://www.scaffold.org |
| NFPA | National Fire Protection Association 1 Batterymarch Park Quincy, MA 02269-7471 Telephone: (617) 770-3000 http://www.nfpa.org | UL | Underwriters Laboratories, Inc. 333 Pfingsten Road Northbrook, IL 60062-2096 Telephone: (847) 272-8800 http://www.ul.com |
| NRCC | National Research Council of Canada Institute for Research in Construction Ottawa, Ontario, K1A0R6 Canada Telephone: (613) 993-2463 http://www.nrc.ca | US ATBCB | United States Access Board 1331 F Street, NW Washington, DC 20004-1111 Telephone: (800) 872-2253 http://www.access-board.gov |
| RMA | Rubber Manufacturers Association 1400 K Street, NW Washington, DC 20005 Telephone: (202) 682-4800 http://www.rma.org | US GPO | U.S. Government Printing Office Superintendent of Documents 732 N. Capitol Street, NW Washington, DC 20401 Telephone: (202) 512-0000 (866) 512-1800 http://www.gpoaccess.gov/index.html |

INTENTIONALLY LEFT BLANK

NONMANDATORY APPENDIX A CONTROL SYSTEM

See Fig. A-1 on the following page.

Fig. A-1

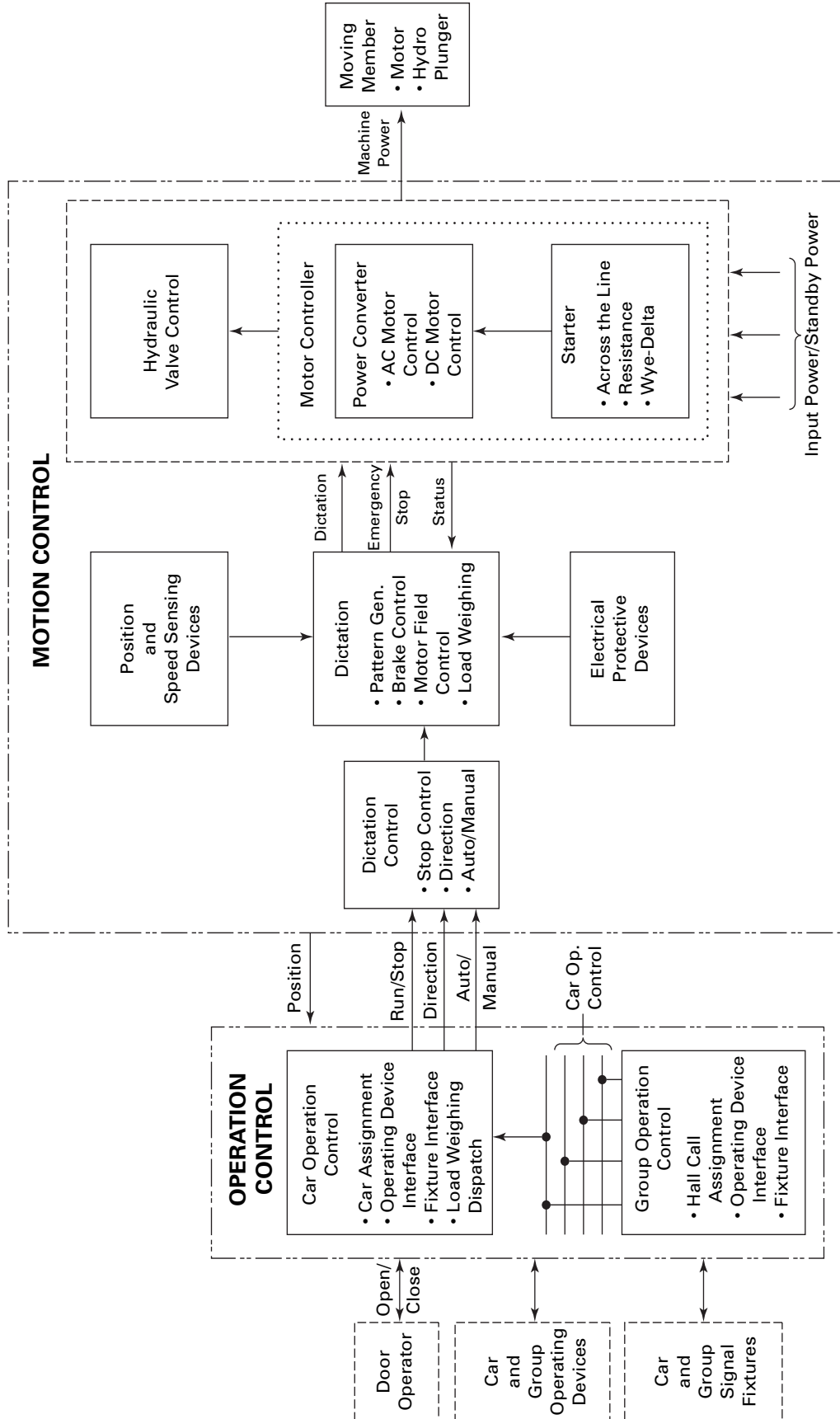

NONMANDATORY APPENDIX B UNLOCKING ZONE

(13)

**Fig. B-1 Unlocking Zone
(2.14.5.7)**

(13)

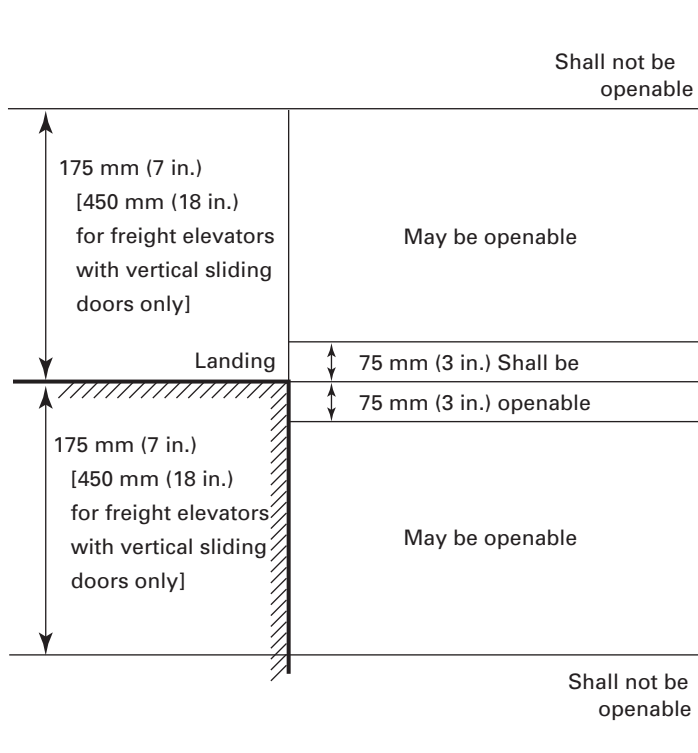

NONMANDATORY APPENDIX C LOCATION OF TOP EMERGENCY EXIT

Fig. C-1 Parallelepiped Volume Orientations
[2.14.1.5.1(b)(2)]

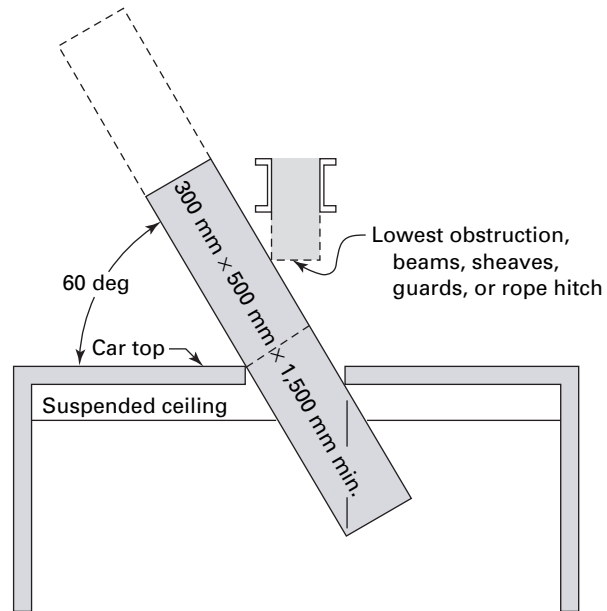

NONMANDATORY APPENDIX D RATED LOAD AND CAPACITY PLATES FOR PASSENGER ELEVATORS

Requirement 2.16.1 specifies the minimum rated load for passenger elevators in terms of kilograms (pounds). Requirement 2.16.3.2.1 requires that a capacity plate indicating the rated load in kilograms (pounds) be located inside the car.

When local ordinances require the elevator capacity to be also indicated in terms of persons, the number of

persons should be calculated by dividing the rated load, if expressed in kilograms, by 72.5 or by 160 if expressed in pounds. The result (quotient) should be reduced to the next lowest whole number. As an example, if the result is 14.97, the capacity in terms of persons should be 14.

(13)

NONMANDATORY APPENDIX E

ELEVATOR REQUIREMENTS FOR PERSONS WITH PHYSICAL DISABILITIES IN JURISDICTIONS ENFORCING NBCC

INTRODUCTION

This Appendix was developed and approved by the CSA B44 Technical Committee. The ASME A17 Standards Committee, in the spirit of harmonization, authorized the publication of this Appendix.

This Appendix is not a mandatory part of this Code; however, it is provided for reference in order to comply with the requirements of the NBCC.

E-1 Scope

This Appendix contains requirements intended to make passenger elevators usable by persons with physical disabilities in jurisdictions enforcing NBCC. These requirements are in addition to, or modifications of, certain requirements specified elsewhere in this Standard. Elevators shall be passenger elevators as classified by ASME A17.1/CSA B44. Elevator operation shall be automatic.

E-2 Definitions

destination-oriented elevator system: an elevator system that provides lobby controls for the selection of destination floors, lobby indicators designating which elevator to board, and a car indicator designating the floors at which the car will stop.

elevator car call sequential step scanning: a technology used to enter a car call by means of an up or down floor selection button.

physical disability: a disability resulting in a mobility or sensory impairment.

variable message signs (VMS): electronic signs that have a message with the capacity to change by means of scrolling, streaming, or paging across a background.

variable message sign (VMS) characters: characters of an electronic sign composed of pixels in an array.

E-3 Leveling

Each car shall automatically stop and maintain position at floor landings within a tolerance of 13 mm ($\frac{1}{2}$ in.) under rated loading to zero loading conditions.

E-4 Door Operation

Power-operated horizontally sliding car and landing doors opened and closed by automatic means shall be provided.

E-5 Door Size

The clear width of elevator doors shall comply with Table E-1.

E-6 Door Protective and Reopening Device

E-6.1 Doors shall be provided with a door-reopening device that automatically stops and reopens the car door and landing door if the door becomes obstructed by an object or person. This reopening device shall also be capable of sensing an object or person in the path of a closing door at 125 mm \pm 25 mm (5 in. \pm 1 in.) and 735 mm \pm 25 mm (29 in. \pm 1 in.) above the floor without requiring contact for activation, although contact may occur before the door reverses.

E-6.2 Door-reopening devices shall remain effective for a period of not less than 20 s.

E-7 Door Timing for Hall and Car Calls

E-7.1 The minimum acceptable time from notification that a car is answering a call until the doors of that car start to close shall be calculated from the following equation, but shall not be less than 5 s:

$$T = D/(455 \text{ mm/s})$$

or

$$T = D/(1.5 \text{ ft/s})$$

where T equals the total time in seconds and D equals the distance (in mm or ft) from the point in the lobby or corridor 1 525 mm (60 in.) directly in front of the farthest call button controlling that car to the centerline of its hoistway door.

E-7.2 For cars with in-car lanterns, T shall begin when the signal is visible from the point 1 525 mm (60 in.) directly in front of the farthest hall call button and the audible signal is sounded.

E-7.3 Elevator doors shall remain fully open in response to a car call for 3 s minimum.

E-8 Inside Dimensions of Elevator Cars

E-8.1 The inside dimensions of elevator cars shall comply with Table E-1.

Table E-1 Minimum Dimensions of Elevator Cars

| Door Location | Door Clear Width, mm | Inside Car, Side to Side, mm | Inside Car, Back Wall to Front Return, mm | Inside Car, Wall to Inside Face of Door, mm |
|-------------------|----------------------|------------------------------|---|---|
| Centered | 1 065 | 2 030 | 1 295 | 1 370 |
| Side (off-center) | 915 ² | 1 725 | 1 295 | 1 370 |
| Any | 915 ² | 1 370 | 2 030 | 2 030 |
| Any | 915 ² | 1 525 | 1 525 | 1 525 |

GENERAL NOTES:

(a) Table E-1 is based on Table 407.2.8 and 407.4.1 in ANSI/ICC A117.1, metric values only.

(b) A tolerance of -16 mm shall be permitted.

E-8.2 Other car configurations that provide a 915 mm (36 in.) minimum clear door width and a circular space with a minimum diameter of 1 525 mm (60 in.) with the door closed are permitted.

E-9 Car Controls

E-9.1 Features. Car controls shall have the features as specified in Clauses E-9.2 to E-9.7.

E-9.2 Height. Buttons with floor designations shall be located a maximum of 1 220 mm (48 in.) above the floor or ground measured to the centerline of the buttons. Emergency control buttons, including emergency alarms where provided, shall be grouped at the bottom of the panel. Emergency control buttons shall have their centerlines 890 mm (35 in.) minimum above the floor or ground.

E-9.3 Buttons

E-9.3.1 Button Dimensions. Buttons shall be 19 mm (0.75 in.) minimum in their smallest dimension. Buttons or surrounding button collars shall be raised a minimum of 1.5 mm (0.06 in.).

E-9.3.2 Button Arrangement. Buttons shall be arranged with numbers in ascending order. Floors shall be designated . . . -4, -3, -2, -1, 0, 1, 2, 3, 4, etc., with floors below the main entry floor designated with minus numbers. Numbers shall be permitted to be omitted, provided the remaining numbers are in sequence. Where a telephone keypad arrangement is used, the number key (#) shall be utilized to enter the minus symbol (“-”). When two or more columns of buttons are provided, they shall read from left to right.

E-9.3.2.1 Where existing building floor designations differ from the arrangement required by Clause E-9.3.2 or are alphanumeric, a new operating panel shall be permitted to use such existing building floor designations.

E-9.3.3 Button Characteristics

E-9.3.3.1 Control buttons shall be identified by raised characters and Braille complying with Clause E-20.

E-9.3.3.2 Raised character and Braille designations shall be placed immediately to the left of the button to which the designations apply. When a negative number is used to indicate a negative floor, the Braille designation shall be a cell with the dots 3 and 6 followed by the ordinal number.

E-9.3.4 Control Button. The control button for the main entry floor, and control buttons other than remaining buttons with floor designations, shall be identified with raised symbols and Braille as shown in Table 2.26.12.1.

The location and size of Braille, where required, shall comply with Table 2.26.12.1.

E-9.3.5 Visible Indicators. Buttons with floor designations shall be provided with visible indicators to show that a call has been registered. The visible indication shall extinguish when the car arrives at the designated floor.

E-9.3.6 Elevator Car Call Sequential Step Scanning. Elevator car call sequential step scanning shall be provided where car control buttons are provided more than 1 220 mm (48 in.) above the floor. Floor selection shall be accomplished by applying momentary or constant pressure to the up or down scan button. The up scan button shall sequentially select floors above the current floor. The down scan button shall sequentially select floors below the current floor. When pressure is removed from the up or down scan button for more than 2 s, the last floor selected shall be registered as a car call. The up and down scan button shall be located adjacent to or immediately above the emergency control buttons.

E-9.4 Telephone-Style Keypads. Telephone-style keypads shall be in a standard telephone keypad arrangement. Call buttons shall be 19 mm (0.75 in.) minimum in their smallest dimension. Buttons shall be raised a minimum of 1.5 mm (0.06 in.). Braille shall not be required. Characters shall be 13 mm (0.5 in.) minimum in height and otherwise conform to Clause E-20.4. The number five key shall have a single raised dot. The dot shall be 3.00 mm to 3.05 mm (0.118 in. to 0.12 in.) base diameter and in other aspects conform to Table E-20.4. Characters shall be centred on the corresponding keypad button. A display shall be provided in the car with visible indicators to show registered car destinations. The visible indication shall extinguish when the call has been answered. A standard five-pointed star shall be used to indicate the main entry floor.

E-10 Car Position Indicators

E-10.1 General. In elevator cars, both audible and visible car floor location indicators shall be provided to identify the floor location of the car.

E-10.2 Visible Indicators. Indicators shall be located above the car control panel or above the door. Numerals shall be 16 mm (0.63 in.) minimum in height.

E-10.2.1 Floor Arrival. To indicate a car passing a floor and when a car stops at a floor, served by the elevator, the corresponding character shall illuminate.

E-10.3 Audible Indicators

E-10.3.1 The audible signal shall be 10 dBA minimum above ambient, but shall not exceed 80 dBA maximum, measured at the annunciator. The signal shall be an automatic verbal announcement that announces the floor at which the car is about to stop. The verbal announcement indicating the floor shall be completed prior to the initiation of the door opening. The verbal annunciator shall have a frequency of 300 Hz minimum and 3,000 Hz maximum.

E-10.3.2 For elevators, other than destination-oriented elevators, that have a rated speed of 1 m/s (200 ft/min) or less, where the verbal annunciator is not provided, an audible signal with a frequency of 1 500 Hz maximum that sounds as the car passes or stops at a floor served by the elevator shall be permitted.

E-11 Emergency Communications

E-11.1 General. Emergency two-way communication systems between the elevator car and a point outside the hoistway shall comply with 2.27.1. The operable parts of a two-way communication system shall be located between 380 mm (1.5 in.) and 1 220 mm (48 in.) from the floor.

E-11.2 Instructions. Operating instructions required by 2.27.1 shall be presented in both tactile and visual form.

E-12 Floor Surfaces

Floor surfaces in elevator cars shall have a firm, stable, and slip-resistant surface that permits easy movement of wheelchairs. Carpet pile height shall be 13 mm (0.5 in.) maximum.

E-13 Handrails

Handrails shall be provided on all nonaccess walls. The top of the gripping surfaces of the handrails shall be at a height of 800 mm to 920 mm (31.5 in. to 36.2 in.), with a space of 35 mm to 45 mm (1.4 in. to 1.8 in.) between the handrails and wall.

E-14 Illumination Levels

The level of illumination at the car controls shall be 100 lx (10 fc) minimum.

E-15 Hall Buttons

E-15.1 Hall buttons and keypad buttons in elevator lobbies and halls shall be located vertically between 890 mm (35 in.) and 1 220 mm (48 in.) above the floor, measured to the centerline of the respective button.

E-15.2 A clear floor space of 760 mm (30 in.) minimum by 1 220 mm (48 in.) minimum shall be provided at hall buttons and keypads.

E-15.3 Hall buttons shall be 19 mm (0.75 in.) minimum in the smallest dimension.

E-15.4 Hall buttons shall have visual signals to indicate when each call is registered and when each call is answered. Call buttons shall provide an audible signal or mechanical motion of the button to indicate when each call is registered.

E-15.5 The hall button that designates the UP direction shall be located above the button that designates the DOWN direction. Buttons or surrounding button collars shall be raised a minimum of 1.5 mm (0.06 in.). Objects located beneath hall buttons shall protrude 25 mm (1 in.) maximum.

E-15.6 Keypads. Where keypads are provided they shall comply with Clause E-9.4.

E-16 Hall or In-Car Signals

E-16.1 General. A visible and audible signal shall be provided at each hoistway entrance to indicate which car is answering a call and its direction of travel, except that signals in cars, visible from the floor area adjacent to the hall call buttons, and complying with requirements of Clauses E-16.2 and E-16.3, shall be permitted.

E-16.2 Audible Signals. Audible signals shall sound once for the UP direction and twice for the DOWN direction, or shall have verbal annunciators that state the word UP or DOWN. Audible signals shall have a frequency of 1 500 Hz maximum. Verbal annunciators

shall have a frequency of 300 Hz minimum and 3 000 Hz maximum. The audible signal or verbal annunciator shall be 10 dBA minimum above ambient, but shall not exceed 80 dBA maximum, measured at the hall call button.

E-16.3 Visible Signals

E-16.3.1 Height. Hall signal fixtures shall be 1 830 mm (72 in.) minimum above the floor or ground, measured to the centerline of the fixture.

E-16.3.2 Size. The visible signal elements shall be 60 mm (2.36 in.) minimum between the uppermost and lowest edges of the illuminated shape measured vertically.

E-16.3.3 Visibility. Signals shall be visible from the floor area adjacent to the hall button.

E-17 Floor/Car Designations

Raised character and Braille floor designations shall be provided on both jambs of elevator hoistway entrances and shall be centred at 1 525 mm (60 in.) above the floor, measured from the baseline of the characters. A raised star placed immediately to the left of the floor designation shall also be provided on both jambs at the main entry level. Such characters shall be 50 mm (2 in.) high and shall comply with Clause E-20.2 and E-20.3.

E-18 Destination-Oriented Elevators

E-18.1 General. Destination-oriented elevators shall comply with Clauses E-3 to E-8, E-11, E-12, E-14, E-17, and E-18.2 to E-18.6.

E-18.2 Call Buttons. Call buttons shall be 890 mm minimum and 1 220 mm maximum (35 in. minimum and 48 in. maximum) above the floor or ground, measured to the centerline of the buttons. A clear floor or ground space of 760 mm × 1 220 mm (30 in. × 48 in.) shall be provided. Call buttons shall be 19 mm (0.75 in.) minimum in their smallest dimension. Buttons shall be raised a minimum of 1.5 mm (0.06 in.). Objects beneath hall call buttons shall protrude 25 mm (1 in.) maximum into the clear floor or ground space. Destination-oriented elevator systems shall have a keypad or other means for the entry of destination information. Keypads, if provided, shall be in a standard telephone keypad arrangement, and buttons shall be identified by visual characters complying with Clause E-20.2. Characters shall be centered on the corresponding keypad button. The number five key shall have a single raised dot. The dot shall be 3.00 mm to 3.05 mm (0.118 in. to 0.12 in.) base diameter, and in other aspects comply with Table E-20.4. Destination-oriented elevator systems shall be provided with a visual signal and audible tones and verbal announcements to indicate which car is responding to a call. The audible tones and verbal announcements shall be activated by pressing a function button. The function

button shall be identified by the international symbol for accessibility and a raised indication (see Fig. E-20.6.3). The symbol shall be 16 mm (0.63 in.) in height and be a visual character complying with Clause E-20.2. The indication shall be three raised dots, spaced 6 mm (0.25 in.) at base diameter, in the form of an equilateral triangle. The function button shall be located immediately below the keypad arrangement or floor buttons. A display shall be provided in the car with visible indicators to show registered car destinations.

E-18.3 Hall Signals

E-18.3.1 General. Destination-oriented elevators shall be provided with a visible signal and audible tones and verbal announcements to indicate which car is responding to a call. The signals shall be the same as those given at the call button or call button keypad, if provided. Each elevator in a bank shall have audible and visible means for differentiation.

E-18.3.2 Visible Signals

E-18.3.2.1 Height. Hall signal fixtures shall be 1 830 mm (72 in.) minimum above the floor or ground, measured to the centerline of the fixture.

E-18.3.2.2 Size. The visible signal elements shall be 60 mm (2.36 in.) minimum in their smallest dimension.

E-18.3.2.3 Visibility. Signals shall be visible from the floor area adjacent to the hoistway entrance.

E-18.4 Car Controls. Emergency controls, including emergency alarms where provided, shall have centerlines that are 890 mm minimum and 1 220 mm maximum (35 in. minimum and 48 in. maximum) above the floor or ground. Buttons shall be 19 mm (0.75 in.) minimum in their smallest dimension. Buttons shall be raised a minimum of 1.5 mm (0.06 in.).

E-18.5 Car Position Indicators

E-18.5.1 General. In elevator cars, audible and visible car location indicators shall be provided.

E-18.5.2 Visible Indicators. A display shall be provided in the car with visible indicators to show car destinations. Numerals shall be 16 mm (0.63 in.) high minimum. The visible indicators shall extinguish when the car arrives at the designated floor.

E-18.5.3 Audible Indicators. An automatic verbal announcement that announces the floor at which the car is about to stop shall be provided. The announcement shall be 10 dBA minimum above ambient and 80 dBA maximum, measured at the annunciator. The verbal announcement indicating the floor shall be completed prior to the initiation of the door opening. The verbal annunciator shall have a frequency of 300 Hz minimum and 3,000 Hz maximum.

E-18.6 Elevator Car Identification. In addition to the tactile signs required by Clause E-17, a raised elevator car identification shall be placed immediately below the hoistway entrance floor designation. The characters shall be 50 mm (2 in.) high and shall comply with Clauses E-20.2 and E-20.3.

E-18.7 Destination-Oriented Elevators.

Destination-oriented elevators shall not be required to comply with Clause E-7.1.

E-19 Limited-Use/Limited-Application Elevators

Limited-use/limited-application elevators shall comply with Clauses E-1, E-3, E-5 through E-17, and E-19.

E-19.1 Elevator Door Requirements. Elevator hoistway doors shall comply with Clause E-19.1.

E-19.1.1 Sliding Doors. Sliding hoistway doors shall comply with Clause E-4.

E-19.1.2 Swinging Doors. Swinging hoistway doors shall open and close automatically and shall comply with Clause E-19.1.2. The clear floor space for hall call buttons shall be located beyond the arc of the door swing.

E-19.1.2.1 Power Operation. Swinging doors shall be power-operated and shall comply with ANSI/BHMA A156.19.

E-19.1.2.2 Duration. Power-operated swinging doors shall remain open for 20 s minimum when activated.

E-19.1.3 Door Location and Width. Car doors shall comply with Clause E-19.1.3.

E-19.1.3.1 Cars With Single Door or Doors on Opposite Ends. Car doors shall be positioned at the narrow end of cars with a single door and on cars with doors on opposite ends. Doors shall provide a clear opening width of 815 mm (32 in.) minimum.

E-19.1.3.2 Cars With Doors on Adjacent Sides

E-19.1.3.2.1 Car doors shall be permitted to be located on adjacent sides of cars that provide a 1.67 m² (18 ft²) platform. Doors located on the narrow end of cars shall provide a clear opening width of 915 mm (36 in.) minimum. Doors located on the long side shall provide a clear opening width of 1 065 mm (42 in.) minimum and be located as far as practicable from the door on the narrow end.

E-19.1.3.2.2 Car doors that provide a clear opening width of 915 mm (36 in.) minimum shall be permitted to be located on adjacent sides of cars that provide a clear floor area of 1 295 mm (51 in.) width and 1 295 mm (51 in.) in depth.

E-19.2 Elevator Car Requirements. Elevator cars shall comply with Clause E-19.2.

E-19.2.1 Inside Dimensions. Elevator cars shall provide a clear floor width of 1 065 mm (42 in.) minimum. The clear floor area shall not be less than 1.46 m² (15.75 ft²).

E-19.3 Elevator Car Controls, Control panels shall be centered on the longest side wall.

E-20 Signs

E-20.1 Accessible signs shall comply with Clause E-20.2. Tactile signs shall contain both raised characters and Braille. Where signs with both visual and raised characters are required, either one sign with both visual and raised characters, or two separate signs, one with visual, and one with raised characters, shall be provided.

E-20.2 Visual Characters

E-20.2.1 General

E-20.2.1.1 Visual characters shall comply with either of the following:

(a) Visual characters that also serve as raised characters shall comply with Clause E-20.3.

(b) Visual characters on Variable Message Signs (VMS) signage shall comply with Clause E-20.7.

(c) Visual characters not covered in (a) and (b) above shall comply with Clause E-20.2.

E-20.2.1.2 The visual and raised requirements of E-20.2.1.1(a) shall be permitted to be provided by two separate signs that provide corresponding information provided one sign complies with Clause E-20.2 and the second sign complies with Clause E-20.3.

E-20.2.2 Case. Characters shall be uppercase, lowercase, or a combination of both.

E-20.2.3 Style. Characters shall be conventional in form. Characters shall not be italic, oblique, script, highly decorative, or of other unusual form.

E-20.2.4 Character Height. The uppercase letter "I" shall be used to determine the allowable height of all characters of a font. The uppercase letter "I" of the font shall have a minimum height of 16 mm (0.63 in.), plus 3 mm (0.118 in.) per 305 mm (1 ft) of viewing distance above 1 830 mm (6 ft). Viewing distance shall be measured as the horizontal distance between the character and an obstruction preventing further approach towards the sign.

E-20.2.5 Character Width. The uppercase letter "O" shall be used to determine the allowable width of all characters of a font. The width of the uppercase letter "O" shall be 55% minimum and 110% maximum of the height of the uppercase letter "I" of the font.

E-20.2.6 Stroke Width. The uppercase letter "I" shall be used to determine the allowable stroke width of all characters of a font. The stroke width shall be

10% minimum and 30% maximum of the height of the uppercase "I" of the font.

E-20.2.7 Character Spacing. Spacing shall be measured between the two closest points of adjacent characters within a message, excluding word spaces. Spacing between individual characters shall be 10% minimum and 35% maximum of the character height.

E-20.2.8 Line Spacing. Spacing between the base-lines of separate lines of characters within a message shall be 135% minimum to 170% maximum of the character height.

E-20.2.9 Finish and Contrast. Characters and their background shall have a non-glare finish. Characters shall contrast with their background, with either light characters on a dark background, or dark characters on a light background.

E-20.3 Raised Characters

E-20.3.1 General. Raised characters shall comply with Clause E-20.3, and shall be duplicated in Braille complying with Clause E-20.4.

E-20.3.2 Depth. Raised characters shall be raised a minimum of 0.8 mm (0.03 in.) above their background.

E-20.3.3 Case. Characters shall be uppercase.

E-20.3.4 Style. Characters shall be sans serif. Characters shall not be italic, oblique, script, highly decorative, or of other unusual form.

E-20.3.5 Character Height

E-20.3.5.1 The uppercase letter "I" shall be used to determine the allowable height of all characters of a font. The uppercase letter "I" of the font, measured vertically from the baseline of the character, shall be 16 mm (0.63 in.) minimum, and 50 mm (2 in.) maximum.

E-20.3.5.2 Where separate raised and visual characters with the same information are provided, the height of the raised uppercase letter "I" shall be permitted to be 13 mm (0.5 in.) minimum.

E-20.3.6 Character Width. The uppercase letter "O" shall be used to determine the allowable width of all characters of a font. The width of the uppercase letter "O" of the font shall be 55% minimum and 110% maximum of the height of the uppercase letter "I" of the font.

E-20.3.7 Stroke Width. Raised character stroke width shall comply with Clause E-20.3.7. The uppercase letter "I" of the font shall be used to determine the allowable stroke width of all characters of a font.

E-20.3.7.1 Maximum. The stroke width shall be 15% maximum of the height of the uppercase letter "I" measured at the top surface of the character.

E-20.3.7.2 Minimum. When characters are both visual and raised, the stroke width shall be 10% minimum of the height of the uppercase letter "I."

E-20.3.8 Character Spacing. Character spacing shall be measured between the two closest points of adjacent raised characters within a message, excluding word spaces. Spaces between individual characters shall be 3 mm (0.118 in.) minimum measured at the top surface of the characters, 1.6 mm (0.63 in.) minimum measured at the base of the characters, and four times the raised character stroke width maximum. Characters shall be separated from raised borders and decorative elements 10 mm (0.4 in.) minimum.

E-20.3.9 Line Spacing. Spacing between the base-lines of separate lines of raised characters within a message shall be 135% minimum and 170% maximum of the raised character height.

E-20.3.10 Location. Where a sign containing raised characters and Braille is provided at double doors with one active leaf, the sign shall be located on the inactive leaf. Where a sign containing raised characters and Braille is provided at double doors with two active leaves, the sign shall be to the right of the right-hand door. Where there is no wall space on the latch side of a single door, or to the right side of double doors, signs shall be on the nearest adjacent wall. Signs containing raised characters and Braille shall be located so that a clear floor area 455 mm (18 in.) minimum by 455 mm (18 in.) minimum, centered on the raised characters, is provided beyond the arc of any door swing between the closed position and 45 deg open position.

E-20.3.11 Finish and Contrast

E-20.3.11.1 Characters and their background shall have a non-glare finish. Characters shall contrast with their background with either light characters on a dark background or dark characters on a light background.

E-20.3.11.2 Where separate raised characters and visual characters with the same information are provided, raised characters are not required to have non-glare finish or to contrast with their background.

E-20.4 Braille

E-20.4.1 General. Braille shall be contracted (Grade 2) Braille and shall comply with Clause E-20.4.

E-20.4.2 Uppercase Letters. The indication of an uppercase letter or letters shall only be used before the first word of sentences, proper nouns and names, individual letters of the alphabet, initials, and acronyms.

E-20.4.3 Dimensions. Braille dots shall have a domed or rounded shape and shall comply with Table E-20.4. See also Fig. E-20.4.

Table E-20.4 Measurement Range for Standard Sign Braille

| Measurement Range | Minimum, mm | Maximum, mm |
|--|-------------|-------------|
| Dot base diameter | 1.5 | 1.6 |
| Distance between two dots in the same cell, center to center | 2.3 | 2.5 |
| Distance between corresponding dots in adjacent cells, center to center | 6.1 | 7.6 |
| Dot height | 0.6 | 0.9 |
| Distance between corresponding dots from one cell to the cell directly below, center to center | 10.0 | 10.2 |

Fig. E-20.4 Braille Measurements

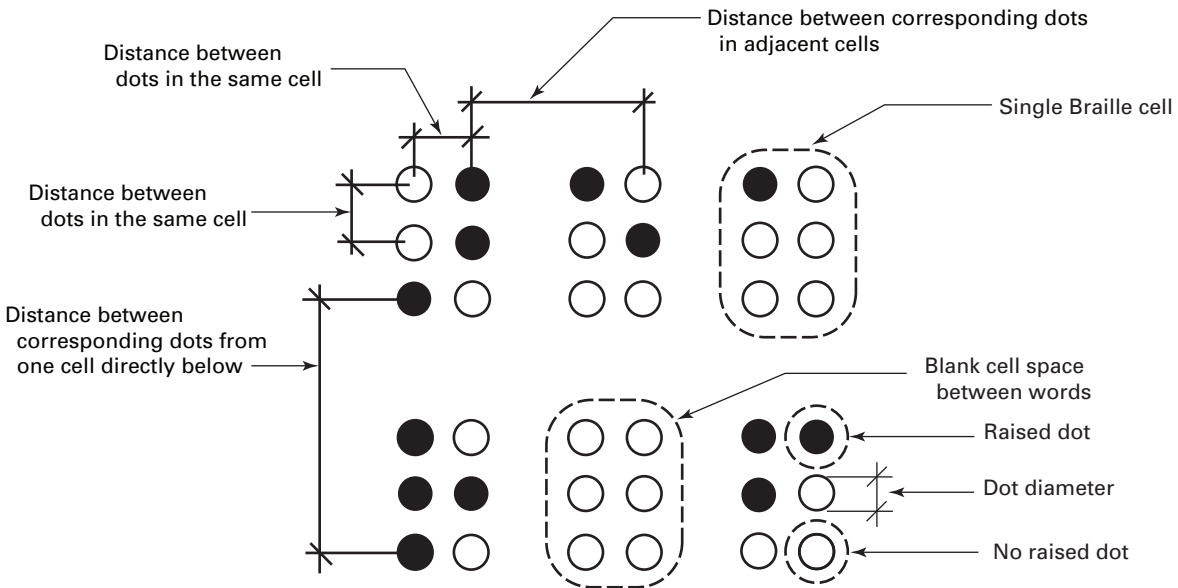

E-20.4.4 Position. Braille shall be below the corresponding text. If text is multilined, Braille shall be placed below the entire text. Braille shall be separated 10 mm (0.4 in.) minimum from any other raised characters and 10 mm (0.4 in.) minimum from raised borders and decorative elements. Braille provided on elevator car controls shall be separated 5 mm (0.2 in.) minimum either directly below or adjacent to the corresponding raised characters or symbols.

E-20.5 Pictograms

E-20.5.1 General. Pictograms shall comply with Clause E-20.5.

E-20.5.2 Pictogram Field. Pictograms shall have a field 150 mm (6 in.) minimum in height. Characters or Braille shall not be located in the pictogram field.

E-20.5.3 Finish and Contrast. Pictograms and their fields shall have a non-glare finish. Pictograms shall

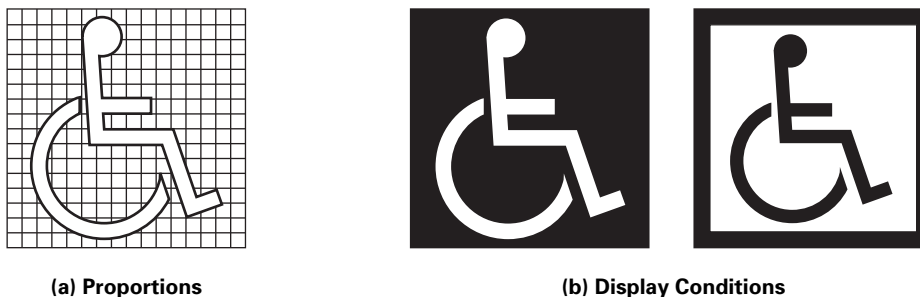
Fig. E-20.6.3 International Symbol of Accessibility

contrast with their fields, with either a light pictogram on a dark field or a dark pictogram on a light field.

E-20.6 Symbols of Accessibility

E-20.6.1 General. Symbols of accessibility shall comply with Clause E-20.6.

E-20.6.2 Finish and Contrast. Symbols of accessibility and their backgrounds shall have a non-glare finish. Symbols of accessibility shall contrast with their backgrounds, with either a light symbol on a dark background or a dark symbol on a light background.

E-20.6.3 International Symbol of Accessibility. The International Symbol of Accessibility shall comply with Fig. E-20.6.3.

E-20.7 Variable Message Signs

E-20.7.1 General. Where provided, variable message signs shall have high resolution variable message sign (VMS) characters with a vertical pixel count of 16 rows or greater and shall comply with Clause E-20.7.

E-20.7.2 Protective Covering. Where a protective layer is placed over VMS characters through which the VMS characters must be viewed, the protective covering shall have a non-glare finish.

E-20.7.3 Rate of Change. Where a VMS message can be displayed in its entirety on a single screen, it shall be displayed on a single screen and shall remain motionless on the screen for a minimum of 3 sec, or 1 sec minimum for every 7 characters of the message including spaces, whichever is longer.

NONMANDATORY APPENDIX F ASCENDING CAR OVERSPEED AND UNINTENDED CAR MOVEMENT PROTECTION

See Table F-1 on the following page.

Table F-1 Traction Elevator Brake Type, Function, and Performance

| Brake Type | Location | Normal Operation Function | Emergency Operation Function | Performance (Minimum Required) | |
|--|---|--|---|---|--|
| | | | | Normal | Emergency |
| Driving-machine brake (see 1.3 and 2.24.8.3) | Electric driving machine (see 1.3 and 2.24.8.1) | To hold car stationary at floor [Note (1)] [see 2.24.8.3(a) and (b), and 2.26.8] | Retard car during emergency stops [see 2.24.8.3(c), 2.26.8.3(c) and (d)] | Hold 125% rated load [Note (2)] [see 2.24.8.3(a)] | Retard empty car in up direction [see 2.24.8.3(c)] |
| Braking system (see 1.3 and 2.24.8.2) | Not specified | Note (1) (see 2.26.8) | Retard car during emergency stops, [see 2.24.8.2 and 2.26.8.3(c) and (d)] | Note (1) | Retard 125% rated load car in down direction [see 2.24.8.2 and 2.16.8] [Note (2)] |
| Emergency brake (see 1.3 and 2.19.3) | Electric driving machine, hoist ropes, compensation ropes, car, or counterweight (see 2.19.3.2) | Not permitted [see 2.19.3.2(c)] | Retard car during ascending car overspeed, unintended movement, and emergency terminal speed limiting, independently of the braking system [see 2.19.1.2(b), 2.19.2.2(b), and 2.25.4.1.1] | Not applicable [see 2.19.3.2(c)] | Retard empty car in the up direction [see 2.19.3.2(a)] up to 110% of governor tripping speed [see 2.19.1.2(a)] Stop unintended motion: 125% rated load down or empty car up [see 2.19.2.2(b) and Note (2)] Reduce the car and counterweight speed such that the rated buffer striking speed is not exceeded (rated load down or empty car up) [see 2.25.4.1.1] |

GENERAL NOTE: See 1.3, 2.19, and 2.24.8.

NOTES:

- (1) It is permitted that the braking system, or the driving machine brake function in normal retardation of the elevator car.
- (2) For freight elevators not authorized to carry passengers, 100% rated load (see 2.16.8).

Fig. F-1 Ascending Car Overspeed Protection (2.19.1)

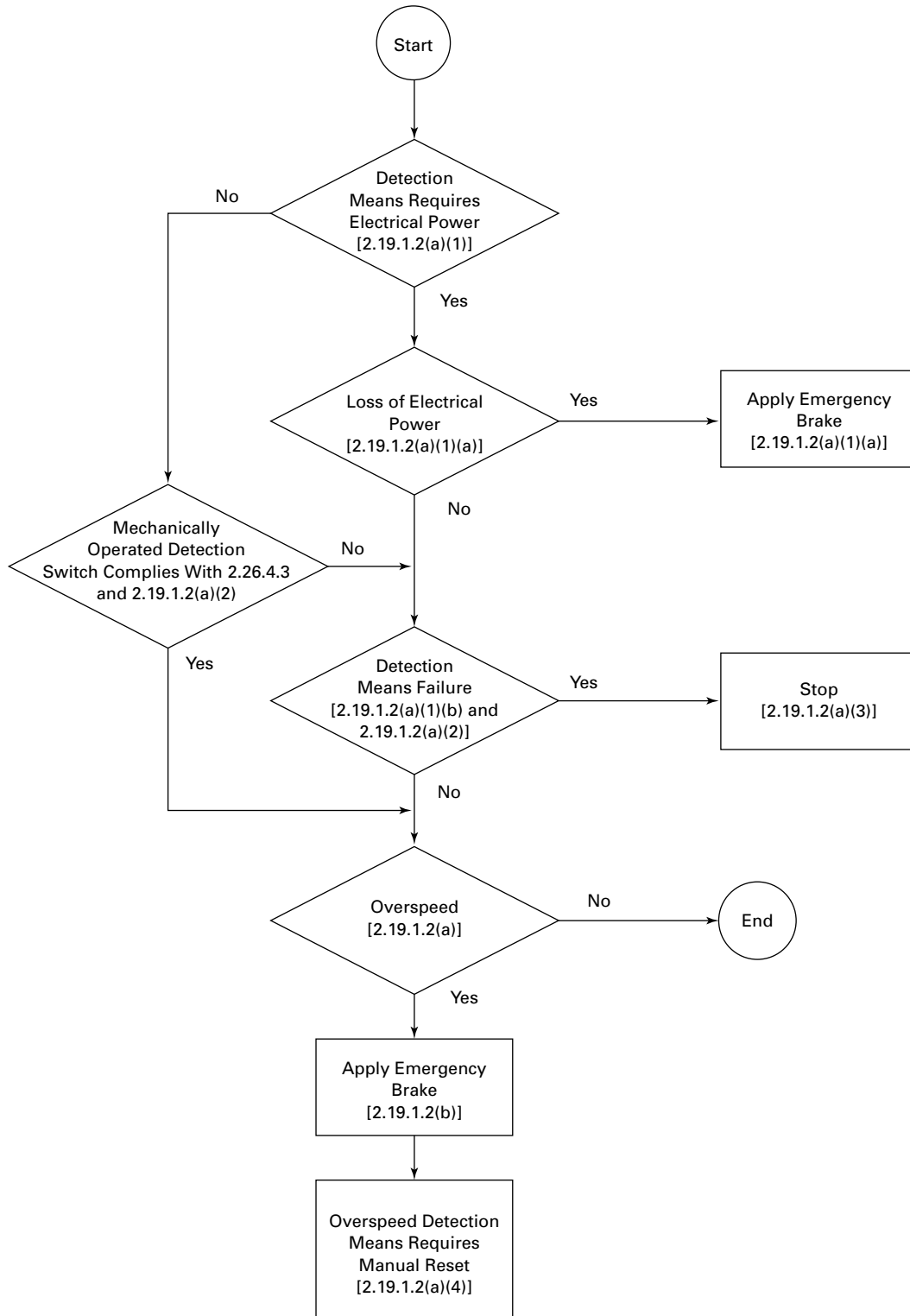
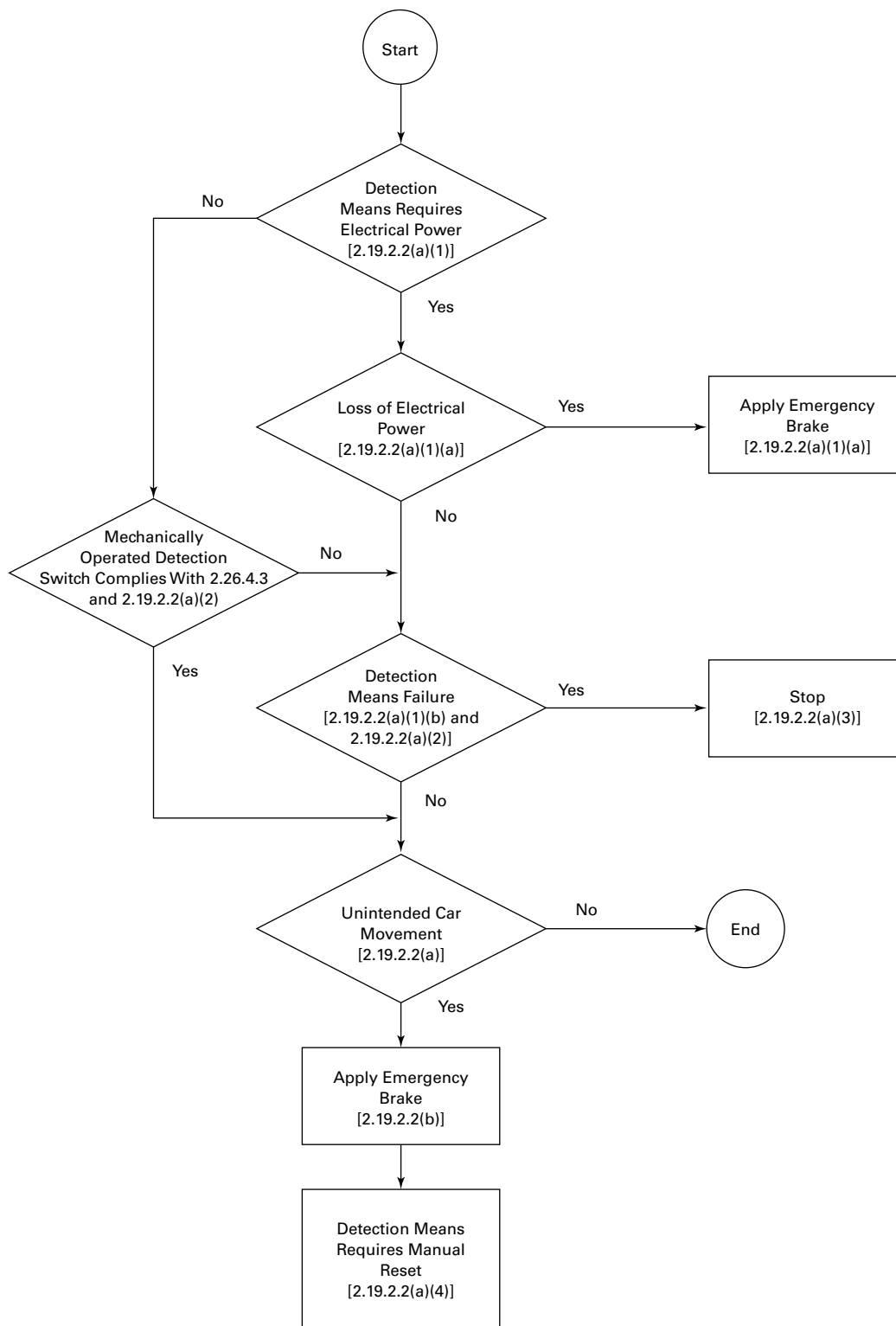

Fig. F-2 Unintended Car Movement Protection (2.19.2)



NONMANDATORY APPENDIX G

TOP OF CAR CLEARANCE

Fig. G-1 Top of Car Clearance Requirements (2.4.7.1)

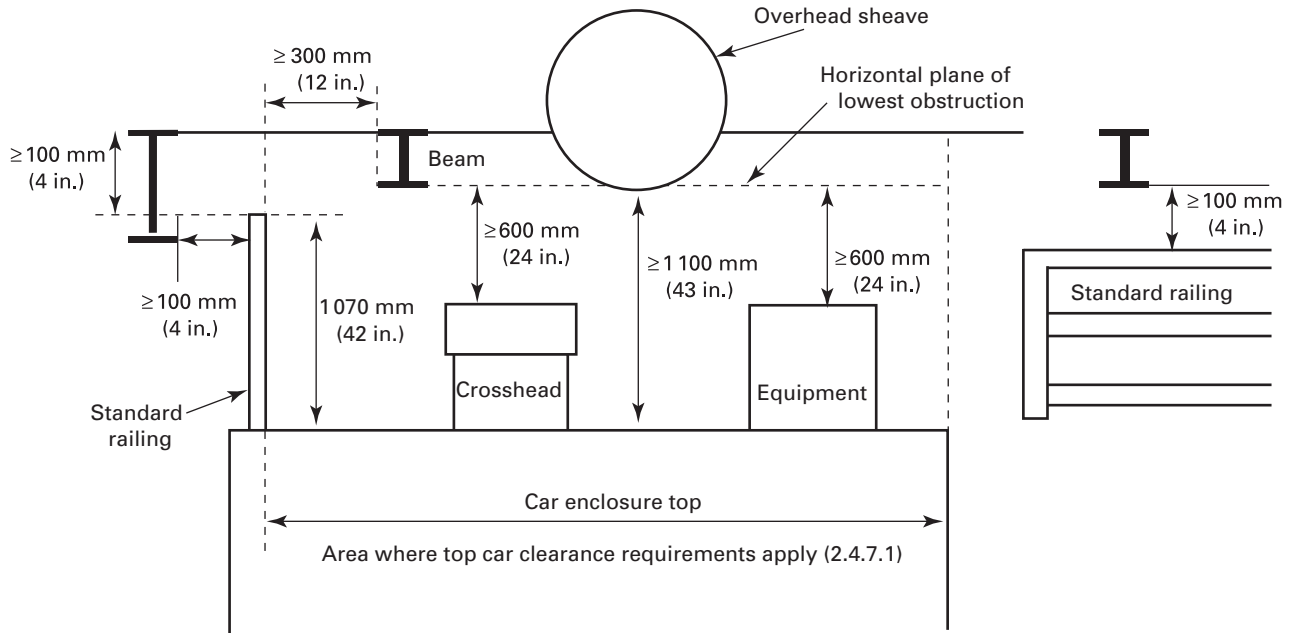

Fig. G-2 Additional Top of Car Clearance Requirements (2.4.7.1)

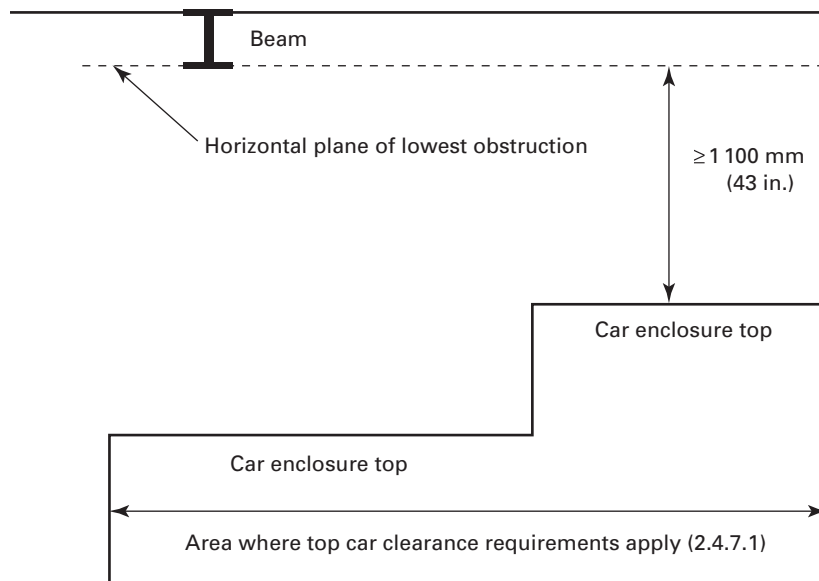

Fig. G-3 Top of Car Marking Requirements (2.4.7.2)

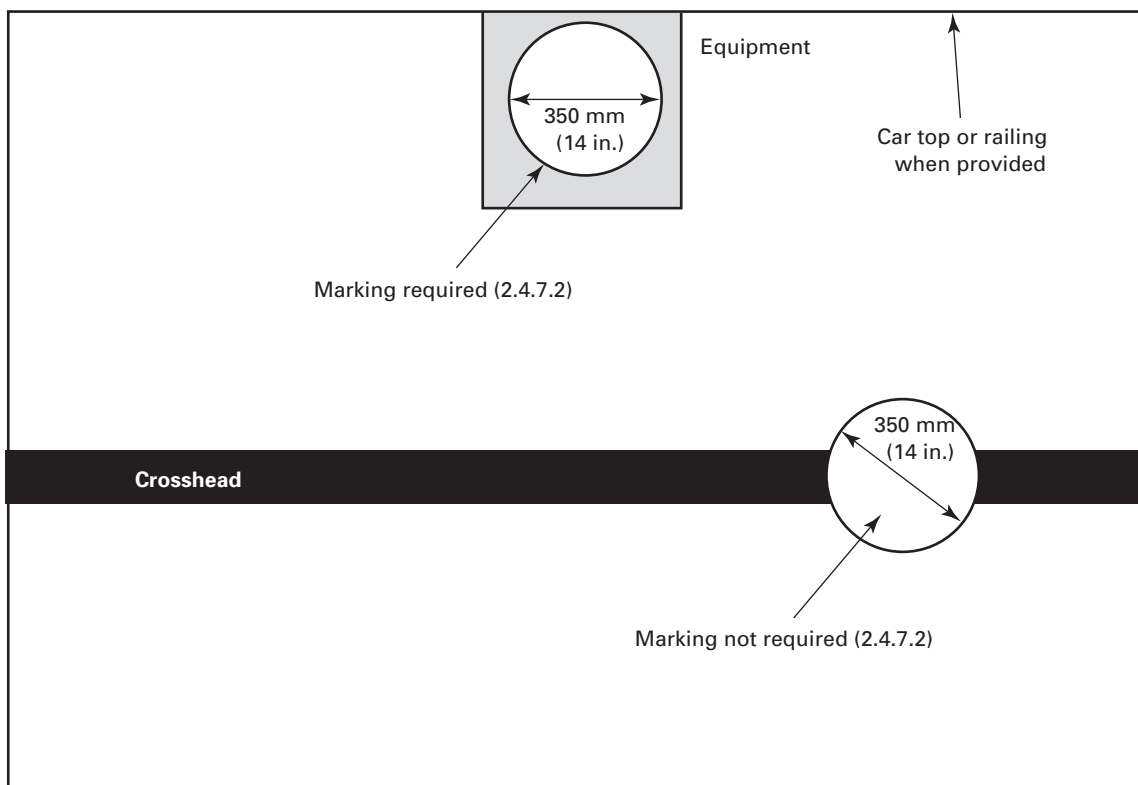

Fig. G-4 Additional Top of Car Marking Requirements (2.4.7.2)

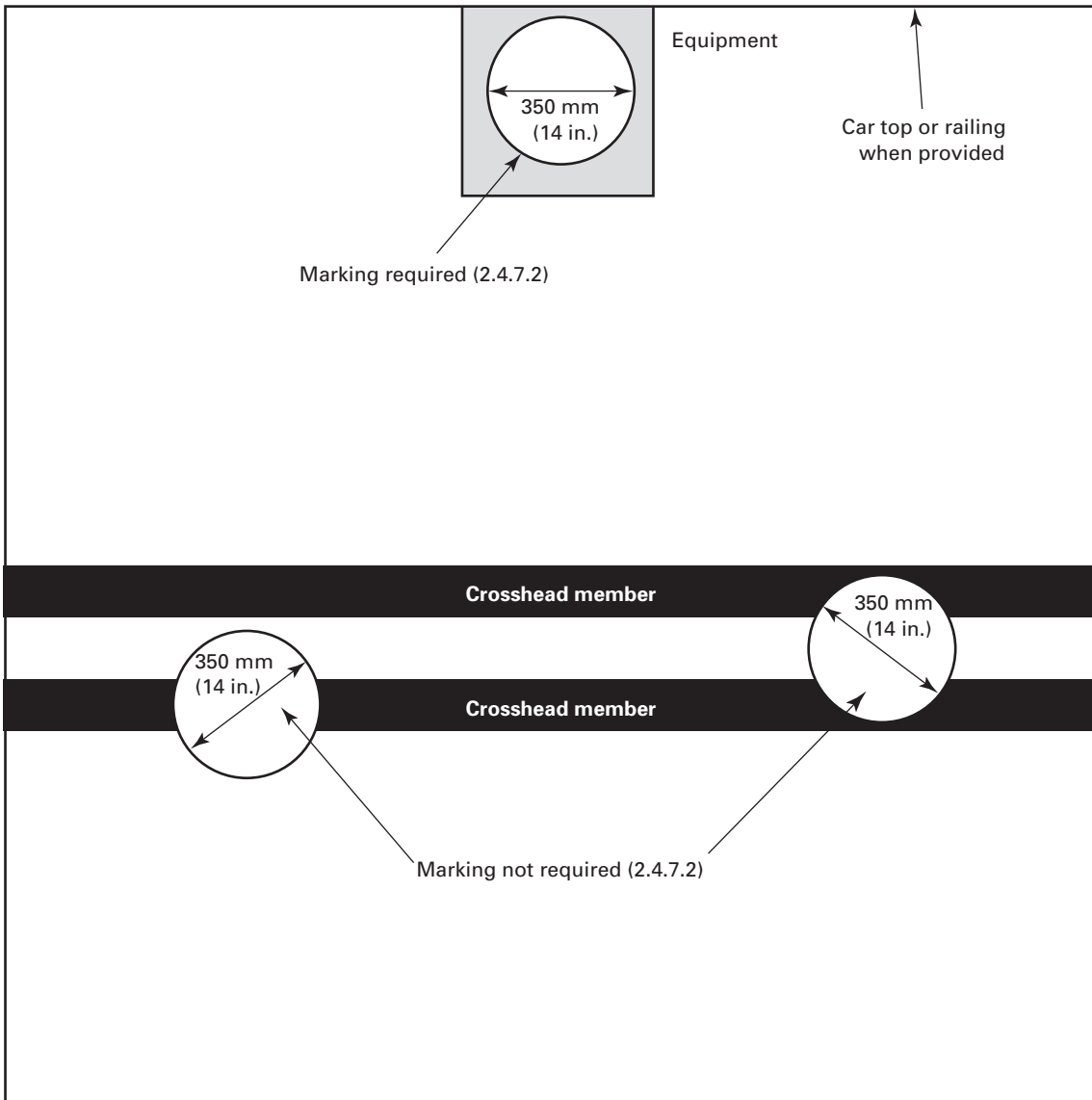

Fig. G-5 Additional Top of Car Clearance Requirements

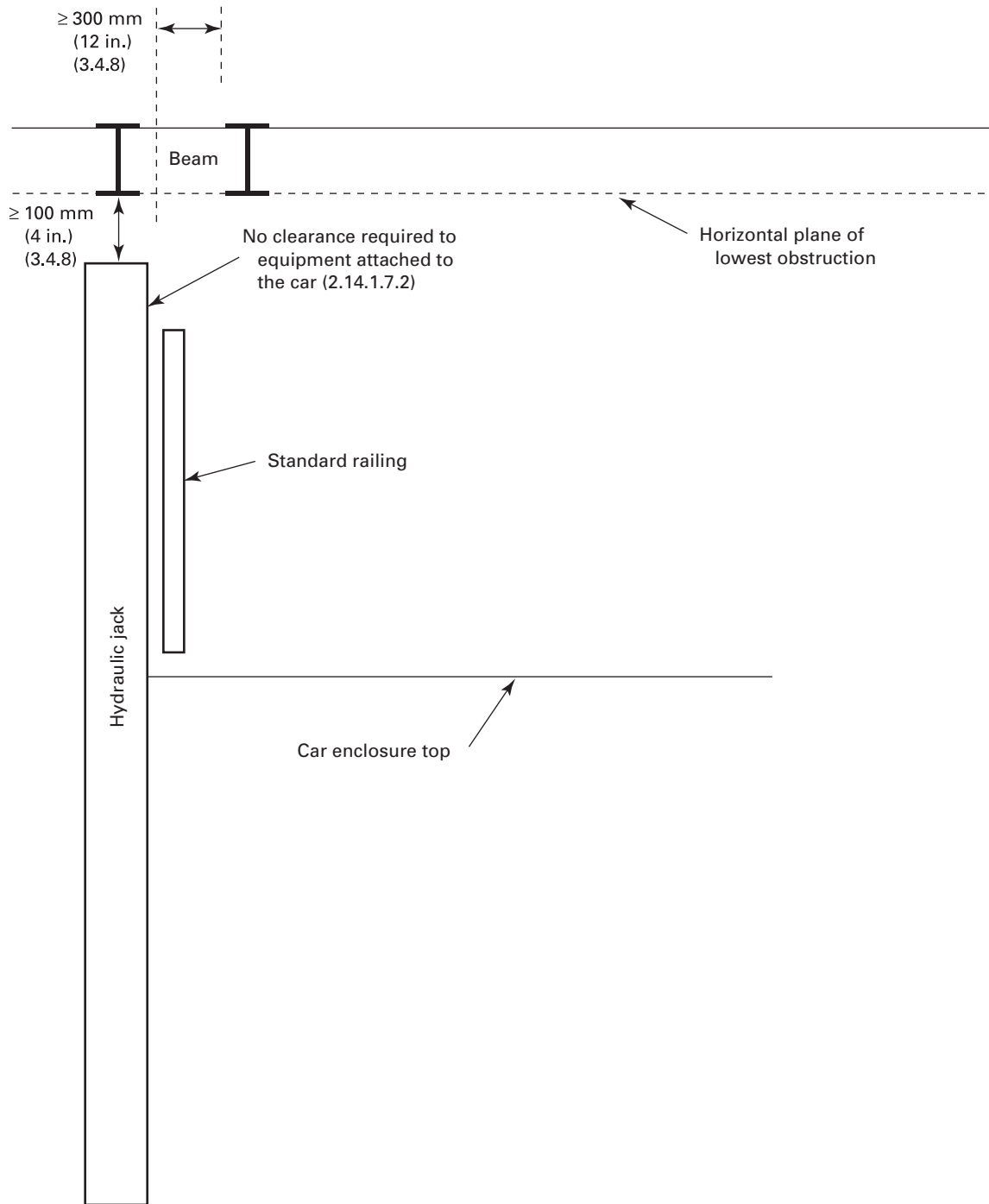
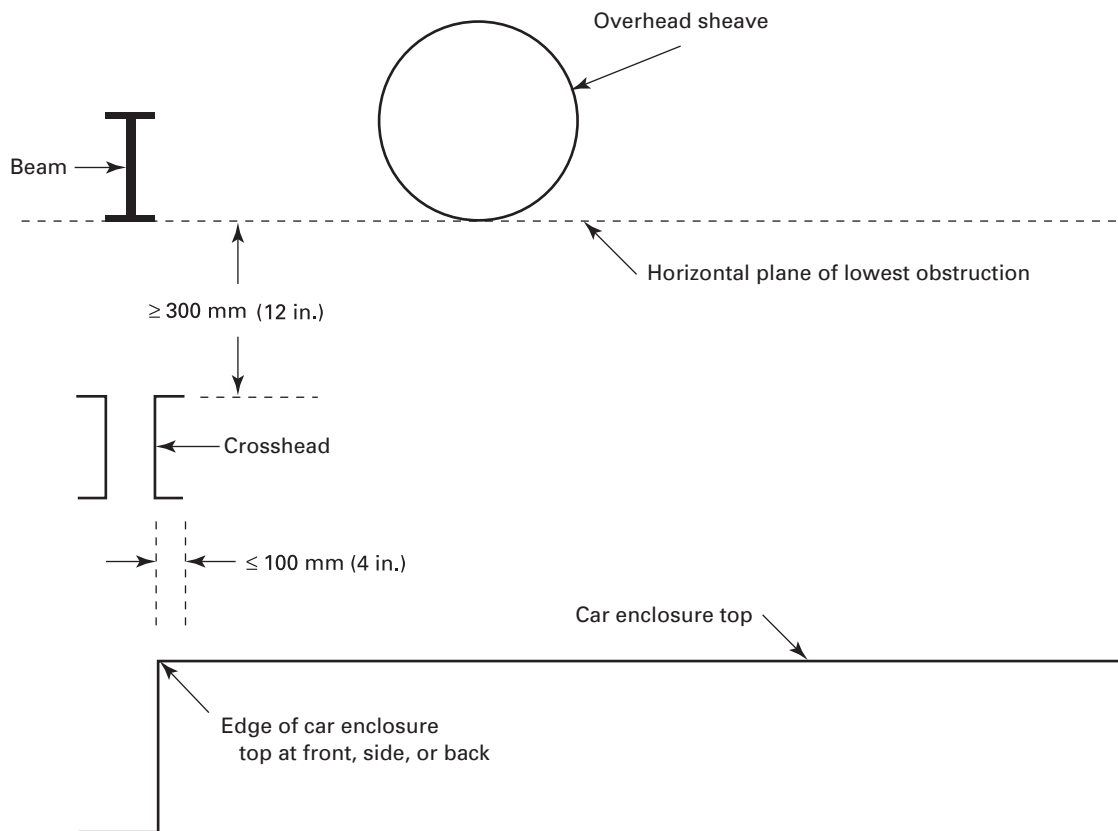

Fig. G-6 Additional Top of Car Clearance [2.4.7.1(b)]



NONMANDATORY APPENDIX H

PRIVATE RESIDENCE ELEVATOR GUARDING

(5.3.1.6.2)

Fig. H-1

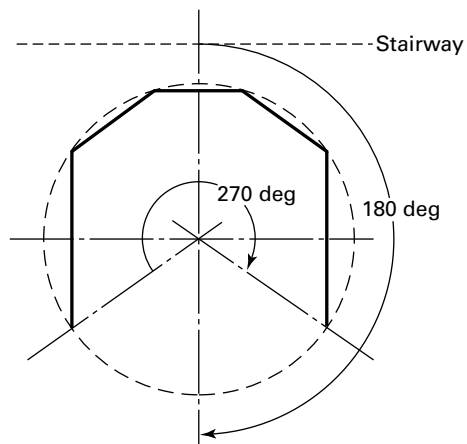

NONMANDATORY APPENDIX I ESCALATOR AND MOVING WALK DIAGRAMS

Fig. I-1 Relationship of Escalator Parts

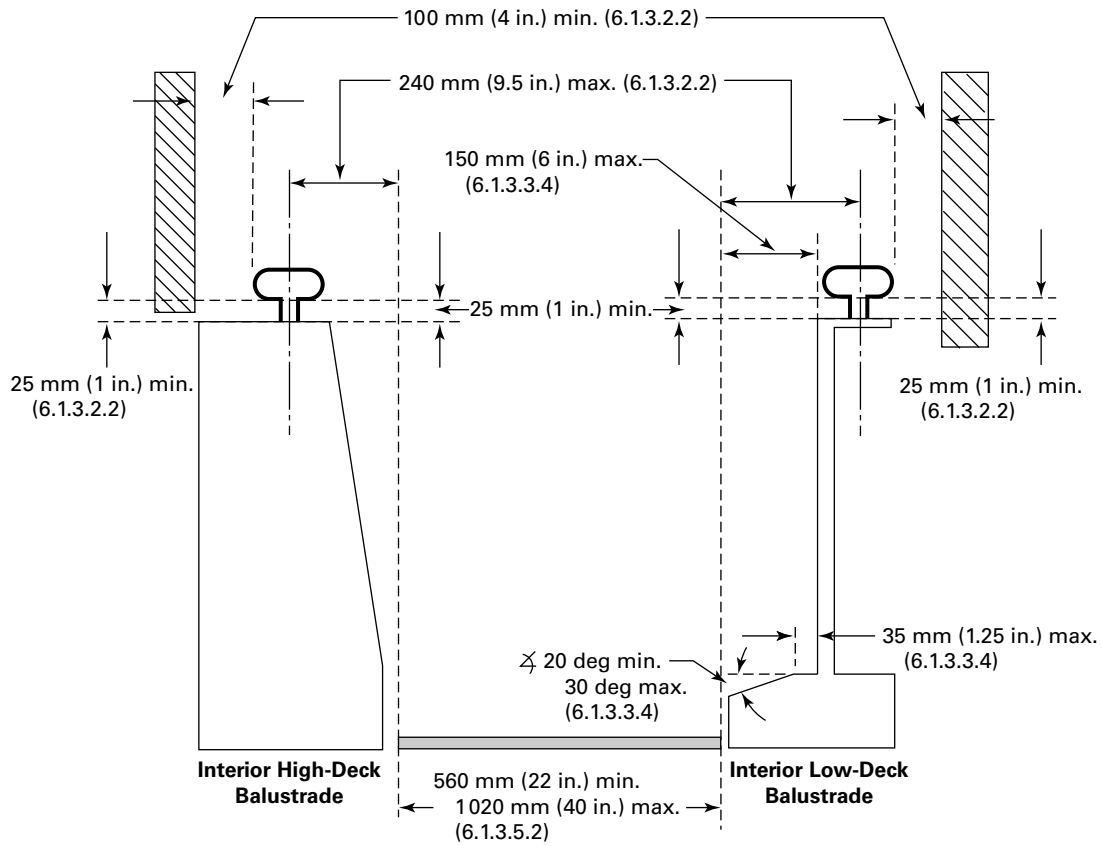

Fig. I-2 Handrail

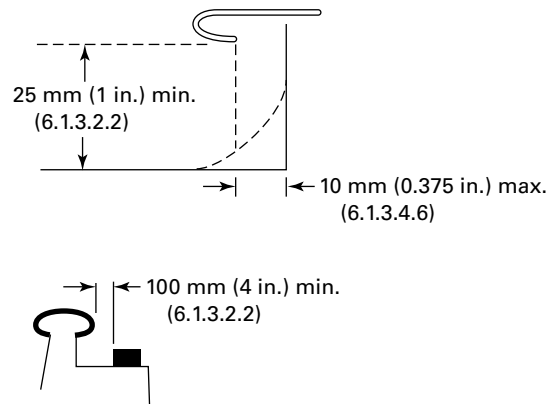
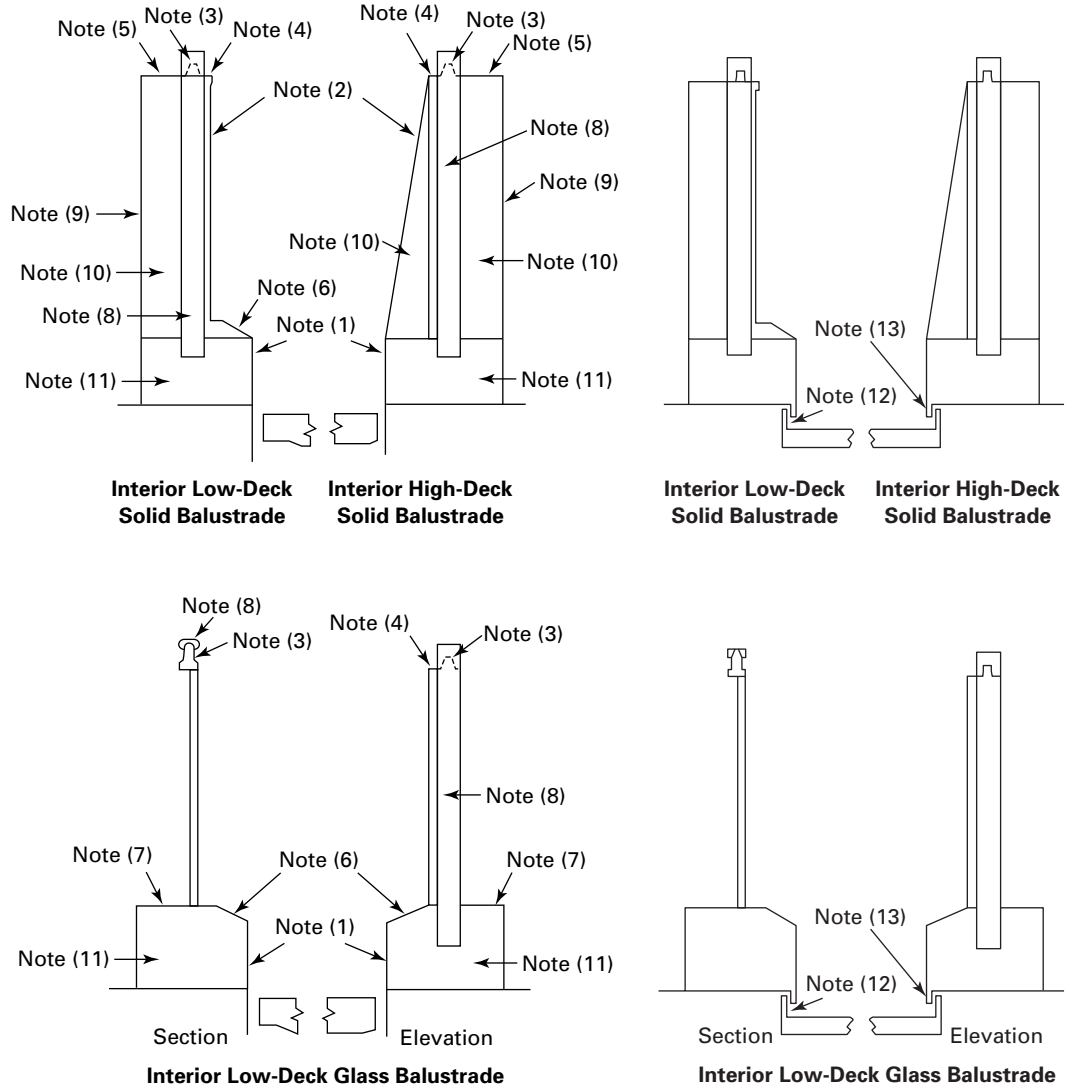

Fig. I-3 Escalator Nomenclature



NOTES:

- (1) Skirt panel.
- (2) Interior panel.
- (3) Handrail stand.
- (4) High-deck interior.
- (5) High-deck exterior.
- (6) Low-deck interior.
- (7) Low-deck exterior.
- (8) Handrail.
- (9) Exterior panel.
- (10) Newel.
- (11) Newel base.
- (12) Dynamic skirt panel.
- (13) Dynamic skirt panel cover.

**Fig. I-4 Skirt or Dynamic Skirt Panel: Step Nose
(6.1.3.3.6)**

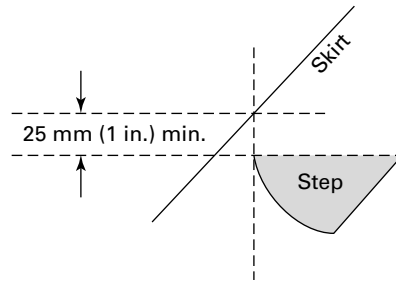

**Fig. I-5 Ceiling or Soffit Guard
(6.1.3.3.11)**

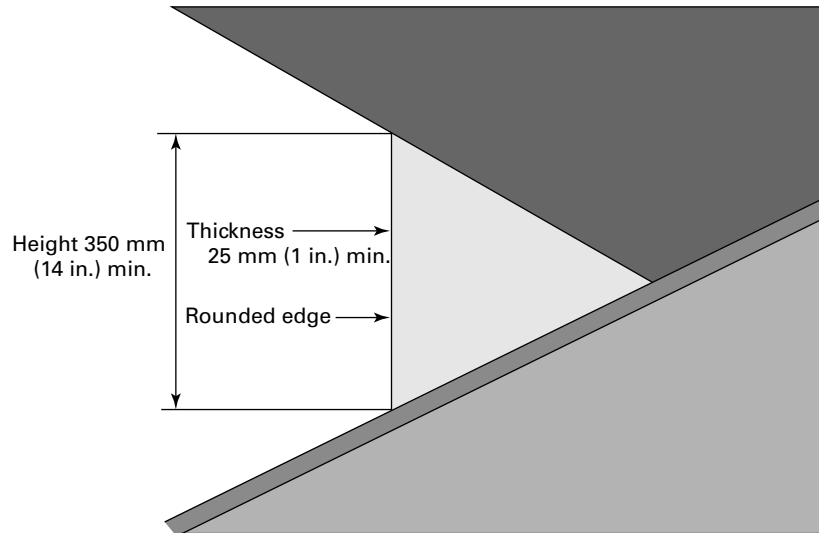

**Fig. I-6 Antislip Device
(6.1.3.3.12)**

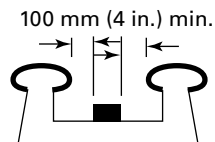

Fig. I-7 Escalator Step Tread

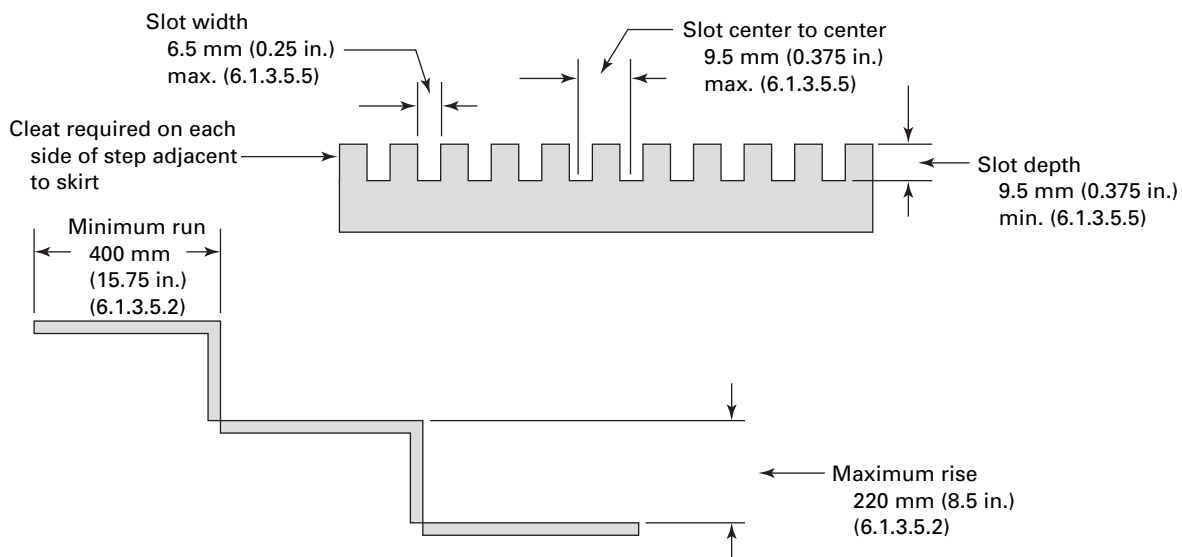

Fig. I-8 Cleated Riser (6.1.3.5.3)

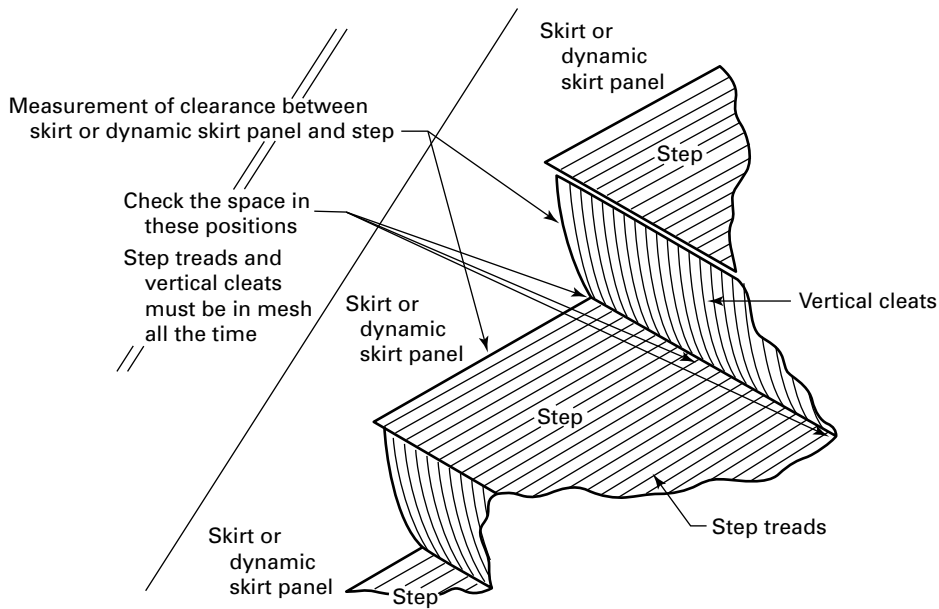

Fig. I-9 Moving Walk Geometry

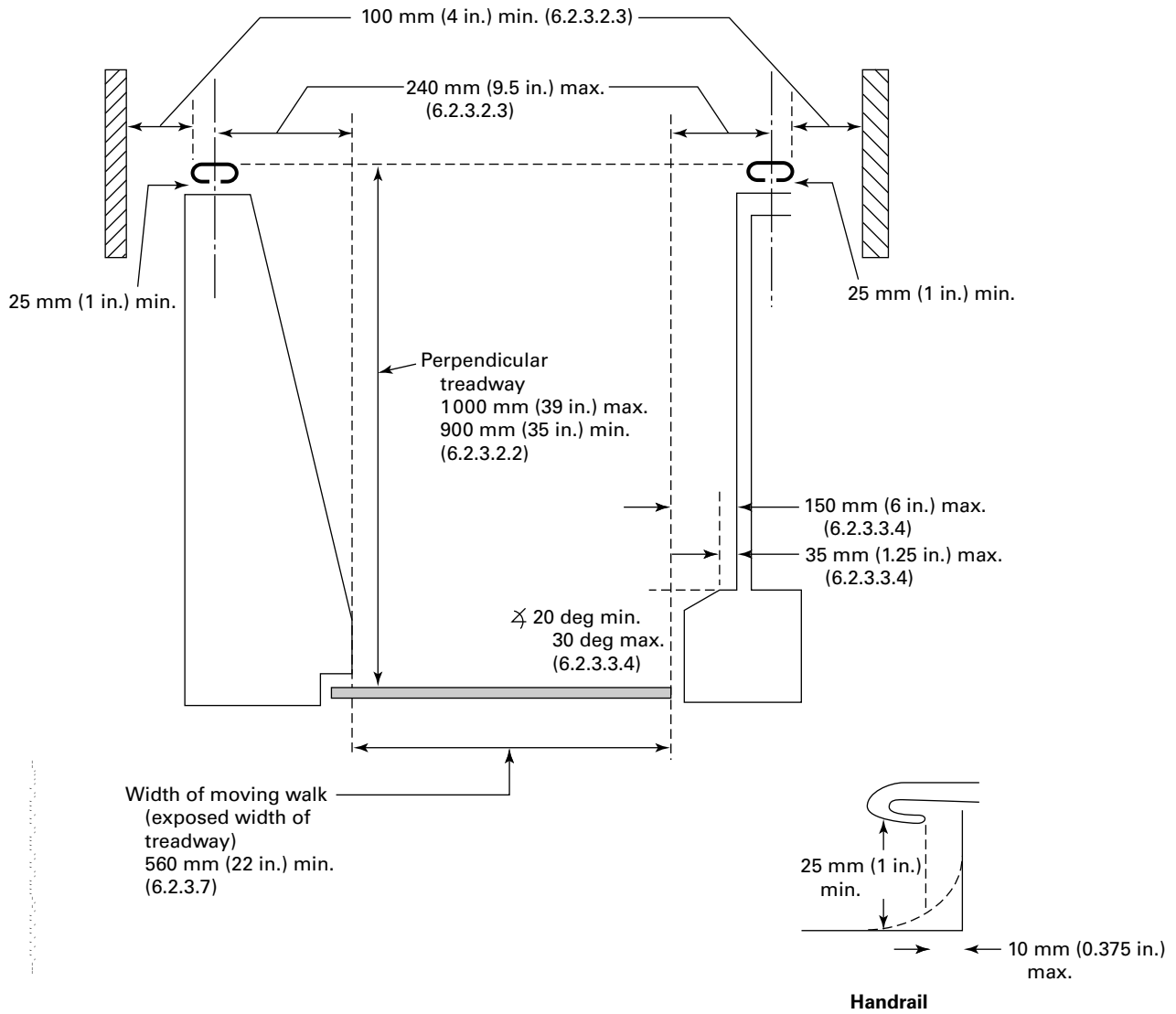

Fig. I-10 Moving Walk Treadway Slots

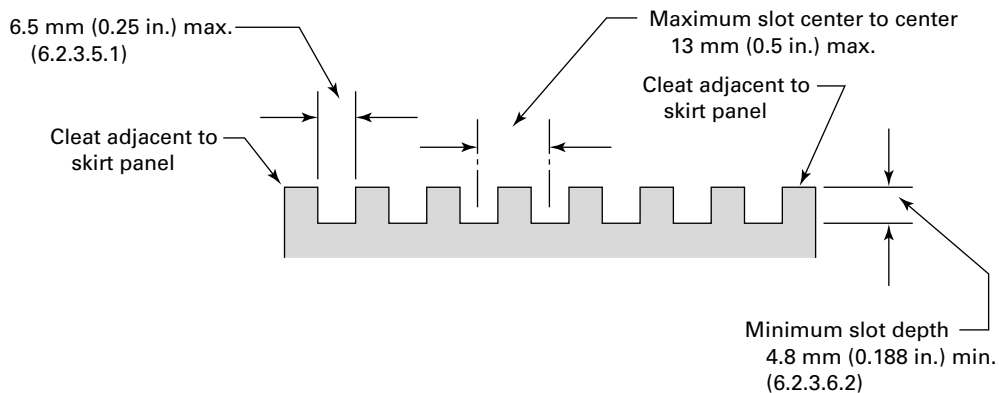
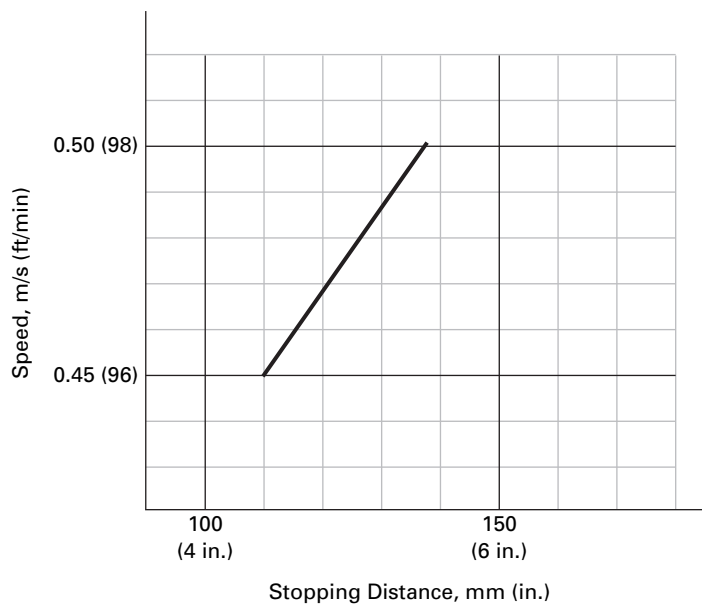
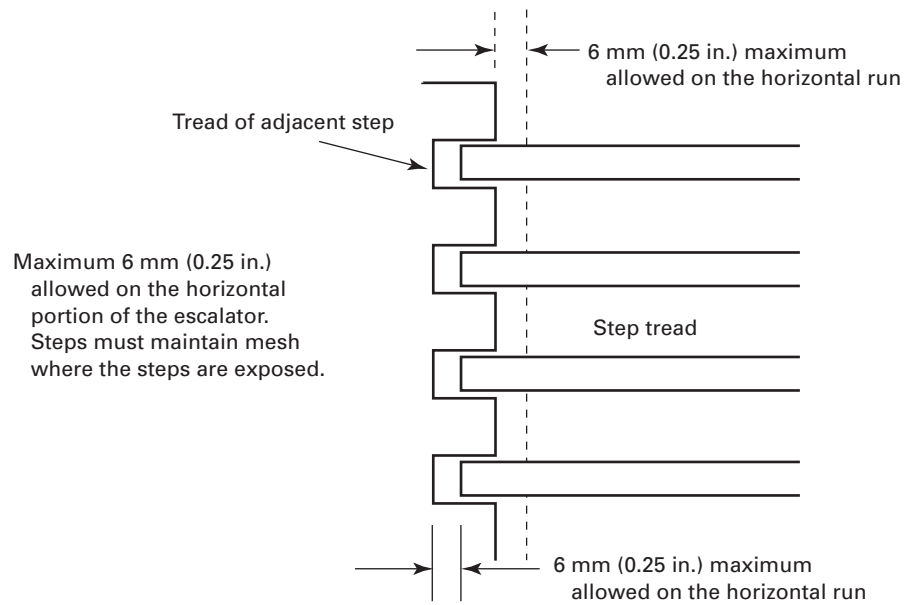

Fig. I-11 Stopping Distances Corresponding to a Deceleration Rate of 0.91 m/s^2 [6.1.5.3.1(c)]



GENERAL NOTE: The above represents the stopping distance of an escalator under a constant deceleration of 0.91 m/s^2 (3 ft/sec^2) and does not represent the total stopping distance of the escalator when it is stopped under no load.

Fig. I-12 Clearance Between Escalator Steps



NONMANDATORY APPENDIX J RELATIONSHIP OF PIT LADDER TO HOISTWAY DOOR UNLOCKING MEANS

Fig. J-1

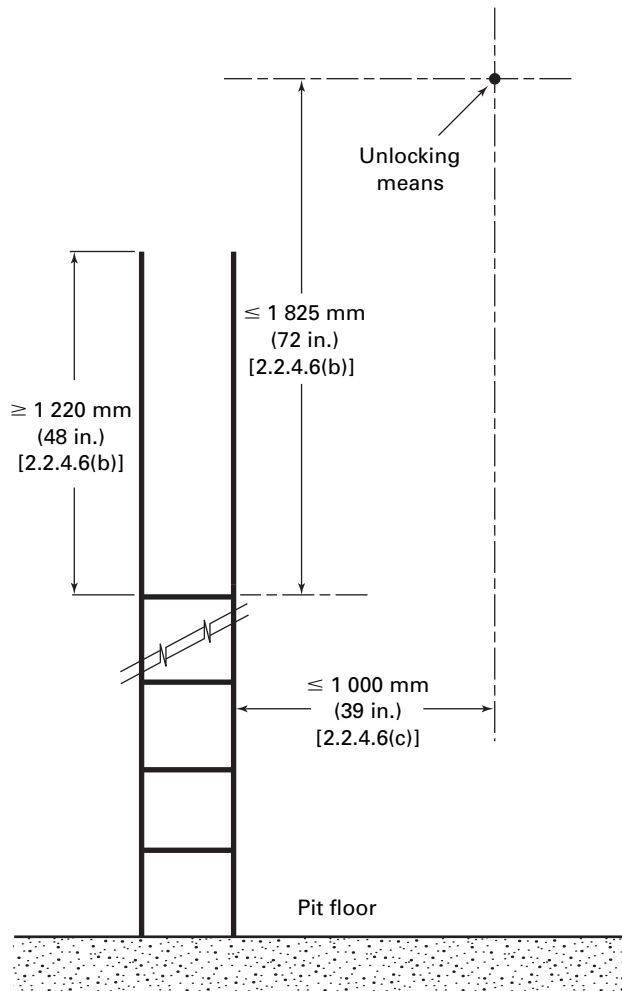

NONMANDATORY APPENDIX K BEVELING AND CLEARANCE REQUIREMENTS (7.4.7.4)

Fig. K-1

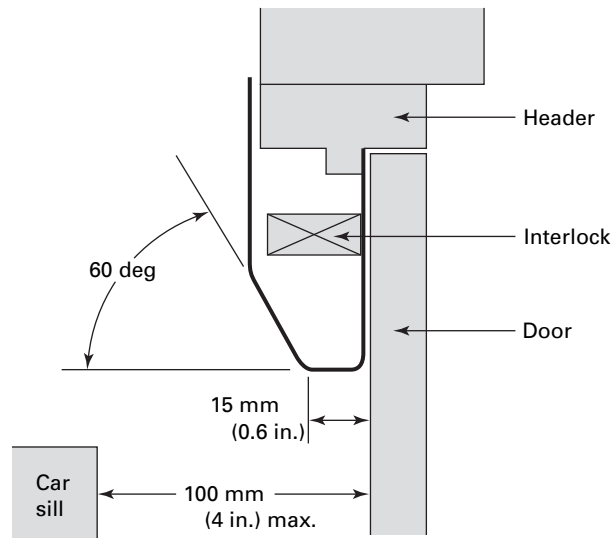

NONMANDATORY APPENDIX L

INDEX OF ALTERATION REQUIREMENTS FOR ELECTRIC ELEVATORS, HYDRAULIC ELEVATORS, ESCALATORS, AND MOVING WALKS

| Item | Electric Elevators | Hydraulic Elevators | Escalators and Moving Walks |
|---|-----------------------|------------------------|--------------------------------|
| Access doors and openings | 8.7.2.7.3 | 8.7.2.7.3 | 8.7.6.1.14, 8.7.6.2.14 |
| Access, means | 8.7.2.7.3 | 8.7.2.7.2 | ... |
| Access switch | 8.7.2.11.4 | 8.7.3.11 | ... |
| Access to machine room and spaces | 8.7.2.7.2, 8.7.2.7.3 | 8.7.2.7.2, 8.7.2.7.3 | ... |
| Addition of elevator to existing hoistway | 8.7.2.1.2 | 8.7.2.1.2 | ... |
| Alteration requirements | 8.7.1.1 | 8.7.1.1 | 8.7.1.1 |
| Alternating current, change to direct | 8.7.2.27.3 | 8.7.3.31.4 | ... |
| Anti-creep leveling device | ... | 8.7.3.31.3 | ... |
| Ascending car overspeed and unintended movement | 8.7.2.20 | ... | ... |
| Automatic stop valve | ... | 8.7.3.24 | ... |
| Automatic transfer device | 8.7.7.2 | 8.7.7.2 | ... |
| Auxiliary power lowering operation | ... | 8.7.3.31.9 | ... |
| Balustrades | ... | ... | 8.7.6.1.5(c), 8.7.6.2.5(c) |
| Beam, machinery and sheave | 8.7.2.9 | 8.7.3.9 | ... |
| Brake | 8.7.2.25.1 | ... | ... |
| Buffer | 8.7.2.23 | 8.7.3.27 | ... |
| Building structure | 8.7.2.9 | 8.7.3.9 | ... |
| Bumper | 8.7.2.23 | 8.7.3.27 | ... |
| Cable (rope) | 8.7.2.21 | 8.7.3.25 | ... |
| Capacity | 8.7.2.16 | ... | ... |
| Car, decrease or increase in dead weight of | 8.7.2.15.2 | 8.7.3.21 | ... |
| Car door or gate | 8.7.2.14 | 8.7.3.13 | ... |
| Car enclosure | 8.7.2.14, 8.7.2.27.7 | 8.7.3.13 | ... |
| Car frame | 8.7.2.15.1 | 8.7.3.14 | ... |
| Car leveling device | 8.7.2.27.2 | 8.7.3.31.2 | ... |
| Car platform | 8.7.2.15.1 | 8.7.3.14 | ... |
| Car safeties | 8.7.2.18 | 8.7.3.15 | ... |
| Check valve | ... | 8.7.3.24 | ... |
| Class of freight loading, change of | 8.7.2.16.2 | 8.7.3.18 | ... |
| Clearance, after reroping | 8.7.1.7 | 8.7.1.7 | ... |
| Clearance, bottom and top | 8.7.2.4 | 8.7.3.4 | ... |
| Clearance, horizontal | 8.7.2.5 | 8.7.3.5 | ... |
| Combplates | ... | ... | 8.7.6.1.8, 8.7.6.2.8 |
| Construction at bottom of hoistway | 8.7.2.1.4 | 8.7.2.1.4 | ... |
| Construction at top of hoistway | 8.7.2.1.3 | 8.7.2.1.3 | ... |
| Construction requirements (escalators and moving walks) | ... | ... | 8.7.6.1.5, 8.7.6.2.5 |
| Contact, mechanical lock and | 8.7.2.11.2 | 8.7.3.11 | ... |
| Control, change in type of motion | 8.7.2.27.5 | 8.7.3.31.6 | ... |
| Control, change in type of operation | 8.7.2.27.6 | 8.7.3.31.7 | ... |
| Control equipment | 8.7.2.27 | 8.7.3.31 | ... |
| Control of smoke and hot gas | 8.7.2.1.5 | 8.7.2.1.5 | ... |
| Control valve | ... | 8.7.3.24 | ... |
| Controller | 8.7.2.27.4 | 8.7.3.31.5 | ... |
| Counterweight | 8.7.2.22 | 8.7.3.26 | ... |

| Item | Electric Elevators | Hydraulic Elevators | Escalators and Moving Walks |
|---|----------------------|---------------------|-----------------------------|
| Counterweight, location and guarding of | 8.7.2.3 | 8.7.3.3 | |
| Counterweight, rod type | 8.7.2.22.2 | ... | ... |
| Counterweight safeties | 8.7.2.18 | 8.7.3.15 | ... |
| Cylinder | ... | 8.7.3.23.3 | ... |
| Data plate, code | 8.7.1.8 | 8.7.1.8 | 8.7.1.8 |
| Dead weight of car, increase or decrease in | 8.7.2.15.2 | 8.7.3.21 | ... |
| Decrease in travel | 8.7.2.17.1 | 8.7.3.22.1 | ... |
| Design | 8.7.1.5 | 8.7.1.5 | 8.7.1.5 |
| Direct current, change to alternating | 8.7.2.27.3 | 8.7.3.31.4 | ... |
| Door, car | 8.7.2.14 | 8.7.3.13 | ... |
| Door, hoistway | 8.7.2.10.1 | 8.7.3.10 | ... |
| Door, machine room | 8.7.2.7.3 | 8.7.2.7.3 | ... |
| Door, power operation of | 8.7.2.12 | 8.7.3.12 | ... |
| Doors, Reopening Device | 8.7.2.13 | 8.7.2.13 | ... |
| Doors, restricted opening | 8.7.2.11.5 | 8.7.2.11.5 | ... |
| Driving machine | 8.7.2.25.1 | 8.7.3.23 | ... |
| Driving machine, change in location of | 8.7.2.25.2 | 8.7.3.23.4 | ... |
| Duct in hoistway or machine room | 8.7.2.8 | 8.7.3.8 | ... |
| Dumbwaiter, addition of automatic transfer device | 8.7.7.2 | 8.7.7.2 | ... |
| Dumbwaiters without automatic transfer devices | 8.7.7 | 8.7.7 | ... |
| Egress, escalator | ... | 8.7.6.1.15 | ... |
| Electric contact, mechanical lock and | 8.7.2.11.2 | 8.7.3.11 | ... |
| Electric wiring | 8.7.2.8 | 8.7.3.8 | 8.7.6.1.14, 8.7.6.2.14 |
| Electrically operated control valve | ... | 8.7.3.24 | ... |
| Emergency door | 8.7.2.10.1 | 8.7.2.10.1 | ... |
| Emergency operation | 8.7.2.28 | 8.7.3.31.8 | ... |
| Emergency signaling device | 8.7.2.28 | 8.7.3.31.8 | ... |
| Enclosure, car | 8.7.2.14, 8.7.2.27.7 | 8.7.3.13 | ... |
| Enclosure, hoistway | 8.7.2.1 | 8.7.3.1 | ... |
| Enclosure, machine room and machinery spaces | 8.7.2.7 | 8.7.2.7 | 6.1.7, 6.2.7 |
| Entrance, escalator and moving walk | ... | ... | 8.7.6.1.15 |
| Entrance, hoistway | 8.7.2.10 | 8.7.3.10 | ... |
| Entrance, horizontal slide type | 8.7.2.10.2 | 8.7.2.10.2 | ... |
| Entrance, swing type | 8.7.2.10.4 | 8.7.2.10.4 | ... |
| Entrance, vertical slide type | 8.7.2.10.3 | 8.7.2.10.3 | ... |
| Entrance assembly, marking of | 8.7.2.10.5 | 8.7.2.10.5 | ... |
| Equipment, non elevator | 8.7.2.8 | 8.7.2.8 | ... |
| Fastening, suspension rope | 8.7.2.21 | 8.7.3.25 | ... |
| Final terminal stopping device | 8.7.2.26 | 8.7.2.26 | ... |
| Firefighters' service | 8.7.2.28 | 8.7.3.31.6 | ... |
| Fitting, hydraulic | ... | 8.7.3.24 | ... |
| Foundation | 8.7.2.9 | 8.7.3.8 | ... |
| Frame, car | 8.7.2.15.1 | 8.7.3.14 | ... |
| Freight elevator, change in class of loading | 8.7.2.16.2 | 8.7.3.18 | ... |
| Freight elevator changed to passenger service | 8.7.2.16.1 | 8.7.3.17 | ... |
| Freight elevator permitted to carry passengers | 8.7.2.16.3 | 8.7.3.19 | ... |
| Frequency, change in | 8.7.2.27.3 | 8.7.3.31.4 | ... |
| Gate, car | 8.7.2.14 | 8.7.3.13 | ... |
| General requirements | 8.7.1 | 8.7.1 | 8.7.6.1.1, 8.7.6.2.1 |
| Geometry | ... | ... | 8.7.6.1.5(b), 8.7.6.2.5(b) |
| Governor | 8.7.2.19 | 8.7.3.16 | ... |
| Governor rope | 8.7.2.19 | 8.7.3.16 | ... |
| Guide rail | 8.7.2.24 | 8.7.3.28 | ... |
| Guide shoe, car | 8.7.2.15.1 | 8.7.3.14 | ... |
| Guide shoe, counterweight | 8.7.2.22 | 8.7.3.26 | ... |

| Item | Electric Elevators | Hydraulic Elevators | Escalators and Moving Walks |
|---|--------------------|---------------------|-----------------------------|
| Hand elevators | ... | 8.7.4.3 | ... |
| Handrails (escalators and moving walks) | ... | ... | 8.7.6.1.6, 8.7.6.2.6 |
| Headroom, machine room | 8.7.2.7.4 | 8.7.2.7.4 | ... |
| Hoistway, addition of elevator to | 8.7.2.1.2 | 8.7.2.1.2 | ... |
| Hoistway, construction at bottom of | 8.7.2.1.4 | 8.7.2.1.4 | ... |
| Hoistway, construction at top of | 8.7.2.1.3 | 8.7.2.1.3 | ... |
| Hoistway, protection of space below | 8.7.2.6 | 8.7.3.6 | ... |
| Hoistway door, power operation of | 8.7.2.12 | 8.7.3.12 | ... |
| Hoistway door interlocks | 8.7.2.11.1 | 8.7.3.11 | ... |
| Hoistway door locking device | 8.7.2.11 | 8.7.3.11 | ... |
| Hoistway door unlocking device | 8.7.2.11.4 | 8.7.3.11 | ... |
| Hoistway enclosure | 8.7.2.1 | 8.7.3.1 | ... |
| Hoistway entrance | 8.7.2.10 | 8.7.3.10 | ... |
| Horizontal slide type entrance | 8.7.2.10.2 | 8.7.2.10.2 | ... |
| Illumination in car | 8.7.2.14 | 8.7.3.13 | ... |
| Inclined elevators | 8.7.5.1 | 8.7.5.1 | ... |
| Inclination, angle of | ... | ... | 8.7.6.1.5(a), 8.7.6.2.5(a) |
| Increase in dead weight of car | 8.7.2.15.2 | 8.7.3.21 | ... |
| Increase in rated load | 8.7.2.16.4 | 8.7.3.20 | ... |
| Increase in rated speed | 8.7.2.17.2 | 8.7.3.22.2 | ... |
| Increase in travel | 8.7.2.17.1 | 8.7.3.22.1 | ... |
| Increase in working pressure | ... | 8.7.3.23.4 | ... |
| Inspection | 8.7.1.3 | 8.7.1.3 | ... |
| Interlock | 8.7.2.11.1 | 8.7.3.11 | ... |
| Jack, hydraulic | ... | 8.7.3.23 | ... |
| Labeling of entrance assembly | 8.7.2.10.5 | 8.7.2.10.5 | ... |
| Leveling device | 8.7.2.27.2 | 8.7.3.31.2 | ... |
| Lighting in car | 8.7.2.14.2(f) | 8.7.3.13 | ... |
| Lighting of escalator and moving walk | ... | ... | 8.7.6.1.14, 8.7.6.2.14 |
| Lighting of machine room | 8.7.2.7.6 | 8.7.2.7.6 | ... |
| Load, increase in | 8.7.2.16.4 | 8.7.3.20 | ... |
| Loading, change in class of | 8.7.2.16.2 | 8.7.3.18 | ... |
| Location of driving machine, change of | 8.7.2.25.2 | 8.7.3.23.4 | ... |
| Location of hydraulic jack, change of | ... | 8.7.3.23.5 | ... |
| Location of hydraulic machine (power unit), change of | ... | 8.7.3.23.6 | ... |
| Lock and contact | 8.7.2.11.2 | 8.7.3.11 | ... |
| Locking device, hoistway door | 8.7.2.11 | 8.7.3.11 | ... |
| Machine room | 8.7.2.7 | 8.7.3.7 | ... |
| Machinery and equipment | 8.7.2 | 8.7.3 | 8.7.6.1.12, 8.7.6.2.12 |
| Machinery space | 8.7.2.7 | 8.7.3.7 | ... |
| Marking of entrance assembly | 8.7.2.10.5 | 8.7.2.10.5 | ... |
| Material lift with automatic transfer device | 8.7.7.3 | 8.7.7.3 | ... |
| Means of access to machine room | 8.7.2.7.2 | 8.7.2.7.2 | ... |
| Mechanical lock and electric contact | 8.7.2.11.2 | 8.7.3.11 | ... |
| Mechanically operated control valve | ... | 8.7.3.24 | ... |
| Motion control, change of | 8.7.2.27.5 | 8.7.3.31.6 | ... |
| Moving walks | ... | ... | 8.7.6.2 |
| Normal terminal stopping device | 8.7.2.26 | 8.7.3.30 | ... |
| Number of elevators per hoistway | 8.7.2.1.2 | 8.7.2.1.2 | ... |
| Oil buffer | 8.7.2.23 | 8.7.3.27 | ... |
| Operating device | 8.7.2.27 | 8.7.3.31 | ... |
| Operating device, top of car | 8.7.2.27.1 | 8.7.3.31.1 | ... |
| Operation control, change in type of | 8.7.2.27.6 | 8.7.3.31.7 | ... |

| Item | Electric Elevators | Hydraulic Elevators | Escalators and Moving Walks |
|---|--------------------|---------------------|-----------------------------|
| Parking device | 8.7.2.11.3 | 8.7.3.11 | ... |
| Passenger elevator changed to freight service | 8.7.2.16.1 | 8.7.3.17 | ... |
| Passengers, carrying of on freight elevators | 8.7.2.16.3 | 8.7.3.19 | ... |
| Phase I and II operation | 8.7.2.28 | 8.7.3.31.8 | ... |
| Phases, change in number of | 8.7.2.27.3 | 8.7.3.31.4 | ... |
| Pipe in hoistway or machine room | 8.7.2.8 | 8.7.3.8 | ... |
| Piping supply | ... | 8.7.3.24 | ... |
| Piston | ... | 8.7.3.23.2 | ... |
| Pit | 8.7.2.2 | 8.7.3.2 | ... |
| Platform, car | 8.7.2.15.1 | 8.7.3.14 | ... |
| Plunger | ... | 8.7.3.23.2 | ... |
| Power operation of hoistway door | 8.7.2.12 | 8.7.3.12 | ... |
| Power supply, change in | 8.7.2.27.3 | 8.7.3.31.4 | ... |
| Power unit (hydraulic machine) | ... | 8.7.3.23.6 | ... |
| Pressure tank | ... | 8.7.3.29 | ... |
| Pressure, working, increase of | ... | 8.7.3.23.4 | ... |
| Pressurization of hoistway | 8.7.2.1.5 | 8.7.3.1 | ... |
| Protection of floor openings | ... | ... | 8.7.6.1.3, 8.7.6.2.3 |
| Protection of space below hoistway | 8.7.2.6 | 8.7.3.6 | ... |
| Protection of truss and machinery spaces against fire | ... | ... | 8.7.6.1.4, 8.7.6.2.4 |
| Rack and pinion | 8.7.4.1 | ... | ... |
| Rated load, increase in | 8.7.2.16.4 | 8.7.3.20 | 8.7.6.1.11, 8.7.6.2.11 |
| Rated speed, decrease in | 8.7.2.17.3 | 8.7.3.22.3 | ... |
| Rated speed, increase in | 8.7.2.17.2 | 8.7.3.22.2 | ... |
| Relief valve | ... | 8.7.3.24 | ... |
| Relocation of escalator | ... | ... | 8.7.6.1.2 |
| Relocation of hydraulic machine | ... | 8.7.3.23.6 | ... |
| Relocation of moving walk | ... | ... | 8.7.6.2.2 |
| Repair | 8.7.1.7 | 8.7.1.7 | ... |
| Replacement | 8.7.1.7 | 8.7.1.7 | 8.7.1.7 |
| Reroping | 8.7.2.21.1 | 8.7.3.25 | ... |
| Restricted opening of doors | 8.7.2.11.5 | 8.7.2.11.5 | ... |
| Rise, increase or decrease in | 8.7.2.17.1 | 8.7.3.22.1 | ... |
| Roller guide shoe, counterweight | 8.7.2.22 | 8.7.2.22 | ... |
| Roof top elevators | 8.7.5.6 | 8.7.5.6 | ... |
| Rope, change in material, grade, number, or diameter | 8.7.2.21.1 | 8.7.3.25.1 | ... |
| Rope, governor | 8.7.2.19 | 8.7.3.16 | ... |
| Rope, replacement of | 8.7.1.7 | 8.7.1.7 | ... |
| Rope, splicing of | 8.7.1.7 | 8.7.1.7 | ... |
| Rope, suspension | 8.7.2.21.1 | 8.7.3.25 | ... |
| Rope equalizer | 8.7.2.21.3 | 8.7.3.25.2 | ... |
| Runby | 8.7.2.4 | 8.7.3.4 | ... |
| Runby, after reroping | 8.7.2.4 | 8.7.3.4 | ... |
| Safeties | 8.7.2.18 | 8.7.3.15 | ... |
| Safety devices | ... | ... | 8.7.6.1.13, 8.7.6.2.13 |
| Screw column elevators | 8.7.4.2 | ... | ... |
| Service, change in type of | 8.7.2.16.1 | 8.7.3.17 | ... |
| Sheave, driving machine | 8.7.2.25.1 | 8.7.2.25.1 | ... |
| Sheave, governor | 8.7.2.19 | 8.7.2.19 | ... |
| Sheave beam | 8.7.2.9 | 8.7.3.8 | ... |
| Shipboard elevators | 8.7.5.8 | ... | ... |
| Shortening of suspension rope | 8.7.1.7 | 8.7.1.7 | ... |
| Sidewalk elevators | 8.7.5.5 | 8.7.5.5 | ... |
| Signaling device | 8.7.2.28 | 8.7.3.31.6 | ... |
| Skylight in machine room | 8.7.2.7.5 | 8.7.3.7 | ... |
| Sleeving | ... | 8.7.3.23.3 | ... |
| Smoke, control of | 8.7.2.1.5 | 8.7.2.1.5 | ... |
| Special purpose elevators | 8.7.5.7 | ... | ... |

| Item | Electric Elevators | Hydraulic Elevators | Escalators and Moving Walks |
|---------------------------------|--------------------|----------------------|-----------------------------|
| Speed, increase in | 8.7.2.17.2 | 8.7.3.22.2 | ... |
| Speed governor | 8.7.2.19 | 8.7.3.16 | ... |
| Spring buffer | 8.7.2.27 | 8.7.3.27 | ... |
| Step system | ... | ... | 8.7.6.1.7 |
| Stop switch, in-car | 8.7.2.14.5 | 8.7.3.13, 8.7.2.14.5 | ... |
| Stop valve | ... | 8.7.3.24 | ... |
| Stopping device, terminal | 8.7.2.26 | 8.7.3.30 | ... |
| Storage and discharge tank | ... | 8.7.3.29 | ... |
| Supply piping | ... | 8.7.3.24 | ... |
| Support | 8.7.2.9 | 8.7.3.9 | ... |
| Suspension rope | 8.7.2.21.1 | 8.7.3.25 | ... |
| Suspension rope, replacement of | 8.7.1.7 | 8.7.1.7 | ... |
| Suspension rope, splicing of | 8.7.1.7 | 8.7.1.7 | ... |
| Suspension rope equalizer | 8.7.2.21.2 | 8.7.3.25.2 | ... |
| Swing type entrance | 8.7.2.10.4 | 8.7.2.10.4 | ... |
| Tank | ... | 8.7.3.29 | ... |
| Temporary wiring | 8.7.1.6 | 8.7.1.6 | 8.7.1.6 |
| Terminal stopping device | 8.7.2.26 | 8.7.3.30 | ... |
| Testing | 8.7.1.3 | 8.7.1.3 | 8.7.1.3 |
| Top of car operating device | 8.7.2.27.1 | 8.7.3.31.1 | ... |
| Track system | ... | ... | 8.7.6.1.10, 8.7.6.2.10 |
| Transfer devices, automatic | 8.7.7.2 | 8.7.7.2 | ... |
| Travel, increase or decrease in | 8.7.2.17.1 | 8.7.3.22.1 | ... |
| Treadway system | ... | ... | 8.7.6.2.7 |
| Truck zoning device | 8.7.2.27.2 | 8.7.3.31.2 | ... |
| Trusses and girders | ... | ... | 8.7.6.1.9, 8.7.6.2.9 |
| Type of operation, change in | 8.7.2.27.6 | 8.7.3.31.5 | ... |
| Type of service, change in | 8.7.2.16.1 | ... | ... |
| Unlocking device, hoistway door | 8.7.2.11.4 | 8.7.3.11 | ... |
| Valve | ... | 8.7.3.24 | ... |
| Ventilation of machine room | 8.7.2.7.7 | 8.7.2.7.7 | ... |
| Vertical slide type entrance | 8.7.2.10.3 | 8.7.2.10.3 | ... |
| Voltage, change in | 8.7.2.27.3 | 8.7.3.31.4 | ... |
| Walls, hoistway enclosure | 8.7.2.1.1 | 8.7.3.1 | ... |
| Welding | 8.7.1.4, 8.8 | 8.7.1.4, 8.8 | 8.7.1.4, 8.8 |
| Window in machine room | 8.7.2.7.5 | 8.7.2.7.5 | ... |
| Wire rope | 8.7.2.21 | 8.7.3.25 | ... |
| Wiring | 8.7.2.8 | 8.7.3.8 | ... |
| Wiring, temporary | 8.7.1.6 | 8.7.1.6 | 8.7.1.6 |
| Working pressure, increase in | ... | 8.7.3.23.4 | ... |

NONMANDATORY APPENDIX M INERTIA APPLICATION FOR TYPE A SAFETY DEVICE LOCATION OF TEST WEIGHT [8.10.2.2.2(ii)(2)]

Fig. M-1

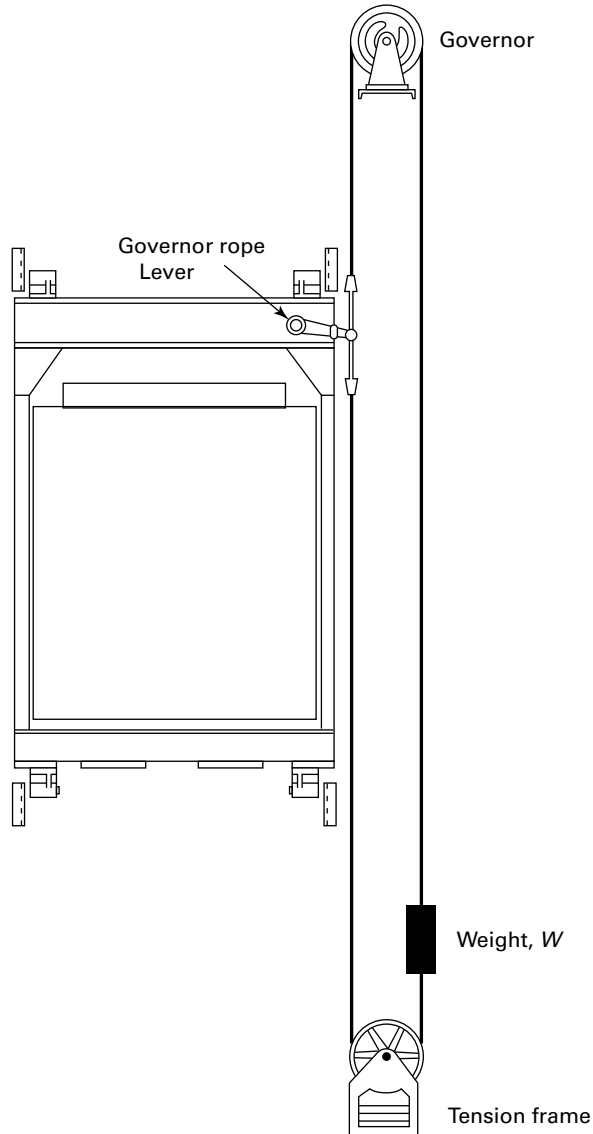

NONMANDATORY APPENDIX N RECOMMENDED INSPECTION AND TEST INTERVALS IN “MONTHS”

See Table N-1 on the following page.

Table N-1 Recommended Inspection and Test Intervals in “Months”

| Reference Section | Equipment Type | Periodic Tests | | | | | | | | | | | | | | | |
|-------------------|--|----------------------|----------|--------------------|----------|-------------|----------|--------------------|----------|-------------|----------|-------------|----------|-------------|----------|--|--|
| | | Periodic Inspections | | | | Category 1 | | | | Category 3 | | | | Category 5 | | | |
| | | Requirement | Interval | Requirement | Interval | Requirement | Interval | Requirement | Interval | Requirement | Interval | Requirement | Interval | Requirement | Interval | | |
| 8.11.2 | Electric elevators | 8.11.2.1 | 6 | 8.6.4.19 | 12 | N/A | N/A | 8.6.4.20 | 60 | | | | | | | | |
| 8.11.3 | Hydraulic elevators | 8.11.3.1 | 6 | 8.6.5.14 | 12 | 8.6.5.15 | 36 | 8.6.5.16 | 60 | | | | | | | | |
| 8.11.4 | Escalators and moving walks | 8.11.4.1 | 6 | 8.6.8.15 | 12 | N/A | N/A | N/A | N/A | | | | | | | | |
| 8.11.5.1 | Sidewalk elevators | 8.11.2.1, 8.11.3.1 | 6 | 8.6.4.19, 8.6.5.14 | 12 | 8.6.5.15 | 36 | 8.6.4.20, 8.6.5.16 | 60 | | | | | | | | |
| 8.11.5.2 | Private residence elevators | 8.11.2.1, 8.11.3.1 | 12 | 8.6.4.19, 8.6.5.14 | 12 | 8.6.5.15 | 36 | 8.6.4.20, 8.6.5.16 | 60 | | | | | | | | |
| 8.11.5.3 | Hand elevators | 8.11.2.1 | 6 | 8.6.4.19 | 12 | N/A | N/A | 8.6.4.20, 8.6.5.16 | 60 | | | | | | | | |
| 8.11.5.4 | Dumbwaiters | 8.11.2.1, 8.11.3.1 | 12 | 8.6.4.19, 8.6.5.14 | 12 | 8.6.5.15 | 36 | 8.6.4.20, 8.6.5.16 | 60 | | | | | | | | |
| 8.11.5.5 | Material lifts and dumbwaiters with automatic transfer devices | 8.11.2.1, 8.11.3.1 | 12 | 8.6.4.19, 8.6.5.14 | 12 | 8.6.5.15 | 36 | 8.6.4.20, 8.6.5.16 | 60 | | | | | | | | |
| 8.11.5.6 | Special purpose personnel elevators | 8.11.2.1, 8.11.3.1 | 6 | 8.6.4.19, 8.6.5.14 | 12 | 8.6.5.15 | 36 | 8.6.4.20, 8.6.5.16 | 60 | | | | | | | | |
| 8.11.5.7 | Inclined elevators | 8.11.2.1, 8.11.3.1 | 6 | 8.6.4.19, 8.6.5.14 | 12 | 8.6.5.15 | 36 | 8.6.4.20, 8.6.5.16 | 60 | | | | | | | | |
| 8.11.5.8 | Shipboard elevators | 8.11.2.1, 8.11.3.1 | 6 | 8.6.4.19, 8.6.5.14 | 12 | 8.6.5.15 | 36 | 8.6.4.20, 8.6.5.16 | 60 | | | | | | | | |
| 8.11.5.9 | Screw-column elevators | 8.11.2.1, 8.11.3.1 | 6 | 8.6.4.19, 8.6.5.14 | 12 | 8.6.5.15 | 36 | 8.6.4.20, 8.6.5.16 | 60 | | | | | | | | |
| 8.11.5.10 | Roof-top elevators | 8.11.2.1, 8.11.3.1 | 6 | 8.6.4.19, 8.6.5.14 | 12 | 8.6.5.15 | 36 | 8.6.4.20, 8.6.5.16 | 60 | | | | | | | | |
| 8.11.5.12 | Limited-use/limited-application elevators | 8.11.2.1, 8.11.3.1 | 6 | 8.6.4.19, 8.6.5.14 | 12 | 8.6.5.15 | 36 | 8.6.4.20, 8.6.5.16 | 60 | | | | | | | | |
| 8.11.5.13 | Elevators used for construction | 8.11.2.1, 8.11.3.1 | 3 | 8.6.4.19, 8.6.5.14 | 12 | 8.6.5.15 | 36 | 8.6.4.20, 8.6.5.16 | 60 | | | | | | | | |

GENERAL NOTE: Factors such as the environment, frequency of usage and type of usage, quality of maintenance, age and condition, remote monitoring (see Table N2), etc., related to the equipment should be taken into account by the authority having jurisdiction prior to establishing the inspection and test intervals. It is recommended that a risk analysis, using the methodology of ISO/TS 14798, be utilized to establish the intervals of inspections and tests for components and systems of the equipment. Where a risk analysis is not performed, the intervals specified in Table N1 are recommended for periodic tests (see 8.6) and periodic inspections (see 8.11).

INTRODUCTION TO MONITORING (TABLE N-2)

Table N-2 is intended to give guidance on the practical application of monitoring for inspections. It is intended to provide information as to where monitoring is or is not practical based on current technology. It is not intended to be all-inclusive or limit the use of monitoring to the identified items.

Monitoring function can be accomplished in two ways.

(a) *Overlay Monitoring.* Overlay monitoring is accomplished by adding a stand-alone monitoring system to an existing elevator installation. This monitoring system would connect to the elevator control system to monitor various signal points and report their status. Using its internal processing the stand-alone monitoring system could determine normal signal status and report any monitored abnormal behavior.

(b) *Integral Monitoring.* Integral monitoring is built into the elevator control system. This allows better access to the functions of the elevator control system. This type of monitoring can report abnormal operation of a more inclusive variety than is practical with the overlay monitoring system.

Both of the above-described systems must conform to all Code requirements when interfacing to elevator/escalator control points.

The application of monitoring to elevator/escalator inspection is a practical approach to supplementing on-site inspections.

All elevator/escalator devices that have an electrical contact can usually be monitored and the operation of the contact can be transmitted to a remote site for storage or viewing. Adding devices that will locally monitor the function and transmit the results to a remote site may also monitor other functions of the elevator/escalator. Such a device to monitor another function could be a tachometer to monitor the speed of the elevator. This could be set to trigger an alert or message if the device detected an abnormal condition.

The data collected by the monitoring system can be reported to a central data collection and storage site. This communications link can be via the in-car phone or other device. If the in-car phone is used, the monitor reporting modem must be secondary in priority to the communications requirements in 2.27.1.

Table N-2 Guidelines on Use of Monitoring to Provide Inspection Data

(ED)

| A17.1/B44 | A17.2 | Item | Device May Be Monitored [Note (1)] | Visual Inspection | Comments |
|---|-------|--|---|----------------------|---|
| Periodic Inspection Electric Elevators | | | | | |
| 8.11.2.1.1 | | Inside Car | | | |
| | 1.1 | Door Reopening Device | X | ... | Since it does not activate on a regular interval, certain assumptions must be made. |
| | 1.2 | Stop Switches | X | ... | |
| | 1.3 | Operating Control Devices | X | ... | |
| | 1.4 | Car Floor and Landing Sill | ... | X | |
| | 1.5 | Car Lighting | ... | X | Could monitor voltage and current. |
| | 1.6 | Car Emergency Signal | X | ... | |
| | 1.7 | Car Door or Gate | ... | X | |
| | 1.8 | Door Closing Force | X | ... | Could monitor current. |
| | 1.9 | Power Closing of Doors or Gates | X | ... | This gives insight to door operation. |
| | 1.10 | Power Opening of Doors or Gates | X | ... | This gives insight to door operation. |
| | 1.11 | Car Vision Panels and Glass Car Doors | ... | X | |
| | 1.12 | Car Enclosure | ... | X | |
| | 1.13 | Emergency Exit | ... | X | The switch itself could be monitored for actuation. |
| | 1.14 | Ventilation | ... | X | Could monitor temperature/air flow switch. |
| | 1.15 | Signs and Operating Device Symbols | ... | X | |
| | 1.16 | Rated Load, Platform Area, and Data Plate | ... | X | |
| | 1.17 | Standby or Emergency Power Operation | ... | X | |
| | 1.18 | Restricted Opening of Car or Hoistway Doors | ... | X | |
| | 1.19 | Car Ride | X | ... | |

Table N-2 Guidelines on Use of Monitoring to Provide Inspection Data (Cont'd)

| A17.1/B44 | A17.2 | Item | Device May Be Monitored [Note (1)] | Visual Inspection | Comments |
|-------------------|-------|---|---|----------------------|--|
| | 1.20 | Door Monitoring Systems | X | ... | This device could be monitored for actuation. |
| | 1.21 | Stopping Accuracy | X | ... | |
| 8.11.2.1.2 | | Machine Room | | | |
| | 2.1 | Access to Machine Space | ... | X | |
| | 2.2 | Headroom | ... | X | |
| | 2.3 | Lighting and Receptacles | ... | X | |
| | 2.4 | Enclosure of Machine | ... | X | |
| | 2.5 | Housekeeping | ... | X | |
| | 2.6 | Ventilation | ... | X | Could monitor temperature and air flow switch. |
| | 2.7 | Fire Extinguisher | ... | X | |
| | 2.8 | Pipes, Wiring, and Ducts | ... | X | |
| | 2.9 | Guarding of Equipment | ... | X | |
| | 2.10 | Numbering of Elevators, Machines, and Disconnect Switches | ... | X | |
| | 2.11 | Disconnecting Means and Control | ... | X | |
| | 2.12 | Controller Wiring, Fuses, and Grounding | ... | X | |
| | 2.13 | Static Control | ... | X | |
| | 2.14 | Overhead Beam and Fastenings | ... | X | |
| | 2.15 | Drive Machine Brake | ... | X | Could monitor wear with a sensor. |
| | 2.16 | Traction Drive Machines | ... | X | |
| | 2.17 | Gears, Bearings, and Flexible Connections | ... | X | |
| | 2.18 | Winding Drum Machine | ... | X | |
| | 2.19 | Belt or Chain Drive Machine | ... | X | |
| | 2.20 | Motor Generator | X | ... | |
| | 2.21 | Absorption of Regenerated Power | X | ... | |
| | 2.22 | Drives From a DC Source | X | ... | |
| | 2.23 | Traction Sheaves | ... | X | |
| | 2.24 | Secondary and Deflector Sheaves | ... | X | |
| | 2.25 | Rope Fastenings | ... | X | |
| | 2.26 | Terminal Stopping Devices | X | ... | |
| | 2.27 | Slack Rope | X | ... | |
| | 2.28 | Governor Overspeed Switch, and Seal | ... | X | The switch itself could be monitored for actuation. |
| | 2.29 | Car and Counterweight Safeties | ... | X | |
| | 2.30 | Code Data Plate | ... | X | |
| 8.11.2.1.3 | | Top Of Car | | | |
| | 3.1 | Top-of-Car Stop Switch | X | ... | |
| | 3.2 | Car Top Light and Outlet | ... | X | |
| | 3.3 | Top-of-Car Operating Device and Platform | X | ... | The top-of-car operating devices could be monitored for actuation. |
| | 3.4 | Top-of-Car Clearance and Refuge Space | ... | X | |
| | 3.5 | Top Counterweight Clearance | ... | X | |
| | 3.6 | Car, Overhead, and Deflector Sheaves | ... | X | |
| | 3.7 | Normal Terminal Stopping Devices | X | ... | |
| | 3.8 | Final Terminal Stopping Devices | X | ... | |
| | 3.9 | Broken Rope, Chain, or Tape Switch | ... | X | The switch itself could be monitored for actuation. |
| | 3.10 | Car Leveling Devices | ... | X | The switch itself could be monitored for actuation. |
| | 3.11 | Crosshead Data Plate | ... | X | |
| | 3.12 | Top Emergency Exit | ... | X | The switch itself could be monitored for actuation. |

Table N-2 Guidelines on Use of Monitoring to Provide Inspection Data (Cont'd)

| A17.1/B44 | A17.2 | Item | Device May Be Monitored [Note (1)] | Visual Inspection | Comments |
|-------------------|-------|--|---|----------------------|---|
| | 3.13 | Counterweight and Counterweight Buffer | ... | X | |
| | 3.14 | Counterweight Safeties | ... | X | |
| | 3.15 | Floor and Emergency Identification Numbering | ... | X | |
| | 3.16 | Hoistway Construction | ... | X | |
| | 3.17 | Hoistway Smoke Control | ... | X | |
| | 3.18 | Pipes, Wiring, and Ducts | ... | X | |
| | 3.19 | Windows, Projections, Recesses, and Setbacks | ... | X | |
| | 3.20 | Hoistway Clearances | ... | X | |
| | 3.21 | Multiple Hoistways | ... | X | |
| | 3.22 | Traveling Cables and Junction Boxes | ... | X | |
| | 3.23 | Door and Gate Equipment | ... | X | |
| | 3.24 | Car Frame and Stiles | ... | X | |
| | 3.25 | Guide Rails, Fastening, and Equipment | ... | X | |
| | 3.26 | Governor Rope | ... | X | |
| | 3.27 | Governor Releasing Carrier | ... | X | |
| | 3.28 | Wire Rope Fastening and Hitch Plate | ... | X | |
| | 3.29 | Wire Suspension and Compensating Ropes | X | ... | |
| 8.11.2.1.4 | | Outside Hoistway | | | |
| | 4.1 | Car Platform Guard | ... | X | |
| | 4.2 | Hoistway Doors | ... | X | |
| | 4.3 | Vision Panels | ... | X | |
| | 4.4 | Hoistway Door Locking Devices | ... | X | If this device has an electrical switch, it may be monitored for actuation. |
| | 4.5 | Access to Hoistway | ... | X | |
| | 4.6 | Power Closing of Hoistway Doors | ... | X | |
| | 4.7 | Sequence Operation | ... | X | |
| | 4.8 | Hoistway Enclosure | ... | X | |
| | 4.9 | Elevator Parking Devices | X | ... | |
| | 4.10 | Emergency and Access Hoistway Openings | ... | X | If this device has an electrical switch, it may be monitored for actuation. |
| | 4.11 | Separate Counterweight Hoistway | ... | X | |
| | 4.12 | Standby Power Selection Switch | ... | X | The switch itself could be monitored for actuation. |
| 8.11.2.1.5 | | Pit | | | |
| | 5.1 | Pit Access, Lighting, Stop Switch, and Condition | ... | X | The switch itself could be monitored for actuation. |
| | 5.2 | Bottom Clearance and Runby | ... | X | |
| | 5.3 | Final Terminal Stopping Device | X | ... | Can be monitored, but local activation required. |
| | 5.4 | Normal Terminal Stopping Devices | X | ... | |
| | 5.5 | Traveling Cables | ... | X | |
| | 5.6 | Governor-Rope Tension Devices | ... | X | |
| | 5.7 | Car Frame and Platform | ... | X | |
| | 5.8 | Car Safeties and Guiding Members | ... | X | |
| | 5.9 | Car and Counterweight Buffer | X | X | The switch itself could be monitored for actuation. |
| | 5.10 | Compensating Chains, Ropes, and Sheaves | ... | X | |
| 8.11.2.1.6 | | Firefighters' Service | | | If this device has an electrical switch, it may be monitored for actuation. |

Table N-2 Guidelines on Use of Monitoring to Provide Inspection Data (Cont'd)

| A17.1/B44 | A17.2 | Item | Device May Be Monitored [Note (1)] | Visual Inspection | Comments |
|---|-------|---|---|----------------------|---|
| Periodic Inspection of Hydraulic Elevators | | | | | |
| 8.11.3.1.1 | | Inside Car | | | |
| | 1.1 | Door Reopening Device | X | ... | Since it does not activate on a regular interval, certain assumptions must be made. |
| | 1.2 | Stop Switches | X | ... | |
| | 1.3 | Operating Control Devices | X | ... | |
| | 1.4 | Sill and Car Floor | ... | X | |
| | 1.5 | Car Lighting and Receptacles | ... | X | Could monitor voltage and current. |
| | 1.6 | Car Emergency Signal | X | ... | |
| | 1.7 | Car Door or Gate | ... | X | |
| | 1.8 | Door Closing Force | X | ... | |
| | 1.9 | Power Closing of Doors or Gates | X | ... | This gives insight to door operation. |
| | 1.10 | Power Opening of Doors or Gates | X | ... | This gives insight to door operation. |
| | 1.11 | Car Vision Panels and Glass Car Doors | ... | X | |
| | 1.12 | Car Enclosure | ... | X | |
| | 1.13 | Emergency Exit | X | X | The switch itself could be monitored for actuation. |
| | 1.14 | Ventilation | ... | X | Could monitor temperature/air flow switch. |
| | 1.15 | Signs and Operating Device Symbols | ... | X | |
| | 1.16 | Rated Load, Platform Area, and Data Plate | ... | X | |
| | 1.17 | Standby Power Operation | ... | X | |
| | 1.18 | Restricted Opening of Car or Hoistway Doors | ... | X | |
| | 1.19 | Car Ride | X | ... | |
| | 1.20 | Door Monitoring System | X | ... | |
| | 1.21 | Stopping Accuracy | X | ... | Could monitor sensors. |
| 8.11.3.1.2 | | Machine Room | | | |
| | 2.1 | Access to Machine Space | ... | X | |
| | 2.2 | Headroom | ... | X | |
| | 2.3 | Lighting and Receptacles | ... | X | |
| | 2.4 | Enclosure of Machine | ... | X | |
| | 2.5 | Housekeeping | ... | X | |
| | 2.6 | Ventilation and Heating | ... | X | Could monitor temperature and air flow switch. |
| | 2.7 | Fire Extinguisher | ... | X | |
| | 2.8 | Pipes, Wiring, and Ducts | ... | ... | |
| | 2.9 | Guarding of Equipment | ... | X | |
| | 2.10 | Numbering of Elevators, Machines, and Disconnect Switches | ... | X | |
| | 2.11 | Disconnecting Means and Control | ... | X | |
| | 2.12 | Controller Wiring, Fuses, and Grounding | ... | X | |
| | 2.13 | Hydraulic Power Unit | ... | X | |
| | 2.14 | Relief Valves | X | ... | |
| | 2.15 | Control Valve | X | ... | Some valve data can be collected. |
| | 2.16 | Tanks | ... | X | |
| | 2.17 | Flexible Hydraulic Hose and Fittings Assemblies | ... | X | |
| | 2.18 | Supply Line and Shutoff Valve | ... | X | |
| | 2.19 | Hydraulic Cylinders and Fluid Loss Record | ... | X | |
| | 2.20 | Pressure Switch | ... | X | The switch itself could be monitored for actuation. |

Table N-2 Guidelines on Use of Monitoring to Provide Inspection Data (Cont'd)

| A17.1/B44 | A17.2 | Item | Device May Be Monitored [Note (1)] | Visual Inspection | Comments |
|-------------------|-------|---|---|----------------------|---|
| | 2.21 | Governor Overspeed Switch and Seal | ... | X | The switch itself could be monitored for actuation. |
| | 2.22 | Recycling Operation | ... | X | |
| 8.11.3.1.3 | | Top of Car | | | |
| | 3.1 | Top-of-Car Stop Switch | X | ... | |
| | 3.2 | Car Top Light and Outlet | ... | X | |
| | 3.3 | Top-of-Car Operating Device | X | ... | The switch itself could be monitored for actuation. |
| | 3.4 | Top-of-Car Clearance and Refuge Space | ... | X | |
| | 3.5 | Normal Terminal Stopping Device | X | ... | |
| | 3.6 | Emergency Terminal Speed Limiting Device | X | ... | The switch itself could be monitored for actuation. |
| | 3.7 | Car Leveling Anticreep Device | X | ... | The switch itself could be monitored for actuation. |
| | 3.8 | Top Emergency Exit | ... | X | If this device has an electrical switch, it may be monitored for actuation. |
| | 3.9 | Floor and Emergency Identification Number | ... | X | |
| | 3.10 | Hoistway Construction | ... | X | |
| | 3.11 | Hoistway Smoke Control | ... | X | |
| | 3.12 | Pipes, Wiring, and Ducts | ... | X | |
| | 3.13 | Windows, Projections, Recesses and Setbacks | ... | X | |
| | 3.14 | Hoistway Clearances | ... | X | |
| | 3.15 | Multiple Hoistways | ... | X | |
| | 3.16 | Traveling Cables and Junction Boxes | ... | X | |
| | 3.17 | Door and Gate Equipment | ... | X | If this device has an electrical switch, it may be monitored for actuation. |
| | 3.18 | Car Frame and Stiles | ... | X | |
| | 3.19 | Guide Rails, Fastening, and Equipment | ... | X | |
| | 3.20 | Governor Rope | ... | X | |
| | 3.21 | Governor Releasing Carrier | ... | X | If this device has an electrical switch, it may be monitored for actuation. |
| | 3.22 | Wire Rope Fastening and Hitch Plate | ... | X | |
| | 3.28 | Counterweight | ... | X | |
| | 3.30 | Speed Test | X | ... | Continuously. |
| | 3.21 | Slack Rope Device | ... | X | |
| | 3.32 | Traveling Sheave | ... | X | |
| | 3.33 | Suspension Rope | ... | X | |
| 8.11.3.1.4 | | Outside the Hoistway | | | |
| | 4.1 | Car Platform Guard | ... | X | |
| | 4.2 | Hoistway Doors | ... | X | |
| | 4.3 | Vision Panels | ... | X | |
| | 4.4 | Hoistway Door Locking Device | ... | X | If this device has an electrical switch, it may be monitored for actuation. |
| | 4.5 | Access to Hoistway | ... | X | |
| | 4.6 | Power Closing of Hoistway Doors | X | ... | If this device has an electrical switch, it may be monitored for actuation. |
| | 4.7 | Sequence Operation | X | ... | |
| | 4.8 | Hoistway Enclosure | ... | X | |
| | 4.9 | Elevator Parking Device | X | ... | If this device has an electrical switch, it may be monitored for actuation. |
| | 4.10 | Emergency Doors in Blind Hoistway | ... | X | If this device has an electrical switch, it may be monitored for actuation. |

Table N-2 Guidelines on Use of Monitoring to Provide Inspection Data (Cont'd)

| A17.1/B44 | A17.2 | Item | Device May Be Monitored [Note (1)] | Visual Inspection | Comments |
|---|------------|---|---|----------------------|--|
| | 4.12 | Standby Power Selection Switch | X | ... | The switch itself could be monitored for actuation. |
| 8.11.3.1.5 | | Pit | | | |
| | 5.1 | Pit Access, Lighting, Stop Switch, and Condition | ... | X | The switch itself could be monitored for actuation. |
| | 5.2 | Bottom Clearance, Runby and Minimum Refuge Space | ... | X | |
| | 5.4 | Normal Terminal Stopping Devices | X | ... | |
| | 5.5 | Traveling Cables | ... | X | |
| | 5.6 | Governor Rope Tension Device | ... | X | If this device has an electrical switch, it may be monitored for actuation. |
| | 5.7 | Car Frame and Platform | ... | X | |
| | 5.8 | Car Safeties and Guiding Members | ... | X | If this device has an electrical switch, it may be monitored for actuation. |
| | 5.11 | Plunger and Cylinder | ... | X | |
| | 5.12 | Car Buffer | X | ... | If this device has an electrical switch, it may be monitored for activation. |
| | 5.13 | Guiding Members | ... | X | |
| | 5.14 | Supply Piping | ... | X | |
| 8.11.3.1.6 | | Firefighters' Service | X | ... | |
| Periodic Inspection of Escalators and Moving Walks | | | | | |
| 8.11.4.1 | | Inspection and Test Requirements | | | |
| | 2.1/4.1 | Machinery Space Access, Lighting, Receptacle, and Condition | ... | X | |
| | 2.2/4.2 | Additional Stop Switch(es) | X | ... | |
| | 2.3/4.3 | Controller and Wiring | ... | X | |
| | 4.9 | Operating Devices | | | |
| | 7.1/9.1 | General Fire Protection | ... | X | |
| | 7.2/9.2 | Geometry | ... | X | |
| | 7.4/9.4 | Entrance and Egress | ... | X | |
| | 7.5/9.5 | Lighting | ... | X | |
| | 7.6/9.6 | Caution Signs | ... | X | |
| | 7.7/9.7 | Combplate | ... | X | |
| | 7.8/9.8 | Deck Barricade Guard and Antislid Devices | ... | X | |
| | 7.9/9.9 | Steps and Treadway | ... | X | |
| | 7.10/9.10 | Operating Devices | X | ... | |
| | 7.11 | Skirt Obstruction Devices | ... | X | If this device has an electrical switch, it may be monitored for actuation. |
| | 7.13/9.13 | Egress Restriction Device | ... | X | |
| | 7.14/9.14 | Speed | X | ... | |
| | 7.15/9.15 | Balustrades | ... | X | |
| | 7.16/9.16 | Ceiling Intersection Guards | ... | X | |
| | 7.17/9.17 | Skirt Panels | ... | X | |
| | 7.18/9.18 | Outdoor Protection | ... | X | |
| | 8.13/10.13 | Handrail Entry Device | ... | X | If this device has an electrical switch, it may be monitored for actuation. |
| | 8.14/10.14 | Code Data Plate | ... | X | |
| 8.11.5 | | See referenced sections | | | |

NOTE:

(1) On-site observation or local actuation may be necessary.

NONMANDATORY APPENDIX P PLUNGER GRIPPER STOPPING DISTANCES

Table P-1 Plunger Gripper Stopping Distances

| Operating Speed in the Down Direction, m/s (ft/min) | Maximum Tripping Speed, m/s (ft/min) | Stopping Distances, mm (in.) | |
|--|--|---------------------------------|------------|
| | | Min. | Max. |
| 0–0.63 (0–125) | 0.90 (175) | 25 (1) | 406 (16) |
| 0.75 (150) | 1.05 (210) | 50 (2) | 584 (23) |
| 0.87 (175) | 1.25 (250) | 75 (3) | 838 (33) |
| 1.00 (200) | 1.40 (280) | 100 (4) | 1 041 (41) |
| 1.12 (225) | 1.55 (308) | 125 (5) | 1 270 (50) |
| 1.25 (250) | 1.70 (337) | 150 (6) | 1 524 (60) |
| 1.50 (300) | 2.00 (395) | 200 (8) | 2 108 (83) |

GENERAL NOTE: Maximum distance calculated using 8.2.6 and substituting 0.1 gravity for deceleration in lieu of 0.35 gravity.

NONMANDATORY APPENDIX Q

EXPLANATORY FIGURES FOR THE DEFINITIONS OF ELEVATOR MACHINERY SPACE, MACHINE ROOM, CONTROL SPACE, CONTROL ROOM, REMOTE MACHINE ROOM, OR REMOTE CONTROL ROOM

Table Q-1

| | Location | | Entry into the Space, Full or Partial | Equipment Used Directly in Connection With the Elevator, Dumbwaiter, or Material Lift | | Equipment Contained Within | |
|----------------------------|--------------------------------|------------------------------------|---------------------------------------|---|--|---|------------------|
| | Inside or Outside the Hoistway | Attached to or Within the Hoistway | | Mechanical Other Than Electric Driving Machine or Hydraulic Machine | Electrical Other Than Motor Controller | Electric Driving Machine or Hydraulic Machine | Motor Controller |
| Machinery Space [Note (1)] | Either | Either | Either | Permitted | Permitted | Permitted | Permitted |
| Control Space | | | | | | Not permitted | Required |
| Machine Room [Note (1)] | Attached to but not within | Full bodily entry required | Required | | | Permitted | |
| Control Room | | | Not permitted | | | Required | |
| Machine Room, Remote | Outside the hoistway | No | Required | | | Permitted | |
| Control Room, Remote | | | Not permitted | | | Required | |
| Machinery Space, Remote | | | Permitted | | | Permitted | |
| Control Space, Remote | | | Not permitted | | | Required | |
| | | | Either | | | | |
| | | | Either | | | | |

NOTE:

- (1) A machinery space outside the hoistway containing an electric driving machine and a motor controller or a hydraulic machine and a motor controller is a machine room.

Fig. Q-1

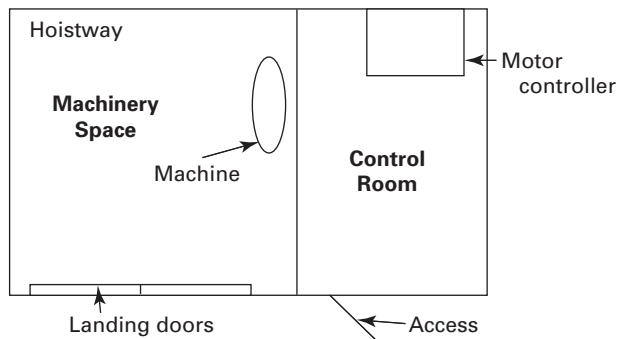

Fig. Q-3

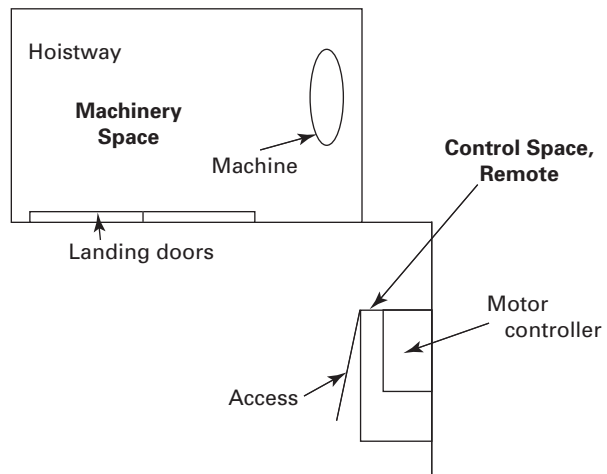

Fig. Q-2

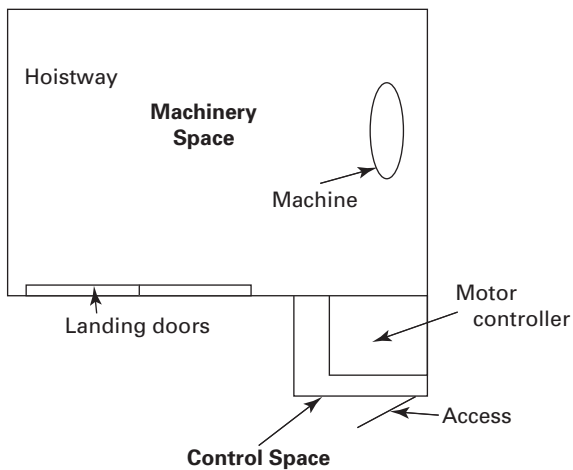

Fig. Q-4

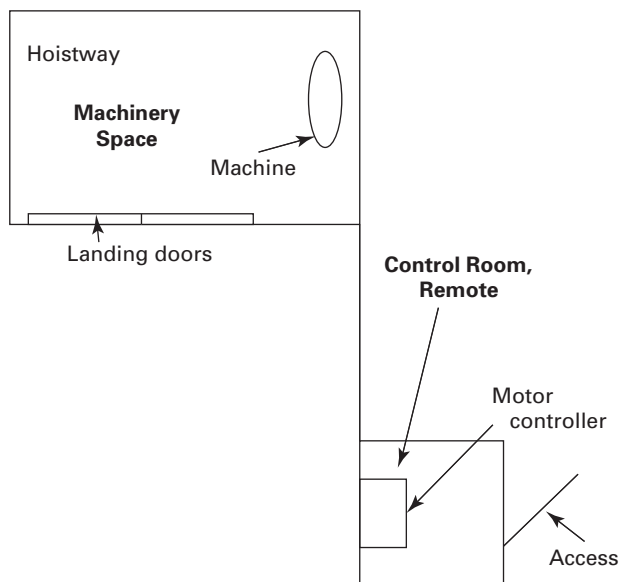

Fig. Q-5

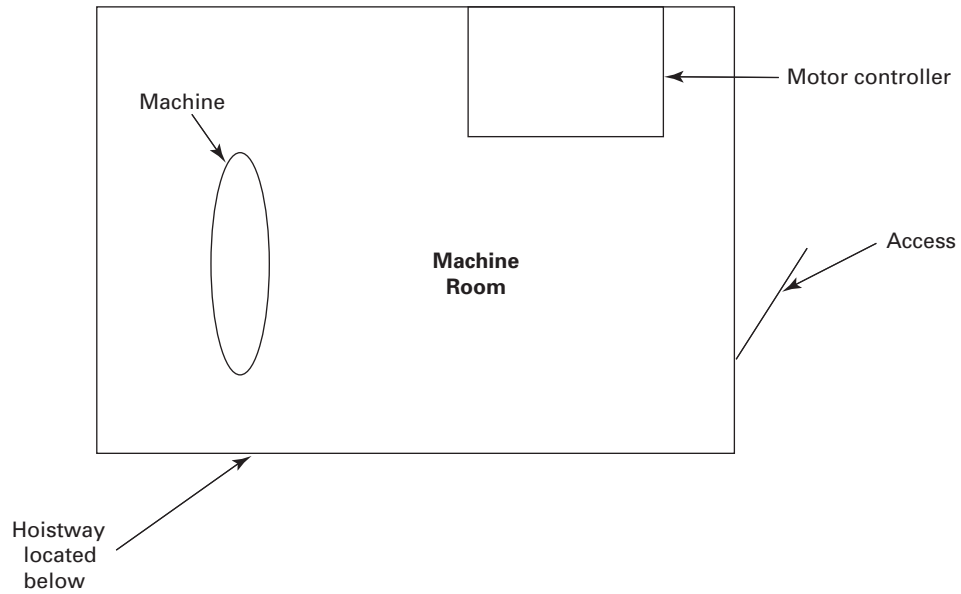
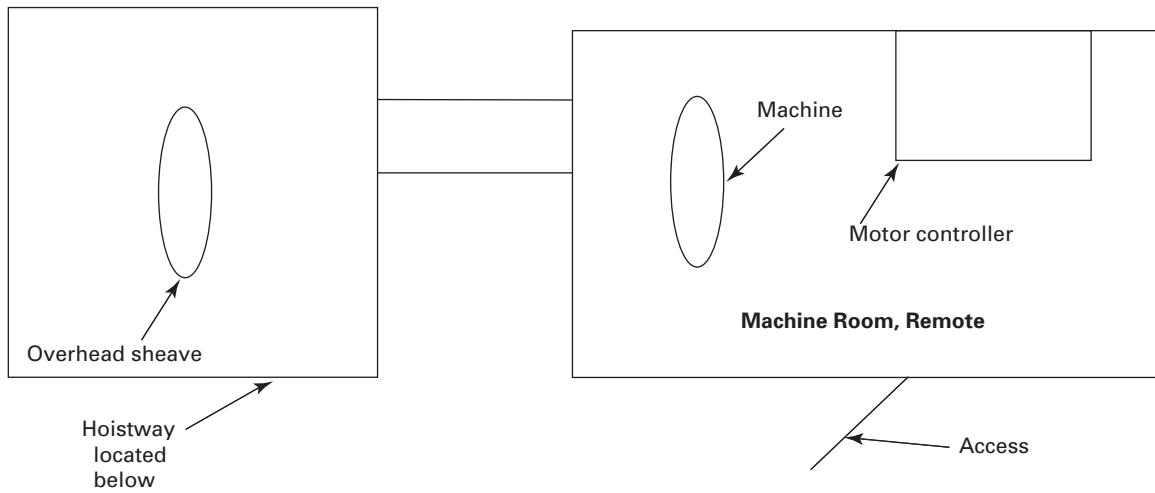

Fig. Q-6



NONMANDATORY APPENDIX R INSPECTION OPERATION AND HOISTWAY ACCESS SWITCH OPERATION HIERARCHY

See Table R-1 on the following page.

(13)

Table R-1 Inspection Operation and Hoistway Access Switch Operation Hierarchy

| | | | | | | | | | | BYPASS Operation, 2.26.1.5 | | | |
|----------------------------------|------------------------|--------------------|-------------------------------------|--------------------------|--------------------------|--|--|---------------------|-----------------|-------------------------------|--------------|--------------|----------------------------------|
| Operation Modes Activated | Top-of-Car, 2.26.1.4.2 | In-Car, 2.26.1.4.3 | Hoistway Access Operation, 2.12.7.3 | Machine Room, 2.26.1.4.4 | Control Room, 2.26.1.4.4 | Machinery Space Outside Hoistway, 2.26.1.4.4 | Control Space Outside Hoistway, 2.26.1.4.4 | Landing, 2.26.1.4.4 | Pit, 2.26.1.4.4 | Working Platform, 2.26.1.4.4 | Top-of-Car | In-Car | Operation Modes Activated |
| Top-of-Car | Top-of-Car | Top-of-Car | Top-of-Car | Top-of-Car | Top-of-Car | Top-of-Car | Top-of-Car | Top-of-Car | No Operation | No Operation | Top-of-Car | Top-of-Car | Top-of-Car |
| In-Car | Top-of-Car | In-Car | In-Car | In-Car | In-Car | In-Car | In-Car | In-Car | No Operation | No Operation | Top-of-Car | In-Car | In-Car |
| Hoistway Access | Top-of-Car | In-Car | Hoistway Access | Hoistway Access | Hoistway Access | Hoistway Access | Hoistway Access | Hoistway Access | No Operation | No Operation | Top-of-Car | In-Car | Hoistway Access |
| Machine Room | Top-of-Car | In-Car | Hoistway Access | Machine Room | No Operation | No Operation | No Operation | No Operation | No Operation | No Operation | Top-of-Car | In-Car | Machine Room |
| Control Room | Top-of-Car | In-Car | Hoistway Access | No Operation | Control Room | No Operation | No Operation | No Operation | No Operation | No Operation | Top-of-Car | In-Car | Control Room |
| Machinery Space Outside Hoistway | Top-of-Car | In-Car | Hoistway Access | No Operation | No Operation | Machinery Space | No Operation | No Operation | No Operation | No Operation | Top-of-Car | In-Car | Machinery Space Outside Hoistway |
| Control Space Outside Hoistway | Top-of-Car | In-Car | Hoistway Access | No Operation | No Operation | No Operation | Control Space | No Operation | No Operation | No Operation | Top-of-Car | In-Car | Control Space Outside Hoistway |
| Landing | Top-of-Car | In-Car | Hoistway Access | No Operation | No Operation | No Operation | No Operation | Landing | No Operation | No Operation | Top-of-Car | In-Car | Landing |
| Pit | No Operation | No Operation | No Operation | No Operation | No Operation | No Operation | No Operation | No Operation | Pit | No Operation | No Operation | No Operation | Pit |
| Working Platform | No Operation | No Operation | No Operation | No Operation | No Operation | No Operation | No Operation | No Operation | No Operation | Working Platform | No Operation | No Operation | Working Platform |

**NONMANDATORY APPENDIX S
VERTICALLY SLIDING DOORS —
ILLUSTRATIONS OF DETECTION ZONES (2.13.3.4)**

Figures begin on following page.

Fig. S-1

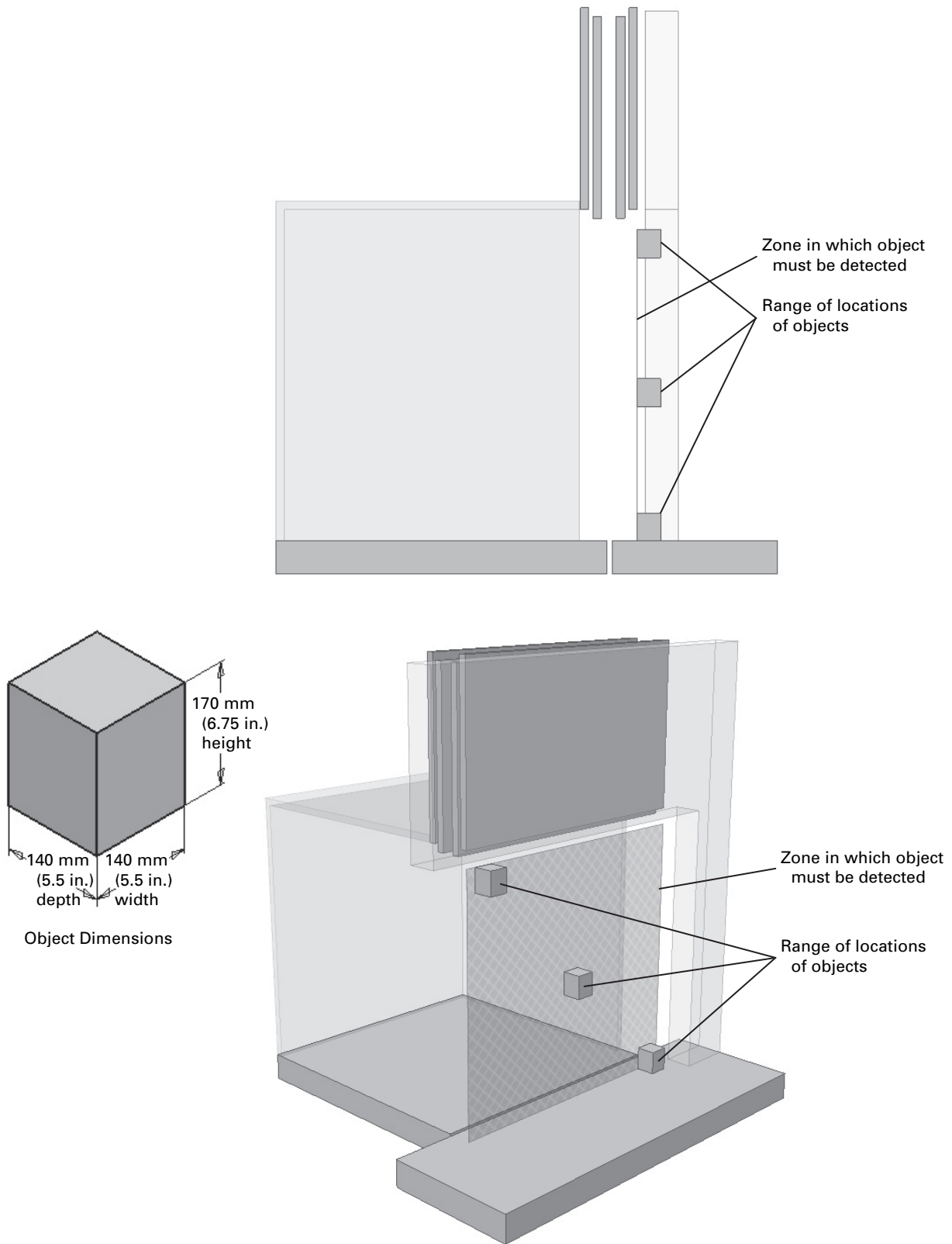
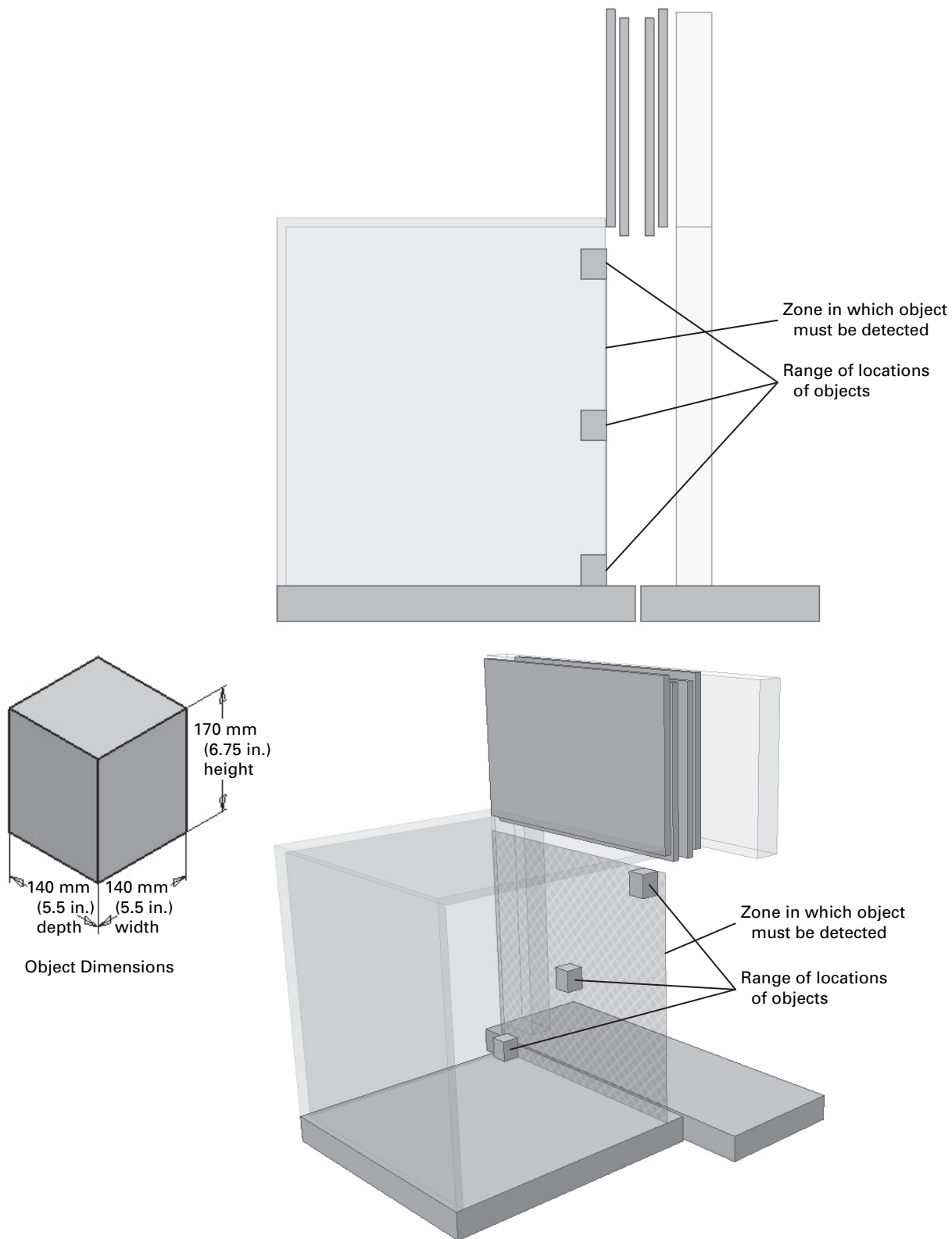
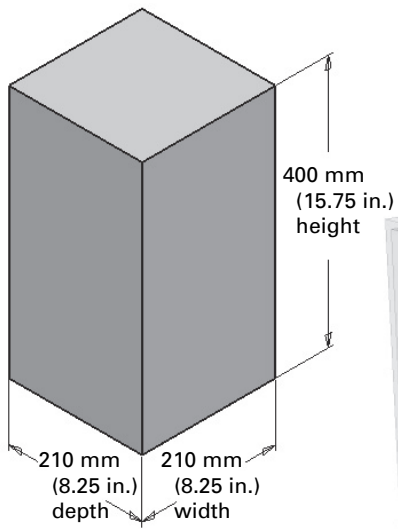
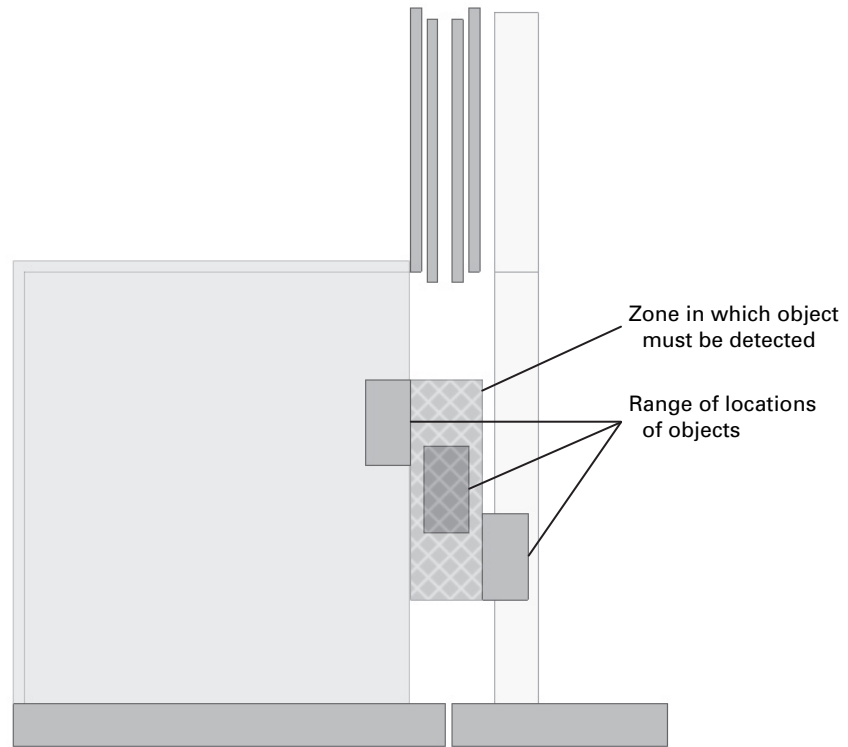

Fig. S-2



Copyright ASME International

Fig. S-3



Object Dimensions

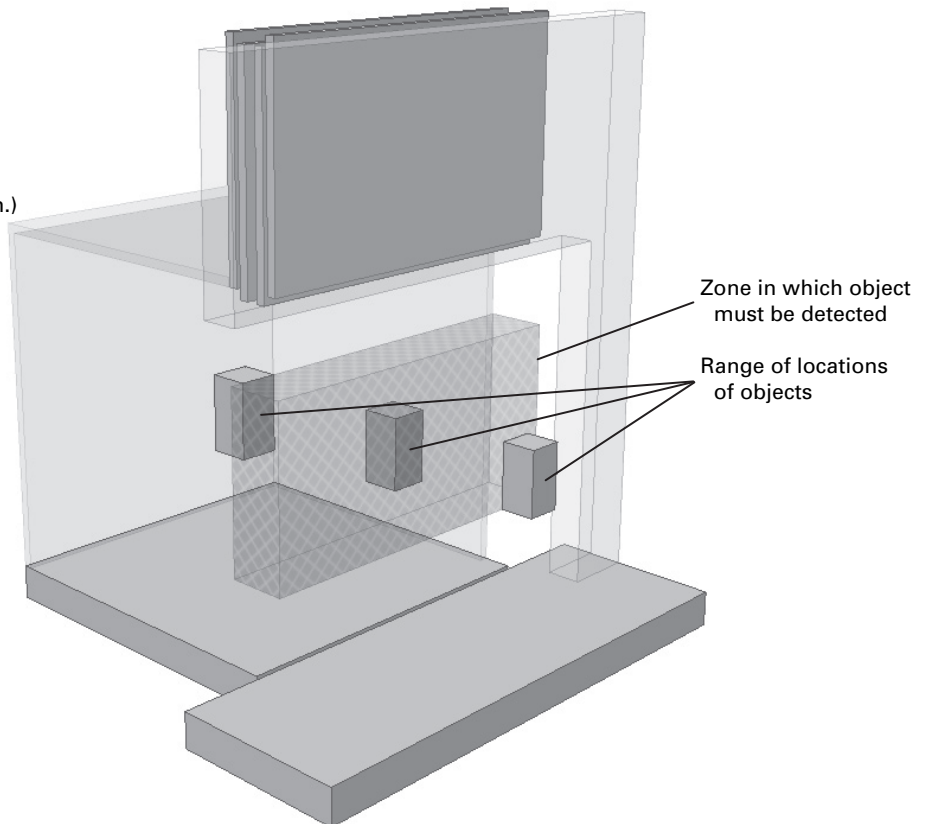

Fig. S-4

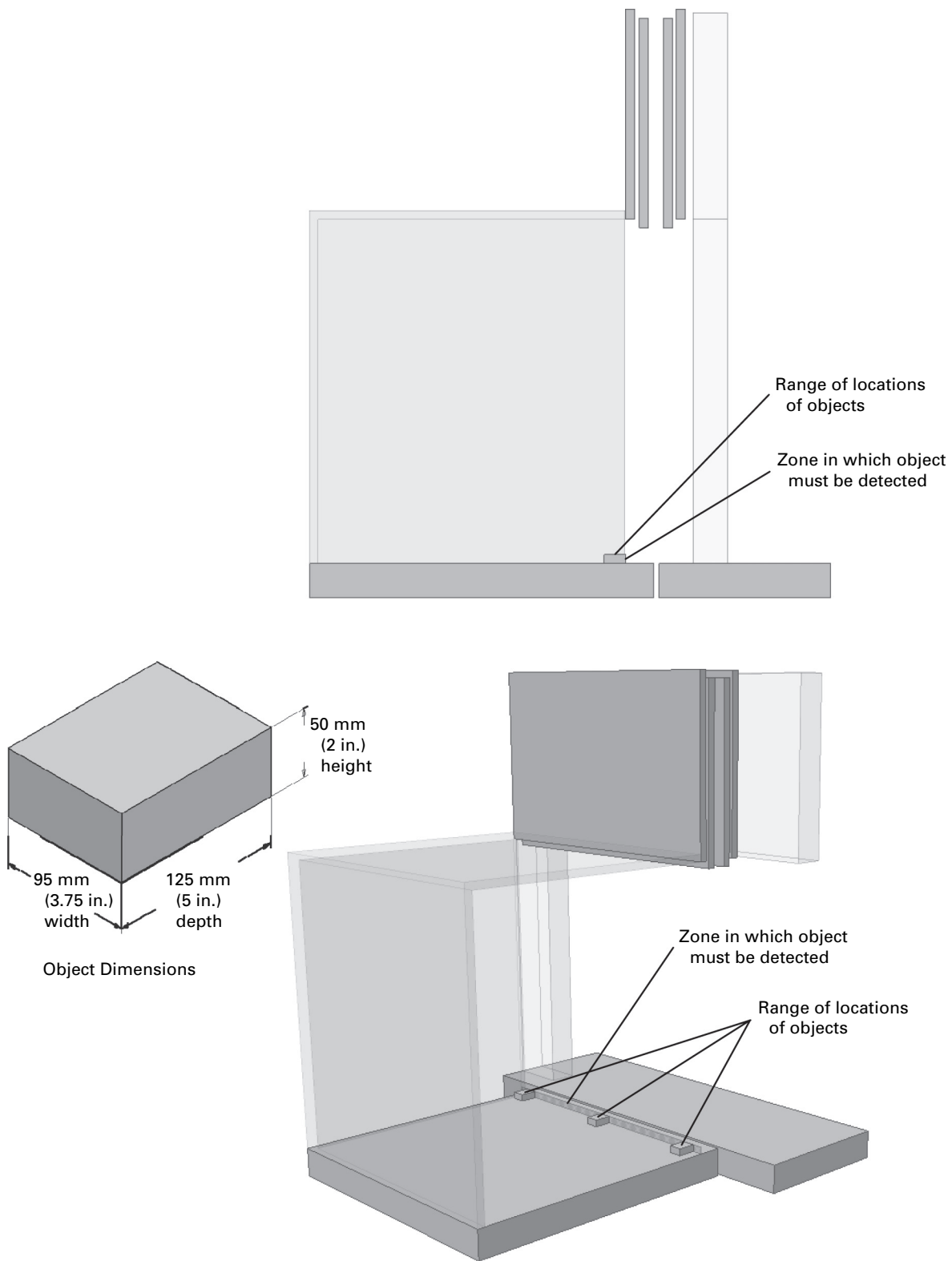

Fig. S-5

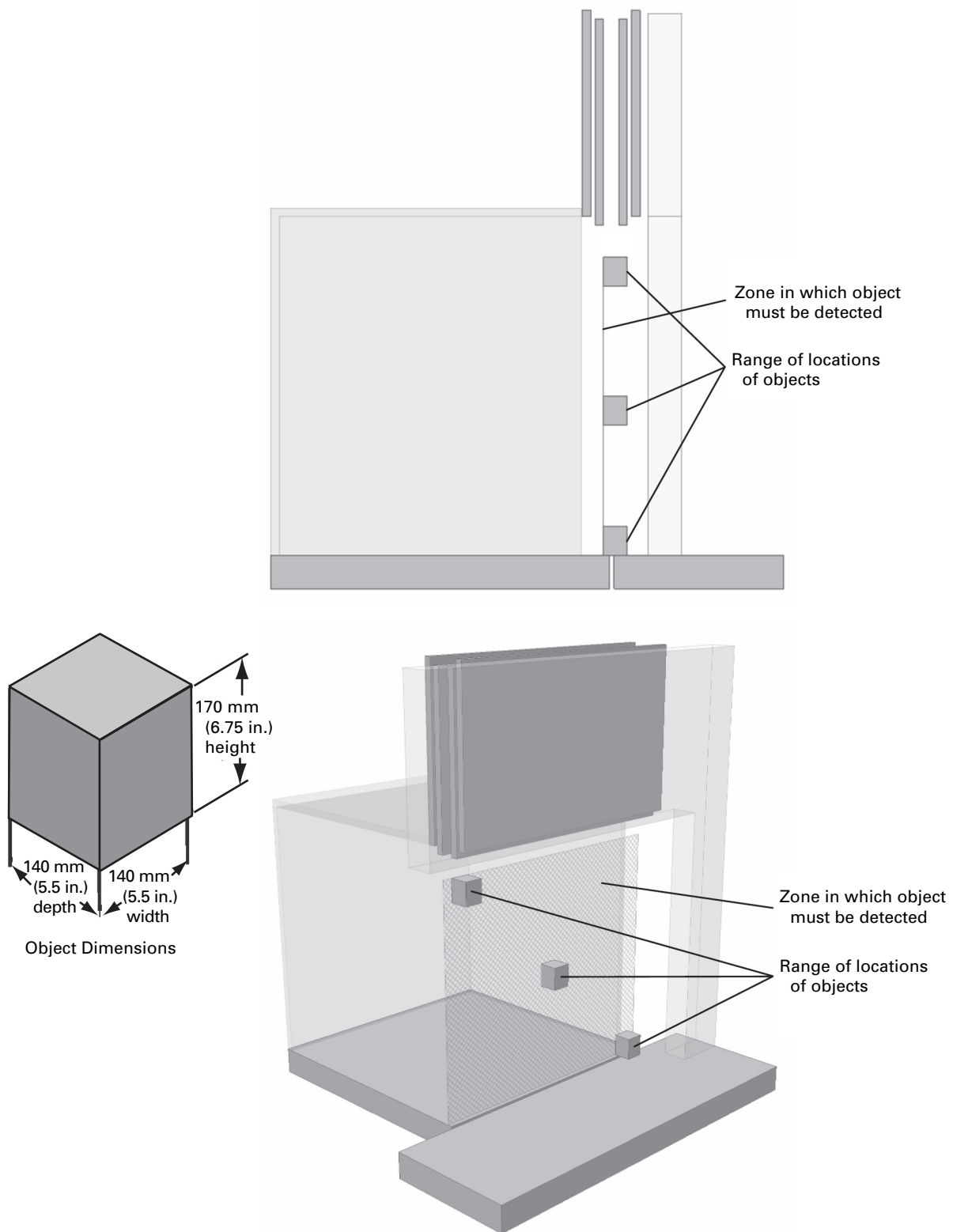

Fig. S-6

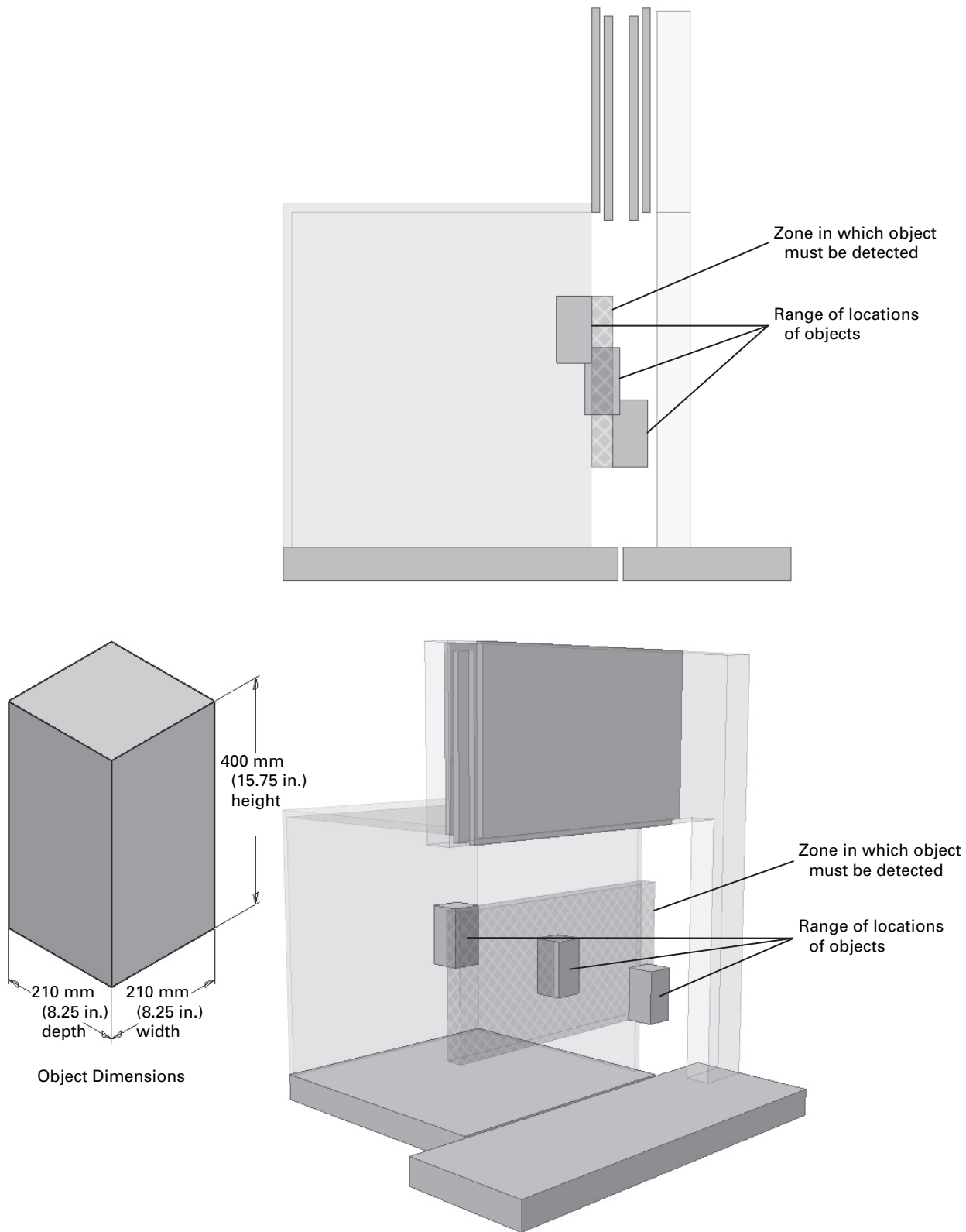

Fig. S-7

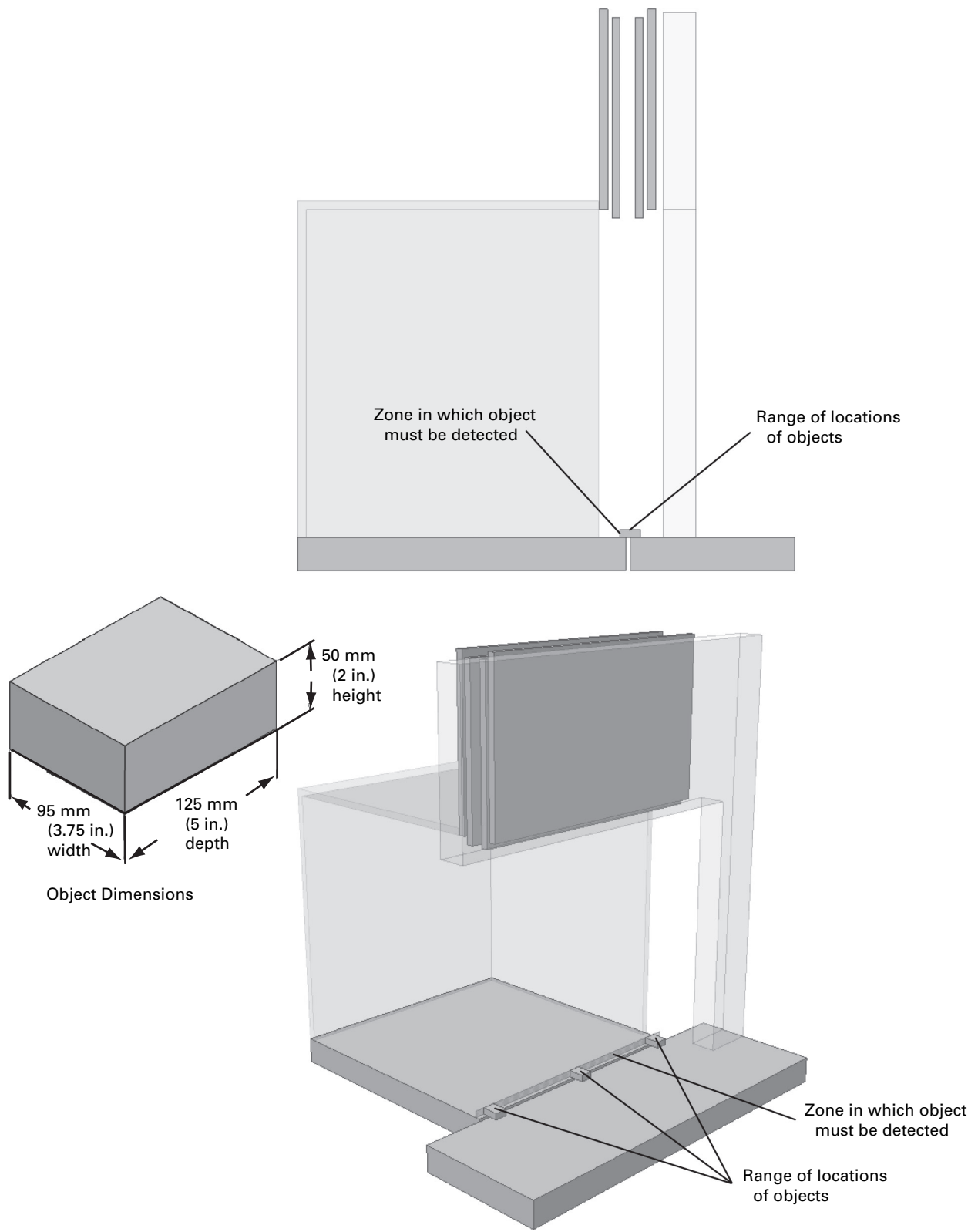

Fig. S-8

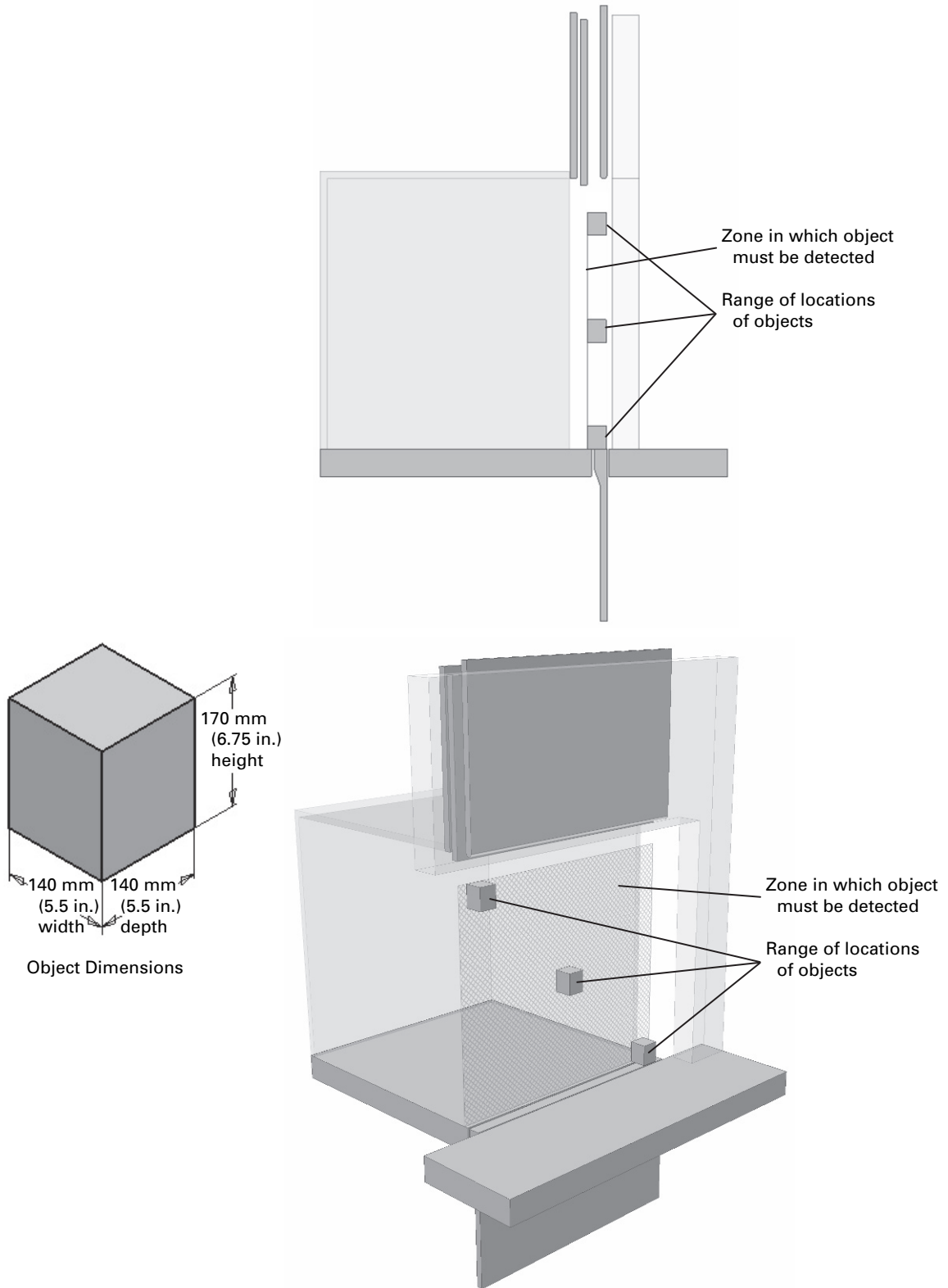

Fig. S-9

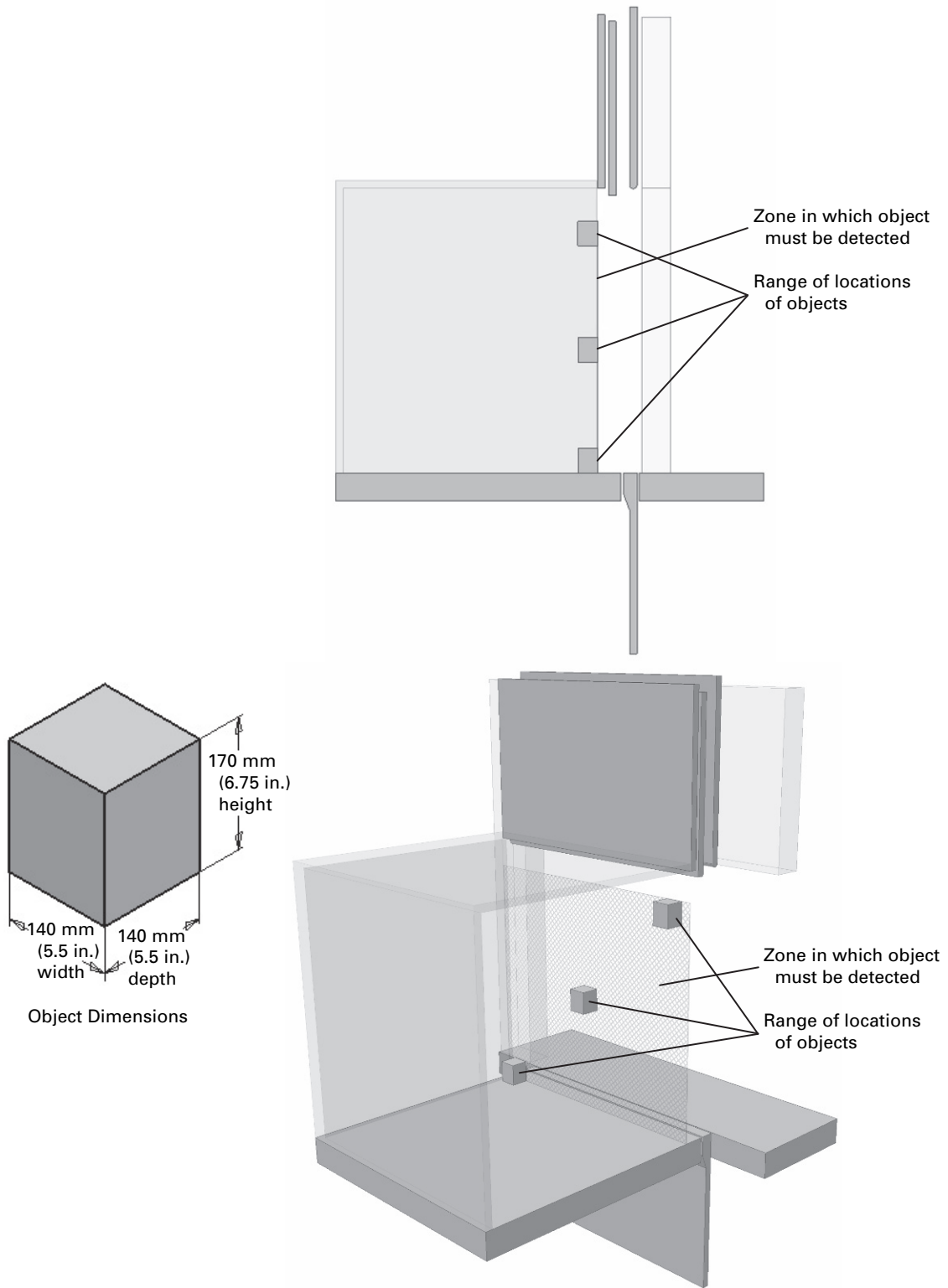

Fig. S-10

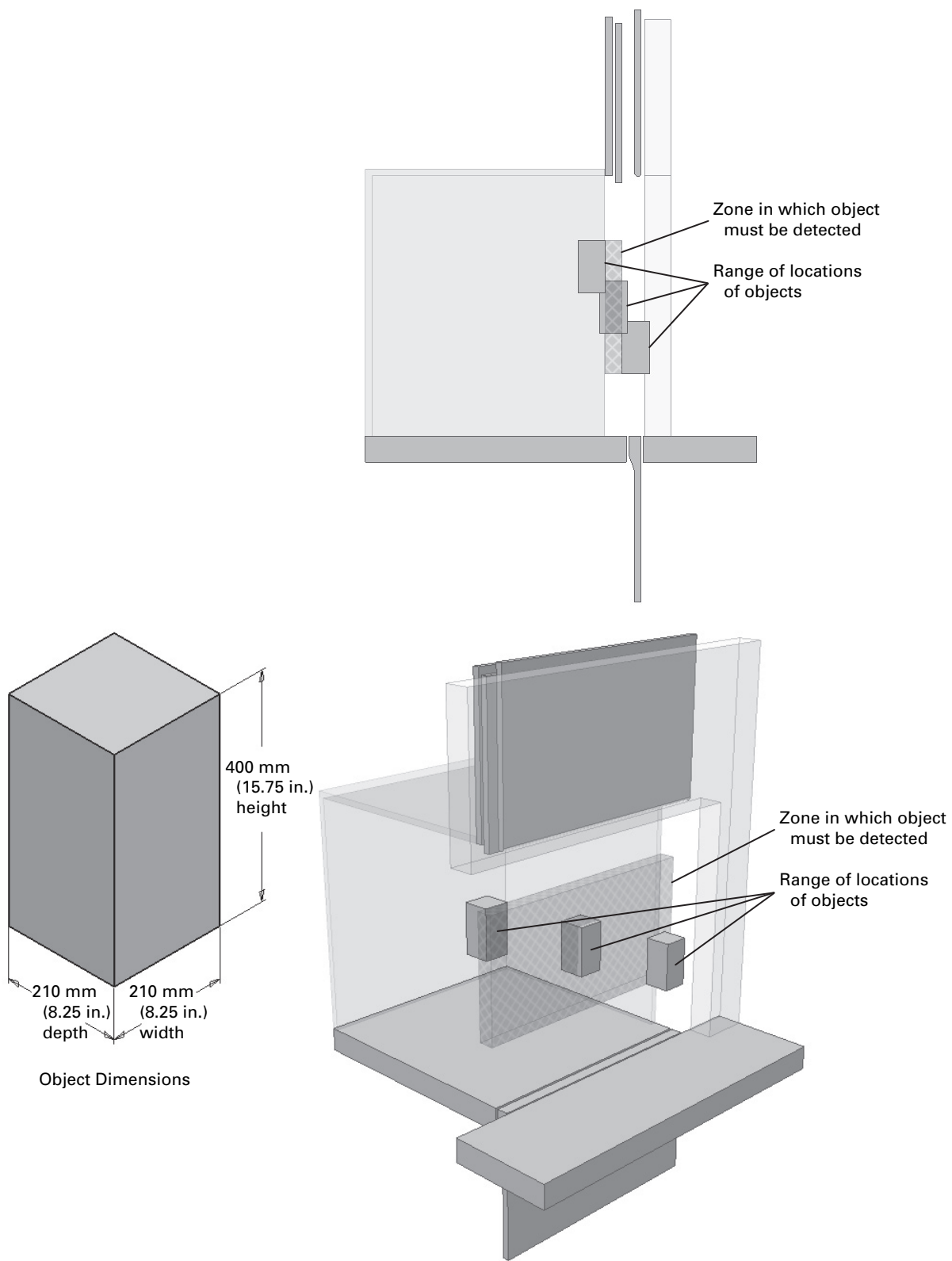

Fig. S-11

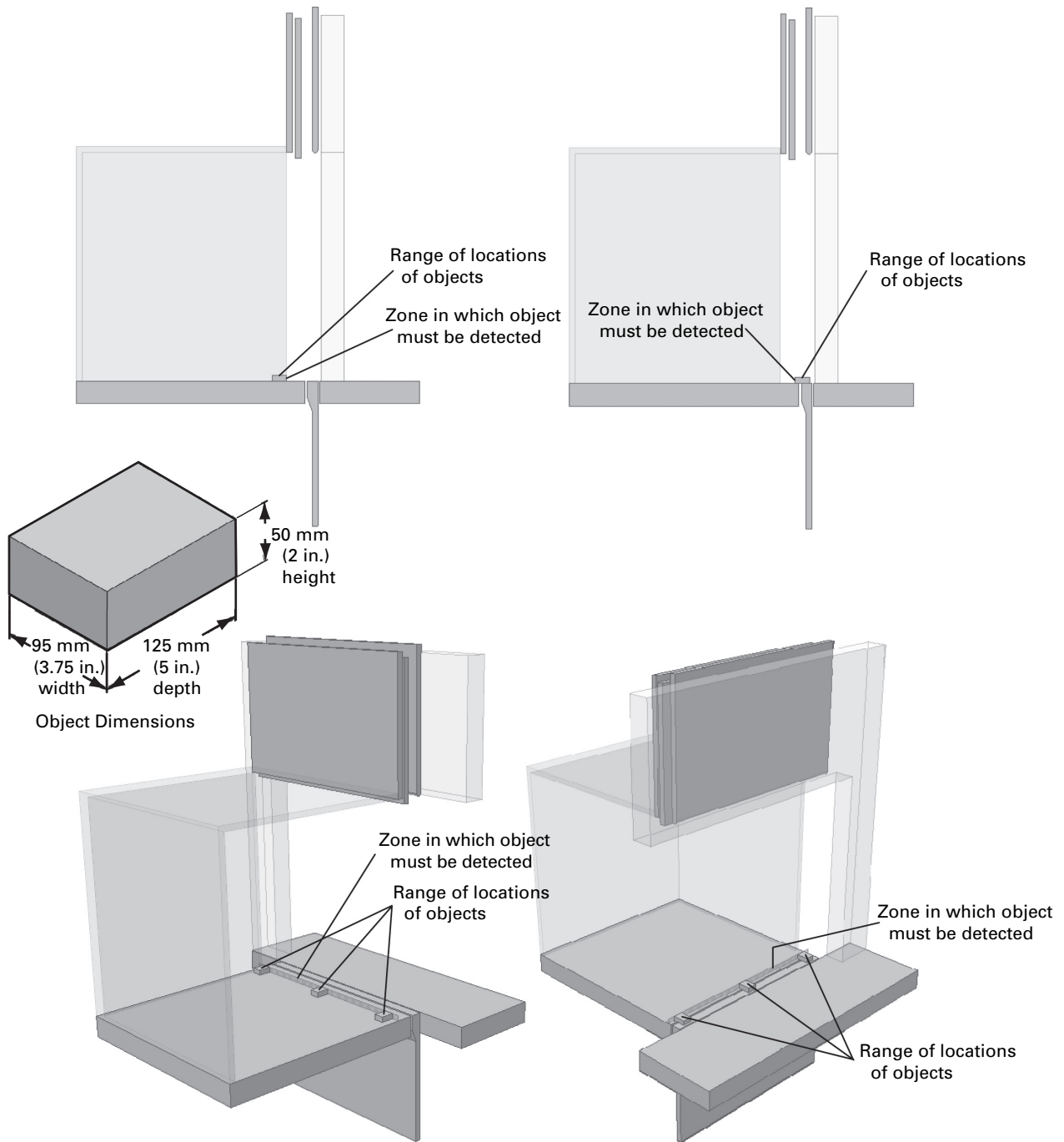
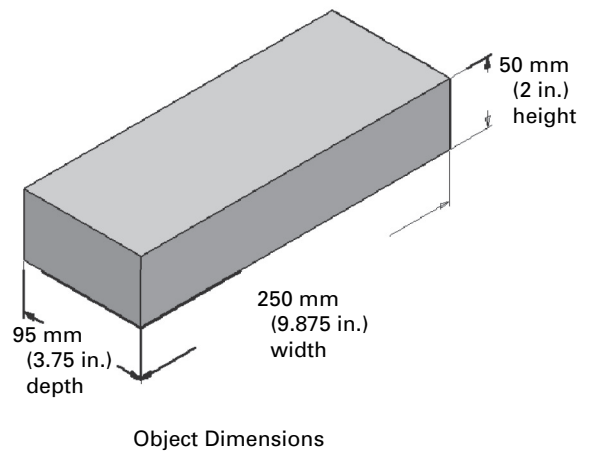
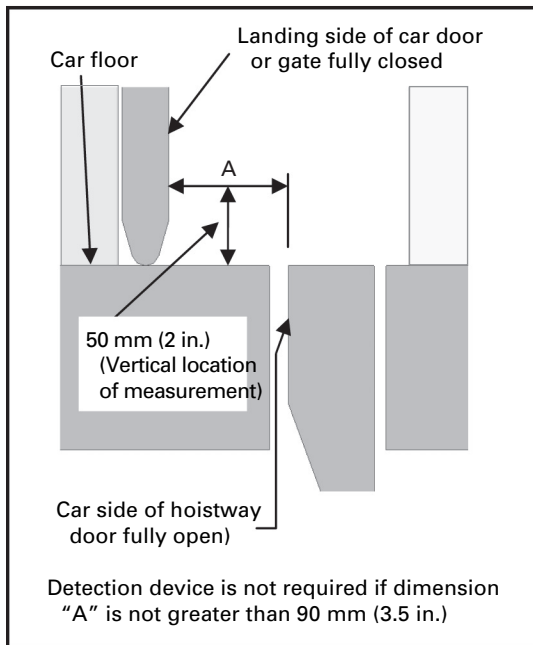
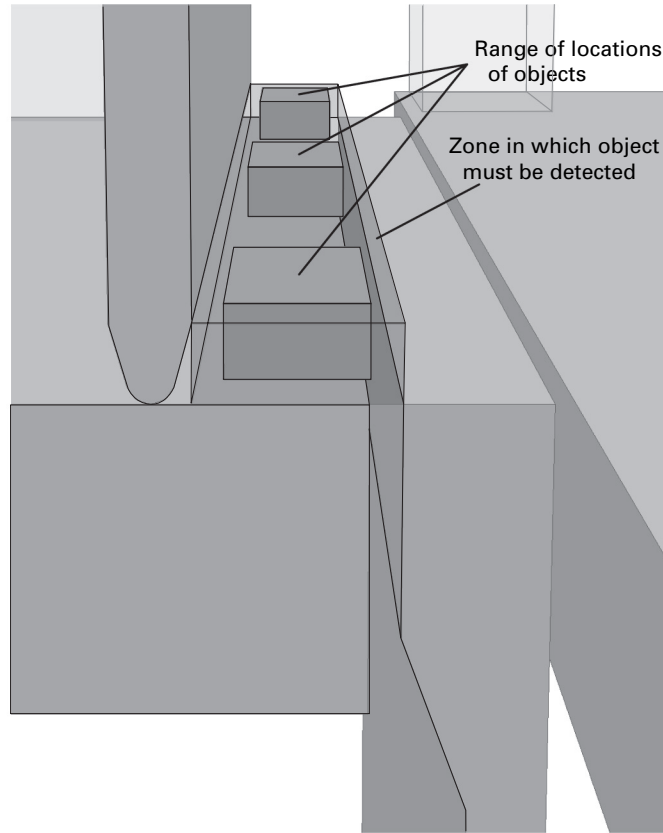

Fig. S-12



NONMANDATORY APPENDIX T INSPECTION AND REPLACEMENT OF STEEL WIRE ROPES

See Fig. T-1 on the following page.

Fig. T-1 Inspection and Replacement of Steel Wire Ropes

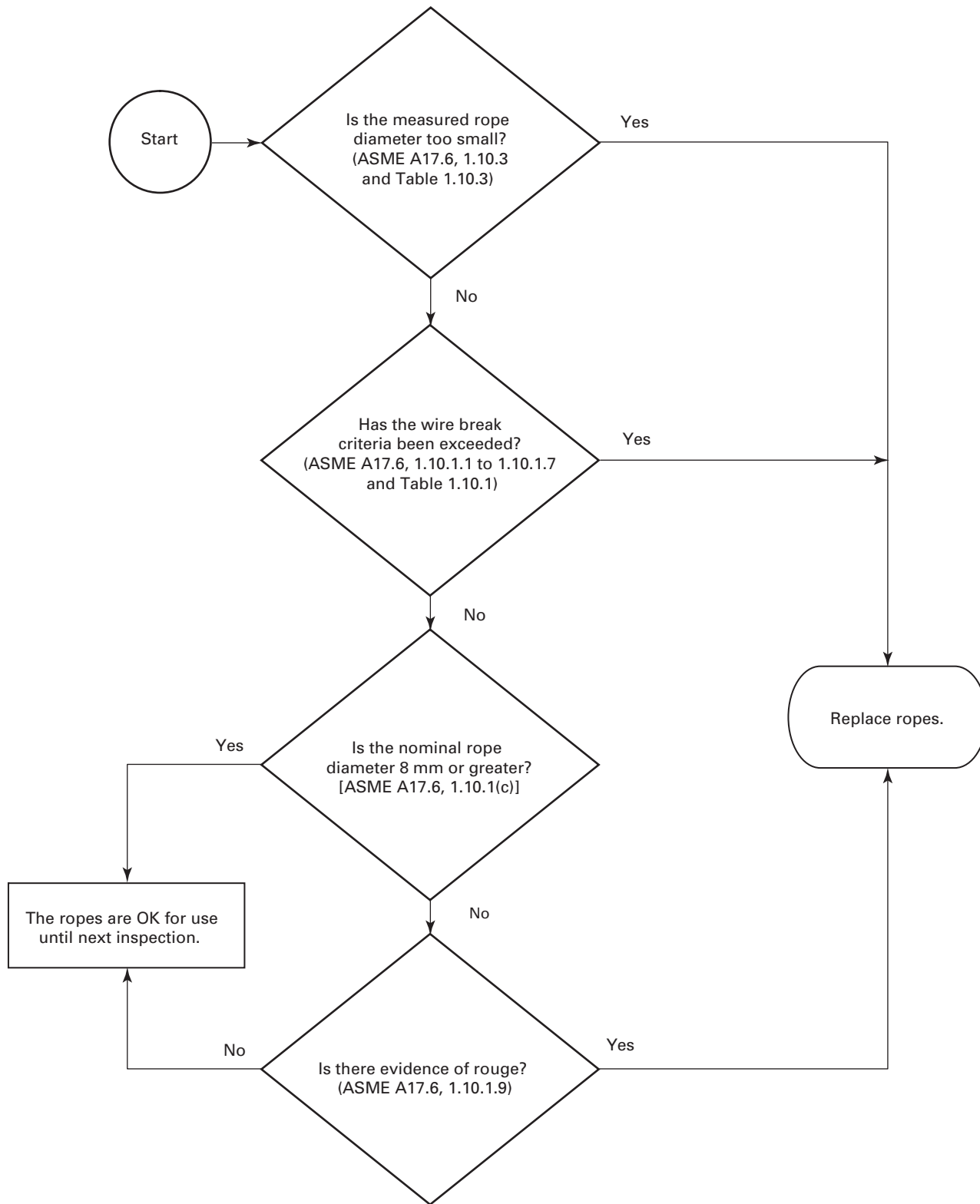

NONMANDATORY APPENDIX U

DESIGN REQUIREMENTS — TRACTION ELEVATOR SUSPENSION SYSTEM

Table U-1 Design Requirements — Traction Elevator Suspension System

| Type | Suspension Diameter, d , or Size | Factor of Safety (FS) (2.20.3) | Traction-Loss Detector and Protection (2.20.8.1) | Broken-Suspension- Member Detector and Protection (2.20.8.2) | Suspension-Member Residual-Strength Detection (2.20.8.3) |
|------|--|--------------------------------------|---|---|---|
| SWR | $d \geq 9.5$ mm | FS \geq Table 2.20.3 | Required | Not required | Not required |
| | 8 mm $\leq d < 9.5$ mm | FS ≥ 12 | Required | Not required | Not required |
| | 4 mm $\leq d < 8$ mm | FS \geq Table 2.20.3 | Required | Required | Not required |
| AFR | Any | FS \geq Table 2.20.3 | Required | Required | Required |
| | | FS \geq BEP | Required | Required | Required |
| CSM | Any | FS \geq Table 2.20.3 | Required | Required | Required |
| | | FS \geq BEP | Required | Required | Required |

GENERAL NOTES:

- (a) AFR = aramid fiber ropes
- (b) BEP = best engineering practice
- (c) CSM = noncircular elastomeric-coated steel suspension members
- (d) SWR = steel wire ropes

NONMANDATORY APPENDIX V

BUILDING FEATURES FOR OCCUPANT EVACUATION OPERATION

(13)

V-1 Human Factors Considerations

Elevator evacuation systems will work most effectively if the components specified reflect state-of-the-art knowledge regarding their performance. Similarly, overall system effectiveness will be maximized if the design incorporates the most up-to-date research on human behavior during emergency evacuation.

Designers should specify system components which reflect the latest research on human factors issues, including the following:

- (a) Floor Wardens
 - (1) will carry out the responsibilities correctly
- (b) Occupant Training
 - (1) will attend initial training sessions
 - (2) will attend ongoing training
- (c) Occupants and Lobby Signage/Voice Notification (SVN)
 - (1) will take the time to observe the SVN
 - (2) will understand the SVN symbols/language
 - (3) will follow the SVN instructions
 - (4) the design of and training on the two-way communication system will ensure correct use
 - (5) will have a workable sense of acceptable wait times in the elevator lobby
 - (6) will make the correct decision regarding using elevators or the stairs
 - (7) if having decided to leave the elevator lobby, will go to the stairway in an orderly manner
- (d) Occupants and Elevators
 - (1) The design of and training on the two-way communication system will ensure correct use.
- (e) Occupants — General
 - (1) will accurately gauge their ability to take the stairs
 - (2) will provide correct assistance to others who cannot use the stairs
 - (3) visitors will follow the lead of trained occupants

V-1.1 Occupant Evacuation Operation. Occupant Evacuation Operation has been designed with the assumption that the following building provisions are in place. If Occupant Evacuation Operation is provided in a building that does not meet these, a hazard analysis (e.g., ISO 14798) should be performed.

(a) The building is a high rise business occupancy (office building) and at the time of permitting conforms

to the latest editions of the building code (IBC, NFPA 5000, or NBCC) and ASME A17.1/CSA B44.

(b) The automatic sprinkler system required by the building code is installed in accordance with NFPA 13 except that sprinklers in elevator machine rooms and hoistways are prohibited.

(c) An emergency voice/alarm communications system meeting the requirements of NFPA 72 is provided to inform occupants on each floor of the current situation and actions to take in an emergency. The announcements should include information about whether or not the elevators are available.

(d) Interior exit stairwell doors automatically unlock, allowing both exit and re-entry, upon any alarm in accordance with the options permitted by the building code.

(e) The elevator lobby at each floor, with the exception of the elevator discharge level, is enclosed and separated from the remainder of the floor by a smoke barrier. The elevator lobby enclosure door has a $\frac{3}{4}$ -hr fire rating and a vision panel, and closes automatically upon initiation of the building fire alarm system. The lobby is large enough to accommodate 25% of the floor population at 3 ft² per person and a minimum of one wheelchair space per 50 occupants with each space minimum 760 mm × 1 220 mm (30 in. × 48 in.). There is direct access from each elevator lobby to an enclosed exit stair. That exit stair enclosure is provided with a second door at each floor that provides access to the floor without requiring travel through the elevator lobby.

(f) The elevator lobbies, at all floors except the elevator discharge level, and hoistways are pressurized together to keep them free of smoke without introducing a pressure differential across the hoistway doors. Active smoke control systems that keep smoke away from the elevators and elevator lobbies are an acceptable alternative. The adjacent exit stair enclosure is separately pressurized.

(g) The building is designed to control the flow of water that accumulates on the floor as a result of sprinkler operation outside the elevator lobby and hoistway. This water is directed to drains or other means, so it does not enter an elevator hoistway from any side.

(h) The building has a fire safety and evacuation plan, approved by the authority having jurisdiction, specifically including procedures for evacuation using stairs and elevators, the roles of fire wardens, a routine training

program and drills for occupants. Training includes the message that elevators should not be used for evacuation in buildings without Occupant Evacuation Operation. The fire safety plan includes the requirement that elevator lobbies and machine rooms be maintained to minimize fire loads.

(i) The elevators designated for Occupant Evacuation Operation, machine room air conditioning, variable message sign(s), voice notification, fire alarm, two-way communication, and pressurization systems are all supplied with standby or emergency power with sufficient

capacity to operate these elevators and these associated systems simultaneously. The standby or emergency power system is minimum Type 60, Class 2, Level 1 in accordance with NFPA 110. The normal power feeders and backup power feeders are separated from each other, and each contained in its own 2-hr fire resistance rated enclosure until they reach the elevator machine room.

(j) A two-way voice communications system is installed, allowing communications between the fire command center and each elevator lobby.

NONMANDATORY APPENDIX W WIND TURBINE TOWER ELEVATOR CLEARANCES

(13)

Fig. W-1

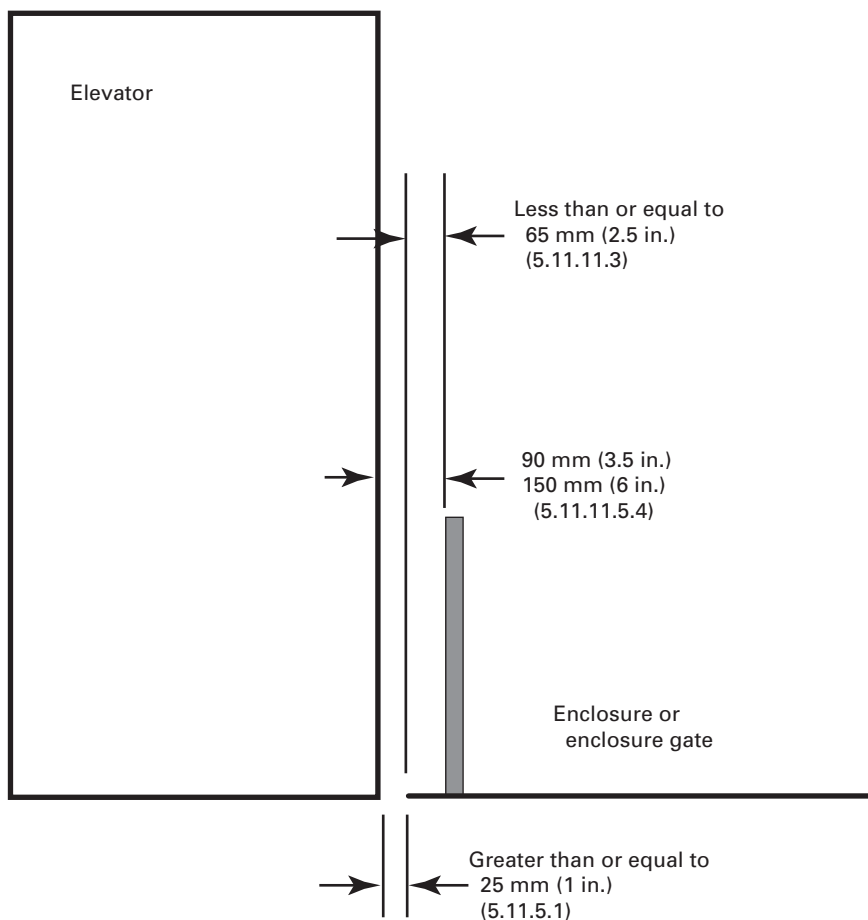

(13)

NONMANDATORY APPENDIX X ACCEPTANCE TESTS

Table X-1 Acceptance Test for Electric Elevators
Acceptance Test: Electric Elevators

Name of Person Performing Test (Print): _____

Name and License Number/Certifying Organization of Inspector (Print): _____

Name of Firm Performing Test: _____

| Devices Tested/Test Requirement | Date | Results of Test |
|--|------|-----------------|
| 1 Door Closing Force — 8.10.2.2.1(h) | | |
| 2 Door Closing Time — 8.10.2.2.1(i) | | |
| 3 Door Opening — 8.10.2.2.1(j)(1) | | |
| 4 Leveling Zone and Speed — 8.10.2.2.1(j)(2) | | |
| 5 Inner Landing Zone — 8.10.2.2.1(j)(3) | | |
| 6 Emergency/Standby Power — 8.10.2.2.1(q) | | |
| 7 Braking System — 8.10.2.2.2(v) | | |
| 8 Winding Drum Machines Slack Rope — 8.10.2.2.2(y)(3) | | |
| 9 Winding Drum Machine Final Terminal Stopping Devices — 8.10.2.2.2(y)(6) | | |
| 10 Emergency Stop — 8.10.2.2.2(cc)(1) | | |
| 11 Traction Limit — 8.10.2.2.2(cc)(3) | | |
| 12 Terminal Stopping Devices — 8.10.2.2.2(ff) | | |
| 13 Governor Overspeed — 8.10.2.2.2(hh) | | |
| 14 Car Safety — 8.10.2.2.2(ii) | | |
| 15 Car Safety Type “A” Inertia Application — 8.10.2.2.2(ii)(2) | | |
| 16 Counterweight Safety — 8.10.2.2.2(ii) | | |
| 17 CWT Safety Type “A” Inertia Application — 8.10.2.2.2(ii)(2) | | |
| 18 Ascending Car Overspeed Protection — 8.10.2.2.2(jj)(1) | | |
| 19 Unintended Car Movement — 8.10.2.2.2(jj)(2) | | |
| 20 Emergency Brake — 8.10.2.2.2(mm) | | |
| 21 AC Drives From DC Sources — 8.10.2.2.2(oo) | | |
| 22 Car Oil Buffer — 8.10.2.2.5(c) | | |
| 23 Counterweight Oil Buffer — 8.10.2.2.5(c) | | |
| 24 Top-of-Car Clearance and Refuge Space — 8.10.2.2.3(d) | | |
| 25 Unexpected Car Movement Device (top of car) — 8.10.2.2.3(ff) | | |
| 26 Unexpected Car Movement Device (pit) — 8.10.2.2.5(l) | | |
| 27 Firefighters’ Emergency Operation (See Checklist in ASME A17.2) — 8.10.2.2.6 | | |
| 28 Seismic and Displacement Switches — 8.10.2.2.2(rr) | | |
| 29 Testing of Broken Suspension and Residual-Strength Detection Means — 8.10.2.2.2(ss) | | |

Table X-2 Acceptance Test for Hydraulic Elevators
Acceptance Test: Hydraulic Elevators

Name of Person Performing Test (Print): _____

Name and License Number/Certifying Organization of Inspector (Print): _____

Name of Firm Performing Test: _____

| Devices Tested/Test Requirement | Date | Results of Test |
|---|------|-----------------|
| 1 Door Closing Force — 8.10.3.2.1(h) | | |
| 2 Door Closing Time — 8.10.3.2.1(i) | | |
| 3 Door Opening — 8.10.3.2.1(j) | | |
| 4 Standby/Emergency Power — 8.10.3.2.1(q)(1) | | |
| 5 Auxiliary Power Lowering (where provided) — 8.10.3.2.1(q)(2) | | |
| 6 Low Oil Protection — 8.10.3.2.2(s)(7) | | |
| 7 Reverse Phase Protection — 8.10.3.2.2(s)(6) | | |
| 8 Working Pressure Verification — 8.10.3.2.2(t) | | |
| 9 Relief Valve Setting — 8.10.3.2.2(u) | | |
| 10 Supply Line and Shutoff Valves — 8.10.3.2.2(y) | | |
| 11 Terminal Speed-Reducing Device — 8.10.3.2.3(f) | | |
| 12 Terminal Stopping Devices — 8.10.3.2.3(e) | | |
| 13 Governor Overspeed — 8.10.3.2.2(ff) | | |
| 14 Safety — 8.10.3.2.5(j) | | |
| 15 Safety Inertia Application — 8.10.3.2.3(dd) | | |
| 16 Hydraulic Cylinder Plunger Stop — 8.10.3.2.2(z) | | |
| 17 Pressure Switch (Cylinder Top Above Tank) — 8.10.3.2.2(aa) | | |
| 18 Recycle Operation (Multiple or Telescopic Plungers) — 8.10.3.2.2(bb) | | |
| 19 Static Controls — [3.25.2.4.2(b)], 8.10.3.2.2(cc) | | |
| 20 Normal Terminal Stopping Devices — 8.10.3.2.3(e), 8.10.3.2.5(e) | | |
| 21 Operating Devices — 8.10.3.2.2(ee) | | |
| 22 Class C2 Freight Elevators — 8.10.3.2.2(hh) | | |
| 23 Top-of-Car Clearance, Refuge Space, and Runby — 8.10.3.2.3(d) | | |
| 24 Overspeed Valve — 8.10.3.2.5(o) | | |
| 25 Plunger Clearance Bottom of Cylinder — 8.10.3.2.5(c)(3)(a) | | |
| 26 Plunger Gripper — 8.10.3.2.5(n) | | |
| 27 Bottom Clearance, Refuge Space, and Runby — 8.10.3.2.5(b) | | |
| 28 Car Leveling and Anticreep Operation — 8.10.3.2.3(g) | | |
| 29 Unexpected Movement — See 2.26.2.34 and 2.7.5.1.1, 8.10.3.2.3(ff) | | |
| 30 Firefighters' Emergency Operation (See Checklist in ASME A17.2) — 8.10.3.2.6 | | |

Table X-3 Acceptance Test for Escalators
Acceptance Test: Escalators

Name of Person Performing Test (Print): _____

Name and License Number/Certifying Organization of Inspector (Print): _____

Name of Firm Performing Test: _____

| Devices Tested/Test Requirement | Date | Results of Test |
|--|------|-----------------|
| 1 Machine Space Access — 8.10.4.1.2(a) | | |
| 2 Machine Space Stop Switch — 8.10.4.1.2(b) | | |
| 3 Control Wiring and Fuses — 8.10.4.1.2(c) | | |
| 4 Driving Machine and Brake Torque Test — 8.10.4.1.2(d) | | |
| 5 Speed Governor — 8.10.4.1.2(e) | | |
| 6 Broken Drive Chain Device — 8.10.4.1.2(f) | | |
| 7 Reversal Stop Device — 8.10.4.1.2(g) | | |
| 8 Broken Step Chain/Treadway Device — 8.10.4.1.2(h) | | |
| 9 Step Upthrust Device — 8.10.4.1.2(i) | | |
| 10 Missing Step/Pallet Device — 8.10.4.1.2(j) | | |
| 11 Step/Pallet Level Device — 8.10.4.1.2(k) | | |
| 12 Steps, Pallet Chain, and Trusses — 8.10.4.1.2(l) | | |
| 13 Handrail Speed Monitoring Device — 8.10.4.1.2(m) | | |
| 14 Handrail Entry Device — 8.10.4.1.1(k) | | |
| 15 Egress Restriction — 8.10.4.1.1(l) | | |
| 16 Heaters Outdoor Units — 8.10.4.1.2(o) | | |
| 17 Permissible Stretch of Step Chain — 8.10.4.1.2(a) | | |
| 18 Disconnected Motor Device — 8.10.4.1.2(n) | | |
| 19 Response to Smoke Detectors — 8.10.4.1.2(v) | | |
| 20 Comb-Step/Comb-Pallet Impact Device — 8.10.4.1.2(q) | | |
| 21 Step/Skirt Performance Index — 8.10.4.1.2(t) | | |
| 22 Clearance Between Step and Skirt (Loaded Gap) — 8.10.4.1.1(p) | | |
| 23 Inspection Controls — 8.10.4.1.2(u) | | |
| 24 Step Lateral Displacement Device, Curved Escalators — 8.10.4.1.2(r) | | |
| 25 Tandem Operation — 8.10.4.1.1(j) | | |

Table X-4 Acceptance Test for Moving Walks
Acceptance Test: Moving Walks

Name of Person Performing Test (Print): _____

Name and License Number/Certifying Organization of Inspector (Print): _____

Name of Firm Performing Test: _____

| Devices Tested/Test Requirement | Date | Results of Test |
|---|------|-----------------|
| 1 Machine Space Access — 8.10.4.1.2(a) | | |
| 2 Machine Space Stop Switch — 8.10.4.1.2(b) | | |
| 3 Control Wiring and Fuses — 8.10.4.1.2(c) | | |
| 4 Driving Machine and Brake Torque Test — 8.10.4.1.2(d) | | |
| 5 Speed Governor — 8.10.4.1.2(e) | | |
| 6 Broken Drive Chain Device — 8.10.4.1.2(f) | | |
| 7 Reversal Stop Device — 8.10.4.1.2(g) | | |
| 8 Broken Treadway Device — 8.10.4.1.2(h) | | |
| 9 Missing Pallet Device — 8.10.4.1.2(j) | | |
| 10 Pallet Level Device — 8.10.4.1.2(k) | | |
| 11 Pallet Chain and Trusses — 8.10.4.1.2(l) | | |
| 12 Handrail Speed Monitoring Device — 8.10.4.1.2(m) | | |
| 13 Handrail Entry Device — 8.10.4.1.1(k) | | |
| 14 Walk Egress Restriction Device — 8.10.4.1.1(l) | | |
| 15 Heaters Outdoor Units — 8.10.4.1.2(o) | | |
| 16 Permissible Stretch of Step Chain — 8.10.4.1.2(a) | | |
| 17 Disconnected Motor Device — 8.10.4.1.2(n) | | |
| 18 Response to Smoke Detectors — 8.10.4.1.2(v) | | |
| 19 Comb-Step/Comb-Pallet Impact Device — 8.10.4.1.2(q) | | |
| 20 Inspection Controls — 8.10.4.1.2(u) | | |
| 21 Tandem Operation — 8.10.4.1.1(j) | | |

(13)

NONMANDATORY APPENDIX Y MAINTENANCE CONTROL PROGRAM RECORDS

Fig. Y-1 Maintenance Control Program Records

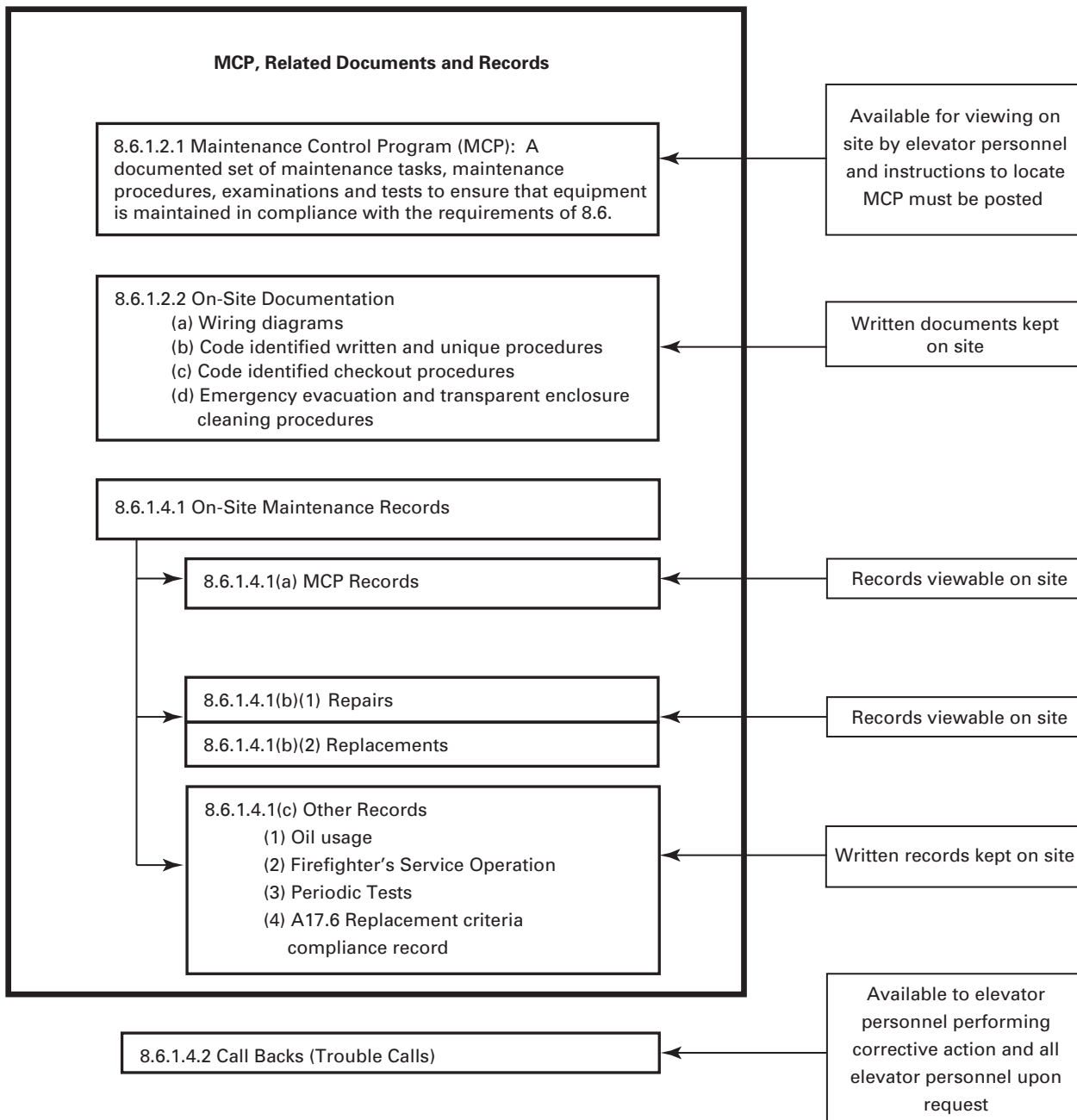

Table Y-1 Maintenance Control Program Records

| Building Name: Building Address: | | Conveyance I.D.: | | | | | | | | | | | |
|---|---|------------------|----------|-------|-------|-----|------|------|--------|-----------|---------|----------|----------|
| | | Y | R | 2 | 0 | — | — | — | — | — | — | — | — |
| | | January | February | March | April | May | June | July | August | September | October | November | December |
| INSIDE CAR | | | | | | | | | | | | | |
| EXAMPLE OF QUARTERLY SCHEDULING | * | * | | * | * | | * | * | | | * | | |
| EXAMPLE OF MONTHLY SCHEDULING | * | * | * | * | * | * | * | * | * | * | * | * | * |
| 8.6.4.13(b) car door electric contacts or car door interlocks, where required | | | | | | | | | | | | | |
| 8.6.4.13(c) door reopening devices | | | | | | | | | | | | | |
| CAR TOP | | | | | | | | | | | | | |
| 8.6.4.9 Cleaning of Top of Cars | | | | | | | | | | | | | |
| 8.6.4.1 Suspension and Compensating Means | | | | | | | | | | | | | |
| | | | | | | | | | | | | | |
| | | | | | | | | | | | | | |
| 8.6.4.7 Cleaning of Hoistways | | | | | | | | | | | | | |
| | | | | | | | | | | | | | |
| MACHINE ROOM/SPACE | | | | | | | | | | | | | |
| 8.6.4.6 Brakes Including Emergency Brakes | | | | | | | | | | | | | |
| 8.6.4.8 Cleaning and Condition of Machine/Control Rooms | | | | | | | | | | | | | |
| | | | | | | | | | | | | | |
| | | | | | | | | | | | | | |
| OUTSIDE HOISTWAY | | | | | | | | | | | | | |
| 8.6.4.13(d) vision panels and grilles, where required | | | | | | | | | | | | | |
| | | | | | | | | | | | | | |

A symbol such as (*) shall be in each cell to indicate month task is due. Initials and date indicates specified task is completed (other designs may be acceptable, as long as you indicate month task is due and that task was performed by a qualified person).

INDEX

References given are to the Part, Section, Requirement, Table, Figure, and Appendix designations.

- Absorption of regenerated power, 2.26.10
 - inspection and test of, 8.10.2.2.2(bb)
- Accelerating moving walk, Nonmandatory
 - Appendix I
- Acceptance Inspection and test (*see also* Inspection and test)
- Access door
 - escalator, 6.1.7.3
 - moving walk, 6.2.7.3
- Access panel in car, 2.14.2.2
- Access plate
 - escalator, 6.1.7.3
 - moving walk, 6.2.7.3
- Access switch, hoistway, 2.12.7
- Access to hoistway (*see* Hoistway, access to)
- Access to machine room (*see* Machine room, access to)
- Access to pit (*see* Pit, access to)
- Adjustable shackle rod, 2.20.9.2
- Air conditioning equipment (*see* Machine room, air conditioning equipment)
- Alteration
 - definition of, Section 1.3
 - electric elevator, hoistway, 8.7.2
 - electric elevator, inspection, 8.10.2.3.2
 - hydraulic elevator, 8.7.3
 - hydraulic elevator, inspection, 8.10.3.3.2
- Alternate level, 2.27.3.2
- Amusement device, 1.1.2
- Angle of inclination
 - escalator, 6.1.3.1
 - moving walk, 6.2.3.1
- Annual inspection and test (*see* Periodic inspection and test)
- Annunciator, car
 - definition of, Section 1.3
- Anticreep leveling device, 3.26.3
 - private residence elevator, hydraulic, 5.3.2.3
 - dumbwaiter, 7.3.11.3
- Antirotation device, 2.20.9.8
- Antislid device, escalator, 6.1.3.3.10
- Application of driving machine brake, 2.26.8
- Applied frame entrance
 - definition of, Section 1.3
- Approved
 - definition of, Section 1.3
- Apron, 2.15.9
- Atmosphere storage and discharge tank, 3.24.3
- Audible signaling device, 2.27.1
- Authorized personnel
 - definition of, Section 1.3
- Automatic fire door, 2.11.6.3
- Automatic recall, 2.27.3.1
- Automatic transfer device, 7.7
 - addition of, 8.7.7.2
 - definition of, Section 1.3
 - dumbwaiter with, 7.8
 - material lift with, 7.9, 7.10
 - obscured, 7.10
- Automobile loading, 2.16.2.2
- Auxiliary power, 2.14.2.3.2(b)
- Auxiliary power, lighting, 2.14.7.1
- Auxiliary rope-fastening device, 2.20.10
 - definition of (rope fastening device, auxiliary), Section 1.3
- Babbiting, 2.20.9.6
- Baggage stop, escalator, 6.1.3.3.10
- Balustrade
 - diagrams and nomenclature, Nonmandatory Appendix I
 - escalator, 6.1.3.3
 - moving walk, 6.2.3.3
- Barricade, escalator deck, 6.1.3.3.11
- Beam, machinery and sheave
 - dumbwaiter, 7.1.9
 - earthquake protection, 8.4.2
 - electric elevator, 2.9
 - elevator used for construction, 5.10.1.8
 - hand elevator, 4.3.5
 - hydraulic elevator, 3.9
 - inclined elevator, 5.1.1.2
 - limited-use/limited-application elevator, 5.2.1.9
 - material lift with automatic transfer device, 7.9.1
 - private residence elevator, 5.3.1.16.1
 - rack-and-pinion elevator, 4.1.4
 - rooftop elevator, 5.1.6.9
 - screw-column elevator, 4.2.7
 - sidewalk elevator, 5.5.1.9
 - special purpose personnel elevator, 5.7.7
- Belt, replacement of, 8.6.3.5

- Belt drive
 - dumbwaiter, 7.2.10.4
 - electric elevator, 2.24.9
 - escalator, 6.1.5.1
 - moving walk, 6.2.3.14
- Belt type treadway, moving walk, 6.2.3.6
- Blind hoistway, 2.11.1.1, 2.11.1.2
- Bolt, guide rail, 2.23.10
- Bottom car clearance (*see* Clearance, bottom car)
- Bottom runby (*see* Runby, bottom)
- Bow iron
 - rooftop elevator, 5.6.1.15.2
 - sidewalk elevator, 5.5.1.15.2
- Bracket, guide rail (*see* Guide-rail bracket)
- Brake
 - dumbwaiter, 7.2.10
 - electric elevator, 2.24.8.3
 - elevator used for construction, 5.10.1.20.7
 - escalator, 6.1.5.3
 - hand elevator, 4.3.19.2
 - inclined elevator, 5.1.1.2
 - limited-use/limited-application elevator, 5.2.1.24
 - material lift with automatic transfer device, 7.9.2
 - moving walk, 6.2.5.3
 - private residence elevator, 5.3.1.16.2(h)
 - rooftop elevator, 5.6.1.23
 - screw-column elevator, 4.2.15
 - shipboard elevator, 5.8.1.7
 - sidewalk elevator, 5.5.1.23
 - special purpose personnel elevator, 5.7.18.7
- Brake, application of
 - electric elevator, 2.26.8
- Brake, five-year inspection and test of, 8.11.2.3.4
- Broken drive-chain device
 - escalator, 6.1.6.3.4
 - moving walk, 6.2.6.3.4
- Broken rope, tape, or chain switch, 2.26.2
- Broken step-chain device, escalator, 6.1.6.3.3
- Broken treadway device, moving walk, 6.2.6.3.3
- Buffer
 - definition of, Section 1.3
 - dumbwaiter, electric, 7.2.8
 - dumbwaiter, hydraulic, 7.3.8.1
 - electric elevator, 2.22
 - elevator used for construction, 5.10.1.18
 - hydraulic elevator, 3.22.1
 - inclined elevator, 5.1.1.7
 - inclined elevator, end loading, 5.1.22.3
 - limited-use/limited-application elevator, electric, 5.2.1.22
 - limited-use/limited-application elevator, hydraulic, 5.2.2.3
 - private residence elevator, 5.3.1.14
 - rack-and-pinion elevator, 4.1.11
 - rooftop elevator, electric, 5.6.1.21
 - rooftop elevator, hydraulic, 5.6.2.13
 - screw-column elevator, 4.2.5
 - shipboard elevator, 5.8.1
 - sidewalk elevator, electric, 5.5.1.21
 - sidewalk elevator, hydraulic, 5.5.2.13
 - special purpose personnel elevator, 5.7.16
- Buffer, inspection and test of
 - acceptance, 8.10.2.2.5(c)
 - annual, 8.11.2.2.1
 - five-year, 8.11.2.3.3
 - type test, 8.3.2
- Buffer support, 2.6
- Buffer support, impact on, 8.2.3
- Buffer switch, 2.26.2
- Building code
 - definition of, Section 1.3
 - list of, Part 9
- Building structure (*see* Hoistway enclosure)
- Bulkhead, safety, 3.18.3.4
 - definition of (safety bulkhead), Section 1.3
- Bumper (*see also* Buffer), 2.22.2
 - definition of, Section 1.3
 - where permitted, 2.22.1.1
- Cable (*see* Suspension means)
- Capacitor
 - electric elevator, 2.26.7
 - escalator, 6.1.6.12
 - moving walk, 6.2.6.11
- Capacity (*see* Rated load)
- Capacity plate (*see also* Data plate and Marking plate)
 - dumbwaiter, 7.2.3.2
 - electric elevator, 2.16.3
 - elevator used for construction, 5.10.1.23
 - freight elevator, 2.16.5
 - hand elevator, 4.3.14.2
 - hydraulic elevator, 3.16
 - inclined elevator, 5.1.1.2
 - limited-use/limited-application elevator, 5.2.1.16.2
 - material lift with automatic transfer device, 7.9.2
 - private residence elevator, 5.3.1.20.1
 - rack-and-pinion elevator, 4.1.8
 - rooftop elevator, 5.6.1.16
 - screw-column elevator, 4.2.10
 - shipboard elevator, 5.8.1
 - sidewalk elevator, 5.5.1.16
 - special purpose personnel elevator, 5.7.12.1
- Car, elevator
 - definition of, Section 1.3
- Car, material lift
 - definition of, Section 1.3
- Car clearance, bottom (*see* Clearance, bottom car)
- Car clearance, horizontal (*see also* Clearance, horizontal), 2.5
 - deflection of car enclosure, 2.14.1.3
- Car clearance, top (*see* Clearance, top car)
- Car counterweight, independent, 2.21.1.4

- Car door [*see also* Door (car or hoistway)]
 - material for, 2.14.4.3
 - vertically sliding, 2.14.4.7
 - vertically sliding, freight, 2.14.6.2
 - vertically sliding, passenger, 2.14.5.3
- Car door operation (*see* Hoistway door operation)
- Car door or gate
 - dumbwaiter, electric, 7.2.1.2
 - dumbwaiter, hydraulic, 7.3.1
 - electric elevator, 2.14
 - elevator used for construction, 5.10.1.10.8
 - hydraulic elevator, 3.14
 - limited-use/limited-application elevator, electric, 5.2.1.14
 - limited-use/limited-application elevator, hydraulic, 5.2.2.4
 - material lift with automatic transfer device, 7.9.2
 - private residence elevator, 5.3.1.8.2
 - rack-and-pinion elevator, 4.1.6
 - rooftop elevator, electric, 5.6.1.14
 - rooftop elevator, hydraulic, 5.6.2.6
 - screw-column elevator, 4.2.8
 - shipboard elevator, 5.8.1
 - sidewalk elevator, electric, 5.5.1.14.2
 - sidewalk elevator, hydraulic, 5.5.2.12
 - special purpose personnel elevator, 5.7.10.5
- Car door or gate, closed position, 2.14.4.11
- Car door or gate, freight, 2.14.6
- Car door or gate, general requirements, 2.14.4
- Car door or gate, kinetic energy and force limitations, 2.13.4
- Car door or gate, location of, 2.14.4.5
- Car door or gate, passenger, 2.14.5
- Car door or gate, power-closed
 - definition of, Section 1.3
- Car door or gate, power opening of, 2.13.2.1
- Car door or gate, restricted opening of, 2.14.5.7
- Car door or gate, sequence operation, 2.13.6
- Car door or gate, strength of, 2.14.4.6
- Car door or gate electric contact, 2.14.4.2
 - approval of, 2.12.6.2
 - definition of, Section 1.3
 - design requirements, 2.12.3.4
 - labeling, 2.12.4.3
 - location of, 2.12.3.5
 - type test of, 8.3.3
- Car door or gate power closer
 - definition of, Section 1.3
- Car door or gate reopening device, 2.13.5
- Car enclosure
 - definition of, Section 1.3
 - dumbwaiter, electric, 7.2.1.1
 - dumbwaiter, hydraulic, 7.3.1
 - electric elevator, 2.14
 - elevator used for construction, 5.10.1.10
 - hand elevator, 4.3.9
 - hydraulic elevator, 3.14
 - inclined elevator, 5.1.1.2
 - limited-use/limited-application elevator, electric, 5.2.1.14
 - limited-use/limited-application elevator, hydraulic, 5.2.2.4
 - material lift with automatic transfer device, 7.9.2
 - private residence elevator, 5.3.1.8.1
 - rack-and-pinion elevator, 4.1.6
 - rooftop elevator, electric, 5.6.1.14
 - rooftop elevator, hydraulic, 5.6.2.6
 - screw-column elevator, 4.2.8
 - shipboard elevator, 5.8.1
 - sidewalk elevator, electric, 5.5.1.14.1
 - sidewalk elevator, hydraulic, 5.5.2.6
 - special purpose personnel elevator, 5.7.10
- Car enclosure, freight, 2.14.3
- Car enclosure, general requirements, 2.14.1
- Car enclosure, passenger, 2.14.2
- Car enclosure material
 - freight elevator, 2.14.3.1
 - passenger elevator, 2.14.2.1
- Car enclosure top, 2.14.1.6
 - equipment prohibited on, 2.14.1.7
 - inclined elevator, 5.1.11.2
 - maintenance of, 8.6.4.9
- Car floor (*see* Car platform)
- Car frame
 - definition of, Section 1.3
 - dumbwaiter, electric, 7.2.2
 - dumbwaiter, hydraulic, 7.3.2
 - earthquake protection, 8.4.5
 - electric elevator, 2.15
 - elevator used for construction, 5.10.1.11
 - hand elevator, 4.3.11
 - hydraulic elevator, 3.15
 - inclined elevator, 5.1.12.1
 - limited-use/limited-application elevator, 5.2.1.15
 - material lift with automatic transfer device, 7.9.2
 - private residence elevator, 5.3.1.9.1
 - rack-and-pinion elevator, 4.1.7
 - rooftop elevator, electric, 5.6.1.5
 - rooftop elevator, hydraulic, 5.6.2.6
 - screw-column elevator, 4.2.9
 - shipboard elevator, 5.8.1
 - sidewalk elevator, electric, 5.5.1.15
 - sidewalk elevator, hydraulic, 5.5.2.7
 - special purpose personnel elevator, 5.7.11
- Car frame, design data and formulas
 - electric elevator, 8.2.2
 - hydraulic elevator, 8.2.9
- Car gate (*see also* Car door or gate)
 - definition of, Section 1.3
 - type permitted, 2.14.4.4
 - vertically sliding, 2.14.4.7
 - vertically sliding, freight, 2.14.6.2

- vertically sliding, passenger, 2.14.5.3
- Car leveling device (*see* Leveling device)
- Car lighting (*see* Lighting, car)
- Car platform
 - definition of, Section 1.3
 - dumbwaiter, electric, 7.2.2
 - dumbwaiter, hydraulic, 7.3.2
 - electric elevator, 2.15
 - elevator used for construction, 5.10.1.11
 - hand elevator, 4.3.11
 - hydraulic elevator, 3.15
 - inclined elevator, 5.1.12.1
 - limited-use/limited-application elevator, 5.2.1.15
 - material lift with automatic transfer device, 7.9.2
 - private residence elevator, 5.3.1.9.1
 - rack-and-pinion elevator, 4.1.7
 - rooftop elevator, electric, 5.6.1.15
 - rooftop elevator, hydraulic, 5.6.2.7
 - screw-column elevator, 4.2.9
 - shipboard elevator, 5.8.1
 - sidewalk elevator, electric, 5.5.1.15
 - sidewalk elevator, hydraulic, 5.5.2.7
 - special purpose personnel elevator, 5.7.11
- Car platform, design data and formulas
 - electric elevator, 8.2.2
 - hydraulic elevator, 8.2.9
- Car platform, laminated
 - definition of, Section 1.3
- Car platform area
 - dumbwaiter, 7.2.3.1
 - inside net, 2.16.1.1
 - reduction of, 2.16.1.2
 - special purpose personnel elevator, 5.7.12.2
- Car platform frame
 - definition of, Section 1.3
- Car platform guard, 2.15.9
- Car safety (*see* Safeties)
- Car safety mechanism
 - maintenance of, 8.6.4.5
 - switch, 2.18.4
- Car sill (*see* Platform sill)
- Car top (*see* Car enclosure top)
- Carpeting on car enclosure walls, 2.14.2.1
 - test of, 8.3.7
- Carrying of one piece loads, 2.16.7
- Cart lift (*see* Material lift with automatic transfer device)
- Caution sign
 - escalator, 6.1.6.9
 - moving walk, 6.2.6.9
- Ceiling intersection guard
 - escalator, 6.1.3.3.11
 - moving walk, 6.2.3.3.7
- Ceramic permanent magnet
 - definition of, Section 1.3
 - escalator brake, 6.1.5.3
- Chain (*see also* Suspension means)
 - dumbwaiter, 7.2.6
 - escalator, 6.1.3.11
 - moving walk, 6.2.3.12
- Chain, compensating (*see* Compensating rope and chain)
- Chain, replacement of, 8.6.2
- Chain drive, electric elevator, 2.24.9
- Check valve, 3.19.3.3
- Circuit, control and operating
 - electric elevator, 2.26.9
 - escalator, 6.1.6.10
 - moving walk, 6.2.6.9
- Class A loading, 2.16.2.2
- Class B loading, 2.16.2.2
- Class C loading, 2.16.2.2
- Clearance, bottom car
 - definition of, Section 1.3
 - dumbwaiter, 7.1.4
 - electric elevator, 2.4.1
 - hydraulic elevator, 3.4.1
 - inclined elevator, 5.1.5.1
 - limited-use/limited-application elevator, electric, 5.2.1.4.1
 - limited-use/limited-application elevator, hydraulic, 5.2.2.2
 - material lift with automatic transfer device, 7.9.1
 - rack-and-pinion elevator, 4.1.1
 - rooftop elevator, electric, 5.6.1.4
 - rooftop elevator, hydraulic, 5.6.2.2
 - screw-column elevator, 4.2.2.1
 - shipboard elevator, 5.8.1
 - sidewalk elevator, electric, 5.5.1.4
 - sidewalk elevator, hydraulic, 5.5.2.2
- Clearance, horizontal
 - dumbwaiter, 7.1.5
 - earthquake protection, 8.4.1
 - electric elevator, 2.5
 - elevator used for construction, 5.10.1.5
 - hydraulic elevator, 3.5
 - limited-use/limited-application elevator, 5.2.15
 - material lift with automatic transfer device, 7.9.1
 - private residence elevator, 5.3.1.4
 - rack-and-pinion elevator, 4.1.1
 - rooftop elevator, 5.6.1.5
 - screw-column elevator, 4.2.3
 - shipboard elevator, 5.8.1
 - sidewalk elevator, 5.5.1.5
 - special purpose personnel elevator, 5.7.5
- Clearance, horizontal, deflection of car enclosure, 2.14.1.3
- Clearance, machine room, 2.7.4
- Clearance, top car
 - definition of, Section 1.3
 - dumbwaiter, 7.1.4
 - electric elevator, counterweighted, 2.4.6

- electric elevator, uncounterweighted, 2.4.7
- hand elevator, 4.3.3
- hydraulic elevator, 3.4.4
- inclined elevator, 5.1.5.2
- limited-use/limited-application elevator, electric, 5.2.1.4.3
- limited-use/limited-application elevator, hydraulic, 5.2.2.2
- material lift with automatic transfer device, 7.9.1
- private residence elevator, 5.3.1.3
- rack-and-pinion elevator, 4.1.1
- rooftop elevator, electric, 5.6.1.4
- rooftop elevator, hydraulic, 5.6.2.2
- screw-column elevator, 4.2.2.3
- shipboard elevator, 5.8.1
- sidewalk elevator, electric, 5.5.1.4
- sidewalk elevator, hydraulic, 5.5.2.2
- special purpose personnel elevator, 5.7.4.2
- Clearance, top counterweight
 - definition of, Section 1.3
 - dumbwaiter, 7.1.4
 - electric elevator, 2.4.9
 - hydraulic elevator, 3.4.6
 - material lift with automatic transfer device, 7.9.1
 - rooftop elevator, 5.6.1.4
 - shipboard elevator, 5.8.1
 - sidewalk elevator, 5.5.1.4
- Clearance between balustrade and treadway
 - balustrades with skirt panels, 6.2.3.3.6
 - skirtless balustrades, 6.2.3.3.5
- Closed position, car doors or gates, 2.14.4.11
- Closing of hoistway door, 2.11.3
- Code, reference, Part 9
- Code data plate
 - dumbwaiter, electric, Section 8.9
 - dumbwaiter, hydraulic, Section 8.9
 - electric elevator, Section 8.9
 - escalator, Section 8.9
 - hand elevator, Section 8.9
 - hydraulic elevator, Section 8.9
 - moving walk, Section 8.9
 - private residence elevator, Section 8.9
 - rack-and-pinion elevator, Section 8.9
 - rooftop elevator, Section 8.9
 - screw-column elevator, Section 8.9
 - sidewalk elevator, electric, Section 8.9
 - sidewalk elevator, hydraulic, Section 8.9
 - special purpose personnel elevator, Section 8.9
- Comb-pallet impact device, moving walk, 6.2.6.3.11
- Comb-step impact device, escalator, 6.1.6.3.13
- Combination horizontal slide and swing type entrance, 2.11.13.5
- Combplate
 - escalator, 6.1.3.6.1
 - moving walk, 6.2.3.8.1
- Communication, 2.27.1
- Compensating rope and chain
 - attachment to counterweight, 2.21.4
 - earthquake protection, 8.4.6.1
 - sheave switch, definition of, Section 1.3
 - switch, 2.26.2
 - tie-down, 2.21.4.2
- Component rated pressure
 - definition of, Section 1.3
- Construction elevator, 5.10
- Control, motion
 - definition of, Section 1.3
- Control, operation
 - definition of, Section 1.3
- Control system
 - definition of, Section 1.3
- Control and operating circuit
 - electric elevator, 2.26.9
 - hydraulic elevator, 3.26.6
- Control equipment
 - dumbwaiter, electric, 7.2.12
 - dumbwaiter, hydraulic, 7.3.11
 - electric elevator, 2.26
 - elevator used for construction, 5.10.1.21
 - hydraulic elevator, 3.26
 - inclined elevator, 5.1.20
 - limited-use/limited-application elevator, 5.2.1.26
 - material lift with automatic transfer device, 7.9.2
 - private residence elevator, 5.3.1.18
 - rack-and-pinion elevator, 4.1.15.1
 - rooftop elevator, electric, 5.6.1.25
 - rooftop elevator, hydraulic, 5.6.2.17
 - screw-column elevator, 4.2.17
 - shipboard elevator, 5.8.1
 - sidewalk elevator, electric, 5.5.1.25
 - sidewalk elevator, hydraulic, 5.5.2.17.1
 - special purpose personnel elevator, 5.7.19
- Control of smoke and hot gases, 2.1.4
- Control room (*see* Machine room)
- Control valves, hydraulic
 - test requirements, 8.3.5
- Controller
 - definition of, Section 1.3
 - electric elevator, 8.7.2.27.4
 - guarding of, 2.10
 - hydraulic elevator, 8.7.3.31.5
 - maintenance of, 8.6.1.6.3
- Controller, motion
 - definition of, Section 1.3
- Controller, motor
 - definition of, Section 1.3
- Controller, operation
 - definition of, Section 1.3
- Conveyor, 1.1.2
- Corrosion protection
 - hydraulic elevator cylinder, 3.18.3.8
 - hydraulic elevator piping, 3.19.5

- Counterbalancing of cars, 2.21.3
- Counterweight
 - dumbwaiter, electric, 7.2.7
 - dumbwaiter, hydraulic, 7.3.7
 - earthquake protection, 8.4.7
 - electric elevator, 2.21
 - elevator used for construction, 5.10.1.17
 - hand elevator, 4.3.17
 - hydraulic elevator, 3.21
 - inclined elevator, 5.1.1.2
 - limited-use/limited-application elevator, 5.2.1.21
 - material lift with automatic transfer device, 7.9.2
 - private residence elevator, 5.3.1.13.1
 - rack-and-pinion elevator, 4.1.10
 - rooftop elevator, electric, 5.6.1.20
 - rooftop elevator, hydraulic, 5.6.2.12
 - shipboard elevator, 5.8.1
 - sidewalk elevator, electric, 5.5.1.20
 - sidewalk elevator, hydraulic, 5.5.2.12
 - special purpose personnel elevator, 5.7.15
- Counterweight, guarding of
 - dumbwaiter, 7.1.3
 - electric elevator, 2.3.2
 - elevator used for construction, 5.10.1.3.2
 - hydraulic elevator, 3.3
 - inclined elevator, 5.1.1.2
 - limited-use/limited-application elevator, 5.2.1.3
 - material lift with automatic transfer device, 7.9.1
 - private residence elevator, 5.3.1.13.2
 - rooftop elevator, 5.6.1.3
 - shipboard elevator, 5.8.1.2
 - sidewalk elevator, 5.5.1.3
 - special purpose personnel elevator, 5.7.3
- Counterweight, location of
 - dumbwaiter, 7.1.3
 - electric elevator, 2.3.1
 - elevator used for construction, 5.10.1.3.1
 - hydraulic elevator, 3.3
 - inclined elevator, 5.1.1.2
 - limited-use/limited-application elevator, 5.2.1.3
 - material lift with automatic transfer device, 7.9.1
 - private residence elevator, 5.3.1.13.2
 - rooftop elevator, 5.6.1.3
 - shipboard elevator, 5.8.1.2
 - sidewalk elevator, 5.5.1.3
 - special purpose personnel elevator, 5.7.3
- Counterweight buffer (*see* Buffer)
- Counterweight clearance, horizontal (*see* Clearance, horizontal)
- Counterweight clearance, top (*see* Clearance, top counterweight)
- Counterweight guide rail (*see* Guide rail)
- Counterweight hoistway
 - electric elevator, 2.3.3
 - elevator used for construction, 5.10.1.3.3
 - private residence elevator, 5.3.1.13.2(c)
 - special purpose personnel elevator, 5.7.3
- Counterweight rope (*see* Rope and Suspension means)
- Counterweight safety (*see* Safeties)
- Counterweight safety required, 2.6
- Counterweight screen (*see also* Counterweight, guarding of)
 - clearance, 2.5.1.2
- Crane, 1.1.2
- Crosshead (*see* Car frame)
- Crosshead data plate, 2.20.2
- Customary unit
 - applicability, Preface
- Cylinder, 3.18.3
 - annual inspection of, 8.11.3.2.2
 - design data and formulas, 8.2.8.2
 - dumbwaiter, 7.3.5
 - maintenance of, 8.6.5.1, 8.6.5.2, 8.6.5.5, 8.6.5.6
 - rooftop elevator, 5.6.2.10
 - sidewalk elevator, 5.5.2.10
- Cylinder head, 3.18.3
 - design data and formulas, 8.2.8.3
- Data plate (*see also* Capacity plate, Marking plate, and Code data plate)
 - crosshead, 2.20.2
 - dumbwaiter, 7.2.3.2
 - electric elevator, 2.16.3
 - elevator used for construction, 5.10.1.23
 - hydraulic elevator, 3.16
 - inclined elevator, 5.1.13.2
 - limited-use/limited-application elevator, 5.2.1.16.2
 - material lift with automatic transfer device, 7.9.2
 - private residence elevator, 5.3.1.20.2
 - rack-and-pinion elevator, 4.1.8
 - rooftop elevator, 5.6.1.16
 - shipboard elevator, 5.8.1
 - screw-column elevator, 4.2.10
 - sidewalk elevator, 5.5.1.16
 - special purpose personnel elevator, 5.7.12.1
- Data tag
 - governor rope, 2.18.5.3
 - screw-column elevator safety nut, 4.2.12
 - suspension rope, 2.20.2
- Deck barricade
 - escalator, 6.1.3.3.11
 - moving walk, 6.2.3.3.8
- Definitions of terms used in code, Section 1.3
- Design data and formulas, 8.2
- Designated attendant
 - definition of, Section 1.3
- Disconnect switch (*see* Power supply line disconnecting means)
- Disconnected motor safety device
 - escalator, 6.1.6.3.10
 - moving walk, 6.2.6.3.8
- Dispatching device
 - definition of, Section 1.3

- Displacement switch, 8.4.10
 - definition of, Section 1.3
- Door (car or hoistway)
 - definition of, Section 1.3
- Door, car (*see* Car door or gate)
- Door, hoistway (*see* Hoistway door and Hoistway entrance)
- Door, machine room, 2.7.3.4
- Door, pit, 2.2.4
- Door closing force and kinetic energy, 2.13.4.1, 2.13.4.2.1, 2.13.4.2.2, 2.13.4.2.3
- Door guide
 - car door or gate, 2.14.4.6
 - horizontal slide type entrance, 2.11.11.6
 - vertical slide type entrance, 2.11.12.5
- Door operation (*see* Hoistway door operation)
- Door or gate closer
 - definition of, Section 1.3
- Door or gate power operator
 - definition of, Section 1.3
- Door panel
 - car door, 2.14.5.6
 - interconnection of panels, 2.11.11.7
 - horizontal slide-type entrance, 2.11.11.5
 - swing-type entrance, 2.11.13.3
 - vertical slide-type entrance, 2.11.12.4
- Door restrictor (*see* Unlocking zone)
- Door track, 2.14.4.6
- Double deck elevator, 2.14.1.4
- Double swing entrance, 2.11.2.3
- Drawings (*see* Layout, Information on)
- Drip pan, escalator and moving walk, 8.6.8.14
- Drive-chain device
 - escalator, 6.1.6.3.4
 - moving walk, 6.2.6.3.4
- Driving machine
 - dumbwaiter, electric, 7.2.10
 - dumbwaiter, hydraulic, 7.3.5
 - earthquake protection, 8.4.9
 - electric elevator, 2.24
 - elevator used for construction, 5.10.1.20
 - escalator, 6.1.5
 - escalator, factor of safety, 6.1.3.10
 - hand elevator, 4.3.19
 - hydraulic, 3.18
 - inclined elevator, 5.1.19
 - limited-use/limited-application elevator, electric, 5.2.1.24
 - limited-use/limited-application elevator, hydraulic, 5.2.2.7
 - material lift with automatic transfer device, 7.9.2
 - moving walk, 6.2.5
 - private residence elevator, electric, 5.3.1.16
 - private residence elevator, hydraulic, 5.3.2.2
 - rack-and-pinion elevator, 4.1.13
 - rooftop elevator, electric, 5.6.1.23
 - rooftop elevator, hydraulic, 5.6.2.10
 - screw-column elevator, 4.2.15
 - shipboard elevator, 5.8.1
 - sidewalk elevator, electric, 5.5.1.23
 - sidewalk elevator, hydraulic, 5.5.2.10
 - special purpose personnel elevator, 5.7.18
- Driving machine, belt, 2.24.9
- Driving machine, chain, 2.24.9
- Driving machine, connection to escalator gear reducer, 6.1.6.3.10
- Driving machine, indirect
 - electric elevator, 2.24.9
- Driving machine, operation with doors not closed, 2.12.4.2
- Driving machine, operation with doors unlocked, 2.12.3.1
- Driving-machine brake (*see* Brake)
- Drum (*see* Winding drum)
- Dumbwaiter, Part 7
 - alteration to, 8.7.7.1
 - definition of, Section 1.3
 - hydraulic, 7.3
 - hydraulic, maintenance of, 8.6.5, 8.6.9
 - inspection and test of, 8.10.5.4, 8.11.5.4
 - maintenance of, 8.6
 - undercounter, definition of, Section 1.3
- Dumbwaiter with automatic transfer device, 7.8
 - alteration to, 8.7.7.3
 - inspection and test of, 8.10.5.5, 8.11.5.5
 - maintenance of, 8.6
- Duplex safeties, 2.17.2
- Earthquake protection, 8.4
- Earthquake protective device, 8.4.10.1.1
 - definition of, Section 1.3
- Egress restriction
 - escalators, 6.1.6.3.7
 - moving walks, 6.2.6.3.6
- Electric contact, car door or gate (*see* Car door or gate electric contact)
- Electric elevator
 - alteration to hoistway and related construction, 8.7.2
 - alteration to machinery and equipment, 8.7.2
 - hoistway and related construction, Part 2
 - inspection and test, acceptance, 8.10.2
 - inspection and test, periodic, 8.11.2.2
 - inspection and test, routine, 8.11.2.1
 - machinery and equipment, Part 2
 - maintenance of, 8.6
- Electrical equipment (*see also* Wiring)
 - dumbwaiter, 7.3.11.5
 - electric elevator, 2.26.4
 - elevator used for construction, 5.10.1.21.3
 - escalator, 6.1.7.4
 - hydraulic elevator, 3.8

- limited-use/limited-application elevator, 5.2.1.26
- moving walk, 6.2.7.4
- private residence elevators, 5.3.1.18.4
- Electrical heater, 2.8.3
- Electrical protective device
 - dumbwaiter, electric, 7.2.12
 - dumbwaiter, hydraulic, 7.3.11
 - earthquake protection, 8.4.10.1.2
 - electric elevator, 2.26.2
 - elevator used for construction, 5.10.1.21.1
 - escalator, 6.1.6.3
 - hydraulic elevator, 3.26.4
 - inclined elevator, 5.1.1.2
 - limited-use/limited-application elevator, electric, 5.2.1.26
 - limited-use/limited-application elevator, hydraulic, 5.2.2.13
 - material lift with automatic transfer device, 7.9.2
 - moving walk, 6.2.6.3
 - private residence elevator, 5.3.1.18
 - rack-and-pinion elevator, 4.1.15.1
 - rooftop elevator, electric, 5.6.1.25
 - rooftop elevator, hydraulic, 5.6.2.17
 - screw-column elevator, 4.2.17
 - shipboard elevator, 5.8.1
 - sidewalk elevator, electric, 5.5.1.25
 - sidewalk elevator, hydraulic, 5.5.2.17.1
 - special purpose personnel elevator, 5.7.19
- Electrical protective device, making inoperative, 8.6.1.6.1
- Elevator
 - definition of, Section 1.3
- Elevator car
 - definition of (car, elevator), Section 1.3
- Elevator pad, 2.14.2.1
- Elevator used for construction, 5.10
 - hydraulic, 5.10.2
 - inspection and test of, 8.10.5.10, 8.11.5.13
- Embedment medium, rope socket, 2.20.9.6
- Emergency door
 - electric elevator, 2.11.1
 - elevator used for construction, 5.10.1.9.2
 - hydraulic elevator, 3.11
 - rack-and-pinion elevator, 4.1.1
 - rooftop elevator, hydraulic, 5.6.2.5
 - screw-column elevator, 4.2.1
- Emergency exit, side (*see* Side emergency exit)
- Emergency exit, top (*see* Top emergency exit)
- Emergency in-car operation, 2.27.3.3
- Emergency lighting, car, 2.14.7.1
- Emergency operation (*see* Firefighters' emergency operation)
- Emergency operation, earthquake, 8.4.10
- Emergency power (*see also* Standby power), 2.27.2
- Emergency recall operation, 2.27.3.1
- Emergency signaling device
 - electric elevator, 2.27.1
 - elevator used for construction, 5.10.1.10.7
 - hydraulic elevator, 3.11
 - inclined elevator, 5.1.21.1
 - limited-use/limited-application elevator, electric, 5.2.1.27
 - limited-use/limited-application elevator, hydraulic, 5.2.2.14
 - material lift with automatic transfer device, 7.9.2
 - private residence elevator, 5.3.1.19
 - rack-and-pinion elevator, 4.1.16
 - rooftop elevator, 5.6.1.26
 - shipboard elevator, 5.8.1.8
 - screw-column elevator, 4.2.18
 - sidewalk elevator, 5.5.1.26
 - special purpose personnel elevator, 5.7.21
- Emergency stop button
 - escalator, 6.1.6.3.1
 - moving walk, 6.2.6.3.1
- Emergency stop switch, in-car (*see also* Stop switch), 2.26.2
 - connection to alarm, 2.27.1
 - definition of, Section 1.3
- Emergency terminal speed-limiting device (*see also* Terminal stopping device)
 - definition of (terminal speed-limiting device, emergency), Section 1.3
 - electric elevator, 2.25.4.1
 - five-year inspection and test of, 8.11.2.3.6
 - hydraulic elevator, 3.25.2
 - rack-and-pinion elevator, 4.1.14.2
 - with reduced stroke buffer, 2.22.4.1
- Emergency terminal stopping device (*see also* Terminal stopping device), 2.25.4.2
- Enclosure, Hoistway (*see* Hoistway enclosure)
- Enclosure, Machine room (*see* Machine room)
- End loading inclined elevator, 5.1.22
- Enforcing authority (*see* Authority having jurisdiction)
- Engineering and type test, 8.3
- Entrance (*see also* Hoistway entrance)
 - definition of, Section 1.3
- Entrance, applied frame
 - definition of (Applied frame entrance), Section 1.3
- Entrance frame
 - horizontal slide type entrance, 2.11.11.3
 - swing type entrance, 2.11.13.2
 - vertical slide type entrance, 2.11.12.2
- Entrance locked out of service, 2.11.6
- Equipment covered by A17.1 Code, 1.1.1
- Equipment not covered by A17.1 Code, 1.1.2
- Equipment permitted in machine room, 2.7.2.1
- Equipment prohibited
 - in car, 2.14.1.9
 - in hoistway and machine room, 2.8.2
 - in machine room, 2.7.2.1
 - on top of car, 2.14.1.7

- Escalator, 6.1
 - alteration to, 8.7.6.1
 - definition of, Section 1.3
 - diagram, Nonmandatory Appendix I
 - inspection and test, acceptance, 8.10.4
 - inspection and test, periodic, 8.11.4.2
 - inspection and test, routine, 8.11.4
 - maintenance of, 8.6.8
 - outdoor, 6.1.8
 - portable, 1.1.2
 - relocation of, 8.7.6.1.2
- Escalator deck
 - definition of, Section 1.3
- Escalator molding
 - definition of, Section 1.3
- Escalator newel
 - definition of, Section 1.3
- Escalator newel base
 - definition of, Section 1.3
- Escalator panel, exterior
 - definition of, Section 1.3
- Escalator panel, interior
 - definition of, Section 1.3
- Escalator skirt
 - definition of, Section 1.3
- Escalators, tandem operation
 - definition of, Section 1.3
- Exception to code, Section 1.2
- Existing installation
 - alteration to, 8.7
 - applicable requirements, 1.1.3
 - application of rules to, Preface
 - definition of (installation, existing), Section 1.3
 - inspection of, 8.10, 8.11

- Factor of safety
 - definition of, Section 1.3
- False car, 1.1.2
- Fascia, 2.11.10.1
- Fasteners, 2.24.4
- Fatigue test, escalator step, 6.1.3.5.8
- Final limit (*see* Final terminal stopping device)
- Final terminal stopping device (*see also* Terminal stopping device)
 - annual inspection and test of, 8.11.2.2.5
 - definition of (terminal stopping device, final), Section 1.3
 - electric elevator, 2.25.3
 - hydraulic elevator, 3.25.3
 - screw-column elevator, 4.2.16.2
- Finger guard
 - escalator, 6.1.3.4.3
 - moving walk, 6.2.3.4.3
- Fire door, 2.11.6
- Fire endurance
 - definition of, Section 1.3
- Fire extinguisher, 8.6.1.6.5
- Fire resistance
 - definition of, Section 1.3
- Fire resistance rating (*see also* Flame spread rating)
 - hoistway enclosure, 2.1.1.1
 - hoistway entrance, 2.1.1.1
 - hoistway entrance, test of, 8.3.4
 - machine room, 2.7.1
- Fire resistive
 - definition of, Section 1.3
- Fire test of hoistway entrance, 8.3.4
- Firefighters' emergency operation
 - annual inspection of, 8.11.2.2.6
 - automatic (nondesignated attendant) elevator, 2.27.3
 - corridor call station sign, 2.27.9
 - dual operation elevator, 2.27.5
 - earthquake protection, 8.4.10
 - hydraulic elevator, 3.27
 - inclined elevator, 5.1.1.2
 - inspection operation, 2.27.6
 - maintenance of, 8.6.10.1
 - multideck elevator, 2.27.3.5
 - non-automatic elevator, 2.27.4
 - operating procedures, 2.27.7
 - operating on standby power, 2.27.2
 - rack-and-pinion elevator, 4.1.16
 - screw-column elevator, 4.2.18
 - switch key, 2.27.8
- Fishplate, 2.23.7
- Fittings, hydraulic elevator, 3.19
- Five-year inspection and test (*see* Periodic inspection and test)
- Flame spread rating (*see also* Fire resistance rating)
 - car enclosure, 2.14.2.1
 - car platform, 2.15.8
- Flat step, 6.1.3.6.5
 - definition of, Section 1.3
- Flexible hose and fittings, hydraulic elevator, 3.19.2.3
 - annual inspection of, 8.11.3.2.4
- Floor, car (*see* Car platform)
- Floor number, 2.29.2
 - elevator used for construction, 5.10.1.22
- Floor opening, protection of
 - escalator, 6.1.1
 - moving walk, 6.2.1
- Floor over hoistway, 2.1.3
 - deflections, 2.9.5
 - stress, 2.9.4
- Follower guide, plunger, 3.18.2.7
- Force, door closing, 2.13.4.1, 2.13.4.2.1, 2.13.4.2.2, 2.13.4.2.3
- Forklift truck loading, 2.16.2.2
- Formulas and design data, 8.2
- Foundations (*see* Beam, machinery and sheave)
- Frame, car (*see* Car frame)
- Frame, counterweight, 2.21.1.1

- design of, 2.21.2
- Freight elevator
 - definition of, Section 1.3
- Freight elevator, carrying of passengers on, 2.16.4
- Freight loading, 2.16.2.2
- Furnace hoist, 1.1.2

- Gage, oil buffer, 2.22.4.6
- Gas spring-return oil buffer, 2.22.4.5
 - definition of, Section 1.3
- Gasketing material, hoistway entrances, 2.11.19
- Gate, car (*see* Car gate; *see also* Car door or gate)
- Gate, hoistway, hand elevator, 4.3.7
- Gate, semiautomatic
 - definition of, Section 1.3
- Gear reducer,
 - connection to escalator driving machine, 6.1.6.3.10
- Gears, inspection of, 2.24.10
- Glass
 - car door, 2.14.5.8
 - hoistway door, 2.11.7.2
 - in elevator car, 2.14.1.8
- Glass balustrade
 - escalator, 6.1.3.3.3
 - moving walk, 6.2.3.3.3
- Glass, maintenance of, 8.6.10.3
- Governor
 - definition of (Speed governor), Section 1.3
 - dumbwaiter, 7.2.5
 - electric elevator, 2.18
 - elevator used for construction, 5.10.1.14
 - escalator, 6.1.6.3.2
 - hydraulic elevator, 3.17.1
 - inclined elevator, 5.1.14.3
 - limited-use/limited-application elevator, 5.2.1.18
 - material lift with automatic transfer device, 7.9.2
 - moving walk, 6.2.6.3.2
 - private residence elevator, 5.3.1.11
 - rack-and-pinion elevator, 4.1.9
 - rooftop elevator, electric, 5.6.1.18
 - rooftop elevator, hydraulic, 5.6.2.9
 - screw-column elevator, 4.2.11
 - shipboard elevator, 5.8.1
 - sidewalk elevator, electric, 5.5.1.18
 - sidewalk elevator, hydraulic, 5.5.2.9
 - special purpose personnel elevator, 5.7.13
- Governor, factor of safety, 2.18.8
- Governor, inspection and test of
 - acceptance, 8.10.2.2
 - annual, 8.11.2.2.3
 - five-year, 8.11.2.3.2
- Governor, location of, 2.18.1
- Governor, where required, 2.18.1
- Governor overspeed switch, 2.18.4
- Governor pull-through tension (force)
 - definition of, Section 1.3
- Governor rope, 2.18.5
 - connection to safety, 2.17.12
 - gripping jaws, 2.18.6
 - lubrication of, 8.6.4.2
 - maximum permissible movement, 2.17.11
 - releasing carrier, 2.17.15
 - sheave, 2.18.7
- Governor seal, 2.18.3
- Governor tripping speed, 2.18.2
 - design data, 8.2.5
- Gravity return oil buffer, 2.22.4.5
- Gravity stopping distance, 8.2.4
- Gripping jaw, governor rope, 2.18.6
- Grooved pipe fittings, 3.19.2.2
- Guard, pit (*see* Counterweight, guarding of)
- Guard at ceiling intersection
 - escalator, 6.1.3.3.11
 - moving walk, 6.2.3.3.7
- Guard between adjacent pits, 2.2.3
- Guarding of exposed equipment, 2.10
- Guide, door (*see* Door guide)
- Guide rail
 - dumbwaiter, electric, 7.2.9
 - dumbwaiter, hydraulic, 7.3.9
 - earthquake protection, 8.4.8
 - electric elevator, 2.23
 - elevator used for construction, 5.10.1.19
 - hand elevator, 4.3.18
 - hydraulic elevator, 3.23
 - inclined elevator, 5.1.18
 - limited-use/limited-application elevator, electric, 5.2.1.23
 - limited-use/limited-application elevator, hydraulic, 5.2.2.10
 - material lift with automatic transfer device, 7.9.2
 - private residence elevator, 5.3.1.15
 - rack-and-pinion elevator, 4.1.12
 - rooftop elevator, electric, 5.6.1.22
 - rooftop elevator, hydraulic, 5.6.2.14
 - screw-column elevator, 4.2.14
 - shipboard elevator, 5.8.1
 - sidewalk elevator, electric, 5.5.1.22
 - sidewalk elevator, hydraulic, 5.5.2.14
 - special purpose personnel elevator, 5.7.17
- Guide rail, door panel, 2.11.12.3
- Guide rail, lubrication of, 2.17.16
- Guide rail, maintenance of, 8.6.4.3
- Guide-rail bracket
 - earthquake protection, 8.4.8.4
 - fastening to building structure, 2.23.9
 - fastening to guide rail, 2.23.10
 - spacing, 2.23.4
 - stresses and deflections, 2.23.5
- Guide shoe
 - car, 2.15.2
 - car door or gate, 2.14.4.6

- counterweight, 2.21.1.3
- design of, 2.15.3
- earthquake protection, 8.4.5

- Hand and finger guard
 - escalator, 6.1.3.4.3
 - moving walk, 6.2.3.4.3
- Hand dumbwaiter, Part 7
- Hand elevator, 4.3
 - alteration to, 8.7.4.3
 - inspection and test of, 8.10.5.3, 8.11.5.3
 - maintenance of, 8.6
 - power attachment, 4.3.20
- Handrail
 - escalator, 6.1.3.4
 - moving walk, 6.2.3.4
 - shipboard elevator, electric, 5.8.1.10
 - shipboard elevator, hydraulic, 5.8.2.3
 - shipboard elevator, rack-and-pinion, 5.8.3.2
 - speed monitoring device, escalator, 6.1.6.6.4
 - speed monitoring device, moving walk, 6.2.6.4
- Handrail, location and clearance
 - escalator, 6.1.3.12
 - moving walk, 6.2.3.2
- Handrail entry device, escalator, 6.1.6.3.12
- Handrail entry device, moving walk, 6.2.6.3.10
- Hanger
 - car door or gate, 2.14.4.6
 - horizontal slide type entrance, 2.11.11.4
 - tracks and supports, 2.11.11.2
- Headroom
 - elevator car, 2.14.2.4
 - escalator, 6.1.3.12
 - moving walk, 6.2.3.15
- Headroom in machine room, 2.7.4
- Heater, 2.8.3
- Hinge, swing type entrance, 2.11.13.4
- Hinged platform sill, 2.15.16
- History of code, Foreword
- Hitch plate
 - car, 2.15.13
 - counterweight, 2.21.2.5
 - securing to structure, 2.9.3.3
- Hoist, 1.1.2
- Hoisting rope (*see* Rope and Suspension means)
- Hoistway
 - definition of, Section 1.3
 - dumbwaiter, 7.1
 - electric elevator, Part 2
 - elevator used for construction, 5.10.1
 - hand elevator, 4.3.1
 - hydraulic elevator, 3.1
 - inclined elevator, 5.1.1
 - limited-use/limited-application elevator, electric, 5.2.1
 - limited-use/limited-application elevator, hydraulic, 5.2.2.1
 - material lift with automatic transfer device, 7.9
 - private residence elevator, 5.3.1.1
 - rack-and-pinion elevator, 4.1.1
 - rooftop elevator, electric, 5.6.1
 - rooftop elevator, hydraulic, 5.6.2.1
 - screw-column elevator, 4.2.1
 - shipboard elevator, 5.8.1
 - sidewalk elevator, electric, 5.5.1.1
 - sidewalk elevator, hydraulic, 5.5.2.1
 - special purpose personnel elevator, 5.7.1
- Hoistway, access to
 - dumbwaiter, 7.1.12
 - electric elevator, 2.12.7
 - hydraulic elevator, 3.12
 - inclined elevator, 5.1.10
 - material lift with automatic transfer device, 7.9.1
 - private residence elevator, 5.3.1.7.7
 - rack-and-pinion elevator, 4.1.1
 - rooftop elevator, 5.6.1.12
 - screw-column elevator, 4.2.1
 - shipboard elevator, 5.8.1
 - special purpose personnel elevator, 5.7.8.3
- Hoistway, construction at top and bottom of, 2.1.2
- Hoistway, counterweight (*see* Counterweight hoistway)
- Hoistway, maintenance of, 8.6.4.7
- Hoistway, number of elevators permitted in, 2.1.1.4
- Hoistway, partially enclosed, 2.1.1.3
- Hoistway, pipes and ducts in, 2.8.2
- Hoistway, protection of space below (*see* Protection of space below hoistway)
- Hoistway access switch, 2.12.7
 - definition of, Section 1.3
- Hoistway door [*see also* Door (car or hoistway) and Hoistway entrance]
 - closed position of, 2.12.3.2
 - closing of, 2.11.3
 - counterweight, 2.11.8
 - counterweighting or counterbalancing, 2.11.12.6
 - kinetic energy and force limitations, 2.13.4.1, 2.13.4.2.1, 2.13.4.2.2, 2.13.4.2.3
 - labeling, 2.11.15
 - location of, 2.11.4
 - locking out of service, 2.11.6
 - opening from hoistway side, 2.11.6
 - power closing, 2.13.3
 - power opening, 2.13.2.2
 - reopening device, 2.13.5
 - sequence operation, 2.13.6
- Hoistway door electric contact, 2.12.3
 - approval of, 2.12.4.2
 - definition of, Section 1.3
 - labeling, 2.12.4.3
 - type test of, 8.3.3

- Hoistway door lock and contact
 - approval of, 2.12.4.2
 - design requirements, 2.12.2.4
 - labeling, 2.12.4.3
 - location of, 2.12.2.6
 - type test of, 8.3.3
 - where permitted, 2.12.1
- Hoistway door locking device
 - definition of, Section 1.3
 - dumbwaiter, 7.1.12
 - electric elevator, 2.12
 - elevator used for construction, 5.10.1.21.2
 - hand elevator, 4.3.8
 - hydraulic elevator, 3.12
 - inclined elevator, 5.1.1
 - limited-use/limited-application elevator, 5.2.1.12
 - material lift with automatic transfer device, 7.9.1
 - private residence elevator, 5.3.1.7.4
 - rack-and-pinion elevator, 4.1.1
 - rooftop elevator, 5.6.1.12
 - screw-column elevator, 4.2.1
 - shipboard elevator, 5.8.1
 - sidewalk elevator, 5.5.1.12
 - special purpose personnel elevator, 5.7.9
- Hoistway door locking device, type test of, 8.3.3
- Hoistway door operation
 - dumbwaiter, 7.1.13
 - electric elevator, 2.13
 - elevator used for construction, 5.10.1.21.2
 - hand elevator, 4.3.6.2
 - hydraulic elevator, 3.13
 - limited-use/limited-application elevator, 5.2.1.13
 - material lift with automatic transfer device, 7.9.1
 - private residence elevator, 5.3.1.8.2(a)
 - rack-and-pinion elevator, 4.1.1
 - rooftop elevator, 5.6.1.13
 - screw-column elevator, 4.2.1
 - shipboard elevator, 5.8.1
 - sidewalk elevator, 5.5.1.13
 - special purpose personnel elevator, 5.7.8.4
- Hoistway door operation, annual test of, 8.11.2.2.8
- Hoistway door safety
 - retainers, 2.11.11.8
- Hoistway door unlocking device, 2.12.6
- Hoistway door vision panel (*see* Vision panel, hoistway door)
- Hoistway enclosure
 - definition of, Section 1.3
 - dumbwaiter, 7.1.1
 - electric elevator, 2.1
 - elevator used for construction, 5.10.1.1.1
 - hand elevator, 4.3.1
 - hydraulic elevator, 3.1
 - inclined elevator, 5.1.1
 - limited-use/limited-application elevator, 5.2.1.1
 - material lift with automatic transfer device, 7.9.1
 - private residence elevator, 5.3.1.1
 - rack-and-pinion elevator, 4.1.1
 - rooftop elevator, 5.6.1.1
 - screw-column elevator, 4.2.1
 - shipboard elevator, 5.8.1.1
 - sidewalk elevator, 5.5.1.1
 - special purpose personnel elevator, 5.7.1.1
- Hoistway enclosure, supporting of guide rail, 2.23.10
- Hoistway entrance (*see also* Hoistway door)
 - definition of (entrance)
 - dumbwaiter, 7.1.11
 - electric elevator, 2.11
 - elevator used for construction, 15.10.1.9
 - hand elevator, 4.3.6
 - hydraulic elevator, 3.1
 - inclined elevator, 5.1.8
 - limited-use/limited-application elevator, 5.2.1.11
 - material lift with automatic transfer device, 7.9.1
 - private residence elevator, 5.3.1.7
 - rack-and-pinion elevator, 4.1.1
 - rooftop elevator, 5.6.1.1
 - screw-column elevator, 4.2.1
 - shipboard elevator, 5.8.1.1
 - sidewalk elevator, 5.5.1.11
 - special purpose personnel elevator, 5.7.8
- Hoistway entrance, fire test of, 8.3.4
 - factory inspection, 2.11.16
 - labeling, 2.11.15
- Hoistway entrance, freight elevator, 2.11.2.2
- Hoistway entrance, gasketing of, 2.11.19
- Hoistway entrance, installation instructions, 2.11.18
- Hoistway entrance, minimum size, 2.11.1.2
- Hoistway entrance, passenger elevator, 2.11.2.1
- Hoistway gate
 - definition of, Section 1.3
- Hoistway gate, hand elevator, 4.3.7
- Hoistway landing sill (*see* Landing sill, hoistway)
- Hoistway pressurization, 2.1.4
- Hoistway protection in case of fire, 2.1.4
- Hoistway unit system
 - definition of, Section 1.3
- Hoistway unit system combination mechanical lock and electric contact (*see* Hoistway door lock and contact *and* Hoistway door locking device)
- Hoistway unit system hoistway door interlock (*see* Interlock *and* Hoistway door locking device)
- Hold handrail sign
 - escalator, 6.1.6.9
 - moving walk, 6.2.6.9
- Horizontal clearance (*see* Clearance, horizontal)
- Horizontal slide type entrance, 2.11.11
 - combination slide and swing, 2.11.13.5
 - location of, 2.11.4
- Hose, flexible, hydraulic elevator, 3.19.2.3
 - annual inspection of, 8.11.3.2.4
- Hydraulic elevator, Part 3

- alteration to, 8.7.3
- definition of, Section 1.3
- elevator used for construction, 5.10.2
- inspection and test, acceptance, 8.10.3
- inspection and test, periodic, 8.11.3.2
- inspection and test, routine, 8.11.3.1
- maintenance of, 8.6.5, 8.6.9
- roped, Part 3
- Hydraulic jack
 - definition of, Section 1.3
- Hydraulic machine
 - definition of, Section 1.3
- Hydraulic material lift with automatic transfer device, 7.12

- Illumination (*see* Lighting)
- Impact on buffer support, 8.2.3
- In-car stop switch, 2.26.2
- Inching device (*see* Leveling device)
- Inclined elevator, 5.1
 - alteration to, 8.7.5.1
 - definition of, Section 1.3
 - end loading, 5.1.2.2
 - inspection and test of, 8.10.5.7, 8.11.5.7
 - maintenance of, Section 8.6
 - private residence, Section 5.4
- Inclined lift (*see* Stairway chairlift)
- Inclined reciprocating conveyor, 1.1.2
- Independent car counterweight, 2.21.1.4
- Indirect plunger elevator (*see* Roped-hydraulic elevator)
- Industrial truck, 1.1.2
- Industrial truck loading, 2.16.2.2
- Inertia application test, location of test weight, Nonmandatory Appendix M
- Information on layout (*see* Layout, information on)
- Initial inspection and test (*see* Acceptance inspection and test)
- Inner loading zone
 - five-year test of, 8.11.2.3.9
- Inside net platform area, 2.16.1
- Inspection and test, 8.10, 8.11
 - dumbwaiter, 8.10.5.4, 8.11.5.4
 - dumbwaiter with automatic transfer device, 8.10.5.5, 8.11.5.5
 - electric elevator, acceptance, 8.10.2
 - electric elevator, periodic, 8.11.2.2
 - electric elevator, routine, 8.11.2
 - elevator used for construction, 8.10.5.10, 8.11.5.13
 - escalator and moving walk, acceptance, 8.10.4
 - escalator and moving walk, periodic, 8.11.4.2
 - escalator and moving walk, routine, 8.11.4
 - hand elevator, 8.10.5.3, 8.11.5.3
 - hydraulic elevator, acceptance, 8.10.3
 - hydraulic elevator, routine, 8.11.3
 - hydraulic elevator, periodic, 8.11.3.2
 - inclined elevator, 8.10.5.7, 8.11.5.7
 - installation placed out of service, 8.11.1.4
 - limited-use/limited-application elevator, 8.10.5.13, 8.11.5.12
 - material lift with automatic transfer device, 8.10.5.5, 8.11.5.5
 - persons authorized to perform, 8.10.1.1(c), 8.11.1.1
 - private residence elevator, 8.10.5.2, 8.11.5.2
 - rack-and-pinion elevators, 8.10.5.12, 8.11.5.11
 - recommended procedures, 8.10.1.2, 8.11.1.2
 - rooftop elevators, 8.10.5.11, 8.11.5.10
 - screw-column elevators, 8.10.5.9, 8.11.5.9
 - shipboard elevators, 8.10.5.8, 8.11.5.8
 - sidewalk elevator, 8.10.5.1, 8.11.5.1
 - special purpose personnel elevator, 8.10.5.6, 8.11.5.6
- Inspection operation
 - definition of, Section 1.3
 - electric elevator, 2.26.1.4
- Inspector qualifications, 8.10.1.1(c), 8.11.1.1
- Installation
 - definition of, Section 1.3
- Installation placed out of service
 - inspection and test, 8.11.1.4
- Installation, existing
 - definition of, Section 1.3
- Installation, new
 - definition of, Section 1.3
- Instantaneous safety (*see* Type A safety)
- Intercom, in car, 2.27.1
- Interlock (*see also* Hoistway door locking device)
 - approval of, 2.12.4.2
 - definition of, Section 1.3
 - design of, 2.12.2.4
 - labeling, 2.12.4.3
 - location of, 2.12.2.6
 - multipanel entrance, 2.11.11.7
 - retiring cam, 2.12.2.5
 - type test of, 8.3.3
 - where required, 2.12.1
- Interlock unlocking zone (*see* Unlocking zone)
- Interpretation of code requirements, Preface
- Interruption of power, 2.27.3.4

- Jump of car or counterweight (*see* Compensating rope and chain)

- Key, firefighters' emergency operation, 2.27.8
- Key, hoistway access door, 2.7.3.4(d)
- Key, pit access door, 2.2.4(g)
- Kinetic energy of hoistway and car doors and gates, 2.13.4.1, 2.13.4.2.1, 2.13.4.2.2, 2.13.4.2.3

- Labeled
 - definition of, Section 1.3
- Labeling

- hoistway door and car door locking devices, 2.12.4.3
- hoistway entrance, 2.11.14
- replacement devices, 8.6.3.7
- Laminated car platform, 2.15.5
 - definition of (car platform, laminated), Section 1.3
- Landing, elevator
 - definition of, Section 1.3
- Landing, escalator
 - access plate, 6.1.7.3
 - floor space, 6.1.3.6.3
 - outdoor, 6.1.8.3
 - safety zone, 6.1.3.6.4
- Landing, escalator or moving walk
 - definition of, Section 1.3
- Landing, moving walk
 - access plate, 6.2.7.3
 - floor surface, 6.2.3.8.4
 - outdoor, 6.2.8.3
 - safety zone, 6.2.3.8.5
- Landing sill, hoistway
 - clearance, 2.5.1.3
 - guard, 2.11.10.1
 - hinged, 2.11.10.3
 - horizontal slide type entrance, 2.11.11.1
 - lighting, 2.11.10.2
 - swing type entrance, 2.11.13.1
 - vertical slide type entrance, 2.11.12.1
- Landing zone
 - definition of, Section 1.3
- Layout, information on
 - dumbwaiter, electric, 7.2.13
 - dumbwaiter, hydraulic, 7.3.12
 - electric elevator, 2.28
 - electric elevator, earthquake protection, 8.4.8.9
 - hand elevator, 4.3.21
 - hydraulic elevator, Section 3.28
 - hydraulic elevator, earthquake protection, 8.4.11.7
 - rack-and-pinion elevator, 4.1.17
 - screw-column elevator, 4.2.19
 - sidewalk elevators, electric, 5.5.1.27
 - sidewalk elevators, hydraulic, 5.5.2.18
- Leveling
 - definition of, Section 1.3
- Leveling device
 - definition of, Section 1.3
- Leveling device, anticreep, 3.26.3
- Leveling zone
 - definition of, Section 1.3
 - operation in, 2.26.1.6
- Lift bridge, 1.1.2
 - five-year test of, 8.11.2.3.8
- Lighting, car
 - dumbwaiter, electric, 7.2.1.3
 - dumbwaiter, hydraulic, 7.3.1
 - electric elevator, 2.14.7
 - elevator used for construction, 5.10.1.10.3
 - hydraulic elevator, 3.14
 - inclined elevator, 5.1.1.2
 - limited-use/limited-application elevator, 5.2.1.14
 - material lift with automatic transfer device, 7.9.2
 - private residence elevator, 5.3.1.8.3
 - rack-and-pinion elevator, 4.1.6
 - rooftop elevator, 5.6.1.14
 - screw-column elevator, 4.2.8
 - shipboard elevator, 5.8.1.6
 - sidewalk elevator, 5.5.1.14.3
 - special purpose personnel elevator, 5.7.10.3
- Lighting, escalator step demarcation, 6.1.6.7
- Lighting of landing, 2.11.10.2
 - escalator, 6.1.7.2
- Lighting of machine room, 2.7.5
 - escalator, 6.1.7.1
 - moving walk, 6.2.7.1
- Lighting of moving walk treadway, 6.2.7.2
- Lighting of pit, 2.2.5
- Lighting of step tread, escalator, 6.1.7.2
- Limited-use/limited-application elevator, 5.2
- Limit switch (*see* Terminal stopping device)
- Line jack, 1.1.2
- Listed
 - definition of, Section 1.3
- Listing
 - hoistway door and car door locking devices, 2.12.4.3
 - replacement devices, 8.6.3.7
- Load, rated (*see* Rated load)
- Load rating
 - oil buffer, 2.22.4.10
 - spring buffer, 2.22.3.2
- Loading
 - freight elevator, 2.16.2.2
 - passenger elevator, 2.16.1.1
 - special loading means, 2.16.9
- Locked out of service, entrance, 2.11.6
- Locking device, hoistway door (*see* Hoistway door locking device)
- Lubrication, 8.6.1.6.2
 - guide rail, 2.17.16
- Machine and control rooms, remote, 2.7.8
 - definition of, Section 1.3
- Machine final, 2.25.3.5
- Machine room
 - dumbwaiter, 7.1.7
 - electric elevator, 2.7
 - elevator used for construction, 5.10.1.7.1
 - hand elevator, 4.3.4
 - hydraulic elevator, 3.7
 - limited-use/limited-application elevator, 5.2.1.7
 - material lift with automatic transfer device, 7.9.1
 - rack-and-pinion elevator, 4.1.2

- rooftop elevator, electric, 5.6.1.7
- rooftop elevator, hydraulic, 5.6.2.4
- screw-column elevator, 4.2.5
- shipboard elevator, 5.8.1
- sidewalk elevator, electric, 5.5.1.7
- sidewalk elevator, hydraulic, 5.5.2.4
- special purpose personnel elevator, 5.7.18.9
- Machine room, access to, 2.7.3
 - escalator, 6.1.7.3
 - moving walk, 6.2.7.3
- Machine room, air conditioning equipment, 2.8.4
- Machine room, equipment in, 2.7.2.1
- Machine room, location of, 2.7.6
- Machine room, maintenance of, 8.6.4.8
- Machine room, pipes and ducts in, 2.8.2
- Machine room, protection against fire
 - escalator, 6.1.2
 - moving walk, 6.2.2
- Machine room, smoke detector in, 2.27.3.2
- Machine room, underneath hoistway, 2.7.7
- Machine room floor (*see* Floor over hoistway)
- Machine, driving (*see also* Driving machine)
 - definition of, Section 1.3
- Machinery and equipment
 - dumbwaiter, electric, 7.2
 - dumbwaiter, hydraulic, 7.3
 - electric elevator, Part 2
 - elevator used for construction, 5.10.1.19
 - hydraulic elevator, 3.2.3
 - inclined elevator, 5.1.1.2
 - limited-use/limited-application elevator, electric, 5.2.1.23
 - limited-use/limited-application elevator, hydraulic, 5.2.2.3
 - material lift with automatic transfer device, 7.9.2
 - rack-and-pinion elevator, 4.1.12
 - rooftop elevator, electric, 5.6.1.22
 - rooftop elevator, hydraulic, 5.6.2.14
 - screw-column elevator, 4.2.14
 - shipboard elevator, 5.8.1
 - sidewalk elevator, electric, 5.5.1.22
 - sidewalk elevator, hydraulic, 5.5.2.14
 - special purpose personnel elevator, 5.7.17
- Machinery beam (*see* Beam, machinery and sheave)
- Machinery space (*see* Machine room)
- Mainline disconnect switch (*see* Power supply line disconnecting means)
- Maintenance, 8.6
- Manlift, 1.1.2
- Manual lowering valve, 3.19.4.4
- Manual reset
 - definition of, Section 1.3
 - escalator, 6.1.6.14
 - moving walk, 6.2.6.13
- Marking plate (*see also* Capacity plate and Data plate)
 - governor, 2.18.9
 - oil buffer, 2.22.4.11
 - rail lubricant, 2.17.16
 - safeties, 2.17.14
 - spring buffer, 2.22.3.3
- Material for car enclosure and linings
 - freight car, 2.14.3.1
 - passenger car, 2.14.2.1
- Material hoist, 1.1.2
- Material lift with automatic transfer device, Part 7
 - alteration to, 8.7.7.3
 - electric, 7.9
 - hydraulic, 7.12
 - inspection and test of, 8.10.5.5, 8.11.5.5
 - maintenance of, 8.6
- Mechanical lock and electric contact (*see* Hoistway door lock and contact)
- Mechanical spring-return oil buffer
 - definition of, Section 1.3
- Mechanized parking garage equipment, 1.1.2
- Metric unit, Preface
- Mine elevator, 1.1.2
- Missing pallet device, moving walk, 6.2.6.5
- Missing step device, escalator, 6.1.6.6.5
- Mobile scaffold, 1.1.2
- Modernization (*see* Alteration)
- Modular escalator (*see* Escalator)
- Module, definition of, Section 1.3
- Motion control (*see* Control, motion)
- Motor (*see also* Driving machine)
 - escalator, 6.1.5
 - moving walk, 6.2.5
- Motor generator overspeed protection, 2.26.2
- Motor generator running switch, 2.26.2
- Motor generator set, test of, 8.10.2.2.2(aa)
- Motor vehicle loading, 2.16.2.2
- Moving walk, 6.2
 - alteration to, 8.7.6.2
 - definition of, Section 1.3
 - diagram, Nonmandatory Appendix I
 - inspection and test, acceptance, 8.10.4
 - inspection and test, periodic, 8.11.4.2
 - inspection and test, routine, 8.11.4
 - maintenance of, 8.6.8
 - outdoor, 6.2.8
 - relocation of, 8.7.6.2.2
- Multideck elevator, 2.14.1.4
 - definition of, Section 1.3
 - firefighters' emergency operation, 2.27
- Multiple hoistway
 - clearance between cars, 2.5.1.3
 - number of elevators permitted in, 2.1.1.4
- Multiple plunger, recycling operation, 3.26.7
- National Electrical Code, Part 9
- New technology, Preface

- Next available landing
definition of, Section 1.3
- Nonmetallic sheave liner, 2.24.2
- Nonstop switch
definition of, Section 1.3
- Nonvision wing (*see* sight guard)
- Normal limit (*see* Normal terminal stopping device)
- Normal terminal stopping device (*see also* Terminal stopping device)
definition of (terminal stopping device, normal), Section 1.3
electric elevator, 2.25.2
hydraulic elevator, 3.25.1
- Normal terminal stopping device, inspection and test of
acceptance, 8.10.2.2.2(ff)
annual, 8.11.2.2.5
- Nudging, 2.13.5
- Numbering, emergency identification, 2.29.1
- Numbering of disconnect switches, 2.26.4
- Numbering of floors, 2.29.2
- Observation elevator (*see also* Partially enclosed hoistway)
definition of, Section 1.3
separate counterweight hoistway for, 2.3.3
- Occupied space below hoistway (*see* Protection of space below hoistway)
- Oil buffer (*see also* Buffer), 2.22.4
approval of, 2.22.4.7
compressed with car at landing, 2.22.4.8
definition of (buffer, oil), Section 1.3
maintenance of, 8.6.4.4
reduced stroke, 2.22.4.1
- Oil buffer, inspection and test of
acceptance, 8.10.2.2.5(c)
annual, 8.11.2.2.1
five-year, 8.11.2.3.3
type test, 8.3.2
- Oil buffer stroke, 2.22.4.1
definition of (buffer, oil stroke), Section 1.3
inclined elevator, 5.1.17.4
material lift with automatic transfer device, 7.9.2
- Oil leakage
maintenance of, 8.6.5.1, 8.6.5.2, 8.6.5.5, 8.6.5.6
means for collection of, 3.18.3.7
- Oil level, oil buffer, 2.22.4.6
- Operating circuit, 2.26.9
- Operating device
definition of, Section 1.3
dumbwaiter, electric, 7.2.12
dumbwaiter, hydraulic, 7.3.11
electric elevator, 2.26.1
elevator used for construction, 5.10.1.21
escalator, 6.1.6
hydraulic elevator, 3.26
inclined elevator, 5.1.20
limited-use/limited-application elevator, electric, 5.2.1.26
limited-use/limited-application elevator, hydraulic, 5.2.2.13
material lift with automatic transfer device, 7.9.2
moving walk, 6.2.6
private residence elevator, 5.3.1.18
rack-and-pinion elevator, 4.1.15.1
rooftop elevator, electric, 5.6.1.25
rooftop elevator, hydraulic, 5.6.2.17
screw-column elevator, 4.2.17
shipboard elevator, 5.8.1
sidewalk elevator, electric, 5.5.1.25
sidewalk elevator, hydraulic, 5.5.2.17.1
special purpose personnel elevator, 5.7.19
- Operating device symbols, 2.26.12
- Operating speed in the down direction
definition of, Section 1.3
- Operation
definition of (*see also* Operating device), Section 1.3
- Operation, door (*see* Hoistway door operation)
- Orchestra lift, 1.1.2
- Outside emergency elevator, Section 5.12
- Overall length of guide rail, 2.23.8
- Overhead beam (*see* Beam, machinery and sheave)
- Overhead obstruction in hoistway
hydraulic elevator, 3.4.5
material lift with automatic transfer device, 7.9.1
- Overhead structure
definition of, Section 1.3
- Overload, passenger, 2.16.8
- Overspeed governor (*see* Governor)
- Overspeed protection, motor generator, 2.26.2
- Overspeed switch, governor, 2.18.4
- Packing gland, cylinder, 3.18.3.5
- Padded protective linings, 2.14.2.1
- Painting, 8.6.1.6.4
of governor, 2.18.3
- Pallet, moving walk, 6.2.3.11
definition of, Section 1.3
- Pallet level device, moving walk, 6.2.6.3.9
- Pallet type treadway, moving walk, 6.2.3.5
- Panel, door (*see* Door panel)
- Panel guide rail, 2.11.12.3
- Panel sill, 2.11.12.7
- Parking garage equipment, 1.1.2
- Partially enclosed hoistway, 2.1.1.3
- Partition for reducing platform area, 2.16.1.2
- Passenger elevator
carrying of freight on, 2.16.1.3
definition of, Section 1.3
- Passenger overload, 2.16.8
- Periodic inspection and test (*see also* Inspection and test)

- Personnel elevator, 5.7
- Personnel hoist, 1.1.2
- Phase I
 - definition of, Section 1.3
 - operation, 2.27.3.1
- Phase II
 - definition of, Section 1.3
 - operation, 2.27.3.3
- Phase reversal and failure protection
 - electric elevator, 2.26.6
 - hydraulic elevator, 3.26.5
 - residence elevator, 5.3.1.18.6
- Pipe design and formulas, 8.2.8.4
- Piping, hydraulic elevator, 3.19
 - dumbwaiter, 7.3.5
 - rooftop elevator, 5.6.2.11
 - sidewalk elevator, 5.5.2.11
- Piston
 - definition of, Section 1.3
- Pit
 - definition of, Section 1.3
 - dumbwaiter, 7.1.2
 - electric elevator, 2.2
 - elevator used for construction, 5.10.1.2
 - hand elevator, 4.3.2
 - hydraulic elevator, 3.2
 - inclined elevator, 5.1.3
 - limited-use/limited-application elevator, 5.2.1.2
 - material lift with automatic transfer device, 7.9.1
 - private residence elevator, 5.3.1.2
 - rack-and-pinion elevator, 4.1.1
 - rooftop elevator, 5.6.1.2
 - screw-column elevator, 4.2.1
 - shipboard elevator, 5.8.1
 - sidewalk elevator, 5.5.1.2
 - special purpose personnel elevator, 5.7.2
- Pit, access to, 2.2.4
- Pit, maintenance of, 8.6.4.7
- Pit, pipes and ducts in, 2.8.2
- Pit door, 2.2.4
- Pit floor, strength
 - electric elevator, 2.1.2.3
 - hydraulic elevator, 3.1.1
- Pit guard (*see* Counterweight, guarding of)
- Plans (*see* Layout, information on)
- Platform, car (*see* Car platform)
- Platform guard, 2.15.9
- Platform sill
 - clearance, 2.5.1.3
 - hinged, 2.15.16
- Plunger (ram), 3.18.2
 - connection to car, 3.18.1
 - definition of, Section 1.3
 - design data and formulas, 8.2.8.1
 - dumbwaiter, 7.3.5
 - rooftop elevator, 5.6.2.10
 - sidewalk elevator, 5.5.2.10
 - telescopic, recycling operation, 3.26.7
- Plunger follower guide, 3.18.2.7
- Plunger head, 3.18.3.6
 - design data and formulas, 8.2.8.3
- Plunger return, oil buffer, 2.22.4.5
- Plunger stop, 3.18.4
 - acceptance inspection of, 8.10.3.2.2(s)
- Portable equipment, 1.1.2
- Position indicator
 - definition of, Section 1.3
- Power, interruption of, 2.27.3.4
- Power attachment to hand elevator, 4.3.20
- Power closing of doors, 2.13.3
 - annual test of, 8.11.2.2.8
- Power dumbwaiter, Part 7
- Power dumbwaiter with automatic transfer device, 7.8
- Power opening of doors, 2.13.2
 - five-year test of, 8.11.2.3.7
- Power sidewalk elevator (*see* sidewalk elevator)
- Power supply line disconnecting means
 - electric elevator, 2.26.4
 - hydraulic elevator, 3.26
 - sprinkler activation, 2.8.2
- Power transmission member, escalator, 6.1.3.10
- Powered platform, 1.1.2
- Pressure switch, hydraulic elevator, 3.26.8
 - three-year inspection of, 8.11.3.3.2
- Pressure vessels, 3.24.4
 - three-year inspection of, 8.11.3.3.2
- Pressurization of hoistway, 2.1.4
- Private residence
 - definition of, Section 1.3
- Private residence elevator, 5.3
 - definition of, Section 1.3
 - inspection and test of, 8.10.5.2, 8.11.5.2
 - maintenance of, 8.6
- Prohibited equipment (*see* Equipment, prohibited)
- Projection, recess, and setback in hoistway enclosure, 2.1.6
- Projection of equipment into hoistway, 2.11.5
- Protection of space below hoistway
 - dumbwaiter, 7.1.6
 - electric elevator, 2.6
 - elevator used for construction, 5.10.1.6
 - hand elevator, 4.3.1
 - hydraulic elevator, Section 3.6
 - inclined elevator, 5.1.1
 - limited-use/limited-application elevator, 5.2.1.6
 - material lift with automatic transfer device, 7.9.1
 - private residence elevator, 5.3.1.14
 - rack-and-pinion elevator, 4.1.1
 - rooftop elevator, electric, 5.6.1.6
 - rooftop elevator, hydraulic, 5.6.2.3
 - screw-column elevator, 4.2.4
 - shipboard elevator, 5.8.1.3

- sidewalk elevator, electric, 5.5.1.6
- sidewalk elevator, hydraulic, 5.5.2.3
- special purpose personnel elevator, 5.7.6
- Protective linings, 2.14.2.1
- Pull strap, 2.11.12.8
- Pump relief valve, 3.19.3.2
- Pump, sump, 2.2.2
- Purpose of code, Section 1.2

- QEI, 8.10.1.1(c), 8.11.1.1
- Qualification of inspectors, 8.10.1.1(c), 8.11.1.1

- Rack-and-pinion elevator, 4.1
 - alteration to, 8.7.4.1
 - inspection and test of, 8.10.5.12, 8.11.5.11
 - maintenance of, 8.6
 - shipboard, 5.8.3
- Rail joint, 2.23.7
- Rail lubricant, 2.17.16
- Rail section, 2.23.3
- Rated load
 - definition of, Section 1.3
 - dumbwaiter, 7.2.3.1
 - dumbwaiter with automatic transfer device, 7.8.4
 - electric elevator, Section 2.16
 - elevator used for construction, 5.10.1.12
 - escalator, 6.1.3.9
 - hand elevator, 4.3.14.1
 - hydraulic elevator, 3.16
 - inclined elevator, 5.1.13
 - material lift with automatic transfer device, 7.9.2
 - moving walk, 6.2.3.10
 - private residence elevator, 5.3.1.10.1
 - rack-and-pinion elevator, 4.1.8
 - rooftop elevator, electric, 5.6.1.16
 - rooftop elevator, hydraulic, 5.6.2.8
 - screw-column elevator, 4.2.10
 - shipboard elevator, 5.8.1
 - sidewalk elevator, 5.5.1.16
 - special purpose personnel elevator, 5.7.12.2
- Rated load, formula for calculation of, 8.2.1
- Rated load, freight elevator, 2.16.2
- Rated load, limited-use/limited-application elevator, 5.2.1.16
- Rated load, passenger elevator, 2.16.1.1
- Rated load performance, definition of, Section 1.3
- Rated speed
 - definition of, Section 1.3
 - elevator used for construction, 5.10.1.12.3
 - escalator, 6.1.4
 - hydraulic elevator, test of, 8.10.3.2.3(cc)
 - inclined elevator, end loading, 5.1.22.2
 - limited-use/limited-application elevator, 5.2.1.16.4
 - moving walk, 6.2.4
 - private residence elevator, 5.3.1.10.2
 - rooftop elevator, 5.6.1.25.4
- shipboard elevator, 5.8.1
- sidewalk elevator, 5.5.1.25.4
- special purpose personnel elevator, 5.7.12.2
- winding drum elevator, 2.24.1
- Recall of elevator, 2.27.3.1
- Recess in hoistway enclosure, 2.1.6
- Reciprocating conveyor, 1.1.2
- Recycling for multiple or telescopic plungers, 3.26.7
 - definition of, Section 1.3
- Reduced stroke oil buffer, 2.22.4.1
- Refastening of ropes of winding drum machines, 8.6.4.10
- Reference code, standard, and specification, Part 9
- Refuge space, top-of-car
 - hydraulic elevator, 3.4.7
 - material lift with automatic transfer device, 7.9.1
 - rack-and-pinion elevator, 4.1.1
 - screw-column elevator, 4.2.2.4
- Regenerated power, absorption of, 2.26.10
- Releasing carrier, governor rope, 2.17.15
- Relief valve, pump, 3.19.3.2
 - annual inspection of, 8.11.3.2.1
- Reopening device, 2.13.5
- Repair, 8.6.2
- Replacement (*see* Alteration)
- Residence elevator, 5.3
- Resin, thermosetting, 2.20.9.6
- Resocketing of ropes, of winding drum machines, 8.6.4.10
- Restricted area, definition of, Section 1.3
- Restrictor, door (*see* Unlocking zone)
- Retiring cam, 2.12.3.3
- Reversal stop device
 - escalator, 6.1.6.3.8
 - moving walk, 6.2.6.3.7
- Revision to code, Preface
- Rise (*see* Travel)
- Riser, escalator step, 6.1.3.5.3
- Roller guide shoe
 - car, 2.15.2
 - counterweight, 2.21.1.3
 - design of, 2.15.3
 - earthquake protection, 8.4.5
- Rolling shutter device (*see* Egress restriction)
- Rooftop elevator, 5.6
 - alteration to, 8.7.5.6
 - definition of, Section 1.3
 - hydraulic, 5.5.2
 - inspection and test of, 8.10.5.11, 8.11.5.10
- Rope (*see also* Suspension means)
 - factor of safety, design data, 8.2.7
 - hitch plate, securing to beam, 2.9.3.3
 - hitch plate, securing to car frame, 2.15.13
 - hitch plate, securing to counterweight, 2.21.2.5
 - refastening and resocketing, 8.6.4.10
- Rope, car-counterweight

- definition of, Section 1.3
- Rope, compensating (*see also* Compensating rope and chain)
 - definition of, Section 1.3
- Rope, counterweight
 - definition of, Section 1.3
- Rope, governor (*see* Governor rope)
- Rope, suspension
 - definition of, Section 1.3
- Rope data tag, 2.20.2
- Rope equalizer, 2.20.5
 - definition of, Section 1.3
- Rope socket
 - tapered, 2.20.9.4
 - wedge, 2.20.9.5
- Rope sprocket drive
 - definition of, Section 1.3
- Roped-hydraulic driving machine
 - definition of, Section 1.3
- Roped-hydraulic elevator, Part 3
 - definition of, Section 1.3
- Routine inspection and test (*see also* Inspection and test)
- Runby, bottom
 - definition of, Section 1.3
 - dumbwaiter, 7.1.4
 - electric elevator, maximum, 2.4.4, 2.4.5
 - electric elevator, minimum, counterweighted, 2.4.2
 - electric elevator, minimum, uncounterweighted, 2.4.3
 - hand elevator, 4.3.3
 - hydraulic elevator, Section 3.4
 - limited-use/limited-application elevator, 5.2.1.4
 - material lift with automatic transfer device, 7.9.1
 - rack-and-pinion elevator, 4.1.1
 - rooftop elevator, electric, 5.6.1.4
 - rooftop elevator, hydraulic, 5.6.2.2
 - screw-column elevator, 4.2.2.2
 - shipboard elevator, 5.8.1
 - sidewalk elevator, electric, 5.5.1.4
 - sidewalk elevator, hydraulic, 5.5.2.2
 - special purpose personnel elevator, 5.7.4.1
- Runby, top
 - definition of, Section 1.3
 - hydraulic elevator, 3.4
 - screw-column elevator, 4.2.2.2
- Safe lift, 2.16.7
- Safeties
 - definition of, Section 1.3
 - dumbwaiter, electric, 7.2.4
 - dumbwaiter, hydraulic, 7.3.4.1
 - electric elevator, 2.17
 - elevator used for construction, 5.10.1.13
 - hand elevator, 4.3.15
 - hydraulic elevator, 3.17.1
 - inclined elevator, 5.1.14
 - limited-use/limited-application elevator, 5.2.1.17
 - material lift with automatic transfer device, 7.9.2
 - private residence elevator, 5.3.1.11
 - rack-and-pinion elevator, 4.1.9
 - rooftop elevator, electric, 5.6.1.17
 - rooftop elevator, hydraulic, 5.6.2.9
 - screw-column elevator, 4.2.11
 - screw-column elevator safety nut, 4.2.12
 - shipboard elevator, 5.8.1
 - sidewalk elevator, electric, 5.5.1.17
 - sidewalk elevator, hydraulic, 5.5.2.9
 - special purpose personnel elevator, 5.7.13
- Safeties, counterweight, 2.17.4
- Safeties, duplex, 2.17.2
- Safeties, inspection and test of
 - acceptance, 8.10.2.2
 - annual, 8.11.2.2.2
 - five-year, 8.11.2.3.1
 - location of inertia application test weight, Nonmandatory Appendix M
- Safeties, painting of, 8.6.1.6.4
- Safeties, stopping distance for, 2.17.3
- Safety bulkhead, 3.18.3.4
 - definition of, Section 1.3
- Safety edge, 2.13.5
- Safety mechanism switch, 2.18.4
- Safety nut, screw-column elevator, 4.2.12
 - engineering test, 8.3.10
- Safety valve, 8.4.11.2
- Scope of code, Section 1.1
- Screw column, 4.2.15
 - definition of, Section 1.3
- Screw column elevator, 4.2
 - alteration to, 8.7.4.2
 - inspection and test of, 8.10.5.9, 8.11.5.9
 - maintenance of, 8.6
- Seal, governor, 2.18.3
- Seismic requirements, 8.4
- Seismic switch, 8.4.10.1.1
 - definition of, Section 1.3
- Selector, guarding of, 2.10
- Sequence operation, 2.13.6
- Setback in hoistway enclosure, 2.1.6
- Shackle rod, 2.20.9.2
- Shaft (*see* Hoistway)
- Shafter, 1.1.2
- Shall
 - definition of, Section 1.3
- Sheave (*see also* Driving machine)
 - car frame, 2.15.12
 - counterweight, 2.21.2.4
 - driving machine, 2.24
 - governor rope, 2.18.7
 - grooving and minimum diameter, 2.24.2
- Sheave beam (*see* Beam, machinery and sheave)

- Shipboard elevator, 5.8
 - alteration to, 8.7.5.8
 - hydraulic, 5.8.2
 - inspection and test of, 8.10.5.8, 8.11.5.8
 - rack-and-pinion, 5.8.3
- Shipper rope operating device, 2.26.1.1
- Should
 - definition of, Section 1.3
- Shutoff valve, sprinkler, 2.8.2
- Shutoff valve, supply line, 3.19.3.1
 - acceptance inspection of, 8.10.3.2.2(q)
- SI unit, Preface
- Side emergency exit
 - electric elevator, 2.14.1.10
 - hydraulic elevator, 3.14
 - inclined elevator, 5.1.11.1
 - rack-and-pinion elevator, 4.1.6
 - screw-column elevator, 4.2.8
- Sidewalk elevator, 5.5
 - alteration to, 8.7.5.5
 - definition of, Section 1.3
 - hydraulic, 5.5.2
 - inspection and test of, 8.10.5.1, 8.11.5.1
 - maintenance of, 8.6
- Sight guard
 - definition of, Section 1.3
- Sign
 - corridor call station, 2.27.9
 - dumbwaiter door, 7.2.3.4
 - dumbwaiter entrance, 7.1.11.3
 - emergency door, 2.11.1.1, 2.11.1.2
 - escalator, 6.1.6.9
 - freight elevator, 2.16.5
 - hand elevator, 4.3.6.3
 - moving walk, 6.2.6.8
- Signaling device (*see* Emergency signaling device)
- Sill, platform (*see* Platform sill)
- Single blind hoistway, 2.11.1.1, 2.11.1.2
- Skip hoist, 1.1.2
- Skirt obstruction device, escalator, 6.1.6.3.6
- Skirt panel, escalator, 6.1.3.3.6
 - clearance to step, 6.1.3.3.5
 - maintenance of, 8.6.8.4
- Skylight and window, 2.1.5
- Slack rope device
 - annual inspection of, 8.11.2.2.4
- Slack-rope switch, 2.26.2
 - annual test of, 8.11.2.2.9
 - definition of, Section 1.3
- Sleeving, definition of, Section 1.3
- Sling (*see* Car frame)
- Smoke, control of, 2.1.4
- Smoke detector, 2.27.3.2
 - activating sprinkler, 2.8.2
 - escalator, 6.1.6.8
 - moving walk, 6.2.6.7
- Special emergency service (*see* Firefighters' emergency operation)
- Special purpose personnel elevator, Section 5.7
 - alteration to, 8.7.5.7
 - definition of, Section 1.3
 - inspection and test of, 8.10.5.6, 8.11.5.6
 - maintenance of, Section 8.6
- Specification, reference, Part 9
- Speed, rated (*see* Rated speed)
- Speed governor (*see* Governor)
- Splicing of suspension rope, 8.6.2.5
- Spring buffer (*see also* Buffer), 2.22.3
 - definition of (buffer, spring), Section 1.3
 - where permitted, 2.22.1.1
- Spring buffer stroke (*see also* Elevator), 2.22.3.1
 - definition of (buffer, spring stroke), Section 1.3
- Spring return oil buffer, 2.22.4.5
- Sprinklers in hoistway and machine room, 2.8.2
- Stage lift, 1.1.2
- Stanchion
 - rooftop elevator, 5.6.1.15.2
 - sidewalk elevator, 5.5.1.15.2
- Standard, reference, Part 9
- Standby lighting, car, 2.14.7.1
- Standby power, 2.27.2
 - connection to alarm, 2.27.1
- Standby power, inspection and test of
 - annual, 8.11.2.2.7
 - five-year, 8.11.2.3.5
- Starting switch
 - escalator, 6.1.6.2.1
 - moving walk, 6.2.6.2.1
- Static switching
 - definition of, Section 1.3
- Step, escalator, 6.1.3.5
 - clearance to skirt panel, 6.1.3.3.5
 - demarcation light, 6.1.6.7
 - factor of safety, 6.1.3.10
 - level, 6.1.6.3.11
 - lighting, 6.1.7.2
 - missing, 6.1.6.5
 - number of flat, 6.1.3.6.5
- Step lateral displacement device, escalator, 6.1.6.3.14
- Step level device, escalator, 6.1.6.3.11
- Step upthrust device, escalator, 6.1.6.3.9
- Step wheel track, escalator, 6.1.3.8
- Stop motion switch, 2.25.3.5
- Stop ring, 3.18.4
 - acceptance inspection of, 8.10.3.2.5(c)
- Stop switch, elevator (*see also* Emergency stop button)
 - emergency, 2.26.2
 - in-car, 2.26.2
 - machinery space, 2.7.3.5
 - pit, 2.2.6
 - top-of-car, 2.26.2
- Stop switch in machinery space

- escalator, 6.1.6.3.5
- moving walk, 6.2.6.3.5
- Stopped handrail device
 - escalator, 6.1.6.4
 - moving walk, 6.2.6.4
- Stopping distance
 - car and counterweight safety, inclined elevator, 8.2.11
 - gravity, 8.2.4
- Stroke, oil buffer (*see* Oil buffer stroke)
- Stroke, spring buffer (*see* Spring buffer stroke)
- Sub-post car frame, 2.15.4
- Sump and sump pump, 2.2.2
- Supply line shutoff valve, 3.19.3.1
 - acceptance inspection of, 8.10.3.2.2(q)
- Supply piping, 3.19
 - dumbwaiter, 7.3.5
 - rooftop elevator, 5.6.2.11
 - sidewalk elevator, 5.5.2.11
- Support, moving walk treadway, 6.2.3.9
- Supports and foundations (*see* Beam, machinery and sheave)
- Suspended ceiling, in elevator car, 2.14.1.5
- Suspension means
 - dumbwaiter, electric, 7.2.6
 - dumbwaiter, hydraulic, 7.3.6
 - electric elevator, 2.20
 - elevator used for construction, 5.10.1.16
 - hand elevator, 4.3.16
 - hydraulic elevator, 3.20
 - inclined elevator, 5.1.16
 - limited-use/limited-application elevator, 5.2.1.20
 - material lift with automatic transfer device, 7.9.2
 - private residence elevator, 5.3.1.12
 - private residence elevator, guarding of, 5.3.1.6
 - rooftop elevator, 5.6.1.19
 - shipboard elevator, 5.8.1
 - sidewalk elevator, 5.5.1.19
 - special purpose personnel elevator, 5.7.14
- Suspension means, fastening, 2.20.9
- Suspension means, splicing and replacing, 8.6.2.5
- Suspension rope (*see* Rope and Suspension means)
- Suspension rope equalizer, 2.20.5
- Sway control guides, Section 2.30
 - definition of, 1.3
- Swing type entrance, 2.11.13
 - combination slide and swing, 2.11.13.1
 - double swing, 2.11.2.3
 - location of, 2.11.4
- Switch key, firefighters' emergency operation, 2.27.8
- Switch, pressure, hydraulic elevator, 3.26.8
- Symbol, operating device, 2.26.12

- Tandem operation
 - definition of, Section 1.3
 - escalator, 6.1.6.6.6
 - moving walk, 6.2.6.6
- Tank, hydraulic elevator, 3.24
 - dumbwaiter, 7.3.5
 - earthquake protection, 8.4.11.6
 - limited-use/limited-application elevator, 5.2.2.11
 - maintenance of, 8.6.5.1, 8.6.5.2, 8.6.5.5, 8.6.5.6
 - rooftop elevator, 5.6.2.15
 - shipboard elevator, 5.8.2.1
- Tapered rope socket, 2.20.9.4
- Telephone, in car, 2.27.1
- Telescopic plunger, recycling operation, 3.26.7
- Temporary elevator, 5.10
- Terminal landing
 - definition of, Section 1.3
- Terminal stopping device
 - dumbwaiter, electric, 7.2.11
 - dumbwaiter, hydraulic, 7.3.10
 - electric elevator, 2.25
 - elevator used for construction, 5.10.1.21.1
 - hydraulic elevator, 3.25
 - inclined elevator, 5.1.1.2
 - inclined elevator, end loading, 5.1.22.4
 - limited-use/limited-application elevator, electric, 5.2.1.25
 - limited-use/limited-application elevator, hydraulic, 5.2.2.12
 - private residence elevator, electric, 5.3.1.17
 - private residence elevator, hydraulic, 5.3.2.3
 - rack-and-pinion elevator, 4.1.14
 - rooftop elevator, electric, 5.6.1.24
 - rooftop elevator, hydraulic, 5.6.2.16
 - screw-column elevator, 4.2.16
 - shipboard elevator, 5.8.1
 - sidewalk elevator, 5.5.1.24
 - special purpose personnel elevator, 5.7.19
- Terminal stopping device, emergency
 - definition of, Section 1.3
- Test, engineering and type, 8.3
- Test and inspection (*see* Inspection and test), 8.10, 8.11
- Thermosetting resin embedment medium, 2.20.9.5
- Three-year inspection and test (*see* Periodic inspection and test)
- Threshold comb
 - definition of, Section 1.3
- Threshold plate (*see* Combplate)
 - definition of, Section 1.3
- Tie-down (*see* Compensating rope and chain)
- Tie rod, 2.21.1.2
 - design of, 2.21.2
- Tiering machine, 1.1.2
- Tiller rope used for connection to safety, 2.17.12
- Top car clearance (*see* Clearance, top car)
- Top emergency exit
 - earthquake protection, 8.4.4.1
 - electric elevator, 2.14.1.5
 - elevator used for construction, 5.10.1.10.4

- hydraulic elevator, 3.14
- inclined elevator, 5.1.11.1
- limited-use/limited-application elevator, 5.2.1.14
- material lift with automatic transfer device, 7.9.2
- rack-and-pinion elevator, 4.1.6
- screw-column elevator, 4.2.8
- shipboard elevator, 5.8.1
- special purpose personnel elevator, 5.7.10.4
- Top-of-car operating device
 - dumbwaiter, electric, 7.2.12
 - dumbwaiter, hydraulic, 7.3.11.1
 - electric elevator, 2.26.1.4
 - hydraulic elevator, 3.26.2
 - limited-use/limited-application elevator, 5.2.1.26
 - rooftop elevator, electric, 5.6.1.25.3
 - rooftop elevator, hydraulic, 5.6.2.17.1
 - shipboard elevator, 5.8.1
 - sidewalk elevator, electric, 5.5.1.25.3
 - sidewalk elevator, hydraulic, 5.5.2.17.2, 5.5.2.17.3
- Traction, 2.24.2.3
- Traction elevator (*see* Electric elevator)
- Transfer device (*see* Automatic transfer device)
- Tansom, 2.11.7
 - definition of, Section 1.3
- Travel
 - definition of, Section 1.3
- Travel, extreme limit of, 2.23.8
- Traveling cable, 2.26.4
 - definition of, Section 1.3
 - inclined elevator, 5.1.7.1
- Tread, escalator step, 6.1.3.5.5
- Treadway
 - definition of, Section 1.3
- Treadway, moving walk
 - belt type, 6.2.3.6
 - pallet type, 6.2.3.5
 - slope, 6.2.3.1
 - support, 6.2.3.9
- Tripping speed, governor, 2.18.2
- Truck zone
 - definition of, Section 1.3
 - operation in, 2.26.1.6
- Truck zoning device, definition of, Section 1.3
- Truss, escalator, 6.1.3.7
 - alteration of, 8.7.6.1.4
 - factor of safety, 6.1.3.10
 - protection against fire, 6.1.2
- Type A safety (*see also* Safeties)
 - identification and classification, 2.17.5
 - limits of use, 2.17.8.1
 - location of inertia application test weight, Nonmandatory Appendix M
- Type B safety (*see also* Safeties)
 - identification and classification, 2.17.5
 - stopping distance, design data, and formulas, 8.2.6
- Type C safety (*see also* Safeties)
 - buffer switch, 2.26.2
 - identification and classification, 2.17.5
 - limits of use, 2.17.8.2
- Type test, 8.3
- Underslung car frame, 2.15.4
 - vertical clearances for, 2.4.8
- Unlocking device, hoistway door, 2.12.6
- Unlocking zone
 - definition of, Section 1.3
 - locking door out of service, 2.11.6
 - restricted opening of doors, 2.14.5.7
- Valley break
 - definition of, Section 1.3
- Valve, supply piping, and fitting, 3.19
 - dumbwaiter, 7.3.5
 - earthquake protection, 8.4.11.3
 - limited-use/limited-application elevator, 5.5.2.8
 - maintenance of, 8.6.5.1, 8.6.5.2, 8.6.5.5, 8.6.5.6
 - rooftop elevator, 5.6.2.11
 - sidewalk elevator, 5.5.2.11
- Ventilation
 - freight car, 2.14.3.3
 - hoistway, 2.1.4
 - machine room, 2.7.5
 - passenger car, 2.14.2.3
- Vertical burn test, 8.3.7
- Vertical clearance (*see* Clearance, vertical)
- Vertical lifting cover
 - rooftop elevator, 5.6.1.11.4
 - sidewalk elevator, 5.5.1.11.4
- Vertical reciprocating conveyor, 1.1.2
- Vertical slide type entrance, 2.11.12
- Vertically sliding door or gate, 2.14.4.7
- Vision panel, car, 2.14.2.5
- Vision panel, hoistway door
 - electric elevator, 2.11.7.1
 - elevator used for construction, 5.10.1.9.3
 - inclined elevator, 5.1.8.1
- Volatile memory, 8.4.10.1.3(h)
 - definition of, Section 1.3
- Waiver, Section 1.2
- Weatherproof
 - definition of, Section 1.3
- Weatherproofing
 - inclined elevator, 5.1.7.2
 - outdoor escalator, 6.1.8.1
 - outdoor moving walk, 6.2.8.1
 - rooftop elevator, 5.6.1.8
 - sidewalk elevator, 5.5.1.8
- Wedge rope socket, 2.20.9.5
- Welding
 - alteration and repair, 8.6.2.2

- electric elevator, 8.8
- hydraulic elevator plungers and cylinders, 3.18.5
- hydraulic elevator valve, piping and fitting, 3.19.5
- inclined elevator, 5.1.1.2
- limited-use/limited-application elevator, 5.2.1.30
- material lift with automatic transfer device, 7.9.2
- rack-and-pinion elevator, 4.1.18
- rooftop elevator, 5.6.1.27
- screw-column elevator, 4.2.20
- shipboard elevator, 5.8.1
- sidewalk elevator, 5.5.1.28
- Wharf ramp, 1.1.2
- Width
 - escalator, 6.1.3.2
 - escalator step, 6.1.3.5.2
 - moving walk, 6.2.3.7
 - moving walk, definition of, Section 1.3
- Wind turbine tower elevator, Section 5.11
- Winding drum machine (*see also* Driving machine)
 - final terminal stopping device, 2.25.3.5
 - limitation of use, 2.24.1
 - material and grooving, 2.24.2.1
 - refastening of ropes, 8.6.4.10
 - securing of rope to, 2.20.6
 - slack rope switch, 2.26.2
 - spare rope turns on drum, 2.20.7
- Window
 - definition of, Section 1.3
- Window and skylight, 2.1.5
- Wire rope (*see* Rope and Suspension means)
- Wiring (*see also* Electrical equipment)
 - dumbwaiter, 7.1.8
 - electric elevator, 2.8.1
 - elevator used for construction, 5.10.1.21.3
 - escalator, 6.1.7.4
 - hydraulic elevator, 3.8
 - inclined elevator, 5.1.1
 - limited-use/limited-application elevator, 5.2.1.8
 - material lift with automatic transfer device, 7.9.1
 - moving walk, 6.2.7.4
 - private residence elevator, 5.3.1.18.4
 - rack-and-pinion elevator, 4.1.3
 - rooftop elevator, 5.6.1.8
 - screw-column elevator, 4.2.6
 - shipboard elevator, 5.8.1
 - sidewalk elevator, 5.5.1.8
 - special purpose personnel elevator, 5.7.19
- Working platform on top of car, 2.14.1.7
- Working pressure, hydraulic elevator, 3.19.1.2
 - acceptance inspection of, 8.10.3.2.2(m)
 - definition of, Section 1.3
- Yield strength
 - definition of, Section 1.3

INTENTIONALLY LEFT BLANK

ASME A17.1-2013/CSA B44-13

(CSA) ISBN 978-1-77139-312-6
(ASME) ISBN 978-0-7918-6857-7



A09613